

VARISPEED V7

Compact Sensorless Vector Inverter

USER'S MANUAL

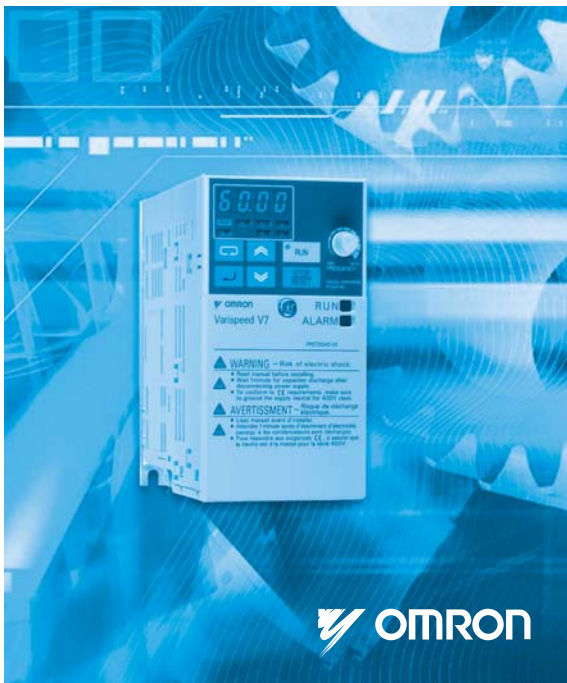

PREFACE

Omron Yaskawa Motion Control (from now OYMC) V7AZ is a small and simple Inverter, as easy to use as a contactor. This instruction manual describes installation, maintenance, inspection, troubleshooting, and specifications of the V7AZ. Read this instruction manual thoroughly before operation.

OMRON YASKAWA MOTION CONTROL

General Precautions

- Some drawings in this manual are shown with protective covers or shields removed in order to show detail with more clarity. Make sure all covers and shields are replaced before operating the product.
- This manual may be modified when necessary because of improvements to the product, modifications, or changes in specifications. Such modifications are indicated by revising the manual number.
- To order a copy of this manual, or if your copy has been damaged or lost, contact your OMRON representative.
- OMRON YASKAWA is not responsible for any modification of the product made by the user, since that will void the guarantee.

NOTATION FOR SAFETY PRECAUTIONS

Read this instruction manual thoroughly before installation, operation, maintenance, or inspection of the V7AZ. In this manual, safety precautions are classified as either warnings or cautions and are indicated as shown below.



Indicates a potentially hazardous situation which, if not avoided, may result in death or serious injury.



Indicates a potentially hazardous situation which, if not avoided, may result in minor or moderate injury or damage to equipment.

It may also be used to alert against unsafe practices.

Even items classified as cautions may result in serious accidents in some situations. Always follow these important precautions.



: Indicates information to insure proper operation.

PRECAUTIONS FOR UL/cUL MARKING

- Do not connect or disconnect wiring, or perform signal checks while the power supply is turned ON.
- The Inverter internal capacitor is still charged even after the power supply is turned OFF. To prevent electric shock, disconnect all power before servicing the Inverter, and then wait at least one minute after the power supply is disconnected. Confirm that all indicators are OFF before proceeding.
- Do not perform a withstand voltage test on any part of the Inverter. The Inverter is an electronic device that uses semiconductors, and is thus vulnerable to high voltage.
- Do not remove the Digital Operator or the blank cover unless the power supply is turned OFF. Never touch the printed circuit board (PCB) while the power supply is turned ON.
- This Inverter is not suitable for use on a circuit capable of delivering more than 18,000 RMS symmetrical amperes, 250 V maximum (200 V Class Inverters) or 18,000 RMS symmetrical amperes, 480 V maximum (400 V Class Inverters).

 CAUTION

- | |
|---|
| <ul style="list-style-type: none">• Use 75°C copper wire or the equivalent. |
|---|

PRECAUTIONS FOR CE MARKINGS

- Only basic insulation to meet the requirements of protection class I and overvoltage category II is provided with control circuit terminals. Additional insulation may be necessary in the end product to conform to CE requirements.
- For 400 V Class Inverters, make sure to ground the supply neutral to conform to CE requirements.
- For conformance to EMC directives, refer to the relevant manuals for the requirements.

Document No. EZZ006543

RECEIVING THE PRODUCT

CAUTION

(Ref. page)

- Do not install or operate any Inverter that is damaged or has missing parts.
Failure to observe this caution may result in injury or equipment damage.

18

MOUNTING

CAUTION

(Ref. page)

- Lift the Inverter by the heatsinks. When moving the Inverter, never lift it by the plastic case or the terminal cover.
Otherwise, the main unit may fall and be damaged.
- Mount the Inverter on nonflammable material (i.e., metal).
Failure to observe this caution may result in a fire.
- When mounting Inverters in an enclosure, install a fan or other cooling device to keep the intake air temperature below 50 °C (122 °F) for IP20 (open chassis type), or below 40 °C (105 °F) for NEMA 1 (TYPE 1).
Overheating may cause a fire or damage the Inverter.
- The V7AZ generates heat. For effective cooling, mount it vertically.
Refer to the figure in *Choosing a Location to Mount the Inverter* on page 24.

23

23

23

24

WIRING

WARNING

	(Ref. page)
<ul style="list-style-type: none">• Only begin wiring after verifying that the power supply is turned OFF. Failure to observe this warning may result in an electric shock or a fire.	28
<ul style="list-style-type: none">• Wiring should be performed only by qualified personnel. Failure to observe this warning may result in an electric shock or a fire.	28
<ul style="list-style-type: none">• When wiring the emergency stop circuit, check the wiring thoroughly before operation. Failure to observe this warning may result in injury.	28
<ul style="list-style-type: none">• Always ground the ground terminal  according to the local grounding code. Failure to observe this warning may result in an electric shock or a fire.	34
<ul style="list-style-type: none">• For 400 V Class, make sure to ground the supply neutral. Failure to observe this warning may result in an electric shock or a fire.	37
<ul style="list-style-type: none">• If the power supply is turned ON while the FWD (or REV) Run Command is being given, the motor will start automatically. Turn the power supply ON after verifying that the RUN signal is OFF. Failure to observe this warning may result in injury.	37
<ul style="list-style-type: none">• When the 3-wire sequence is set, do not make the wiring for the control circuit unless the multi-function input terminal parameter is set. Failure to observe this warning may result in injury.	112

CAUTION

	(Ref. page)
<ul style="list-style-type: none">• Verify that the Inverter rated voltage coincides with the AC power supply voltage. Failure to observe this caution may result in personal injury or a fire.	28
<ul style="list-style-type: none">• Do not perform a withstand voltage test on the Inverter. Performing withstand voltage tests may damage semiconductor elements.	28
<ul style="list-style-type: none">• To connect a Braking Resistor, Braking Resistor Unit, or Braking Unit, follow the procedure described in this manual. Improper connection may cause a fire.	34
<ul style="list-style-type: none">• Always tighten terminal screws of the main circuit and the control circuits. Failure to observe this caution may result in a malfunction, damage, or a fire.	28
<ul style="list-style-type: none">• Never connect the AC main circuit power supply to output terminals U/T1, V/T2, W/T3, B1, B2, -, +1, or +2. The Inverter will be damaged and the guarantee will be voided.	28
<ul style="list-style-type: none">• Do not connect or disconnect wires or connectors while power is applied to the circuits. Failure to observe this caution may result in injury.	28
<ul style="list-style-type: none">• Do not perform signal checks during operation. The machine or the Inverter may be damaged.	28
<ul style="list-style-type: none">• To store a constant with an Enter Command by communications, be sure to take measures for an emergency stop by using the external terminals. Delayed response may cause injury or damage the machine.	155

OPERATION

WARNING

	(Ref. page)
<ul style="list-style-type: none">• Only turn ON the input power supply after confirming that the Digital Operator or blank cover (optional) are in place. Do not remove the Digital Operator or the covers while current is flowing. Failure to observe this warning may result in an electric shock.	38
<ul style="list-style-type: none">• Never operate the Digital Operator or DIP switches with wet hands. Failure to observe this warning may result in an electric shock.	38
<ul style="list-style-type: none">• Never touch the terminals while current is flowing, even if the Inverter is stopped. Failure to observe this warning may result in an electric shock.	38
<ul style="list-style-type: none">• When the fault retry function is selected, stand clear of the Inverter or the load. The Inverter may restart suddenly after stopping. (Construct the system to ensure safety, even if the Inverter should restart.) Failure to observe this warning may result in injury.	84
<ul style="list-style-type: none">• When continuous operation after power recovery is selected, stand clear of the Inverter or the load. The Inverter may restart suddenly after stopping. (Construct the system to ensure safety, even if the Inverter should restart.) Failure to observe this warning may result in injury.	79
<ul style="list-style-type: none">• The Digital Operator stop button can be disabled by a setting in the Inverter. Install a separate emergency stop switch. Failure to observe this warning may result in injury.	98

WARNING

	(Ref. page)
<ul style="list-style-type: none">• If an alarm is reset with the operation signal ON, the Inverter will restart automatically. Reset an alarm only after verifying that the operation signal is OFF. Failure to observe this warning may result in injury.	37
<ul style="list-style-type: none">• When the 3-wire sequence is set, do not make the wiring for the control circuit unless the multi-function input terminal parameter is set. Failure to observe this warning may result in injury.	112
<ul style="list-style-type: none">• If n001=5, a Run Command can be received even while changing a constant. If sending a Run Command while changing a constant, such as during a test run, be sure to observe all safety precautions. Failure to observe this warning may result in injury.	46, 53

CAUTION

	(Ref. page)
<ul style="list-style-type: none">• Never touch the heatsinks, which can be extremely hot. Failure to observe this caution may result in harmful burns to the body.	38
<ul style="list-style-type: none">• It is easy to change operation speed from low to high. Verify the safe working range of the motor and machine before operation. Failure to observe this caution may result in injury and machine damage.	38
<ul style="list-style-type: none">• Install a holding brake separately if necessary. Failure to observe this caution may result in injury.	38

 CAUTION

	(Ref. page)
<ul style="list-style-type: none">• If using an Inverter with an elevator, take safety measures on the elevator to prevent the elevator from dropping. Failure to observe this caution may result in injury.	187
<ul style="list-style-type: none">• Do not perform signal checks during operation. The machine or the Inverter may be damaged.	38
<ul style="list-style-type: none">• All the constants set in the Inverter have been preset at the factory. Do not change the settings unnecessarily. The Inverter may be damaged.	38

MAINTENANCE AND INSPECTION

WARNING

	(Ref. page)
<ul style="list-style-type: none">• Never touch high-voltage terminals on the Inverter. Failure to observe this warning may result in an electrical shock.	192
<ul style="list-style-type: none">• Disconnect all power before performing maintenance or inspection, and then wait at least one minute after the power supply is disconnected. For 400 V Class Inverters, confirm that all indicators are OFF before proceeding. If the indicators are not OFF, the capacitors are still charged and can be dangerous.	192
<ul style="list-style-type: none">• Do not perform a withstand voltage test on any part of the V7AZ. The Inverter is an electronic device that uses semi-conductors, and is thus vulnerable to high voltage.	192
<ul style="list-style-type: none">• Only authorized personnel should be permitted to perform maintenance, inspection, or parts replacement. (Remove all metal objects (watches, bracelets, etc.) before starting work.) (Use tools which are insulated against electrical shock.) Failure to observe these warnings may result in an electric shock.	192

 CAUTION

(Ref. page)

- The control PCB employs CMOS ICs. Do not touch the CMOS elements. They are easily damaged by static electricity. 192
- Do not connect or disconnect wires, connectors, or the cooling fan while power is applied to the circuit. 192
Failure to observe this caution may result in injury.

OTHERS

 WARNING

- Never modify the product.
Failure to observe this warning may result in an electrical shock or injury and will void the guarantee.

 CAUTION

- Do not subject the Inverter to halogen gases, such as fluorine, chlorine, bromine, and iodine, at any time even during transportation or installation.
Otherwise, the Inverter can be damaged or interior parts burnt.

WARNING LABEL

A warning label is provided on the front cover of the Inverter, as shown below. Follow the warnings when handling the Inverter.

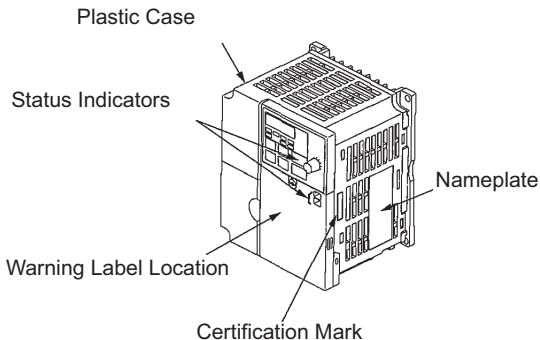

Warning Labels

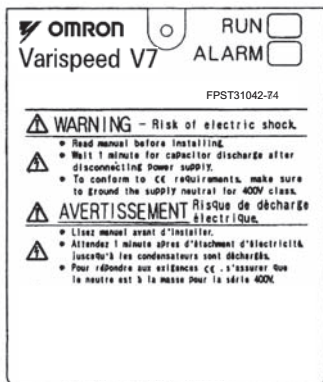

Example of 5.5 kW for 400 V

CONTENTS

NOTATION FOR SAFETY PRECAUTIONS	-----	2
1 Receiving the Product	-----	18
■ Checking the Nameplate	-----	19
2 Identifying the Parts	-----	20
3 Mounting	-----	23
■ Choosing a Location to Mount the Inverter	-----	23
■ Mounting Dimensions	-----	24
■ Mounting/Removing Components-	-----	25
□ Removing the Front Cover-	-----	25
□ Mounting the Front Cover	-----	25
□ Removing the Terminal Cover	-----	25
□ Mounting the Terminal Cover	-----	26
□ Removing the Digital Operator-	-----	26
□ Mounting the Digital Operator	-----	26
□ Mounting the Bottom Cover	-----	27
4 Wiring	-----	28
■ Wire and Terminal Screw Sizes	-----	30
■ Wiring the Main Circuits-	-----	34
■ Wiring the Control Circuits	-----	36
■ Wiring Inspection	-----	37
5 Operating the Inverter	-----	38
■ Test Run	-----	39
□ Selecting Rotation Direction-	-----	41
□ Operation Check Points-	-----	41
■ Operating the Digital Operator	-----	42
□ Description of Status Indicators	-----	43
■ Function Indicator Description	-----	45
□ MNTR Multi-function Monitoring	-----	46
□ Input/Output Terminal Status	-----	48
□ Data Reception Error Display-	-----	48

■ Simple Data Setting - - - - -	50
6 Programming Features - - - - -	52
□ Hardware - - - - -	52
□ Software (Constant) - - - - -	52
■ Constant Setup and Initialization - - - - -	53
□ Constant Selection/Initialization (n001) - - - - -	53
■ Using V/f Control Mode - - - - -	55
□ Adjusting Torque According to Application - - - - -	55
■ Using Vector Control Mode - - - - -	59
□ Precautions for Voltage Vector Control Application - - - - -	59
□ Motor Constant Calculation - - - - -	60
□ V/f Pattern during Vector Control - - - - -	61
■ Switching LOCAL/REMOTE Mode - - - - -	62
□ How to Select LOCAL/REMOTE Mode - - - - -	63
■ Selecting Run/Stop Commands - - - - -	63
□ LOCAL Mode - - - - -	63
□ REMOTE Mode - - - - -	64
□ Operating (Run/Stop Commands) by Communications - - - - -	64
■ Selecting Frequency Reference - - - - -	64
□ LOCAL Mode - - - - -	65
□ REMOTE Mode - - - - -	65
■ Setting Operation Conditions - - - - -	66
□ Autotuning Selection (n139) - - - - -	66
□ Reverse Run Prohibit (n006) - - - - -	74
□ Multi-step Speed Selection - - - - -	74
□ Operating at Low Speed - - - - -	75
□ Adjusting Speed Setting Signal - - - - -	76
□ Adjusting Frequency Upper and Lower Limits - - - - -	77
□ Using Four Acceleration/Deceleration Times - - - - -	77
□ Momentary Power Loss Ridethrough Method (n081) - - - - -	79
□ S-curve Selection (n023) - - - - -	80
□ Torque Detection - - - - -	81
□ Frequency Detection Level (n095) - - - - -	82
□ Jump Frequencies (n083 to n086) - - - - -	84
□ Continuing Operation Using Automatic Retry Attempts - - - - -	84
□ Frequency Offset Selection (n146) - - - - -	85

<input type="checkbox"/>	Operating a Coasting Motor without Tripping - - - - -	88
<input type="checkbox"/>	Holding Acceleration/Deceleration Temporarily - - - - -	89
<input type="checkbox"/>	External Analog Monitoring(n066) - - - - -	90
<input type="checkbox"/>	Calibrating Frequency Meter or Ammeter (n067) - - - - -	91
<input type="checkbox"/>	Using Analog Output (AM-AC) as Pulse Train Signal - - -	91
<input type="checkbox"/>	Carrier Frequency Selection (n080)14kHz max - - - - -	94
<input type="checkbox"/>	Operator Stop Key Selection (n007) - - - - -	98
<input type="checkbox"/>	Second motor selection - - - - -	99
■	Selecting the Stopping Method- - - - -	106
<input type="checkbox"/>	Stopping Method Selection (n005) - - - - -	106
<input type="checkbox"/>	Applying DC Injection Braking - - - - -	107
<input type="checkbox"/>	Simple Positioning Control when Stopping - - - - -	107
■	Building Interface Circuits with External Devices - - - - -	110
<input type="checkbox"/>	Using Input Signals- - - - -	110
<input type="checkbox"/>	Using the Multi-function Analog Inputs - - - - -	120
<input type="checkbox"/>	Using Output Signals (n057, n058, n059) - - - - -	124
■	Setting Frequency by Current Reference Input - - - - -	126
■	Frequency Reference by Pulse Train Input - - - - -	128
■	Two-wire Sequence 2 - - - - -	129
■	Preventing the Motor from Stalling (Current Limit) - - - - -	131
<input type="checkbox"/>	Stall Prevention during Operation - - - - -	133
■	Decreasing Motor Speed Fluctuation - - - - -	135
<input type="checkbox"/>	Slip Compensation (n002 = 0) - - - - -	135
■	Motor Protection - - - - -	136
<input type="checkbox"/>	Motor Overload Detection - - - - -	136
<input type="checkbox"/>	PTC Thermistor Input for Motor Overheat Protection --	138
■	Selecting Cooling Fan Operation - - - - -	141
■	Using MEMOBUS (MODBUS) Communications - - - - -	141
<input type="checkbox"/>	MEMOBUS (MODBUS) Communications - - - - -	141
<input type="checkbox"/>	Communications Specifications - - - - -	142
<input type="checkbox"/>	Communications Connection Terminal - - - - -	142
<input type="checkbox"/>	Setting Constants Necessary for Communication- - - - -	143
<input type="checkbox"/>	Message Format- - - - -	144
<input type="checkbox"/>	Storing Constants [Enter Command] - - - - -	155
<input type="checkbox"/>	Performing Self-test - - - - -	158
■	Using PID Control Mode - - - - -	159
<input type="checkbox"/>	PID Control Selection (n128) - - - - -	159

<input type="checkbox"/>	Analog Position Control with Bi-directional PID Output	- 163
<input type="checkbox"/>	Bidirectional Reference Control	- 164
■	Using Constant Copy Function	- 168
<input type="checkbox"/>	Constant Copy Function	- 168
<input type="checkbox"/>	READ Function	- 170
<input type="checkbox"/>	COPY Function	- 172
<input type="checkbox"/>	VERIFY Function	- 174
<input type="checkbox"/>	Inverter Capacity Display	- 176
<input type="checkbox"/>	Software No. Display	- 178
<input type="checkbox"/>	Display List	- 179
■	Customer Specific Display Scaling	- 181
■	Selecting Processing for Frequency Reference Loss (n064)	- 183
■	Input/Output Open-phase Detection	- 184
■	Undertorque Detection	- 185
■	Using Inverter for Elevating Machines	- 187
<input type="checkbox"/>	Brake ON/OFF Sequence	- 187
<input type="checkbox"/>	Stall Prevention during Deceleration	- 189
<input type="checkbox"/>	Settings for V/f Pattern and Motor Constants	- 189
<input type="checkbox"/>	Momentary Power Loss Restart and Fault Restart	- 189
<input type="checkbox"/>	I/O Open-phase Protection and Overtorque Detection	- 189
<input type="checkbox"/>	Carrier Frequency	- 189
<input type="checkbox"/>	External Baseblock Signal	- 190
<input type="checkbox"/>	Acceleration/Deceleration Time	- 190
<input type="checkbox"/>	Contactors on the Inverter's Output-side	- 190
■	Using MECHATROLINK-II Communications	- 191
7	Maintenance and Inspection	- 192
■	Periodic Inspection	- 193
■	Part Replacement	- 194
<input type="checkbox"/>	Replacement of Cooling Fan	- 195
8	Fault Diagnosis	- 197
■	Protective and Diagnostic Functions	- 197
<input type="checkbox"/>	Corrective Actions of Models with Blank Cover	- 197
<input type="checkbox"/>	Corrective Actions of Models with Digital Operator	- 198
■	Troubleshooting	- 212

9 Specifications	214
■ Standard Specifications (200 V Class)	214
■ Standard Specifications (400 V Class)	218
■ Standard Wiring	222
■ Sequence Input Connection with NPN/PNP Transistor	226
■ Dimensions/Heat Loss	228
■ Recommended Peripheral Devices	231
■ Constants List	234
10 Conformance to CE Markings	247
■ CE Markings	247
■ Requirements for Conformance to CE Markings	247
□ Low Voltage Directive	247
□ EMC Directive	248

1 Receiving the Product



CAUTION

Do not install or operate any Inverter that is damaged or has missing parts.
Failure to observe this caution may result in injury or equipment damage.

After unpacking the V7AZ, check the following.

- Verify that the model number matches your purchase order or packing slip.
- Check the Inverter for physical damage that may have occurred during shipping.

If any part of V7AZ is missing or damaged, call for service immediately.

■ Checking the Nameplate

Example for 3-phase, 200-VAC, 0.1-kW (0.13 HP) Inverter for European standards

Inverter Model	MODEL : CIMR-V7AZ20P1	SPEC : 20P10	
Input Spec.	INPUT : AC3PH 200-230V 50/60Hz 1.1A		
Output Spec.	OUTPUT : AC3PH 0-230V 0-400Hz 0.8A 0.3kVA		
Lot No.	LOT NO :	MASS : 0.6 kg	← Mass
Serial No.	SER NO :	PRG :	← Software Number
	FILE NO : E131457 INSTALLATION CATEGORY II		
	TP20  YASKAWA ELECTRIC CORPORATION JAPAN		

Model

CIMR - V7AZ20P1

Inverter
V7AZ Series

No.	Type
A	With Digital Operator (with potentiometer)

Note: Contact your OMRON representatives for models without heatsinks.

	Applicable maximum motor output	
	200 V class	400 V class
0P1	0.1 kW	—
0P2	0.25 kW	0.37 kW
0P4	0.55 kW	0.55 kW
0P7	1.1 kW	1.1 kW
1P5	1.5 kW	1.5 kW
2P2	2.2 kW	2.2 kW
3P0	—	3.0 kW
4P0	4.0 kW	4.0 kW
5P5	5.5 kW	5.5 kW
7P5	7.5 kW	7.5 kW

No.	Voltage Class
B	Single-phase 200 VAC
2	Three-phase 200 VAC
4	Three-phase 400 VAC

No.	Specifications
Z	European standards

Specifications

	Applicable maximum motor output		No.	Protective structure
	200 V class	400 V class		
0P1	0.1 kW	—	0	Open chassis (IP20, IP00)*1
0P2	0.25 kW	0.37 kW	1	Enclosed wall-mounted (NEMA1)*2
0P4	0.55 kW	0.55 kW		
0P7	1.1 kW	1.1 kW		
1P5	1.5 kW	1.5 kW		
2P2	2.2 kW	2.2 kW		
3P0	—	3.0 kW		
4P0	4.0 kW	4.0 kW		
5P5	5.5 kW	5.5 kW		
7P5	7.5 kW	7.5 kW		

*1: Inverters with outputs 0P1 to 3P7 are rated IP20. Be sure to remove the top and bottom covers if using open-chassis mounted Inverters with a 5P5 or 7P5 output.

*2: A NEMA 1 rating is optional for Inverters with outputs 0P1 to 3P7 but standard for 5P5 or 7P5.

Inverter Software Version

The inverter software version can be read out from the monitor parameter U-10 or parameter n179. The parameter shows the last for digits of the software number (e.g. display is "5740" for the software version VSP015740).

The manual describes the functionality of the Inverter software version VSP015740 (0.1 to 4.0 kW) and VSP105750 (5.5 and 7.5 kW). Older software versions do not support all described functions. Check the software version before starting to work with this manual.

2 Identifying the Parts

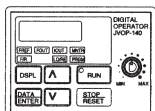
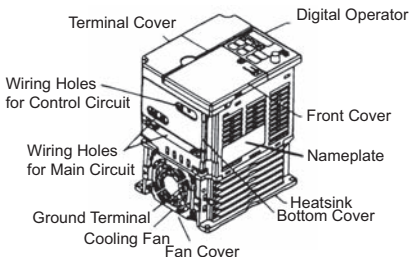

Digital Operator (with potentiometer) JVOP-140
Used for setting or changing constants. Frequency can be set using the potentiometer.

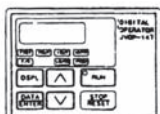

Digital Operator (without potentiometer) JVOP-147
Used for setting or changing constants.

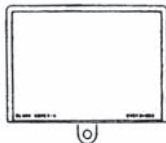

Blank cover
In models without a Digital Operator, the blank cover is mounted in place of the Digital Operator.

V7AZ Inverters with the Covers Removed

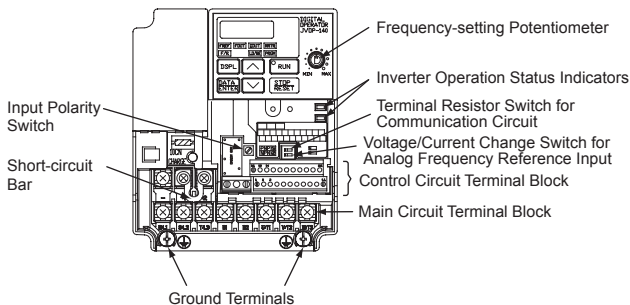

Example for 3-phase (200 V Class, 1.5 kW) Inverter

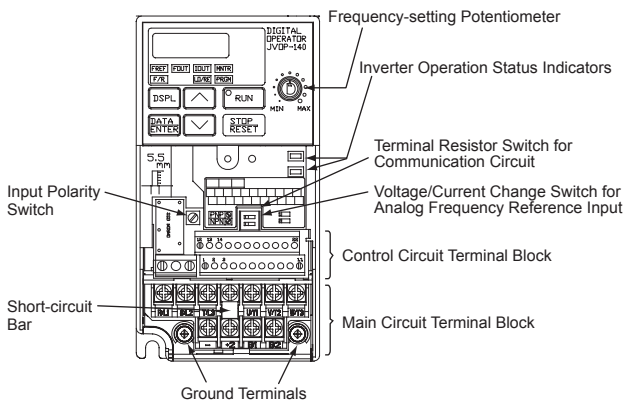

Example for 3-phase (200 V Class, 0.1 kW) Inverter

Main Circuit Terminal Arrangement

The terminal arrangement of the main circuit terminals depends on the Inverter model.

CIMR-V7AZ20P1 to 20P7, B0P1 to B0P4

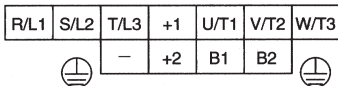

CIMR-V7AZ21P5, 22P2, B0P7, B1P5, 40P2 to 42P2

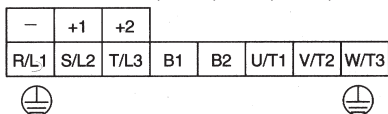

CIMR-V7AZ24P0, B2P2, 43P0, 44P0

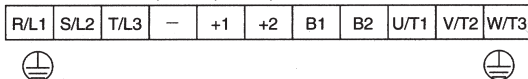

CIMR-V7AZB4P0

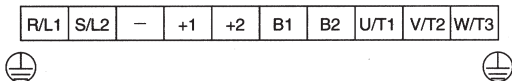

CIMR-V7AZ25P5, 27P5, 45P5, 47P5

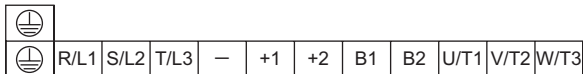

3 Mounting

■ Choosing a Location to Mount the Inverter

Be sure the Inverter is protected from the following conditions.

- Extreme cold and heat. Use only within the specified ambient temperature range:
 - 10 to 50 °C (14 to 122 °F) for IP20 (open chassis type),
 - 10 to 40 °C (14 to 105 °F) for NEMA 1 (TYPE 1)
- Rain and moisture
- Oil sprays and splashes
- Salt spray
- Direct sunlight (Avoid using outdoors.)
- Corrosive gases (e.g., sulfurized gas) or liquids
- Dust or metallic particles in the air
- Physical shock or vibration
- Magnetic noise (Examples: Welding machines, power devices, etc.)
- High humidity
- Radioactive substances
- Combustibles, such as thinner or solvents

■ Mounting Dimensions

To mount the V7AZ, the dimensions shown below are required.

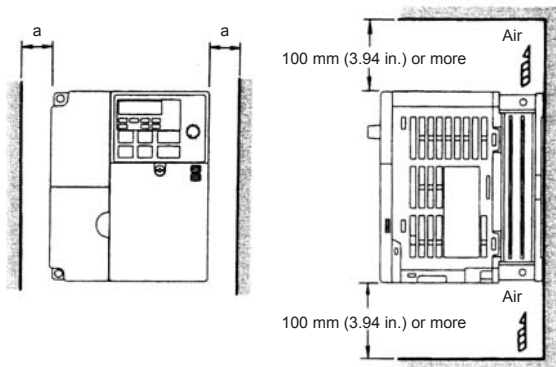

Voltage Class (V)	Max. Applicable Motor Capacity (kW)	Length a
200 V Single-phase 3-phase 400 V 3-phase	3.7 kW or less	30 mm (1.18 in.) min.
200 V 3-phase 400 V 3-phase	5.5 kW	50 mm (1.97 in.) min.
	7.5 kW	



- Lift the Inverter by the heatsinks. When moving the Inverter, never lift it by the plastic case or the terminal cover. Otherwise, the main unit may fall and be damaged.
- The V7AZ generates heat. For effective cooling, mount it vertically.



- The same space is required horizontally and vertically and right and left for both Open Chassis (IP00, IP20) and Enclosed Wall-mounted (NEMA 1) Inverters.
- Always remove the top and bottom covers before installing a 200 or 400 V Class Inverter with an output of 5.5/7.5 kW in a panel.

■ Mounting/Removing Components

Removing and Mounting the Digital Operator and Covers

□ Removing the Front Cover

Use a screwdriver to loosen the screw (section A) on the front cover. (To prevent loss, this screw cannot be removed.) Then press the right and left sides in direction 1 and lift the front cover in direction 2.

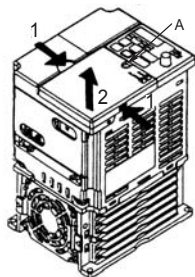

□ Mounting the Front Cover

Mount the front cover by reversing the order of the above procedure for removal.

□ Removing the Terminal Cover

- 200 V class Inverters with 1.1 kW and more and all 400 V class Inverters:

After removing the front cover, press the right and left sides of the terminal cover in direction 1 and lift the terminal cover in direction 2.

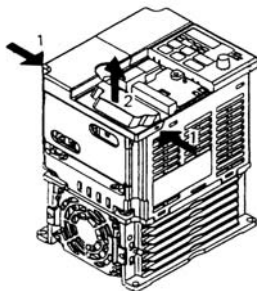

- Inverters of 5.5 and 7.5 kW:

Use a screwdriver to loosen the screw (section B) on the terminal cover surface. (To prevent loss, this screw cannot be removed.) Then press the right and left sides in direction 1 and lift the terminal cover in direction 2.

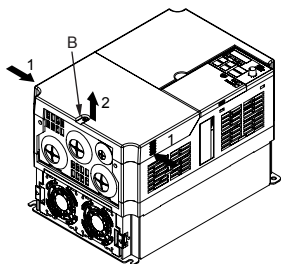

- Mounting the Terminal Cover

Mount the terminal cover by reversing the order of the above procedure for removal.

- Removing the Digital Operator

After removing the front cover, (follow the procedure on page 25) lift the upper and lower sides (section C) of the right side of the Digital Operator in direction 1.

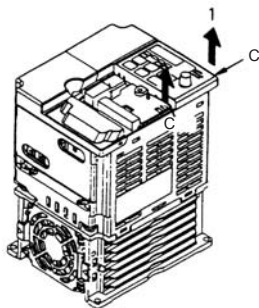

- Mounting the Digital Operator

Mount the Digital Operator by reversing the order of the above procedure for removal.

□ Removing the Bottom Cover

- 200 V class Inverters with 1.1 kW and more and all 400 V class Inverters:

After removing the front cover and the terminal cover, tilt the bottom cover in direction 1 with section A as a supporting point.

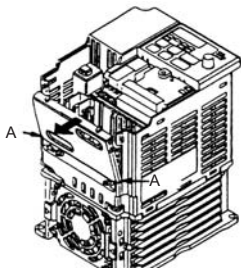

- Inverters of 5.5 and 7.5 kW

After removing the terminal cover, use a screwdriver to loosen the mounting screw in direction 1.

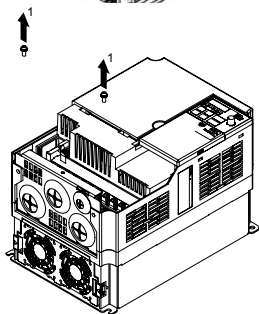

□ Mounting the Bottom Cover

Mount the bottom cover by reversing the order of the above procedure for removal.

4 Wiring

WARNING

- Only begin wiring after verifying that the power supply is turned OFF.
Failure to observe this warning may result in an electric shock or a fire.
- Wiring should be performed only by qualified personnel.
Failure to observe this warning may result in an electric shock or a fire.
- When wiring the emergency stop circuit, check the wiring thoroughly before operation.
Failure to observe this warning may result in injury.
- For the 400 V Class, make sure to ground the supply neutral.
Failure to observe this warning may result in an electric shock or a fire.

CAUTION

- Verify that the Inverter rated voltage coincides with the AC power supply voltage.
Failure to observe this caution may result in personal injury or a fire.
- Do not perform a withstand voltage test on the Inverter.
Performing withstand voltage tests may damage semiconductor elements.
- Always tighten terminal screws of the main circuit and the control circuits.
Failure to observe this caution may result in a malfunction, damage, or a fire.
- Never connect the AC main circuit power supply to output terminals U/T1, V/T2, W/T3, B1, B2, -, +1, or +2.
The Inverter will be damaged and the guarantee will be voided.
- Do not connect or disconnect wires or connectors while power is applied to the circuits.
Failure to observe this caution may result in injury.
- Do not perform signal checks during operation.
The machine or the Inverter may be damaged.
- To store a constant with an Enter Command by communications, be sure to take measures for an emergency stop by using the external terminals.

Delayed response may cause injury or damage the machine.



Wiring Instructions

1. Always connect the power supply for the main circuit inputs to the power input terminals R/L1, S/L2, and T/L3 (R/L1, S/L2 for single-phase power) via a molded-case circuit breaker (MCCB) or a fuse. Never connect the power supply to terminals U/T1, V/T2, W/T3, B1, B2, -, +1, or +2. The Inverter may be damaged.
For single-phase Inverters, always use terminals R/L1 and S/L2. Never connect terminal T/L3. Fuses must be of UL-class RK5 fuse or an equivalent.
Refer to page 231 for recommended peripheral devices.

Inverter Power Supply Connection Terminals

200-V 3-phase Input Power Supply Specification Inverters CIMR-V7□□2□□□	200-V Single Input Power Supply Specification Inverters CIMR-V7□□B□□□	400-V 3-phase Input Power Supply Specification Inverters CIMR-V7□□4□□□
Connect to R/L1, S/L2, and T/L3.	Connect to R/L1 and S/L2.	Connect to R/L1, S/L2, and T/L3.

2. If the wiring distance between Inverter and motor is long, reduce the Inverter carrier frequency. For details, refer to *Carrier Frequency Selection (n080)14kHz max* on page 94.
3. Control wiring must be less than 50 m (164 ft) in length and must be separated from power wiring. Use shielded twisted-pair cable when inputting the frequency signal externally.
4. Only basic insulation to meet the requirements of protection class 1 and overvoltage category II is provided with control circuit terminals. Additional insulation may be necessary in the end product to conform to CE requirements.
5. Closed-loop connectors should be used when wiring to the main circuit terminals.

6. Voltage drop should be considered when determining the wire size.

Voltage drop can be calculated using the following equation:

Phase-to-phase voltage drop (V)

$$= \sqrt{3} \times \text{Wire resistance } (\Omega/\text{km}) \times \text{Wiring distance (m)} \times \text{Current}$$

$$(\text{A}) \times 10^{-3}$$

Select a wire size so that voltage drop will be less than 2% of the normal rated voltage.

7. If the Inverter is connected to a power transformer exceeding 600 kVA, excessive peak current may flow into the input power supply circuit, and break the converter section. In this case, attach an AC reactor (optional) to the Inverter input side, or a DC reactor (optional) to the DC reactor connection terminal.









■ Wire and Terminal Screw Sizes

1. Control Circuits

Model	Terminal Symbols	Screws	Tightening Torque N•m (lb•in)	Wires				Type
				Applicable Size		Recommended Size		
				mm ²	AWG	mm ²	AWG	
Same for all models	MA, MB, MC	M3	0.5 to 0.6 (4.44 to 5.33)	Twisted wires: 0.5 to 1.25, Single: 0.5 to 1.25	20 to 16, 20 to 16	0.75	18	Shielded or equivalent
	S1 to S7, P1, P2, SC, PC, R+, R-, S+, S-, FS, FR, FC, AM, AC, RP	M2	0.22 to 0.25 (1.94 to 2.21)	Twisted wires: 0.5 to 0.75, Single: 0.5 to 1.25	20 to 18, 20 to 16	0.75	18	







2. Main Circuits

200 V Class 3-phase Input Inverters

Model	Terminal Symbols	Screws	Tightening Torque N•m (lb•in)	Wires				Type				
				Applicable Size		Recommended Size						
				mm ²	AWG	mm ²	AWG					
CIMR-V7AZ 20P1	R/L1, S/L2, T/L3, - +1, +2, B1, B2, U/T1, V/T2, W/T3	M3.5	0.8 to 1.0 (7.1 to 8.88)	0.75 to 2	18 to 14	2	14	600-V vinyl-sheathed or equivalent				
												
CIMR-V7AZ 20P2	R/L1, S/L2, T/L3, - +1, +2, B1, B2, U/T1, V/T2, W/T3	M3.5	0.8 to 1.0 (7.1 to 8.88)	0.75 to 2	18 to 14	2	14		600-V vinyl-sheathed or equivalent			
												
CIMR-V7AZ 20P4	R/L1, S/L2, T/L3, - +1, +2, B1, B2, U/T1, V/T2, W/T3	M3.5	0.8 to 1.0 (7.1 to 8.88)	0.75 to 2	18 to 14	2	14			600-V vinyl-sheathed or equivalent		
												
CIMR-V7AZ 20P7	R/L1, S/L2, T/L3, - +1, +2, B1, B2, U/T1, V/T2, W/T3	M3.5	0.8 to 1.0 (7.1 to 8.88)	0.75 to 2	18 to 14	2	14				600-V vinyl-sheathed or equivalent	
												
CIMR-V7AZ 21P5	R/L1, S/L2, T/L3, - +1, +2, B1, B2, U/T1, V/T2, W/T3	M4	1.2 to 1.5 (10.65 to 13.31)	2 to 5.5	14 to 10	2	14					600-V vinyl-sheathed or equivalent
							3.5					
CIMR-V7AZ 22P2	R/L1, S/L2, T/L3, - +1, +2, B1, B2, U/T1, V/T2, W/T3	M4	1.2 to 1.5 (10.65 to 13.31)	2 to 5.5	14 to 10	3.5	12	600-V vinyl-sheathed or equivalent				
												
CIMR-V7AZ 24P0	R/L1, S/L2, T/L3, - +1, +2, B1, B2, U/T1, V/T2, W/T3	M4	1.2 to 1.5 (10.65 to 13.31)	2 to 5.5	14 to 10	5.5	10		600-V vinyl-sheathed or equivalent			
												
CIMR-V7AZ 25P5	R/L1, S/L2, T/L3, - +1, +2, B1, B2, U/T1, V/T2, W/T3	M5	2.5 (22.13)	5.5 to 8	10 to 8	8	8			600-V vinyl-sheathed or equivalent		
												
CIMR-V7AZ 27P5	R/L1, S/L2, T/L3, - +1, +2, B1, B2, U/T1, V/T2, W/T3	M5	2.5 (22.13)	5.5 to 8	10 to 8	8	8				600-V vinyl-sheathed or equivalent	
												

Note: The wire size is given for copper wire at 75°C (160°F).









200 V Class Single-phase Input Inverters

Model	Terminal Symbols	Screws	Tightening Torque N•m (lb•in)	Wires				Type
				Applicable Size		Recommended Size		
				mm ²	AWG	mm ²	AWG	
CIMR-V7AZ B0P1	R/L1, S/L2, T/L3, -, +1, +2, B1, B2, U/T1, V/T2, W/T3	M3.5	0.8 to 1.0 (7.1 to 8.88)	0.75 to 2	18 to 14	2	14	600-V vinyl-sheathed or equivalent
								
CIMR-V7AZ B0P2	R/L1, S/L2, T/L3, -, +1, +2, B1, B2, U/T1, V/T2, W/T3	M3.5	0.8 to 1.0 (7.1 to 8.88)	0.75 to 2	18 to 14	2	14	
								
CIMR-V7AZ B0P4	R/L1, S/L2, T/L3, -, +1, +2, B1, B2, U/T1, V/T2, W/T3	M3.5	0.8 to 1.0 (7.1 to 8.88)	0.75 to 2	18 to 14	2	14	
								
CIMR-V7AZ B0P7	R/L1, S/L2, T/L3, -, +1, +2, B1, B2, U/T1, V/T2, W/T3	M4	1.2 to 1.5 (10.65 to 13.31)	2 to 5.5	14 to 10	3.5	12	
								
CIMR-V7AZ B1P5	R/L1, S/L2, -, +1, +2, B1, B2, U/T1, V/T2, W/T3	M4	1.2 to 1.5 (10.65 to 13.31)	2 to 5.5	14 to 10	5.5	10	
								
CIMR-V7AZ B2P2	R/L1, S/L2, -, +1, +2, B1, B2, U/T1, V/T2, W/T3	M4	1.2 to 1.5 (10.65 to 13.31)	2 to 5.5	14 to 10	5.5	10	
								
CIMR-V7AZ B4P0	R/L1, S/L2, -, +1, +2, B1, B2, U/T1, V/T2, W/T3	M5	3.0 (26.62)	3.5 to 8	12 to 8	8	8	
		M4	1.2 to 1.5 (10.65 to 13.31)	2 to 8	14 to 8			

Note: 1. The wire size is given for copper wire at 75°C (160°F).

2. Do not use terminal T/L3 on Inverters with single-phase input.

400 V Class 3-phase Input Inverters

Model	Terminal Symbols	Screws	Tightening Torque N•m (lb•in)	Wires				Type				
				Applicable Size		Recommended Size						
				mm ²	AWG	mm ²	AWG					
CIMR-V7AZ 40P2	R/L1, S/L2, T/L3, -, +1, +2, B1, B2, U/T1, V/T2, W/T3	M4	1.2 to 1.5 (10.65 to 13.31)	2 to 5.5	14 to 10	2	14	600-V vinyl- sheathed or equivalent				
												
CIMR-V7AZ 40P4	R/L1, S/L2, T/L3, -, +1, +2, B1, B2, U/T1, V/T2, W/T3	M4	1.2 to 1.5 (10.65 to 13.31)	2 to 5.5	14 to 10	2	14		600-V vinyl- sheathed or equivalent			
												
CIMR-V7AZ 40P7	R/L1, S/L2, T/L3, -, +1, +2, B1, B2, U/T1, V/T2, W/T3	M4	1.2 to 1.5 (10.65 to 13.31)	2 to 5.5	14 to 10	2	14			600-V vinyl- sheathed or equivalent		
												
CIMR-V7AZ 41P5	R/L1, S/L2, T/L3, -, +1, +2, B1, B2, U/T1, V/T2, W/T3	M4	1.2 to 1.5 (10.65 to 13.31)	2 to 5.5	14 to 10	2	14				600-V vinyl- sheathed or equivalent	
												
CIMR-V7AZ 42P2	R/L1, S/L2, T/L3, -, +1, +2, B1, B2, U/T1, V/T2, W/T3	M4	1.2 to 1.5 (10.65 to 13.31)	2 to 5.5	14 to 10	2	14					600-V vinyl- sheathed or equivalent
												
CIMR-V7AZ 43P0	R/L1, S/L2, T/L3, -, +1, +2, B1, B2, U/T1, V/T2, W/T3	M4	1.2 to 1.5 (10.65 to 13.31)	2 to 5.5	14 to 10	2	14	600-V vinyl- sheathed or equivalent				
												
CIMR-V7AZ 44P0	R/L1, S/L2, T/L3, -, +1, +2, B1, B2, U/T1, V/T2, W/T3	M4	1.2 to 1.5 (10.65 to 13.31)	2 to 5.5	14 to 10	2	14		600-V vinyl- sheathed or equivalent			
												
CIMR-V7AZ 45P5	R/L1, S/L2, T/L3, -, +1, +2, B1, B2, U/T1, V/T2, W/T3	M4	1.4 (12.39)	3.5 to 5.5	12 to 10	5.5	10			600-V vinyl- sheathed or equivalent		
												
CIMR-V7AZ 47P5	R/L1, S/L2, T/L3, -, +1, +2, B1, B2, U/T1, V/T2, W/T3	M5	2.5 (22.13)	5.5 to 8	10 to 8	5.5	10				600-V vinyl- sheathed or equivalent	
												

Note: The wire size is given for copper wire at 75°C (160°F).

■ Wiring the Main Circuits

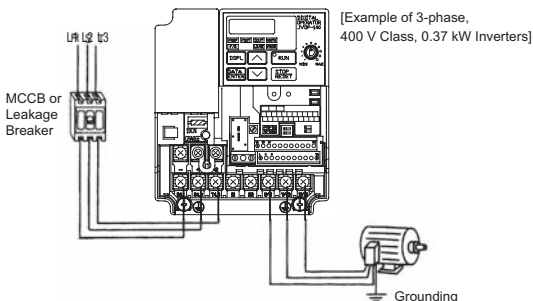

• Main Circuit Input Power Supply

Always connect the power supply line to input terminals R/L1, S/L2, and T/L3. Never connect them to terminals U/T1, V/T2, W/T3, B1, B2, -, +1, or +2. The Inverter may be damaged if the wrong terminals are connected.

NOTE

For single-phase Inverters, always use terminals R/L1 and S/L2. Never connect terminal T/L3.

• Grounding (Use ground terminal \oplus)



WARNING

Always ground the ground terminal \oplus according to the local grounding code.

Failure to observe this warning may result in an electric shock or a fire.

Never ground the V7AZ to the same ground as welding machines, motors, or other electrical equipment.

When several V7AZ Inverters are used side by side, ground each as shown in the following examples. Do not loop the ground wires.

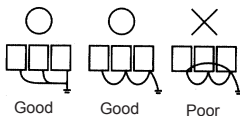

- Braking Resistor Connection (Optional)

**WARNING**

To connect the braking resistor, cut the protector on terminals B1 and B2.

To protect the braking resistor from overheating, install a thermal overload relay between the braking resistor and the Inverter. This provides a sequence that turns OFF the power supply with thermal relay trip contacts.

Failure to observe this warning may result in a fire.

Use this same procedure when connecting a Braking Resistor Unit. Refer to page 223.

- Inverter Output

Connect the motor terminals to U/T1, V/T2, and W/T3.

- Wiring the Main Circuit Terminals

Pass the cables through the wiring hole to connect them. Always mount the cover in its original position.

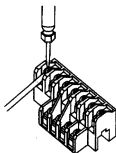

Connect with a Phillips screwdriver.

■ Wiring the Control Circuits

Only basic insulation is provided for the control circuit terminals.

Additional insulation may be necessary in the end product.

- Control Circuit Terminals

Pass the cable through the wiring hole to connect it. Always mount the cover in its original position.

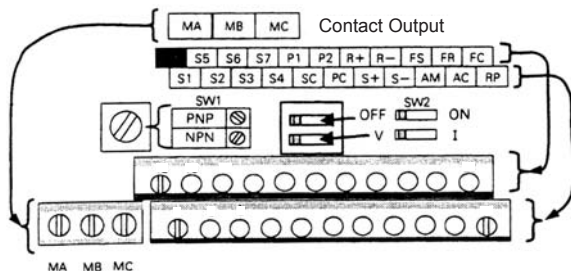

SW1 can be changed according to sequence input signal (S1 to S7) polarity.

0 V common: NPN side (factory setting)

+24 V common: PNP side

Refer to pages 226 and 227 for SW1.

Refer to pages 126 and 142 for SW2.

Wiring the Control Circuit Terminals

Screwdriver Blade Width

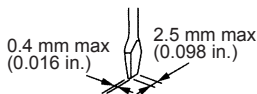
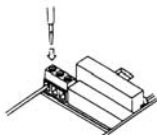

Insert the wire into the lower part of the terminal block and connect it tightly with a screwdriver.



- Keep the screwdriver vertical to the Inverter.
- Refer to Page 30 for tightening torques.

5.5 mm
(0.22 in.)



The wire sheath strip length must be 5.5 mm (0.22 in.).

Open the front cover and verify that the strip length is 5.5 mm (0.22 in.).

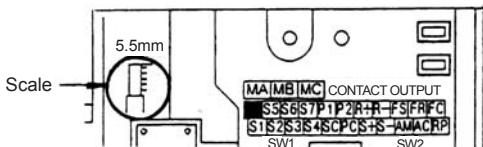

■ Wiring Inspection

After completing wiring, check the following.

- Wiring is proper.
- Wire clippings or screws are not left in the Inverter.
- Screws are securely tightened.
- Bare wires in the terminals do not contact other terminals.



WARNING

If the power supply is turned ON while the FWD (or REV) Run Command is given, the motor will start automatically.

Turn the power supply ON after verifying that the RUN signal is OFF.

Failure to observe this warning may result in injury.



1. If the FWD (or REV) Run Command is given when the Run Command from the control circuit terminal is selected (n003 = 1), the motor will start automatically after the main circuit input power supply is turned ON.
2. To set the 3-wire sequence, set terminal S3 (n052) to 0.

5 Operating the Inverter

The Control Mode Selection (n002) is initially set to V/f control mode.

WARNING

- Only turn ON the input power supply after confirming that the Digital Operator or blank cover (optional) are in place. Do not remove the Digital Operator or the covers while current is flowing. Failure to observe this warning may result in an electric shock.
- Never operate the Digital Operator or DIP switches with wet hands. Failure to observe this warning may result in an electric shock.
- Never touch the terminals while current is flowing, even if the Inverter is stopped. Failure to observe this warning may result in an electric shock.

CAUTION

- Never touch the heatsinks, which can be extremely hot. Failure to observe this caution may result in harmful burns to the body.
- It is easy to change operation speed from low to high. Verify the safe working range of the motor and machine before operation. Failure to observe this caution may result in injury and machine damage.
- Install a holding brake separately if necessary. Failure to observe this caution may result in injury.
- Do not perform signal checks during operation. The machine or the Inverter may be damaged.
- All the constants set in the Inverter have been preset at the factory. Do not change the settings unnecessarily. The Inverter may be damaged.

■ Test Run

The Inverter operates when a frequency (speed) is set.

There are four operating modes for the V7AZ:

1. Run Command from the Digital Operator (potentiometer/digital setting)
2. Run Command from the control circuit terminals
3. Run Command from MEMOBUS communications
4. Run Command from communication card (optional)

Prior to shipping, the Inverter is set up to receive the Run Command and frequency reference from the Operator. Below are instructions for running the V7AZ using the JVOP-147 Digital Operator (without potentiometer). For instructions on operation, refer to page 50.

Operation reference or frequency reference constants can be selected separately as shown below.

Name	Constant
Run Command Selection	n003 = 0 --- Enables run, stop, and reset from Digital Operator. = 1 --- Enables run and stop from control circuit terminals. = 2 --- Enables MEMOBUS communications. = 3 --- Enables communication card (optional).
Frequency Reference Selection	n004 = 0 --- Enables the Digital Operator's potentiometer setting. = 1 --- Enables Frequency Reference 1 (constant n024). = 2 --- Enables a voltage reference (0 to 10 V) at the control circuit terminal. = 3 --- Enables a current reference (4 to 20 mA) at the control circuit terminal. = 4 --- Enables a current reference (0 to 20 mA) at the control circuit terminal. = 5 --- Enables a pulse train reference at the control circuit terminal. = 6 --- Enables MEMOBUS communications. = 7 --- Enables a voltage reference (0 to 10 V) at the Digital Operator's circuit terminal. = 8 --- Enables a current reference (4 to 20 mA) at the Digital Operator's circuit terminal. = 9 --- Enables communication card (optional).

Operation Steps	Operator Display	Function Indicators	Status Indicators
1. Turn ON the power supply.	6.00		RUN ALARM
2. Set constant n004 to 1.	1		RUN ALARM
3. Set the following constants. n019: 15.0 (acceleration time) n020: 5.0 (deceleration time)	15.0 5.0		RUN ALARM
4. Select forward or reverse run by pressing or key. NOTE Never select REV when reverse run is prohibited.	<i>For</i> (Forward) or <i>rev</i> (Reverse)		RUN ALARM
5. Set the reference by pressing or key.	60.00		RUN ALARM
6. Press .	0.00→60.00		RUN ALARM
7. Press to stop. NOTE If the potentiometer is switched rapidly, the motor also accelerates or decelerates rapidly in proportion to the potentiometer movement. Pay attention to load status and switch the potentiometer at the speed that will not adversely affect motor movement.	60.00→0.00		RUN ↓ ALARM

Status indicators : ON : Flashing (Long flashing) : Flashing : OFF

Selecting Rotation Direction

It is possible to select the direction in which the motor rotates when the Forward Run Command is executed.

The motor rotates in the opposite direction when the Reverse Run Command is executed.

n040 Setting	Description
0	The motor rotates in the counterclockwise direction as viewed from the load when the Forward Run Command is executed.
1	The motor rotates in the clockwise direction as viewed from the load when the Forward Run Command is executed.

 Operation Check Points

- Motor rotates smoothly.
- Motor rotates in the correct direction.
- Motor does not have abnormal vibration or noise.
- Acceleration and deceleration are smooth.
- Motor current consumption is matching to load condition .
- Status indicators and Digital Operator display are correct.

■ Operating the Digital Operator

All functions of the V7AZ are set using the Digital Operator. Below are descriptions of the display and keypad sections.

JVOP-140 Digital Operator

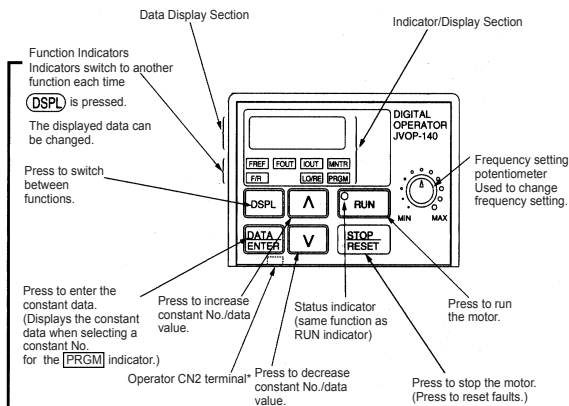

(Rear side of the Operator)

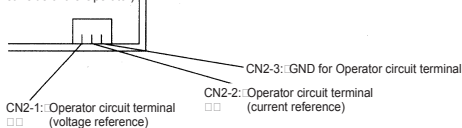

* For details, refer to *Operator Analog Speed Reference Block Diagram* on page 167.

Details of Indicators (Color in parenthesis indicates the color of the indicator.)

FREF Frequency reference setting/monitoring (GREEN)	FOUT Output frequency monitoring (GREEN)	IOUT Output current monitoring (GREEN)	MNTR Multi-function monitoring (GREEN)
F/R Operator Run Command FWD/REV selection (GREEN)		LO/RE LOCAL/REMOTE Selection (RED)	PRGM Constant No./data (RED)

□ Description of Status Indicators

There are two Inverter operation status indicators on the middle right section of the face of the V7AZ. The combinations of these indicators indicate the status of the Inverter (ON, flashing, and OFF). The RUN indicator and status indicator on the **RUN** button have the same function.

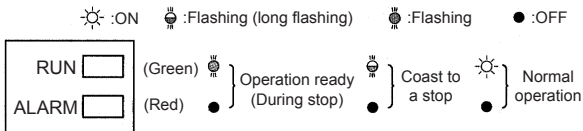

The following table shows the relationship between the Inverter conditions and the indicator on the RUN button of the Digital Operator as well as the RUN and ALARM indicators on the face of the V7AZ.

The indicators are lit, unlit or flashing reflecting the order of priority.

Priority	Digital Operator	Face of the V7AZ		Conditions
	RUN	RUN	ALARM	
1	●	●	●	Power supply is shut down. Until the Inverter become ready after the power is turned ON.
2	●	●		Fault
3				Emergency stop (Stop Command is sent from the Digital Operator when the control circuit terminals were used to operate the Inverter.) Emergency stop (Emergency stop alarm is sent from the control circuit terminal.) Note: Indicators will be the same as with alarm (stopped) occurring after the Inverter is stopped.
4				Emergency stop (Emergency stop fault is sent from the control circuit terminal.) Note: Indicators will be the same as with fault occurring after the Inverter is stopped.
5				Alarm (Stopped)
6				Alarm (Operating) The Run Command is carried out when the External Baseblock Command using the multi-function contact input terminal is issued.
7			●	Stopped (during baseblock)
8			●	Operating (Including the status that the Inverter is operating at a frequency below the minimum output frequency.) During dynamic braking when starting.
9			●	During deceleration to a stop During dynamic braking when stopping.

For details on how the status indicators function for Inverter faults, refer to *Chapter 8 Fault Diagnosis*. If a fault occurs, the ALARM indicator will light.



The fault can be reset by turning ON the Fault Reset signal (or by pressing the  key on the Digital Operator) with the operation signal OFF, or by turning OFF the power supply. If the operation signal is ON, the fault cannot be reset using the Fault Reset signal.

■ Function Indicator Description

By pressing **(DSPL)** on the Digital Operator, each of the function indicators can be selected.

The following flowchart describes each function indicator.

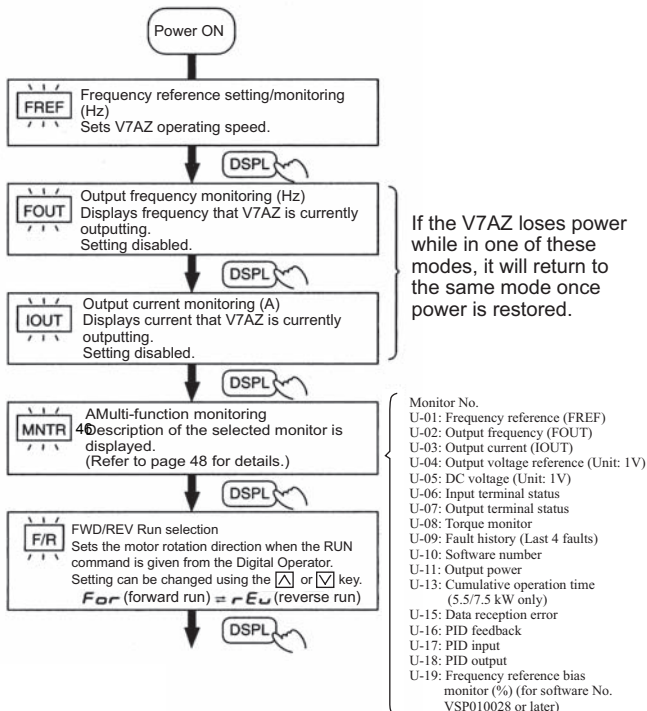

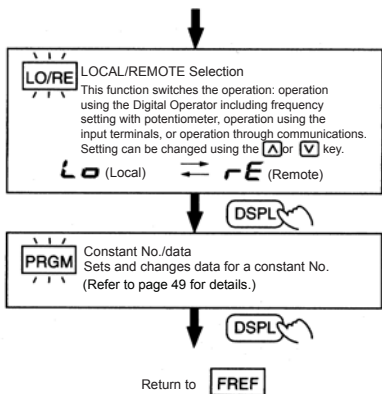

If the V7AZ is stopped after it has changed to any of these modes during operation, it changes to Program mode from Drive mode. Even if the Run Command is turned ON again, the V7AZ does not operate. However, if n001=5, the Run Command can be received and the V7AZ will operate.

⚠ WARNING

If n001=5, a Run Command can be received even while changing a constant. If sending a Run Command while changing a constant, such as during a test run, be sure to observe all safety precautions. Failure to observe this warning may result in injury.

□ MNTR Multi-function Monitoring
Selecting the Monitor

Press the **DSPL** key. When **MNTR** is ON, data can be displayed by selecting the monitor number.

Example: Monitoring the Output Voltage Reference

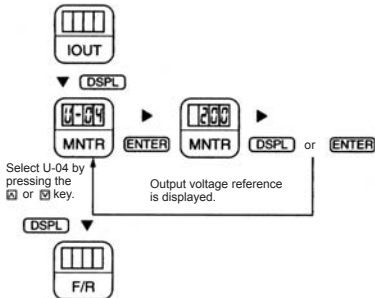

Monitoring

The following items can be monitored using U constants.

Con-stant No.	Name	Unit	Description
U-01	Frequency Reference (FREF)* ¹	Hz	Frequency reference can be monitored. (Same as FREF)
U-02	Output Frequency (FOUT)* ¹	Hz	Output frequency can be monitored. (Same as FOUT)
U-03	Output Current (IOUT)* ¹	A	Output current can be monitored. (Same as IOUT)
U-04	Output Voltage	V	Output voltage can be monitored.
U-05	DC Voltage	V	Main circuit DC voltage can be monitored.
U-06	Input Terminal Status* ²	-	Input terminal status of control circuit terminals can be monitored.
U-07	Output Terminal Status* ²	-	Output terminal status of control circuit terminals can be monitored.
U-08	Torque Monitor	%	The amount of output torque per rated torque of the motor can be monitored. When V/f control mode is selected, "---" is displayed.
U-09	Fault History (Last 4 Faults)	-	The last four fault history records are displayed.
U-10	Software No.	-	Software number can be checked.
U-11	Output Power* ³	kW	Output power can be monitored.
U-13	Cumulative Operation Time * ⁴	×10 H	Cumulative operation time can be monitored in units of 10 hours.
U-15	Data Reception Error* ⁵	-	Contents of MEMOBUS communication data reception error can be checked. (Contents of transmission register No. 003DH are the same.)
U-16	PID Feedback* ⁶	%	Input 100(%) / Max. output frequency or equivalent
U-17	PID Input* ⁶	%	±100(%) / ± Max. output frequency
U-18	PID Output* ⁶	%	±100(%) / ± Max. output frequency
U-19	Frequency Reference Bias Monitor * ⁷	%	Bias can be monitored when Up/Down Command 2 is used.

* 1. The status indicator is not turned ON.

* 2. Refer to the next page for input/output terminal status.

* 3. The display range is from -99.9 to 99.99 kW.

When regenerating, the output power will be displayed in units of 0.01 kW when -9.99 kW or less and in units of 0.1 kW when more than -9.99 kW.

In vector control mode, “---” will be displayed.

- * 4. Applicable only for Inverters of 5.5 kW and 7.5 kW (200 V and 400 V Classes).
- * 5. Refer to the next page for data reception error.
- * 6. Displayed in units of 0.1% when less than 100% and in units of 1% when 100% or more. The display range is from -999% to 999%.
- * 7. Applicable for Inverters with software version VSP0105740(4.0kW or less) and VSP015750(5.5kW and 7.5kW).

□ Input/Output Terminal Status

Input Terminal Status

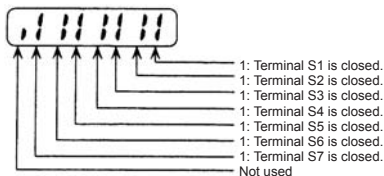

Output Terminal Status

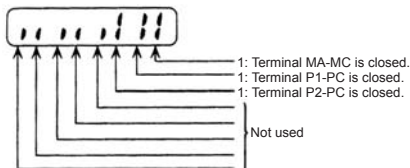

□ Data Reception Error Display

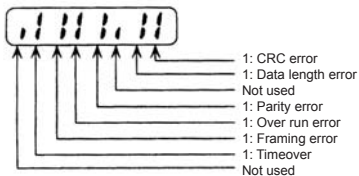



Fault History Display Method

When U-09 is selected, a four-digit box is displayed. The three digits from the right show the fault description, and the digit on the left shows the order of fault (from one to four). Number 1 represents the most recent fault, and numbers 2, 3, 4 represent the other faults, in ascending order of fault occurrence.

Example:

- 4-digit number
 ■ : Order of fault (1 to 4)
 □□□ : Fault description
 "---" is displayed if there is no fault.
 (Refer to *Chapter 8 Fault Diagnosis* for details.)

Switching Fault History Records

The fault that is displayed can be changed using the  or  key.

Clearing the Fault History

Set constant n001 to 6 to clear the fault history. The display will return to n001 after 6 is set.

Note: Initializing the constants (n001=12, 13) also clears the fault history.

Setting and Referencing Constants

The following diagram shows how to select and change constants.

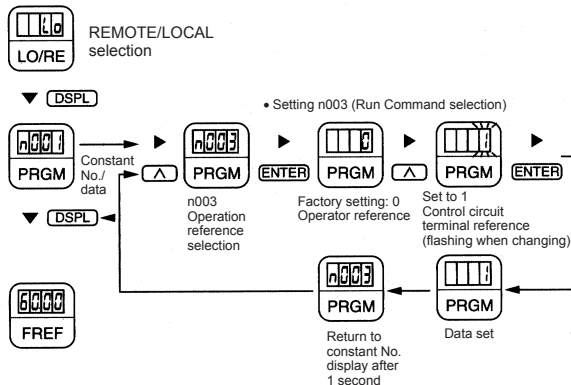













■ Simple Data Setting





Digital setting (refer to *5 Operating the Inverter*) and potentiometer setting are both possible for simple acceleration/deceleration operation of the V7AZ.

Digital setting is set at the factory (n004=1). For the model with JVOP-140 Digital Operator (with potentiometer), factory setting is set by a frequency-setting potentiometer (n004=0).

Following is an example in which the function indicators are used to set frequency reference, acceleration time, deceleration time, and motor direction.

Data Setting by Frequency-setting Potentiometer

Operation Steps	Operator Display	Function Indicators	Status Indicators
1. Turn the potentiometer fully to the left. Then, turn the power ON.	0.00		RUN  ALARM 
2. F/R flashes. Select FWD/REV Run using keys. NOTE Never select REV when reverse run is prohibited.	FOR or REV		RUN  ALARM 
3. Press DSPL to flash FREF. Then press RUN.	0.00		RUN  ALARM 
4. Operate the motor by turning the potentiometer to the right. (Frequency reference corresponding to the potentiometer position is displayed.) NOTE If the potentiometer is switched rapidly, the motor also accelerates or decelerates rapidly corresponding to the potentiometer movement. Pay attention to load status and switch the potentiometer at a speed that does not affect motor movement.	0.00 to 60.00 Minimum output frequency is 1.50 Hz		RUN  ALARM 

Status indicators  : ON  : Flashing (Long flashing)  : Flashing  : OFF

6 Programming Features

Factory settings of the constants are shaded in the tables. After wiring is complete, be sure to make the following settings before operation.

Hardware

Make the following settings before the Inverter is turned ON.

Item	Ref. page
Sequence input signal (S1 to S7) polarity selection	226
Voltage reference / current reference input selection of control circuit terminal FR	126

Software (Constant)

Item	Ref. page	
Environment setting	Constant Selection / Initialization (n001)	53
	Control Mode Selection (n002)	59
	Run Command Selection (n003)	63
	Frequency Reference Selection (n004)	64
	Stopping Method Selection (n005)	106
Basic characteristics and frequency reference setting	V/f pattern setting (n011 to n017)	55
	Acceleration Time 1 (n019), Deceleration Time 1 (n020)	77
	Frequency Reference 1 to 8 (n024 to n031)	74
Motor protection	Motor Rated Current (n036)	136
	Electric Thermal Motor Protection Selection (n037)	136
Countermeasure for noise and leakage current	Carrier Frequency Reference (n080)	94
Using an optional braking resistor	Stall Prevention during Deceleration (n092)	134

■ Constant Setup and Initialization

□ Constant Selection/Initialization (n001)

 **WARNING** If n001=5, a Run Command can be received even while changing a constant. If sending a Run Command while changing a constant, such as during a test run, be sure to observe all safety precautions. Failure to observe this warning may result in injury.

The following table lists the data that can be set or read when n001 is set. By setting this constant, the fault history can be cleared and the constants initialized. Unused constants between n001 and n179 are not displayed.

n001 Setting	Constant That Can Be Set	Constant That Can Be Referenced
0	n001	n001 to n179
1	n001 to n049* ¹	
2	n001 to n079* ¹	
3	n001 to n119* ¹	
4	n001 to n179* ¹	
5	n001 to n179* ¹ (Run Command can be received in Program mode.)	
6	Fault history cleared	
7 to 11	Not used	
12	Initialize	
13	Initialize (3-wire sequence)* ²	

* 1. Excluding setting-disabled constants.

* 2. Refer to page 112.



Err appears on the display for one second and the set data returns to its initial values in the following cases.

1. If the set values of Multi-function Input Selections 1 to 7

(n050 to n056) are the same

2. If the following conditions are not satisfied in the V/f pattern setting:

Max. Output Frequency (n011) \geq Max. Voltage Output Frequency (n013)
> Mid. Output Frequency (n014)
 \geq Min. Output Frequency (n016)

Note: Mid. Output Frequency (n014) is also used for motor 2 settings, n014 has to be lower than n140 and n147.

For details, refer to *Adjusting Torque According to Application (V/f Pattern Setting)* on page 55.

3. If the following conditions are not satisfied in the jump frequency settings:
Jump Frequency 3 (n085) \leq Jump Frequency 2 (n084)
 \leq Jump Frequency 1 (n083)
4. If the Frequency Reference Lower Limit (n034) \leq Frequency Reference Upper Limit (n033)
5. If the Motor Rated Current (n036) \leq 150% of Inverter rated current
6. If one of the Acceleration/Deceleration Time settings (n019 to n022) exceeds 600.0 sec. and it is tried to set n018 to 1 (Acceleration/Deceleration Time Unit 0.01 sec).

■ Using V/f Control Mode

V/f control mode is preset at the factory.

Control Mode Selection (n002) = 0: V/f control mode (factory setting)
1: Vector control mode

□ Adjusting Torque According to Application

Adjust motor torque by using the V/f pattern and full-range automatic torque boost settings.

V/f Pattern Setting

Set the V/f pattern in n011 to n017 as described below. Set each pattern when using a special motor (e.g., high-speed motor) or when requiring special torque adjustment of the machine.

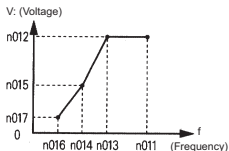

Be sure to satisfy the following conditions for the settings of n011 to n017.

$n016 \leq n014 < n013 \leq n011$

If $n016 = n014$, the setting of n015 will be disabled.

Note: n014 is also used for motor 2 settings. ($n014 < n140, n147$)

Constant No.	Name	Unit	Setting Range	Factory Setting
n011	Max. Output Frequency	0.1 Hz	50.0 to 400.0 Hz	50.0 Hz
n012	Max. Voltage	0.1 V	0.1 to 255.0 V (0.1 to 510.0 V)	200.0 V (400.0 V)
n013	Max. Voltage Output Frequency (Base Frequency)	0.1 Hz	0.2 to 400.0 Hz	50.0 Hz
n014	Mid. Output Frequency	0.1 Hz	0.1 to 399.9 Hz	1.3 Hz
n015	Mid. Output Frequency Voltage	0.1 V	0.1 to 255.0 V (0.1 to 510.0 V)	12.0 V* (24.0 V)
n016	Min. Output Frequency	0.1 Hz	0.1 to 10.0 Hz	1.3 Hz
n017	Min. Output Frequency Voltage	0.1 V	0.1 to 50.0 V (0.1 to 100.0 V)	12.0 V* (24.0 V)

Note: The values in the parentheses are for the 400 V Class of Inverters.

* 10.0 V (20.0 V) for Inverters of 5.5 kW and 7.5 kW (200 V and 400 V Classes).

Typical Setting of the V/f Pattern

Set the V/f pattern according to the application as described below. For 400-V Class Inverters, the voltage values (n012, n015, and n017) should be doubled. When running at a frequency exceeding 50/60 Hz, change the Maximum Output Frequency (n011).

Note: Always set the maximum output frequency according to the motor characteristics.

1. For General-purpose Applications

Motor Specification: 60 Hz

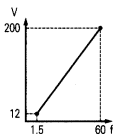

Constant	Setting
n011	60.0
n012	200.0
n013	60.0
n014	1.5
n015	12.0
n016	1.5
n017	12.0

Motor Specification: 50 Hz
(Factory setting)

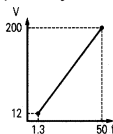

Constant	Setting
n011	50.0
n012	200.0
n013	50.0
n014	1.3
n015	12.0
n016	1.3
n017	12.0

2. For Fans/Pumps

Motor Specification: 60 Hz

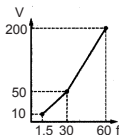

Constant	Setting
n011	60.0
n012	200.0
n013	60.0
n014	30.0
n015	50.0
n016	1.5
n017	10.0

Motor Specification: 50 Hz

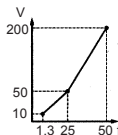

Constant	Setting
n011	50.0
n012	200.0
n013	50.0
n014	25.0
n015	50.0
n016	1.3
n017	10.0

3. For Applications Requiring High Starting Torque

Motor Specification: 60 Hz

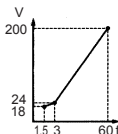

Constant	Setting
n011	60.0
n012	200.0
n013	60.0
n014	3.0
n015	24.0
n016	1.5
n017	18.0

Motor Specification: 50 Hz

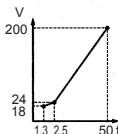

Constant	Setting
n011	50.0
n012	200.0
n013	50.0
n014	2.5
n015	24.0
n016	1.3
n017	18.0

Increasing the voltage of the V/f pattern increases motor torque, but an excessive increase may cause motor overexcitation, motor overheating, or vibration.

Note: Constant n012 must be set to motor rated voltage.

Full-range Automatic Torque Boost (when V/f Mode is Selected: n002=0)

The motor torque requirement changes according to load conditions. The full-range automatic torque boost adjusts the voltage of the V/f pattern according to requirements. The V7AZ automatically adjusts the voltage during constant-speed operation, as well as during acceleration.

The required torque is calculated by the Inverter.

This ensures triplex operation and energy-saving effects.

$$\boxed{\text{Output voltage}} \propto \boxed{\text{Torque Compensation Gain (n103)}} \times \boxed{\text{Required torque}}$$

Operation

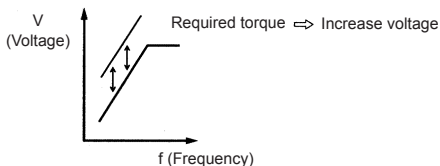

Normally, no adjustment is necessary for the Torque Compensation Gain (n103, factory setting: 1.0). When the wiring distance between the Inverter and the motor is long, or when the motor generates vibration, change the automatic torque boost gain. In these cases, set the V/f pattern (n011 to n017).

Adjustment of the Torque Compensation Time Constant (n104) and the Torque Compensation Iron Loss (n105) are normally not required.

Adjust the torque compensation time constant under the following conditions:

- Increase the setting if the motor generates vibration.
- Reduce the setting if response is slow.

■ Using Vector Control Mode

Set the Control Mode Selection (n002) to use vector control mode.

- n002 = 0: V/f control mode (factory setting)
 1: Vector control mode

□ Precautions for Voltage Vector Control Application

Vector control requires motor constants. The factory settings constants have been set at the factory prior to shipment. Therefore, when a motor designed for an Inverter is used or when a motor from any other manufacturer is driven, the required torque characteristics or speed control characteristics may not be maintained because the constants are not suitable. Set the following constants so that they match the required motor constants.

Constant No.	Name	Unit	Setting Range	Factory Setting
n106	Motor Rated Slip	0.1 Hz	0.0 to 20.0 Hz	*
n107	Motor Line-to-neutral Resistance	0.001 Ω (less than 10 Ω) 0.01 Ω (10 Ω or more)	0.000 to 65.50 Ω	*
n036	Motor Rated Current	0.1 A	0% to 150% of Inverter rated current	*
n110	Motor No-load Current	1%	0% to 99% (100% = motor rated current)	*

* Setting depends on Inverter capacity. (Refer to pages 245 and 246.)

Adjustment of the Torque Compensation Gain (n103) and the Torque Compensation Time Constant (n104) is normally not required.

Adjust the torque compensation time constant under the following conditions:

- Increase the setting if the motor generates vibration.
- Reduce the setting if response is slow.

Adjust the Slip Compensation Gain (n111) while driving the load so that the target speed is reached. Increase or decrease the setting in increments of 0.1.

- If the speed is less than the target value, increase the slip compensation gain.
- If the speed is more than the target value, reduce the slip compensation gain.

Adjustment of the Slip Compensation Time Constant (n112) is normally not required. Adjust it under the following conditions:

- Reduce the setting if response is slow.
- Increase the setting if speed is unstable.

Select slip compensation status during regeneration as follows:

n113 Setting	Slip Correction during Regenerative Operation
0	Disabled
1	Enabled

□ Motor Constant Calculation

An example of motor constant calculation is shown below.

1. Motor Rated Slip (n106)

$$= \frac{\frac{120 \times \text{Motor rated frequency (Hz)}^{*1}}{\text{Number of motor poles}} - \text{Motor rated speed (min}^{-1}\text{)}^{*2}}{120/\text{Number of motor poles}}$$

2. Motor Line-to-neutral Resistance (n107)

Calculations are based on the line-to-line resistance and insulation grade of the motor test report.

E type insulation: Test report of line-to-line resistance at 75°C (Ω) × 0.92 × $\frac{1}{2}$

B type insulation: Test report of line-to-line resistance at 75°C (Ω) × 0.92 × $\frac{1}{2}$

F type insulation: Test report of line-to-line resistance at 115°C (Ω) × 0.87 × $\frac{1}{2}$

3. Motor Rated Current (n036)

$$= \text{Rated current at motor rated frequency (Hz)}^{*1} \text{ (A)}$$

4. Motor No-load Current (n110)

$$= \frac{\text{No-load current (A) at motor rated frequency (Hz)}^{*1}}{\text{Rated current (A) at motor rated frequency (Hz)}^{*1}} \times 100 \text{ (\%)}$$

* 1. Base frequency (Hz) during constant output control

* 2. Rated speed (rpm) at base frequency during constant output control

Set n106 (Motor Rated Slip), n036 (Motor Rated Current), n107 (Motor Line-to-neutral Resistance), and n110 (Motor No-load Current) according to the motor test report.

To connect a reactor between the Inverter and the motor, set n108 to the sum of the initial value of n108 (Motor Leakage Inductance) and the externally mounted reactor inductance. Unless a reactor is connected, n108 (Motor Leakage Inductance) does not have to be set according to the motor.

□ V/f Pattern during Vector Control

Set the V/f pattern as follows during vector control:

The following examples are for 200 V Class motors. When using 400 V Class motors, double the voltage settings (n012, n015, and n017).

Standard V/f

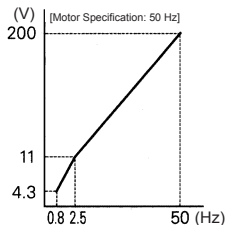
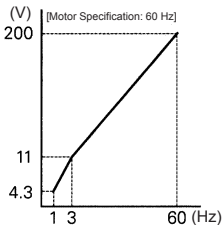

High Starting Torque V/f

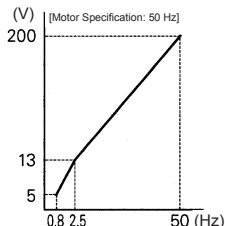
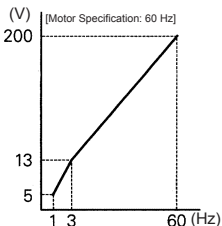

When operating with a frequency larger than 60/50 Hz, change only the Max. Output Frequency (n011).

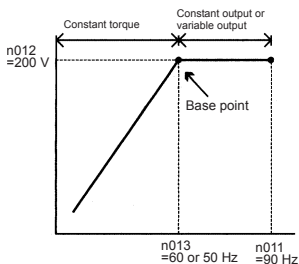

■ Switching LOCAL/REMOTE Mode

The following functions can be selected by switching LOCAL or REMOTE mode. To select the Run/Stop Command or frequency reference, change the mode in advance depending on the following applications.

- LOCAL mode: Enables the Digital Operator for Run/Stop Commands and FWD/REV Run Commands. The frequency reference can be set using the potentiometer or **FREF**.
- REMOTE mode: Enables Run Command Selection (n003). The frequency reference can be set using the Frequency Reference Selection (n004).

□ How to Select LOCAL/REMOTE Mode

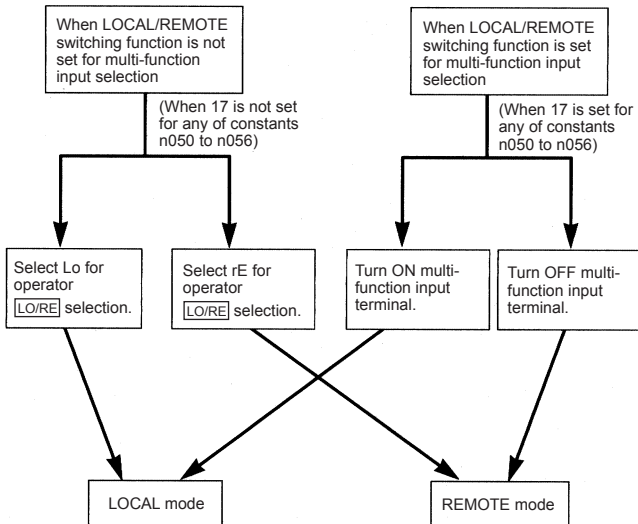

■ Selecting Run/Stop Commands

Refer to *Switching LOCAL/REMOTE Mode* (page 62) to select either the LOCAL mode or REMOTE mode.

The operation method (Run/Stop Commands, FWD/REV Run Commands) can be selected using the following method.

□ LOCAL Mode

When Lo (local mode) is selected for Digital Operator LO/RE ON mode, or when the LOCAL/REMOTE switching function is set and the input terminals are turned ON, run operation is enabled by the STOP or RUN on the Digital Operator, and FWD/REV is enabled by the F/R ON mode (using the or key).

□ REMOTE Mode

1. Select REMOTE mode.

The following two methods can be used to select REMOTE mode.

- Select rE (REMOTE mode) for the **LO/RE** selection.
- When the LOCAL/REMOTE switching function is selected for the multi-function input selection, turn OFF the input terminal to select REMOTE mode.

2. Select the operation method by setting constant n003.

n003=0: Enables the Digital Operator (same with LOCAL mode).

=1: Enables the multi-function input terminal (see fig. below).

=2: Enables communications (refer to page 141).

=3: Enables communication card (optional).

- Example when using the multi-function input terminal as operation reference (two-wire sequence)

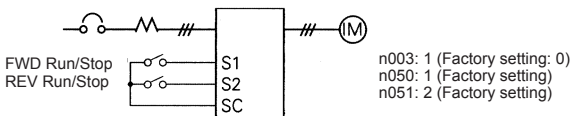

- For an example of three-wire sequence, refer to page 112.
- For more information on how to select the sequence polarity, refer to page 226.

Note: When the Inverter is operated without the Digital Operator, always set constant n010 to 0.

n010 = 0: Detects fault contact of the Digital Operator (factory setting)

= 1: Does not detect fault contact of the Digital Operator

□ Operating (Run/Stop Commands) by Communications

Setting constant n003 to 2 in REMOTE mode enables using Run/Stop commands via MEMOBUS communications. For commands using communications, refer to page 141.

■ Selecting Frequency Reference

Select REMOTE or LOCAL mode in advance. For the method for selecting the mode, refer to page 63.

□ LOCAL Mode

Select the command method using constant n008.

n008=0: Enables using the potentiometer on the Digital Operator.

=1: Enables digital setting on the Digital Operator (factory setting).

The factory setting for models with the Digital Operator with a potentiometer (JVOP-140) is n008=0.

• Digital Setting Using the Digital Operator

Input the frequency while **FREF** is lit (press **ENTER** after setting the numeric value).

Frequency reference setting is effective when 1 (factory setting: 0) is set for constant n009 instead of pressing **ENTER**.

n009 =0: Enables frequency reference setting using the **ENTER** key.

=1: Disables frequency reference setting using the **ENTER** key.

□ REMOTE Mode

Select the command method in constant n004.

n004 =0: Enables frequency reference setting using the potentiometer on the Digital Operator.

=1: Enables using frequency reference 1 (n024) (factory setting)
Factory setting of models with the Digital Operator with a potentiometer (JVOP-140) is n004=0.

=2: Enables a voltage reference (0 to 10 V) (refer to the figure on page 65).

=3: Enables a current reference (4 to 20 mA) (refer to page 126).

=4: Enables a current reference (0 to 20 mA) (refer to page 126).

=5: Enables a pulse train reference (refer to page 128).

=6: Enables communication (refer to page 141).

=7: Enables a voltage reference on Digital Operator circuit terminal CN2 (0 to 10 V)

=8: Enables a current reference on Digital Operator circuit terminal CN2 (4 to 20 mA)

=9: Enables communication card (optional).

Example of frequency reference by voltage signal

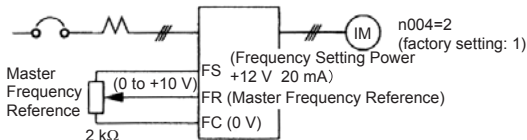

■ Setting Operation Conditions

□ Autotuning Selection (n139)

Motor data required for vector control can be measured and set by inputting the data from the nameplate of the motor to be used and performing autotuning for the motor. Autotuning is possible only for motor 1.



Autotuning mode cannot be entered when motor 2 is selected using a Motor Switching Command allocated to a multi-function input (i.e., Autotuning Selection (n139) setting is not possible).

Constant No.	Name	Unit	Setting Range	Factory Setting
n139	Autotuning Selection	–	0 to 2	0

n139 Settings

Setting	Function
0	Disabled
1	Rotational autotuning (motor 1)
2	Stationary autotuning for motor line-to-neutral resistance only (motor 1)

Note: Setting is not possible when motor 2 is selected using a Motor Switching Command allocated to a multi-function input. ("Err" will be displayed on the Digital Operator, and the setting will return to the value before the change.)

Use the following procedure to perform autotuning to automatically set motor constants when using the V/f control method, when the cable length is long, etc.

Setting the Autotuning Mode

One of the following two autotuning modes can be set.

- Rotational autotuning
- Stationary autotuning for motor line-to-neutral resistance only

Always confirm the precautions before autotuning.

- Rotational Autotuning (n139 = 1)

Rotational autotuning is used only for open-vector control. Set n139 to 1, input the data from the nameplate, and then press the RUN key on the Digital Operator. The Inverter will stop the motor for approximately 1 minute and then set the required motor constants automatically while operating the motor for approximately 1 minute.

NOTE

1. When performing rotational autotuning, be sure to separate the motor from the machine and first confirm that it is safe for the motor to rotate.
2. For a machine in which the motor itself cannot be rotated, set the values from the motor test report.
3. If automatic rotation poses no problem, perform rotational autotuning to ensure performance.

- Stationary Autotuning for Motor Line-to-neutral Resistance Only (n139 = 2)

Autotuning can be used to prevent control errors when the motor cable is long or the cable length has changed since installation or when the motor and Inverter have different capacities.

Set n139 to 2 for open-loop vector control, and then press the RUN key on the Digital Operator. The Inverter will supply power to the stationary motor for approximately 20 seconds and the Motor Line-to-neutral Resistance (n107) and cable resistance will be automatically measured.

NOTE

1. Power will be supplied to the motor when stationary autotuning for motor line-to-neutral resistance only is performed even though the motor will not turn. Do not touch the motor until autotuning has been completed.
2. When performing stationary autotuning for motor line-to-neutral resistance only connected to a conveyor or other machine, ensure that the holding brake is not activated during autotuning.

Precautions before Using Autotuning

Read the following precautions before using autotuning.

- Autotuning the Inverter is fundamentally different from autotuning the servo system. Inverter autotuning automatically adjusts parameters according to detected motor constants, whereas servo system autotuning adjusts parameters according to the detected size of the load.

- When speed precision is required at high speeds (i.e., 90% of the rated speed or higher), use a motor with a rated voltage that is 20 V less than the input power supply voltage of the Inverter for 200V-class Inverters and 40 V less for 400V-class Inverters. If the rated voltage of the motor is the same as the input power supply voltage, the voltage output from the Inverter will be unstable at high speeds and sufficient performance will not be possible.
- Use stationary autotuning for motor line-to-neutral resistance only whenever performing autotuning for a motor that is connected to a load. (To ensure performance, set the value from the motor test report.)
- Use rotational autotuning if performing autotuning is possible while not connected to a load.
- If rotational autotuning is performed for a motor connected to a load, the motor constants will not be found accurately and the motor may exhibit abnormal operation. Never perform rotational autotuning for a motor connected to a load.
- The status of the multi-function inputs and multi-function outputs will be as shown in the following table during autotuning. When performing autotuning with the motor connected to a load, be sure that the holding brake is not applied during autotuning, especially for conveyor systems or similar equipment.

Tuning Mode	Multi-function Inputs	Multi-function Outputs
Rotational autotuning	Do not function.	Same as during normal operation
Stationary autotuning for motor line-to-neutral resistance only	Do not function.	Maintain same status as when autotuning is started.

- To cancel autotuning, always use the DSPL PRGM STOP key on the Digital Operator.

Precautions for Using Autotuning(when motor voltage > supply voltage)

Use the following procedure to perform autotuning if using a motor with a rated voltage higher than the Inverter input power supply.

1. Input the rated voltage from the motor nameplate for the Maximum Voltage (n012).
2. Set the Maximum Voltage Output Frequency (n013) to the base frequency on the motor nameplate.
3. Perform autotuning.
4. Record the Motor No-load Current (n110).

5. Calculate the rated secondary current of the motor using the following equation:

$$\text{Rated Secondary Current} = \sqrt{(\text{Rated Current})^2 - (\text{No-Load Current})^2}$$

6. Input the power supply voltage for the Maximum Voltage (n012).
7. Input the following calculated value for the Maximum Voltage Output Frequency (n013):

Maximum Voltage Output Frequency =

$$\frac{\text{Base Frequency on the Motor Nameplate} \times \text{Power Supply Voltage}}{\text{Rated Voltage on the Motor Nameplate}}$$

8. Perform autotuning again.
9. Record the Motor No-load Current (n110) again.
10. Calculate the rated secondary current of the motor using the following equation:

Rated Secondary Current =

$$\frac{\text{Rated Secondary Current calculated in Step 5} \times \text{Rated Voltage on Motor Nameplate}}{\text{Power Supply Voltage}}$$

11. Input the following calculated value for the Motor Rated Slip (n106):

Motor Rated Slip =

$$\frac{\left(\text{Base Freq. from Motor Nameplate} - \text{Rated Speed from Motor Nameplate} \times \frac{\text{Number of Poles}}{120} \right)}{\text{No-Load Current in Step 9} \times \frac{\text{No-Load Current in Step 4}}{\text{Rated Secondary Current in Step 5}}}$$

NOTE

- When speed precision is required at high speeds (i.e., 90% of the rated speed or higher), set n012 (Max. Voltage) to the input power supply voltage $\times 0.9$.
- When operating at high speeds (i.e., 90% of the rated speed or higher), the output current will increase as the input power supply voltage is reduced. Be sure to provide sufficient margin in the Inverter current.

Operating Procedure

1. Confirm the following:

- The motor is separated from the machine system.
- The motor shaft lock key is removed.
- If there is a brake, it is released.
- The wiring is correct.

2. The Inverter power supply is ON.

3. There is no error.

4. Select Program Mode by pressing _____ until _____ is lit.

5. Set the following constants for the selected motor to the nameplate

values.

Constant No.	Name	Setting Range	Remarks
n012	Maximum Voltage	0.1 to 255.0	Set to the rated voltage from the nameplate.
n013	Maximum Voltage Output Frequency	0.2 to 400.0	Set to the base frequency from the nameplate.
n036	Motor Rated Current	0.0 to 999.9	Set to the rated current from the nameplate.
n106	Motor Rated Slip	0.0 to 20.0 Hz	Set to the value of the following equation using data from the nameplate: Base frequency – Rated speed × Number of poles / 120

When performing precision setting (i.e., when performing autotuning using a motor test report or design data), the input data to set when autotuning will differ. Refer to the table below.

Name	Simple Setting	Precision Setting
Maximum Voltage	Motor rated voltage	Voltage under no-load conditions at motor rated speed
Maximum Voltage Output Frequency	Motor base frequency	Frequency under no-load conditions at rated speed
Motor Rated Slip	Base frequency – Rated speed × Number of poles / 120	Slip at rated torque

6. Set the Autotuning Selection (n139).

7. Press the **[DSPL]** key to select the autotuning mode.

- The Digital Operator will display "TUn□." The □ shows the autotuning method selected for n139.
- All function indicators will turn OFF.
- The status indicators will return to operation ready status.
- Only the **[RUN]**, **[DSPL]**, and **[STOP]** keys will be accepted in autotuning mode.
- Autotuning will start when the **[RUN]** key is input.
- Autotuning will be cancelled when the **[STOP]** key is input

- When the **[DSPL]** key is input, status will return again to Program Mode, and constants can be changed.
8. Press the **[RUN]** key to perform autotuning. Power will be supplied to the motor with the selected autotuning method.
- "TUn□" will flash during autotuning.
 - All function indicators will turn OFF.
 - The status indicators will change to normal operation status.
9. Tuning Completed
- When autotuning has been completed properly, "End" will be displayed and constants will be changed according to the tuning results.
 - When rotational autotuning is completed, the Middle Output Frequency Voltage and Minimum Output Frequency Voltage will be calculated and set according to the selected Maximum Voltage as shown in the following table.

Constant No.	Name	Setting Range	Remarks
n015	Middle Output Frequency Voltage	0.1 to 255.0	$(\text{Factory-set Middle Output Frequency Voltage}) \times (\text{Maximum Voltage set value}) / (\text{Factory-set Maximum Voltage})$
n017	Minimum Output Frequency Voltage	0.1 to 50.0	$(\text{Factory-set Minimum Output Frequency Voltage}) \times (\text{Maximum Voltage set value}) / (\text{Factory-set Maximum Voltage})$

10. Press the **[DSPL]** key to select the Drive Mode. This completes autotuning.

Error Processing during Autotuning

- Errors and alarms that occur during normal operation are also detected during autotuning.
- If an error or alarm occurs, the motor will coast to a stop (baseblock) and autotuning will be cancelled.

-
- If an error in measurement occurs or the **STOP** key has been pressed during autotuning, an EXX error will be displayed, the motor will coast to a stop, and autotuning will be cancelled. This error message, however, does not remain in the error log. Refer to page 211 for information on errors.
 - If autotuning is cancelled, constants changed by autotuning will automatically return to their values before the start of autotuning.
 - If an error occurs while decelerating to a stop at the end of autotuning, an error will be displayed on the Digital Operator, but autotuning processing will not be cancelled. The results of autotuning will be valid.

Precautions after Using Autotuning

For a fixed output region, the V/f pattern for the maximum point in the output region must be set after completing autotuning. To increase the motor's rated speed by 1 to 1.2 times or when using a fixed output motor, make the following changes after autotuning. Do not change n012 (Max. Voltage) or n013 (Max. Voltage Output Frequency).

- **Increasing the Motor's Rated Speed by 1 to 1.2 Times**

To increase the motor's rated speed by 1 to 1.2 times, use the following formula to change the setting of Max. Output Frequency (n011):

Max. output frequency = (motor rated speed) x (no. of motor poles)/120 (Hz) x 1 to 1.2)

If the motor's speed is increased beyond the rated speed, fixed output characteristics will be used at high speeds and motor torque will be reduced.

- **Applications to Constant Output Motors Such as Motors for Machine Tools**

Use the following formula to change the settings of n011 (Max. Output Frequency) when using a motor with a fixed output, e.g., a motor for a machine tool:

n011 = Frequency (Hz) at maximum speed under no-load conditions (load rate = 0)

Do not change the motor constants after performing autotuning.

Digital Operator Displays during Autotuning

Function indicators on the Digital Operator change during autotuning as in the following diagram.

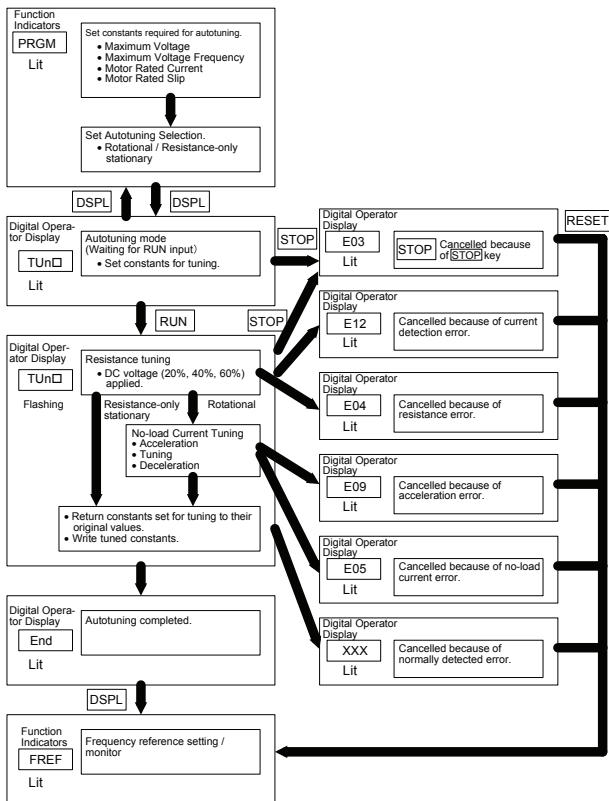

□ Reverse Run Prohibit (n006)

The Reverse Run Prohibit setting disables accepting a Reverse Run Command from the control circuit terminal or Digital Operator. This setting is used for applications where a Reverse Run Command can cause problems.

Setting	Description
0	Reverse run enabled.
1	Reverse run disabled.

□ Multi-step Speed Selection

Up to 17 speed steps (including Jog frequency reference) can be set using the following combinations of frequency reference and input terminal selections.

8-step speed change

n003=1 (Operation mode selection)
n004=1 (Frequency reference selection)
n024=25.0 Hz (Frequency reference 1)
n025=30.0 Hz (Frequency reference 2)
n026=35.0 Hz (Frequency reference 3)
n027=40.0 Hz (Frequency reference 4)
n028=45.0 Hz (Frequency reference 5)
n029=50.0 Hz (Frequency reference 6)
n030=55.0 Hz (Frequency reference 7)
n031=60.0 Hz (Frequency reference 8)

* For more information on how to select the sequence voltage and the current input, refer to page 226.

NOTE

When all multi-function reference inputs are OFF, the frequency reference selected by constant n004 (Frequency Reference Selection) becomes effective.

n054=6 (Multi-function contact input terminal S5)
n055=7 (Multi-function contact input terminal S6)
n056=8 (Multi-function contact input terminal S7)
n053=1

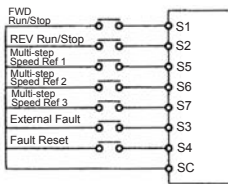

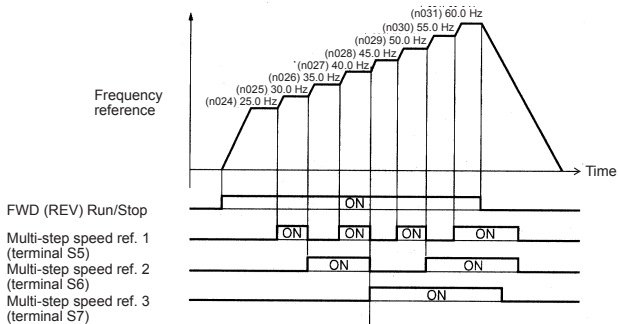

- n050 = 1 (Input terminal S1) (factory setting)
- n051 = 2 (Input terminal S2) (factory setting)
- n052 = 3 (Input terminal S3) (factory setting)
- n053 = 5 (Input terminal S4) (factory setting)
- n054 = 6 (Input terminal S5) (factory setting)
- n055 = 7 (Input terminal S6) (factory setting)
- n056 = 8 (Input terminal S7) (Change the setting to 8.)

16-step speed operation

Set frequency references 9 to 16 for n120 to n127.

Set the input terminal for a multi-step speed reference using the multi-function input selection.

□ Operating at Low Speed

By inputting a Jog Command and then a Forward (Reverse) Run Command, operation is enabled at the jog frequency set in n032. When multi-step speed references 1, 2, 3 or 4 are input simultaneously with the Jog Command, the Jog Command has priority.

Constant No.	Name	Setting
n032	Jog Frequency	Factory setting: 6.00 Hz
n050 to n056	Jog References	Set to 10 for any constant.

□ Adjusting Speed Setting Signal

The relationship between the analog inputs and the frequency reference can be set to provide the frequency reference as analog inputs to control circuit terminal FR or FC.

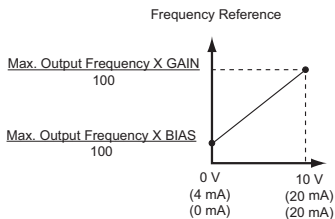

() indicates the value when a current reference input is selected

1. Analog Frequency Reference Gain (n060)

The frequency reference provided when the analog input is 10 V (or 20 mA) can be set in units of 1%. (Max. Output Frequency n011=100%)

* Factory setting: 100%

2. Analog Frequency Reference Bias (n061)

The frequency reference provided when the analog input is 0 V (4 mA or 0 mA) can be set in units of 1%. (Max. Output Frequency n011=100%)

* Factory setting: 0%

Typical Settings

- To operate the Inverter with a frequency reference of 0% to 100% at an input voltage of 0 to 5 V

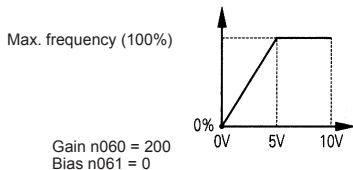

- To operate the Inverter with a frequency reference of 50% to 100% at an input voltage of 0 to 10 V

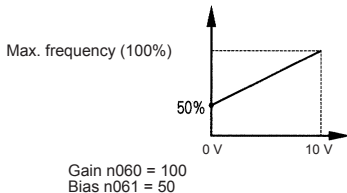

□ Adjusting Frequency Upper and Lower Limits

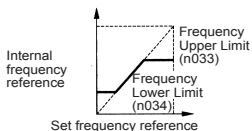

• Frequency Reference Upper Limit (n033)

Sets the upper limit of the frequency reference in units of 1%.

(n011: Max. Output Frequency = 100%)

Factory setting: 100%

• Frequency Reference Lower Limit (n034)

Sets the lower limit of the frequency reference in units of 1%.

(n011: Max. Output Frequency = 100%)

When operating at a frequency reference of 0, operation is continued at the frequency reference lower limit.

However, if the frequency reference lower limit is set to less than the Minimum Output Frequency (n016), operation is not performed.

Factory setting: 0%

□ Using Four Acceleration/Deceleration Times

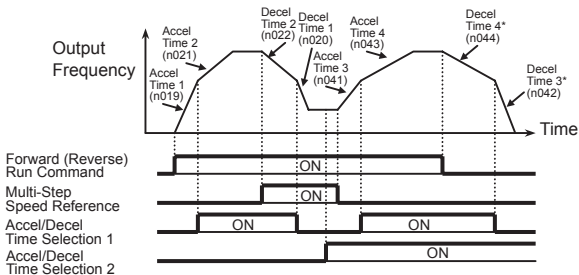

* When deceleration to a stop is selected (n005 = 0).

By setting a multi-function input selection (any one of n050 to n056) to 11 (acceleration/deceleration time selection 1) or 27 (acceleration/deceleration time selection 2), the acceleration/deceleration time is selected by ON/OFF combinations of acceleration/deceleration time selection 1 and acceleration/deceleration time selection 2 (terminals S1 to S7).

The combinations of acceleration/deceleration time selection settings are shown below.

Acceleration/ Deceleration Time Selection 1	Acceleration/ Deceleration Time Selection 2	Acceleration Time	Deceleration Time
OFF	OFF	Acceleration time 1 (n019)	Deceleration time 1 (n020)
ON	OFF	Acceleration time 2 (n021)	Deceleration time 2 (n022)
OFF	ON	Acceleration time 3 (n041)	Deceleration time 3 (n042)
ON	ON	Acceleration time 4 (n043)	Deceleration time 4 (n044)

No.	Name	Unit	Setting Range	Factory Setting
n019	Acceleration Time 1	Depends on n018 setting. (See the next table.)	Depends on n018 setting. (See the next table.)	10.0 s
n020	Deceleration Time 1			10.0 s
n021	Acceleration Time 2			10.0 s
n022	Deceleration Time 2			10.0 s
n041	Acceleration Time 3			10.0 s
n042	Deceleration Time 3			10.0 s
n043	Acceleration Time 4			10.0 s
n044	Deceleration Time 4			10.0 s

n018 Settings

No.	Unit	Setting Range	
n018	0	0.1 s	0.0 to 999.9 s (999.9 s or less)
		1 s	1000 to 6000 s (1000 s or more)
	1	0.01 s	0.00 to 99.99 s (99.99 s or less)
		0.1 s	100.0 to 600.0 s (100 s or more)

Note: Constant n018 can be set while stopped.

If a value exceeding 600.0 s is set for the acceleration/deceleration time when n018=0 (in units of 0.1 s), 1 cannot be set for n018.

- Acceleration time
Set the time needed for the output frequency to reach 100% from 0%.
- Deceleration time
Set the time needed for the output frequency to reach 0% from 100%.
(Max. Output Frequency n011 = 100%)

Momentary Power Loss Ridethrough Method (n081)

**WARNING**

When continuous operation after power recovery is selected, stand clear of the Inverter or the load. The Inverter may restart suddenly after stopping. (Construct the system to ensure safety, even if the Inverter should restart.) Failure to observe this warning may result in injury.

When constant n081 is set to 1 or 2, operation automatically restarts even if a momentary power loss occurs.

Setting ^{*3}	Description
0	Continuous operation after momentary power loss not enabled.
1 ^{*1}	Continuous operation after power recovery within momentary power loss ridethrough time 0.5 s
2 ^{*1, *2}	Continuous operation after power recovery (Fault output not produced.)

- * 1. Hold the operation signal to continue operation after recovery from a momentary power loss.
- * 2. When 2 is selected, the Inverter restarts if power supply voltage recovers while the control power supply is held.
No fault signal is output.

□ S-curve Selection (n023)

To prevent shock when starting and stopping the machine, acceleration/deceleration can be performed using an S-curve pattern.

Setting	S-curve Selection
0	S-curve characteristic not provided.
1	0.2 s
2	0.5 s
3	1.0 s

- Note: 1. S-curve characteristics are not supported for simple positioning control, so use a set value of 0.
2. The S-curve characteristic time is the time from acceleration/deceleration rate 0 to the normal acceleration/deceleration rate determined by the set acceleration/deceleration time.

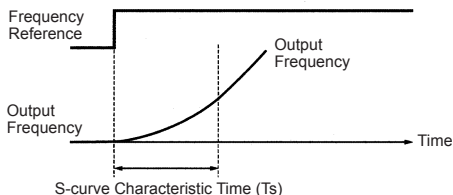

The following time chart shows switching between FWD/REV run when decelerating to a stop.

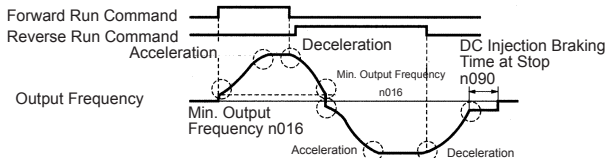

S-curve Characteristics in

□ Torque Detection

If an excessive load is applied to the machine, an increase in the output current can be detected to output an alarm signal to multi-function output terminal MA, MB, P1, or P2.

To output an overtorque detection signal, set one of the output terminal function selections n057 to n059 for overtorque detection (Setting: 6 (NO contact) or 7 (NC contact)).

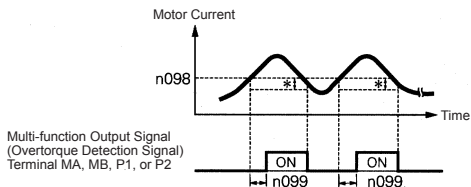

- * The overtorque detection release width (hysteresis) is set at approx. 5% of the Inverter rated current.

Overtorque Detection Function Selection 1 (n096)

Setting	Description
0	Overtorque detection not provided.
1	Detected during constant-speed running. Operation continues after detection.
2	Detected during constant-speed running. Operation stops during detection.
3	Detected during running. Operation continues after detection.
4	Detected during running. Operation stops during detection.

- To detect overtorque during acceleration/deceleration, set n096 to 3 or 4.
- To continue operation after overtorque detection, set n096 to 1 or 3. During detection, the Digital Operator will display an **OL3** alarm (flashing).
- To stop the Inverter and generate a fault at overtorque detection, set n096

to 2 or 4. At detection, the Digital Operator will display an **OL3** fault (ON).

Overtorque Detection Level (n098)

Set the overtorque detection current level in units of 1%. (Inverter rated current = 100%) When detection by torque is selected, the motor rated torque becomes 100%.

Factory setting: 160%

Overtorque Detection Time (n099)

If the time that the motor current exceeds the Overtorque Detection Level (n098) is longer than Overtorque Detection Time (n099), the overtorque detection function will operate.

Factory setting: 0.1 s

Overtorque/Undertorque Detection Function Selection 2 (n097)

When vector control mode is selected, overtorque/undertorque detection can be performed either by detecting the output current or the output torque.

When V/f control mode is selected, the setting of n097 is invalid, and overtorque/undertorque is detected by the output current.

Setting	Description
0	Detected by output torque
1	Detected by output current

Frequency Detection Level (n095)

Effective when one or more of the Multi-function Output Selections n057, n058 and n059 are set for frequency detection (setting: 4 or 5). Frequency detection turns ON when the output frequency is higher or lower than the setting for the Frequency Detection Level (n095).

Frequency Detection 1

Output frequency \geq Frequency Detection Level n095

(Set n057, n058 or n059 to 4.)

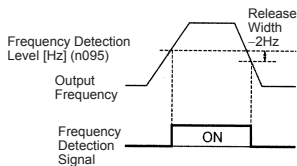

Frequency Detection 2

Output frequency \leq Frequency Detection Level n095

(Set n057, n058 or n059 to 5.)

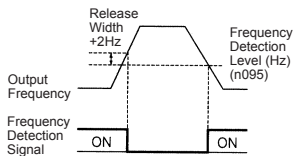

□ Jump Frequencies (n083 to n086)

This function allows the prohibition or “jumping” of critical frequencies so that the motor can operate without resonance caused by the machine system. This function is also used for dead band control. Setting the values to 0.00 Hz disables this function.

Set prohibited frequencies 1, 2, and 3 as follows:

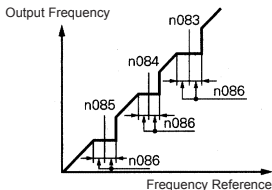

$$n083 \geq n084 \geq n085$$

If this condition is not satisfied, the Inverter will display **Err** for one second and restore the data to initial settings.

Operation is prohibited within the jump frequency ranges.

However, the motor will operate without jumping during acceleration/deceleration.

□ Continuing Operation Using Automatic Retry Attempts (n082)



WARNING When the fault retry function is selected, stand clear of the Inverter or the load. The Inverter may restart suddenly after stopping.
(Construct the system to ensure safety, even if the Inverter should restart.) Failure to observe this warning may result in injury.

The Inverter can be set to restart and reset fault detection after a fault occurs. The number of self-diagnosis and retry attempts can be set to up to 10 in n082. The Inverter will automatically restart after the following faults occur:

OC (overcurrent)

OV (overvoltage)

The number of retry attempts is cleared to 0 in the following cases:

1. If no other fault occurs within 10 minutes after retry
2. When the Fault Reset signal is ON after the fault is detected
3. When the power supply is turned OFF

□ Frequency Offset Selection (n146)

An offset frequency (which can be set with a constant) can be added to or subtracted from the frequency reference using multi-function inputs.

Constant No.	Name	Description	Factory Setting
n083	Jump Frequency 1 (Offset Frequency 1)	1st digit of n146 is 0 or 1: Setting unit: 0.01 Hz Setting range: 0.00 to 400.0 Hz 1st digit of n146 is 2: Setting unit: 0.01% Setting range: 0.00% to 100.0% (Percentage of Maximum Output Frequency)	0.00 Hz
n084	Jump Frequency 2 (Offset Frequency 2)	1st digit of n146 is 0 or 1: Setting unit: 0.01 Hz Setting range: 0.00 to 400.0 Hz 1st digit of n146 is 2: Setting unit: 0.01% Setting range: 0.00% to 100.0% (Percentage of Maximum Output Frequency)	0.00 Hz
n085	Jump Frequency 3 (Offset Frequency 3)	1st digit of n146 is 0 or 1: Setting unit: 0.01 Hz Setting range: 0.00 to 400.0 Hz 1st digit of n146 is 2: Setting unit: 0.01% Setting range: 0.00% to 100.0% (Percentage of Maximum Output Frequency)	0.00 Hz

Constant No.	Name	Description	Factory Setting																																												
n146	Frequency Offset Selection	<p>n146 is separated in 2 digits (n146=xy). The first digit "x" selects the use of parameters n083 to n085: <u>n146= 0y:</u> Disabled (n083 to n085 are jump frequencies) <u>n146= 1y:</u> Enabled (n083 to n085 are offset frequencies in Hz) <u>n146= 2y:</u> Enabled (n083 to n085 are offset frequencies in percent)</p> <p>The 2nd digit "y" selects the sign of the offset frequencies. Refer to the table below for the possible combinations:</p> <table border="1"> <thead> <tr> <th>y</th> <th>n083</th> <th>n084</th> <th>n085</th> </tr> </thead> <tbody> <tr><td>0</td><td>+</td><td>+</td><td>+</td></tr> <tr><td>1</td><td>-</td><td>+</td><td>+</td></tr> <tr><td>2</td><td>+</td><td>-</td><td>+</td></tr> <tr><td>3</td><td>-</td><td>-</td><td>+</td></tr> <tr><td>4</td><td>+</td><td>+</td><td>-</td></tr> <tr><td>5</td><td>-</td><td>+</td><td>-</td></tr> <tr><td>6</td><td>+</td><td>-</td><td>-</td></tr> <tr><td>7</td><td>-</td><td>-</td><td>-</td></tr> <tr><td>8</td><td>-</td><td>-</td><td>-</td></tr> <tr><td>9</td><td>-</td><td>-</td><td>-</td></tr> </tbody> </table> <p>Note: When the 2nd digit of n146 is changed, the set values of n083 to n085 will be initialized to 0.</p>	y	n083	n084	n085	0	+	+	+	1	-	+	+	2	+	-	+	3	-	-	+	4	+	+	-	5	-	+	-	6	+	-	-	7	-	-	-	8	-	-	-	9	-	-	-	0
y	n083	n084	n085																																												
0	+	+	+																																												
1	-	+	+																																												
2	+	-	+																																												
3	-	-	+																																												
4	+	+	-																																												
5	-	+	-																																												
6	+	-	-																																												
7	-	-	-																																												
8	-	-	-																																												
9	-	-	-																																												

- If the 1st digit "x" of Frequency Offset Selection (n146) is 0 (frequency offsets disabled), the set values of constants n083 to n085 will function as jump frequencies.

- If the 1st digit “x” of Frequency Offset Selection (n146) is 1 or 2 (frequency offsets enabled), the set values of constants n083 to n085 will function as frequency offsets.
- In order to activate the offset frequencies 1 to 3 of the Multi-function Input Selections (n050 to n056) must be programmed to 30, 31 or 33. Depending on the input status following combinations of the offset frequencies can be used. Note that the sign specified with “y” is used.

Terminal Input Status			Final Offset Amount
Offset Frequency Input 3	Offset Frequency Input 2	Offset Frequency Input 1	
OFF	OFF	OFF	None
OFF	OFF	ON	n083
OFF	ON	OFF	n084
OFF	ON	ON	n083 + n084
ON	OFF	OFF	n085
ON	OFF	ON	n083 + n085
ON	ON	OFF	n084 + n085
ON	ON	ON	n083 + n084 + n085

- The enabled offset amount can be monitored on the display of U-12 on the Digital Operator.

Monitor No.	Name	Description
U-12	Offset amount	1st digit “x” of n146 = 0: “----” displayed 1st digit “x” of n146 = 1: Display range: -400 to 400.0 Hz 1st digit “x” of n146 = 2: Display range: -100% to 100.0%

The following block diagram illustrates the Frequency Offset Function.

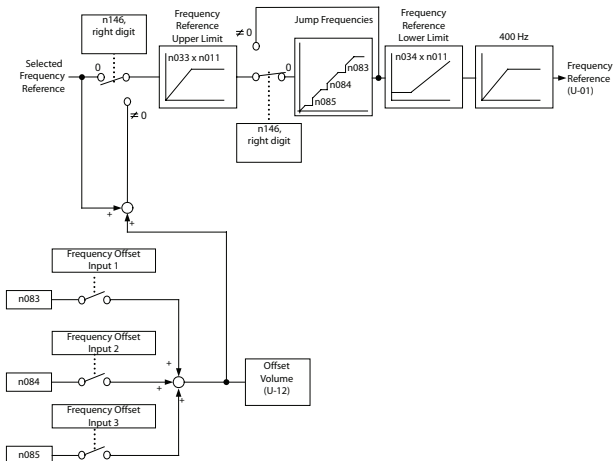

□ Operating a Coasting Motor without Tripping

To operate a coasting motor without tripping, use the Speed Search Command or DC Injection Braking at Startup.

Speed Search Command

Restarts a coasting motor without stopping it. This function enables smooth switching between motor commercial power supply operation and Inverter operation.

Set a Multi-function Input Selection (n050 to n056) to 14 (Search Command from maximum output frequency) or 15 (Search Command from set frequency).

Build a sequence so that a FWD (REV) Run Command is input at the same time as the Search Command or after the Search Command. If the Run Command is input before the Search Command, the Search Command will be disabled.

Time Chart at Search Command Input

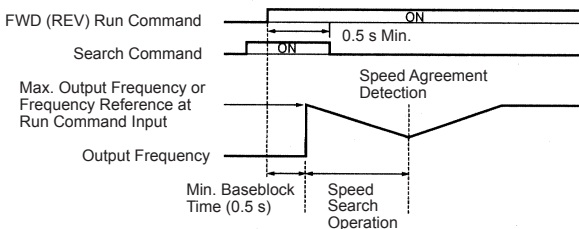

The deceleration time for speed search operation can be set in n101.

If the setting is 0, however, an initial value of 2.0 s will be used.

The speed search starts when the Inverter's output current is greater than or equal to the speed search operation level (n102).

DC Injection Braking at Startup (n089, n091)

Restarts a coasting motor after stopping it. Set the DC injection braking time at startup in n091 in units of 0.1 s. Set the DC Injection Braking Current in n089 in units of 1% (Inverter rated current =100%). When the setting of n091 is 0, DC injection braking is not performed and acceleration starts from the minimum output frequency.

When n089 is set to 0, acceleration starts from the minimum output frequency after baseblocking for the time set in n091.

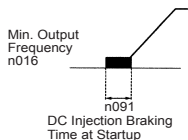

□ Holding Acceleration/Deceleration Temporarily

To hold acceleration or deceleration, input an Acceleration/Deceleration Hold Command. The output frequency is maintained when an Acceleration/Deceleration Hold Command is input during acceleration or deceleration.

When the Stop Command is input while an Acceleration/Deceleration Hold Command is being input, the acceleration/deceleration hold is released and operation coasts to a stop.

Set a Multi-function Input Selection (n050 to n056) to 16 (acceleration/deceleration hold).

Time Chart for Acceleration/Deceleration Hold Command Input

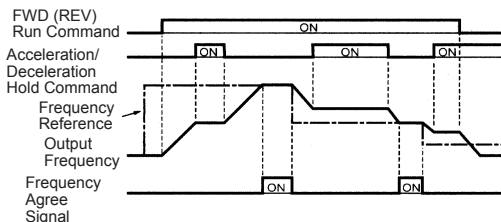

Note: If a FWD (REV) Run Command is input at the same time as an Acceleration/Deceleration Hold Command, the motor will not operate. However, if the Frequency Reference Lower Limit (n034) is set to a value greater than or equal to the Min. Output Frequency (n016), the motor will operate at the Frequency Reference Lower Limit (n034).

External Analog Monitoring(n066)

Selects to output either output frequency or output current to analog output terminals AM-AC for monitoring.

Setting	Description
0	Output frequency
1	Output current
2	Main circuit DC voltage
3	Torque monitor
4	Output power
5	Output voltage reference
6	Frequency reference monitor
7	PID Feedback Amount (10 V/Maximum Output Frequency in n011)
8	Data Output via Communications (MEMOBUS register No.0007H) (10 V/1000)

Note: Enabled only when n065 is set to 0 (analog monitor output).

In factory setting, analog voltage of approx. 10 V is output when output frequency (output current) is 100 %.

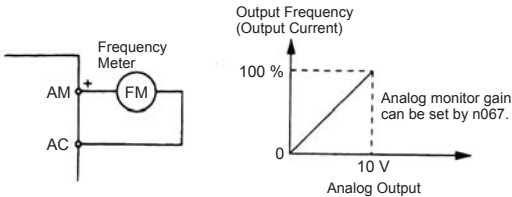

□ Calibrating Frequency Meter or Ammeter (n067)

Used to adjust analog output gain.

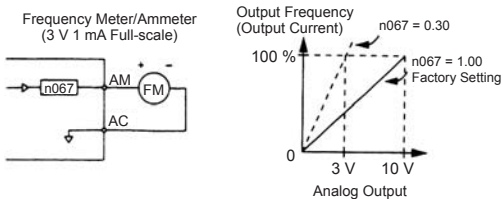

Set the analog output voltage at 100 % of output frequency (output current). Frequency meter displays 0 to 60 Hz at 0 to 3 V.

$$10 \text{ V} \times \frac{\text{n067 setting}}{1.00} = 3 \text{ V} \quad \text{Output frequency becomes 100 \% at this value.}$$

□ Using Analog Output (AM-AC) as a Pulse Train Signal Output (n065)

Analog output AM-AC can be used as a pulse train output (output frequency monitor, frequency reference monitor).

Set n065 to 1 when using pulse train output.

Constant No.	Name	Unit	Setting range	Factory setting
n065	Monitor Output Type	-	0, 1	0

n065 Setting

n065 Setting	Description
0	Analog monitor output
1	Pulse monitor output (Output frequency monitor)

Pulse train signal can be selected by setting in n150.

n150 Setting	Description	
0	Output frequency monitor	1440 Hz/Max. frequency (n011)
1		1F: Output frequency \times 1
6		6F: Output frequency \times 6
12		12F: Output frequency \times 12
24		24F: Output frequency \times 24
36		36F: Output frequency \times 36
40		Frequency reference monitor
41	1F: Output frequency \times 1	
42	6F: Output frequency \times 6	
43	12F: Output frequency \times 12	
44	24F: Output frequency \times 24	
45	36F: Output frequency \times 36	
50	Data Output via Communi- cations	0 to 14,400 Hz output (MEMO- BUS register No.000AH) (1 Hz/ 1)

Note: Enabled only when n065 is set to 1 (pulse monitor output).

At the factory setting, the pulse of 1440 Hz can be output when output frequency is 100 %.

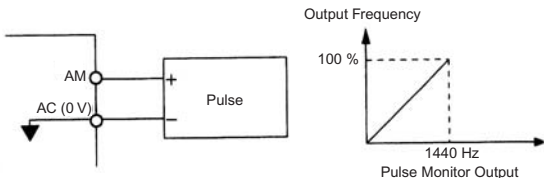

NOTE

Peripheral devices must be connected according to the following load conditions when using pulse monitor output. The machine might be damaged when the conditions are not satisfied.

Used as a Sourcing Output

Output Voltage VRL (V)	Load Impedance (k Ω)
+5 V	1.5 k Ω or more
+8 V	3.5 k Ω or more
+10 V	10 k Ω or more

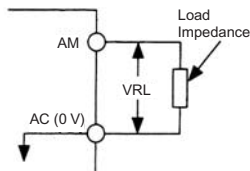

Used as a Sinking Input

External Power Supply (V)	+12 VDC \pm 5 % or less
Sinking Current (mA)	16 mA or less

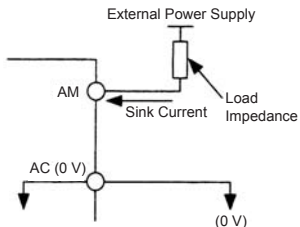

□ Carrier Frequency Selection (n080)14kHz max

Set the Inverter output transistor switching frequency (carrier frequency).

Setting	Carrier Frequency (kHz)	Metallic Noise from Motor	Noise and Current Leakage
7	12 fout (Hz)	Higher ↑ ↓ Not audible	Smaller ↑ ↓ Larger
8	24 fout (Hz)		
9	36 fout (Hz)		
1	2.5 (kHz)		
2	5.0 (kHz)		
3	7.5 (kHz)		
4	10.0 (kHz)		
12	14 (kHz)		

Note: When the carrier frequency has been set to 14 kHz, use a MEMOBUS baud rate of 4,800 bps or lower.

If the set value is 7, 8, or 9, the carrier frequency will be multiplied by the same factor as the output frequency.

n080=7

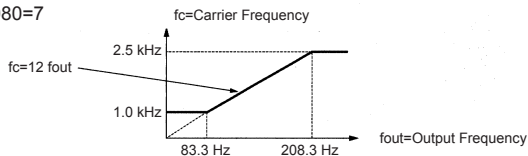

n080=8

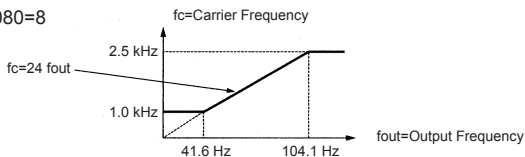

n080=9

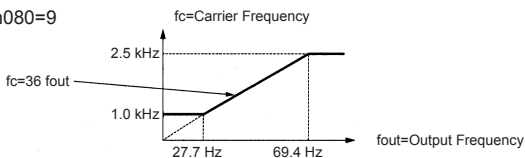

The factory setting depends on the Inverter capacity (kVA).

Voltage Class (V)	Capacity (kW)	Factory Setting		Maximum Continuous Output Current (A)	Reduced Current (A)	Continuous Output Current (Reduction Output Current) (A)
		Setting	Carrier Frequency (kHz)			FC = 14 kHz
200 V Single-phase or 3-phase	0.1	4	10	0.8	-	0.7 (88%)
	0.25	4	10	1.6		1.4 (88%)
	0.55	4	10	3.0		2.6 (87%)
	1.1	4	10	5.0		4.3 (86%)
	1.5	3	7.5	8.0	7.0	6.0 (75%)
	2.2	3	7.5	11.0	10.0	8.6 (78%)
	4.0	3	7.5	17.5	16.5	14.0 (80%)
	5.5	3	7.5	25	23	18.0 (72%)
	7.5	3	7.5	33	30	22.1 (67%)
400 V 3-phase	0.37	3	7.5	1.2	1.0	0.8 (67%)
	0.55	3	7.5	1.8	1.6	1.28 (71%)
	1.1	3	7.5	3.4	3.0	2.2 (65%)
	1.5	3	7.5	4.8	4.0	3.2 (67%)
	2.2	3	7.5	5.5	4.8	3.84 (70%)
	3.0	3	7.5	7.2	6.3	4.9 (68%)
	4.0	3	7.5	9.2	8.1	6.4 (74%)
	5.5	3	7.5	14.8	*	12.0 (81%)
	7.5	3	7.5	18	17	13.0 (72%)

* Reduction of the current is not necessary.

NOTE

1. Reduce the continuous output current when changing the carrier frequency to 4 (10 kHz) for 200 V Class (1.5 kW or more) and 400 V Class Inverters. Refer to the table above for the reduced current.

Operation Condition

- Input power supply voltage:
 - 3-phase 200 to 230 V (200 V Class)
 - Single-phase 200 to 240 V (200 V Class)
 - 3-phase 380 to 460 V (400 V Class)
- Ambient temperature:
 - 10 to 50°C (14 to 122°F)
(Protection structure: open chassis type IP20, IP00)
 - 10 to 40°C (14 to 105°F)
(Protection structure: enclosed wall-mounted type NEMA 1 (TYPE 1))

2. If the wiring distance is long, reduce the Inverter carrier frequency as described below.

Wiring Distance between Inverter and Motor	Up to 50 m	Up to 100 m	More than 100 m
Carrier Frequency (n080 setting)	10 kHz or less (n080=1, 2, 3, 4, 7, 8, 9)	5 kHz or less (n080=1, 2, 7, 8, 9)	2.5 kHz or less (n080=1, 7, 8, 9)

3. Set the Carrier Frequency Selection (n080) to 1, 2, 3, or 4 when using vector control mode. Do not set it to 7, 8, or 9.
4. If the Inverter repeatedly stops and starts with a load exceeding 120% of the Inverter rated current within a cycle time of 10 minutes or less, reduce carrier frequency at a low speed. (Set constant n175 to 1.)
5. The carrier frequency is automatically reduced to 2.5 kHz when the Reducing Carrier Frequency Selection at Low Speed (n175) is set to 1 and the following conditions are satisfied:
 - Output frequency ≤ 5 Hz
 - Output current $\geq 110\%$
 - Factory setting: 0 (Disabled)

6. When a carrier frequency of 14 kHz (n080) is selected, automatic carrier frequency reduction during low-speed overcurrent is automatically enabled, even if the Reducing Carrier Frequency Selection at Low Speed (n175) is set to 0 (disabled).
7. When the carrier frequency is set to 14 kHz, the following functions will be disabled:
 - Fast digital input (START/STOP)
 - UP 2/DOWN 2
 - Motor overheat protection using PTC thermistor input
 - Bi-directional PID output
 - Frequency offsets



□ Operator Stop Key Selection (n007)

⚠ WARNING The Digital Operator stop button can be disabled by a setting in the Inverter. Install a separate emergency stop switch.
Failure to observe this warning may result in injury.

Set the processing when the STOP key is pressed during operation either from a multi-function input terminal or communications.

Setting	Description
0	The STOP key is effective either from a multi-function input terminal or communications. When the STOP key is pressed, the Inverter stops according to the setting of constant n005. At this time, the Digital Operator displays a SFP alarm (flashing). This Stop Command is held in the Inverter until both Forward and Reverse Run Commands are open, or until the Run Command from communications goes to zero.
1	The STOP key is ineffective either from multi-function input terminals or communications.

□ Second motor selection

This function switches between two motors for one Inverter. V/f control must be used for the second motor. Switching is possible from a multi-function input.

The following constants are used as control constants for motor 2.

Constant No.	Name	Unit	Setting Range	Factory Setting
–	Control Mode Selection	–	V/f control must be used.	–
n140	Motor 2 Maximum Output Frequency	0.1 Hz	50.0 to 400.0 Hz	50.0 Hz
n158	Motor 2 Maximum Voltage	0.1 V	0.1 to 255.0 V ^{*1}	200.0 V ^{*1}
n147	Motor 2 Maximum Voltage Output Frequency	0.1 Hz	0.2 to 400.0 Hz	50.0 Hz
n159	Motor 2 Middle Output Frequency Voltage	0.1 V	0.1 to 255.0 V ^{*1}	12.0 V ^{*1*2}
n014	Middle Output Frequency	0.1 Hz	0.1 to 399.9 Hz	1.3 Hz
n160	Motor 2 Minimum Output Frequency Voltage	0.1 V	0.1 to 50.0 V ^{*1}	12.0 V ^{*1*2}
n161	Motor 2 Rated Current	0.1 A	0.0 to 150% of Inverter rated current	*2
n162	Motor 2 Rated Slip	0.1 Hz	0.0 to 20.0 Hz	*2

Note: Not initialized when constants are initialized.

* 1. Upper limit of setting range and factory setting are doubled for 400-V Class Inverters.

* 2. Depends on Inverter capacity.

Constant No.	Name	Description	Factory Setting
n057	Multi-function Output Selection 1 (Contact output terminals MA-MB-MC)	0: Fault 1: Operating 2: Frequency agree 3: Zero speed 4: Frequency detection (\geq Detection level) 5: Frequency detection (\leq Detection level) 6: Overtorque detection (NO contact output) 7: Overtorque detection (NC contact output) 8: Undertorque detection (NO contact output) 9: Undertorque detection (NC contact output) 10: Minor fault (Alarm is indicated) 11: Base blocked 12: Operating mode 13: Inverter operation ready 14: Fault retry 15: UV 16: Reverse run 17: Speed search 18: Data output from communications 19: PID feedback loss 20: Frequency reference loss 21: Inverter overheat alert (OH3) 22: Motor selection monitor	0
n058	Multi-function Output Selection 2 (Open-collector output terminals PHC1-PHCC)	Same as constant 57	1
n059	Multi-function Output Selection 3 (Open-collector output terminals PHC2-PHCC)	Same as constant 57	2

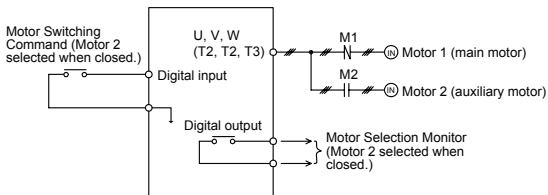

Note: Switching of motor 1 and motor 2 as well as checking motor status should be performed using an external sequence.

- By setting one of the constants from n050 to n056 (Multi-function Input Selections) to 28 (Motor Switching Command) and by opening and closing the input signal when stopped (i.e. while Inverter output is OFF when the Run Command is OFF), the control mode, V/f characteristics, and motor constants stored in the Inverter can be selected.
- By setting one of the constants from n057 to n059 (Multi-function Output Selections) to 22 (Motor Selection Monitor), the present motor selection status can be monitored on a digital output terminal.
- The following shaded constants are switched for the Motor Switching Command.

Motor Constant Table (New Parameters are shown in bold letters)

	Motor Switching Command	
	Open (Motor 1 Selected)	Closed (Motor 2 Selected)
Control Mode Selection	n002	V/f control must be used.
V/f Characteristics	n011: Maximum Output Frequency n012: Maximum Voltage n013: Maximum Voltage Output Frequency n014: Middle Output Frequency n015: Middle Output Frequency Voltage n016: Minimum Output Frequency n017: Minimum Output Frequency Voltage	n140: Motor 2 Maximum Output Frequency (2) n158: Motor 2 Maximum Voltage n147: Motor 2 Maximum Voltage Output Frequency (2) n014: Middle Output Frequency (Same as motor 1) n159: Motor 2 Middle Output Frequency Voltage n016: Minimum Output Frequency (Same as motor 1) n160: Motor 2 Minimum Output Frequency Voltage
Motor Constants	n036: Motor Rated Current n037: Electronic Thermal Motor Protection Selection n038: Electronic Thermal Motor Protection Time Constant Setting n093: Stall Prevention Level during Acceleration n094: Stall Prevention Level during Running n104: Torque Compensation Time Constant n105: Torque Compensation Iron Loss n106: Motor Rated Slip n107: Motor Line-to-Neutral Resistance n108: Motor Leakage Inductance n110: Motor No-load Current n111: Slip Compensation Gain n112: Slip Compensation Time Constant	n161: Motor 2 Rated Current n037: Electronic Thermal Motor Protection Selection (Same as motor 1) n038: Electronic Thermal Motor Protection Time Constant Setting (Same as motor 1) n093: Stall Prevention Level during Acceleration (Same as motor 1) n094: Stall Prevention Level during Running (Same as motor 1) n104: Torque Compensation Time Constant (Same as motor 1) n105: Torque Compensation Iron Loss (Same as motor 1) n162: Motor 2 Rated Slip n107: Motor Line-to-Neutral Resistance (Same as motor 1) n110: Motor No-load Current (Same as motor 1) n111: Slip Compensation Gain (Same as motor 1) n112: Slip Compensation Time Constant (Same as motor 1)

	Motor Switching Command	
	Open (Motor 1 Selected)	Closed (Motor 2 Selected)
Motor Selection Monitor	Open	Closed

Application Precautions

- **Motor Switching Command and Motor Selection Monitor**

When using the Motor Switching Command, be sure to switch the motor when it is at a complete stop (i.e., while Inverter output is OFF when the Run Command is OFF). Check the status of the Motor Selection Monitor and contactors M1 and M2 with an external sequence or sequencer, and start Inverter operation only after confirming that the motor has been switched. The motor switching process for the Inverter takes 50 ms max.

If an attempt is made to switch the motor during operation or when the motor is decelerating to a stop, the switching process will not be performed, a SEr (sequence error) alarm will be displayed, a multi-function output alarm will be output to the Digital Operator, and operation will continue. No error will be output. When the motor comes to a complete stop (i.e., when the Inverter output is OFF), the switching process will be performed.

- **Electronic Thermal Motor Protection (OL1)**

Electronic thermal motor protection is performed based on n036 (Motor Rated Current) when motor 1 is selected and based on n161 (Motor 2 Rated Current) when motor 2 is selected. When a Motor Switching Command is allocated for a multi-function input terminal, OL1 calculations for motor 1 and motor 2 are always performed regardless of the status of the Motor Switching Command input terminal.

Output current detection data for OL1 calculations is provided separately for motor 1 and motor 2. (If motor 1 is selected, output current detection data is calculated for motor 1 with the actual output current, and output current detection data is calculated for motor 2 with an output current of 0.0 A. If motor 2 is selected, output current detection data will be calculated for motor 2 with the actual output current, and output current detection data will be calculated for motor 1 with an output current of 0.0 A. If motor 2 is selected, output current detection data will be calculated for motor 2 with the actual output current, and output current detection data will be calculated for motor 1 with an output current of 0.0 A.)

If constant n037 is set to 3 (standard motor, motor 1 only) or 4 (special motor, motor 1 only), however, OL1 calculations for motor 1 will always be performed, regardless of the status of the Motor Switching Command. (Regardless of whether motor 1 or motor 2 is selected, output current detection data for motor 1 is calculated with the actual output current, and output current detection data for motor 2 is calculated with an output current of 0.0 A.)

Constant No.	Name	Description	Factory Setting
n037	Electronic Thermal Motor Protection Selection	0: Electronic thermal characteristics for standard motor 1: Electronic thermal characteristics for special motor 2: No electronic thermal motor protection 3: Electronic thermal characteristics for standard motor (motor 1 only) 4: Electronic thermal motor characteristics for special motor (motor 1 only)	0

- Maximum Frequency, Frequency Reference, Acceleration Time, and Deceleration Time

When motor 1 is selected, operation is performed using n011 (Maximum Output Frequency) as the maximum frequency. Therefore, when the set value of the Maximum Output Frequency (n011) and the set value of the Motor 2 Maximum Output Frequency (n140) are different, operation is as follows:

1. Even when using an analog frequency reference with the same reference voltage (current), the frequency reference will differ by the ratio between n011 and n140.

Example: If n011 = 60 Hz and n140 = 50 Hz, when the reference voltage is 5 V (50%), motor 1 would rotate at 30 Hz and motor 2 would rotate at 25 Hz.

- For a multi-step speed reference, the setting unit is Hz (absolute value), and so the motor rotates at the commanded value regardless of the motor selection status.

If a multi-step speed reference exceeding the selected maximum output frequency multiplied by the Frequency Reference Upper Limit (n033) is mistakenly input, upper limit operation will be performed at the selected maximum output frequency multiplied by the Frequency Reference Upper Limit (n033).

Example: If n011 = 60 Hz, n140 = 50 Hz, and n033 = 100%, operation will be at 50 Hz when a multi-step speed reference of 60 Hz is mistakenly input when motor 2 is selected.

- Multi-step Speed Reference (n024 to n032) Upper Limit (Setting Range Upper Limit)

The upper limit is Maximum Output Frequency (n011) for motor 1 or the Motor 2 Maximum Output Frequency (n140), whichever is greater, multiplied by the Frequency Reference Upper Limit (n033).

- The setting values of the Acceleration and Deceleration Times (n019 to n022) are the times required to reach the selected maximum output frequency.

Example: If n011 = 60 Hz, n140 = 50 Hz, and acceleration (deceleration) time = 10 s, motor 1 will accelerate (decelerate) for 5 s and motor 2 will accelerate (decelerate) for 6 s to reach 30 Hz starting at 0 Hz (or to reach 0 Hz starting at 30 Hz).

Motor 2 Switching Time Chart

Example of Switching Operation from Motor 1 to Motor 2

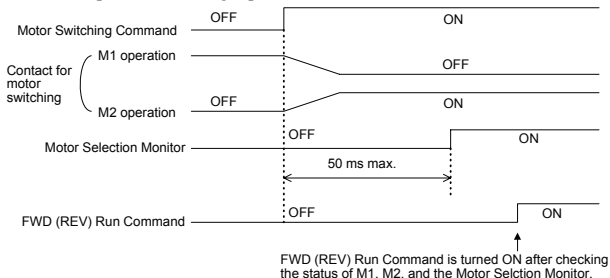

If the FWD/REV Run Command is turned ON after turning the Motor Switching Command ON (or OFF) but before the Motor Selection Monitor turns ON (or OFF), Inverter output will begin immediately after the Motor Selection Monitor turns ON (or OFF).

■ Selecting the Stopping Method

□ Stopping Method Selection (n005)

Select the stopping method suitable for the application.

Setting	Description
0	Deceleration to a stop
1	Coast to a stop

Deceleration to a Stop

Example when Acceleration/Deceleration Time 1 is selected

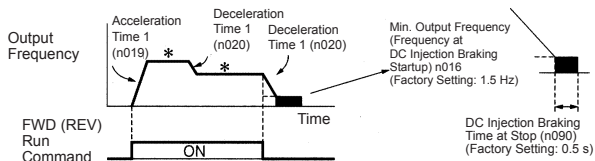

* Changing the frequency reference while running

Upon termination of a FWD (REV) Run Command, the motor decelerates at the deceleration rate determined by the time set in Deceleration Time 1 (n020) and DC injection braking is applied immediately before stopping. DC injection braking is also applied when the motor decelerates because the frequency reference is set lower than the Min. Output Frequency (n016) when the FWD (REV) Run Command is ON. If the deceleration time is short or the load inertia is large, an overvoltage (OV) fault may occur at deceleration. In this case, increase the deceleration time or install an optional Braking Resistor.

Braking torque: Without braking resistor: Approx. 20% of motor rating

With braking resistor: Approx. 150% of motor rating

Coast to a Stop

Example when Acceleration/Deceleration Time 1 is selected

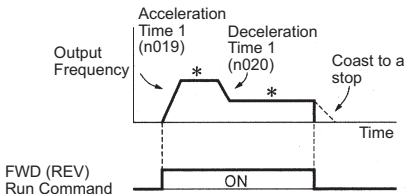

- * Changing the frequency reference while running

Upon termination of the FWD (REV) Run Command, the motor starts coasting.

□ Applying DC Injection Braking

DC Injection Braking Current (n089)

Sets the DC injection braking current in units of 1%. (Inverter rated current=100%)

DC Injection Braking Time at Stop (n090)

Sets the DC injection braking time at stopping in units of 0.1 s. When the setting of n090 is 0, DC injection braking is not performed, but the Inverter output is turned OFF when DC injection braking is started.

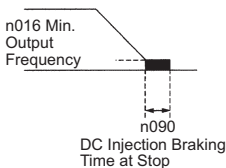

When coasting to a stop is specified in the Stopping Method Selection (n005), DC injection braking is not applied when stopping.

□ Simple Positioning Control when Stopping

- If a sequence input terminal is used for a RUN/STOP sequence, simple positioning control when stopping can be used to reduce deviation in the position where the motor stops after the Run Command is started from the sequence input terminal.

- Controlling the Stop Position Regardless of Output Frequency
Control is performed so that S, the travel distance from maximum output frequency until decelerating to a stop, and S1, the travel distance from any frequency (less than maximum output frequency) until decelerating to a stop, are the same. (Control is performed to stop at the same position when the Run Command is input from a sequence input terminal regardless of the output frequency.)

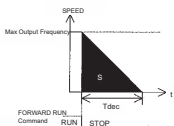

Fig. 1

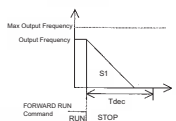

Fig. 2

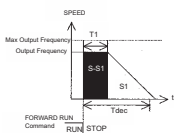

Fig. 3



Simple positioning control is not performed if the value of the Maximum Output Frequency (n011) multiplied by the Deceleration Time (n020, n022, n042, or n044) is more than 8,589. For example, simple positioning control is not performed if the Deceleration Time is set to 143 s or higher at 60 Hz.

Constant No.	Name	Description	Factory Setting
n143	Sequence Input Redundant Reading Selection (Stop Position Control Selection)	0: 8-ms redundant reading (Stop position control disabled.) 1: 2-ms redundant reading with only stop position deviation reduction 2: 2-ms redundant reading with simple positioning control	0
n144	Stop Position Control Compensation Gain	Setting unit: 0.01 Setting range: 0.50 to 2.55	1.00

Constants Requiring Restrictions

Constant No.	Name	Description	Factory Setting
n023	S-curve Selection	0: No S-curve Characteristic 1: 0.2-s S-curve Characteristic 2: 0.5-s S-curve Characteristic 3: 1.0-s S-curve Characteristic Note: S-curve characteristics are not supported for simple positioning control, so use a set value of 0.	0
n092	Stall Prevention during Deceleration	0: Stall prevention 1: No stall prevention (when a braking resistor is installed) Note: If Stall Prevention during Deceleration is used with simple positioning control, positioning will not be performed properly, so use a set value of 1.	0

■ Building Interface Circuits with External Devices

□ Using Input Signals

The functions of multi-function input terminals S1 to S7 can be changed as necessary by setting constants n050 to n056. The same value cannot be set for more than one of these constants.

Setting	Name	Description	Ref. page
0	FWD/REV Run Command (3-wire sequence selection)* ¹	Setting enabled only for n052 (terminal S3)	112
1	Forward Run Command (2-wire sequence selection)* ¹		64
2	Reverse Run Command (2-wire sequence selection)* ¹		64
3	External fault (NO contact input)	Inverter stops for an external fault signal input. Digital Operator displays Efo.* ²	-
4	External fault (NC contact input)		-
5	Fault Reset	Resets a fault. Fault Reset not effective when the RUN signal is ON.	66
6	Multi-step speed reference 1		66
7	Multi-step speed reference 2		66
8	Multi-step speed reference 3		66
9	Multi-step speed reference 4		66
10	Jog Command		75
11	Acceleration/deceleration time selection 1		77
12	External Baseblock, NO contact input	Motor coasts to a stop for this signal input. Digital Operator displays bb .	-
13	External Baseblock, NC contact input		-

Setting	Name	Description	Ref. page
14	Search Command from maximum frequency	Speed Search Command signal	88
15	Search Command from set frequency		88
16	Acceleration/Deceleration Hold Command		89
17	LOCAL/REMOTE selection		63
18	Communications/control circuit terminal selection		115
19	Emergency stop fault, NO contact input	Inverter stops for an emergency stop signal input according to the Stopping Method Selection (n005). When coast to stop (n005 = 1) is selected, the Inverter coasts to stop. Digital Operator displays SFP (flashing).	-
20	Emergency stop alarm, NO contact input		-
21	Emergency stop fault, NC contact input		-
22	Emergency stop alarm, NC contact input		-
23	PID control cancel		167
24	PID integral reset		167
25	PID integral hold		167
26	Inverter overheat alert (OH3 alarm)	When the Inverter overheat signal turns ON, OH3 (flashing) is displayed at the Digital Operator.	-
27	Acceleration/deceleration time selection 2		77
28	Motor Switching Command (Motor Selection)		99
29	Bi-directional PID prohibit (ON: Prohibited)		163
30	Frequency offset input 1		85
31	Frequency offset input 2		85
32	Frequency offset input 3		85

Setting	Name	Description	Ref. page
33	no function		-
34	UP/DOWN commands	setting enabled only for n056	114
35 to 36	Do not set.		-
37	FWD/REV Run 2 Command (2-wire sequence 2)		129

- For more information on how to select the sequence polarity, refer to page 226.
- Numbers 1 to 7 are displayed for □ to indicate the terminal numbers S1 to S7.

Factory Settings

No.	Terminal	Factory Setting	Function
n050	S1	1	Forward Run Command (2-wire sequence)
n051	S2	2	Reverse Run Command (2-wire sequence)
n052	S3	3	External fault (NO contact input)
n053	S4	5	Fault Reset
n054	S5	6	Multi-step speed reference 1
n055	S6	7	Multi-step speed reference 2
n056	S7	10	Jog Command

Terminal Functions for 3-wire Sequence Selection

When 0 is set for terminal S3 (n052), terminal S1 is the Run Command, terminal S2 is the Stop Command, and terminal S3 is the FWD/REV Run Command.

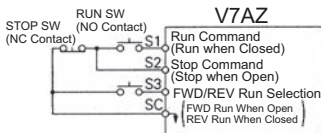



WARNING To select the 3-wire sequence, set terminal S3 (n052) to 0.
Failure to observe this warning may result in injury.

LOCAL/REMOTE Selection (Setting: 17)

Select the operation reference from either the Digital Operator or from the settings of the Run Command Selection (n003) and Frequency Reference Selection (n004). The LOCAL/REMOTE Selection can be used only when stopped.

Open: Run according to the setting of Run Command Selection (n003) or Frequency Reference Selection (n004).

Closed: Run according to the frequency reference and Run Command from the Digital Operator.

Example: Set n003=1, n004=2, n008=0.

Open: Run according to the frequency reference from multi-function input terminal FR and Run Command from multi-function input terminals S1 to S7.

Closed: Run according to the potentiometer frequency reference and Run Command from the Digital Operator.

Up/Down Commands (Setting: n056 = 34)

When the FWD (REV) Run Command is ON, acceleration/deceleration is enabled by inputting the UP or DOWN signal from multi-function input terminals S6 and S7 without changing the frequency reference. Operation can thus be performed at the desired speed. When Up/Down Commands are specified in n056, any function set in n055 is disabled, terminal S6 is the input terminal for the Up Command, and terminal S7 is the input terminal for the Down Command.

Multi-function Input Terminal S6 (Up Command)	Closed	Open	Open	Closed
Multi-function Input Terminal S7 (Down Command)	Open	Closed	Open	Closed
Operation Status	Acceleration	Deceleration	Hold	Hold

Time Chart for Up/Down Command Input

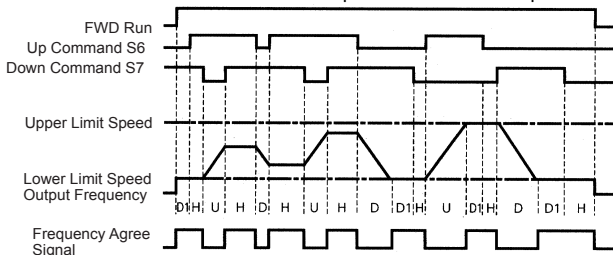

- U = Up (accelerating) status
- D = Down (decelerating) status
- H = Hold (constant speed) status
- U1 = Up status, clamping at upper limit speed
- D1 = Down status, clamping at lower limit speed

- Note: 1. When Up/Down Commands are selected, the upper limit speed is set regardless of frequency reference.
 Upper limit speed = Maximum Output Frequency (n011) × Frequency Reference Upper Limit (n033)/100
2. Lower limit value is either the Minimum Output Frequency (n016) or the Frequency Reference Lower Limit (n034) (whichever is larger.).
 3. When the FWD (REV) Run Command is input, operation starts at the lower limit speed without using the Up/Down Commands.
 4. If the Jog Command is input while running for an Up/Down Command, the Jog Command has priority.
 5. Multi-step speed references 1 to 4 are not effective when an Up/Down Command is selected.
 6. When 1 is set for the HOLD Output Frequency Memory Selection (n100), the output frequency can be recorded during HOLD.

Setting	Description
0	Output frequency is not recorded during HOLD.
1	When HOLD status is continued for 5 seconds or longer, the output frequency during HOLD is recorded and the Inverter restarts at the recorded frequency.

Communications/Control Circuit Terminal Selection (Setting: 18)

Operation can be changed from communications commands, or from control circuit terminal or Digital Operator commands.

Run Commands from communications and the frequency reference are effective when the multi-function input terminal for this setting is closed (register No. 0001H, 0002H).

Run Commands in LOCAL/REMOTE mode and the frequency reference are effective when the terminal is open.

Up/Down Command 2 (Setting: n056 = 36)

This function works like standard Up/Down commands but with additional functionality:

No.	Name	Description	Setting Range	Factory Setting
n056	Multi-function Input Selection S7	When n056=36 is selected, the Up/Down 2 function is allocated to S6(Up) and S7(Down). Setting of n055 has no effect.	1 to 37	10
n045	Frequency reference bias step amount (Up/Down2)	0: Bias value increase/decrease by ramp time (n019/020 or n043/044) dependent on n046. >0: When Up/Down 2 (S6/S7) is switched, bias value is increased/decreased by the value of n045.	0.00 to 99.99 Hz	0Hz
n046	Frequency Reference Bias Accel/Decel Rate during Up/Down 2	Selection of Accel/Decel time rate. 0: Accel/Decel time 1 (n019/n020) 1: Accel/Decel time 4 (n043/n044)	0, 1	0
n047	Operation after removing Up/Down command 2	only effective for n045 and n100=0 0: Bias value will be held 1: Bias value will be reset to previous frequency reference	0, 1	0

No.	Name	Description	Setting Range	Factory Setting
n048	Frequency Reference Bias value of Up/Down command 2	100% =max. frequency (n011) Bias value is stored in n048 when Up/Down 2 command is completed. n048 is limited by setting of n171 and n172. The setting of n048 has no effect under following conditions: <ul style="list-style-type: none"> • Up/Down 2 function is not selected (n056 <> 36) • Frequency reference method is changed (n004 setting) • n100 is changed from 0 to 1 • n100=0 and Run signal is OFF • When n045= 0 and n047= 1 and S6/S7 are both set ON or OFF • Max. frequency (n011) is changed 	-99.9 to 100.0%	0.0%
n049	Analogue Frequency Reference Fluctuation Limit, Up/Down command 2	If analogue reference (or pulse train) value change is bigger than value of n049, bias value is cleared.	0.1 to 100.0%	1.0%
n171	Frequenc Reference Bias upper limit, Up/Down command 2	The Up/Down 2 bias value is limited by n171 (upper limit) Limit is fixed to: $Fref + (Fmax \times n171) / 100$	0.0 to 100%	0.0%
n172	Frequenc Reference Bias lower limit, Up/Down command 2	The Up/Down 2 bias value is limited by n172 (lower limit) Limit is fixed to: $Fref - (Fmax \times n172) / 100$	-99.9 to 0.0%	0.0%
n100	Hold output frequency saving selection	Selects if bias value is saved to EEPROM after RUN signal is removed (frequency must be hold for more than 5s). 0 : not saved to EEPROM. 1 : saved to EEPROM	0, 1	0
U-19	Frequency Reference Bias monitor	Displays the frequency offset caused by Up/Down command 2	-99.99 to 100%	-

If $n045 > 0$ the frequency reference is changed in steps of $n045$ value

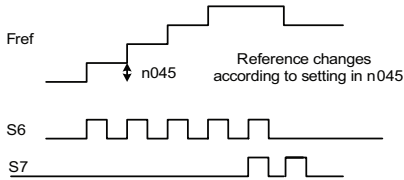

For $n045=0$, acceleration / deceleration rate is selected by $n046$:

$n046 = 0$: Accel/Decel time 1 time ($n019 / n020$)

$n046 = 1$: Accel/Decel time 4 ($n043 / n044$)

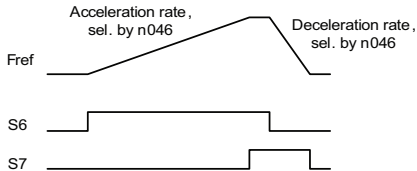

Saving of the Up/Down 2 bias to the EEPROM if save mode $n100=1$ is selected (Frequency reference has to remain for 5 sec)

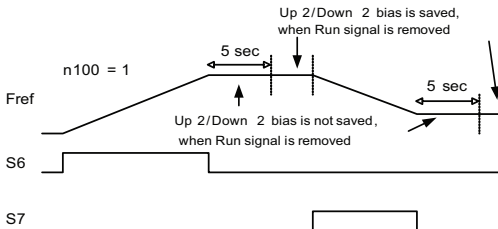

Up/Down Command 2, Examples

Up/Down Command 2 by time

- n056 = 36 Up/Down command 2 on S6 / S7
- n003 = 1 Run command source is digital input
- n004 = 1 Main frequency reference input is n024
- n045 = 0** Frequency reference bias is changed by time
- n046 = 1 Use Acceleration / Deceleration time 4
- n047 = 0 Bias value is held if S6, S7 are both ON or OFF
- n100 = 1 Bias value is saved to EEPROM

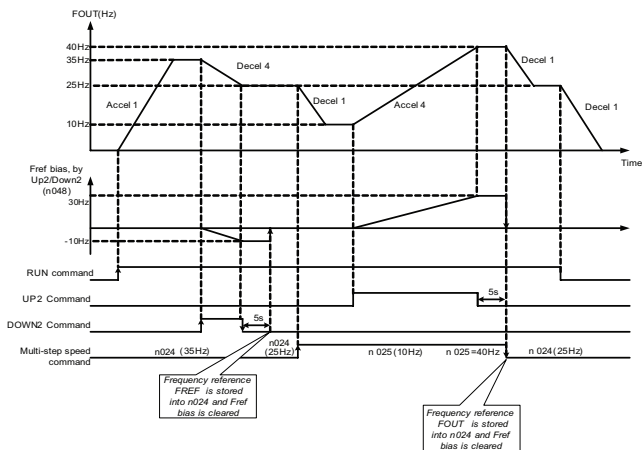

Up/Down Command 2 by step

n056 = 36	Up/Down command 2 on S6 / S7
n003 = 1	Run command source is digital input
n004 = 1	Main frequency reference input is n024
n045 = 5.00Hz	Frequency reference bias is changed by step
n046 = 1	Use Acceleration / Deceleration time 4
n047	not active
n100 = 1	Bias value is saved to EEPROM

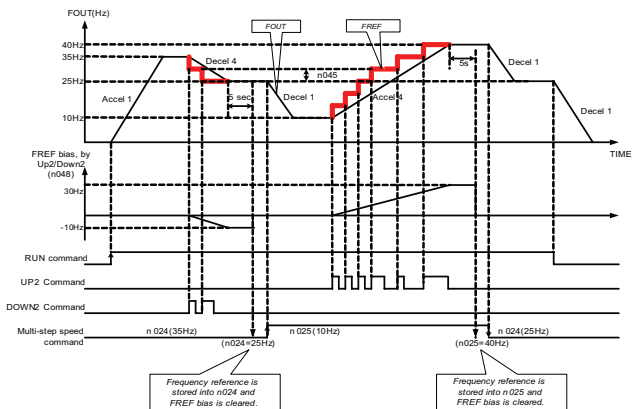

Up/Down Command 2 by time and return to original frequency reference when S6, S7 = OFF

- n056 = 36 Up/Down command 2 on S6 / S7
- n003 = 1 Run command source is digital input
- n004 = 1 Main frequency reference input is n024
- n045 = 0 Frequency reference bias is changed by time
- n046 = 1 Use Acceleration / Deceleration time 4
- n047 = 1 Bias value is held if S6, S7 are both ON or OFF
- n100 = 1 Bias value is saved to EEPROM

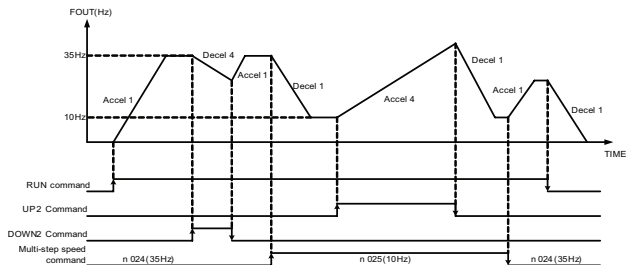

□ Using the Multi-function Analog Inputs (n077, n078, n079)

The input analog signal (0 to 10 V or 4 to 20 mA) for the CN2 terminal of the JVOP-140 Digital Operator can be used as an auxiliary function for the master frequency reference input to the control circuit terminals (FR or RP). Refer to the block diagram on page 167 for details on the input signal.



When using the signal for the CN2 terminal of the JVOP-140 Digital Operator as a multi-function analog input, never use it for the target value or the feedback value of PID control.

Multi-function Input Selection (n077)

No.	Name	Unit	Setting Range	Factory Setting
n077	Multi-function Input Selection	-	0 to 4	0

n077 Settings

Setting	Function	Description
0	Disabled	The multi-function input is disabled.
1	Auxiliary frequency reference (FREF2)	When frequency reference 2 is selected using the multi-step speed references, the input analog signal for the CN2 terminal will be the frequency reference. The n025 setting will be invalid. Note: Set the Frequency Reference Gain in n068 or n071, and the Frequency Reference Bias in n069 or n072.
2	Frequency reference gain (FGAIN)	Set the FGAIN to constant n060 or n074 and the FBIAS to constant n061 or n075 for the master frequency reference. Then, multiply the resulting frequency reference by the FGAIN.
3	Frequency reference bias (FBIAS)	Set the FGAIN to constant n060 or n074 and the FBIAS to constant n061 or n075 for the master frequency reference. Then, add the FBIAS to the resulting frequency reference. The amount of the FBIAS to be added is set to n079.
4	Output voltage bias (VBIAS)	Add the VBIAS to the output voltage after V/f conversion.

Analog Input Level

1. Auxiliary Frequency Reference (n077=1)

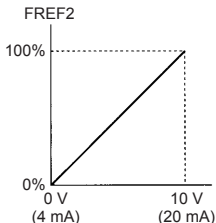

100%=Max. Output Frequency (n011)

2. Frequency Reference Gain (n077=2)

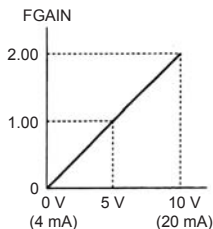

3. Frequency Reference Bias (n077=3) 4. Output Voltage Bias (n077=4)

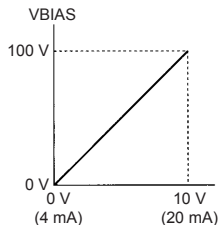
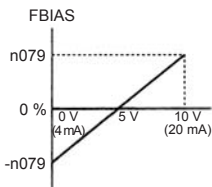

The VBIAS value to be added is doubled for 400 V Class Inverters.

Multi-function Analog Input Signal Selection (n078)

Constant No.	Name	Unit	Setting Range	Factory Setting
n078	Multi-function Analog Input Signal Selection	-	0=Digital Operator terminal (voltage: 0 to 10 V) 1=Digital Operator terminal (current: 4 to 20 mA)	0

Frequency Reference Bias Setting (n079)

Constant No.	Name	Unit	Setting Range	Factory Setting
n079	Frequency Reference Bias Setting	1 %	0 to 50 100 %/Max. Output Frequency (n011)	10

□ Using Output Signals (n057, n058, n059)

The functions of multi-function output terminals MA, MB, P1 and P2 can be changed as necessary by setting constants n057, n058, and n059.

- Terminal MA and MB functions: Set in n057
- Terminal P1 function: Set in n058
- Terminal P2 function: Set in n059

Setting	Name	Description	Ref. page
0	Fault	Closed when Inverter fault occurs.	-
1	Operating	Closed when either FWD/REV Run Command is input or voltage is output from the Inverter.	-
2	Frequency agree	Closed when the set frequency agrees with Inverter output frequency.	125
3	Zero speed	Closed when Inverter output frequency is less than minimum output frequency.	-
4	Frequency detection 1	Output frequency \geq Frequency Detection Level (n095)	82
5	Frequency detection 2	Output frequency \leq Frequency Detection Level (n095)	82
6	Overtorque detection, NO contact output	-	81
7	Overtorque detection, NC contact output	-	81
8	Undertorque detected, NO contact output	-	185
9	Undertorque detected, NC contact output	-	185
10	Minor fault	Closed when an alarm has been detected.	-
11	Base blocked	Closed when the Inverter output is OFF.	-
12	Operating mode	Closed when LOCAL is selected for the LOCAL/REMOTE selection.	-
13	Inverter operation ready	Closed when an Inverter fault is not detected, and operation is ready.	-
14	Fault retry	Closed during fault retries.	-
15	UV	Closed when undervoltage is detected.	-

Setting	Name	Description	Ref. page
16	Reverse run	Closed during reverse run.	-
17	Speed search	Closed when Inverter conducts a speed search.	-
18	Data output from communications	Operates multi-function output terminal independently from Inverter operation (by MEMOBUS communication)	141
19	PID feedback loss	Closed during PID feedback loss.	163
20	Frequency reference loss	Closed during frequency reference loss.	183
21	Inverter overheat alert	Closed during Inverter overheat alert.	111
22	monitor motor selection	closed during select motor 2	-

Factory Settings

No.	Terminal	Factory Setting
n057	MA, MB	0 (fault)
n058	P1	1 (operating)
n059	P2	2 (frequency agree)

- Frequency Agree Signal (setting=2)

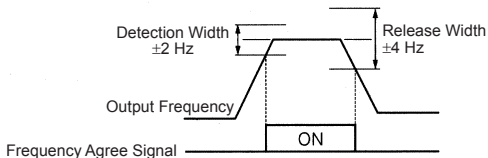

■ Setting Frequency by Current Reference Input

When setting the frequency by inputting a current reference (4 to 20 mA or 0 to 20 mA) from the control circuit terminal FR, switch the DIP switch SW2 on the control circuit board to the “I” side.

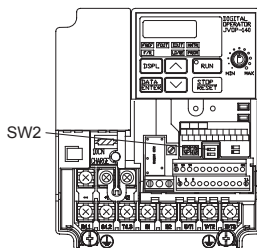
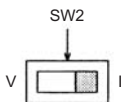

Never input a voltage reference to control circuit terminal FR when DIP switch SW2 is switched to the “I” side. The Inverter might be damaged.

Current Reference Selection

After changing the DIP switch (V-I switch of SW2) to the “I” side, press **PRGM** on the Digital Operator, then set the following constants.

Current reference (4 to 20 mA): constant n004 = 3

Current reference (0 to 20 mA): constant n004 = 4

- Setting: n003 = 0

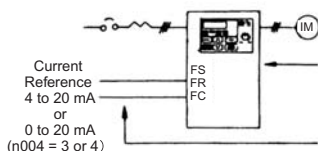

Press the Digital Operator keys to run or stop the Inverter. Switch FWD and REV run by setting the F/R LED.

Set the frequency by the analog current signal [0 % to 100 % (max. frequency)/4 to 20 mA or 0 to 20 mA] connected to the control circuit terminals.

- Setting: n003 = 1

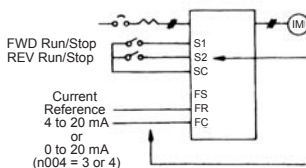

Switch run/stop and FWD/REV run with switching device connected to the control circuit terminal.

Multi-function input terminals S1 and S2 are set to Forward run/stop (n050=1) and Reverse run/stop (n051=2) respectively.

Set frequency by the analog current signal [0 % to 100 % (max. frequency)/4 to 20 mA or 0 to 20 mA] connected to the control circuit terminal.

Frequency reference gain (n060)/bias (n061) can be set even when current reference input is selected. For details, refer to *Adjusting Speed Setting Signal* on page 76.

■ Frequency Reference by Pulse Train Input

Frequency reference can be set by pulse train input from the control circuit terminals.

- Input pulse specifications
 - Low-level voltage: 0.8 V or less
 - High-level voltage: 3.5 to 32 V
 - H duty: 30 % to 70 %
 - Pulse frequency: 0 to 33 kHz
- Frequency reference method

Frequency reference is a value obtained by multiplying the ratio of the maximum input pulse frequency and actual input pulse frequency by the maximum output frequency.

$$\text{Reference frequency} = \frac{\text{Input pulse frequency}}{\text{Maximum pulse train frequency (n149)} \times 10} \times \text{Maximum output frequency (n011)}$$

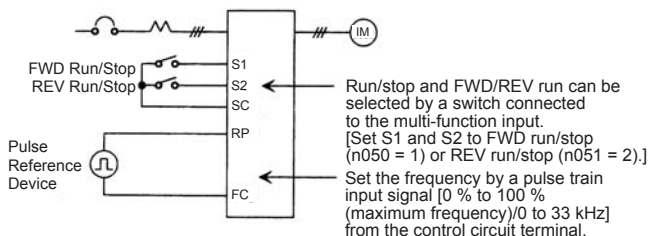

Constant No.	Name	Unit	Setting Range	Factory Setting
n003	Run Command Selection	-	0 to 3	0
n004	Frequency Reference Selection	-	0 to 9	1
n149	Pulse Train Input Scaling	1=10 Hz	100 to 3300 (33 kHz)	2500 (25 kHz)

■ Two-wire Sequence 2

Additional to the standard 2-wire or 3-wire sequence a new 2-wire sequence 2 is available which features a FWD/REV Run 2 Command (setting 37 for one of the Multi-function Input Selection 1 to 7, constants n050 to n056).

Whenever this FWD/REV Run 2 Command is programmed to one of the Multi-function Digital Inputs, it switches between forward (ON) and reverse (OFF) operation, while the standard FWD Run Command (set value 1 for n050 to n056) works as a RUN/STOP command (i.e. it starts and stops the inverter operation).

An “ERR” alarm will be displayed when it is tried to set the REV Run Command (set value: 2) and the FWD/REV Run 2 Command (set value: 37) simultaneously. If this is attempted via communications, constant setting error message "oP8" will be displayed, and operation will not be possible.

The following time chart shows the operation of the traditional 2-wire and 3-wire sequences and the operation of 2-wire sequence 2.

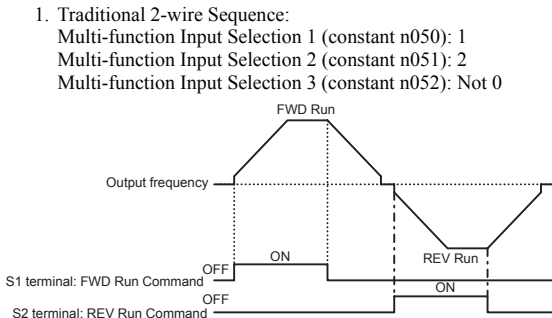

2. Three-wire Sequence

Multi-function input selection 1 (constant n050): 1 (Any setting)

Multi-function input selection 2 (constant n051): 2 (Any setting)

Multi-function input selection 3 (constant n052): 0

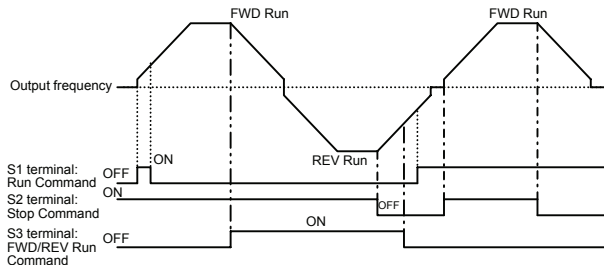

3. Two-wire Sequence 2 (Special Specifications):

Multi-function input selection 1 (constant n050): 1

Multi-function input selection 2 (constant n051): 37

Multi-function input selection 3 (constant n052): Not 0

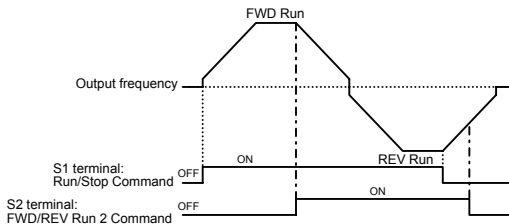

■ Preventing the Motor from Stalling (Current Limit)

This function automatically adjusts the output frequency and output current according to the load to continue operation without stalling the motor.

Stall Prevention (Current Limit) Level during Acceleration (n093)

Sets the stall prevention (current limit) level during acceleration in units of 1%. (Inverter rated current = 100%)

Factory setting: 170%

A setting of 200% disables the stall prevention (current limit) during acceleration. If the output current exceeds the value set for n093 during acceleration, acceleration stops and the frequency is maintained. When the output current goes to the value set for n093, acceleration starts.

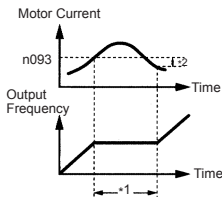

*1: Stops the acceleration to prevent the motor from stalling.

*2: Release width (hysteresis) of stall prevention during acceleration is approx. 5% of inverter rated current.

In the constant output area (output frequency > Max. Voltage Output Frequency (n013)), the stall prevention (current limit) level during acceleration is automatically decreased using the following equation.

Stall prevention during accel. in constant output area =

$$\text{Stall Prevention Level During Accel. (n093)} \times \frac{\text{Max. Voltage Output Freq. (n013)}}{\text{Output frequency}}$$

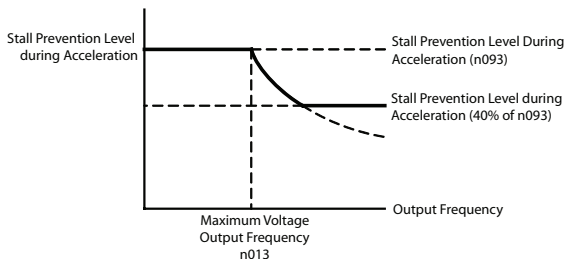

Stall Prevention (Current Limit) Level while Running (n094)

Sets the stall prevention (current limit) level while running in units of 1%. (Inverter rated current = 100%)

Factory setting: 160%

A setting of 200% disables stall prevention (current limit) while running.

If the stall prevention action current at speed agreement exceeds the value set for n094 for longer than 100 ms, deceleration starts.

If the output current exceeds the value set for n094, deceleration continues. If the output current goes to the value set for n094, acceleration to the set frequency starts.

Stall prevention acceleration/deceleration settings during operation are set either for the currently selected Acceleration Time, i.e., for Acceleration Time 1 (n019) and Deceleration Time 1 (n020), or for Acceleration Time 2 (n021) and Deceleration Time 2 (n022).

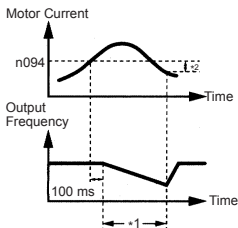

*1: Decreases the frequency to prevent the motor from stalling.

*2: At the start of acceleration, the output current hysteresis is approx. 5% of Inverter rated current.

□ Stall Prevention during Operation

Stall Prevention above Base Speed during Run (n115)

The stall prevention level can be decreased automatically in the constant output range.

Constant No.	Name	Unit	Setting Range	Factory Setting
n115	Stall Prevention above Base Speed during Run	-	0=Disabled 1=Enabled	0

n115 Settings

Setting	Function
0	The stall prevention level is the level set for constant n094 in all frequency areas.
1	<p>The following figure shows how the stall prevention level is automatically decreased in the constant output range (Max. frequency > Max. Voltage Output Frequency (n013)).</p> <p>The lower limit is 40% of the set value of n094.</p>

Acceleration/Deceleration Time Selection during Stall Prevention (n116)

With this function, Acceleration Time 2 (n021) and Deceleration Time 2 (n022) can be fixed as the acceleration/deceleration time when moving to prevent stalling during operation.

Constant No.	Name	Unit	Setting Range	Factory Setting
n116	Acceleration/Deceleration Time Selection during Stall Prevention	-	0=Disabled 1=Enabled	0

n116 Settings

Setting	Function
0	Standard Selection Acceleration/Deceleration Time 1 or 2.
1	Automatic Selection Acceleration/Deceleration Time 2 (n021, n022).

- Stall Prevention during Deceleration (n092)

To prevent overvoltage during deceleration, the Inverter automatically extends the deceleration time according to the value of the main circuit DC voltage. When using an optional braking resistor, set n092 to 1.

Setting	Stall Prevention during Deceleration
0	Provided
1	Not provided (with braking resistor mounted)

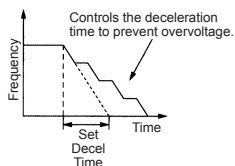

Note: If Stall Prevention during Deceleration is used with simple positioning control, positioning will not be performed properly, so use a set value of 1.

■ Decreasing Motor Speed Fluctuation

□ Slip Compensation (n002 = 0)

As the load becomes larger, the motor speed is reduced and the motor slip value is increased. The slip compensating function controls the motor speed at a constant value even if the load varies.

When the Inverter output current is equal to the Motor Rated Current (n036), the compensation frequency is added to the output frequency.

Compensation Frequency = Motor Rated Slip (n106)

$$\times \frac{\text{Motor Rated Slip (n106)} - \text{Motor No-load Current (n110)}}{\text{Motor Rated Current (n036)} - \text{Motor No-load Current (n110)}} \\ \times \text{SlipCompensationGain(n110)}$$

Related Constants

Constant No.	Name	Unit	Setting Range	Factory Setting
n036	Motor Rated Current	0.1 A	0% to 150% of Inverter rated current	*
n111	Slip Compensation Gain	0.1	0.0 to 2.5	0.0
n110	Motor No-load Current	1%	0% to 99% (100%=Motor Rated Current n036)	*
n112	Slip Compensation Time Constant	0.1 s	0.0 to 25.5 s When 0.0 s is set, delay time is 2.0 s.	2.0 s
n106	Motor Rated Slip	0.1 Hz	0.0 to 20 Hz	*

* Depends on Inverter capacity. (Refer to pages 245 and 246.)

- Note: 1. Slip compensation is not performed under the following condition:
Output frequency < Minimum Output Frequency (n016)
- Slip compensation is not performed during regeneration.
 - Slip compensation is not performed when the Motor Rated Current (n036) is set to 0.0 A.

■ Motor Protection

□ Motor Overload Detection

The V7AZ protects against motor overload with a built-in electronic thermal overload relay.

Motor Rated Current (Electronic Thermal Reference Current, n036)

Set the rated current value shown on the motor nameplate.

Note: Setting n036 to 0.0 A disables the motor overload protective function.

Motor Overload Protection Selection (n037, n038)

n037 Setting	Electronic Thermal Characteristics
0	For general-purpose motor
1	For Inverter motor
2	Electronic thermal overload protection not provided.

Constant No.	Name	Unit	Setting Range	Factory Setting
n038	Electronic Thermal Motor Protection Time Constant Setting	1 min	1 to 60 min	8 min

The electronic thermal overload function monitors the motor temperature based on Inverter output current and time to protect the motor from overheating. When the electronic thermal overload relay is enabled, an **OL** error occurs, and the Inverter output is turned OFF to prevent excessive overheating in the motor. When operating with one Inverter connected to one motor, an external thermal relay is not needed. When operating more than one motor with one Inverter, install a thermal relay on each motor.

General-purpose Motors and Inverter Motors

Induction motors are classified as general-purpose motors or Inverter motors based on their cooling capabilities. The motor overload function operates differently for these two motor types.

Example for 200 V Class Motors

	Cooling Effect	Torque Characteristics	Electronic Thermal Over-load
General-purpose	Effective when operated at 50/60 Hz from commercial power supply	<p>Base Frequency 60 Hz (V/f for 50 Hz, 220 V Input Voltage)</p> <p>For low-speed operation, torque must be limited in order to stop motor temperature rise.</p>	An OL error (motor overload protection) occurs when continuously operated at 50/60 Hz or less at 100% load.
Inverter Motor	Effective even when operated at low speed (approx. 6 Hz)	<p>Base Frequency 60 Hz (V/f for 50 Hz, 220 V Input Voltage)</p> <p>Use an Inverter motor for continuous operation at low speed.</p>	Electronic thermal overload protection is not activated even for continuous operation at 50/60 Hz or less at a 100% load.

□ PTC Thermistor Input for Motor Overheat Protection

Motor protection is performed using the temperature-resistance characteristics of the positive temperature coefficient (PTC) thermistor, which is embedded in the coil for each motor phase.

The following graph shows the characteristics of the PTC temperature-resistance value.

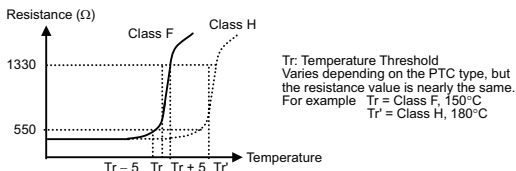

The voltage across the ends of three PTC thermistors connected in series is input to an analog input terminal (FR), and motor OH alarms and motor OH errors are detected according to the voltage in respect to the temperature-resistance characteristics of the PTC thermistor.

After a motor OH alarm is detected (FR input > 0.94 V), operation continues according to the n141 Motor Overheat Operation Selection (and the OH8 indicator on the Digital Operator will flash).

After a motor error is detected (FR input > 1.87 V), the motor stops according to the n141 Motor Overheat Operation Selection (and the OH9 indicator on the Digital Operator will flash).

Constant No.	Name	Description	Factory Setting
n141	PTC Thermistor Input Motor Overheat Protection Selection	<p>0: No overheat protection with PTC thermistor input (FR)</p> <p>1 or higher: Overheat protection with PTC thermistor input (FR)</p> <p>Note: oH8 / oH9 alarm: User can select the inverter decelerate to a stop or not.</p> <p>1: Only oH8 alarm, not to a stop.</p> <p>2: oH8 alarm, and decelerate to a stop (oH9 fault output).</p> <p>3: oH8 alarm, and decelerate to a stop (oH9 fault output) using n022 (Deceleration Time 2) deceleration time</p> <p>4: oH8 alarm, and coasting to a stop (oH9 fault output) .</p> <p>5: not oH8 alarm, and decelerate to a stop (oH9 fault output).</p> <p>6: not oH8 alarm, and decelerate to a stop (oH9 fault output) using n022 (Deceleration Time 2) deceleration time.</p> <p>7: not oH8 alarm, and coasting to a stop (oH9 fault output).</p>	0
n142	Motor Temperature Input Filter Time Constant	<p>Setting Unit: 0.1 s</p> <p>Setting Range: 0.0 to 10.0 s</p>	0.2 sec

Note: When the analog signal (0 to 10 V) input into terminal FR is used as the motor overheat signal for the PTC thermistor input (FR) (when n141 is set to 1 or higher), the signal cannot be used as a frequency reference or for PID feedback. (There are restrictions when setting constants.) The following settings cannot be set from the Digital Operator. (After the error is displayed on the Digital Operator, the value returns to the value before the change.)

If the following settings are set from the MEMOBUS, a constant setting error will occur. (oP7 will flash on the Digital Operator.)

- When n141 is set to 1 or higher:
n004 (Frequency Reference Selection) cannot be set to 2, 3, or 4 (frequency reference of 0 to 10 V, 4 to 20 mA, or 0 to 20 mA, respectively).
When n128 (PID Control Selection) is set to a value other than 0 (with PID control), n164 (PID Feedback Value Selection) cannot be set to 0, 1, or 2 (feedback values of 0 to 10 V, 4 to 20 mA, or 0 to 20 mA, respectively).
- Constant n141 cannot be set to 1 when n004 is set to 2, 3, or 4, and n128 is set to 1 and n164 is set to 0, 1, or 2.

Terminal Connection Diagram of PTC Thermistor Input Motor Overheat Protection

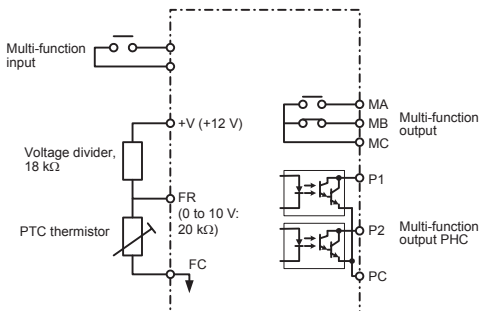

Note: When performing motor overheat protection using the PTC thermistor input, be sure to set the V-I switch (SW2) on the DIP switch on the control circuit board to V.



■ Selecting Cooling Fan Operation

In order to increase the life of the cooling fan, the fan can be set to operate only when Inverter is running

- n039 = 0 (Factory setting): Operates only when Inverter is running
(Continues operation for 1 minute after Inverter is stopped.)
- =1: Operates with power ON.

■ Using MEMOBUS (MODBUS) Communications

Serial communication is available with V7AZ using a programmable controller (MEMOCON series) and MEMOBUS (MODBUS). Refer to the MEMOBUS Instruction Manual (Manual No.: TOEZ-C736-70.1) for details of communications.

□ MEMOBUS (MODBUS) Communications

The MEMOBUS system is composed of a single master (PLC) and slaves (1 to 31 V7AZ units).

Communication between master and slave (serial communication) is controlled according to the master program with the master initiating communication and the slave responding.

The master sends a signal to one slave at a time. Each slave has a pre-registered address number, and the master specifies the number and conducts signal communications. The slave receives the communications to carry out designated functions and reply to the master.

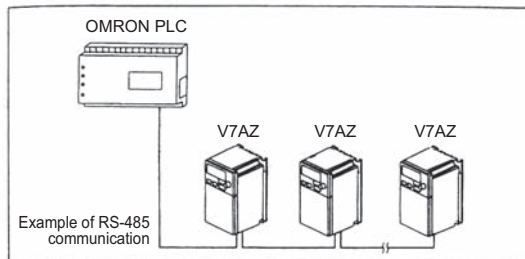

□ Communications Specifications

Interface	RS-422, RS-485
Synchronization	Asynchronous (Start-stop synchronization)
Communication Parameters	Baud rate: Selected from 2400/4800/9600/19200 bps Data length: 8 bits fixed Parity: Selected from even/odd/none Stop bits: 1 bit fixed
Communication Protocol	MEMOBUS (MODBUS) (RTU mode only)
Max. Number of Inverters That Can Be Connected	31 (When using RS-485)

□ Communications Connection Terminal

Use the following S+, S-, R+ and R- terminals for MEMOBUS communications. Change the termination resistor as shown below.

At RS-422, RS-485 communications: Turn ON SW2 ON/OFF switch of only the Inverter at the termination viewed from the PLC.

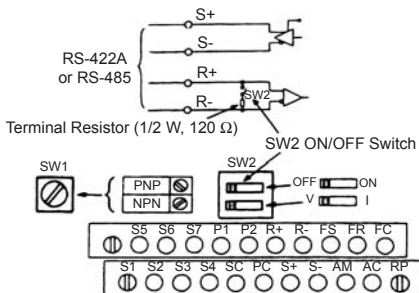

- Note: 1. Separate the wiring for communication from the main circuit wiring or other power lines.
2. Use shielded cables for communication wiring; connect the shielded sheath to the ground terminal and terminate the other end to prevent it from being connected (to prevent noise malfunction).
3. When communication is performed through RS-485, connect S+ and R+, S- and R- terminals outside the Inverter as shown at the right.

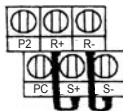

Procedure for Communications with PLC

The following shows the procedure for communications with a PLC.

1. Connect the communication cable between the PLC and the V7AZ with the power supply turned OFF.
2. Turn the power ON.
3. Set the constants (n151 to n157) required for communication by using the Digital Operator.
4. Turn the power OFF once to verify that the Digital Operator displays have been completely erased.
5. Turn the power ON again.
6. Communications with the PLC starts.

Setting Constants Necessary for Communication

Communication related constants must be set for PLC communication.

Constants n151 to n157 cannot be set by communication. Always set them before performing communication.

Constant	Name	Description	Factory Setting
n003	Run Command Selection	0: Digital Operator 1: Control circuit terminals 2: MEMOBUS communications 3: Communications card (optional)	0
n004	Frequency Reference Selection	0: Potentiometer (Digital Operator) 1: Frequency reference 1 (n024) 2: Control circuit terminals (voltage 0 to 10 V) 3: Control circuit terminals (current 4 to 20 mA) 4: Control circuit terminals (current 0 to 20 mA) 5: Pulse train 6: MEMOBUS communication (register No. 0002H) 7: Operator circuit terminals CN2(voltage 0 to 10 V) 8: Operator circuit terminals CN2(current 4 to 20 mA) 9: Communication card (optional)	0
n151	MEMOBUS Timeover Detection Monitors Transmission Time between Receiving the Correct Data from the PLC. (Timeover: 2 s)	0: Timeover detection (coast to a stop) 1: Timeover detection (decelerates to a stop with speed deceleration time 1) 2: Timeover detection (decelerates to a stop with speed deceleration time 2) 3: Timeover detection (continuous operation, warning display) 4: Timeover detection not provided	0
n152	MEMOBUS Frequency Reference and Frequency Monitor Unit	0: 0.1 Hz 1: 0.01 Hz 2: 30000/100 % (30000=max.output frequency) 3: 0.1 %	0

Constant	Name	Description	Factory Setting
n153	MEMOBUS Slave Address	Setting range: 0 to 32*	0
n154	MEMOBUS BPS Selection	0: 2400 bps 1: 4800 bps 2: 9600 bps 3: 19200 bps	2
n155	MEMOBUS Parity Selection	0: Even parity 1: Odd parity 2: No parity	2
n156	Transmission Waiting Time	Setting range: 10 ms to 65 ms Setting unit: 1 ms	10 ms
n157	RTS Control	0: RTS control 1: No RTS control (RS-422A: 1-to-1 communication)	0

* The slave does not respond to the command from the master when set to 0.

Monitoring run status from the PLC, setting/referencing of constants, Fault Reset and multi-function input reference can be done regardless of Run Command or frequency reference selection.

Multi-function input reference from the PLC becomes OR with input commands from S1 to S7 multi-function input terminals.

□ Message Format

For communications, the master (PLC) sends a command to the slave (V7AZ) and the slave responds to it. The configuration for sending and receiving is as shown to the right. The length of the data varies according to the contents of commands (functions).

The interval between messages must be maintained at the following amount.

Slave address
Function code
Data
Error check

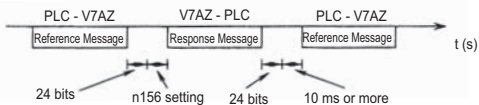

- Slave address: Inverter address (0 to 32)

Setting to 0 indicates simultaneous broadcasting. The Inverter does not respond to the command from the master.

- Function code: Command codes (See below.)

Function Code Hexadecimal	Function	Reference Message		Response Message	
		Minimum (Bytes)	Maximum (Bytes)	Minimum (Bytes)	Maximum (Bytes)
03H	Reading holding register contents	8	8	7	37
08H	Loop-back test	8	8	8	8
10H	Write in several holding registers	11	41	8	8

- Data: Composes a series of data by combining holding register numbers (test codes for loop-back numbers) and their data. Data length depends on the contents of the command.
- Error check: CRC-16 (Calculate the value by the following method.)
 1. The default value at calculation of CRC-16 is normally 0. In the MEMOBUS system, change the default to 1 (all to 16-bit).
 2. Calculate CRC-16 assuming that the loop address LSB is MSB and the last data MSB is LSB.
 3. Also calculate CRC-16 for a response message from the slave and refer it to CRC-16 in the response message.
- Read Out Holding Register Contents (03H)

Reads out the contents of the specified number of continuous holding registers. The contents of each holding register is divided into the upper 8 bits and the lower 8 bits. They become the data items in the response message in numerical order.

Example:

Reads out the status signal, fault contents, data link status, and frequency reference from the V7AZ (slave 2).

Reference Message

Slave address	02H	
Function code	03H	
Start number	Upper	00H
	Lower	20H
Quantity	Upper	00H
	Lower	04H
CRC-16	Upper	45H
	Lower	F0H

(For error code 03H, refer to page 157.)

Response Message
(at Normal Operation)

Slave address	02H	
Function code	03H	
Number of data*	08H	
First holding register	Upper	00H
	Lower	65H
Next holding register	Upper	00H
	Lower	00H
Next holding register	Upper	00H
	Lower	00H
Next holding register	Upper	01H
	Lower	F4H
CRC-16	Upper	AFH
	Lower	82H

Response Message
(at Fault Occurrence)

Slave address	02H	
Function code	83H	
Error code	03H	
CRC-16	Upper	F1H
	Lower	31H

* Twice as much as the number of the reference message.

- **Example of Loop-back Test (08H)**

A reference message is returned as a response message without being changed. This function is used to check communication between the master and the slave. Any arbitrary values can be used for test codes or data.

Example: Loop-back test of V7AZ (slave 1)

Reference Message

Slave address	01H	
Function code	08H	
Test code	Upper	00H
	Lower	00H
Data	Upper	A5H
	Lower	37H
CRC-16	Upper	DAH
	Lower	8DH

Response Message
(at Normal Operation)

Slave address	01H	
Function code	08H	
Test code	Upper	00H
	Lower	00H
Data	Upper	A5H
	Lower	37H
CRC-16	Upper	DAH
	Lower	8DH

Response Message
(at Fault Occurrence)

Slave address	01H	
Function code	89H	
Error code	01H	
CRC-16	Upper	86H
	Lower	50H

- Writing to Several Holding Registers (10H)

Specified data are written into the several specified holding registers from the specified number, respectively. Written data must be arranged in a reference message in the order of the holding register numbers: from upper eight bits to lower eight bits.

Example:

Set forward run at frequency reference 60.0 Hz to slave 1 V7AZ from the PLC.

Reference Message			Response Message (at Normal Operation)			Response Message (at Fault Occurrence)		
Slave address		01H	Slave address		01H	Slave address		01H
Function code		10H	Function code		10H	Function code		90H
Start number	Upper	00H	Start number	Upper	00H	Error code		02H
	Lower	01H		Lower	01H	CRC-16	Upper	CDH
Quantity	Upper	00H	Quantity	Upper	00H		Lower	C1H
	Lower	02H		Lower	02H			
Number of data*		04H	CRC-16		Upper	10H		
First data	Upper	00H			Lower	08H		
	Lower	01H						
Next data	Upper	02H						
	Lower	58H						
CRC-16	Upper	63H						
	Lower	39H						

* Sets twice as large as the actual number.

Register No.	Bit	Description
000AH		Pulse train output terminal AM output setting Setting range: 0 to 14400 (0 to 14,400 Hz output/0 to 14400 [set in 1-Hz increments]) Note: Enabled only when n065 is set to 1 (pulse monitor output) and n150 is set to 50 (data output via communications).
000BH	PLC alarm/error setting	0 PLC alarm 1 1: PLC alarm 1 (PA1 flashes on Digital Operator)
		1 PLC alarm 2 1: PLC alarm 2 (PA2 flashes on Digital Operator)
		2 PLC error 1 1: PLC error 1 (PE1 displayed on Digital Operator)
		3 PLC error 2 1: PLC error 2 (PE2 displayed on Digital Operator)
		4-F (Not used)
000CH	Digital Operator	0-6 Digital Operator 7-segment LED 1st digit display data (ASCII)
		7-D Digital Operator 7-segment LED 2nd digit display data (ASCII)
		E-F (Not used)
000DH	Digital Operator	0-6 Digital Operator 7-segment LED 3rd digit display data (ASCII)
		7-D Digital Operator 7-segment LED 4th digit display data (ASCII)
		E-F (Not used)
000EH 001FH		Reserved

Note: Write in "0" for an unused bit. Never write in data for the reserved register.

* Codes that cannot be expressed on 7-segment LEDs will be displayed as "_".

- Simultaneous Broadcasting Data (available only for write in)

Register No.	Bit	Description
0001H	0	Run Command 1: Run 0: Stop
	1	Reverse Run Command 1: Reverse run 0: Forward run
	2	(Not used)
	3	(Not used)
	4	External fault 1: Fault (EFO)
	5	Fault Reset Command 1: Fault Reset
	6-F	(Not used)
0002H		Frequency reference 30000/100 % fixed unit (Data is converted into 0.01 Hz inside the Inverter, and fractions are rounded off.)

Bit signals not defined as the broadcast operation signals are used as the local station data signals.

- Monitor Data (available only for read out)

Register No.	Bit	Description	
0020H	Status signal	0	Run Command 1: Run 0: Stop
		1	Reverse Run Command 1: Reverse run 0: Forward run
		2	Inverter operation ready 1: Ready 0: Not ready
		3	Fault 1: Fault
		4	Data setting error 1: Error
		5	Multi-function output 1 (1: MA ON 0: MA OFF)
		6	Multi-function output 2 (1: P1 ON 0: P1 OFF)
		7	Multi-function output 3 (1: P2 ON 0: P2 OFF)
		8-F	(Not used)

Register No.	Bit	Description
0021H	0	Overcurrent (OC)
	1	Overvoltage (OV)
	2	Inverter overload (OL2)
	3	Inverter overheat (OH)
	4	(Not used)
	5	(Not used)
	6	PID feedback loss (FbL)
	7	External fault (EF, EFO), Emergency stop (STP)
	8	Hardware fault (FXX)
	9	Motor overload (OL1)
	A	Overtorque detection (OL3)
	B	Undertorque detection (UL3)
	C	Power loss (UV1)
	D	Control power fault (UV2)
	E	MEMOBUS communications timeover (CE)
F	Operator connection fault (OPR)	
0022H	0	Data write in
	1	(Not used)
	2	(Not used)
	3	Upper/lower limit fault
	4	Consistency fault
	5-F	(Not used)
0023H	Frequency reference (unit: n152)	
0024H	Output frequency (unit: n152)	
0025H-0026H	(Not used)	
0027H	Output current (10/1 A)	
0028H	Output voltage reference (1/1 V)	

Register No.		Bit	Description
0029H	Fault description	0	(Not used)
		1	(Not used)
		2	Input open phase (PF)
		3	Output open phase (LF)
		4-F	(Not used)
002AH	Alarm description	0	Operation function stop (STP)
		1	Sequence error (SER)
		2	Simultaneous FWD/REV Run Commands (EF)
		3	External Baseblock (BB)
		4	Overtorque detection (OL3)
		5	Cooling fan overheat (OH)
		6	Main circuit overvoltage (OV)
		7	Main circuit undervoltage (UV)
		8	Cooling fan fault (FAN)
		9	Communications fault (CE)
		A	Option card communications error (BUS)
		B	Undertorque (UL3)
		C	Inverter overheat alert (OH3)
		D	PID feedback loss (FBL)
		E	Emergency stop (STP)
F	Communications waiting (CAL)		
002BH	Sequence input status	0	Terminal S1 1: Closed 0: Open
		1	Terminal S2 1: Closed 0: Open
		2	Terminal S3 1: Closed 0: Open
		3	Terminal S4 1: Closed 0: Open
		4	Terminal S5 1: Closed 0: Open
		5	Terminal S6 1: Closed 0: Open
		6	Terminal S7 1: Closed 0: Open
		7-F	(Not used)

Register No.		Bit	Description
002CH	Inverter status	0	Run 1: Run
		1	Zero-speed 1: Zero-speed
		2	Frequency agreed 1: Agreed
		3	Minor fault (Alarm is indicated)
		4	Frequency detection 1 1: Output frequency \leq (n095)
		5	Frequency detection 2 1: Output frequency \geq (n095)
		6	Inverter operation ready 1: Ready
		7	Undervoltage detection 1: Undervoltage detection
		8	Baseblock 1: Inverter output baseblock
		9	Frequency reference mode 1: Other than communications 0: Communications
		A	Run Command mode 1: Other than communications 0: Communications
		B	Overtorque detection 1: Detection or overtorque fault
		C	Undertorque detection 1: Detection or undertorque fault
		D	Fault retry
E	Fault (Including MEMOBUS communications timeover) 1: Fault		
F	MEMOBUS communications timeover 1: Timeover		
002DH	Multi-function output	0	MA 1: ON 0: OFF
		1	P1 1: ON 0: OFF
		2	P2 1: ON 0: OFF
		3-F	(Not used)
002EH	Inverter Status	0	Frequency reference loss 1: Frequency reference loss
		1-F	(Not used)
002FH-0030H	Reserved		
0031H	Main circuit DC voltage (1/1 V)		
0032H	Torque monitor (1/1 %; 100 %/Motor rated torque; with sign)		
0033H-0036H	(Not used)		
0037H	Output Power (1/1 W: with sign)		

Register No.	Bit	Description	
0038H		PID feedback value (100 % /Input equivalent to max. output frequency; 10/1 %; without sign)	
0039H		PID input value (± 100 %/ \pm Max. output frequency; 10/1 %; with sign)	
003AH		PID output value (± 100 %/ \pm Max. output frequency; 10/1 %; with sign)	
003BH-003CH		Reserved	
003DH	Communications error	0	CRC error
		1	Data length fault
		2	(Not used)
		3	Parity error
		4	Overrun error
		5	Framing error
		6	Timeover
		7	(Not used)
003EH-00FFH		Reserved	
0075H		Analog input terminal FR input value (0.0% to 100.0%/0 to 10 V input, 0.0% to 100.0%/4 to 20 mA input, 0.0% to 100.0%/0 to 20 mA input)	
0076H		Pulse train input terminal RP input value (1 Hz/1)	
0077H		Digital Operator potentiometer input value (0.0% to 100.0%/Minimum to Maximum)	
0078H		Digital Operator terminal CN2-1 (voltage input) input value (0.0% to 100.0%/0 to 10 V input)	
0079H		Digital Operator terminal CN2-2 (current input) input value (0.0% to 100.0%/4 to 20 mA input)	
007AH	Digital Operator key input status	0	(Not used)
		1	The DATA/ENTER key is being pressed.
		2	The UP key is being pressed.
		3	The DOWN key is being pressed.
		4	The RUN key is being pressed.
		5	The STOP/RESET key is being pressed.
		6-F	Not used (always 0)

- * Communications error contents are saved until Fault Reset is input.
(Reset is enabled during run.)

□ Storing Constants [Enter Command] (can be written only.)

Register No.	Name	Contents	Setting Range	Factory Setting
0900H	Enter Command	Write in constant data to non-volatile memory (EEPROM)	0000H to FFFFH	-

When a constant is written from the PLC by communications, the constant is written to the constant data area on the RAM in the V7AZ. The Enter Command is a command to write the constant data on the RAM to the non-volatile memory in the V7AZ. This Enter Command is executed when data, regardless of the value, is written to register number 0900H. With the factory setting, an Enter Command is accepted only while the Inverter is stopped. By changing constant n170, an Enter Command can be accepted even while the Inverter is running.



CAUTION While the constant is being stored after an Enter Command was issued, response to the commands or data input with the keys on the Digital Operator (JVOP-140) becomes poor. Be sure to take some measures for an emergency stop by using the external terminals (setting the external terminal to Run Command priority, or setting the multi-function input terminal to external fault, External Baseblock or emergency stop).



NOTE Maximum number of writing times of the non-volatile memory used for V7AZ is 100,000; do not execute the Enter Command excessively.

When a constant is changed from the Digital Operator, the constant data on the RAM is written to the non-volatile memory without the Enter Command.

Constant No.	Name	Unit	Setting Range	Factory Setting
n170	Enter Command operation selection (MEMOBUS communications)	-	0, 1	0

n170 Setting	Description
0	Accepts the Enter Command (constant saving) while the Inverter is stopped.
1	Always accepts the Enter Command (constant storing). The new constant becomes valid even if the Enter Command is not input. If the Enter Command is not used, however, the value returns to the stored value when the power supply is turned ON again.

Register number 0900H is used only for write-in. If this register is read-out, a register number error (error code: 02H) occurs.

Error code

Error Code	Contents
01H	Function code error <ul style="list-style-type: none"> Function code from PLC is other than 03H, 08H, or 10H.
02H	Improper register number <ul style="list-style-type: none"> No register numbers to be accessed have been registered. Enter Command "0900H" (an exclusive-use register for write-in) was read out.
03H	Improper quantity <ul style="list-style-type: none"> The number of data items to be read or written-in is not in the range between 1 and 16. The number of data items in a message is not the value obtained by multiplying the quantity by two in the write-in mode.
21H	Data setting error <ul style="list-style-type: none"> A simple upper/lower limit error occurred with control data or constant write-in. A constant setting error occurred when a constant was written.
22H	Write-in mode error <ul style="list-style-type: none"> Attempt to write in a constant from PLC was made during running.* Attempt to write in an Enter Command from PLC was made during running (n170=0). Attempt to write in a constant from PLC was made during UV occurrence. Attempt to write in an Enter Command from PLC was made during UV occurrence. Attempt to write in a constant other than n001=12, 13 (constant initialization) from PLC was made during "F04" occurrence. Attempt to write in a constant from PLC was made while data were being stored. Attempt to write in data exclusive for read-out from PLC was made.

* Refer to the constants list for constants that can be changed during operation.

□ Performing Self-test

V7AZ is provided with a function to perform self-diagnosis for operation check of the serial communication I/F circuit. This function is called self-test. In the self-test, connect the sending terminal with the receiving terminal in the communication section. It checks if the data received by V7AZ is not being changed. It also checks if the data can be received normally.

Carry out the self-test in the following procedure.

1. Turn ON the V7AZ power supply. Set constant n056 to 35 (self-test).
2. Turn OFF the V7AZ power supply.
3. Make the following wiring with the power supply turned OFF.
4. Turn the power ON.

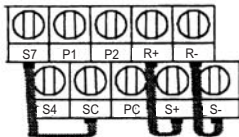

(Note: Select NPN side for SW1.)

Normal operation: Operator displays frequency reference value.

Faulty operation: Operator displays **CE**, fault signal is turned ON and Inverter ready signal is turned OFF.

■ Using PID Control Mode

For details on the PID control settings, refer to the block diagram of the Inverter's internal PID control or the block diagram of the Operator analog speed reference.

□ PID Control Selection (n128)

Constant No.	Name	Unit	Setting Range	Factory Setting
n128	PID Control Selection	-	0 to 8	0

Setting	Function	PID Output Characteristics
0	Disabled.	-
1	Enabled: Deviation is subject to derivative control.	Forward
2	Enabled: Feedback signal is subject to derivative control.	
3	Enabled: Frequency reference + PID output, and deviation are subject to derivative control.	
4	Enabled: Frequency reference + PID output, and feedback signal are subject to derivative control.	
5	Enabled: Deviation is subject to derivative control.	Reverse (Reverse the PID output.)
6	Enabled: Feedback signal is subject to derivative control.	
7	Enabled: Frequency reference + PID output, and deviation are subject to derivative control.	
8	Enabled: Frequency reference + PID output, and feedback signal are subject to derivative control.	

Set one of the above values when using PID control.
The following table shows how to determine the target value and the feedback value to be input when PID control is enabled.

	Input	Condition
Target Value	The currently selected frequency reference	Determined by the Frequency Reference Selection (n004). When LOCAL mode is selected, the target value is determined by the Frequency Reference Selection in Local Mode (n008). When multi-step speed references are selected, the currently selected frequency reference will be the target value.
Feedback Value	The frequency reference that is set in the PID Feedback Value Selection (n164)	-

n164 Setting	Description
0	Control circuit terminal FR, Voltage: 0 to 10 V
1	Control circuit terminal FR, Current: 4 to 20 mA
2	Control circuit terminal FR, Current: 0 to 20 mA
3	Operator terminal, Voltage: 0 to 10 V
4	Operator terminal, Current: 4 to 20 mA
5	Pulse train

Note: 1. When selecting a frequency reference from the control circuit terminal FR as the target or feedback value, the V-I switch of SW2 on the control circuit board must be selected depending on the input method (current or voltage input).

2. Never use the frequency reference from the control circuit terminal FR for both the target and feedback values. The frequency reference for both the target value and the feedback value becomes the same.

Example:

When the frequency reference from the control circuit terminal FR, with a voltage of 0 to 10 V, is selected as the target value and n004=2, and when at the same time the frequency reference from the control circuit terminal FR, with a current of 4 to 20 mA, is selected as the feedback value and n164=1, the feedback value will be set as the frequency reference from the control circuit terminal FR with a voltage of 0 to 10 V.

3. When using an analog signal (0 to 10 V/4 to 20 mA) input to the CN2 terminal of the JVOP-140 Digital Operator as the target or feedback value of PID control, do not use it as a multi-function analog input. Constant n077 (Multi-function Analog Input Function) must be set to 0 (disabled in this case).

Proportional Gain (P), Integral Time (I), Derivative Time (D) (n130, n131, n132)

Adjust the response of the PID control with the proportional gain (P), integral time (I), and derivative time (D).

Constant No.	Name	Unit	Setting Range	Factory Setting
n130	Proportional Gain (P)	0.1	0.0 to 25.0	1.0
n131	Integral Time (I)	0.1 s	0.0 to 360.0	1.0
n132	Derivative Time (D)	0.01 s	0.00 to 2.50	0.00

Optimize the responsiveness by adjusting the constants while operating an actual load (mechanical system). Any control (P, I, or D) that is set to zero will not operate.

Upper Limit of Integral (I) Values (n134)

Constant No.	Name	Unit	Setting Range	Factory Setting
n134	Upper Limit of Integral Values	1 %	0 to 100	100

Constant n134 prevents the calculated value of integral control from exceeding a specific amount. There is normally no need to change the setting.

Reduce the setting if there is a risk of load damage, or of the motor going out of step by the Inverter's response when the load suddenly changes. If the setting is reduced too much, the target value and the feedback value will not match.

Set this constant as a percentage of the maximum output frequency with the maximum frequency as 100%.

PID Offset Adjustment (n133)

Constant No.	Name	Unit	Setting Range	Factory Setting
n133	PID Offset Adjustment	1 %	-100 to 100	0

Constant n133 adjusts the PID control offset.

If both the target value and the feedback values are zero, adjust n133 so that the Inverter output frequency is zero.

Primary Delay Time Constant for PID Output (n135)

Constant No.	Name	Unit	Setting Range	Factory Setting
n135	Primary Delay Time Constant for PID Output	0.1 s	0.0 to 10.0	0.0

Constant n135 is the low-pass filter setting for PID control outputs.

There is normally no need to change the setting.

If the viscous friction of the mechanical system is high or if the rigidity is low, causing the mechanical system to resonate, increase the setting so that it is higher than the resonance frequency period.

PID Output Gain (n163)

Constant No.	Name	Unit	Setting Range	Factory Setting
n163	PID Output Gain	0.1	0.0 to 25.0	1.0

Constant n163 adjusts the PID control output gain.

PID Feedback Gain (n129)

Constant No.	Name	Unit	Setting Range	Factory Setting
n129	PID Feedback Gain	0.01	0.00 to 10.00	1.00

Constant n129 is the gain that adjusts the feedback value.

PID Feedback Loss Detection (n136, n137, n138)

Constant No.	Name	Unit	Setting Range	Factory Setting
n136	Selection for PID Feedback Loss Detection	-	0: No detection of PID feedback loss 1: Detection of PID feedback loss, operation continued: FbL alarm 2: Detection of PID feedback loss, output turned OFF: Fault	0
n137	PID Feedback Loss Detection Level	1 %	0 to 100 100%/Max. output frequency	0
n138	PID Feedback Loss Detection Time	0.1 s	0.0 to 25.5	1.0

PID Upper Limit

Sets the upper limit after PID control as a percentage of the maximum output frequency.

Prohibition of PID Output

Zero limit occurs when the PID output is negative.

□ Analog Position Control with Bi-directional PID Output(n145)

If the Bi-directional Function Selection (n145) is set to 1 (enabled), the following functions will be enabled as bi-directional functions:

- PID Control Selection (n128) \neq 0 (Enabled) and Bi-directional PID Prohibit Input from Multi-function Input = OFF (Bi-directional PID Function Enabled):

If the frequency reference is negative after PID control, the input rotation direction command will be reversed, and the frequency reference will be converted to an absolute value. (If Reverse Run Prohibit (n006) is set to 1, however, reverse operation will not be performed and the frequency reference will be limited to 0 Hz.)

□ Bidirectional Reference Control

PID Control Selection (n128) $\neq 0$ (Enabled) and Bi-directional PID Prohibit Input from a Multi-function Input = ON (Bi-directional Range Function Enabled):

If the frequency reference is from 0% to 50% after PID control, the input rotation direction command will be reversed. If the reference is from 50% to 100%, operation will be performed without reversing the input rotation direction command.

The frequency reference at this time is shown in the following diagram. (The diagram shows operation when a Forward Run Command is input.) (If Reverse Run Prohibit (n006) is set to 1, however, reverse operation will not be performed and the frequency reference will be limited to 0 Hz.)

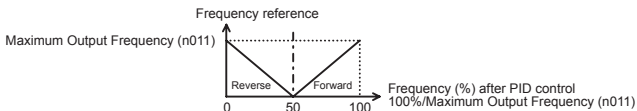

Bi-directional Function Operation Table

PID Control Selection (n128)	Bi-directional PID Prohibit Input (S1 to S7)	
	OFF	ON
$\neq 0$ (PID control enabled)	PID output is used bi-directional	Frequency reference is used bi-directional
0 (PID control disabled)	Frequency reference is used bi-directional	Frequency reference is used bi-directional

- If PID Control Selection (n128) is set to 0 (disabled), or a PID cancel input using a multi-function input is ON (Bi-directional Range Function Enabled):

If the input frequency reference is from 0% to 50%, the input rotation direction command will be reversed. If the reference is from 50% to 100%, operation will be performed without reversing the input rotation direction command.

The frequency reference at this time is shown in the following diagram. (The diagram shows operation when a Forward Run Command is input.) (If Reverse Run Prohibit (n006) is set to 1, however, reverse operation will not be performed and the frequency reference will be limited to 0 Hz.)

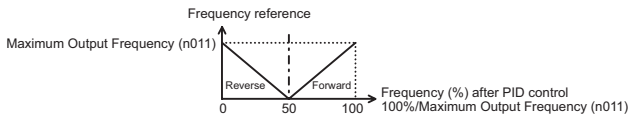

PID Analog Output of the PID Feedback Value

If the Monitor Item Selection (n066) is set to 7, the PID feedback value will be output as an analog value.

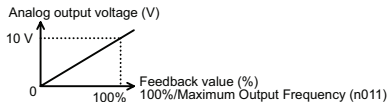

V7AZ PID Control Block Diagram

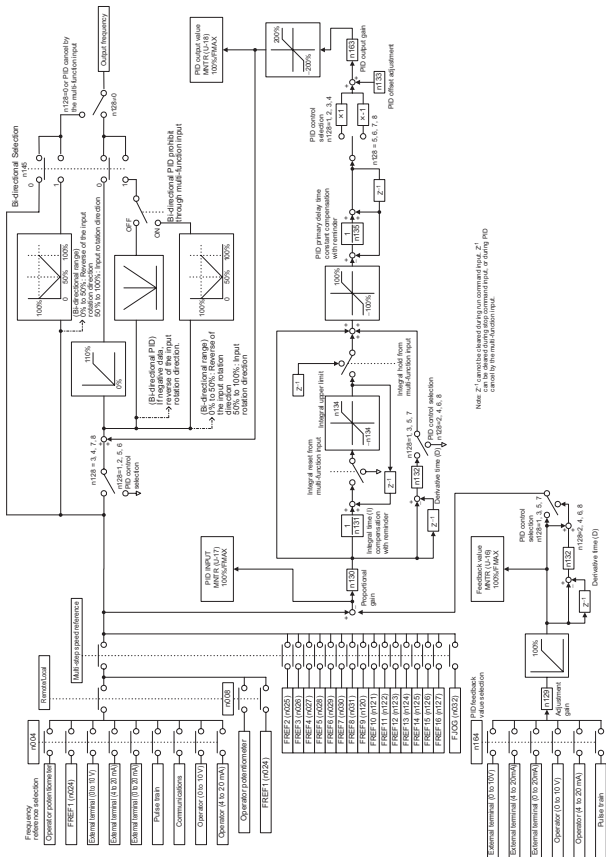

Note: Z⁻¹ cannot be cleared during run command hold, Z⁻¹ can be cleared during stop command input, or during PID cancel by the multi-function input.

Operator Analog Speed Reference Block Diagram

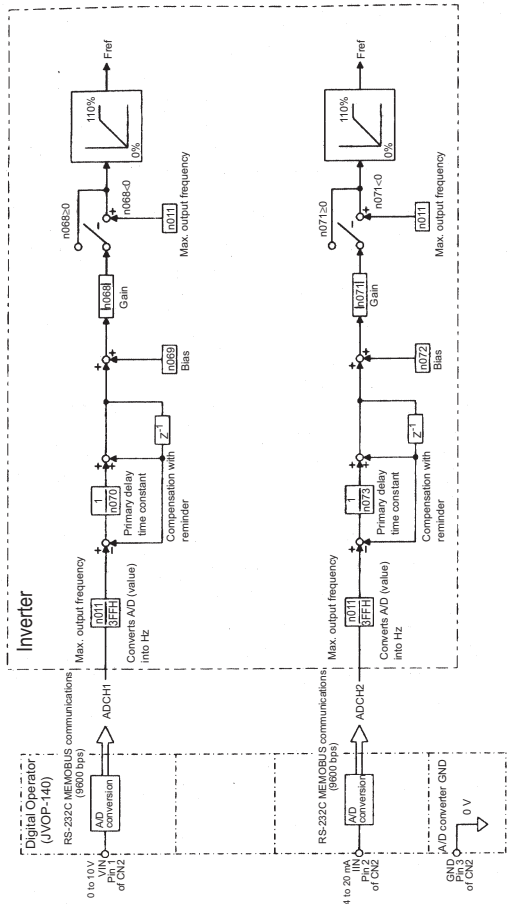

■ Using Constant Copy Function

□ Constant Copy Function

The V7AZ standard JVOP-140 Digital Operator can store constants for one Inverter. A backup power supply is not necessary because EEPROM is used.

The constant copy function is possible only for the Inverters with the same product series, power supply specifications, and control mode (V/f control or vector control). However, some constants may not be copied. It is also impossible to copy constants between V7AZ and VS mini J7 Inverters.

Prohibiting reading constants from the Inverter can be set in n177. The constant data cannot be changed when this constant is set.

If an alarm occurs when copying constants, **PRGM** will flash and copying will continue.



To remove the Digital Operator from the Inverter, turn OFF the input power supply of the Inverter and confirm that the display on the Digital Operator has turned OFF. If the Digital Operator is removed while the power is ON, the Inverter may be damaged.

Constant Copy Function Selection (n176)

Depending on the setting of n176 (Constant Copy Function Selection), the following functions can be used.

1. Reading all the constants from the Inverter (READ) and storing them in EEPROM in the Digital Operator
2. Copying the constants stored in the Digital Operator to the Inverter (COPY)
3. Verifying that the constants in the Digital Operator and the constants in the Inverter are the same (VERIFY)
4. Displaying the maximum applicable motor capacity and the voltage class of the Inverter for which constants are stored in the Digital Operator
5. Displaying the software number of the Inverter for which constants are stored in the Digital Operator

Constant No.	Name	Unit	Setting Range	Factory Setting
n176	Constant Copy Function Selection	-	rdy: Ready rEd: Read CPy: Copy vFy: Verify vA: Inverter capacity display Sno: Software No. display	rdy

Prohibiting Constant Read Selection (n177)

Select this function to prevent accidentally overwriting the constants stored in EEPROM in the Digital Operator. Reading is not possible when this constant is set to 0.

The constant data stored in the Digital Operator are safe from accidental overwriting.

If reading is attempted while this constant is set to 0, PrE will flash.

Press or and return to the constant number display.

Constant No.	Name	Unit	Setting Range	Factory Setting
n177	Constant Read Selection Prohibit	-	0: Read prohibited 1: Read allowed	0

□ READ Function

Reads out the constants in batch from the Inverter and stores them in EEPROM inside the Digital Operator. When the read-out is executed, the previously stored constants data in the EEPROM are cleared and replaced with the newly entered constants.

Example: Storing Constants from Inverter in EEPROM in Operator

Explanation	Operator Display
<ul style="list-style-type: none"> • Enable the setting of constants n001 to n179. 	<ul style="list-style-type: none"> • Press DSPL and PRGM will light. • Press ENTER to display the set value. • Change the set value to 4 by pressing the 4 or 4 key. • Press ENTER.
<ul style="list-style-type: none"> • Set Constant Read Prohibited Selection (n177) to read-enabled.*1 	<ul style="list-style-type: none"> • Change the constant No. to n177 by pressing the 7 or 7 key. • Press ENTER to display the set value. • Change the set value to 1 by pressing the 1 or 1 key. • Press ENTER.

Explanation		Operator Display
<ul style="list-style-type: none"> Execute read-out (READ) using the Constant Copy Function Selection (n176). Set Constant Read Prohibited Selection (n177) to read-disabled.*2 	<ul style="list-style-type: none"> Change the constant number by pressing the \square or \square key. Press \square to display the set value. Change the set value to rEd by pressing the \square or \square key. Press \square. 	<p>n 176</p> <p>r d' (Lit)</p> <p>rEd (Lit)</p> <p>rEd (Flashes while executing the read.) ↓ End (End is displayed after the read has been completed.)</p> <p>n 176 (The constant number is displayed.)</p>
	<ul style="list-style-type: none"> Press \square or \square. Change the constant number to n177 by pressing the \square or \square key. Press \square to display the set value. Change the set value to 0 by pressing the \square or \square key. Press \square. 	<p>n 177</p> <p>! (Lit)</p> <p>0 (Flashes)</p> <p>0 (Lit for one second.) ↓ n 177 (The constant number is displayed.)</p>

* 1. When reading is enabled (n177=1), this setting is not necessary.

* 2. This setting is not necessary unless read-prohibition is selected.

□ COPY Function

This function writes the constants stored inside the Digital Operator in batch to the Inverter. Write-in is possible only for Inverters with the same product series, power supply specifications, and control mode (V/f control or vector control).

Therefore, writing from 200 V Class to 400 V Class Inverters (or vice versa), from V/f control mode to vector control mode Inverters (or vice versa), or from V7AZ to VS mini J7 Inverters is not possible.

The Constant Copy Function Selection (n176), Constant Read Selection Prohibit (n177), Fault History (n178), Software Version No. (n179), and hold output frequency are not written. vAE will appear (flashing) if the capacities of the Inverters differ.

Press to continue writing (the COPY function).

Press to stop the COPY function.

The following constants are not written if the Inverter capacities differ.

Constant No.	Name	Constant No.	Name
n011 to n017	V/f Settings	n108	Motor Leakage Inductance
n036	Motor Rated Current	n109	Torque Compensation Voltage Limiter
n080	Carrier Frequency Selection	n110	Motor No-load Current
n105	Torque Compensation Iron Loss	n140	Energy-saving Coefficient K2
n106	Motor Rated Slip	n158	Motor Code
n107	Motor Line-to-neutral Resistance		

Constants added with software version upgrades will not be written between V7AZ Inverters without the additional constants and V7AZ Inverters with the additional constants.

For this reason, the settings for the additional constants will not be changed by the copy operation.

Example: Writing Constants from EEPROM in Operator to Inverter

Explanation	Operator Display
<ul style="list-style-type: none"> Enable the settings for constants n001 to n179. 	<ul style="list-style-type: none"> Press DSPL and PRGM will light. Press ENTER to display the set value. Change the set value to 4 by pressing the □ or □ key. Press ENTER.
<ul style="list-style-type: none"> Execute write-in (COPY) using the Constant Copy Function Selection (n176). 	<ul style="list-style-type: none"> Change the constant No. to n176 by pressing the □ or □ key. Press ENTER to display the set value. Change the set value to CPy by pressing the □ or □ key. Press ENTER. Press DSPL or ENTER.

A setting range check and matching check for the written constants are executed after the constants are written from the Digital Operator to the Inverter. If a constant error is found, the written constants are discarded and the constants stored before writing are restored.

When a setting range error is found, the constant number where an error occurs is indicated by flashing.

When an inconsistency in the settings is found, **OP** **□** (**□**: a number) is indicated by flashing.

□ VERIFY Function

This function compares the constants stored in the Digital Operator with the constant in the Inverter. Verification is possible only for the Inverters with same product series, power supply specifications, and control mode (V/f control or vector control).

When the constants stored in the Digital Operator are the same as those in the Inverter, vFy will flash, and then End will be displayed.

When the constants are not the same, the unmatched constant number will be displayed.

Constants added with software version upgrades will be displayed when VERIFY is performed for V7AZ Inverters without the additional constants and V7AZ Inverters with the additional constants.

Example: Comparing Constants Stored in EEPROM in Operator with Constants in Inverter

Explanation		Operator Display
<ul style="list-style-type: none"> Enable the settings for constants n001 to n179. 	<ul style="list-style-type: none"> Press DSPL and PRGM will light. Press ENTER to display the set value. Change the set value to 4 by pressing the \boxtimes or \boxplus key. Press ENTER. 	<p>n00 1 (May be a different constant number)</p> <p>1 (Lit) (May be a different set value.)</p> <p>4 (Flashes)</p> <p>4 (Lit for one second.)</p> <p>↓</p> <p>n00 1 (The constant number is displayed.)</p>
<ul style="list-style-type: none"> Execute VERIFY by Constant Copy Function Selection (n176). Display the unmatched constant number Display the constant value in the Inverter. Display the constant value in the Digital Operator. Continue the execution of VERIFY. 	<ul style="list-style-type: none"> Change the constant number to n176 by pressing the \boxtimes or \boxplus key. Press ENTER to display the set value. Change the set value to vFy by pressing the \boxtimes or \boxplus key. Press ENTER. Press ENTER. Press ENTER. Press the \boxtimes key. Press DSPL or ENTER. 	<p>n 176</p> <p>vFy (Lit)</p> <p>vFy (Lit)</p> <p>vFy (Flashes while executing the verification.)</p> <p>n0 11 (Flashes) (When n011 is different.)</p> <p>50.0 (Flashes)</p> <p>50.0 (Flashes)</p> <p>vFy (Flashes while executing the verification.)</p> <p>↓</p> <p>End (End is displayed when the verification has been completed.)</p> <p>n 176 (The constant number is displayed.)</p>

While a constant number that is not the same is displayed or a constant value is displayed, press **STOP/RESET** to interrupt the execution of the verification. End will be displayed. Press **DSPL** or **ENTER** to return to the constant number display.

□ Inverter Capacity Display

The voltage class and maximum applicable motor capacity for which constants are stored in the Digital Operator are displayed.

Example: Displaying Voltage Class and Maximum Applicable Motor Capacity for Inverter whose Constants are in EEPROM in Operator

	Explanation	Operator Display
<ul style="list-style-type: none"> • Enable the setting for constants n001 to n179. 	<ul style="list-style-type: none"> • Press DSPL and PRGM will light. • Press ENTER to display the set value. • Change the set value to 4 by pressing the ↵ or ⏏ key. • Press ENTER. 	<p>n00 ! (May be a different constant number)</p> <p>! (Lit) (May be a different set value.)</p> <p>4 (Flashes)</p> <p>4 (Lit for one second.)</p> <p>↓</p> <p>n00 ! (The constant number is displayed.)</p>
<ul style="list-style-type: none"> • Execute Inverter Capacity Display (vA) using the Constant Copy Function Selection (n176). 	<ul style="list-style-type: none"> • Change the constant number to n176 by pressing the ↵ or ⏏ key. • Press ENTER to display the set value. • Change the set value to vA by pressing the ↵ or ⏏ key. • Press ENTER. • Press DSPL or ENTER. 	<p>n 176</p> <p>vA (Lit)</p> <p>vA (Lit)</p> <p>20.7 (Lit) (For 20P7)*</p> <p>n 176 (The constant number is displayed.)</p>

* The following figure shows the Inverter Capacity Display.

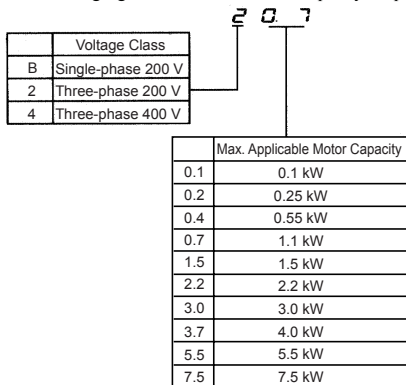

□ Software No. Display

The software number of the Inverter for which constants are stored in the Digital Operator is displayed.

Example: Displaying Software No. of Inverter for which Constants are Stored in EEPROM in Digital Operator

	Explanation	Operator Display
<ul style="list-style-type: none"> • Enable the setting for constants n001 to n179. 	<ul style="list-style-type: none"> • Press DSPL and PRGM will light. • Press ENTER to display the set value. • Change the set value to 4 by pressing the ↔ or ↵ key. • Press ENTER. 	<p>n001 (May be a different constant number)</p> <p>4 (Lit) (May be a different set value.)</p> <p>4 (Flashes)</p> <p>4 (Lit for one second.)</p> <p>↓</p> <p>n001 (The constant number is displayed.)</p>
<ul style="list-style-type: none"> • Execute Software No. Display (Sno)* using the Constant Copy Function Selection (n176). 	<ul style="list-style-type: none"> • Change the constant number to n176 by pressing the ↔ or ↵ key. • Press ENTER to display the set value. • Change the set value to Sno by pressing the ↔ or ↵ key. • Press ENTER. • Press DSPL or ENTER. 	<p>n176</p> <p>r d4 (Lit)</p> <p>Sno (Lit)</p> <p>0013 (Lit) (Software version: for example VSP010013)</p> <p>n176 (The constant number is displayed.)</p>

* Displays the lower 4 digits of the software version.

□ Display List

Operator Display	Description	Corrective Action
r dY	Lit: Constant copy function selection enabled.	-
r Ed	Lit: READ selected. Flashes: READ under execution.	-
CPY	Lit: Writing (COPY) selected. Flashes: Writing (COPY) under execution.	-
VFY	Lit: VERIFY selected. Flashes: VERIFY under execution.	-
uR	Lit: Inverter capacity display selected.	-
Sno	Lit: Software No. display selected.	-
End	Lit: READ, COPY (writing), VERIFY completed.	-
P r E	Flashes: Attempt made to execute READ while Constant Read Selection Prohibit (n177) is set to 0.	Confirm the necessity to execute READ, then set Constant Read Selection Prohibit (n177) to 1 to execute READ.
r dE	Flashes: The constant could not be read properly for READ operation. Or, a main circuit low voltage is detected during READ operation.	Confirm that the main circuit power supply voltage is correct, then re-execute READ.
CSE	Flashes: A checksum error occurred in the constant data stored in the Digital Operator.	The constants stored in the Digital Operator cannot be used. Re-execute READ to store the constants in the Digital Operator.
dPS	Flashes: The password for the connected Inverter and that for the constant data stored in the Digital Operator disagree. Example: Writing (COPY) from V7AZ to VS mini J7	Check if the Inverters are the same product series.
ndr	Flashes: No constant data stored in the Digital Operator.	Execute READ.
CPE	Flashes: Attempt made to execute writing (COPY) or VERIFY between different voltage classes or different control modes.	Check each voltage class and control mode.
CYE	Flashes: A main circuit low voltage was detected during writing (COPY) operation.	Confirm that the main circuit power supply voltage is correct, then re-execute writing (COPY).
FOY	Lit: A checksum error occurred in the constant data stored in the Inverter.	Initialize the constants. If an error occurs again, replace the Inverter due to a failure of constant memory element (EEPROM) in the Inverter.
uRE	Flashes: Attempt made to execute COPY or VERIFY between different Inverters or different capacities.	Press [ENTER] to continue the execution of COPY or VERIFY. Press [STOP] to interrupt the execution of COPY or VERIFY.

Operator Display	Description	Corrective Action
<i>.FE</i>	Flashes: A communications error occurred between the Inverter and the Digital Operator.	Check the connection between the Inverter and Digital Operator. If a communications error occurs during the READ operation or writing (COPY) operation, always re-execute the READ or COPY.

Note: While rEd, CPy, or vFy is flashing, key input on the Digital Operator is disabled. While rEd, CPy and vFy are not flashing, pressing DSPL or ENTER redisplay the constant number.

■ Customer Specific Display Scaling

Constants and Monitor Displays for Which Selection of Unit Function is Valid

Item	Contents
Frequency reference constants	Frequency References 1 to 8 (Constants n024 to n031)
	Jog Frequency Reference (Constant n032)
	Frequency References 9 to 16 (Constants n120 to n127)
Monitor display	Frequency Reference Display (FREF)
	Output Frequency Display (FOUT)
	Frequency Reference Display (U-01)
	Output Frequency Display (U-02)

Setting/Displaying Unit Selection for Frequency Reference (n035)

The frequency reference, output frequency, and the numeric data of frequency reference constants can be displayed in %, rpm, or m/min according to the set value of constant n035.

Constant No.	Constant Name	Description	Factory Setting
n035	Setting/Displaying Unit Selection for Frequency Reference	0: Units of 0.01 Hz (less than 100 Hz) 0.1 Hz (100 Hz and more) 1: Units of 0.1% 2 to 39: Units of rpm (set the number of motor poles) 40 to 3999: Any unit	0

n035 Settings

Setting	Description								
0	<ul style="list-style-type: none"> Setting unit: 0.01 Hz (below 100 Hz), 0.1 Hz (above 100 Hz) 								
1	<ul style="list-style-type: none"> Setting in units of 0.1%: 100.0% at Fmax (n011) 								
2 to 39	<ul style="list-style-type: none"> Setting in units of 1 rpm: (Set number of motor poles in n035) Display = 120 x frequency value [Hz] / number of motor poles Limits: 9999 rpm and $\text{rpm} \times \text{n035} / 120 \leq 400 \text{ Hz}$ 								
40 to 3999	<ul style="list-style-type: none"> Set the display value at 100% of frequency reference (set value of Fmax (n011)) at the 1st to 4th digits of n035. The 4th digit of n035, sets the position of decimal point. The 1st to 3rd digits of n035, sets the display value at 100% frequency reference (excluding decimal point). <p style="margin-left: 40px;">4th digit Position of decimal point</p> <table style="margin-left: 40px; border-collapse: collapse;"> <tr> <td style="padding-right: 20px;">0</td> <td>□ □ □</td> </tr> <tr> <td>1</td> <td>□ □. □</td> </tr> <tr> <td>2</td> <td>□. □ □</td> </tr> <tr> <td>3</td> <td>0. □ □ □</td> </tr> </table> <p style="margin-left: 40px;">Example: To display 20.0 at 100% of frequency reference, set n035 to 1200.</p> <ul style="list-style-type: none"> Limits: max. Display value 999 (3 lower digits of n035) 	0	□ □ □	1	□ □. □	2	□. □ □	3	0. □ □ □
0	□ □ □								
1	□ □. □								
2	□. □ □								
3	0. □ □ □								

Note: 1. The frequency reference constants and monitor display data for which this selection of the unit is valid are stored in the Inverter in units of Hz.

The units are converted as shown below:

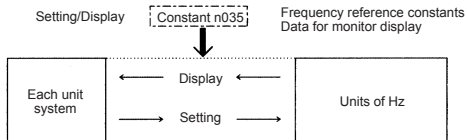

- The upper limit for each unit is the value with decimal places below the significant digits truncated.
Example: Where the upper limit for the unit Hz is as follows for 60.00 Hz and $n035 = 39$:
 $120 \times 60.00 \text{ Hz} \div 39 = 184.6$, thus 184 rpm is displayed as the upper limit.
For displays other than for the upper limit, the decimal places below the significant digits are rounded off.
- When verifying constants for the copy function, frequency reference constants (units of Hz) are used.

■ Selecting Processing for Frequency Reference Loss (n064)

Use this setting to select the processing performed if the level of the frequency reference signal from the control circuit terminals suddenly drops.

n064 Setting	Description
0	Processing for frequency reference loss disabled.
1*	Processing for frequency reference loss enabled.

* Detected in REMOTE mode (Drive mode) when analog reference (except potentiometer on Digital Operator) or pulse train reference is selected in the Frequency Reference Selection (n004).

Processing Method When 1 is Selected

If the level of the frequency reference signal drops by 90 % within 400 ms, operation continues at 80 % of the signal level before the level drop.

■ Input/Output Open-phase Detection

Constant No.	Name	Unit	Setting Range	Factory Setting
n166	Input Open-phase Detection Level	1 %	0 to 100 %* ¹ 400.0 V/100 % (200 V Class) 800.0 V/100 % (400 V Class)	0 %
n167	Input Open-phase Detection Time	1 s	0 to 255 s* ²	0 s
n168	Output Open-phase Detection Level	1 %	0 to 100 %* ¹ Inverter's rated output current/100 %	0 %
n169	Output Open-phase Detection Time	0.1 s	0.0 to 2.0 s* ²	0.0 s

* 1. Not detected when set to 0 %.

* 2. Not detected when set to 0.0 s.

The recommended settings for input open-phase detection are n166=7 % and n167=10 s.
(Open-phase cannot be detected correctly depending on the load status.)

The recommended settings for output open-phase detection are n168=5 % and n169=0.2 s.

■ Undertorque Detection

An alarm signal can be output to a multi-function output terminal (MA, MB, P1 or P2) when the load on the machine side suddenly becomes lighter (i.e., when an undertorque occurs).

To output an undertorque detection signal, set the output terminal function selection in n057, n058, or n059 to 8 (undertorque detected, NO contact) or 9 (undertorque detected, NC contact).

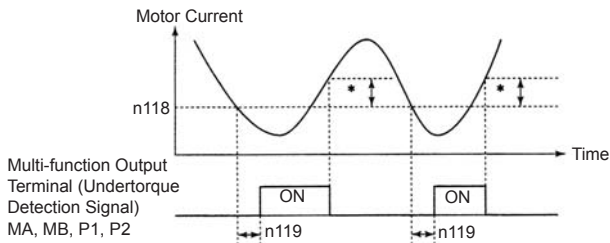

* Undertorque detection release width (hysteresis) is set at approx. 5 % of the Inverter's rated current.

Undertorque Detection Function Selection 1 (n117)

Setting	Description
0	Undertorque detection not provided.
1	Detected during constant-speed running. Operation continues after detection.
2	Detected during constant-speed running. Operation stops.
3	Detected during running. Operation continues after detection.
4	Detected during running. Operation stops.

- To detect undertorques during acceleration, set to 3 or 4.
- To continue operation after undertorque detection, set to 1 or 3.
During detection, the operation displays the "UL3" alarm (flashing).
- To halt the Inverter by a fault at undertorque detection, set to 2 or 4.
At detection, the Operation displays the "UL3" fault (continuously lit).

Undertorque Detection Level (n118)

Sets the undertorque detection current level in units of 1 %. (Inverter rated current=100 %) When detected by torque is selected, motor rated torque becomes 100 %.

Factory setting=10 %

Undertorque Detection Time (n119)

If the time for which the motor current is less than the undertorque detection level (n118) is longer than the undertorque detection time (n119), the undertorque detection function operates.

Factory setting=0.1 s

Overtorque/Undertorque Detection Function Selection 2 (n097)

When vector control mode is selected, it is possible to select whether overtorque/undertorque detection is performed by output current or output torque.

When V/f control mode is selected, the n097 setting becomes invalid, and overtorque/undertorque is detected by output current.

Setting	Description
0	Overtorque/undertorque detected by output torque.
1	Overtorque/undertorque detected by output current.

■ Using Inverter for Elevating Machines

- ⚠ CAUTION** If using an Inverter with an elevator, take safety measures on the elevator to prevent the elevator from dropping.
Failure to observe this caution may result in injury.

When using the V7AZ for elevating machines such as elevators and cranes, make sure that the brake holds and observe the following precautions for safe operation.

□ Brake ON/OFF Sequence

- For the holding brake's ON/OFF sequence, use the following Inverter output signals according to the set control mode.

NOTE Do not use "Running (Set value: 1)" for the holding brake's ON/OFF interlock signal.

Control Mode	Brake ON/OFF Signals		Brake ON/OFF Level Adjustment	
	Signal Name	Constant*2	Signal Name	Constant
V/f Control*1 (n002=0)	Frequency detection 1	n058=4	Frequency detection level	n095=2.50 Hz to 4.00 Hz*3

* 1. For Vector control (n002=1), use the same brake ON/OFF sequence with the same signals as for V/f control.

* 2. Shows the setting when a multi-function photocoupler output terminal (P1-PC) is used.

* 3. Usually, make the following settings for the frequency detection (n095):
For V/f control: Motor rated slip frequency +1 Hz
For Vector control: 2.5 Hz to 3.0 Hz

If the set value is too low, the motor torque is insufficient and the load may shift when the brake is applied. Be sure to set n095 to a value larger than that of the Minimum Output Frequency (n016) and larger than that of the braker releasing width shown in the following figure. If the set value is too large, the motor may not run smoothly when it starts running.

- For a variable speed operation by an analog signal, set the Frequency Reference Selection (n004) to a value from 2 to 4.

□ Stall Prevention during Deceleration

If connecting a braking resistor to discharge regenerative energy, be sure to set the stall prevention during deceleration (n092) to 1.



If the stall prevention during deceleration (n092) is set to the factory setting 0 (Enabled), the motor may not stop within the specified decelerating time.

The Stall Prevention during Acceleration (n093) and the Stall Prevention Level during Running (n094) should be set to their factory settings to enable these functions.

□ Settings for V/f Pattern and Motor Constants

To set the control mode and the V/f pattern, refer to the instruction manual. If the Vector control method is used, also set the motor constants.

□ Momentary Power Loss Restart and Fault Restart

Do not use the momentary power loss restart and fault restart functions in applications for elevating machines. Make sure that n081=0 and n082=0. If these functions are used, the motor coasts to a stop with the brake contact open when a momentary power loss or fault occurs during operation, possibly resulting in serious accidents.

□ I/O Open-phase Protection and Overtorque Detection

The I/O open-phase protection is only available for 5.5 kW and 7.5 kW models.

To prevent the machine from falling when the motor is open-phase or in a similar situation, enable the I/O open-phase protection (n166 to n169) and the overtorque detection (n096 to n099). At the factory, these constants are set so that these functions are disabled.

Also, take safety measures such as protection against falls on the machine.

□ Carrier Frequency

Set the carrier frequency selection (n080) to 5 kHz or more (n080: 2 to 4 or 12) to secure the motor torque even if an overcurrent occurs (the current is limited).

□ External Baseblock Signal

If the External Baseblock Command (settings 12 and 13 of n050 to n056) is input while the motor is running, the motor will immediately coast to a stop. Do not input the External Baseblock Command while the motor is running unless necessary.

If using the External Baseblock Command for an emergency stop or to start run of an interlock, make sure that the holding brake operates.

If the External Baseblock Command is input and immediately reset, the Inverter does not output voltage during the minimum baseblock time, which is 0.5 to 0.7 seconds depending on the Inverter capacity. Do not use the External Baseblock Command in an application where the motor is frequently stopped and started.

□ Acceleration/Deceleration Time

If the delay time for the holding brake's mechanical operation is not taken into consideration and the acceleration/deceleration time on the Inverter side is set to a time that is too short, an overcurrent or wear on the brakes may occur at starting or the load will shift at stopping because the holding brake does not operate on time. If so, use the S-curve characteristic function or lengthen the acceleration/deceleration time to tune the timing for the holding brake.

□ Contactor on the Inverter's Output-side

Do not install a contactor between the Inverter and the motor.

If a contactor must be installed because of local electrical codes or regulations or to operate motors with an Inverter, excluding emergencies, open or close the contactor only where the holding brake is fully closed and the Inverter is in baseblock status with the baseblock signal ON.

If the contactor is opened or closed while the Inverter is controlling the motor or DC injection braking, surge voltage or a current from the motor by full-voltage starting may cause an Inverter fault.

When a contactor is installed between the Inverter and the motor, enable the I/O open-phase protection (n166 to n169).

For more information on using Inverters exclusively for elevators or cranes, contact your OMRON representatives or the nearest OMRON sales office.

■ Using MECHATROLINK-II Communications

MECHATROLINK-II can be used with the SI-T/V7 option unit.

For details, refer to *V7AZ OPTION UNIT MECHATROLINK COMMUNICATIONS INTERFACE UNIT INSTRUCTIONS (TOBPC73060003)*.

The following constants are used for communications error settings for SI-T/V7.

Constant No.	Name	Unit	Setting Range	Factory Setting
n063	Watchdog Error Operation Selection (For SI-T/V7)	-	0 to 4	0
n114	Number of Transmission Cycle Error Detection (For SI-T/V7)	-	2 to 10	2

n063 Setting	Description
0	Coast to a stop
1	Deceleration to a stop using Deceleration Time 1 in n020.
2	Deceleration to a stop using Deceleration Time 2 in n022.
3	Continuous operation (Alarm)
4	Continuous operation (Alarm, no fault)

7 Maintenance and Inspection

WARNING

- Never touch high-voltage terminals on the Inverter. Failure to observe this warning may result in an electrical shock.
- Disconnect all power before performing maintenance or inspection, and then wait at least one minute after the power supply is disconnected. Confirm that all indicators are OFF before proceeding. If the indicators are not OFF, the capacitors are still charged and can be dangerous.
- Do not perform a withstand voltage test on any part of the V7AZ.
The Inverter is an electronic device that uses semi-conductors, and is thus vulnerable to high voltage.
- Only authorized personnel should be permitted to perform maintenance, inspection, or parts replacement.
(Remove all metal objects (watches, bracelets, etc.) before starting work.)
(Use tools which are insulated against electrical shock.)
Failure to observe these warnings may result in an electric shock.

CAUTION

- The control PCB employs CMOS ICs. Do not touch the CMOS elements. They are easily damaged by static electricity.
- Do not connect or disconnect wires, connectors, or the cooling fan while power is applied to the circuit. Failure to observe this caution may result in injury.

■ Periodic Inspection

Periodically inspect the Inverter as described in the following table to prevent accidents and to ensure high performance with high reliability.

Location to Check	Check for	Solution
Terminals, Inverter mounting screws, etc.	Improper seating or loose connections in hardware.	Properly seat and tighten hardware.
Heatsinks	Buildup of dust, dirt, and debris	Blow with dry compressed air at a pressure of 39.2×10^4 to 58.8×10^4 Pa (4 to 6 kg/cm ²).
Printed circuit boards	Accumulation of conductive material or oil mist	Blow with dry compressed air at a pressure of 39.2×10^4 to 58.8×10^4 Pa (4 to 6 kg/cm ²). If dust or oil cannot be removed, replace the Inverter.
Power elements and smoothing capacitor	Abnormal odor or discoloration	Replace the Inverter.
Cooling fan	Abnormal noise or vibration Cumulative operation time exceeding 20,000 hours	Replace the cooling fan.

■ Part Replacement

Inverter's maintenance periods are given below. Keep them as guidelines.

Part Replacement Guidelines

Part	Standard Replacement Period	Replacement Method
Cooling fan	2 to 3 years	Replace with new part.
Smoothing capacitor	5 years	Replace the Inverter unit with a new one.(Determine need by inspection.)
Breaker relays	-	Replace the Inverter unit with a new one.(Determine need by inspection.)
Fuses	10 years	Replace the Inverter unit with a new one.(Determine need by inspection.)
Aluminum capacitors on PCBs	5 years	Replace the Inverter unit with a new one.(Determine need by inspection.)

Note: Usage conditions are as follows:

- Ambient temperature: Yearly average of 30°C
- Load factor: 80% max.
- Operating rate: 12 hours max. per day

□ Replacement of Cooling Fan

Inverters of

200 V class, single-phase, 0.1 to 0.55, 2.2 and 4.0 kW,
200 V class, three-phase, 0.1 to 1.1 and 4.0 to 5.5 kW,
400 V class, three-phase, 3.0 to 7.5 kW:

1. Removal

1. Press the right and left catches on the fan cover in direction 1, and then pull them in direction 2 to remove the fan cover from the Inverter.
2. Pull the wiring in direction 3 from the fan cover rear face, and remove the protective tube and connector.
3. Open the left and right sides of the fan cover to remove the cooling fan from the cover.

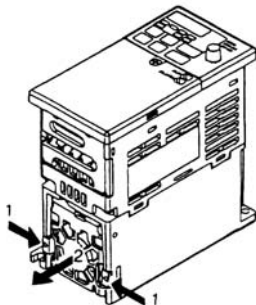

2. Mounting

1. Mount the cooling fan on the fan cover. The arrow mark to indicate the airflow direction of the cooling fan must be on the opposite side to the cover.
2. Connect the connector and mount the protective tube firmly. Mount the connector joint section on the fan cover rear face.
3. Mount the fan cover on the Inverter. Always mount the right and left catches on the fan cover on the heatsinks.

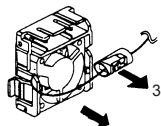

Airflow Direction

Inverters of
200 V class single-phase, 1.5 and 2.2 kW,
200 V class three-phase, 1.1 and 1.5 kW,
400 V class three-phase, 0.37 to 2.2 kW:

1. Removal

1. Remove the front cover and terminal cover, and then remove the cooling fan connector (CN10).
2. Press the right and left catches on the fan cover in direction 1, and pull the fan cover in direction 2 to remove it from the Inverter. Pull out the wiring from the cable lead-in hole at the bottom of the plastic case.
3. Open the right and left sides of the fan cover to remove the cover from the cooling fan.

2. Mounting

1. Mount the cooling fan on the fan cover. The arrow mark to indicate the airflow direction must be opposite to the cover.
2. Mount the fan cover on the Inverter. Always mount the right and left catches on the fan cover on the heatsinks. Thread in the wiring from the cable lead-in hole at the bottom of the plastic case to the inside of the Inverter.
3. Connect the wiring to the cooling fan connector (CN10) and mount the front cover and the terminal cover.

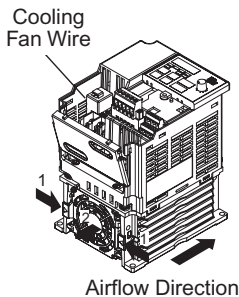

8 Fault Diagnosis

■ Protective and Diagnostic Functions

This section describes the alarm and fault displays, the fault conditions, and the corrective actions to be taken if the V7AZ

malfunctions.

Inverter alarms are classified into alarm display and fault display.

Alarm display: When a minor fault occurs in the Inverter, the Digital Operator flashes the display. In this case, the operation is continued, and restored automatically as soon as the cause is removed. Multi-function output can output the minor fault status to external devices.

Fault display: When a major fault occurs in the Inverter, the protective function operates, and the Digital Operator lights the display and shuts off the output to stop the Inverter. The fault can be output as a fault output to the external devices by multi-function output.

To reset the fault, turn ON the reset signal with the Run Command OFF or cycle the power after taking the corrective action.

* Selecting "always ON" mode at fan operation selection, the power must be cycled to release the alarm display.

□ Corrective Actions of Models with Blank Cover

1. Input fault reset or cycle the power supply OFF and ON.
2. When a fault cannot be corrected:
 - (1) Turn the power supply OFF and check the wiring and external circuit (sequence).
 - (2) Turn the power supply OFF and replace the blank cover with the Digital Operator to display faults. The faults are displayed after turning the power ON.

□ Corrective Actions of Models with Digital Operator



: ON



: Flashing







: OFF





Alarm Display





Alarm Displays and Meaning

Alarm Display		Inverter Status	Description	Causes and Corrective Actions
Digital Operator	RUN (Green) ALARM (Red)			
		Detected as an alarm only. Fault contact output is not activated.	UV (Main circuit low voltage) Main circuit DC voltage dropped below the low-voltage detection level while the Inverter output is OFF. 200 V: Main circuit DC voltage drops below approx. 200 V (160 V for single-phase). 400 V: Main circuit DC voltage dropped below approx. 400 V. (Control supply fault) Control power supply fault is detected while the Inverter output is OFF.	Check the following: <ul style="list-style-type: none"> • Power supply voltage • Main circuit power supply connections • Terminal screws: Loose? • Monitor value Confirm voltage (DC voltage) between terminals "+1" and "-". ↓ If there is no problem, the Inverter may be faulty.
			OV (Main circuit over-voltage) Main circuit DC voltage exceeded the overvoltage detection level while the Inverter output is OFF. Detection level: 200 V: approx. 410 V or more 400 V: approx. 820 V or more	Check the following: <ul style="list-style-type: none"> • Power supply voltage • Monitor value Confirm voltage (DC voltage) between terminals "+1" and "-". ↓ If there is no problem, the Inverter may be faulty.
			OH (Heatsink overheat) Intake air temperature increased while the Inverter output is OFF.	Check the following: <ul style="list-style-type: none"> • Intake air temperature. • There is no thermal source around the Inverter and oil stuck to the fan has not lowered the cooling capability. • Fan is not clogged. • No foreign matters, such as water, is inside the Inverter.
			CAL (MEMOBUS communications waiting) Correct data has not been received from the PLC when the constants n003 (Run Command Selection) is 2 or n004 (Frequency Reference Selection) is 6, and power is turned ON.	Check the following: <ul style="list-style-type: none"> • Communications devices and transmission signals. • PLC is not faulty. • Transmission cable is connected properly. • Wiring is made properly. • Any loose terminal screws do not result in improper contact.

Alarm Display		Inverter Status	Description	Causes and Corrective Actions
Digital Operator	RUN (Green) ALARM (Red)			
 Flashing		Detected as an alarm only. Fault contact output is not activated.	OH8 (Motor Overheating) The motor temperature PTC thermistor input exceeded the alarm detection level.	<ul style="list-style-type: none"> • Check the size of the load and the length of the acceleration, deceleration, and cycle times. • Check the V/f characteristics. • Check the input motor temperature.
 (Flashing)			<p>OP□ (Constant setting error when constants are set through MEMO-BUS communications)</p> <p>OP1: Two or more values are set for multi-function input selection. (constants n050 to n056)</p> <p>OP2: Relationship among V/f constants is not correct. (constants n011, n013, n014, n016)</p> <p>OP3: Setting value of motor rated current exceeds 150% of Inverter Rated Current. (constant n036)</p> <p>OP4: Upper/lower limit of frequency reference is reversed. (constants n033, n034)</p> <p>OP5: Relationship among jump frequency 1, 2 and 3 is not correct. (constants n083 to n085)</p> <p>OP6: Multi-function Analog Inputs (n077) and PID Control Selection (n128) are both set to a value other than 0.</p> <p>OP9: The setting of the Inverter capacity does not coincide with the Inverter. (Contact your OMRON representative.)</p>	Check the setting values.





Alarm Display		Inverter Status	Description	Causes and Corrective Actions
Digital Operator	RUN (Green) ALARM (Red)			
OL3 Flashing	 	Detected as an alarm only. Fault contact output is not activated.	OL3 (Overtorque detection) Motor current exceeded the preset value in constant n098. Overtorque detection level was exceeded because of increased leak current due to excessively long wiring.	<ul style="list-style-type: none"> Reduce the load, and increase the acceleration/deceleration time. Refer to the paragraph of <i>Carrier Frequency Selection (n080)</i> 14kHz max on page 94. Check the wiring (increase of current caused by rare shortcircuit, etc.).
SER Flashing			SER (Sequence error) Inverter received Local/Remote Command or communications/control circuit terminal changing signals from the multi-function terminal while the Inverter output is ON.	Check the following: <ul style="list-style-type: none"> NO/NC contact selection (constant). Wiring is made properly. Signal is not input from the PLC.
UL3 Flashing			UL3 (Undertorque detection) When V/f mode is selected: The Inverter's output current was less than the undertorque detection level (n118). When vector mode is selected: The output current or output torque was less than the detection level (n097 or n118). Operation when undertorque is detected will be determined by the setting in n117.	<ul style="list-style-type: none"> Check the setting in n118. Check the operating conditions, and remove the cause.

Alarm Display		Inverter Status	Description	Causes and Corrective Actions
Digital Operator	RUN (Green) ALARM (Red)			
<i>bb</i> Flashing	  or  	Detected as an alarm only. Fault contact output is not activated.	BB (External Baseblock) Baseblock Command at multi-function terminal is ON and the Inverter output is OFF (motor coasting). Condition is cleared when input command is removed.	Check the following: <ul style="list-style-type: none"> • NO/NC contact selection (constant). • Wiring is made properly. • Signal is not input from the PLC.
<i>EF</i> Flashing			EF (Simultaneous FWD/REV Run Commands) When FWD and REV Run Commands are simultaneously input for over 500 ms, the Inverter stops according to constant n005.	Check the following: <ul style="list-style-type: none"> • NO/NC contact selection (constant). • Wiring is made properly. • Signal is not input from the PLC.
<i>STP</i> Flashing			STP (Operator function stop)  was pressed during running via a control circuit terminal FWD/REV Run Command, or by a Run Command from communications. The Inverter stops according to constant n005. STP (Emergency stop) Inverter received emergency stop alarm signal. Inverter stops according to constant n005.	<ul style="list-style-type: none"> • Turn OFF FWD/REV Run Command of control circuit terminals. Check the following: <ul style="list-style-type: none"> • NO/NC contact selection (constant). • Wiring is made properly. • Signal is not input from the PLC.
<i>FAN</i> Flashing			FAN (Cooling fan fault) Cooling fan is locked.	Check the following: <ul style="list-style-type: none"> • Cooling fan • Cooling fan connection • Foreign matter is not interrupting rotation. • Fan is mounted correctly. • Relay connector is connected properly after replacement of the fan.

Alarm Display		Inverter Status	Description	Causes and Corrective Actions
Digital Operator	RUN (Green) ALARM (Red)			
<p><i>CE</i> Flashing</p> <p><i>FBL</i> Flashing</p> <p><i>bus</i> Flashing</p> <p><i>OH3</i> Flashing</p>	  or  	Detected as an alarm only. Fault contact output is not activated.	CE (MEMOBUS) communications fault	Check the following: <ul style="list-style-type: none"> • Communication devices or communication signals. • PLC is not faulty. • Transmission cable is connected properly. • Any loose terminal screws do not result in improper contact. • Wiring is made properly.
		FBL (PID feedback loss detection) PID feedback value dropped below the detection level (n137). When PID feedback loss is detected, the Inverter operates according to the n136 setting.	Check the mechanical system and correct the cause, or increase the value of n137.	
		Option card communications fault. <ul style="list-style-type: none"> • Communication fault has occurred in a mode where the communications option card was used and a Run Command or frequency reference was input from the PLC. • Communication fault has occurred in a mode where a Run Command and frequency reference are set from the communication option card. 	Check the following: <ul style="list-style-type: none"> • Communications devices or communications signals. • PLC is not faulty. • Transmission cable is connected properly. • Any loose terminal screws do not result in improper contact. • Wiring is made properly. • Communication option card is inserted correctly. 	
		OH3 (Inverter overheat alarm) The Inverter overheat alarm (OH3) was input from a multi-function input terminal (S1 and S7).	<ul style="list-style-type: none"> • Clear the multi-function input terminal's Inverter overheat alert input. • Check that the wiring is made properly. • Check that a signal is not input from the PLC. 	

Fault Display

Fault Displays and Meanings

Fault Display		Inverter Status	Description	Causes and Corrective Actions
Digital Operator	RUN (Green) ALARM (Red)			
		Protective Operation Output is turned OFF and motor coasts to a stop.	OC (Overcurrent) Inverter output current momentarily exceeded approx. 250% of rated current.	<p>Operation is restored, if no fault is found, after confirming the following:</p> <ul style="list-style-type: none"> • Short circuit or grounding at Inverter output side • Excessive load GD² • Extremely rapid Acceleration/Deceleration Time (constants n019 to n022) • Special motor used • Starting motor during coasting • Motor of a capacity greater than the Inverter rating has been started. • Magnetic contactor opened/closed at the Inverter output side • Leak current increased because of excessively long wiring <p>Note: Before turning the power ON again, make sure that no short-circuit or ground fault occurs at the Inverter output.</p>
			GF (Grounding) *1 *2 Grounding current exceeded approx. 50% of Inverter rated output current at the Inverter output side.	<p>Inverter output grounded.</p> <p>↓</p> <p>Check the cause, and restore the operation.</p> <p>Note: Before turning the power ON again, make sure that no short-circuit or ground fault occurs at the Inverter output.</p>
			SC (Load shortcircuit) *1 Inverter output or load short-circuited.	<p>Inverter output shortcircuited or grounded.</p> <p>↓</p> <p>Check the cause, and restore the operation.</p>

* 1. Indicates that an Inverter of 5.5 kW and 7.5 kW (200 V and 400 V Classes) is attached.



* 2. The ground fault here is one which occurs in the motor wiring while the motor is running. A ground fault may not be detected in the following cases.

- A ground fault with low resistance which occurs in motor cables or terminals.
- A ground fault occurs when the power is turned ON.

Fault Display		Inverter Status	Description	Causes and Corrective Actions
Digital Operator	RUN (Green) ALARM (Red)			
<i>OU</i>		Protective Operation Output is turned OFF and motor coasts to a stop.	OV (Main circuit over-voltage) Main circuit DC voltage level exceeded the overvoltage detection level while the Inverter was running. Detection level (DC voltage: Voltage between terminals "+1" and "-") 200 V: Approx. 410 V or more 400 V: Approx. 820 V or more	1. Regenerative energy is large. <ul style="list-style-type: none"> The setting of deceleration time is too short. Negative load (e.g., elevator) is excessive at lowering. • Confirm that the load does not have any problem. 2. Input voltage is erroneous. Confirm that DC voltage exceeding the left value is not input.
<i>UV1</i>			UV1 (Main circuit low voltage) Main circuit DC voltage dropped below the low-voltage detection level while the Inverter output is ON. 200 V: Stops at main circuit DC voltage below approx. 200 V (160 V for single-phase) 400 V: Stops at main circuit DC voltage below approx. 400 V.	Check the following: <ul style="list-style-type: none"> Power supply voltage Main circuit power supply connections Terminal screws: Loose? Monitor value Confirm voltage (DC voltage) between terminals "+1" and "-". ↓ If there is no problem, the Inverter may be faulty.
<i>UV2</i>			UV2 (Control power supply fault) Inverter detected voltage fault of control power supply during running.	Replace the Inverter.

Fault Display		Inverter Status	Description	Causes and Corrective Actions
Digital Operator	RUN (Green) ALARM (Red)			
OH	● ☀	Protective Operation Output is turned OFF and motor coasts to a stop.	OH (Heatsink overheat) Temperature increased because of Inverter overload operation or intake air temperature rise.	<ul style="list-style-type: none"> Excessive load Improper V/f pattern setting Insufficient acceleration time if the fault occurs during acceleration Intake air temperature exceeding 50°C (122°F) Cooling fan stops. Cooling fan has lowered cooling capability or stops. Heatsink is clogged. There is a thermal source around the Inverter <p style="text-align: center;">↓</p> Check the following: <ul style="list-style-type: none"> Load size V/f pattern setting (constants n011 to n017) Intake air temperature. Cooling fan is turning while the Inverter is running. Foreign matter on the fan is not interrupting rotation. Fan is mounted properly. There is no thermal source around the Inverter.
OH9			OH9 (Motor overheating)	<ul style="list-style-type: none"> Check the size of the load and the length of the acceleration, deceleration, and cycle times. Check the V/f characteristics. Check the input motor temperature.
RH			RH (Externally-mounting-type braking resistor overheat) * Protection of externally mounting-type braking resistor operated.	<ul style="list-style-type: none"> Insufficient deceleration time Excessive motor regenerative energy <p style="text-align: center;">↓</p> <ul style="list-style-type: none"> Increase deceleration time Reduce regenerative load







* Indicates that an Inverter of 5.5 kW and 7.5 kW (200 V and 400 V Classes) is attached.

Fault Display		Inverter Status	Description	Causes and Corrective Actions
Digital Operator	RUN (Green) ALARM (Red)			
OL1	 	Protective Operation Output is turned OFF and motor coasts to a stop.	OL1 (Motor overload) Motor overload protection operated by built-in electronic thermal overload relay.	<ul style="list-style-type: none"> • Check the load size or V/f pattern setting (constants n011 to n017). • Set the motor rated current shown on the nameplate in constant n036. • Check that the settings of motor protection (whether motor cooling method is self-cooled or fan-cooled) and motor protection time constant are made correctly. • Check the load size, V/f set value, operation pattern, etc. to confirm that the load is not excessive under actual operation. • Recheck the item of motor protection and set the constants again if necessary. • Refer to <i>Carrier Frequency Selection (n080)14kHz max</i> on page 94. • Check the wiring (increase of current caused by rare shortcircuit, etc.).
OL2			OL2 (Inverter overload) Inverter overload protection operated by built-in electronic thermal overload relay.	<ul style="list-style-type: none"> • Check the load size or V/f pattern setting (constants n011 to n017). • Check the Inverter capacity. • Check the load size, V/f set value, operation pattern, etc. to confirm that the load is not excessive under actual operation. • Refer to <i>Carrier Frequency Selection (n080)14kHz max</i> on page 94. • Check the wiring (increase of current caused by rare shortcircuit, etc.).

Fault Display		Inverter Status	Description	Causes and Corrective Actions
Digital Operator	RUN (Green) ALARM (Red)			
OL3		Protective Operation Output is turned OFF and motor coasts to a stop.	OL3 (Over torque detection) V/f mode: Inverter output current exceeded the preset value in constant n098. Vector mode: Motor output current or torque exceeded the preset value in constants n097 and n098. When over torque is detected, Inverter performs operation according to the preset setting of constant n096.	<ul style="list-style-type: none"> Check the driven machine and correct the cause of the fault, or increase the value of constant n098 up to the highest value allowed for the machine. Check the load size, V/f set value, operation pattern, etc. to confirm that the load is not excessive under actual operation. Refer to <i>Carrier Frequency Selection (n080) 14kHz max</i> on page 94. Check the wiring (increase of current caused by rare shortcircuit, etc.).
PF	● 		PF (Main circuit voltage fault) The main circuit's DC voltage oscillated in an irregular way when not in regenerative operation.	<ul style="list-style-type: none"> Open phase of input supply Momentary power loss Excessive fluctuation in input supply voltage Unbalanced line voltage ↓ Check the following: <ul style="list-style-type: none"> Main circuit power supply connections Power supply voltage Terminal screws: Loose?
LF			LF (Output open phase) An open phase occurred in Inverter output.	<ul style="list-style-type: none"> Disconnection in output cable Disconnection in motor windings Loose output terminal screws ↓ Check the following: <ul style="list-style-type: none"> Disconnection in output wiring Motor impedance Terminal screws: Loose?

Fault Display		Inverter Status	Description	Causes and Corrective Actions
Digital Operator	RUN (Green) ALARM (Red)			
UL3		Protective Operation Output is turned OFF and motor coasts to a stop.	UL3 (Undertorque detection) When V/f mode is selected: The Inverter's output current was less than the Undertorque Detection Level (n118). When vector mode is selected: The output current or output torque was less than the detection level (n097 to n118). Operation when undertorque is detected will be determined by the setting in n117.	<ul style="list-style-type: none"> Check the setting in n118. Check the operating conditions, and remove the cause.
EF□	● ☀		EF□ (External fault) Inverter receives an external fault input from control circuit terminal. EF0: External fault reference through MEMOBUS communications EF1: External Fault Input Command from control circuit terminal S1 EF2: External Fault Input Command from control circuit terminal S2 EF3: External Fault Input Command from control circuit terminal S3 EF4: External Fault Input Command from control circuit terminal S4 EF5: External Fault Input Command from control circuit terminal S5 * EF6: External Fault Input Command from control circuit terminal S6 * EF7: External Fault Input Command from control circuit terminal S7	Check the following: <ul style="list-style-type: none"> NO/NC contact selection (constant). Wiring is made properly. Signal is not input from the PLC.
FP0			CPF-00 Inverter cannot communicate with the Digital Operator for 5 s or more when power is turned ON.	Cycle power after confirming that the Digital Operator is securely mounted. If the fault remains, replace the Digital Operator or Inverter.
FP1			CPF-01 Transmission fault occurred for 5 s or more when transmission starts with the Digital Operator.	Cycle power after confirming that the Digital Operator is securely mounted. If the fault remains, replace the Digital Operator or Inverter.
FP4			CPF-04 EEPROM fault of Inverter control circuit was detected.	<ul style="list-style-type: none"> Record all constant data and initialize the constants. (Refer to page 53.) Cycle power. If the fault remains, replace the Inverter.

Fault Display		Inverter Status	Description	Causes and Corrective Actions	
Digital Operator	RUN (Green) ALARM (Red)				
F05		Protective Operation Output is turned OFF and motor coasts to a stop.	CPF-05 AD converter fault was detected.	Cycle power. If the fault remains, replace the Inverter.	
F06			CPF-06 <ul style="list-style-type: none"> Option card connection fault A non-corresponding option card is connected. 	<ul style="list-style-type: none"> Cycle power to the Inverter after checking the connection of the Communication option card. Verify Software Version No. (n179). Check the applicable Inverter software number that is listed in the instruction manual of the Communications Option Card. 	
F07			CPF-07 Operator control circuit (EEPROM or AD converter) fault	Cycle power after checking that the Digital Operator is securely mounted. If the fault remains, replace the Digital Operator or Inverter.	
F11			CPF-11 Combination error	Control circuit is not combined with correct software. (Contact your OMRON representative.)	
F21			Communication option card self-diagnostic error	<ul style="list-style-type: none"> Option card fault. Replace the option card. Confirm that no foreign matter is on the Communications Option Card. 	
F22			Communication option card model code error		
F23			Communication option card DPRAM error		
OPr				OPR (Operator connecting fault)	Cycle power. If the fault remains, replace the Inverter.
CE				CE (MEMOBUS communications fault)	Check the following: <ul style="list-style-type: none"> Communications devices or communications signals. PLC is not faulty. Transmission cable is connected properly. Any loose terminal screws do not result in improper contact. Wiring is made properly.

Fault Display		Inverter Status	Description	Causes and Corrective Actions
Digital Operator	RUN (Green) ALARM (Red)			
<i>SFP</i>		Stops according to constant.	STP (Emergency stop) The Inverter stopped according to constant n005 after receiving the emergency stop fault signal.	Check the following: <ul style="list-style-type: none"> • NO/NC contact selection (constant). • Wiring is made properly. • Signal is not input from the PLC.
<i>FBL</i>	  or 		FBL (PID feedback loss detection) PID feedback value dropped below the detection level. When PID feedback loss is detected, the Inverter operates according to the n136 setting.	Check the mechanical system and correct the cause, or increase the value of n137.
<i>BUS</i>	 		Option card communications fault A communication error occurred in the mode where the communication option card was used and a Run Command or frequency reference was input from the PLC.	Check the following: <ul style="list-style-type: none"> • Communications devices or communications signals. • PLC is not faulty. • Transmission cable is connected properly. • Wiring is made properly. • Any loose terminal screws do not result in improper contact. • Communication option card is not inserted correctly.
— (OFF)	 	Protective Operation Output is turned OFF and motor coasts to a stop.	<ul style="list-style-type: none"> • Insufficient power supply voltage • Control power supply fault • Hardware fault 	Check the following: <ul style="list-style-type: none"> • Power supply voltage • Main circuit power supply connections • Terminal screws: Loose? • Control sequence. • Replace the Inverter.

* To display or clear the fault history, refer to page 49.

Errors Occurring during Autotuning

Indication	Meaning	Cause	Corrective Action
E02	Alarm	An alarm (XXX) was detected during tuning.	<ul style="list-style-type: none"> • Check input data. • Check wiring and the machine environment. • Check the load.
E03	STOP key input	The STOP key was pressed during tuning and tuning was cancelled.	—
E04	Resistance error	<ul style="list-style-type: none"> • Tuning was not completed in the specified time. • Tuning results were outside the setting range for constants. 	<ul style="list-style-type: none"> • Check input data. • Check motor wiring. • Disconnect the motor from the machine system if connected during rotational autotuning. • Change the Maximum Voltage if the Maximum Voltage is higher than the Inverter input power supply voltage.
E05	No-load current error		
E09	Acceleration error	The motor did not accelerate in the specified time.	<ul style="list-style-type: none"> • Increase Acceleration Time 1 (n019). • If Stall Prevention Level during Acceleration (n093) has been lowered, return it to the initial value. • Disconnect the motor from the machine system, if connected.
E12	Current detection error	<ul style="list-style-type: none"> • Current flow exceeded motor rated current. • The sign of the detected current was reversed. • At least one of phases U, V, and W is open. 	Check the current detection circuit, motor wiring, and current detector installation.

■ Troubleshooting

Trouble	Cause	Corrective Actions
The motor does not operate when an external operation signal is input.	The operation method selection is wrong. The RUN command (n003) is not set to Control Circuit Terminal.	Set the RUN command (n003) to Control Circuit Terminal.
	A 3-wire sequence is in effect. The Multi-function Input Selection (n052) is set to 3-wire sequence, and the S2 control terminal is not closed.	To use a 3-wire sequence, make the wiring so that the S2 control terminal is closed. To use a 2-wire sequence, set the Multi-function Input (n052) to a value other than 3-wire sequence.
	The frequency reference is too low. The input frequency reference is lower than the setting for the Min. Output Frequency (n016).	Input a frequency reference greater than the Min. Output Frequency (n016).
	Local mode is in effect.	Set the LO/RE selection of the Digital Operator to RE.
	The V-I SW (SW2) setting is wrong. Example: The reference 4 to 20 mA is input, but SW2 is set to "V."	For analog input, make sure that the Frequency Reference (n004) and SW2 settings are correct.
	The setting of NPN/PNP switch (SW1) is not correct.	Set SW1 correctly.
	Program mode is enabled.	Press [DSPL] to make [FREF] flash and change to Drive mode.
The motor stops. The torque is not output.	The stall prevention level during acceleration is too low. Because the Stall Prevention Level during Acceleration (n093) is set too low, the output current reaches the set level, the output frequency is stopped, and the acceleration time is lengthened.	Check if the Stall Prevention Level during Acceleration (n093) is set to an appropriate value.
	The stall prevention level during running is too low. Because the Stall Prevention Level during Running (n094) is set too low, the output current reaches the set level, and the speed drops.	Check if the Stall Prevention Level during Running (n094) is set to an appropriate value.
	The load is too heavy. If the load is too heavy, stall prevention is activated, the output frequency is stopped, and the acceleration time is lengthened.	<ul style="list-style-type: none"> Lengthen the set acceleration time (n019). Reduce the load.
	When the maximum frequency (n011) was changed, the maximum voltage frequency (n013) was also changed.	To increase the speed of a general-purpose motor, only change the maximum frequency (n011).
	The V/f set value is too low.	Set the V/f (n011 to n017) according to the load characteristics.

Trouble	Cause	Corrective Actions
The motor speed is unstable. The motor speed fluctuates when operating with a light load.	The stall prevention level during running is too low. Because the Stall Prevention Level during Running (n094) is too low, the output current reaches the set level and the speed drops.	Check if the Stall Prevention Level during Running (n094) is set to an appropriate value.
	The load is too heavy. If the load is too heavy, stall prevention is activated, the output frequency is stopped, and the acceleration time is lengthened.	Reduce the load.
	The carrier frequency is too high. If operating the motor with a light load, a high carrier frequency may cause the motor speed to fluctuate.	Decrease the carrier frequency (n080).
	The V/f set value is too high for a low-speed operation. Because the set value for the V/f is too high, over-excitation occurs at low speeds.	Set the V/f (n011 to n017) according to the load characteristics.
	The maximum frequency (n011) and maximum voltage frequency (n013) were incorrectly adjusted. Example: To operate a 60-Hz motor at 40 Hz or less, the maximum frequency and base frequency are set to 40 Hz.	Set the maximum frequency (n011) and the maximum voltage frequency (n013) according to the motor specifications.
	The Inverter is used for an operation at 1.5 Hz or less.	Do not use the V7 Inverter for an operation that runs at 1.5 Hz or less. For an operation at 1.5 Hz or less, use a different Inverter model.
	The analog reference input is unstable and has noise interference.	Increase the set value for the filter time constant (n062).
The LED of the Digital Operator is unlit.	The power is not being supplied. The breaker or other component on the power input side is not turned ON, and the power is not being supplied.	Check if the power is being supplied.
	Because the Digital Operator is not correctly mounted, the display does not appear.	Mount the Digital Operator correctly.
	Short-circuit bar for terminals +1 and +2 is not connected.	Confirm that the short-circuit bar is connected properly.
	POWER charge indicator lamp lights but the Digital Operator does not give any display after the power supply is turned ON.	Since the main circuit fuse is blown, replace the Inverter.

9 Specifications

■ Standard Specifications (200 V Class)

Voltage Class		200 V single-/3-phase									
Model CIMR- V7AZ□□ □□	3-phase	20P1	20P2	20P4	20P7	21P5	22P2	24P0	25P5	27P5	
	Single-phase	B0P1	B0P2	B0P4	B0P7	B1P5	B2P2	B4P0	-	-	
Max. Applicable Motor Output kW ¹		0.1	0.25	0.55	1.1	1.5	2.2	4.0	5.5	7.5	
Output Characteristics	Inverter Capacity (kVA)	0.3	0.6	1.1	1.9	3.0	4.2	6.7	9.5	13	
	Rated Output Current (A)	0.8	1.6	3	5	8	11	17.5	25	33	
	Max. Output Voltage (V)	3-phase, 200 to 230 V (proportional to input voltage) Single-phase, 200 to 240 V (proportional to input voltage)									
	Max. Output Frequency (Hz)	400 Hz (Programmable)									
Power Supply	Rated Input Voltage and Frequency	3-phase, 200 to 230 V, 50/60 Hz Single-phase, 200 to 240 V, 50/60 Hz									
	Allowable Voltage Fluctuation	-15% to +10%									
	Allowable Frequency Fluctuation	±5%									

Voltage Class		200 V single-/3-phase								
Model CIMR- V7AZ□□ □□	3-phase	20P1	20P2	20P4	20P7	21P5	22P2	24P0	25P5	27P5
	Single-phase	B0P1	B0P2	B0P4	B0P7	B1P5	B2P2	B4P0	-	-
Control Characteristics	Control Method	Sine wave PWM (V/f control/vector control selectable)								
	Frequency Control Range	0.1 to 400 Hz								
	Frequency Accuracy (Temperature Change)	Digital reference: $\pm 0.01\%$ (-10 to 50°C) Analog reference: $\pm 0.5\%$ ($25 \pm 10^{\circ}\text{C}$)								
	Frequency Setting Resolution	Digital reference: 0.01 Hz (less than 100 Hz)/0.1 Hz (100 Hz or more) Analog reference: 1/1000 of max. output frequency								
	Output Frequency Resolution	0.01 Hz								
	Overload Capacity	150% rated output current for one minute								
	Frequency Reference Signal	0 to 10 VDC (20 k Ω), 4 to 20 mA (250 Ω), 0 to 20 mA (250 Ω) pulse train input, frequency setting potentiometer (Selectable)								
	Acceleration/Deceleration Time	0.00 to 6000 s (Acceleration/deceleration time are independently programmed.)								
	Braking Torque	Short-term average deceleration torque ^{*2} 0.1, 0.25 kW (0.13 HP, 0.25 HP): 150% or more 0.55, 1.1 kW (0.5 HP, 1 HP): 100% or more 1.5 kW (2 HP): 50% or more 2.2 kW (3 HP) or more: 20% or more Continuous regenerative torque: Approx. 20% (150% with optional braking resistor, braking transistor built-in)								
	V/f Characteristics	Possible to program any V/f pattern								

Voltage Class		200 V single-/3-phase									
Model CIMR- V7AZ□□ □□	3-phase	20P1	20P2	20P4	20P7	21P5	22P2	24P0	25P5	27P5	
	Single-phase	B0P1	B0P2	B0P4	B0P7	B1P5	B2P2	B4P0	-	-	
Protective Functions	Motor Overload Protection	Electronic thermal overload relay									
	Instantaneous Over-current	Motor coasts to a stop at approx. 250% or more of Inverter rated current									
	Overload	Motor coasts to a stop after 1 minute at 150% of Inverter rated output current									
	Overvoltage	Motor coasts to a stop if DC bus voltage exceeds 410 V									
	Undervoltage	Stops when DC bus voltage is approx. 200 V or less (approx. 160 V or less for single-phase series).									
	Momentary Power Loss	The following items are selectable: Not provided (stops if power loss is 15 ms or longer), continuous operation if power loss is approx. 0.5 s or shorter, continuous operation.									
	Heatsink Overheat	Protected by electronic circuit.									
	Stall Prevention Level	Can be set to individual levels during acceleration/constant-speed operation, provided/not provided available during deceleration.									
	Cooling Fan Fault	Protected by electronic circuit (fan lock detection).									
	Ground Fault ^{*4}	Protected by electronic circuit (overcurrent level). ^{*3}									
Power Charge Indication	ON until the DC bus voltage becomes 50 V or less. RUN indicator stays ON or Digital Operator indicator stays ON.										
Output Functions	Input Signals	Multi-function Input	Seven of the following input signals are selectable: Forward Run Command, Reverse Run Command, Forward/Reverse Run (3-wire sequence) Command, Fault Reset, external fault, multi-step speed operation, Jog Command, acceleration/deceleration time select, External Baseblock, Speed Search Command, Acceleration/Deceleration Hold Command, LOCAL/REMOTE selection, communication/control circuit terminal selection, emergency stop fault, emergency stop alarm, Up/Down Command, self-test, PID control cancel, PID integral reset/hold, Inverter overheat alarm								
	Output Signals	Multi-function Output ^{*5}	The following output signals are selectable (1 NO/NC contact output, 2 photocoupler outputs): Fault, running, zero speed, frequency agree, frequency detection, over-torque detection, undervoltage detection, minor error, baseblock, operating mode, Inverter run ready, fault retry, UV, speed search, data output through communications, PID feedback loss detection, frequency reference loss, Inverter overheat alarm								
	Standard Functions		Voltage vector control, full-range automatic torque boost, slip compensation, DC injection braking current/time at startup/stop, frequency reference bias/gain, MEMOBUS communications (RS-485/422, max. 19.2 kbps), PID control, energy-saving control, constant copy, frequency reference with built-in potentiometer, unit selection for frequency reference setting/display, multi-function analog input								

Voltage Class		200 V single-/3-phase									
Model CIMR- V7AZ□□□ □□	3-phase	20P1	20P2	20P4	20P7	21P5	22P2	24P0	25P5	27P5	
	Single-phase	B0P1	B0P2	B0P4	B0P7	B1P5	B2P2	B4P0	-	-	
Other Functions	Indications	Status Indicators	RUN and ALARM provided as standard indicators								
		Digital Operator (JVOP-140)	Provided for monitor frequency reference, output frequency, output current								
	Terminals	Main circuit: screw terminals Control circuit: plug-in screw terminal									
	Wiring Distance between Inverter and Motor	100 m (328 ft) or less ⁶									
Enclosure		Open chassis (IP20, IP00) ⁷ , or enclosed wall-mounted NEMA 1 (TYPE 1) ⁸									
Cooling Method		Cooling fan is provided for the following models: 200 V, 0.75 kW or larger Inverters (3-phase) 200 V, 1.5 kW or larger Inverters (single-phase) Other models are self-cooling.									
Environmental Condi-	Ambient Temperature	Open chassis (IP20, IP00): -10 to 50 °C (14 to 122 °F) and enclosed wall-mounted NEMA 1 (TYPE 1): -10 to 40 °C (14 to 105 °F) (not frozen)									
	Humidity	95% or less (non-condensing)									
	Storage Temperature ⁹	-20 to 60 °C (-4 to 140 °F)									
	Location	Indoor (free from corrosive gases or dust)									
	Elevation	1,000 m (3,280 ft) or less									
	Vibration	Up to 9.8 m/s ² (1G) at 10 to less than 20 Hz, up to 2 m/s ² (0.2G) at 20 to 50 Hz									

- * 1. Based on a standard 4-pole motor for max. applicable motor output.
- * 2. Shows deceleration torque for uncoupled motor decelerating from 60 Hz with the shortest possible deceleration time.
- * 3. The operation level becomes approx. 50% of Inverter rated output current in case of Inverters of 5.5 kW or 7.5 kW.
- * 4. The ground fault here is one which occurs in the motor wiring while the motor is running. A ground fault may not be detected in the following cases.
 - A ground fault with low resistance which occurs in motor cables or terminals.
 - A ground fault occurs when the power is turned ON.
- * 5. Minimum permissible load: 5 VDC, 10 mA (as reference value)
- * 6. For details, refer to "Carrier Frequency Selection (n080)14kHz max" on page 94.

- * 7. 0P1 to 3P7 are of IP20. Be sure to remove the top and bottom covers when Inverter 5P5 or 7P5 of open chassis mounting type is used.
- * 8. NEMA 1 of 0P1 to 3P7 is optional, while NEMA 1 of 5P5 and 7P5 is provided as standard.
- * 9. Temperature during shipping (for short period).

■ Standard Specifications (400 V Class)

Voltage Class		400 V 3-phase									
Model CIMR- V7AZ□ □□□	3-phase	40P2	40P4	40P7	41P5	42P2	43P0	44P0	45P5	47P5	
	Single-phase	-	-	-	-	-	-	-	-	-	
Max. Applicable Motor Output kW ¹		0.37	0.55	1.1	1.5	2.2	3.0	4.0	5.5	7.5	
Output Characteristics	Inverter Capacity (kVA)	0.9	1.4	2.6	3.7	4.2	5.5	7.0	11	14	
	Rated Output Current (A)	1.2	1.8	3.4	4.8	5.5	7.2	9.2	14.8	18	
	Max. Output Voltage (V)	3-phase, 380 to 460 V (proportional to input voltage)									
	Max. Output Frequency (Hz)	400 Hz (Programmable)									
Power Supply	Rated Input Voltage and Frequency	3-phase, 380 to 460 V, 50/60 Hz									
	Allowable Voltage Fluctuation	-15 to +10%									
	Allowable Frequency Fluctuation	±5%									

Voltage Class		400 V 3-phase								
Model CIMR- V7AZ□ □□□	3-phase	40P2	40P4	40P7	41P5	42P2	43P0	44P0	45P5	47P5
	Single-phase	-	-	-	-	-	-	-	-	-
Control Characteristics	Control Method	Sine wave PWM (V/f control/vector control selectable)								
	Frequency Control Range	0.1 to 400 Hz								
	Frequency Accuracy (Temperature Change)	Digital reference: $\pm 0.01\%$, -10 to $50\text{ }^{\circ}\text{C}$ (14 to $122\text{ }^{\circ}\text{F}$) Analog reference: $\pm 0.5\%$, $25\pm 10\text{ }^{\circ}\text{C}$ (59 to $95\text{ }^{\circ}\text{F}$)								
	Frequency Setting Resolution	Digital reference: 0.01 Hz (less than 100 Hz)/0.1 Hz (100 Hz or more) Analog reference: 1/1000 of max. output frequency								
	Output Frequency Resolution	0.01 Hz								
	Overload Capacity	150% rated output current for one minute								
	Frequency Reference Signal	0 to 10 VDC (20 k Ω), 4 to 20 mA (250 Ω), 0 to 20 mA (250 Ω) pulse train input, frequency setting potentiometer (Selectable)								
	Acceleration/Deceleration Time	0.00 to 6000 s (Acceleration/deceleration time are independently programmed.)								
	Braking Torque	Short-term average deceleration torque ^{*2} 0.2 kW: 150% or more 0.75 kW: 100% or more 1.5 kW (2 HP): 50% or more 2.2 kW (3 HP) or more: 20% or more Continuous regenerative torque: Approx. 20% (150% with optional braking resistor, braking transistor built-in)								
	V/f Characteristics	Possible to program any V/f pattern								
Protective Functions	Motor Overload Protection	Electronic thermal overload relay								
	Instantaneous Overcurrent	Motor coasts to a stop at approx. 250% or more of Inverter rated current								
	Overload	Motor coasts to a stop after 1 minute at 150% of Inverter rated output current								
	Overvoltage	Motor coasts to a stop if DC bus voltage exceeds 820 V								
	Undervoltage	Stops when DC bus voltage is approx. 400 V or less								
	Momentary Power Loss	The following items are selectable: Not provided (stops if power loss is 15 ms or longer), continuous operation if power loss is approx. 0.5 s or shorter, continuous operation.								
	Heatsink Overheat	Protected by electronic circuit.								
	Stall Prevention Level	Can be set to individual levels during acceleration/constant-speed operation, provided/not provided available during deceleration.								
	Cooling Fan Fault	Protected by electronic circuit (fan lock detection).								
	Ground Fault ^{*4}	Protected by electronic circuit (overcurrent level). ^{*3}								
Power Charge Indication	ON until the DC bus voltage becomes 50 V or less. Charge LED is provided.									

Voltage Class		400 V 3-phase									
Model CIMR- V7AZ□ □□□	3-phase	40P2	40P4	40P7	41P5	42P2	43P0	44P0	45P5	47P5	
	Single-phase	-	-	-	-	-	-	-	-	-	
Output Functions	Input Signals	Seven of the following input signals are selectable: Forward Run Command, Reverse Run Command, Forward/Reverse Run (3-wire sequence) Command, Fault Reset, external fault, multi-step speed operation, Jog Command, acceleration/deceleration time select, External Baseblock, Speed Search Command, Acceleration/Deceleration Hold Command, LOCAL/REMOTE selection, communication/control circuit terminal selection, emergency stop fault, emergency stop alarm, Up/Down Command, self-test, PID control cancel, PID integral reset/hold, Inverter overheat alarm									
	Output Signals	The following output signals are selectable (1 NO/NC contact output, 2 photocoupler outputs): Fault, running, zero speed, frequency agree, frequency detection, over-torque detection, undertorque detection, minor error, baseblock, operating mode, Inverter run ready, fault retry, UV, speed search, data output through communications, PID feedback loss detection, frequency reference loss, Inverter overheat alarm									
	Standard Functions	Voltage vector control, full-range automatic torque boost, slip compensation, DC injection braking current/time at startup/stop, frequency reference bias/gain, MEMOBUS communications (RS-485/422, max. 19.2 kbps), PID control, energy-saving control, constant copy, frequency reference with built-in potentiometer, unit selection for frequency reference setting/display, multi-function analog input									
Other Functions	Indications	Status Indicators	RUN and ALARM provided as standard indicators								
		Digital Operator (JVOP-140)	Monitor frequency reference, output frequency, and output current provided.								
	Terminals	Main circuit: screw terminals Control circuit: plug-in screw terminal									
	Wiring Distance between Inverter and Motor	100 m (328 ft) or less ⁶									
Enclosure		Open chassis (IP20, IP00) ¹⁷ , or enclosed wall-mounted NEMA 1 (TYPE 1) ¹⁸									
Cooling Method		Cooling fan is provided for the following models: 400 V, 1.5 kW or larger Inverters (3-phase) Other models are self-cooling.									
Environmental Condi-	Ambient Temperature	Open chassis (IP20, IP00): -10 to 50 °C (14 to 122 °F) Enclosed wall-mounted NEMA 1 (TYPE 1): -10 to 40 °C (14 to 105°F) (not frozen)									
	Humidity	95 % or less (non-condensing)									
	Storage Temperature ¹⁹	-20 to 60 °C (-4 to 140 °F)									
	Location	Indoor (free from corrosive gases or dust)									
	Elevation	1,000 m (3,280 ft) or less									
	Vibration	Up to 9.8 m/s ² (1G) at 10 to less than 20 Hz, up to 2 m/s ² (0.2G) at 20 to 50 Hz									

-
- * 1. Based on a standard 4-pole motor for max. applicable motor output.
 - * 2. Shows deceleration torque for uncoupled motor decelerating from 60 Hz with the shortest possible deceleration time.
 - * 3. The operation level becomes approx. 50% of Inverter rated output current in case of Inverters of 5.5 kW or 7.5 kW.
 - * 4. The ground fault here is one which occurs in the motor wiring while the motor is running. A ground fault may not be detected in the following cases.
 - A ground fault with low resistance which occurs in motor cables or terminals.
 - A ground fault occurs when the power is turned ON.
 - * 5. Minimum permissible load: 5 VDC, 10 mA (as reference value)
 - * 6. For details, refer to “Carrier Frequency Selection (n080)14kHz max” on page 94.
 - * 7. 0P1 to 3P7 are of IP20. Be sure to remove the top and bottom covers when Inverter 5P5 or 7P5 of open chassis mounting type is used.
 - * 8. NEMA 1 of 0P1 to 3P7 is optional, while NEMA 1 of 5P5 and 7P5 is provided as standard.
 - * 9. Temperature during shipping (for short period).

Standard Wiring

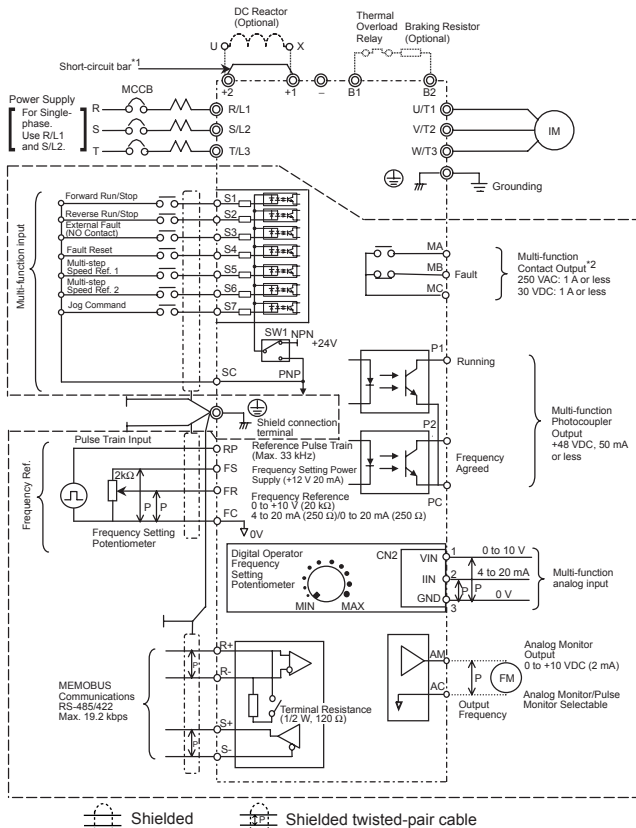

⋯: Only basic insulation (protective class 1, overvoltage category II) is provided for the control circuit terminals. Additional insulation may be necessary in the end product to conform to CE requirements.

*1. Short-circuit bar should be removed when connecting a DC reactor.

*2. Minimum permissible load: 5 VDC, 10 mA (as reference value)

Connection Example of Braking Resistor

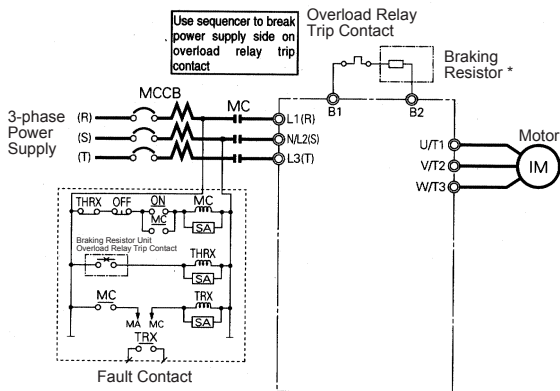

- * Disable stall prevention during deceleration by setting n092 to 1 when using a Braking Resistor Unit. The motor may not stop within the deceleration time if this setting is not changed.

Terminal Descriptions

Type	Terminal	Name	Function (Signal Level)
Main Circuit	R/L1, S/L2, T/L3	AC power supply input	Use main circuit power input. (Use terminals R/L1 and S/L2 for single-phase Inverters. Never use terminal T/L3.)
	U/T1, V/T2, W/T3	Inverter output	Inverter output
	B1, B2	Braking resistor connection	Braking resistor connection
	+2, +1	DC reactor connection	When connecting optional DC reactor, remove the main circuit short-circuit bar between +2 and +1.
	+1, -	DC power supply input	DC power supply input (+1: positive -: negative)*1
	⊕	Grounding	For grounding (according to the local grounding codes)

Type	Terminal	Name	Function (Signal Level)				
Control Circuit	Input	Sequence	S1	Multi-function input selection 1	Factory setting closed: FWD run open: Stop	Photocoupler insulation, 24 VDC, 8 mA	
			S2	Multi-function input selection 2	Factory setting closed: REV run open: Stop		
			S3	Multi-function input selection 3	Factory setting: External fault (NO contact)		
			S4	Multi-function input selection 4	Factory setting: Fault reset		
			S5	Multi-function input selection 5	Factory setting: Multi-step speed reference 1		
			S6	Multi-function input selection 6	Factory setting: Multi-step speed reference 2		
			S7	Multi-function input selection 7	Factory Setting: Jog Command		
			SC	Multi-function input selection common	For control signal		
	Frequency reference	RP	Master reference pulse train input	33 kHz max.			
		FS	Power for frequency setting	+12 V (permissible current 20 mA max.)			
		FR	Master frequency reference	0 to +10 VDC (20 k Ω) or 4 to 20 mA (250 k Ω) or 0 to 20 mA (250 Ω) (1/1000 resolution)			
		FC	Frequency reference common	0 V			
	Output	Multi-function contact output	MA	NO contact output	Factory setting: fault	Contact capacity 250 VAC: 1 A or less, ^{*3} 30 VDC: 1 A or less	
			MB	NC contact output			
			MC	Contact output common			
		Photocoupler output	P1	Photocoupler output 1	Factory setting: Run		Photocoupler output +48 VDC, 50 mA or less
			P2	Photocoupler output 2	Factory setting: Frequency agree		
			PC	Photocoupler output common	0 V		
		AM	Analog monitor output	Factory setting: Output frequency 0 to +10 V [*]	0 to +10 VDC, 2 mA or less, 8-bit resolution		
		AC	Analog monitor common	0 V			

Type	Terminal	Name	Function (Signal Level)		
Communication Circuit Terminal	MEMOBUS communications	R+	Communications input (+)	MEMOBUS communications Run through RS-485 or RS-422.	RS-485/422 MEMOBUS protocol 19.2 kbps max.
		R-	Communications input (-)		
		S+	Communications output (+)		
		S-	Communications output (-)		

- * 1. DC power supply input terminal does not conform to CE/UL standards.
- * 2. Can be switched to pulse monitor output.
- * 3. Minimum permissible load: 5 VDC, 10 mA (as reference value)

■ Sequence Input Connection with NPN/PNP Transistor

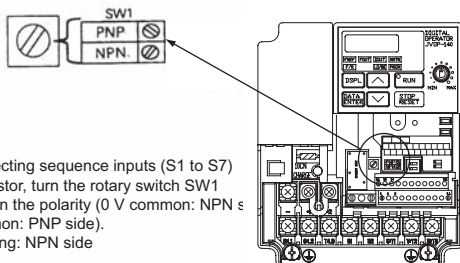

When connecting sequence inputs (S1 to S7) with a transistor, turn the rotary switch SW1 depending on the polarity (0 V common: NPN side; +24 V common: PNP side).
Factory setting: NPN side

Sequence Connection with NPN Transistor (0 V Common)

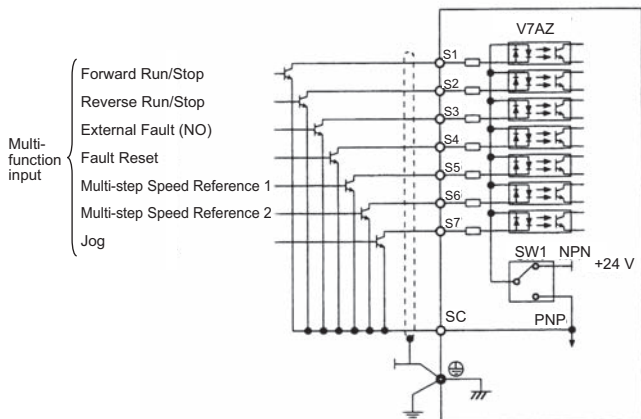

Sequence Connection with PNP Transistor (+24 V Common)

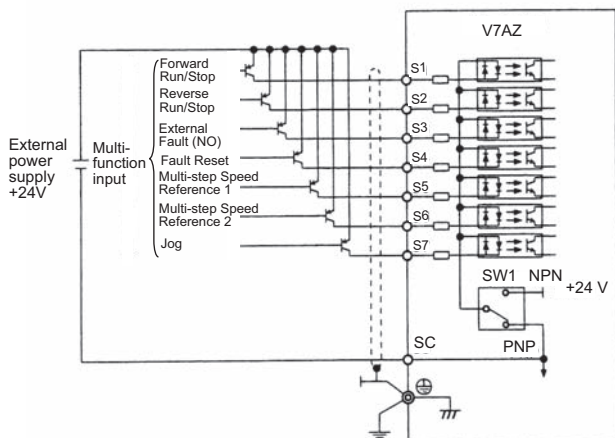

■ Dimensions/Heat Loss

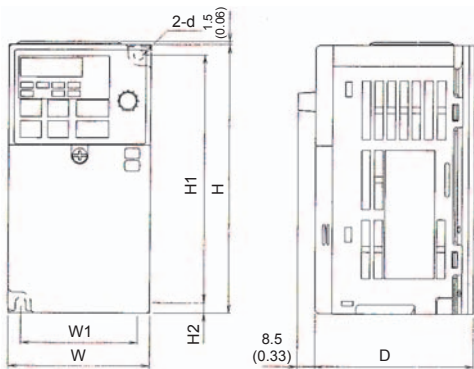

Fig. 1

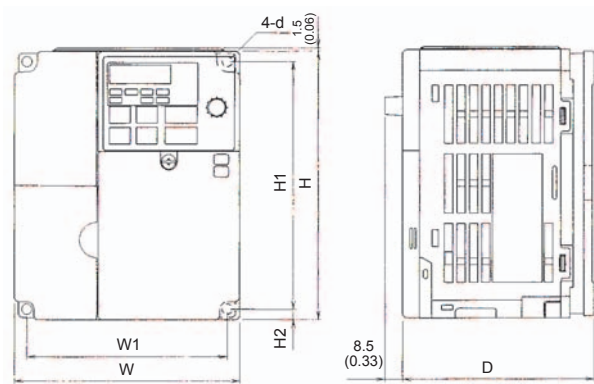

Fig. 2

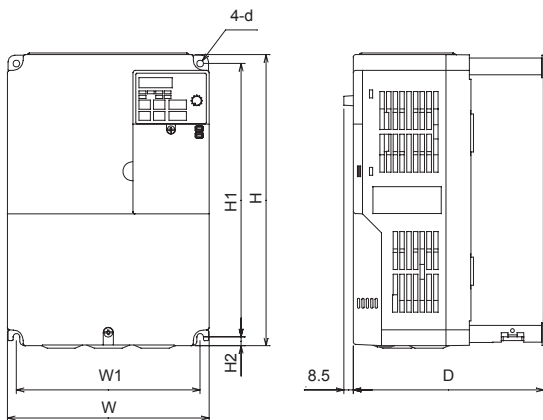

Fig. 3

Dimensions in mm (inches)/Mass in kg (lb)/Heat Loss (W)

Voltage class	Capacity (kW)	W	H	D	W1	H1	H2	d	Mass	Heat Loss (W)			Fig.
										Heat-sink	Unit	Total	
200 V 3-phase	0.1	68 (2.68)	128 (5.04)	76 (2.99)	56 (2.20)	118 (4.65)	5 (0.20)	M4	0.6 (1.32)	3.7	9.3	13.0	1
	0.25	68 (2.68)	128 (5.04)	76 (2.99)	56 (2.20)	118 (4.65)	5 (0.20)	M4	0.6 (1.32)	7.7	10.3	18.0	1
	0.55	68 (2.68)	128 (5.04)	108 (4.25)	56 (2.20)	118 (4.65)	5 (0.20)	M4	0.9 (1.98)	15.8	12.3	28.1	1
	1.1	68 (2.68)	128 (5.04)	128 (5.04)	56 (2.20)	118 (4.65)	5 (0.20)	M4	1.1 (2.43)	28.4	16.7	45.1	1
	1.5	108 (4.25)	128 (5.04)	131 (5.16)	96 (3.78)	118 (4.65)	5 (0.20)	M4	1.4 (3.09)	53.7	19.1	72.8	2
	2.2	108 (4.25)	128 (5.04)	140 (5.51)	96 (3.78)	118 (4.65)	5 (0.20)	M4	1.5 (3.3)	60.4	34.4	94.8	2
	4.0	140 (5.51)	128 (5.04)	143 (5.63)	128 (5.04)	118 (4.65)	5 (0.20)	M4	2.1 (4.62)	96.7	52.4	149.1	2
	5.5	180	260	170	164	244	8	M5	4.6	170.4	79.4	249.8	3
	7.5	180	260	170	164	244	8	M5	4.8	219.2	98.9	318.1	3

Voltage class	Capacity (kW)	W	H	D	W1	H1	H2	d	Mass	Heat Loss (W)			Fig.
										Heat-sink	Unit	Total	
200 V single-phase	0.1	68 (2.68)	128 (5.04)	76 (2.99)	56 (2.20)	118 (4.65)	5 (0.20)	M4	0.6 (1.32)	3.7	10.4	14.1	1
	0.25	68 (2.68)	128 (5.04)	73 (2.99)	56 (2.20)	118 (4.65)	5 (0.20)	M4	0.7 (1.54)	7.7	12.3	20.0	1
	0.55	68 (2.68)	128 (5.04)	131 (5.16)	56 (2.20)	118 (4.65)	5 (0.20)	M4	1.0 (2.20)	15.8	16.1	31.9	1
	1.1	108 (4.25)	128 (5.04)	140 (5.51)	96 (3.78)	118 (4.65)	5 (0.20)	M4	1.5 (3.31)	28.4	23.0	51.4	2
	1.5	108 (4.25)	128 (5.04)	156 (6.14)	96 (3.78)	118 (4.65)	5 (0.20)	M4	1.5 (3.31)	53.7	29.1	82.8	2
	2.2	140 (5.51)	128 (5.04)	163 (6.42)	128 (5.04)	118 (4.65)	5 (0.20)	M4	2.2 (4.84)	64.5	49.1	113.6	2
	4.0	170 (6.69)	128 (5.04)	180 (7.09)	158 (6.22)	118 (4.65)	5 (0.20)	M4	2.9 (6.38)	98.2	78.2	176.4	2
400 V 3-phase	0.37	108 (4.25)	128 (5.04)	92 (3.62)	96 (3.78)	118 (4.65)	5 (0.20)	M4	1.0 (2.20)	9.4	13.7	23.1	2
	0.55	108 (4.25)	128 (5.04)	110 (4.43)	96 (3.78)	118 (4.65)	5 (0.20)	M4	1.1 (2.43)	15.1	15.0	30.1	2
	1.1	108 (4.25)	128 (5.04)	140 (5.51)	96 (3.78)	118 (4.65)	5 (0.20)	M4	1.5 (3.31)	30.3	24.6	54.9	2
	1.5	108 (4.25)	128 (5.04)	156 (6.14)	96 (3.78)	118 (4.65)	5 (0.20)	M4	1.5 (3.31)	45.8	29.9	75.7	2
	2.2	108 (4.25)	128 (5.04)	156 (6.14)	96 (3.78)	118 (4.65)	5 (0.20)	M4	1.5 (3.31)	50.5	32.5	83.0	2
	3.0	140 (5.51)	128 (5.04)	143 (5.63)	128 (5.04)	118 (4.65)	5 (0.20)	M4	2.1 (4.62)	58.2	37.6	95.8	2
	4.0	140 (5.51)	128 (5.04)	143 (5.63)	128 (5.04)	118 (4.65)	5 (0.20)	M4	2.1 (4.62)	79.9	49.2	129.1	2
	5.5	180	260	170	164	244	8	M5	4.8	168.8	87.7	256.5	3
7.5	180	260	170	164	244	8	M5	4.8	209.6	99.3	308.9	3	

Note: Remove the top and bottom covers so that Inverters of 5.5/7.5 kW (200/400 V Classes) can be used as IP00.

■ Recommended Peripheral Devices

It is recommended that the following peripheral devices be mounted between the AC main circuit power supply and V7AZ input terminals R/L1, S/L2, and T/L3.

- **MCCB (Molded-case Circuit Breaker)/Fuse:**
Always connect for wiring protection.
- **Magnetic Contactor:**
Mount a surge suppressor on the coil. (Refer to the table shown below.) When using a magnetic contactor to start and stop the Inverter, do not exceed one start per hour.

Recommended MCCB Magnetic Contactors and Fuses

- 200 V 3-phase

V7AZ Model	V7** 20P1	V7** 20P2	V7** 20P4	V7** 20P7	V7** 21P5	V7** 22P2	V7** 24P0	V7** 25P5	V7** 27P5	
Capacity (kVA)	0.3	0.6	1.1	1.9	3.0	4.2	6.7	9.5	13.0	
Rated Output Current (A)	0.8	1.6	3	5	8	11	17.5	25.0	33.0	
MCCB type NF30 (MITSUBISHI)	5 A	5 A	5 A	10 A	20 A	20 A	30 A	50 A	60 A	
Magnetic contactor (Fuji Electric FA Components & Systems)	Without reactor	SC-03 (11A)	SC-03 (11A)	SC-03 (11A)	SC-03 (11A)	SC-4-0 (18A)	SC-N1 (26A)	SC-N2 (35A)	SC-N2S (50A)	SC-N3 (65A)
	With reactor	SC-03 (11A)	SC-03 (11A)	SC-03 (11A)	SC-03 (11A)	SC-03 (11A)	SC-4-0 (18A)	SC-N1 (26A)	SC-N2 (35A)	SC-N2S (50A)
Fuse (UL Class RK5)	5 A	5 A	5 A	10 A	20 A	20 A	30 A	50 A	60 A	

- 200 V Single-phase

V7AZ Model	V7** B0P1	V7** B0P2	V7** B0P4	V7** B0P7	V7** B1P5	V7** B2P2	V7** B4P0	
Capacity (kVA)	0.3	0.6	1.1	1.9	3.0	4.2	6.7	
Rated Output Current (A)	0.8	1.6	3	5	8	11	17.5	
MCCB type NF30, NF50 (MITSUBISHI)	5 A	5 A	10 A	20 A	30 A	40 A	50 A	
Magnetic contactor (Fuji Electric FA Components & Systems)	Without reactor	SC-03 (11A)	SC-03 (11A)	SC-03 (11A)	SC-4-0 (18A)	SC-N2 (35A)	SC-N2 (35A)	SC-N2S (50A)
	With reactor	SC-03 (11A)	SC-03 (11A)	SC-03 (11A)	SC-4-0 (18A)	SC-N1 (26A)	SC-N2 (35A)	SC-N2S (50A)

V7AZ Model	V7** B0P1	V7** B0P2	V7** B0P4	V7** B0P7	V7** B1P5	V7** B2P2	V7** B4P0
Fuse (UL Class RK5)	5 A	5 A	10 A	20 A	20 A	40 A	50 A

• 400 V 3-phase

V7AZ Model	V7** 40P2	V7** 40P4	V7** 40P7	V7** 41P5	V7** 42P2	V7** 43P0	V7** 43P0	V7** 45P5	V7** 47P5	
Capacity (kVA)	0.9	1.4	2.6	3.7	4.2	5.5	7.0	11.0	14.0	
Rated Output Current (A)	1.2	1.8	3.4	4.8	5.5	7.2	9.2	14.8	18.0	
MCCB type NF30, NF50 (MIT-SUBISHI)	5 A	5 A	5 A	10 A	20 A	20 A	20 A	30 A	30 A	
Magnetic contactor (Fuji Electric FA Components & Systems)	Without reactor	SC-03 (11A)	SC-03 (11A)	SC-03 (11A)	SC-03 (11A)	SC-4-0 (18A)	SC-4-0 (18A)	SC-N1 (26A)	SC-N2 (35A)	SC-N2 (35A)
	With reactor	SC-03 (11A)	SC-03 (11A)	SC-03 (11A)	SC-03 (11A)	SC-03 (11A)	SC-03 (11A)	SC-4-0 (18A)	SC-N1 (26A)	SC-N2 (35A)
Fuse (UL Class RK5)	5 A	5 A	5 A	10 A	10 A	20 A	20 A	30 A	30 A	

Surge Suppressors

Surge Suppressors		Model DCR2-	Specifications	Code No.
Coils and Relays				
200 V to 230 V	Large size magnetic contactors	50A22E	250 VAC 0.5 μ F 200 Ω	C002417
	Control relays MY-2, -3 (OMRON) HH-22, -23 (FUJI) MM-2, -4 (OMRON)	10A25C	250 VAC 0.1 μ F 100 Ω	C002482

• Ground Fault Interrupter:

Select a ground fault interrupter not affected by high frequencies. To prevent malfunctions, the current should be 200 mA or higher and the operating time 0.1 s or longer.

Example:

- NV series by Mitsubishi Electric Co., Ltd. (manufactured in 1988 and after)
- EGSG series by Fuji Electric Co., Ltd. (manufactured in 1984 and after)

- **AC and DC Reactor:**

Install an AC reactor to connect to a power supply transformer of large capacity (600 kVA or more) or to improve power factor on the power supply side.

- **Noise Filter:**

Use a noise filter exclusively for the Inverter if radio noise generated from the Inverter causes other control devices to malfunction.

A black speech bubble icon with the word "NOTE" written inside in white capital letters.

1. Never connect a general LC/RC noise filter to the Inverter output circuit.
2. Do not connect a phase-advancing capacitor to the I/O sides and/or a surge suppressor to the output side.
3. When a magnetic contactor is installed between the Inverter and the motor, do not turn it ON/OFF during operation.

For the details of the peripheral devices, refer to the catalog.

■ Constants List

First Functions (Constants n001 to n049)

No.	Register No. for Transmission	Name	Setting Range	Setting Unit	Factory Setting	Change during Operation	User Setting	Ref. Page
001	0101H	Password	0 to 6, 12, 13	-	1	No		53
002	0102	Control Mode Selection (Note 6)	0, 1	-	0 (Note 1, 6)	No		59
003	0103	Run Command Selection	0 to 3	-	0	No		64
004	0104	Frequency Reference Selection	0 to 9	-	1	No		65
005	0105	Stopping Method Selection	0, 1	-	0	No		106
006	0106	Reverse Run Prohibit	0, 1	-	0	No		74
007	0107	Stop Key Selection	0, 1	-	0	No		98
008	0108	Frequency Reference Selection in Local Mode	0, 1	-	0 (Note 5)	No		65
009	0109	Frequency Reference Setting Method from Digital Operator	0, 1	-	0	No		65
010	010A	Detecting Fault Contact of Digital Operator	0, 1	-	0	No		64
011	010B	Max. Output Frequency	50.0 to 400.0 Hz	0.1 Hz	50.0 Hz	No		55
012	010C	Max. Voltage	0.1 to 255.0 V (Note 2)	0.1 V	200.0 V (Note 2)	No		55
013	010D	Max. Voltage Output Frequency	0.2 to 400.0 Hz	0.1 Hz	50.0 Hz	No		55
014	010E	Mid. Output Frequency	0.1 to 399.9 Hz	0.1 Hz	1.3 Hz (Note 6)	No		55
015	010F	Mid. Output Frequency Voltage	0.1 to 255.0 V (Note 2)	0.1 V	12.0 V (Note 2, 6)	No		55
016	0110	Min. Output Frequency	0.1 to 10.0 Hz	0.1 Hz	1.3 Hz (Note 6)	No		55
017	0111	Min. Output Frequency Voltage	0.1 to 50.0 V (Note 2)	0.1 V	12.0 V (Note 2, 6)	No		55
018	0112	Selecting Setting Unit for Acceleration/deceleration Time	0, 1	-	0	No		79

No.	Register No. for Transmission	Name	Setting Range	Setting Unit	Factory Setting	Change during Operation	User Setting	Ref. Page
019	0113	Acceleration Time 1	0.00 to 6000 s	Depends on n018 setting	10.0 s	Yes		78
020	0114	Deceleration Time 1	0.00 to 6000 s	Depends on n018 setting	10.0 s	Yes		78
021	0115	Acceleration Time 2	0.00 to 6000 s	Depends on n018 setting	10.0 s	Yes		78
022	0116	Deceleration Time 2	0.00 to 6000 s	Depends on n018 setting	10.0 s	Yes		78
023	0117	S-curve Selection	0 to 3	-	0	No		80
024	0118	Frequency Reference 1 (Master Frequency Reference)	0.00 to 400.0 Hz	0.01 Hz (less than 100 Hz)/ 0.1 Hz (100 Hz or more)	6.00 Hz	Yes		74
025	0119	Frequency Reference 2	0.00 to 400.0 Hz	0.01 Hz (less than 100 Hz)/ 0.1 Hz (100 Hz or more)	0.00 Hz	Yes		74
026	011A	Frequency Reference 3	0.00 to 400.0 Hz	0.01 Hz (less than 100 Hz)/ 0.1 Hz (100 Hz or more)	0.00 Hz	Yes		74
027	011B	Frequency Reference 4	0.00 to 400.0 Hz	0.01 Hz (less than 100 Hz)/ 0.1 Hz (100 Hz or more)	0.00 Hz	Yes		74
028	011C	Frequency Reference 5	0.00 to 400.0 Hz	0.01 Hz (less than 100 Hz)/ 0.1 Hz (100 Hz or more)	0.00 Hz	Yes		74
029	011D	Frequency Reference 6	0.00 to 400.0 Hz	0.01 Hz (less than 100 Hz)/ 0.1 Hz (100 Hz or more)	0.00 Hz	Yes		74
030	011E	Frequency Reference 7	0.00 to 400.0 Hz	0.01 Hz (less than 100 Hz)/ 0.1 Hz (100 Hz or more)	0.00 Hz	Yes		74
031	011F	Frequency Reference 8	0.00 to 400.0 Hz	0.01 Hz (less than 100 Hz)/ 0.1 Hz (100 Hz or more)	0.00 Hz	Yes		74

No.	Register No. for Transmission	Name	Setting Range	Setting Unit	Factory Setting	Change during Operation	User Setting	Ref. Page
032	0120	Jog Frequency	0.00 to 400.0 Hz	0.01 Hz (less than 100 Hz)/ 0.1 Hz (100 Hz or more)	6.00 Hz	Yes		75
033	0121	Frequency Reference Upper Limit	0% to 110%	1%	100%	No		77
034	0122	Frequency Reference Lower Limit	0% to 110%	1%	0%	No		77
035	0123	Setting/Displaying Unit Selection for Frequency Reference	0 to 3999	-	0	No		182
036	0124	Motor Rated Current	0% to 150% of Inverter rated current	0.1 A	(Note 3)	No		136
037	0125	Electronic Thermal Motor Protection Selection	0 to 4	-	0	No		136, 103
038	0126	Electronic Thermal Motor Protection Time Constant Setting	1 to 60 min	1 min	8 min	No		136
039	0127	Selecting Cooling Fan Operation	0, 1	-	0	No		141
040	0128	Motor Rotation Direction	0, 1	-	0	No		41
041	0129	Acceleration Time 3	0.00 to 6000 s	Depends on n018 setting	10.0 s	Yes		78
042	012A	Deceleration Time 3	0.00 to 6000 s	Depends on n018 setting	10.0 s	Yes		78
043	012B	Acceleration Time 4	0.00 to 6000 s	Depends on n018 setting	10.0 s	Yes		78
044	012C	Deceleration Time 4	0.00 to 6000 s	Depends on n018 setting	10.0 s	Yes		78
045	012D	Frequency Reference Bias Step Amount (Up/Down Command 2)	0.00 Hz to 99.99 Hz	0.01 Hz	0.00 Hz	Yes		115
046	012E	Frequency Reference Bias Accel/Decel Rate (Up/Down Command 2)	0, 1	-	0	Yes		115
047	012F	Frequency Reference Bias Operation Mode Selection (Up/Down Command 2)	0, 1	-	0	Yes		115
048	0130	Frequency Reference Bias Value (Up/Down Command 2)	-99.9% to 100.0% n011=100%	0.1%	0.0%	No		115
049	0131	Analog Frequency Reference Fluctuation Limit Level (Up/Down Command 2)	0.1% to 100.0% n011=100%	0.1%	1.0%	Yes		115

Second Functions (Constants n050 to n079)

No.	Register No. for Transmission	Name	Setting Range	Setting Unit	Factory Setting	Change during Operation	User Setting	Ref. Page
050	0132	Multi-function Input Selection 1 (Terminal S1)	1 to 37	-	1	No		110
051	0133	Multi-function Input Selection 2 (Terminal S2)	1 to 37	-	2	No		110
052	0134	Multi-function Input Selection 3 (Terminal S3)	0 to 37	-	3	No		110
053	0135	Multi-function Input Selection 4 (Terminal S4)	1 to 37	-	5	No		110
054	0136	Multi-function Input Selection 5 (Terminal S5)	1 to 37	-	6	No		110
055	0137	Multi-function Input Selection 6 (Terminal S6)	1 to 37	-	7	No		110
056	0138	Multi-function Input Selection 7 (Terminal S7)	1 to 37	-	10	No		110
057	0139	Multi-function Output Selection 1	0 to 22	-	0	No		124
058	013A	Multi-function Output Selection 2	0 to 22	-	1	No		124
059	013B	Multi-function Output Selection 3	0 to 22	-	2	No		124
060	013C	Analog Frequency Reference Gain	0 % to 255 %	1 %	100 %	Yes		76
061	013D	Analog Frequency Reference Bias	-100 % to 100 %	1 %	0 %	Yes		76
062	013E	Filter Time Constant for Analog Frequency Reference	0.00 to 2.00 s	0.01 s	0.10 s	Yes		-
063	013F	Watchdog Error Operation Selection (For SI-T/V7)	0 to 4	-	0	No		191
064	0140	Frequency Reference Loss Detection Selection	0, 1	-	0	No		183
065	0141	Monitor Output Type	0, 1	-	0	No		91
066	0142	Monitor Item Selection	0 to 8	-	0	No		90
067	0143	Monitor Gain	0.00 to 2.00	0.01	1.00	Yes		91
068	0144	Analog Frequency Reference Gain (Voltage input from Operator)	-255% to 255%	1%	100%	Yes		167
069	0145	Analog Frequency Reference Bias (Voltage input from Operator)	-100% to 100%	1%	0%	Yes		167

No.	Register No. for Transmission	Name	Setting Range	Setting Unit	Factory Setting	Change during Operation	User Setting	Ref. Page
070	0146	Analog Frequency Reference Filter Time Constant (Voltage input from Operator)	0.00 to 2.00 s	0.01 s	0.10 s	Yes		167
071	0147	Analog Frequency Reference Gain (Current input from Operator)	-255% to 255%	1%	100%	Yes		167
072	0148	Analog Frequency Reference Bias (Current input from Operator)	-100% to 100%	1%	0%	Yes		167
073	0149	Analog Frequency Reference Filter Time Constant (Current input from Operator)	0.00 to 2.00 s	0.01 s	0.10 s	Yes		167
074	014A	Pulse Train Frequency Reference Gain	0 % to 255 %	1 %	100 %	Yes		-
075	014B	Pulse Train Frequency Reference Bias	-100 % to 100 %	1 %	0 %	Yes		-
076	014C	Pulse Train Frequency Filter Time Constant	0.00 to 2.00 s	0.01 s	0.10 s	Yes		-
077	014D	Multi-function Analog Input Function	0 to 4	-	0	No		121
078	014E	Multi-function Analog Input Signal Selection	0, 1	-	0	No		120
079	014F	Frequency Reference Bias (FBIAS) Value	0 % to 50 %	1 %	10 %	No		120

Third Functions (Constants n080 to n119)

No.	Register No. for Transmission	Name	Setting Range	Setting Unit	Factory Setting	Change during Operation	User Setting	Ref. Page
080	0150	Carrier Frequency Selection	1 to 4, 7 to 9, 12	-	(Note 4)	No		94
081	0151	Momentary Power Loss Ride-through Method	0 to 2 (Note 9)	-	0	No		79
082	0152	Automatic Retry Attempts	0 to 10 times	-	0	No		84
083	0153	Jump Frequency 1	0.00 to 400.0 Hz	0.01 Hz (less than 100 Hz)/0.1 Hz (100 Hz or more)	0.00 Hz	No		84
084	0154	Jump Frequency 2	0.00 to 400.0 Hz	0.01 Hz (less than 100 Hz)/0.1 Hz (100 Hz or more)	0.00 Hz	No		84

No.	Register No. for Transmission	Name	Setting Range	Setting Unit	Factory Setting	Change during Operation	User Setting	Ref. Page
085	0155	Jump Frequency 3	0.00 to 400.0 Hz	0.01 Hz (less than 100 Hz)/0.1 Hz (100 Hz or more)	0.00 Hz	No		84
086	0156	Jump Frequency Range	0.00 to 25.50 Hz	0.01 Hz	0.00 Hz	No		84
087	0157	Cumulative Operation Time Function Selection (Note 8)	0, 1	-	0	No		-
088	0158	Cumulative Operation Time (Note 8)	0 to 6550	1 = 10H	0H	No		-
089	0159	DC Injection Braking Current	0 to 100 %	1%	50%	No		89
090	015A	DC Injection Braking Time at Stop	0.0 to 25.5 s	0.1 s	0.5 s	No		107
091	015B	DC Injection Braking Time at Startup	0.0 to 25.5 s	0.1 s	0.0 s	No		89
092	015C	Stall Prevention during Deceleration	0, 1	-	0	No		134
093	015D	Stall Prevention Level during Acceleration	30% to 200%	1%	170%	No		131
094	015E	Stall Prevention Level during Running	30% to 200%	1%	160%	No		134
095	015F	Frequency Detection Level	0.00 to 400.0 Hz	0.01 Hz (less than 100 Hz)/0.1 Hz (100 Hz or more)	0.00 Hz	No		82
096	0160	Overtorque Detection Function Selection 1	0 to 4	-	0	No		81
097	0161	Overtorque/Undertorque Detection Function Selection 2	0, 1	-	0	No		82
098	0162	Overtorque Detection Level	30% to 200%	1%	160%	No		82
099	0163	Overtorque Detection Time	0.1 to 10.0 s	0.1 s	0.1 s	No		82
100	0164	Hold Output Frequency Saving Selection	0, 1	-	0	No		114
101	0165	Speed Search Deceleration Time	0.1 to 10.0 s	0.1 s	2.0 s	No		89
102	0166	Speed Search Operation Level	0 % to 200 %	1 %	150 %	No		89
103	0167	Torque Compensation Gain	0.0 to 2.5	0.1	1.0	Yes		58

No.	Register No. for Transmission	Name	Setting Range	Setting Unit	Factory Setting	Change during Operation	User Setting	Ref. Page
104	0168	Torque Compensation Time Constant	0.0 to 25.5 s	0.1 s	0.3 s (Note 6)	No		58
105	0169	Torque Compensation Iron Loss	0.0 to 6550	0.01 W (less than 1000 W)/1 W (1000 W or more)	(Note 3)	No		58
106	016A	Motor Rated Slip	0.0 to 20.0 Hz	0.1 Hz	(Note 3)	Yes		60
107	016B	Motor Line-to-neutral Resistance	0.000 to 65.50 Ω	0.001 Ω (less than 10 Ω)/0.01 Ω (10 Ω or more)	(Note 3)	No		60
108	016C	Motor Leakage Inductance	0.00 to 655.0 mH	0.01 mH (less than 100 mH)/0.1 mH (100 mH or more)	(Note 3)	No		61
109	016D	Torque Compensation Voltage Limiter	0% to 250%	1%	150%	No		-
110	016E	Motor No-load Current	0% to 99%	1%	(Note 3)	No		59
111	016F	Slip Compensation Gain	0.0 to 2.5	0.1	0.0 (Note 6)	Yes		135
112	0170	Slip Compensation Time Constant	0.0 to 25.5 s	0.1 s	2.0 s (Note 6)	No		135
113	0171	Slip Compensation during Regenerative Operation	0, 1	-	0	No		-
114	0172	Number of Transmission Cycle Error Detection (For SI-T/V7)	2 to 10	-	2	No		191
115	0173	Stall Prevention above Base Speed during Run	0, 1	-	0	No		133
116	0174	Acceleration/Deceleration Time during Stall Prevention	0, 1	-	0	No		133
117	0175	Undertorque Detection Function Selection 1	0 to 4	-	0	No		186
118	0176	Undertorque Detection Level	0% to 200%	1%	10%	No		186
119	0177	Undertorque Detection Time	0.1 to 10.0 s	0.1 s	0.1 s	No		186

Fourth Functions (Constants n120 to n179)

No.	Register No. for Transmission	Name	Setting Range	Setting Unit	Factory Setting	Change during Operation	User Setting	Ref. Page
120	0178	Frequency Reference 9	0.00 to 400.0 Hz	0.01 Hz (less than 100 Hz)/0.1 Hz (100 Hz or more)	0.00 Hz	Yes		74
121	0179	Frequency Reference 10	0.00 to 400.0 Hz	0.01 Hz (less than 100 Hz)/0.1 Hz (100 Hz or more)	0.00 Hz	Yes		74
122	017A	Frequency Reference 11	0.00 to 400.0 Hz	0.01 Hz (less than 100 Hz)/0.1 Hz (100 Hz or more)	0.00 Hz	Yes		74
123	017B	Frequency Reference 12	0.00 to 400.0 Hz	0.01 Hz (less than 100 Hz)/0.1 Hz (100 Hz or more)	0.00 Hz	Yes		74
124	017C	Frequency Reference 13	0.00 to 400.0 Hz	0.01 Hz (less than 100 Hz)/0.1 Hz (100 Hz or more)	0.00 Hz	Yes		74
125	017D	Frequency Reference 14	0.00 to 400.0 Hz	0.01 Hz (less than 100 Hz)/0.1 Hz (100 Hz or more)	0.00 Hz	Yes		74
126	017E	Frequency Reference 15	0.00 to 400.0 Hz	0.01 Hz (less than 100 Hz)/0.1 Hz (100 Hz or more)	0.00 Hz	Yes		74
127	017F	Frequency Reference 16	0.00 to 400.0 Hz	0.01 Hz (less than 100 Hz)/0.1 Hz (100 Hz or more)	0.00 Hz	Yes		74
128	0180	PID Control Selection	0 to 8	-	0	No		159
129	0181	PID Feedback Gain	0.00 to 10.00 Hz	0.01	1.00	Yes		162
130	0182	Proportional Gain (P)	0.0 to 25.0	0.1	1.0	Yes		161
131	0183	Integral Time (I)	0.0 to 360.0 s	0.1 s	1.0 s	Yes		161
132	0184	Derivative Time (D)	0.00 to 2.50 s	0.01 s	0.00	Yes		161

No.	Register No. for Transmission	Name	Setting Range	Setting Unit	Factory Setting	Change during Operation	User Setting	Ref. Page
133	0185	PID Offset Adjustment	-100% to 100%	1%	0%	Yes		162
134	0186	Upper Limit of Integral Values	0% to 100%	1%	100%	Yes		161
135	0187	Primary Delay Time Constant for PID Output	0.0 to 10.0 s	0.1 s	0.0 s	Yes		162
136	0188	Selection of PID Feedback Loss Detection	0 to 2	-	0	No		163
137	0189	PID Feedback Loss Detection Level	0% to 100%	1%	0%	No		163
138	018A	PID Feedback Loss Detection Time	0.0 to 25.5 s	0.1 s	1.0 s	No		163
139	018B	Autotuning Selection	0 to 2	-	0	No		66
140	018C	Motor 2 Maximum Output Frequency	50.0 to 400.0 Hz	0.1 Hz	50.0 Hz	No		99
141	018D	PTC Thermistor Input Motor Overheat Protection Selection	0 to 7	-	0	No		139
142	018E	Motor Temperature Input Filter Time Constant	0.0 to 10.0 s	0.1 s	0.2 s	Yes		139
143	018F	Sequence Input Redundant Reading Selection (Stop Position Control Selection)	0 to 2	-	0	No		108
144	0190	Stop Position Control Compensation Gain	0.50 to 2.55	0.1	1.00	No		108
145	0191	Bi-directional Function Selection	0, 1	-	0	No		163
146	0192	Frequency Offset Selection	0 to 29	-	0	No		85
147	0193	Motor 2 Maximum Voltage Output Frequency	0.2 to 400.0 Hz	0.1 Hz	50.0 Hz	No		99
148	0194	UV fault storage selection	0,1	-	0	No		-
149	0195	Pulse Train Input Scaling	100 to 3300	1 = 10 Hz	2500 (25 kHz)	No		128
150	0196	Pulse Monitor Output Frequency Selection	0, 1, 6, 12, 24, 36, 40 to 45, 50	-	0	No		92
151	0197	MEMOBUS Timeover Detection	0 to 4	-	0	No		143
152	0198	MEMOBUS Frequency Reference and Frequency Monitor Unit	0 to 3	-	0	No		143

No.	Register No. for Transmission	Name	Setting Range	Setting Unit	Factory Setting	Change during Operation	User Setting	Ref. Page
153	0199	MEMOBUS Slave Address	0 to 32	-	0	No		144
154	019A	MEMOBUS BPS Selection	0 to 3	-	2	No		144
155	019B	MEMOBUS Parity Selection	0 to 2	-	0	No		144
156	019C	Transmission Waiting Time	10 to 65 ms	1 ms	10 ms	No		144
157	019D	RTS Control	0, 1	-	0	No		144
158	019E	Motor 2 Maximum Voltage	0.1 to 255.0 V (Note 2)	0.1 V	200.0 V (Note 2)	No		99
159	019F	Motor 2 Mid. Output Frequency Voltage	0.1 to 255.0 V (Note 2)	0.1 V	12.0 V (Note 2) (Note 3)	No		99
160	01A0	Motor 2 Minimum Output Frequency Voltage	0.1 to 50.0 V (Note 2)	0.1 V	12.0 V (Note 2) (Note 3)	No		99
161	01A1	Motor 2 Rated Current	0% to 150% of Inverter rated current	0.1 A	(Note 3)	No		99
162	0192	Motor 2 Rated Slip	0.0 to 20.0 Hz	0.1 Hz	(Note 3)	No		99
163	01A3	PID Output Gain	0.0 to 25.0	0.1	1.0	No		162
164	01A4	PID Feedback Value Selection	0 to 5	-	0	No		160
165	01A5	Externally Mounting Type Braking Resistor Overheat Protection Selection (Note 7)	0, 1	-	0	No		-
166	01A6	Input Open-phase Detection Level	0% to 100%	1%	0%	No		184
167	01A7	Input Open-phase Detection Time	0 to 255 s	1 s	0 s	No		184
168	01A8	Output Open-phase Detection Level	0% to 100%	1%	0%	No		184
169	01A9	Output Open-phase Detection Time	0.0 to 2.0 s	0.1 s	0.0 s	No		184
170	01AA	Enter Command Operation Selection (MEMOBUS communications)	0, 1	-	0	No		155
171	01AB	Frequency Reference Bias Upper Limit (Up/Down Command 2)	0.0% to 100.0% (n011 = 100%)	0.1%	0.0%	Yes		115
172	01AC	Frequency Reference Bias Lower Limit (Up/Down Command 2)	-99.9% to 0.0% (n011 = 100%)	0.1%	0.0%	Yes		115

No.	Register No. for Transmission	Name	Setting Range	Setting Unit	Factory Setting	Change during Operation	User Setting	Ref. Page
173	01AD	DC Injection Braking Proportional Gain	1 to 999	1 = 0.001	83 (0.083)	No		-
174	01AE	DC Injection Braking Integral Time Constant	1 to 250	1 = 4 ms	25 (100 ms)	No		-
175	01AF	Reducing Carrier Frequency Selection at Low Speed	0, 1	-	0 (Note 8)	No		97
176	01B0	Constant Copy Function Selection	rdy, rEd, CPy, vFy, vA, Sno	-	rdy	No		168
177	01B1	Constant Read Selection Prohibit	0, 1	-	0	No		169
178	01B2	Fault History	Stores, displays most recent 4 alarms	Setting disabled	-	No		49
179	01B3	Software Version No.	Displays lower-place 4 digits of software No.	Setting disabled	-	No		-

Note: 1. Not initialized by constant initialization.

2. Upper limit of setting range and factory setting are doubled for 400 V Class.
3. Depends on Inverter capacity. Refer to the next page.
4. Depends on Inverter capacity. Refer to page 96.
5. Factory setting of the model with JVOP-140 Digital Operator (with potentiometer) is 0. Setting can be set to 1 by constant initialization.
6. When control mode selection (n002) is changed, factory setting corresponds to the control mode. Refer to the next page.
7. Constant that is provided for 5.5 kW and 7.5 kW Inverters of 200 V and 400 V Classes.
8. 1 (Enabled) for 5.5 kW and 7.5 kW Inverters of 200 V and 400 V Classes.
9. Do not select 3 to 100 as they are reserved for future use.

No.	Name	V/f Control Mode (n002 = 0)	Vector Control Mode (n002 = 1)
n014	Mid. Output Frequency	1.3 Hz	3.0 Hz
n015	Mid. Output Frequency Voltage	$12.0 V^{*1 *2}$	$11.0 V^{*1}$
n016	Min. Output Frequency	1.3 Hz	1.0 Hz
n017	Min. Output Frequency Voltage	$12.0 V^{*1 *2}$	$4.3 V^{*1}$
n104	Torque Compensation Time Constant	0.3 s	0.2 s
n111	Slip Compensation Gain	0.0	1.0
n112	Slip Compensation Gain Time Constant	2.0 s	0.2 s

* 1. Values are doubled for 400 V Class.

* 2. 10.0 V for 5.5 kW and 7.5 kW Inverters of 200 V Class and 20.0 V of 400 V Class.

Factory Settings That Change with the Inverter Capacity

- 200 V Class 3-phase

No.	Name	Unit	Factory Setting								
			0.1 kW	0.25 kW	0.55 kW	1.1 kW	1.5 kW	2.2 kW	4.0 kW	5.5 kW	7.5 kW
-	Inverter Capacity	kW									
n036	Motor Rated Current	A	0.6	1.1	1.9	3.3	6.2	8.5	14.1	19.6	26.6
n105	Torque Compensation Iron Loss	W	1.7	3.4	4.2	6.5	11.1	11.8	19	28.8	43.9
n106	Motor Rated Slip	Hz	2.5	2.6	2.9	2.5	2.6	2.9	3.3	1.5	1.3
n107	Motor Line-to-neutral Resistance *	Ω	17.99	10.28	4.573	2.575	1.233	0.8	0.385	0.199	0.111
n108	Motor Leakage Inductance	mH	110.4	56.08	42.21	19.07	13.4	9.81	6.34	4.22	2.65
n110	Motor No-load Current	%	72	73	62	55	45	35	32	26	30
n159	Motor 2 Mid. Output Frequency Voltage	V	12.0	12.0	12.0	12.0	12.0	12.0	12.0	10.0	10.0
n160	Motor 2 Min. Output Frequency Voltage	V	12.0	12.0	12.0	12.0	12.0	12.0	12.0	10.0	10.0

* Sets the value of the motor resistance for one phase.

• 200 V Class Single-phase

No.	Name	Unit	Factory Setting						
			0.1 kW	0.25 kW	0.55 kW	1.1 kW	1.5 kW	2.2 kW	4.0 kW
-	Inverter Capacity	kW	0.1 kW	0.25 kW	0.55 kW	1.1 kW	1.5 kW	2.2 kW	4.0 kW
n036	Motor Rated Current	A	0.6	1.1	1.9	3.3	6.2	8.5	14.1
n105	Torque Compensation Iron Loss	W	1.7	3.4	4.2	6.5	11.1	11.8	19
n106	Motor Rated Slip	Hz	2.5	2.6	2.9	2.5	2.6	2.9	3.3
n107	Motor Line-to-neutral Resistance *	Ω	17.99	10.28	4.573	2.575	1.233	0.8	0.385
n108	Motor Leakage Inductance	mH	110.4	56.08	42.21	19.07	13.4	9.81	6.34
n110	Motor No-load Current	%	72	73	62	55	45	35	32
n159	Motor 2 Mid. Output Frequency Voltage	V	12.0	12.0	12.0	12.0	12.0	12.0	12.0
n160	Motor 2 Min. Output Frequency Voltage	V	12.0	12.0	12.0	12.0	12.0	12.0	12.0

* Sets the value of the motor resistance for one phase.

• 400 V Class 3-phase

No.	Name	Unit	Factory Setting								
			0.37 kW	0.55 kW	1.1 kW	1.5 kW	2.2 kW	3.0 kW	4.0 kW	5.5 kW	7.5 kW
-	Inverter Capacity	kW	0.37 kW	0.55 kW	1.1 kW	1.5 kW	2.2 kW	3.0 kW	4.0 kW	5.5 kW	7.5 kW
n036	Motor Rated Current	A	0.6	1.0	1.6	3.1	4.2	7.0	7.0	9.8	13.3
n105	Torque Compensation Iron Loss	W	3.4	4.0	6.1	11.0	11.7	19.3	19.3	28.8	43.9
n106	Motor Rated Slip	Hz	2.5	2.7	2.6	2.5	3.0	3.2	3.2	1.5	1.3
n107	Motor Line-to-neutral Resistance *	Ω	41.97	19.08	11.22	5.044	3.244	1.514	1.514	0.797	0.443
n108	Motor Leakage Inductance	mH	224.3	168.8	80.76	53.25	40.03	24.84	24.84	16.87	10.59
n110	Motor No-load Current	%	73	63	52	45	35	33	33	26	30
n159	Motor 2 Mid. Output Frequency Voltage	V	24.0	24.0	24.0	24.0	24.0	24.0	24.0	20.0	20.0
n160	Motor 2 Min. Output Frequency Voltage	V	24.0	24.0	24.0	24.0	24.0	24.0	24.0	20.0	20.0

* Sets the value of the motor resistance for one phase.

10 Conformance to CE Markings

Points regarding conformance to CE markings are given below.

■ CE Markings

CE markings indicate conformance to safety and environmental standards that apply to business transactions (including production, imports, and sales) in Europe. There are unified European standards for mechanical products (Machine Directive), electrical products (Low Voltage Directive), and electrical noise (EMC Directive). CE markings are required for business transactions in Europe (including production, imports, and sales).

The V7AZ Series Inverters bear CE markings indicating conformance to the Low Voltage Directive and the EMC Directive.

- Low Voltage Directive: 73/23/EEC
93/68/EEC
- EMC Directive: 89/336/EEC
92/31/EEC
93/68/EEC

Machinery and installations that incorporate the Inverter are also subject to CE markings. It is ultimately the responsibility of customers making products incorporating the Inverter to attach CE markings to the finished products. The customer must confirm that the finished products (machines or installations) conform to the European Standards.

■ Requirements for Conformance to CE Markings

□ Low Voltage Directive

V7AZ Series Inverters satisfy testing for conformance to the Low Voltage Directive under the conditions described in European Standard EN50178.

Requirements for Conformance to the Low Voltage Directive
V7AZ Series Inverters must satisfy the following conditions in order to conform to the Low Voltage Directive.

- Only basic insulation to meet the requirements of protection class I and overvoltage category II is provided with control circuit terminals. Additional insulation may be necessary in the end product to conform to CE requirements.

-
- For 400 V Class Inverters, always ground the supply neutral to conform to CE requirements.

□ EMC Directive

V7AZ Series Inverters satisfy testing for conformance to the EMC Directive under the conditions described in European Standard EN61800-3.

Installation Method

In order to ensure that the machinery or installation incorporating the Inverter conforms to the EMC Directive, perform installation according to the method below.

- Install a noise filter that conforms to European Standards on the input side. (Refer to *EMC Noise Filter* on page 251.)
- Use a shielded line or metal piping for wiring between the Inverter and Motor. Make the wiring as short as possible.
- For details of installation method, refer to Installation Manual (document No. EZZ006543.)

Installation and Wiring of Inverter and Noise Filter
(Model: CIMR-V7□□20P1 to 27P5),
(Model: CIMR-V7□□40P1 to 45P5)

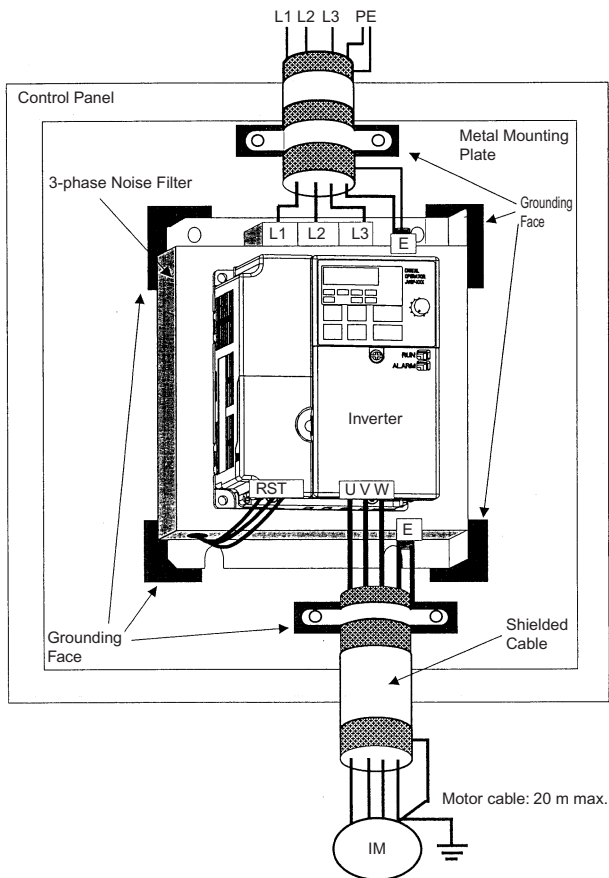

Installation and Wiring of Inverter and Noise Filter (Model: CIMR-V7□□B0P1 to B4P0)

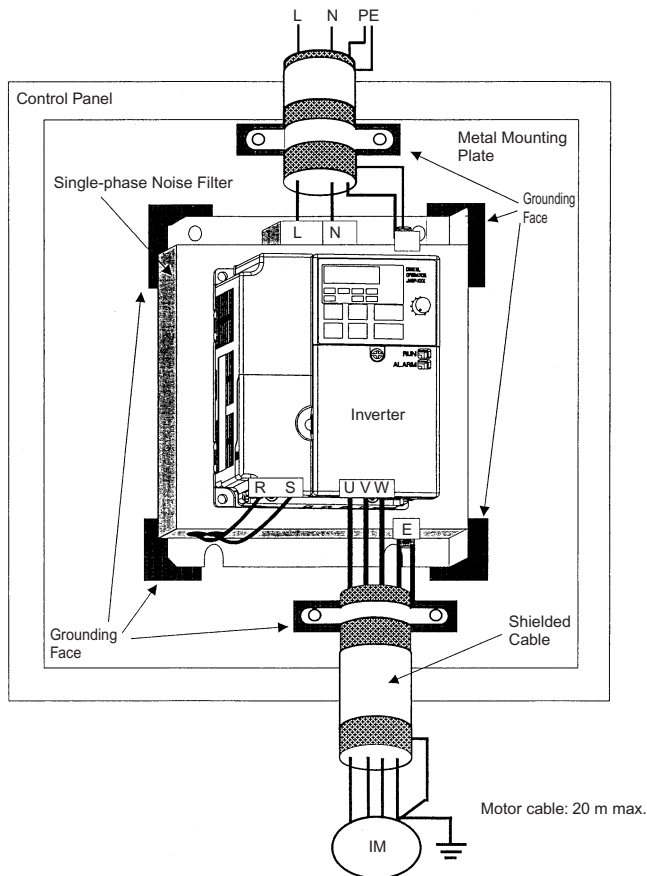

EMC Noise Filter

Voltage Class	Inverter Model CIMR-V7AZ	Noise Filter (Manufacturer: RASMI)						
		Model No.	Number of Phases	Rated Current (A)	Mass (kg)	Dimensions W×L×H	Y×X	φd
200 V	B0P1	3G3MV-PFI1010	1	10	0.6	71 × 169 × 45	51 × 156	5.0
	B0P2							
	B0P4							
	B0P7	3G3MV-PFI1020	1	20	1.0	111 × 169 × 50	91 × 156	5.0
	B1P5							
	B2P2	3G3MV-PFI1030	1	30	1.1	144 × 174 × 50	120 × 161	5.0
	B3P7							
	B4P0	3G3MV-PFI1040	1	40	1.2	174 × 174 × 50	150 × 161	5.0
	20P1							
	20P2	3G3MV-PFI2010	3	10	0.8	82 × 194 × 50	62 × 181	5.0
	20P4							
	20P7							
	21P5							
	22P2	3G3MV-PFI2020	3	16	1.0	111 × 169 × 50	91 × 156	5.0
	23P7							
	24P0	3G3MV-PFI2030	3	26	1.1	144 × 174 × 50	120 × 161	5.0
25P5								
27P5	3G3MV-PFI2050	3	50	2.3	184 × 304 × 56	150 × 264	6.0	
400 V								
400 V	40P2	3G3MV-PFI3005	3	5	1.0	111 × 169 × 45	91 × 156	5.0
	40P4							
	40P7	3G3MV-PFI3010	3	10	1.0	111 × 169 × 45	91 × 156	5.0
	41P5							
	42P2							
	43P0	3G3MV-PFI3020	3	15	1.1	144 × 174 × 50	120 × 161	5.0
	43P7							
	44P0							
	45P5	3G3MV-PFI3030	3	30	2.3	184 × 304 × 56	150 × 264	6.0
	47P5							

The EMC-compliant V7 Series noise filter is footprint type.

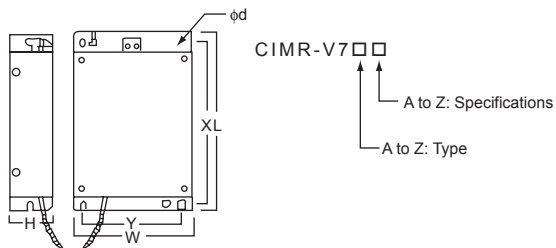

Revision History

The revision dates and numbers of the revised manuals are given on the bottom of the back cover.

MANUAL NO. TOEP C710606 05A

© Printed in Japan March 2005 05-03
└ Date of printing └ Date of original publication

Date of Printing	Rev. No.	Section	Revised Content
March 2005	-		First edition