

**SYSMAC**  
**C20K, C28K, C40K, C60K**  
**Programmable Controllers**

**INSTALLATION GUIDE**

**OMRON**

# K-type Programmable Controllers

## Installation Guide

*September 1993*

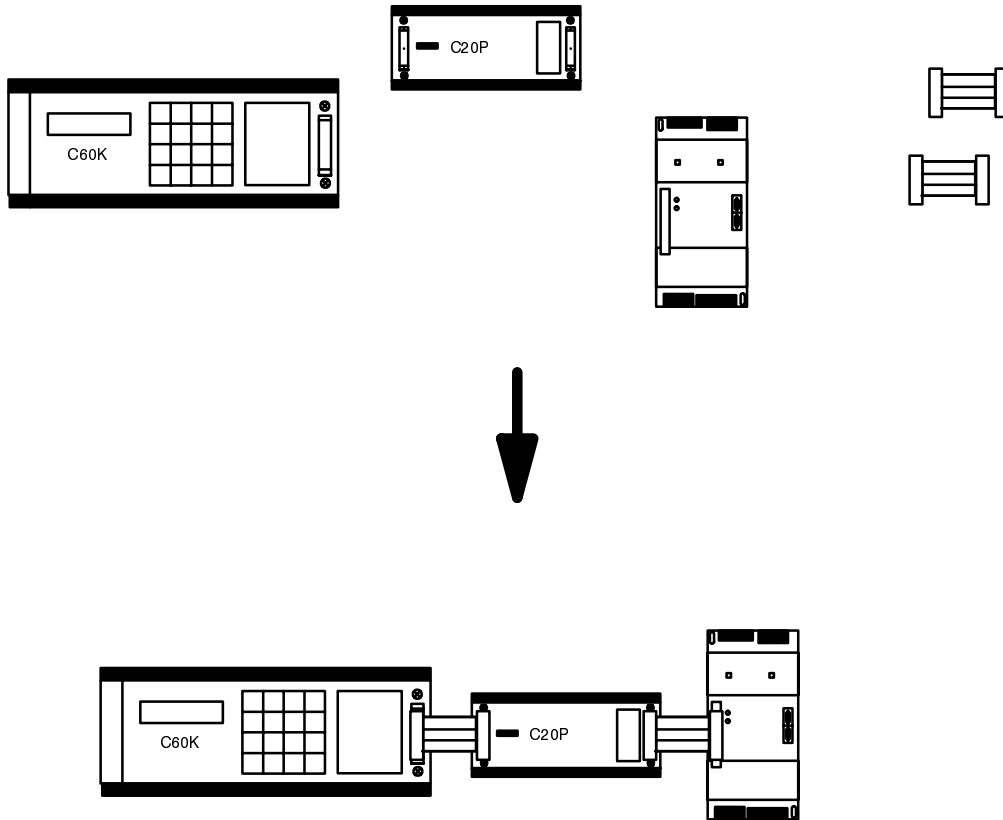

## **Notice:**

OMRON products are manufactured for use according to proper procedures by a qualified operator and only for the purposes described in this manual.

The following conventions are used to indicate and classify precautions in this manual. Always heed the information provided with them. Failure to heed precautions can result in injury to people or damage to the product.

**DANGER!** Indicates information that, if not heeded, is likely to result in loss of life or serious injury.

**WARNING** Indicates information that, if not heeded, could possibly result in loss of life or serious injury.

**Caution** Indicates information that, if not heeded, could result in relative serious or minor injury, damage to the product, or faulty operation.

## **OMRON Product References**

All OMRON products are capitalized in this manual. The word “Unit” is also capitalized when it refers to an OMRON product, regardless of whether or not it appears in the proper name of the product.

The abbreviation “Ch,” which appears in some displays and on some OMRON products, means “word” and is abbreviated “Wd” in documentation.

## **Visual Aids**

The following headings appear in the left column of the manual to help you locate different types of information.

**Note** Indicates information of particular interest for efficient and convenient operation of the product.

**1, 2, 3...** Indicates lists of one sort or another, such as procedures, precautions, etc.

## **© OMRON, 1989**

All rights reserved. No part of this publication may be reproduced, stored in a retrieval system, or transmitted, in any form, or by any means, mechanical, electronic, photocopying, recording, or otherwise, without the prior written permission of OMRON.

No patent liability is assumed with respect to the use of the information contained herein. Moreover, because OMRON is constantly striving to improve its high-quality products, the information contained in this manual is subject to change without notice. Every precaution has been taken in the preparation of this manual. Nevertheless, OMRON assumes no responsibility for errors or omissions. Neither is any liability assumed for damages resulting from the use of the information contained in this publication.

# TABLE OF CONTENTS

## SECTION 1

<b>Introduction</b> .....	<b>1</b>
1-1 Nomenclature .....	2
1-2 System Configuration .....	7

## SECTION 2

<b>System Installation and Wiring</b> .....	<b>9</b>
2-1 General .....	10
2-2 Installation Environment .....	10
2-3 Dimensions and Installation .....	12
2-4 I/O Connecting Cable .....	16
2-5 Wiring CPUs and Expansion I/O Units .....	19
2-6 I/O Wiring .....	22
2-7 Special Wiring Precautions .....	39
2-8 Settings .....	41

## SECTION 3

<b>Maintenance and Inspection</b> .....	<b>47</b>
3-1 General .....	48
3-2 Self-Diagnostic Functions .....	48
3-3 Replacing Parts .....	49
3-4 Preventive Measures .....	52
3-5 Inspection .....	54

## Appendices

A Standard Models .....	55
B Specifications .....	63
C Programming Console Operations .....	69
D Programming Instructions .....	71
E System Configuration Chart .....	77

<b>Index</b> .....	<b>83</b>
--------------------	-----------

<b>Revision History</b> .....	<b>85</b>
-------------------------------	-----------

## ***About this Manual:***

This manual has been prepared to provide the information necessary to install, set up, and maintain your C-series K-type Programmable Controller, a low-cost, compact, versatile industrial control system providing up to 148 I/O points. For information regarding system programming and operation, refer to the operation manual.

Refer to the Appendix for a complete list of all products covered in this manual, including complete part numbers.

# SECTION 1

## Introduction

- 1-1 Nomenclature ..... 2
  - 1-1-1 CPUs ..... 2
  - 1-1-2 Expansion I/O Units ..... 3
  - 1-1-3 Analog Timer Unit ..... 5
  - 1-1-4 I/O Link Units ..... 6
- 1-2 System Configuration ..... 7

# 1-1 Nomenclature

This section gives the names and functions of the various components of K-Type PCs and the basic Units with which they can be combined in a System.

## 1-1-1 CPUs

In the diagram below, the C20K is shown as a representative model. Refer to Appendix A Standard Models for your model's exact specifications.

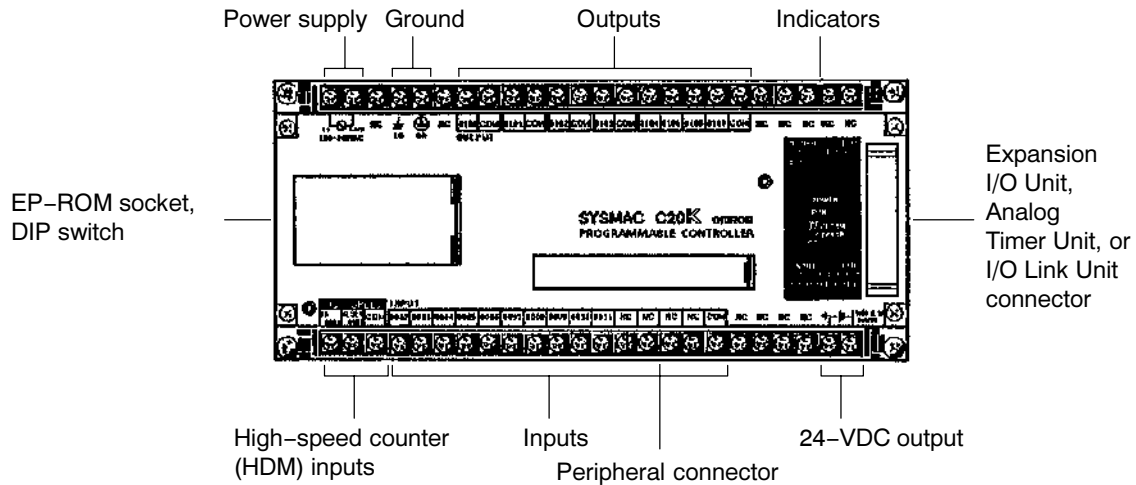

### High-speed Counter

When the high-speed counter (HDM(61)) is not being used, the two high-speed counter input terminals can be used as normal DC input terminals. Their ON/OFF response time, however, will be shorter (0.15 ms max.). Regardless of whether the high-speed counter command is being used, DIP switch pins 7 and 8 must be off whenever the hardware reset is not being used.

### Indicators

The diagram below shows the functions of the various indicators, taking the C20K as an example.

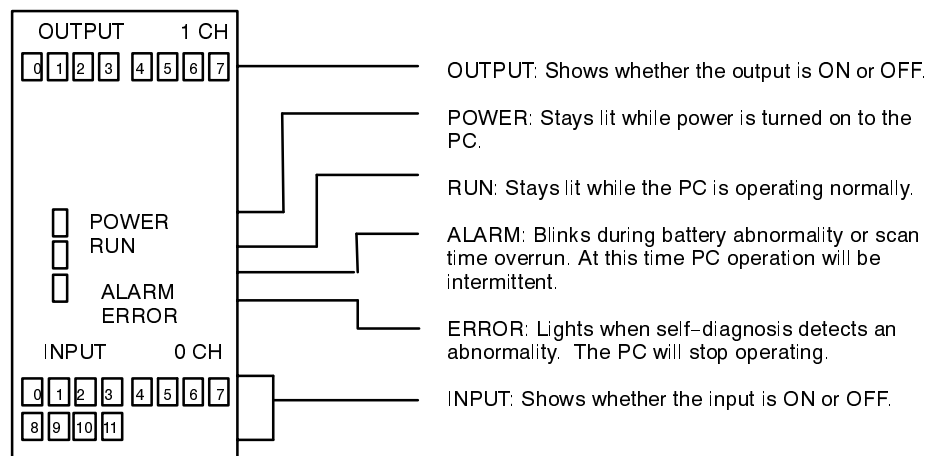

### Memory

Each of the C-Series K-Type PCs is provided with a built-in RAM (random-access memory), as well as a ROM (read-only memory) chip socket. Either may be used with ease. It is recommended to use the RAM for programming and, when the program is completed, to save it in a ROM chip for protection. The memory capacity in either case is 1,194 addresses.

**ROM Socket and DIP Switch**

Beneath the cover are the DIP switch and the socket where an EP-ROM chip may be installed. For details, see 2-7-1 Setting the CPU Dipswitch and 2-7-2 EP-ROM Installation. Only DIP switch pins 1 and 2 are on when the CPU is delivered.

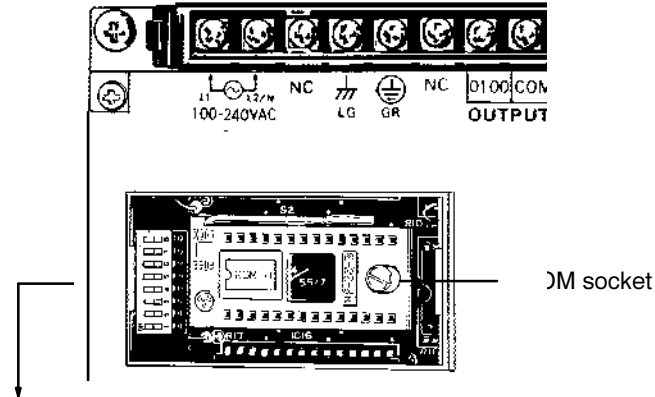

8	Turn ON to use hardware reset (0001).
7	Turn OFF if HDM(61) is not used.
6	Turn ON for English display.
5	Turn ON to inhibit ALARM indicator.
4, 3	ROM: ON (RAM: OFF)
2, 1	RAM: ON (ROM: OFF)

CAUTION: In case of battery failure, data stored in the RAM, the DM area, the HR area, etc., will not be preserved.

**1-1-2 Expansion I/O Units**

In the diagram below, the C20P is shown as a representative model. Refer to Appendix A Standard Models for your model's exact specifications.

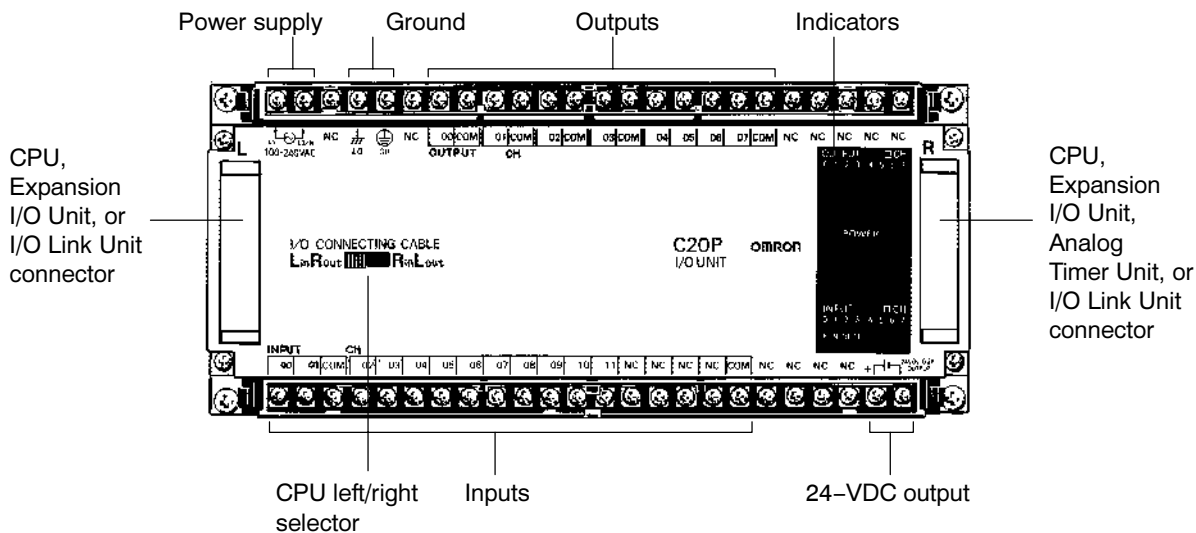

**Indicators**

The following diagram shows the functions of the various indicators, taking the C20P as an example.

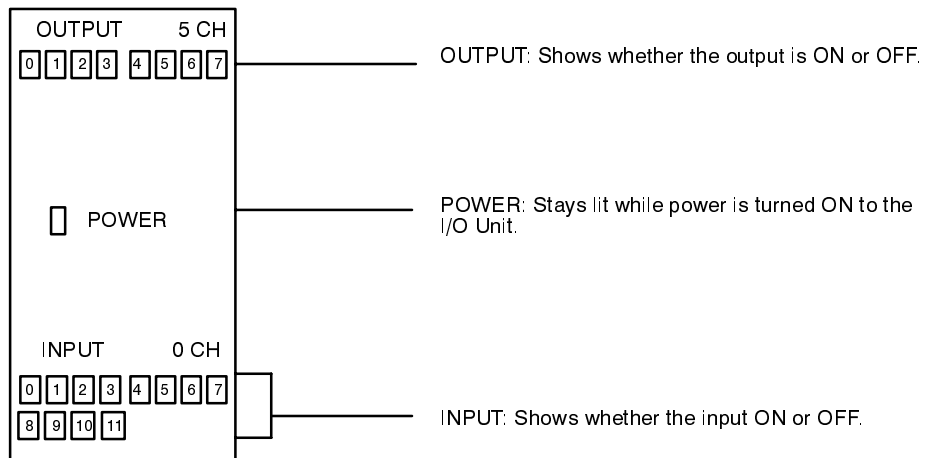

**CPU Left/Right Selector**

The C20P, C28P, C40P, and C60P Expansion I/O Units all have CPU left/right selector switches. The C16P and C4K do not. For those models which have the switch, care must be taken to set it so that it corresponds with the direction of the I/O Connecting Cable. If the switch is set to the wrong position, the System will operate as if the I/O Unit were not there. Set the switch so that the CPU connector side (Left or Right) is "in," as shown in the following diagram. Do not change the switch setting after power has been turned ON, because the I/O bus will malfunction.

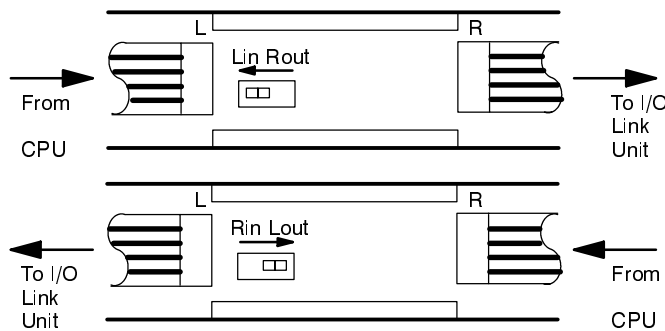

The following example diagrams show the proper switch settings for horizontal and vertical mounting of Units.

**Horizontal Mounting**

(All Units can be positioned horizontally.)

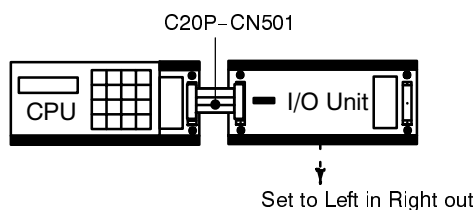

**Vertical Mounting**

(All Units except the C16P and C4K can be positioned vertically.)

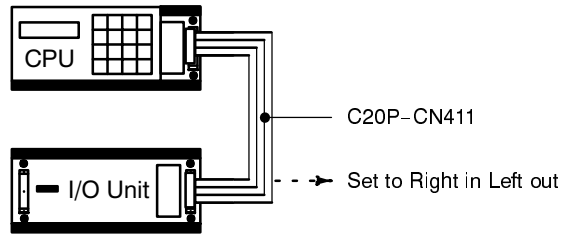

**1-1-3 Analog Timer Unit**

**Internal variable resistors**

These variable resistors are used to set the timers and, from left to right, correspond to T0 to T3. The settings of these resistors are effective only when the corresponding IN/EXT selector is set to IN. To set or adjust the time, use the screwdriver supplied with the Analog Timer Unit. Turn the variable resistor shafts clockwise to increase the time value.

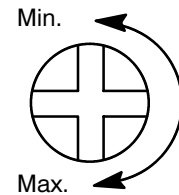

**CPU connector**

Install and connect the Expansion I/O Unit and the CPU horizontally; otherwise the Analog Timer Unit cannot be connected to the CPU.

**I/O Connecting Cable**

C4K-CN502  
One cable is supplied with the Analog Timer Unit

**IN/EXT selectors**

When using the internal variable resistor, set the corresponding selector to IN; when using an external resistor, set the corresponding selector to EXT. These selectors correspond to T0 to T3 from left to right.

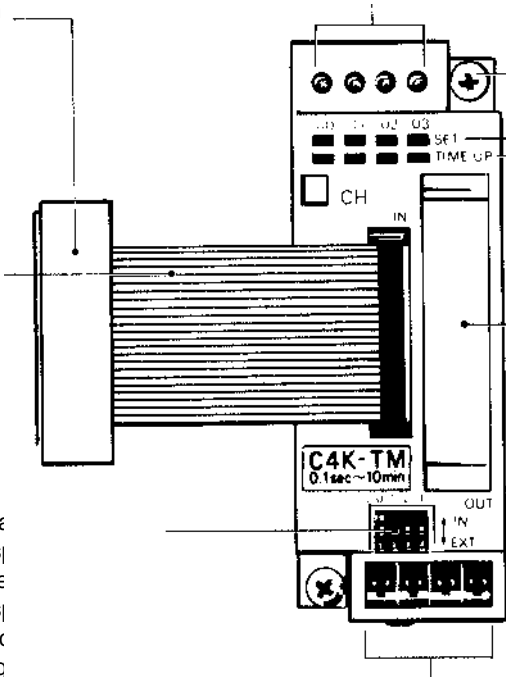

Two M4 mounting screws (self-rising pressure plate)

**Indicators**

The SET indicators in the top row light while timer values are being set. The TIME UP indicators in the bottom row light when the corresponding timer contact (T0 to T3) turns ON. Numbers 00 to 03 correspond to T0 to T3.

This connector is not used. Do not remove the cover.

**External variable resistor connectors**

When using external variable resistors to set the timers, connect the resistors to these connectors. The corresponding IN/EXT selector must be set to the EXT position. These connectors correspond to T0 to T3 from left to right. Use 20 kΩ external variable resistors.

**External Variable Resistor** The contactor employs solderless terminals and must be wired as shown below, using AWG 28 to 22 lead wires.

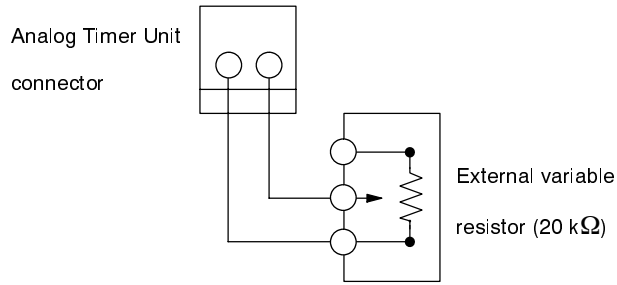

### 1-1-4 I/O Link Units

The I/O Link Unit must be used as a Remote I/O Device and must be used with a Remote Master Module. Refer to the SYSMAC BUS Remote I/O System Manual (Cat. no. W120) for details.

**Operation output terminal**  
Indicates that the power is ON and that the CPU is in RUN or MONITOR mode with no errors.

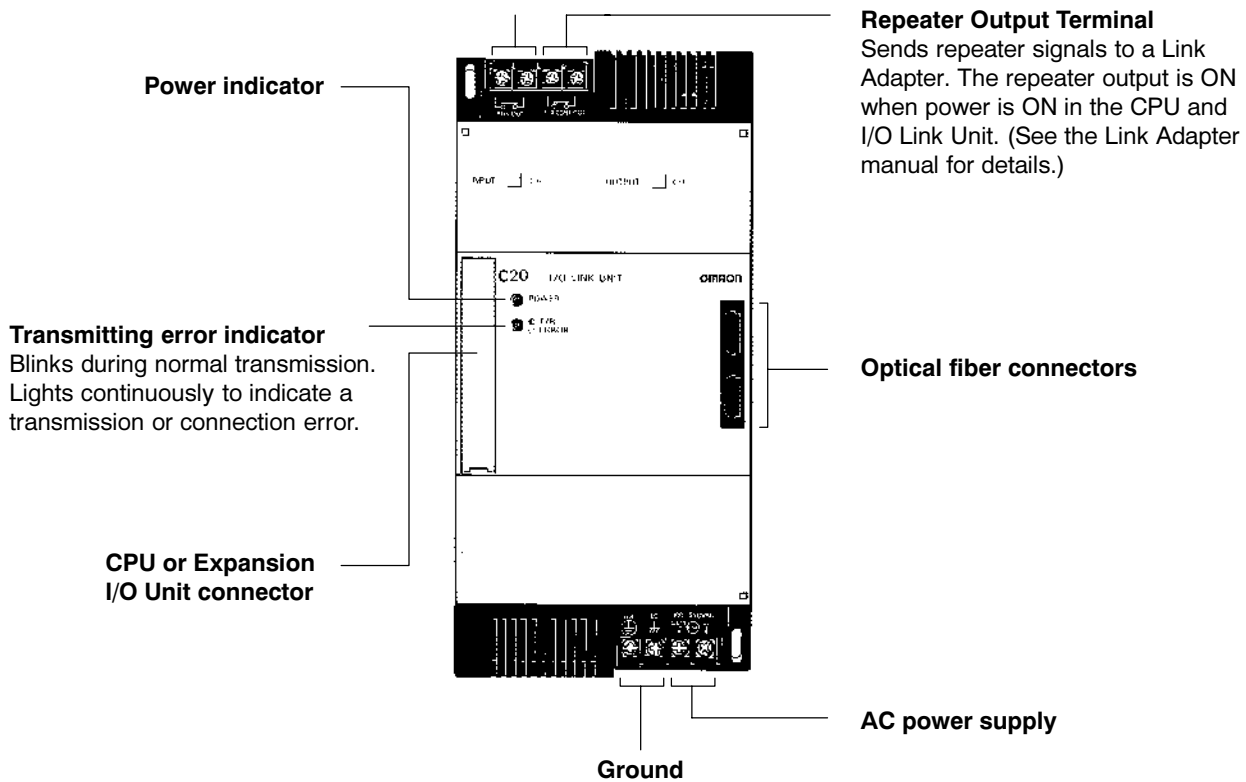

## 1-2 System Configuration

Depending on your control requirements, you can combine various Units for a total number of I/O points ranging anywhere from 20 to 148.

For example, a single C20K CPU, with no Expansion I/O Units connected, has a total of 20 I/O points, broken down into 12 input points and 8 output points. If it is used in combination with a C4K Input Unit, there will be a total of 16 input points and 8 output points. If combined with a C4K Output Unit, the total will be 12 input points and 12 output points.

If the C20K is combined with a C16P Expansion I/O Unit, there will be a sum total of 36 I/O points. If the C16P is an Input Unit, they will be broken down into 28 input points and 8 output points; if it is an Output Unit, there will be 12 input points and 24 output points. For a listing of possible Unit combinations and numbers of I/O points, see Appendix E System Configuration Chart.

Only one Expansion I/O Unit with the suffix "P" can be connected to any given CPU. It is possible to add more than one C4K, but under no circumstances can the total number of I/O points exceed 148. Either one Analog Timer Unit or one I/O Link Unit can be added to any other possible combination of Units.

When determining which configuration to use, another factor to consider is the ease with which I/O points can be assigned. In order to make the process as simple as possible, it is recommended that a CPU be used which has more I/O points than the largest Expansion I/O Unit. For example, rather than combining a C20P CPU with a C20P Expansion I/O Unit, it would be preferable to use a C40P CPU. Similarly, combining a C60P CPU with a C40 Expansion I/O Unit would be better than using a C40P CPU and a C60P Expansion I/O Unit.

This is intended only as a brief overview of system configuration possibilities. In addition to Appendix E System Configuration Chart (mentioned above), see the I/O tables in the operation manual for details on various possible combinations of Units and the particular I/O bits and IR area work bits which are available for use in each configuration.

## SECTION 2

# System Installation and Wiring

2-1	General .....	10
2-2	Installation Environment .....	10
2-3	Dimensions and Installation .....	12
2-4	I/O Connecting Cable .....	16
2-5	Wiring CPUs and Expansion I/O Units .....	19
2-6	I/O Wiring .....	22
2-6-1	Unit Wiring Diagrams .....	22
2-6-2	I/O Device Connection Examples .....	38
2-7	Special Wiring Precautions .....	39
2-8	Settings .....	41
2-8-1	Setting the CPU DIP Switch .....	41
2-8-2	EP-ROM Installation .....	42
2-8-3	High-Speed Counter .....	42
2-8-4	Inhibiting the ALARM Indicator .....	43
2-8-5	Setting the I/O Link Unit .....	43

## 2-1 General

This section explains how to install and set up your Control System, with specifics on the proper environment, actual mounting, applicable cable, wiring, and switch settings.

## 2-2 Installation Environment

Although the K-Type Programmable Controller is quite durable, the following conditions must be observed in order for your System to operate at its highest level of reliability.

Ambient temperature	Operating: 0° to 55°C* Storage: -20 to 65°C
Humidity	35% to 85% RH (without condensation)
Atmosphere	Must be free from the following: <ul style="list-style-type: none"> <li>• Corrosive gases</li> <li>• Abrupt temperature changes</li> <li>• Direct sunlight</li> <li>• Concentration of dust, salt, iron particles</li> <li>• Splatter from water, oil, other chemicals</li> </ul>
Vibration and shock	Must not receive direct impact or vibration

\*The ambient operating temperature for the Programming Console is 05 to 455

### CAUTION

In low humidity conditions, excessive static electricity of over 8 KV can damage internal components such as ICs. Therefore, before touching the PC, be sure to first touch a grounded metallic object to discharge any static electricity build-up.

### Noise Prevention

Use twisted pair cables with cross-sectional areas of at least 2 mm<sup>2</sup>/conductor (AGW 14) to prevent noise. Avoid mounting the PC close to high-power equipment, and be sure to mount it at least 200 mm away from power lines. Wherever possible, use wiring ducts to contain and protect the PC wiring. The I/O wiring should not be placed in the same duct with the power line or other wiring. Standard wiring conduits are sufficient as long as the I/O wiring and power lines are kept separate.

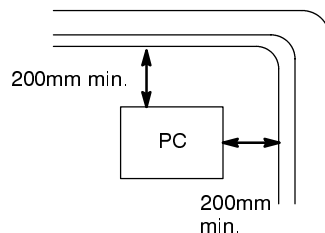

Duct Work

When CPUs and Expansion I/O Units are mounted horizontally, be sure that no ducts or wiring passes between them. The diagram shows an example of unacceptable mounting.

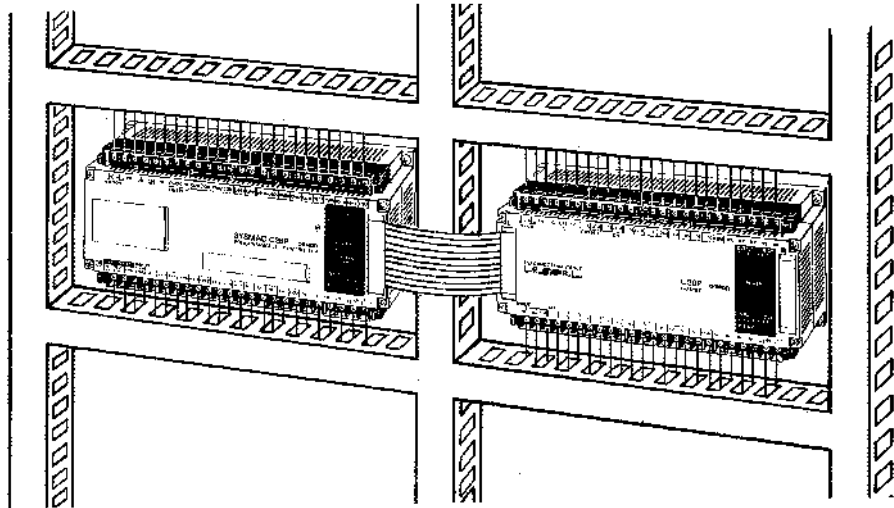

If the controlled system requires either 10 A at 400 V max. or 20 A at 220 V max. power cables, and if the conduits are run parallel to each other, a minimum distance of 300 mm must be provided between the I/O lines and the power cable. If the I/O lines and the power cables must be placed in the same duct at the point of connection to the equipment, be sure to screen them with a grounded metal plate.

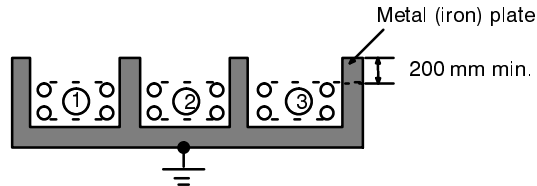

Grounding (at a ground resistance of less than 100 Ω)

- 1 PC I/O circuit
- 2 PC power circuit
- 3 General control circuit/Power circuit

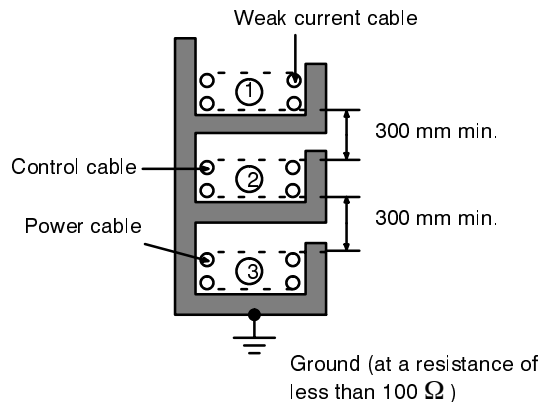

Ground (at a resistance of less than 100 Ω)

### 2-3 Dimensions and Installation

This section gives dimensions and other information necessary for mounting the CPUs, Expansion I/O Units, Analog Timer Units, and I/O Link Units. All measurements are in mm.

**CPUs** (The C20K is shown as an example.)

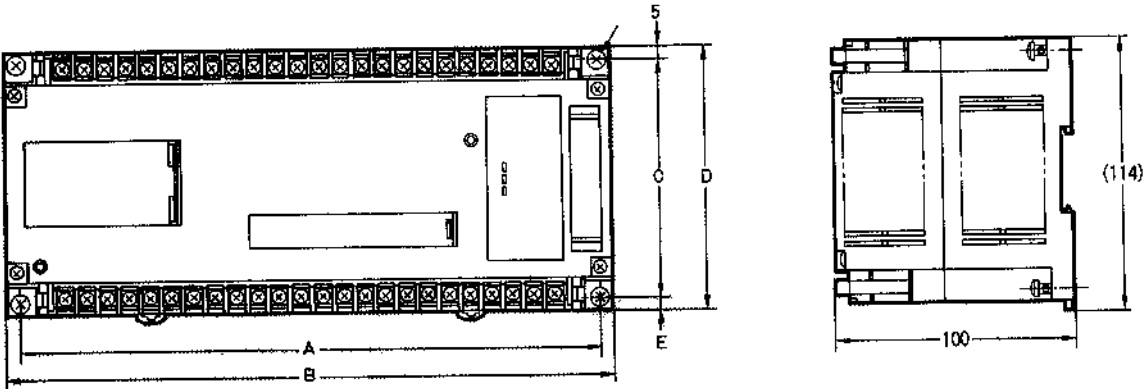

Model	A	B	C	D	E
C20K	240	250	100	110	5
C28K	240	250	100	110	5
C40K	290	300	100	110	5
C60K	340	350	120	140	15

**Expansion I/O Units** (The C20P is shown as an example.)

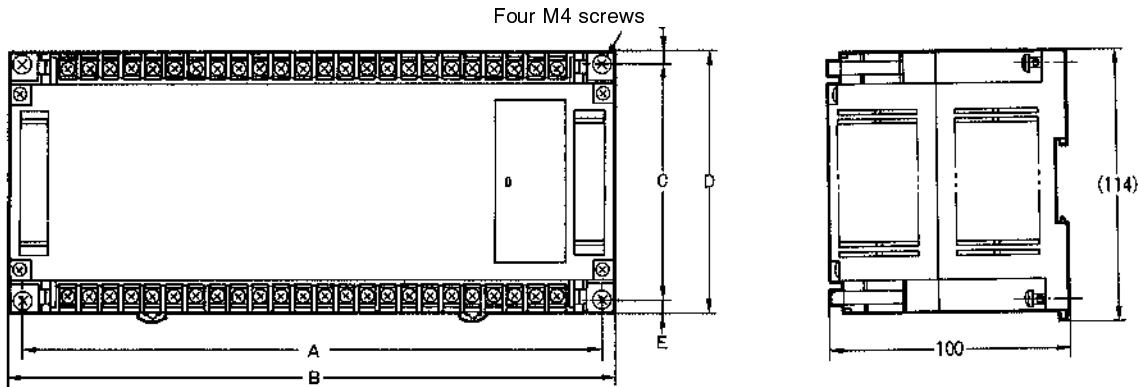

Expansion I/O Units cont.

C4K

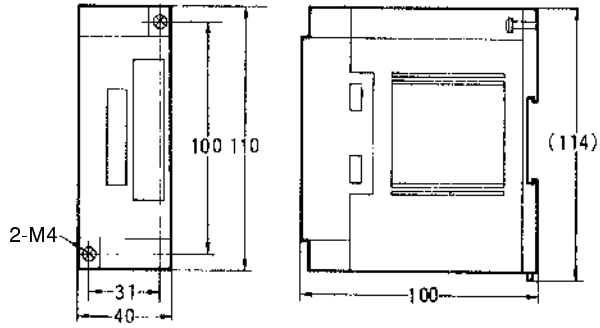

Model	A	B	C	D	E
C16P	145	155	100	110	5
C20P	240	250	100	110	5
C28P	240	250	100	110	5
C40P	290	300	100	110	5
C60P	340	350	120	140	15

Analog Timer Units

C4K-TM

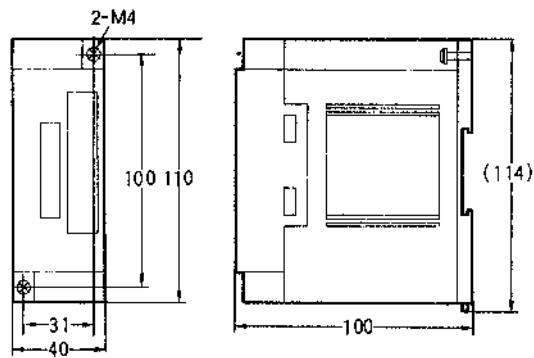

I/O Link Units

C20-LK011(-P)

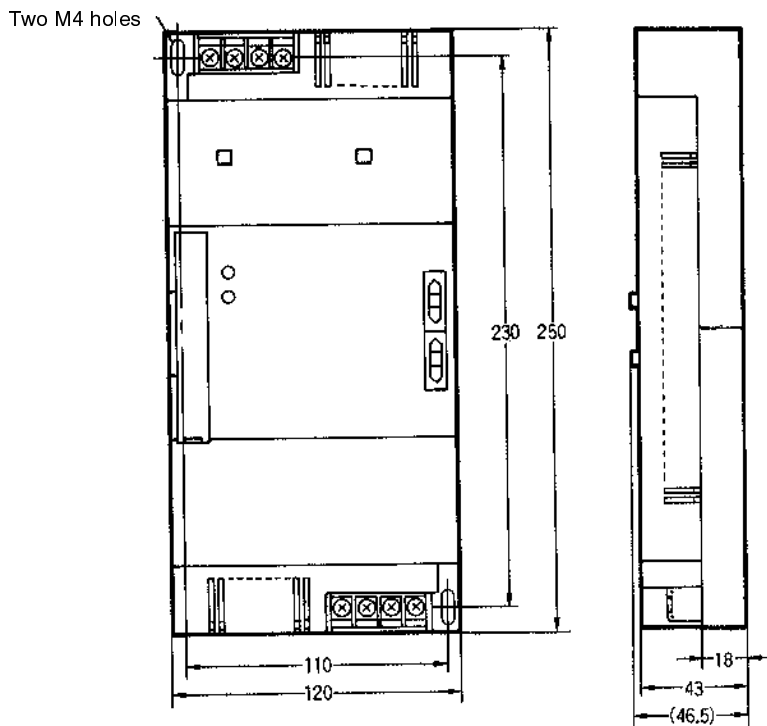

DIN Rails

PFP-50N/PFP-100N

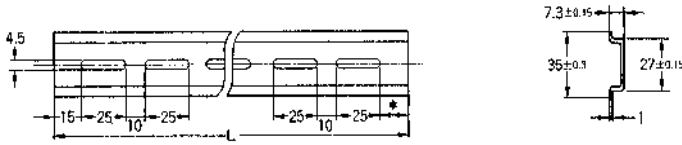

Model	L	*
PFP-50N	50 cm	5
PFP-100N	1 m	15
PFP-100N2	1 m	--

PFP-100N2

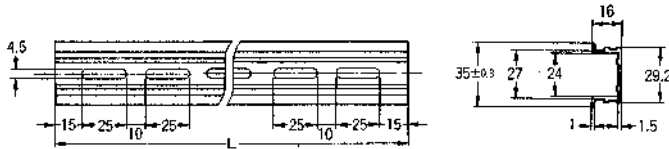

Use the PFP-100N2 for the C60P. If the PFP-50N or PFP-100N are used, the Unit will be slanted.

Endplate PFP-M

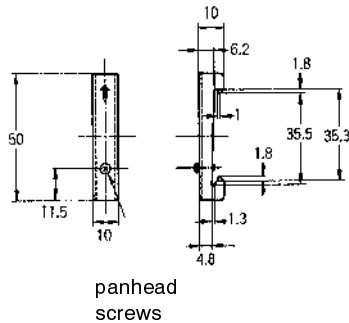

Spacer PFP-S

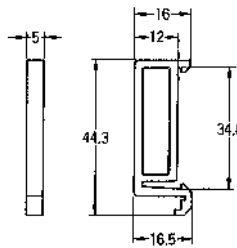

Mounting

A CPU and Expansion I/O Unit may be mounted either vertically or horizontally in relation to each other but the orientation of each unit itself must remain horizontal as described by the following mounting diagrams. If mounting the units vertically, position the CPU above the Expansion I/O Unit; if mounting horizontally, position the CPU to the left.

When installing the CPUs, Expansion I/O Units, and I/O Link Units, allow sufficient space between the Units for cooling. Models taking a 100- to 240-VAC power supply require a minimum cooling space of 10 mm between Units. Avoid mounting any units in warm areas or over a heat source of any kind. In addition, if the CPU is installed in a control box, allow sufficient space for maintenance and ventilation. It may be necessary to install a ventilation fan in the control box to maintain the required ambient temperature as indicated in Appendix B Specifications.

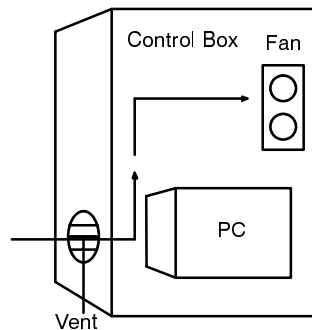

Another factor to consider is the I/O wiring (see 2-5 I/O Wiring). If the CPU and/or Expansion I/O Units are mounted vertically, a minimum of 70 mm open space is required for ease of I/O wiring. The spacing of the mounting holes, for both vertical and horizontal mounting is as shown below.

Horizontal Mounting

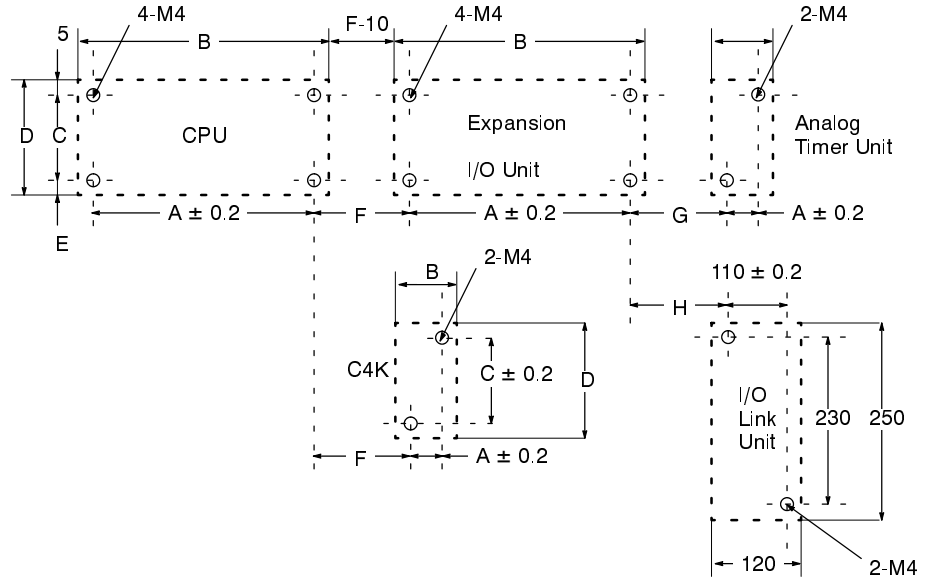

Vertical Mounting

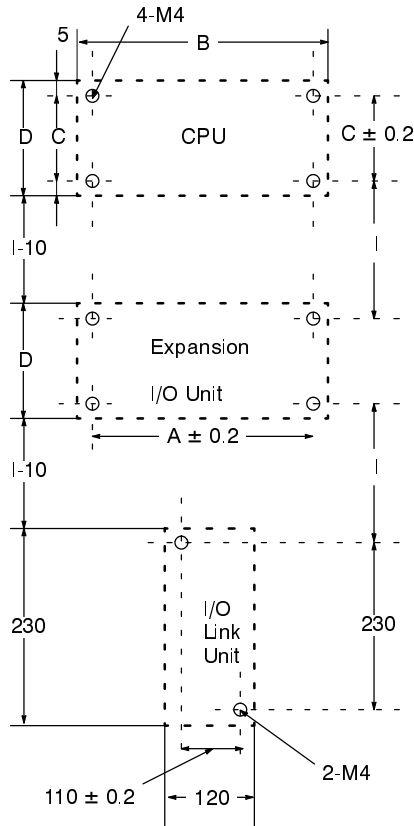

Model		A±0.2	B	C±0.2	D	E
CPU	C20K	240	250	100	110	5
	I/O Unit	C28K	240	250	100	110
	C40K	290	300	100	110	5
	C60K	340	350	120	140	15
I/O Unit	C16P	145	155	100	110	5
	C4K	31	40	100	110	5
Analog Timer Unit	C4K -TM	31	40	100	110	5

F	G	H	I
15 to 40	15 to 35	20 to 40	80 to 130

Attach End Plates (PFP-M) to both ends (as shown below) when connecting CPUs, Expansion I/O Units, or Analog Timer Units to a DIN Rail. It is also recommended that a Spacer (PFP-S) be installed between a CPU and Expansion I/O Unit when they are mounted horizontally.

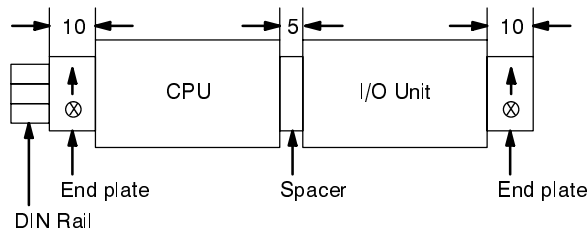

Mounting screws are included with CPUs, Expansion I/O Units, and Analog Timer Units. They must be purchased separately for I/O Link Units.

## 2-4 I/O Connecting Cable

Applicable connecting cable will vary according to which Units are connected and whether they are mounted horizontally or vertically. All Expansion I/O Units, except the C16P and C4K, use C20P-CN501 cable (5 cm) for horizontal mounting and C20P-CN411 cable (40 cm) for vertical mounting. The C16P and C4K cannot be mounted vertically. The C16P can use either of the above-mentioned cables for horizontal mounting. The C4K can use only C4K-CN501 cable (5 cm). For connecting I/O Link Units, use C20P-CN711 cable (70 cm).

**CAUTION:**

Always be sure to use only the cable that is included with the Unit. Using the wrong cable (such as the C20 I/O Connecting Cable or I/O Link Connecting Cable) for connecting Expansion I/O Units can cause serious damage to the Units.

The following diagrams illustrate the appropriate cables for connecting CPUs, Expansion I/O Units, and I/O Link Units either horizontally or vertically.

**Horizontal Mounting**

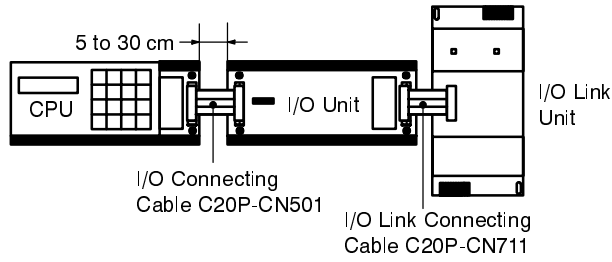

**Vertical Mounting**

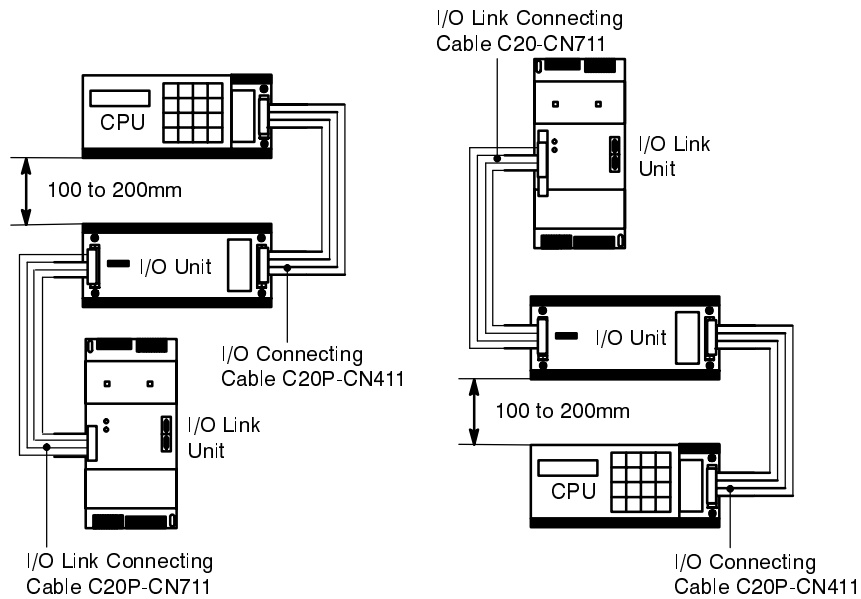

**Connecting Analog Timer Units**

One Analog Timer Unit can be connected directly to a CPU or to any combination of a CPU and Expansion I/O Units. In either case, as shown in the following diagram, the Units must be mounted horizontally.

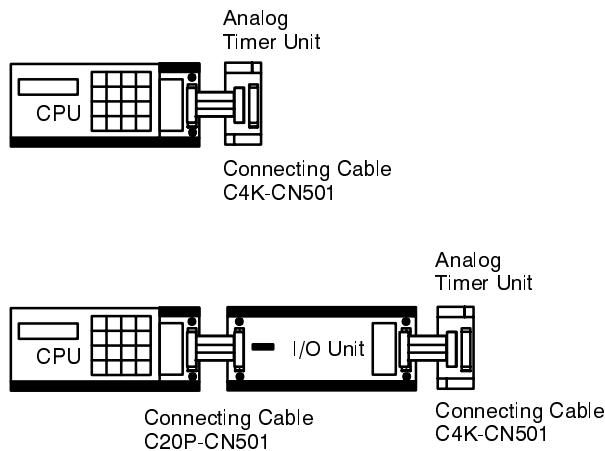

**Connecting I/O Link Units** One I/O Link Unit can be connected directly to a CPU or to any combination of a CPU and Expansion I/O Units. It cannot be used in the same PC System with an Analog Timer Unit.

**Connection Procedure** Follow these four steps to connect Expansion I/O Unit, Analog Timer, and I/O Link Unit Connecting Cables.

- 1, 2, 3...**
1. Remove the connector cover from the CPU, using a screwdriver if necessary.
  2. Insert one of the cable's connectors into the cover. (Once inserted, the connector cannot be removed.)
  3. Re-insert the cover/connector combination into the CPU.
  4. Repeat this procedure on the other end of the cable.

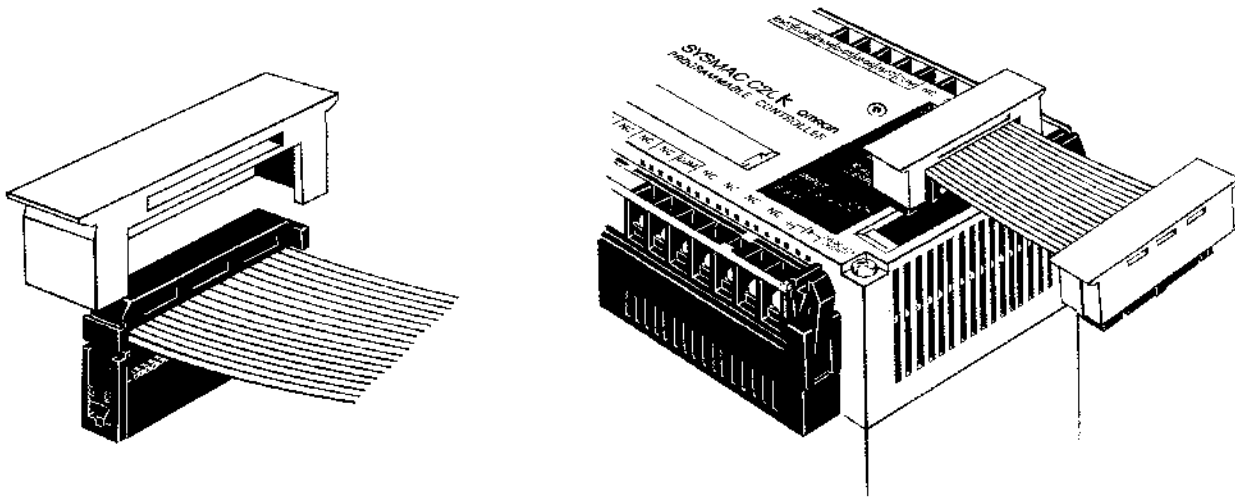

### Optical Fiber Cable

Optical fiber cable can be used for extending transmission distance and reducing noise. There are three types, and the appropriate cable for any given situation will depend on the desired transmission distance and the particular Units which need to be connected.

All-plastic optical fiber cable (APF) is for short-distance transmission (up to 20 m) and can be used only by Units with the suffix -P attached. Plastic-clad optical fiber cable (PCF) is for middle-distance transmission (up to 200 m for Units with -P and 800 m for Units without -P). Crystal optical fiber cable (AGF) is for long-distance transmission (up to 3 km) and can be connected only to certain Link Adapters.

Although laying optical fiber cable does not basically differ from laying wire cable, there are certain precautions which should be observed. For details, refer to the Optical Remote I/O Systems manual.

### Link Adapters

Although it is normally possible to connect Units in series, a failure (power failure, disconnection, etc.) in one of the Units will cause all the subsequent Units to cease operating. You can use Link Adapters to prevent this type of situation from occurring. Even if a power failure occurs in a Unit connected to a branch line of a Link Adapter, the Link Adapter will bypass that Unit and continue to transmit signals to the other Units. You can also use Link Adapters for branching and for converting between various types of wire and optical cable. For details on these and other functions of Link Adapters, refer to the Link Adapter manual.

## 2-5 Wiring CPUs and Expansion I/O Units

### Power Supply

Use a commercially available 24-VDC, 100- to 120-VAC, or 200- to 240-VAC power supply (depending on your model) for the CPU. When an Expansion I/O Unit(s) or an I/O Link Unit is used, the power supply must also be connected to each of these Units. Where possible, use independent power sources for the inputs, the output loads, and the CPU. All of the CPUs and Expansion I/O Units may be connected to the same power source. If a CPU and an Expansion I/O Unit are connected to separate power supplies, then the CPU (as well as the Programming Console, etc.) will not operate unless power is turned on to the Expansion I/O Unit.

### Wiring

The following diagram illustrates the proper wiring for CPUs and Expansion I/O Units with the suffix -A. These models use a power supply of 100 to 240 VAC, with an operating voltage range of 85 to 264 VAC. The internal noise-reduction system in these Units is sufficient for general power line noise, but ground noise can be greatly reduced by using a 1:1 insulating transformer. Ground only the primary side of the transformer. To prevent voltage drop, use wires 2 mm<sup>2</sup> or less in cross sectional area, twisting them as shown in the diagram. When power is turned ON, the incoming current will be approximately 10 A.

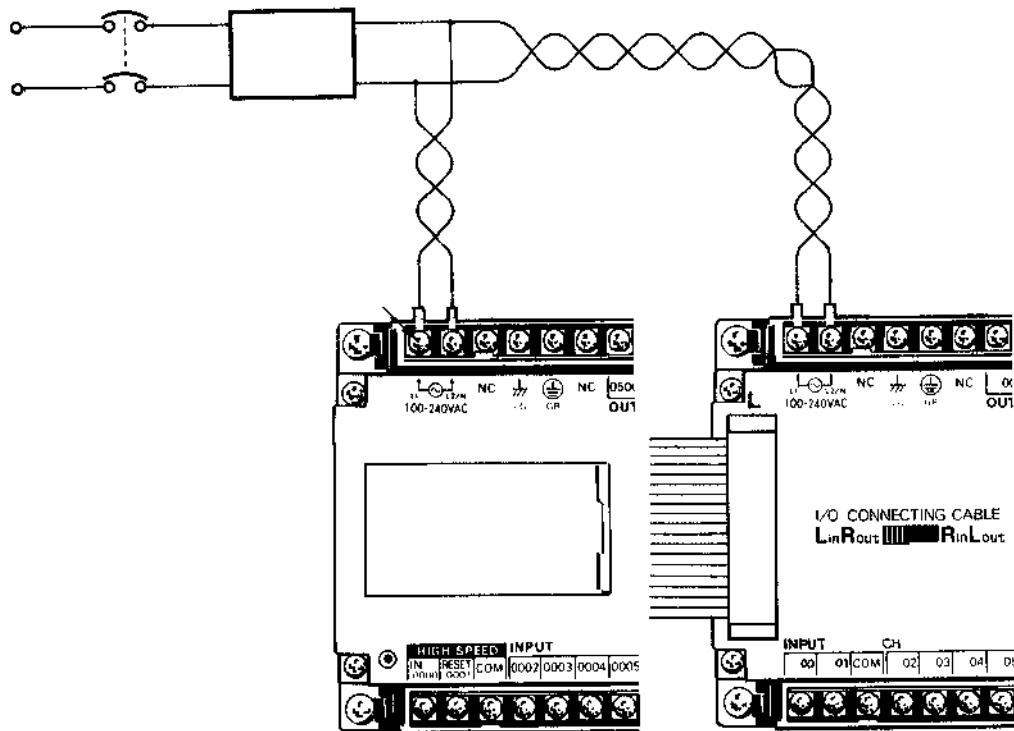

Connect an I/O Link Unit as shown in the following diagram, using M4 terminal screws.

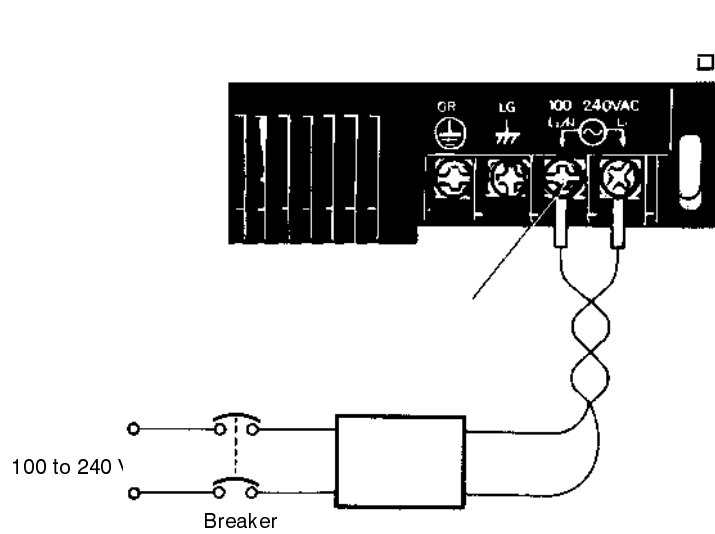

The following diagram illustrates the proper wiring for CPUs and Expansion I/O Units with the suffix -D. These models use a power supply of 24 VDC with an operating voltage range of 20.6 to 26.4 VDC. Be careful to connect the positive and negative terminals correctly. When power is turned ON, the incoming current will be approximately 30 A.

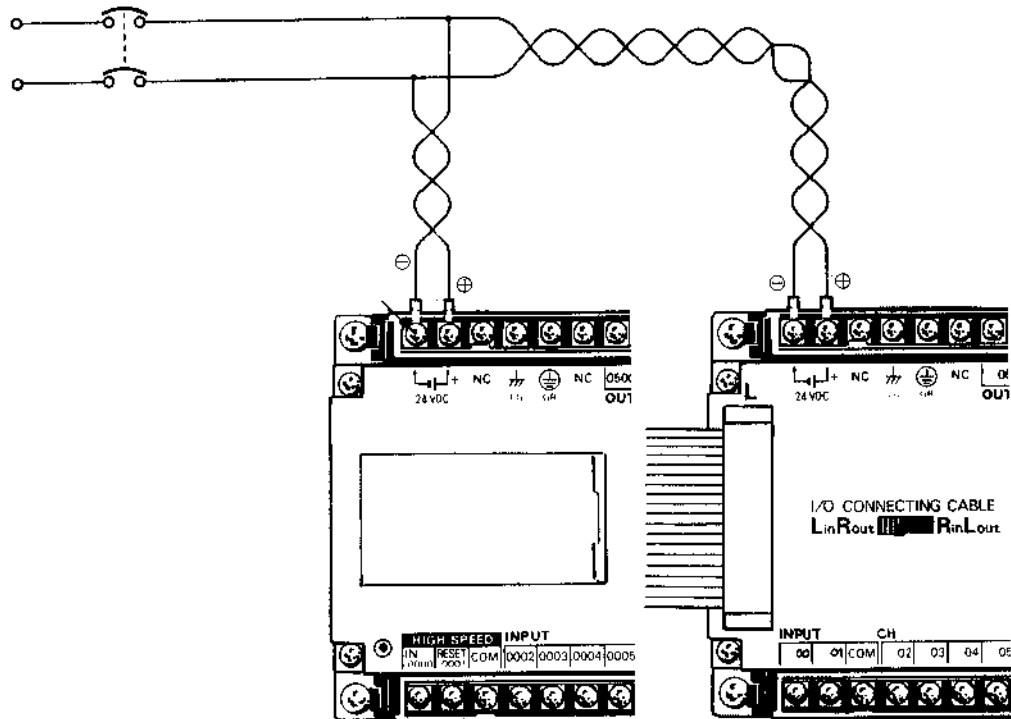

**Ground**

The Line Ground (LG) terminal is a noise filter neutral terminal which does not normally require grounding. When electrical noise is a problem, however, this terminal should be connected to the GR terminal.

Attach an independent ground-wire with a cross-sectional area of at least 2 mm<sup>2</sup> (AWG 14) to the GR terminal, to avoid electrical shock. Ground resis-

tance must be less than 100 Ω. Do not use a ground-wire longer than 20 m. Care must be taken because ground resistance is affected by the nature of the ground, water content, season, and the amount of time that has elapsed since the wire was laid underground.

CPU operation may be adversely affected if the ground-wire is shared with other equipment, or if grounding is attempted by attaching the ground-wire to the metal superstructure of a building. When either Expansion I/O Units or I/O Link Units are used, they also require grounding at the GR terminal. These may all be included on the same ground.

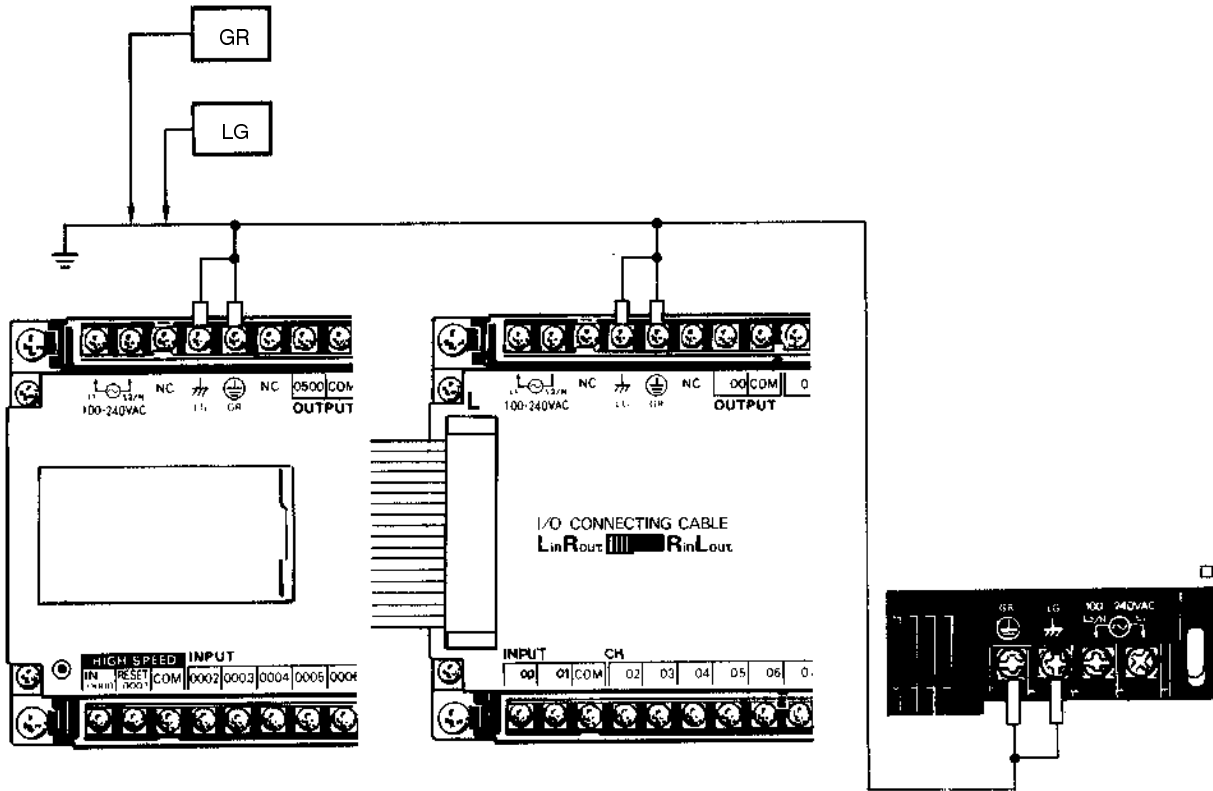

## 2-6 I/O Wiring

This section shows I/O wiring diagrams for representative models of all the CPUs, Expansion I/O Units, and I/O Link Units covered in this manual. It also gives connection examples for the sensors and switches which can be connected as input devices.

### 2-6-1 Unit Wiring Diagrams

The following items are all available for use as outputs. Do not mix them within the same common circuit.

Output	Load Power Supply
Relay	Up to 250 VAC/24 VDC
Transistor	5 to 24 VDC
Triac	100 to 120/200 to 240 VAC

When using transistor outputs, connect the common line (COM) to the load power supply negative side. For an induction load, connect the diode to the

load in parallel, as shown in the diagram, such that the cathode is on the positive side of the power supply.

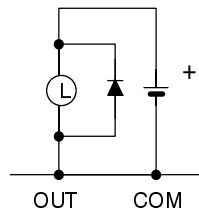

When using the high-speed counter instruction (HDM(61)), wire input 0000 as the high-speed counter input and input 0001 as the hardware reset input. If the HDM is not used, inputs 0000 and 0001 may be used as general input terminals. Their response time (0.15 ms), however, will be shorter than the other inputs.

Do not connect the NC terminals to anything. The DC inputs in the following I/O wiring diagrams are NPN (positive common). Reverse the polarity if PNP (negative common) is used.

In the diagrams, representative models are sometimes used to cover several models with similar wiring. In such cases, the type of Unit (i.e., CPU C60K) is listed first, followed by the suffix of the applicable model number. A space left blank ( ) in the model number indicates that any of several numbers could be inserted there.

**CPU C20K, C28K, C40K (CD\_-A)**

The inputs can use the Unit's 24-VDC power supply output. If the maximum output current of 0.2 A is not sufficient a separate DC power supply must be used.

Not in C20K      Not in C20K or C28K

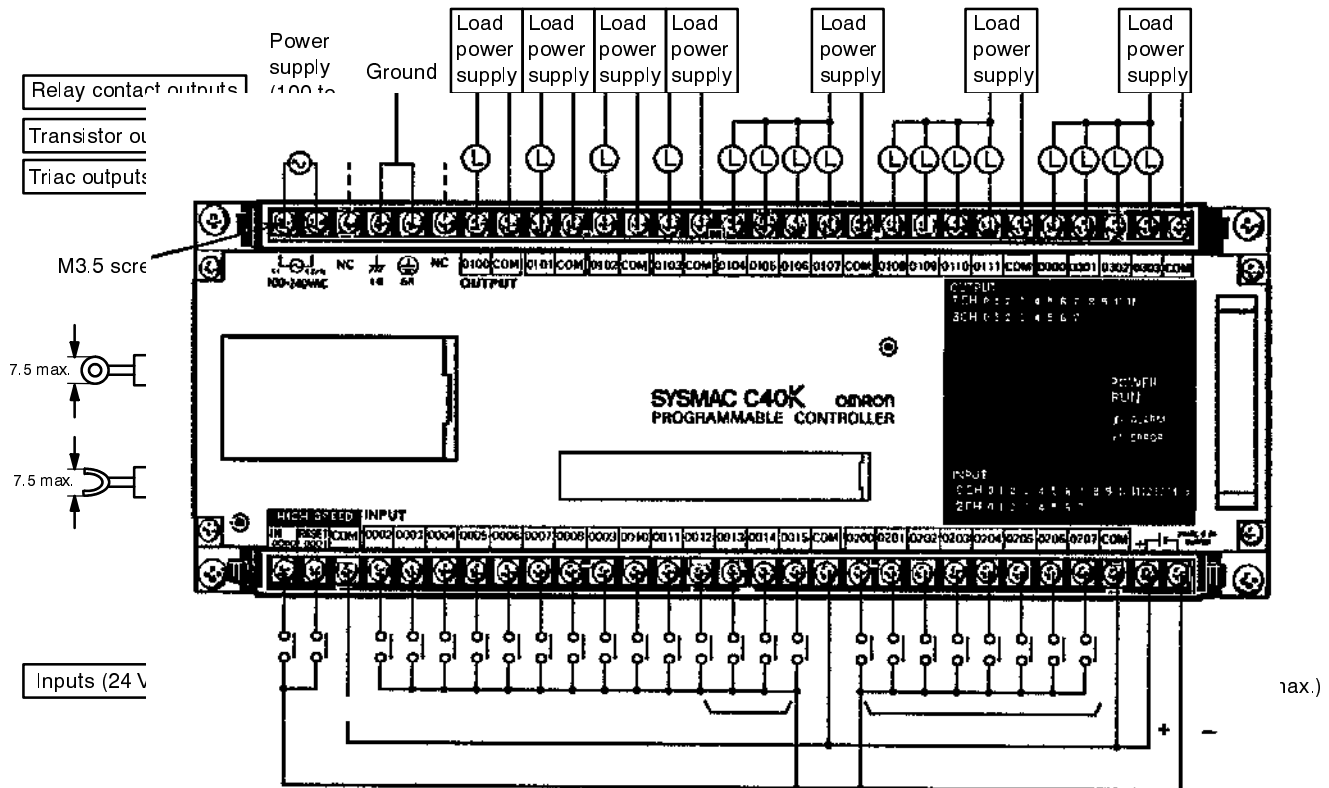

NC: Do not connect the NC terminals to anything.

CPU C20K, C28K, C40K (CA\_A)

Inputs 0000 and 0001 can use the Unit's 24-VDC power supply output. If the maximum output current of 0.2 A is not sufficient a separate DC power supply must be used. Inputs 0002 to 0107 take a 100-VAC power supply.

Not in C20K Not in C20K or C28K

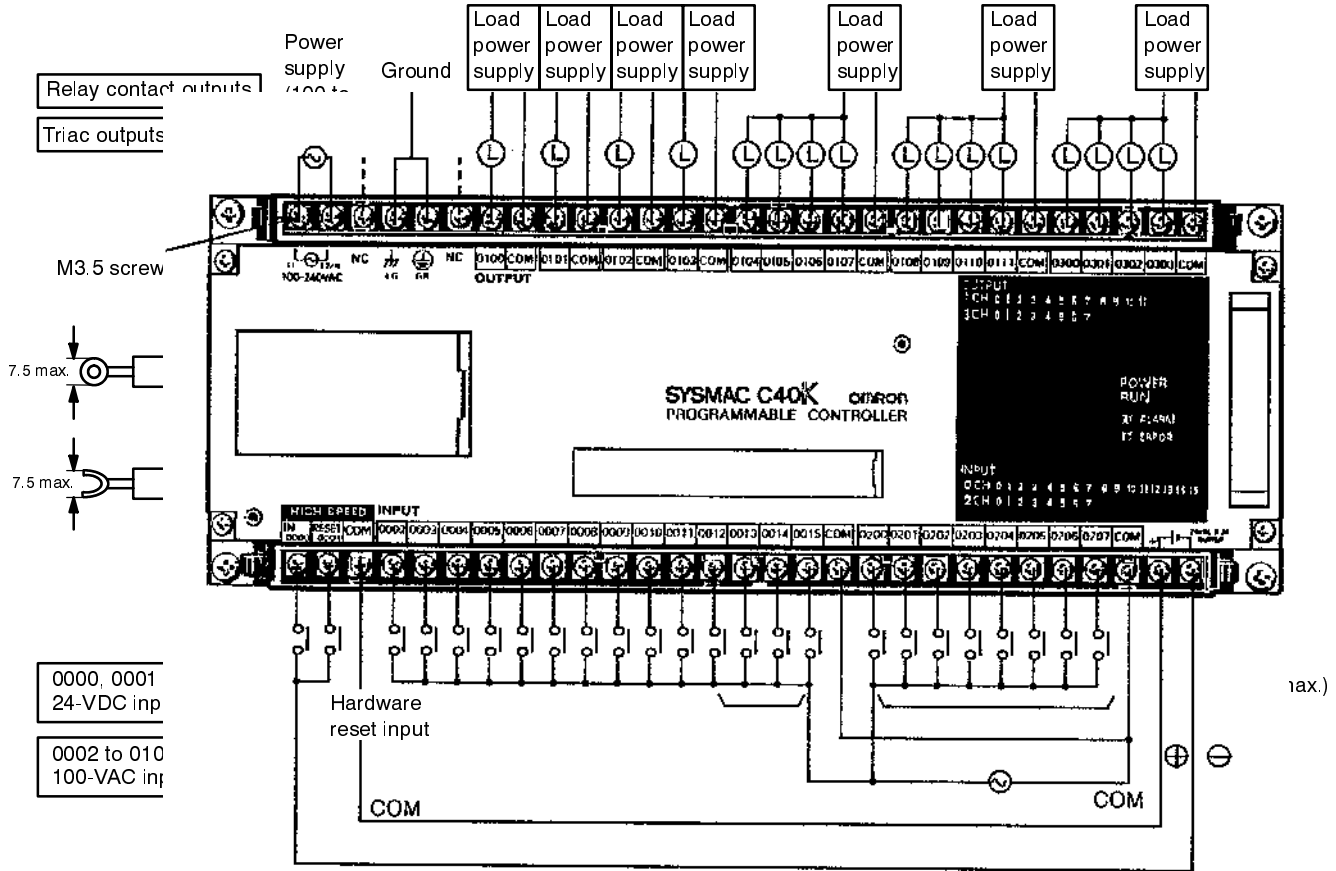

1ax.)

CPU C20P, C28P, C40P (CD\_D)

A separate power supply must be used for the DC inputs.

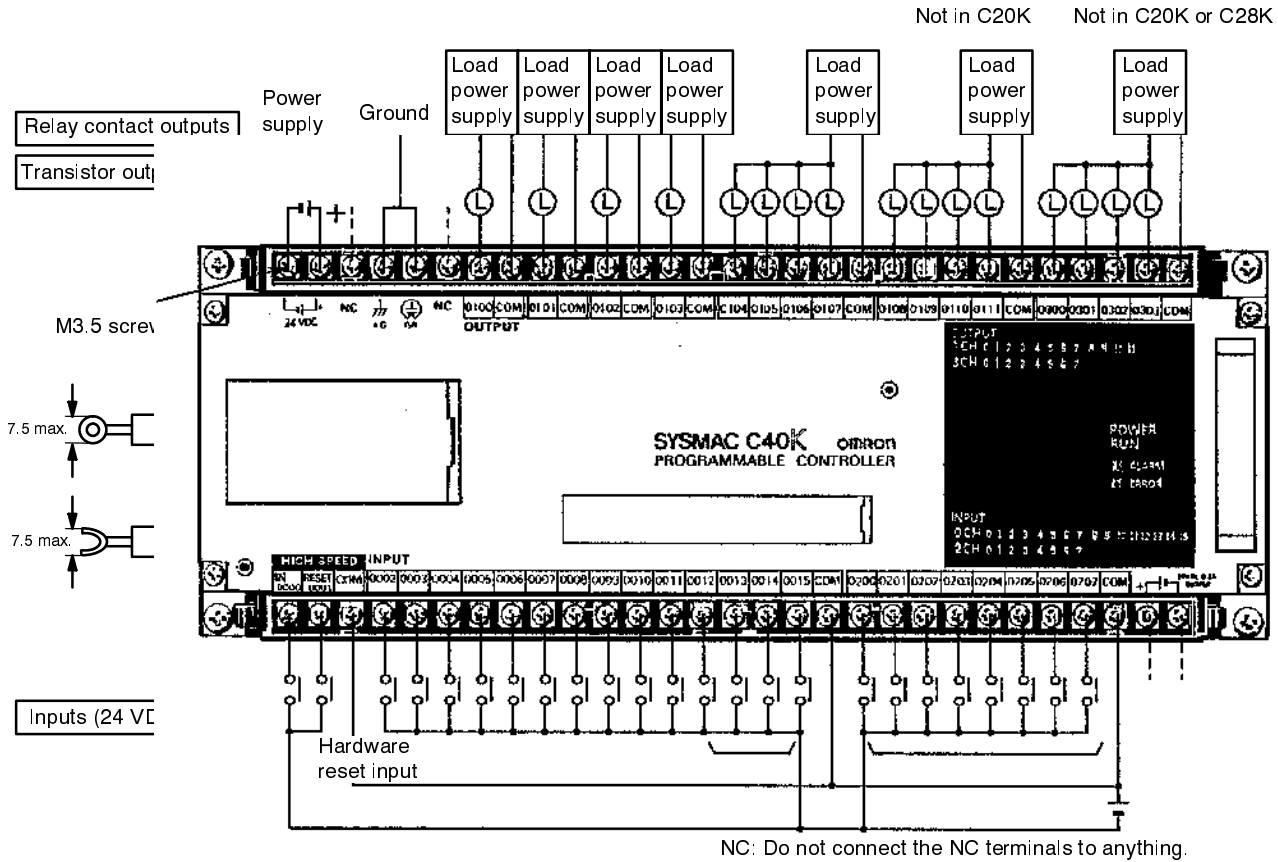

**CPU C60K (CD\_-A)**

The inputs can use the Unit's 24-VDC power supply output. If the maximum output current of 0.3 A is not sufficient, however, a separate DC power supply must be used.

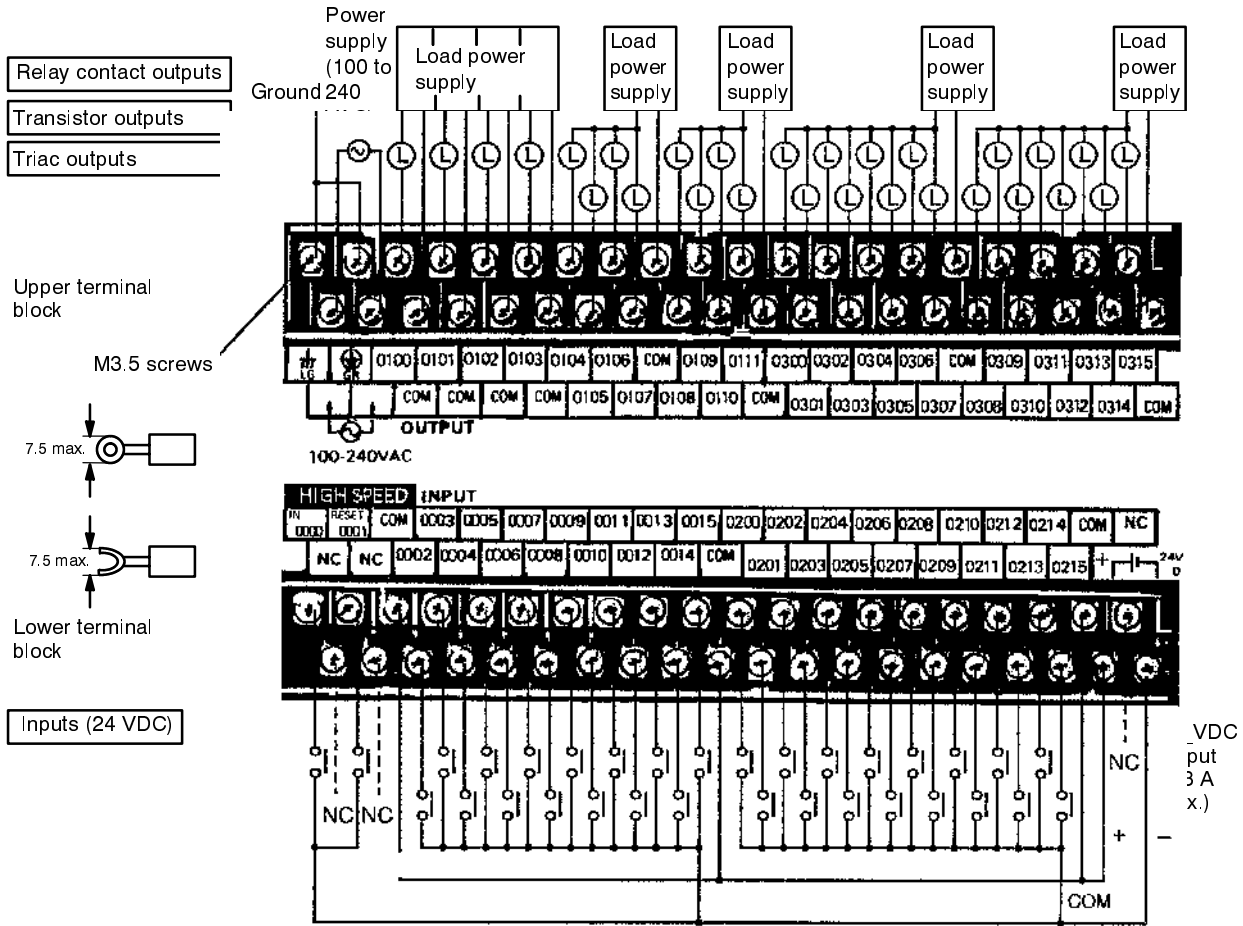

CPU C60K (CA\_-A)

Inputs 0000 and 0001 can use the Unit's 24-VDC power supply output. If the maximum output current of 0.3 A is not sufficient, however, a separate DC power supply must be used. Inputs 0002 to 0115 take a 100-VAC power supply.

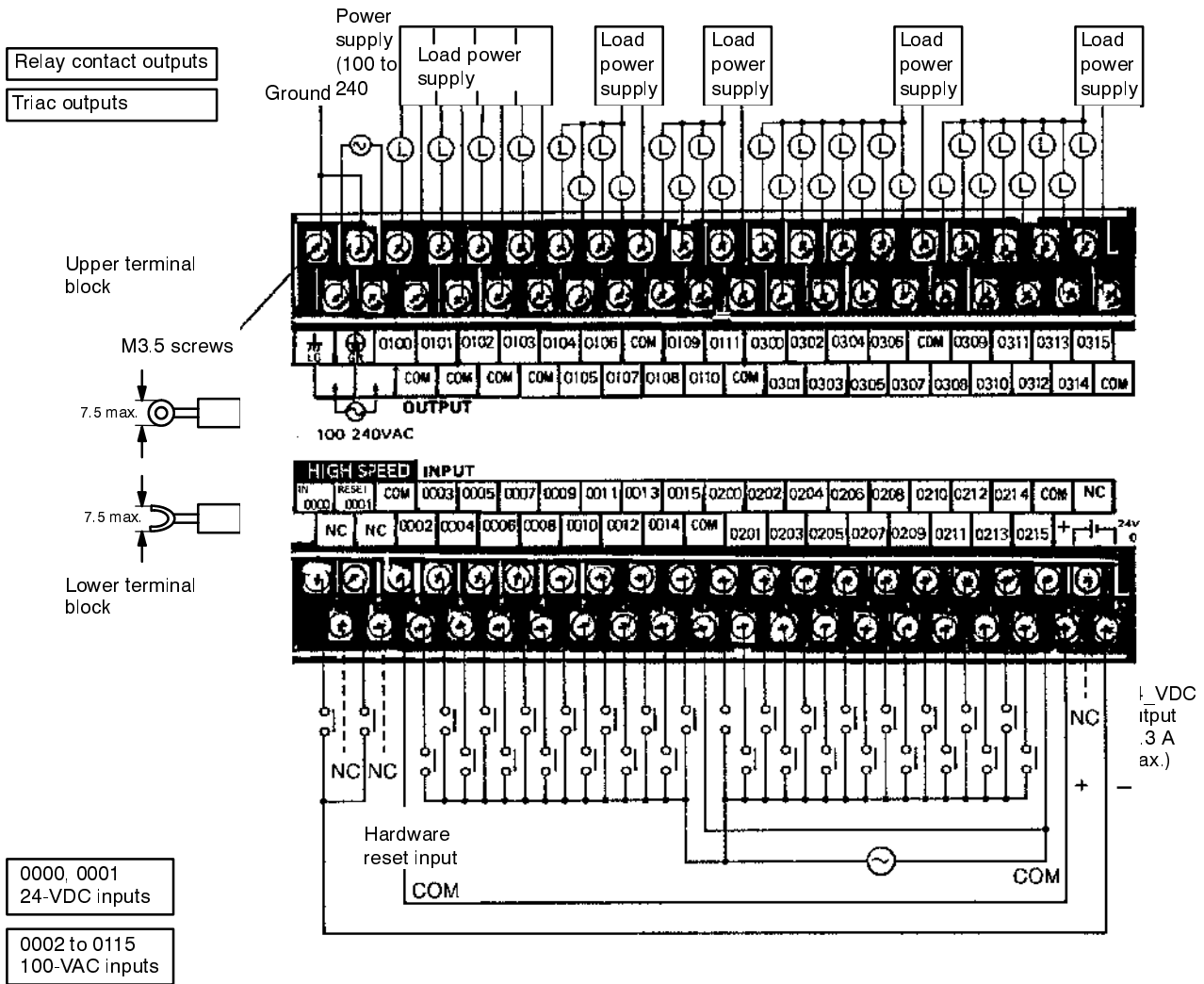

CPU C60K (CD\_-D)

A separate power supply must be used for the DC inputs.

Relay contact outputs  
Transistor outputs

Upper terminal block

M3.5 screws

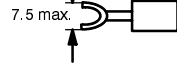
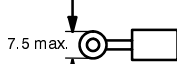

Lower terminal block

Inputs (24 VDC)

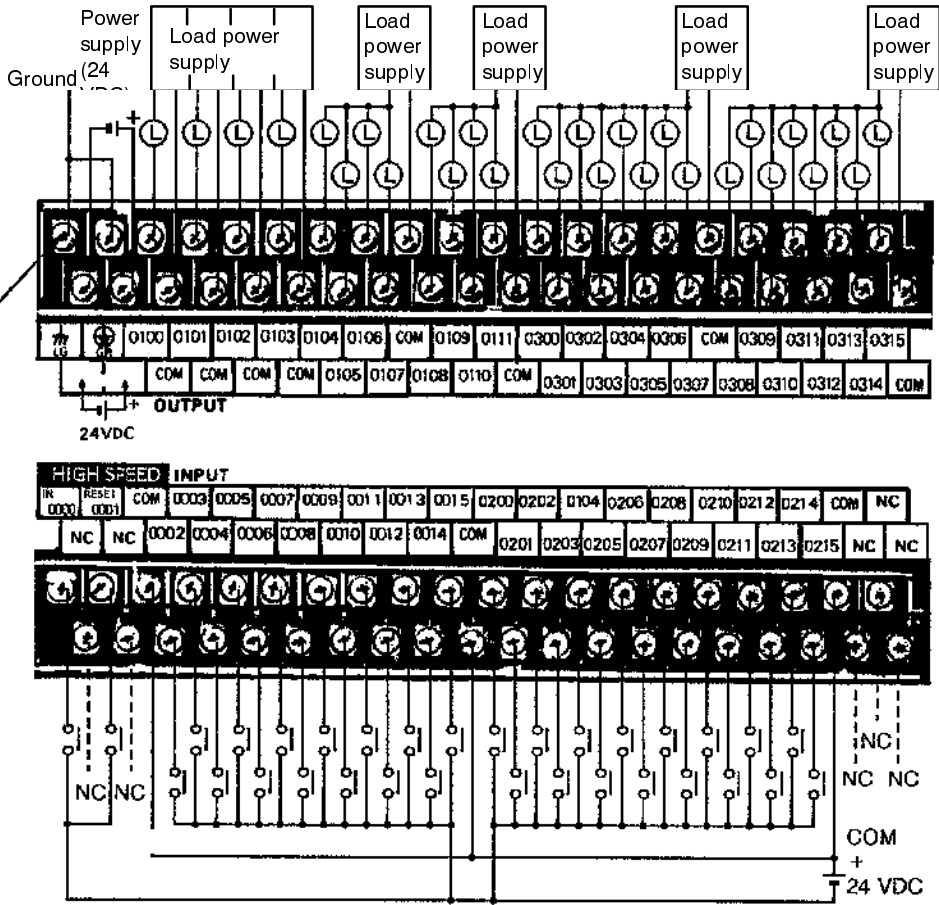



I/O Unit C20P/C28P/C40P (EA\_-A)

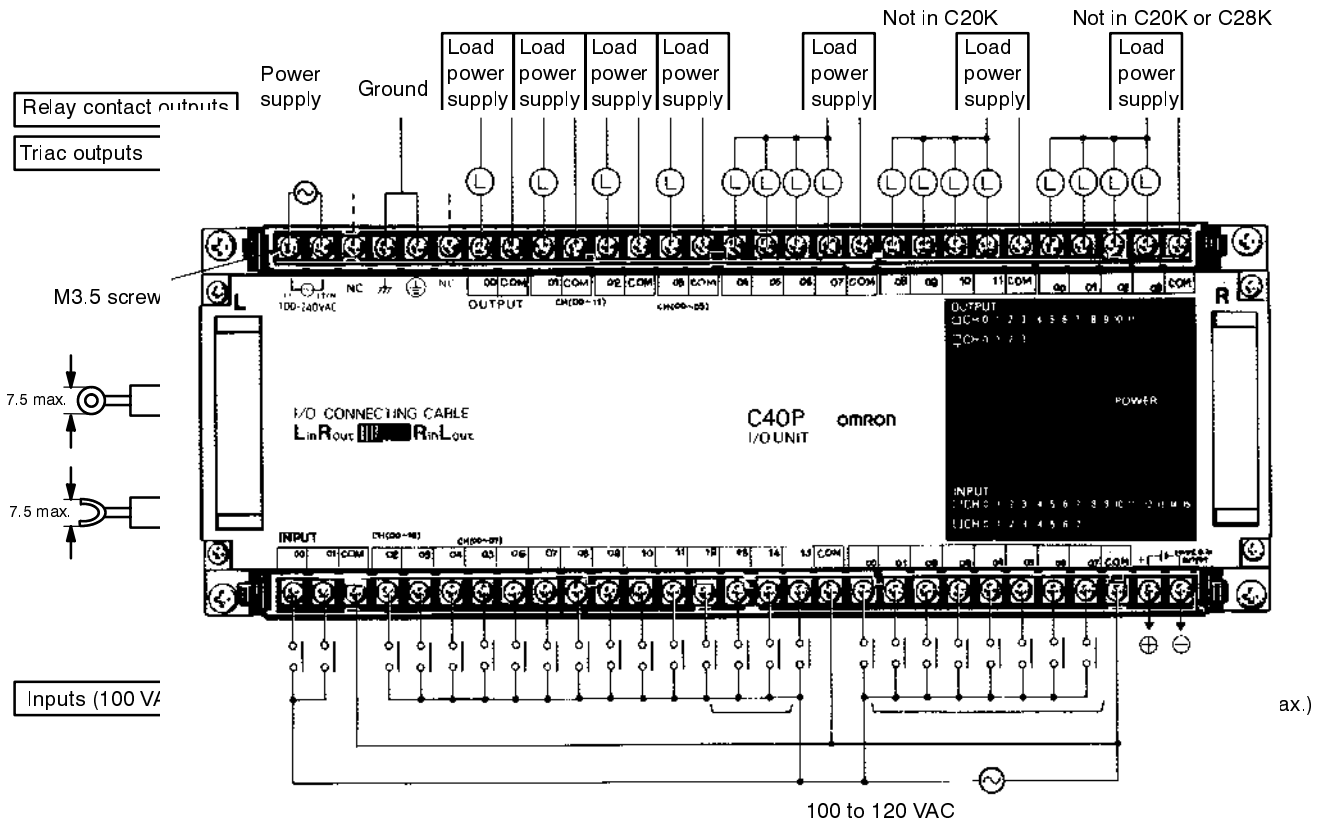

I/O Unit C20P/C28P/C40P (ED\_-D)

A separate power supply must be used for the DC inputs.

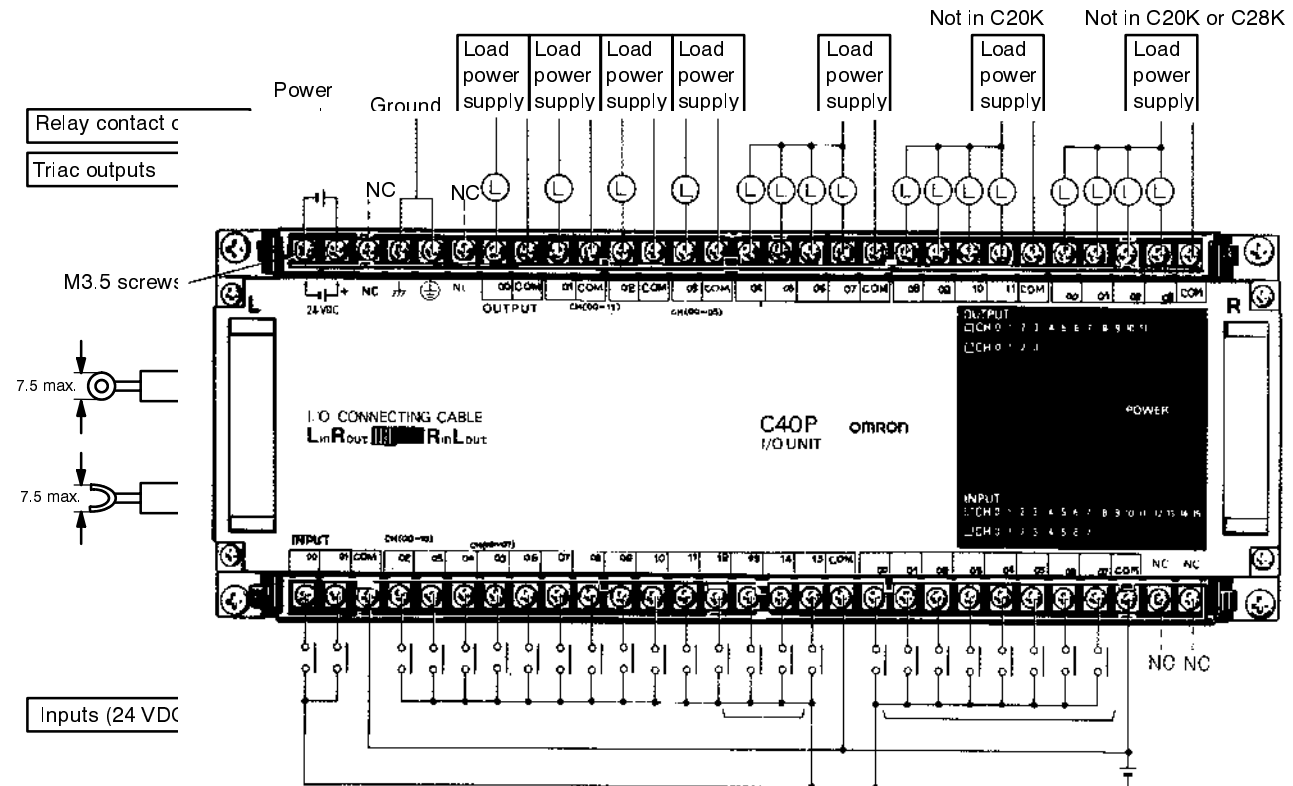

I/O Unit C60P (ED\_-A)

The inputs can use the Unit's 24-VDC power supply output. If the maximum output current of 0.3 A is not sufficient, however, a separate DC power supply must be used.

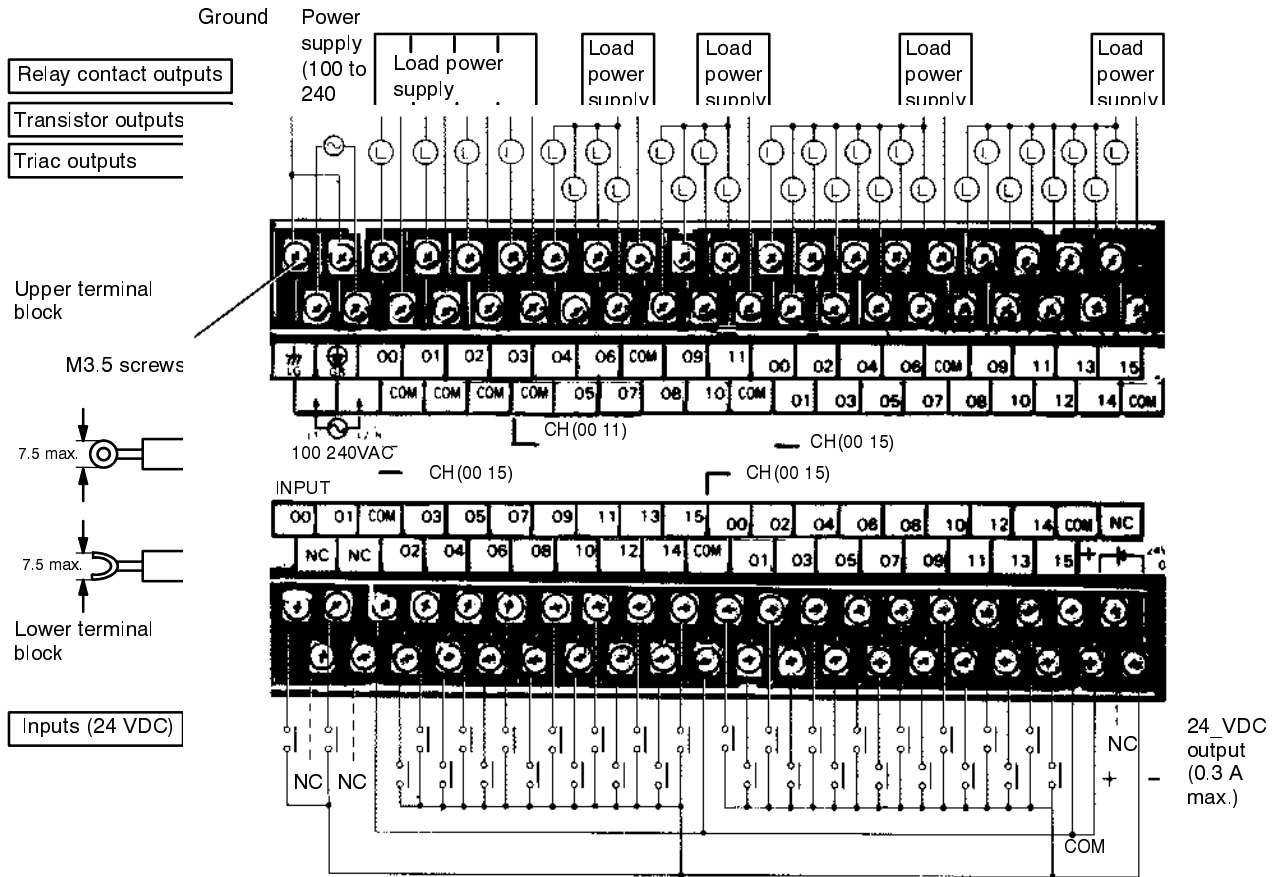

I/O Unit C60P (EA\_-A)

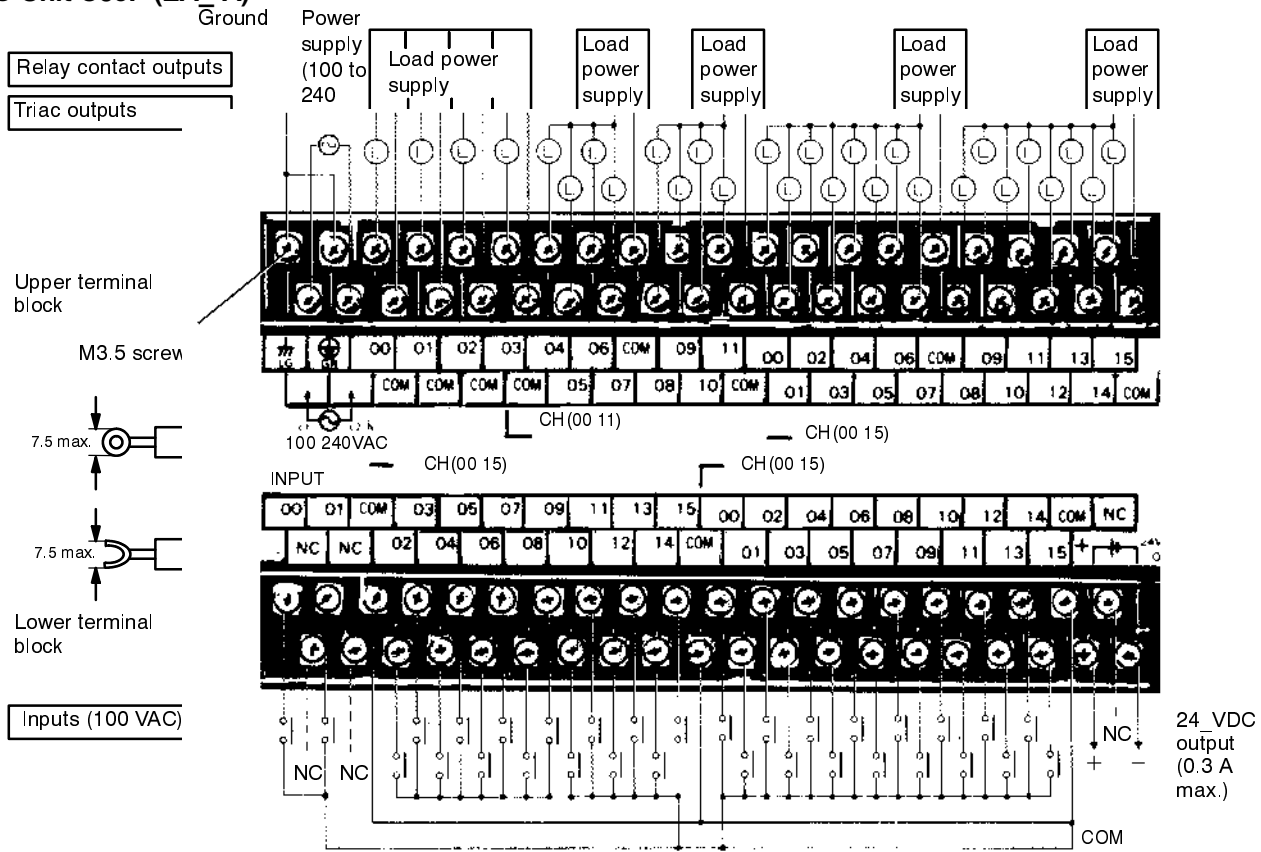

I/O Unit C60P (ED\_-D)

A separate power supply must be used for the DC inputs.

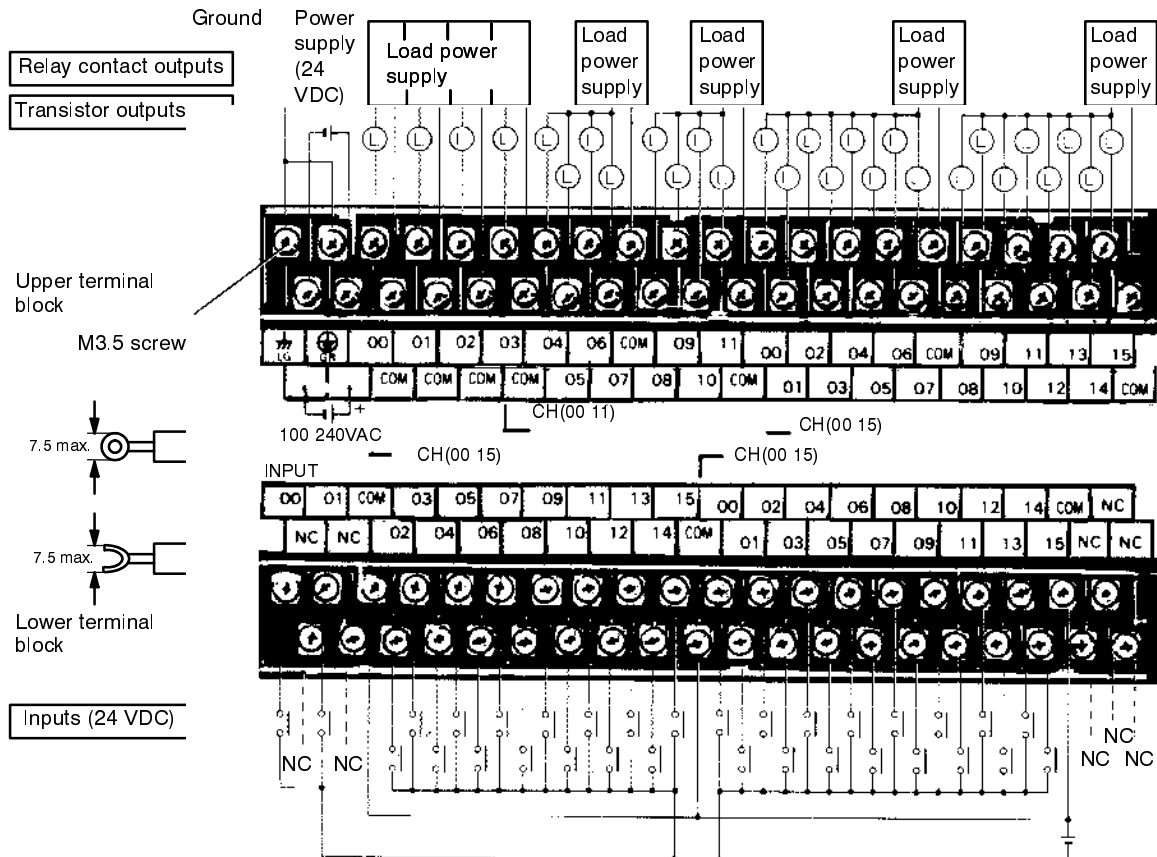

I/O Unit C16P-ID-A

The inputs can use the Unit's 24-VDC power supply output. If the maximum output current of 0.2 A is not sufficient, however, a separate DC power supply must be used.

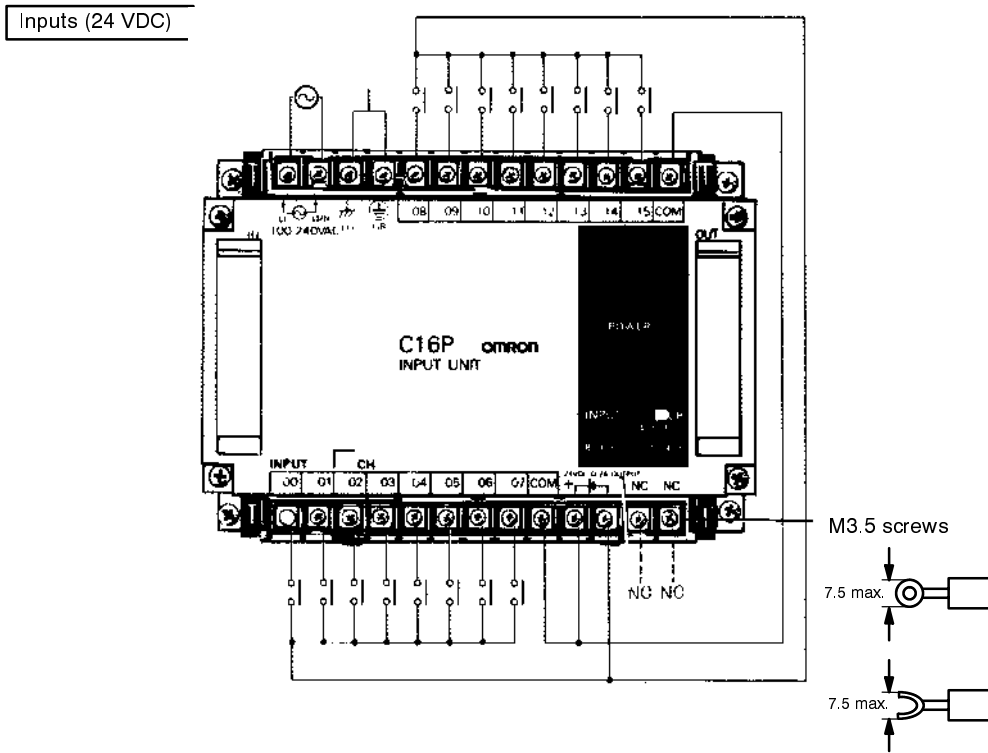

Input Unit C16P-ID

A separate power supply must be used for the DC inputs.

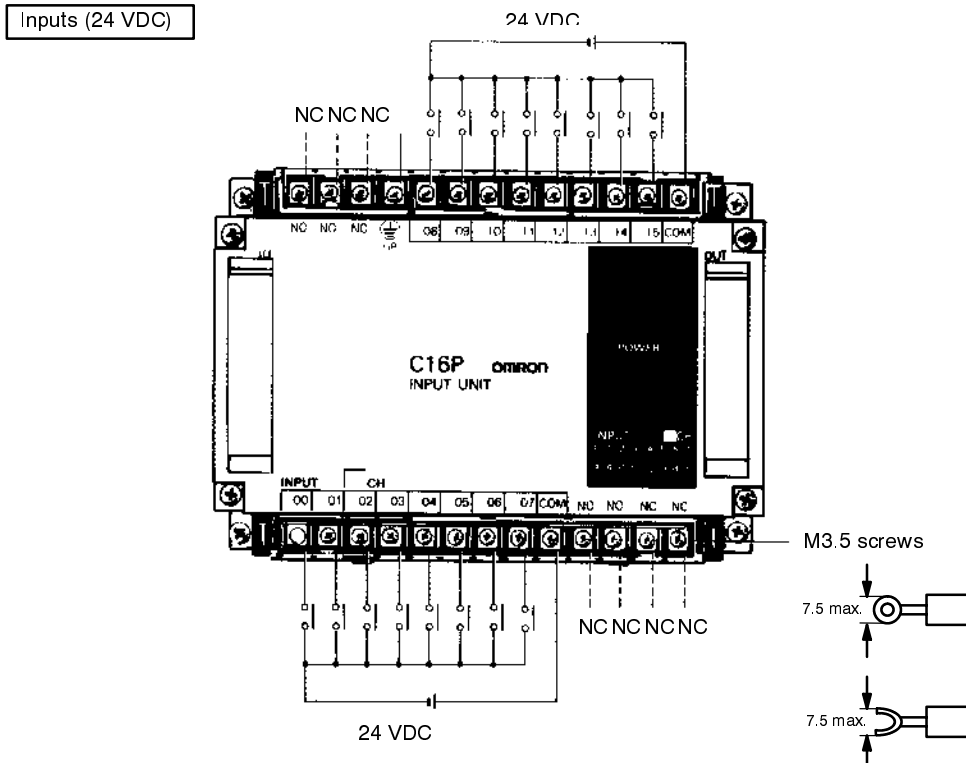

### Input Unit C16P-IA

Inputs (100 VAC)

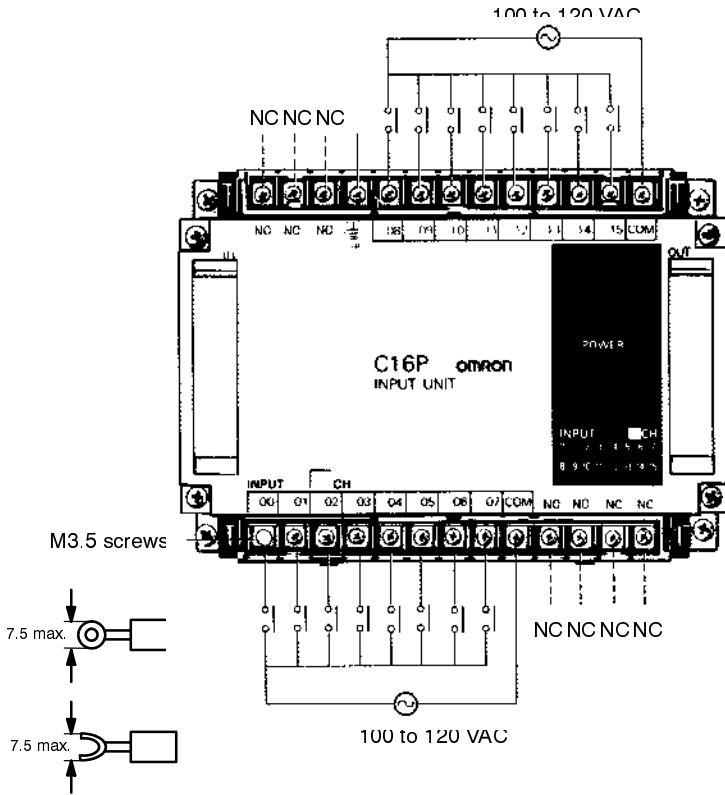

### Output Unit C16P-O\_-A

- Relay contact outputs
- Transistor outputs
- Triac outputs

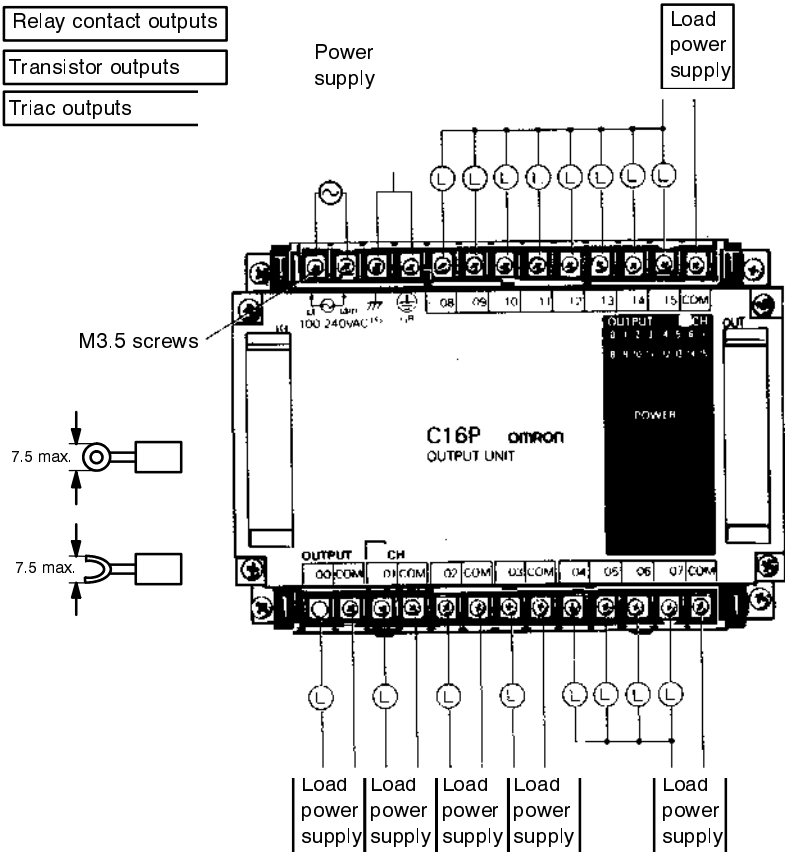

Output Unit C16P-O\_-D

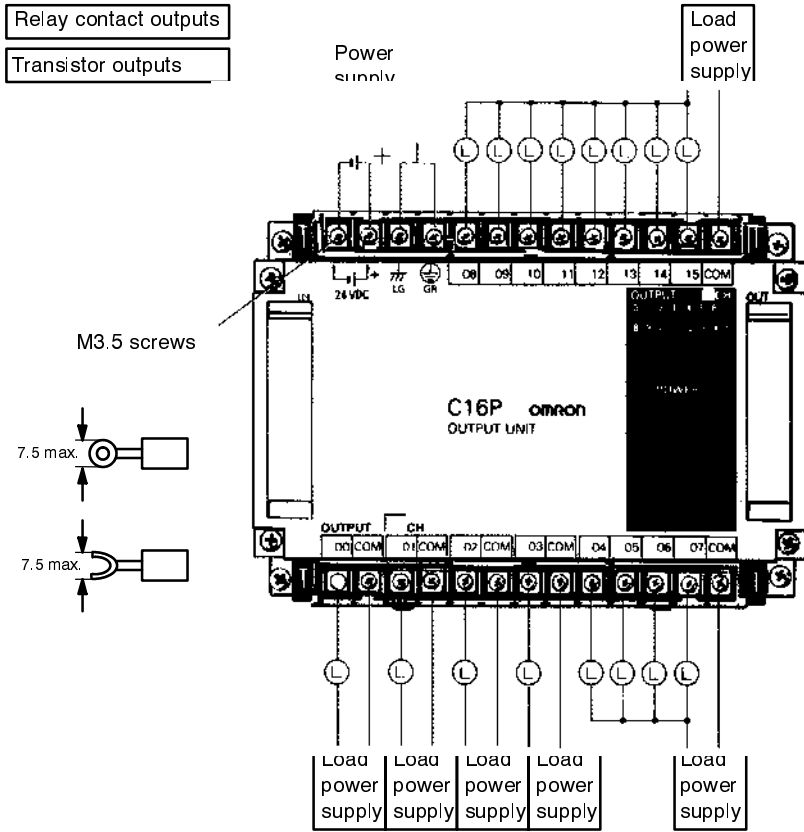

Input Unit C4K-ID

The C4K-ID can use the 24-VDC output from the CPU if the current (0.3 A) is sufficient. If this is not sufficient, a separate DC power source must be used.

Inputs (24 VDC)

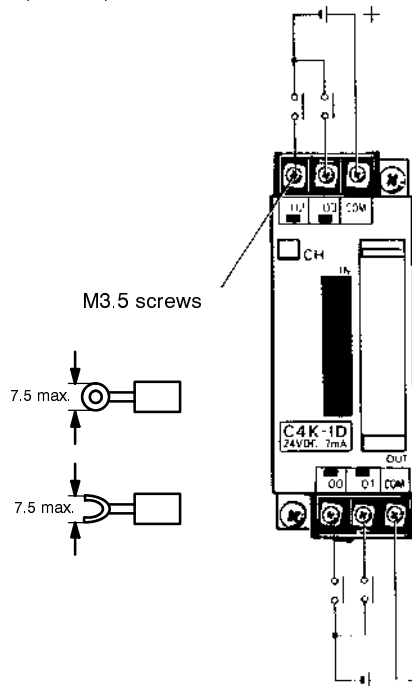

Input Unit C4K-IA

Inputs (100 VAC)

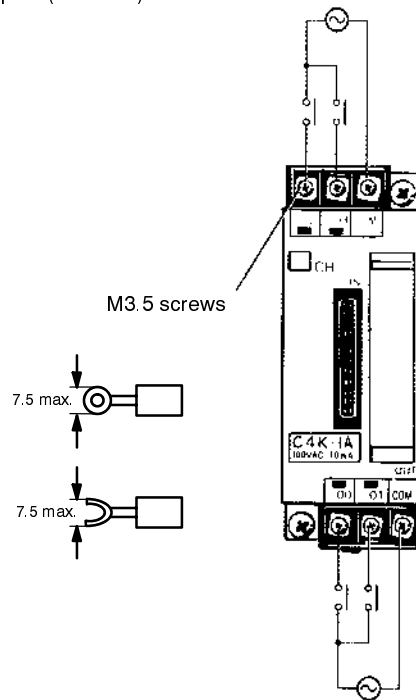

Output Unit C4K-O\_\_

- Relay contact outputs
- Transistor outputs
- Triac outputs

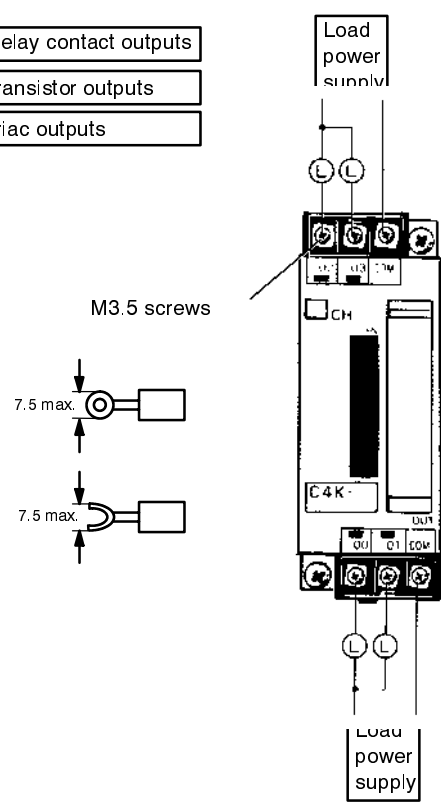

I/O Link Unit 3G2C7-LK011(-P)E

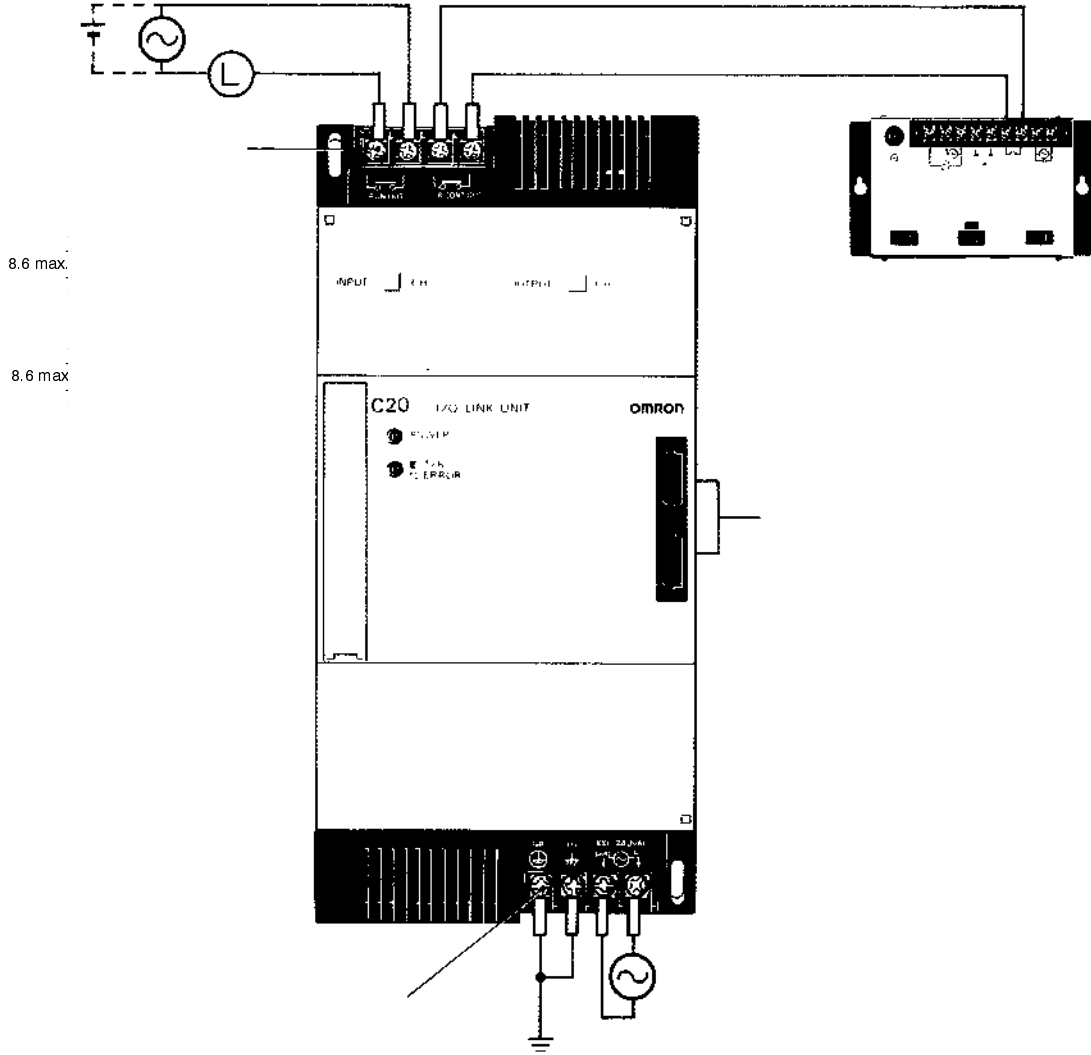

### 2-6-2 I/O Device Connection Examples

The following diagrams show connection examples for the sensors and switches which can be connected as input devices. Be sure to check all input devices for voltage and amperage compatibility before connecting.

#### AC Input Devices

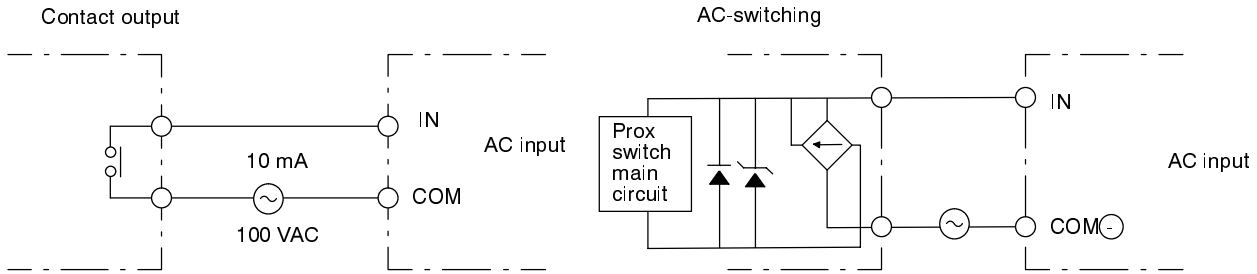

#### DC Input Devices

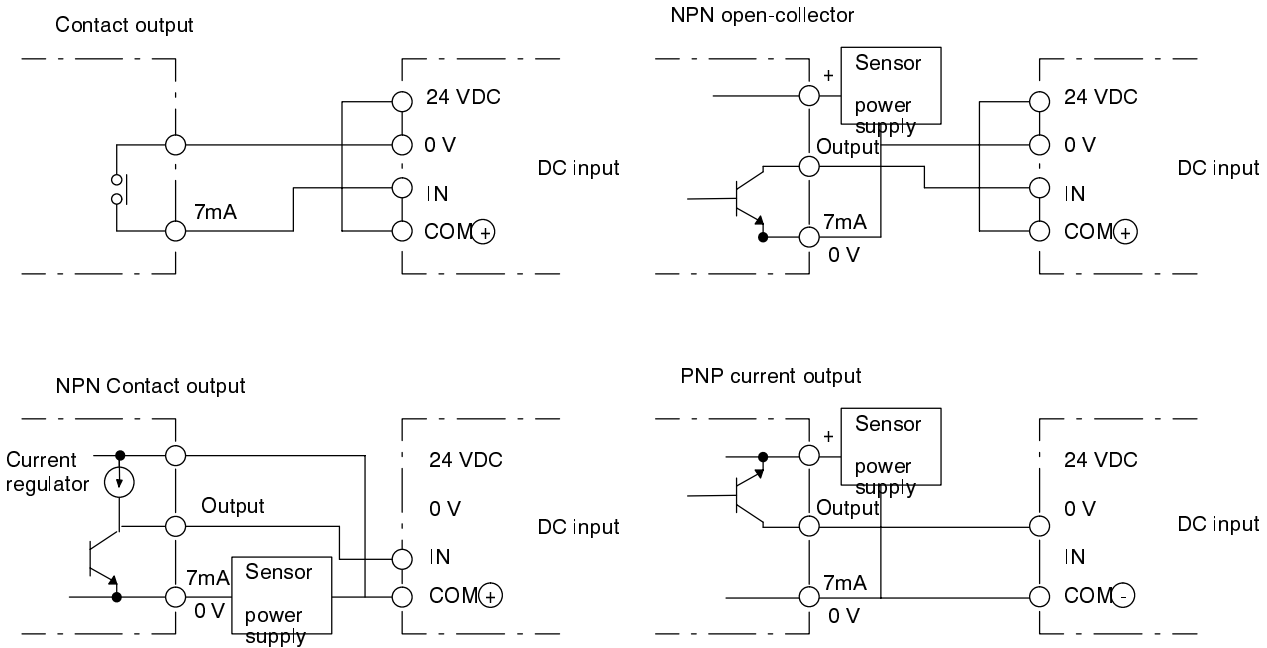

#### High-Speed Counter Input Devices (Rotary Encoder)

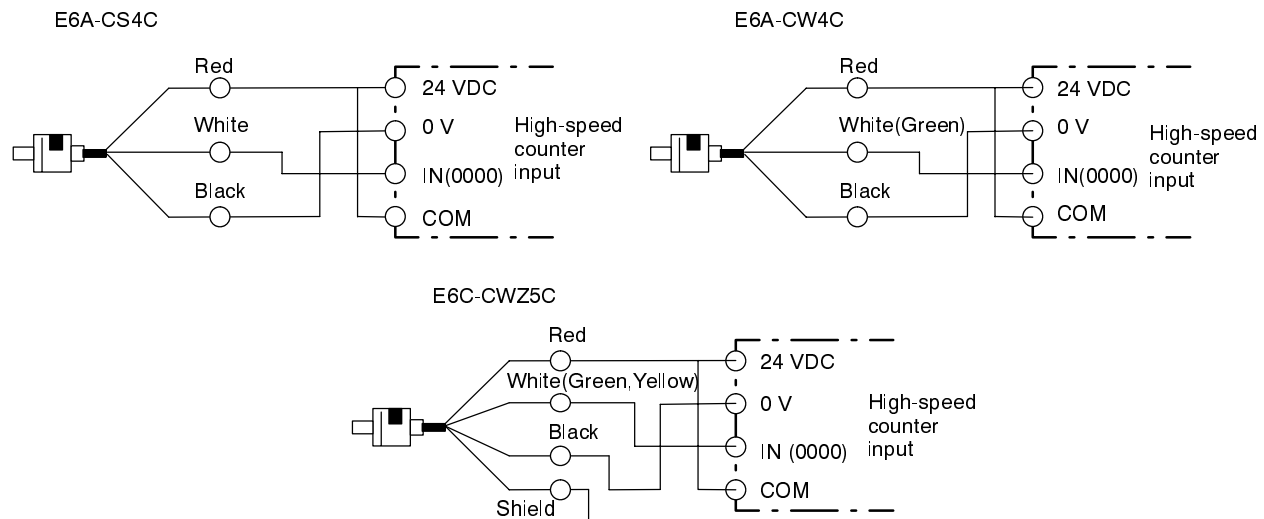

## 2-7 Special Wiring Precautions

### Emergency Stop Circuit

An external relay circuit can be constructed to prevent a CPU breakdown or malfunction from damaging the entire System. In the following diagram, SR bit 1813 is always open when the CPU is operating. If the program is set up as shown in the diagram, then output 0100 will be ON whenever the CPU is in either RUN or MONITOR mode, and it will function as an output to monitor whether the CPU is operating properly or not.

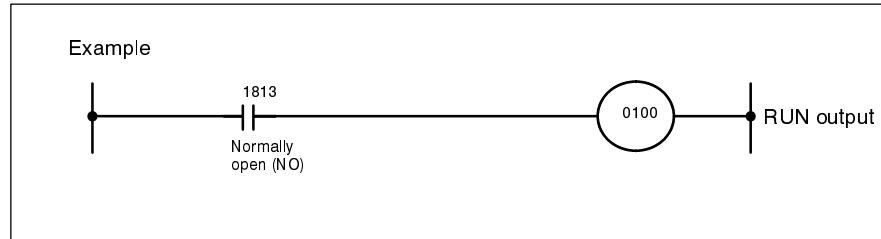

### Emergency Stop Circuit When an I/O Link Unit is Used

An I/O Link Unit's RUN output terminal is wired to a CPU's input terminal. It can function as an output to monitor whether the entire PC System, including the I/O Link Unit, is operating properly or not. In the diagram below, the I/O Link Unit is connected to input terminal 0002. If the program is set up as shown in the diagram, then output 0100 will be ON whenever the CPU is in either RUN or MONITOR mode. The I/O Link Unit's RUN output and the CPU's RUN or MONITOR output together comprise an AND in the external relay circuit, and this can be used to construct an emergency stop circuit.

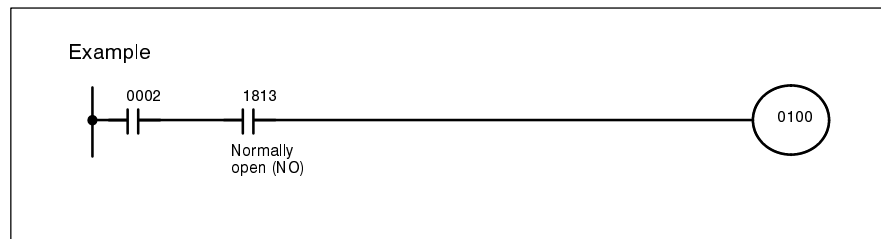
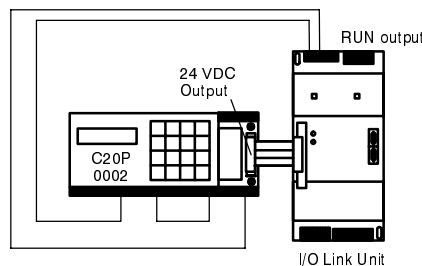

**Interlock Circuit**

There are sometimes cases in which a PC can direct a machine to do either of two contrasting actions, and in which damage could result from a malfunction in the PC. For example, the PC could be set up to output commands to a motor to operate alternately in forward and reverse. In such cases an interlock circuit can be set up to prevent damage in case of a malfunction. In the example diagram below, the interlock circuit will prevent MC1 and MC2 from turning ON at the same time even if the PC malfunctions and turns outputs 0101 and 0102 ON simultaneously.

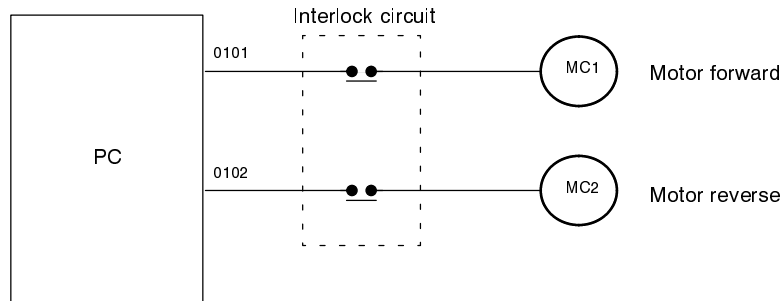

**Wiring of Power Supply Systems**

Electric power systems, control systems, PC power supply systems, and I/O power supply systems should all be wired separately, as shown in the following diagram.

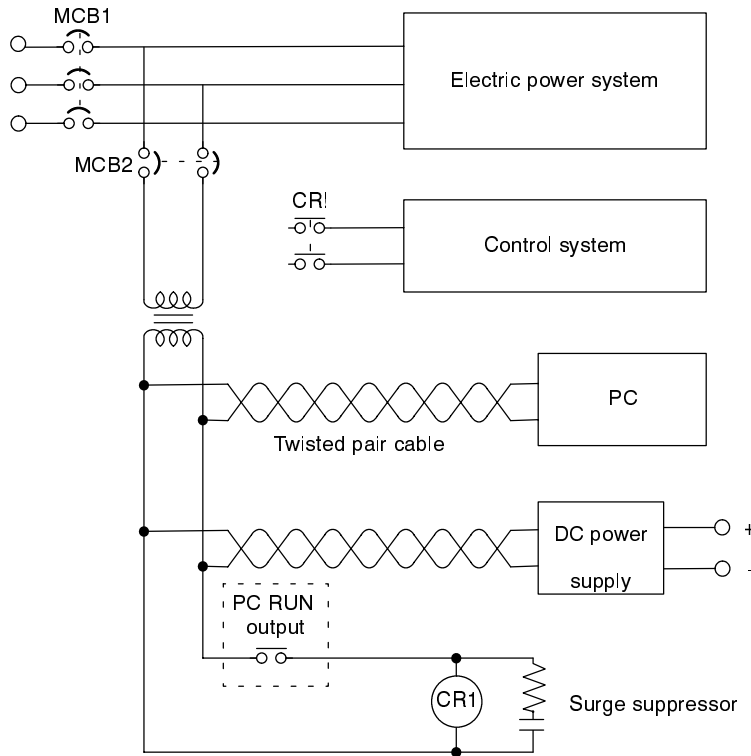

**Power Failure Protection**

A power sequence circuit is incorporated in the PC to prevent malfunctioning due to momentary power failures or voltage drops.

The PC ignores all momentary power failures if the interruption lasts no longer than 10 ms. If the interruption is between 10 ms and 25 ms, it may or may not be detected. If the supply voltage drops below 85% for longer than 25 ms, the PC will stop operating and the external outputs will be automatically turned OFF. Operation automatically resumes when the supply voltage is restored to more than 85% of the rated voltage. Detection time will be slightly shorter when a DC power supply is used.

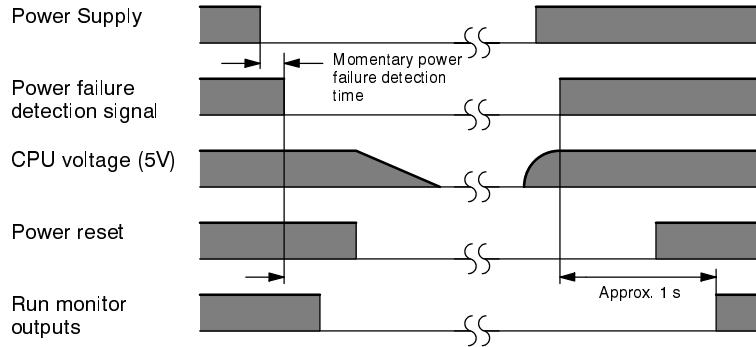

## 2-8 Settings

After writing the program and preparing the EP-ROM chip (see the Operation Manual), the CPU DIP switch must be set and the EP-ROM installed.

### 2-8-1 Setting the CPU DIP Switch

- 1, 2, 3... 1. Turn OFF the power to the CPU.
2. Remove the cover from the CPU, using a screwdriver if necessary.

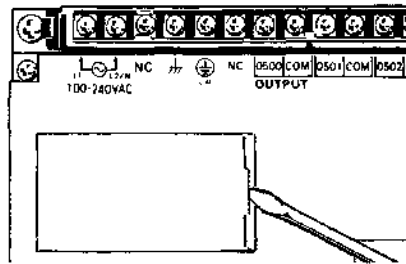

3. Set DIP switch pins 1 and 2 to OFF, and pins 3 and 4 to ON.

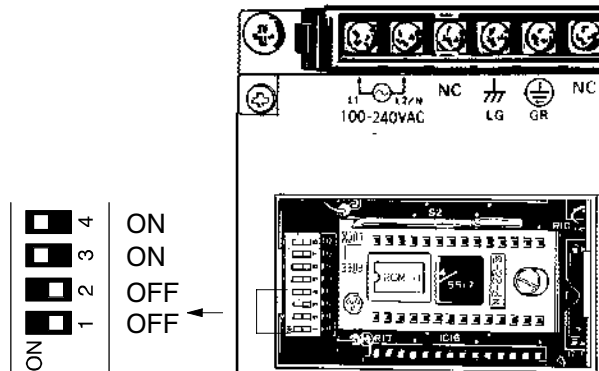

## 2-8-2 EPROM Installation

- 1, 2, 3...
1. Remove the cover as shown above.
  2. Raise the lever to unlock the socket.
  3. Holding the chip so as not to touch the pins, insert it into the socket with the notch to the left.
  4. Check to be sure the chip has been properly installed.
  5. Return the lever to its original position, locking the chip in.
  6. Replace the cover.
  7. Turn the power ON and verify that the CPU is operating in MONITOR mode.

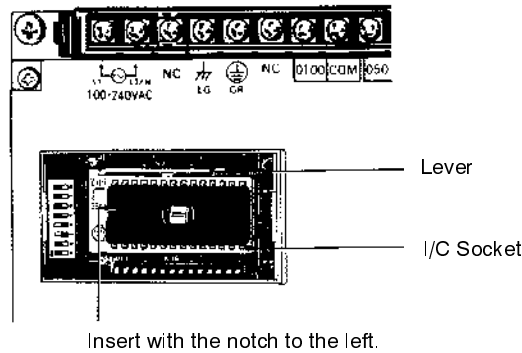

## 2-8-3 High-speed Counter

When the high-speed counter (HDM(61)) is used, input (0000) is used exclusively for this purpose and responds up to 2 kHz. Either the hardware reset or software reset may be used. The software reset may be delayed, depending on the scan time, since it is based on the program. The hardware reset is unrelated to the scan time and can operate at high speed. To use the hardware reset (input 0001), set DIP switch pins 7 and 8 to ON as shown below. Be sure to set them to OFF whenever the hardware reset is not being used, regardless of whether the high-speed counter is being used.

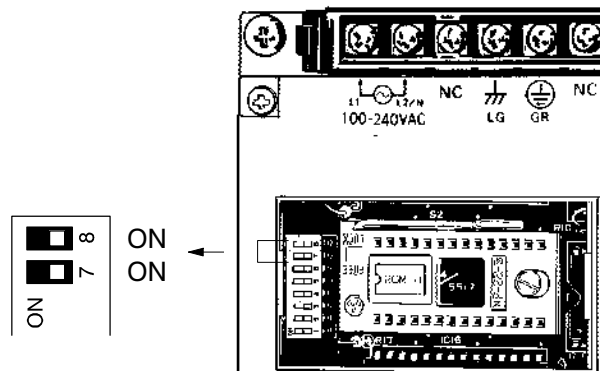

### 2-8-4 Inhibiting the ALARM Indicator

To inhibit the ALARM indicator when using EP-ROM, set DIP switch pin 5 to ON as shown below.

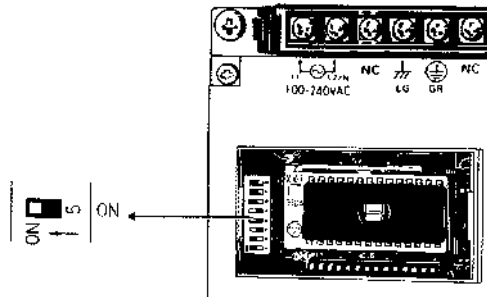

Connect a backup battery to preserve data memory, current counter value, and HR area bits, in case of a power failure. In order to maintain the battery, DIP switch pin 5 should normally be set to OFF. In any case, it must always be OFF when using RAM.

### 2-8-5 Setting the I/O Link Unit

In order for the I/O Link Unit to operate, it is necessary to determine the assignment of I/O words between the I/O Link Unit and the Remote Master Module controlled by the CPU. This is done with the DIP switch on the I/O Link Unit. The following explanation is intended only to give a general outline of the proper procedure. For details, refer to the SYSMCA BUS Remote I/O System Manual.

**Caution** Be certain that power is OFF before setting the DIP switch. Setting it with the power ON can cause the Unit to malfunction.

- 1, 2, 3...**
1. Check the last assigned word number on the CPU. When setting the I/O Link Unit, be sure not to overlap the words or to exceed the number of I/O points in the CPU.
  2. Turn OFF the power to the I/O Link Unit.
  3. Check to be sure that the power supply LED is not lit. Remove the cover on the side panel of the Unit, using a screwdriver if necessary.

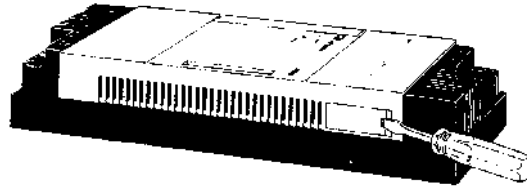

- Use the 6 DIP switch pins to set the word number from 0 to 30. As shown in the diagram below, the word numbers are set in binary, with pin 5 being 1 and pin 1 being 16. Beginning with pin 1, turn ON the pins required to arrive at the desired number of words. Turn ON pin 6 to set the termination resistance if the I/O Link Unit is a terminator (the final Unit in the System). If the Unit is not a terminator, leave pin 6 OFF.

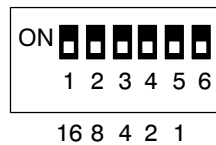

The following example diagram illustrates the proper DIP switch setting for word 26.

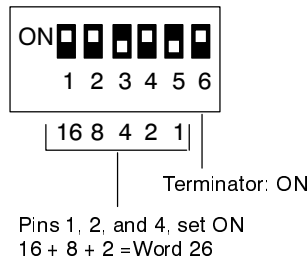

- After initially setting the DIP switches, an I/O table check should be performed on the CPU to ensure that there are no errors in the settings.
- Replace the cover. In addition, to prevent dirt or outside light from causing a malfunction, be sure that any unused optical fiber connectors are covered with the protective caps. The Unit should be ready to operate as soon as power is turned ON. If it does not operate normally, refer to 3-1 Self-Diagnostic Function.

**System Configuration Example**

In the diagram below, a C20 CPU, a C40K CPU, a C20P I/O Unit and two I/O Link Units can exchange data over a distance with a C500 Remote I/O Master Unit. The C20 I/O Link Unit is set for word 28 (which accesses word 29 as well), and the C40K I/O Link Unit is set for word 30 (which accesses word 31 as well). The C40K I/O Link Unit is also set as the terminator.

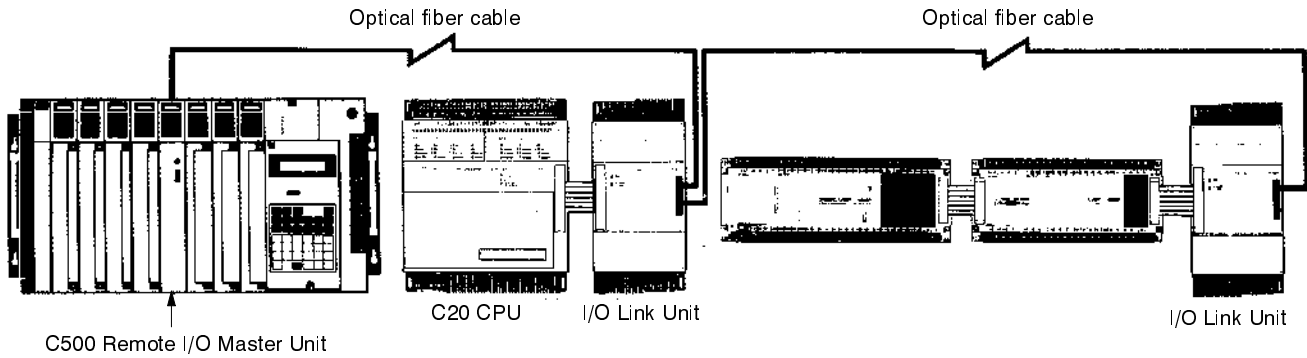

When setting the I/O Link Unit, in this example, it is necessary to take into account not only the I/O words of the C500 Remote I/O Master Unit, but also those of the C20 CPU and the C40K CPU.

C500 Word Assignment		C20 Word Assignment	C40P Word Assignment	
Auto- matic	0			
	1			
	2			
	27			
Manu- al	28			I/O Link (C20)
	29			
	30			
	31			

Model	As seen from C20	As seen from C20, C40P	I/O Link Unit DIP Switch Setting
I/O Link (20)	Word 28: 16 output points → Word 29: 16 input points ← Data output to C20 Data input from C20	Word 1: 16 input points Word 6: 16 output points Data input from C500 Data output to C500	<p>Set for Word 28 Not terminator</p>
I/O Link (40P)	Word 30: 16 output points → Word 31: input points ← Data output to C40K Data input from C40K	Word 6: 16 input points Word 7: 16 output points Data input from C500 Data output to C500	<p>Set for Word 30 Set as terminator</p>

## **SECTION 3**

# **Maintenance and Inspection**

3-1	General .....	48
3-2	Self-Diagnostic Functions .....	48
3-3	Replacing Parts .....	49
	3-3-1 Fuses .....	49
	3-3-2 Relays .....	50
	3-3-3 Batteries .....	51
3-4	Preventive Measures .....	52
3-5	Inspection .....	54

## 3-1 General

This section explains the proper maintenance and inspection procedures for the K-Type PCs, including specifics on replacing parts and taking precautionary measures to ensure reliable, trouble-free operation.

## 3-2 Self-Diagnostic Functions

The K-Type PC has self-diagnostic functions to identify many types of abnormal system conditions. These functions minimize downtime and enable quick, smooth error correction.

The ERROR light on the front panel of the Programming Console indicates hardware errors such as CPU, Expansion I/O Unit, and Remote I/O Unit malfunctions. The ALARM light indicates such things as scan time overrun, battery error, or user-defined errors. The following chart lists possible malfunctions, error messages, and correction procedures.

☒ Stays lit. ☒ Blinks. ● Not lit.

PC LED States						
Situation	Item	POWER	RUN	ALARM ERROR	Error Display	Correction
Fatal error	Power failure	●	●	●	—	Check the power supply voltage and power lines.
	CPU error (watchdog timer over 130 ms)				—	In PROGRAM mode, turn on power again. Check the user program again.
	Memory error	☒	●	☒	MEMORY ERR	Check the program and fix the error. Rerun the program. Check that the DIP switch settings are correct. Check that the EP-ROM chip is properly mounted. Check that the battery is properly inserted. Clear the error after fixing it.
	Missing END instruction				NO END INST	Write END in the final address of the program.
	I/O bus error				I/O BUS ERR	Check that all the lines are properly connected between the Units. Check that the CPU Left/Right Selector on the Expansion I/O Unit is properly set. Clear the error after fixing it.
	JMP over				JMP OVER	Make sure that there are no more than 8 JMP-JME pairs in the program.
Non-fatal error	Battery error	☒	☒	☒	BATT LOW	Check battery connections. Replace battery.
	Scan time overrun (watchdog timer 100 to 130 ms)				SCAN TIME OVER	Check the program again.

### I/O Link Unit Error

Item	I/O Link Unit LED States		Correction
	POWER	ERROR	
Power failure	●	●	Check the power supply voltage and power lines.
Transmission error	☒	☒ *	Check connections of the optical fiber cable and connectors. Check the channel and terminator settings.

\*Note: Blinking ERROR LED indicates normal transmission.

### 3-3 Replacing Parts

In order that your System be restored to operation as quickly as possible, it is advisable to maintain an adequate stock of replaceable parts on hand.

**CAUTION:**

Replace all fuses, relays, and other parts as quickly as possible. If the cover is left off for a long period the RAM's contents may be erased.

#### 3-3-1 Fuses

Replace fuses as follows:

- 1, 2, 3... 1. Turn off power to the Unit.
2. Using a Phillips screwdriver to loosen the 4 screws, remove the cover from the Unit, lifting it from the left.

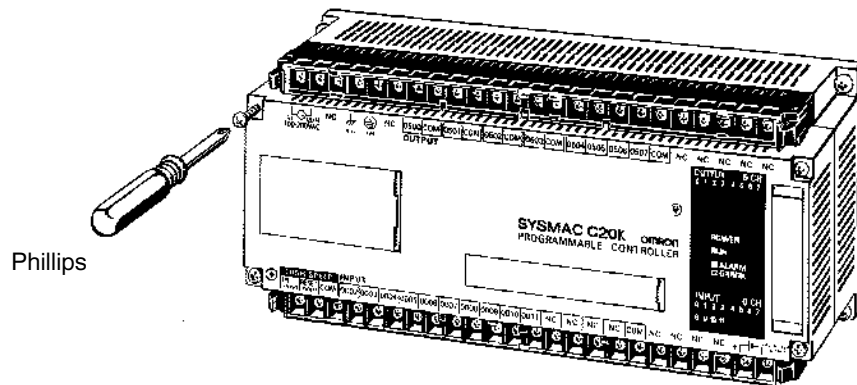

3. Remove the cover from the fuse socket as shown below.

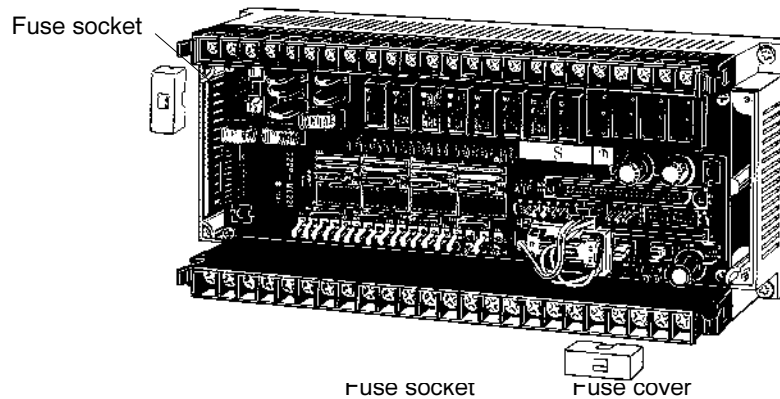

4. Using a standard screwdriver, remove the defective fuses and insert the new ones.
5. Replace the cover, positioning it over the Unit and snapping it into place by applying pressure to the area marked "OMRON."

The above procedure applies to CPUs and Expansion I/O Units. The procedure is similar for I/O Link Units except that the cover is secured by 4 catches instead of 4 screws. Use a standard screwdriver to pop the cover off and insert the fuses as shown below.

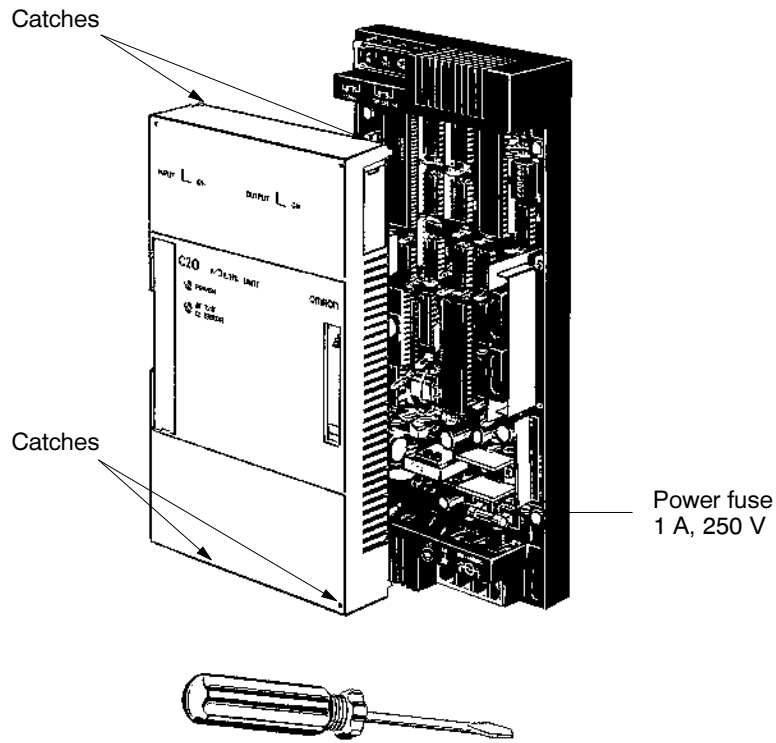

Refer to the chart below in selecting the proper fuses.

Power Supply Fuses $\phi$ 5.2 x 20 (MF1NR)			
CPU's, Expansion I/O Units	A-suffix	C16P	250 V, 1 A
		C20K, C28K, C40K	250 V, 2 A
		C60K	250 V, 3 A
	D-suffix	C16P	125 V, 1 A
		C20K, C28K, C40K	125 V, 3 A
		C60K	125 V, 5 A
I/O Link Units			250 V, 1 A

24-VDC Output Fuses $\phi$ 5.2 x 20 (MF51NR)		
CPUs, Expansion I/O Units (A-suffix only)	C16P	125 V, 0.2 A
	C20K, C28K, C40K, C60K	125 V, 0.5 A

### 3-3-2 Relays

Replace relays as follows:

- 1, 2, 3... 1. Turn off power to the Unit.
2. Using a Phillips screwdriver to loosen the 4 screws, remove the cover from the Unit, lifting it from the left.
3. Using the relay puller attached to the right of the Unit, remove the defective relay and insert the new one.

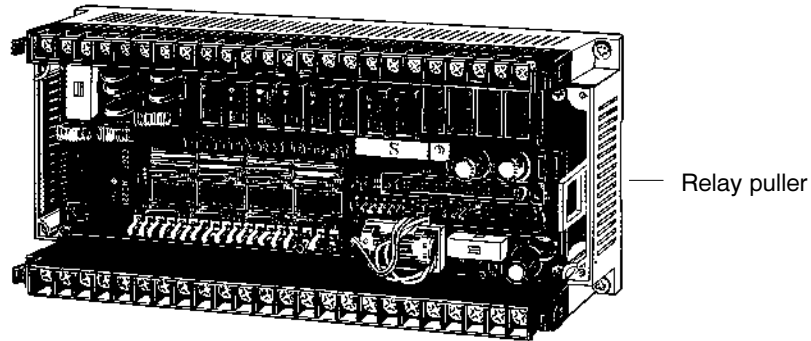

4. Replace the cover, positioning it over the Unit and snapping it into place by applying pressure to the area marked "OMRON."

Relays are arranged as follows for the C16P, C20K, C28K, C40K, and C60K. Among these Units, most models have relay sockets, although certain models do not. The C4K is not shown below; in this Unit the relays are directly attached.

C16P

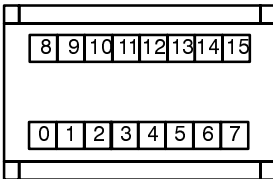

C20K

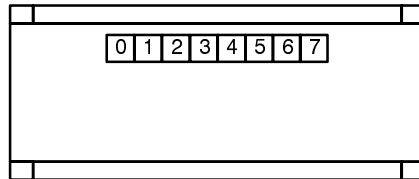

C28K

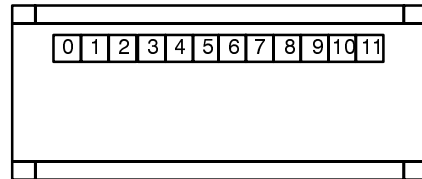

C40K

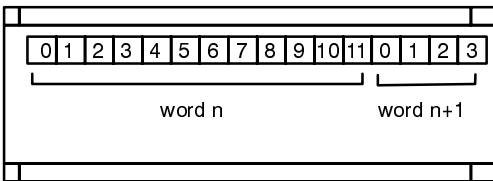

C60K

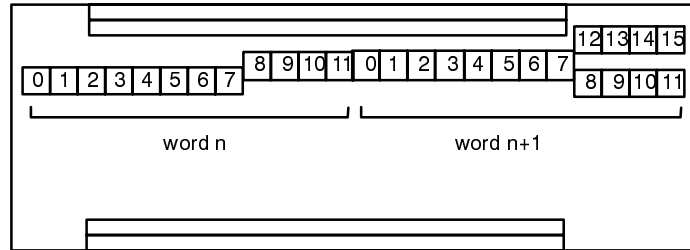

### 3-3-3 Batteries

The service life of the battery (3G2A9-BAT08) is five years at 25° C. It will be shorter at higher temperatures. The ALARM indicator blinks when the battery is discharged. If this happens, replace the battery within one week. The date by which the first battery must be replaced is written on the side panel of the CPU. If, for example, it says "FIRST REPLACEMENT 93/12," it means that you should replace the battery not later than December 1993.

**Caution** The new battery must be connected within five minutes of removing the old to preserve the data in the CPU. In addition, as there is danger of combustion, explosion or leakage, do not attempt to charge, heat or disassemble the battery, or short-circuit the terminals. When disposing of a used battery, do not throw it into a fire.

Replace the battery as follows:

1. Turn off the power to the Unit. If the power is off to begin with, turn it on and wait for at least 10 seconds. Then turn it off.

2. Using a Phillips screwdriver to loosen the 4 screws, remove the cover from the Unit, lifting it from the left.
3. Pull the battery from the holder and install the new one within five minutes.

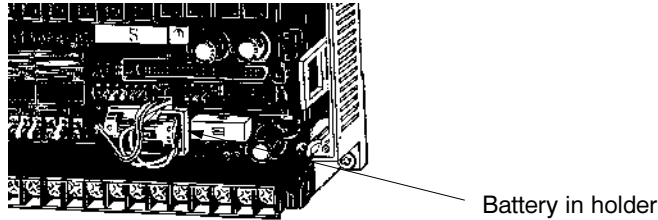

4. Replace the cover, positioning it over the Unit and snapping it into place by applying pressure to the area marked "OMRON."
5. Clear the ALARM on the Programming Console.

### 3-4 Preventive Measures

#### Load Circuit Fuses

A fuse in the load circuit will protect the output elements, circuit board, etc., in the event of a short in the output device.

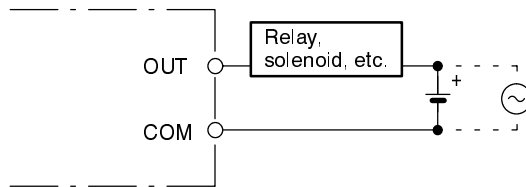

#### Prevention of Input Leakage Current

When two-wire sensors, such as photoelectric sensors and proximity sensors, or limit switches with neon lamp are connected to the CPU as input devices, the input signal may be erroneously turned ON by a leakage current over 1.5 A. To prevent this, connect a bleeder resistor as shown below.

Determine the resistance of the bleeder resistor by the following equation, where I is the leakage current.

$$R = 17.15/3.431 + 5 \text{ (k}\Omega \text{ max.)}$$

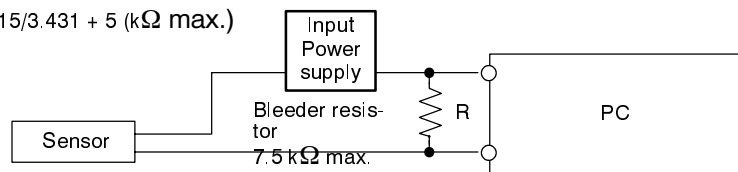

#### Prevention of Output Leakage Current

Likewise, if there is a danger of leakage current causing a transistor or triac to malfunction, connect a bleeder resistor as shown below. Determine the resistance of the bleeder resistor by the following equation.

$$R < V_{on}/I$$

$V_{on}$  = ON voltage of the load (V)  
 $I$  = leakage current (mA)  
 $R$  = bleeder resistance (k $\Omega$ )

Transistor	24 VDC	0.1 mA
Triac	100 VAC	2.0 mA
	200 VAC	5.0 mA

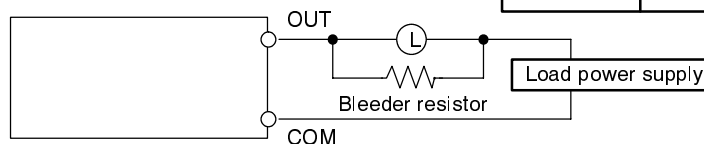

**Precautions for Inrush Current**

When connecting the resistor or triac output to a device (such as an incandescent lamp) which allows a high inrush current to flow, care must be taken to ensure the safety of the transistor or triac. The transistors and triacs are able to withstand an inrush current of ten times the rated current. If the actual inrush current will exceed that amount, use one of the following two circuits to reduce it.

This circuit allows a slight current (about 1/3 of the rated current) to flow through the load (i.e., the lamp), thus eliminating any initial surge of current.

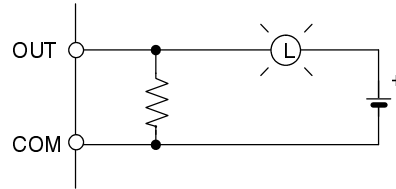

This circuit acts directly on the inrush current to limit it, but also reduces the voltage across the load.

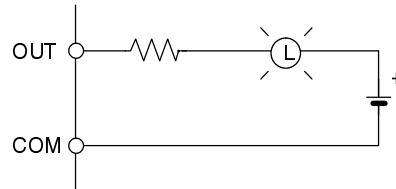

**Transistor Output Residual Voltage**

When connecting TTL circuits to transistor outputs, it is necessary (because of the transistor's residual voltage) to connect a pull-up resistor and a CMOS IC between the two.

**Inductive Load Surge Suppressors**

When an inductive load is connected to the input or output of the CPU, it is necessary to connect a surge suppressor or a diode in parallel with the load, as shown below, to absorb the counter-electromotive force produced by the load.

- Resistor: 50 Ω
- Capacitor: 0.47 μF
- Voltage: 200 V
- Diode: Must withstand voltages more than three times the load voltage and an average current of 1 A

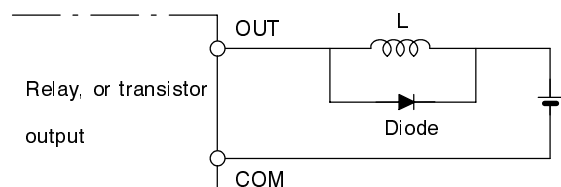
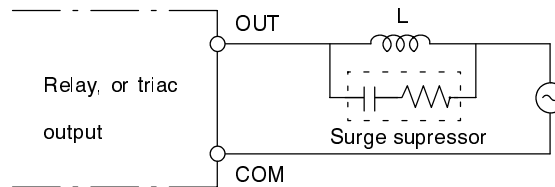
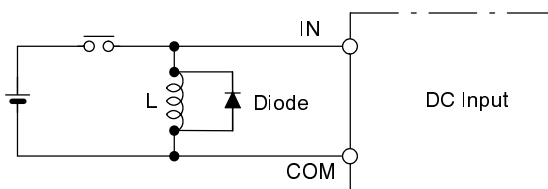

**Output Loads**

Be sure to take appropriate measures when any electrical device likely to produce noise is connected to the CPU as a load. For example, electromagnetic relays and valves generating noise of more than 1,200 V require noise suppression. For AC-operated noise sources, connect a surge suppressor in parallel with the coil of each device. For DC-operated noise sources, connect a diode in parallel with the coil of each device. When mounting a CPU and an Expansion I/O Unit on a control panel, be sure to completely ground the intermediate mounting plate. The mounting plate must be finished with high-conductivity plating to ensure noise immunity.

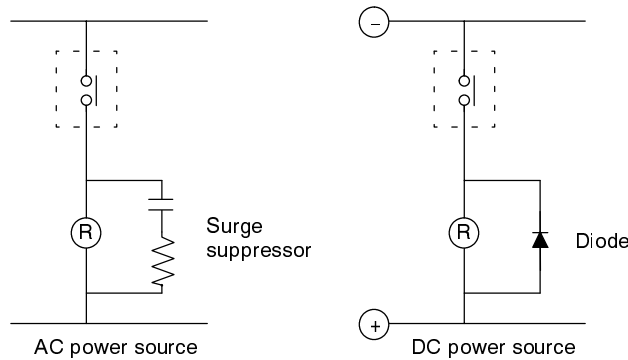

**3-5 Inspection**

In order for your PC to continue operating at optimum condition, periodic inspections are necessary. The main components of the PC are semiconductors and have a long service life, but, depending on the operating environment, there may be more or less deterioration of these and other parts. A standard inspection schedule would be once every six months to one year, but more frequent inspections may be advisable depending on the operating environment. Try to maintain the inspection schedule once it has been set.

Check to be sure that the power supply, ambient temperature, humidity, and so on, are within the specifications (see Appendix B). Be sure that there are no loose screws in any of the Units and that all battery and cable connections are secure. Clean any dust or dirt that has accumulated. Check all fuses, relays, and other replaceable parts.

# APPENDICES

Appendix A .....	55
Standard Models .....	55
Appendix B .....	63
Specifications .....	63
Appendix C .....	69
Programming Console Operations .....	69
Appendix D .....	71
Programming Instructions .....	71
Appendix E .....	77
System Configuration Chart .....	77

# Appendix A

## Standard Models

There are four K-type C-series CPUs. A CPU can be combined with any of six types of Expansion I/O Unit and/or an Analog Timer, Analog I/O Unit, or I/O Link Unit.

### CPUs

C20K-C \_ \_ \_

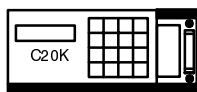

To order cable separately, specify C4K-CN501

C28K-C \_ \_ \_

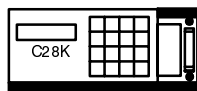

5 cm or 40 cm  
One included with each Expansion I/O Unit.  
(C20P-CN501/411)

C40K-C \_ \_ \_

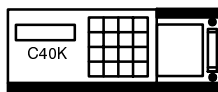

C60K-C \_ \_ \_

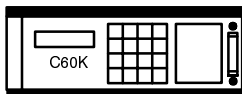

### Expansion I/O Units

C4K-I \_ /O \_ \_



C4K-CN501  
(included with Unit)

C16P-I \_ \_ /O \_ \_

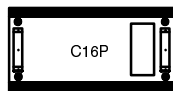

C20P-E \_ \_ \_



C28P-E \_ \_ \_

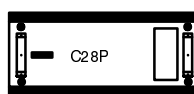

C40P-E \_ \_ \_

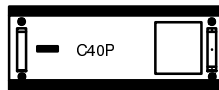

C60P-E \_ \_ \_



Cable (70 cm)  
C20P-CN711  
(ordered separately)

### Analog Timer Unit

C4K-TM



### Analog I/O Units

C1K-AD/DA

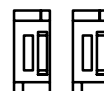

C4K-AD



### I/O Link Unit

C20-LK011/LK011-P

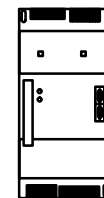

## CPUs

Name	Power supply	Inputs	Outputs	Model number	Standards	
C20K	100 to 240 VAC	24 VDC, 12 pts	Relay w/socket	8 pts	C20K-CDR-A	U, C
			Transistor, 1 A		C20K-CDT1-A	---
			Triac, 1 A		C20K-CDS1-A	U, C
		24 VDC, 2 pts 100 to 120 VAC, 10 pts	Relay w/socket		C20K-CAR-A	U, C
	Triac, 1A		C20K-CAS1-A		U, C	
	24 VDC	24 VDC, 12 pts	Relay w/socket		C20K-CDR-D	U, C
			Transistor, 1 A		C20K-CDT1-D	---
C28K	100 to 240 VAC	24 VDC, 16 pts	Relay w/socket	12 pts	C28K-CDR-A	U, C
			Transistor, 1 A		C28K-CDT1-A	---
			Triac, 1 A		C28K-CDS1-A	U, C
		24 VDC, 2 pts 100 to 120 VAC, 14 pts	Relay w/socket		C28K-CAR-A	U, C
	Triac, 1A		C28K-CAS1-A		U, C	
	24 VDC	24 VDC, 16 pts	Relay w/socket		C40K-CDR-D	U, C
			Transistor, 1 A		C28K-CDT1-D	---
C40K	100 to 240 VAC	24 VDC, 16 pts	Relay w/socket	16 pts	C40K-CDR-A	U, C
			Transistor, 1 A		C40K-CDT1-A	---
			Triac, 1 A		C40K-CDS1-A	U, C
		24 VDC, 2 pts 100 VAC, 22 pts	Relay w/socket		C40K-CAR-A	C
	Triac, 1 A		C40K-CAS1-A		U, C	
	24 VDC	24 VDC, 24 pts	Relay w/socket		C40K-CDR-D	U, C
			Transistor, 1 A		C40K-CDT1-D	---

Name	Power supply	Inputs	Outputs	Model number	Standards	
C60K	100 to 240 VAC	24 VDC, 32 pts	Relay w/socket	28 pts	C60K-CDR-A	U, C
			Transistor, 1 A		C60K-CDT1-A	---
			Triac, 1 A		C60K-CDS1-A	U, C
		24 VDC, 2 pts	Relay w/socket		C60K-CAR-A	C
			100 VAC, 30 pts		Triac, 1 A	C60K-CAS1-A
		24 VDC	24 VDC, 32 pts		Relay w/socket	C60K-CDR-D
	Transistor, 1 A			C60K-CDT1-D	---	

• U: UL, C: CSA, N: NK

See Omron sales representatives concerning operating conditions under which UL, CSA, and NK standards were met (Aug. 1988).

## I/O Units

Name	Power Supply	Inputs	Outputs	Model Number	Standards		
C4K I/O Unit	---	24 VDC, 4 pts	---	4 pts.	C4K-ID	U, C	
		100 to 120 VAC, 4 pts	---		C4K-IA	U, C	
		---	Relay w/socket		C4K-OR2	U, C	
			Transistor, 1 A		C4K-OT2	U, C	
			Triac, 1A		C4K-OS2	U, C	
		C16P I/O Unit	100 to 240 VAC		24 VDC, 16 pts	---	16 pts
---	Relay w/socket			C16P-OR-A	U, C		
	Transistor, 1 A			C16P-OT1-A	U, C		
	Triac, 1A			C16P-OS1-A	U, C		
---	24 VDC, 16 pts		---	C16P-ID	U, C		
	100 to 120 VAC, 16 pts		---	C16P-IA	U, C		
24 VDC	---		Relay w/socket	C16P-OR-D	U		
			Transistor, 1 A	C16P-OT1-D	U		
C20P I/O Unit	100 to 240 VAC		24 VDC, 12 pts	Relay w/socket	8 pts	C20P-EDR-A	U, C, N
				Transistor, 1 A		C20P-EDT1-A	N
		Triac, 1A		C20P-EDS1-A		U, C, N	
		100 to 120 VAC, 12 pts	Relay w/socket	C20P-EAR-A		U, C, N	
			Triac, 1A	C20P-EAS1-A		U, C, N	
		24 VDC	24 VDC, 12 pts	Relay w/socket		C20P-EDR-D	U, C, N
	Transistor, 1 A			C20P-EDT1-D	---		

Name	Power Supply	Inputs	Outputs		Model Number	Standards
C28P I/O Unit	100 to 240 VAC	24 VDC, 16 pts	Relay w/socket	12 pts	C28P-EDR-A	U, C, N
			Transistor, 1 A		C28P-EDT1-A	N
			Triac, 1A		C28P-EDS1-A	U, C, N
		100 to 120 VAC, 16 pts	Relay w/socket		C28P-EAR-A	U, C
	Triac, 1A		C28P-EAS1-A		U, C, N	
	24 VDC	24 VDC, 16 pts	Relay w/socket		C28P-EDR-D	U, C, N
			Transistor, 1 A		C28P-EDT1-D	---
	C40P I/O Unit	100 to 240 VAC	24 VDC, 24 pts		Relay w/socket	16 pts
Transistor, 1 A				C40P-EDT1-A	---	
Triac, 1A				C40P-EDS1-A	U, C, N	
100 to 120 VAC, 24 pts			Relay w/socket	C40P-EAR-A	U, C, N	
		Triac, 1A	C40P-EAS1-A	U, C, N		
24 VDC		24 VDC, 24 pts	Relay w/socket	C40P-EDR-D	U, C, N	
			Transistor, 1 A	C40P-EDT1-D	---	
C60P I/O Unit		100 to 240 VAC	24 VDC, 32 pts	Relay w/socket	28 pts	
	Transistor, 1 A			C60P-EDT1-A		---
	Triac, 1A			C60P-EDS1-A		---
	100 VAC, 32 pts		Relay w/socket	C60P-EAR-A		---
		Triac, 1A	C60P-EAS1-A	---		
	24 VDC	24 VDC, 32 pts	Relay w/socket	C60P-EDR-D		---
			Transistor, 1 A	C60P-EDT1-D		---

• U: UL, C: CSA, N: NK

See Omron sales representatives concerning operating conditions under which UL, CSA, and NK standards were met (Aug. 1988).

## Special Units

Name	Specifications		Model number	Standards
Analog Timer Unit	Settings: 0.1 s to 10 min (one cable, C4K-CN501, included)		C4K-TM	---
Analog Timer External Connector	2-m cable and connector		C4K-CN223	---
Analog Input Unit	1 input; input ranges: 4 to 20 mA, 1 to 5 V		C1K-AD	---
	4 inputs; input ranges: 4 to 20 mA, 1 to 5 V		C4K-AD	---
Analog Output Unit	1 output; output ranges: 4 to 20 mA, 1 to 5 V		C1K-DA	---
Host Link Unit	RS-232C	C20/C20K/C28K/C40K/C60K	3G2C7-LK201-EV1	---
	RS-422		3G2C7-LK202-EV1	---
I/O Link Unit	APF/PCF		C20-LK011-P	---
	PCF		C20-LK011	---
I/O Connecting Cable	For horizontal mounting; cable length: 5 cm (for maintenance)		C20P-CN501	---
	For vertical mounting; cable length: 40 cm (for maintenance)		C20P-CN411	---
I/O Connecting Cable	For horizontal mounting; connects to C4K I/O Units, Analog Timer Unit, or Analog I/O Units (for maintenance)	Cable length: 5 cm	C4K-CN501	---
		Cable length: 50 cm	C4K-CN512	---
		Cable length: 1 m	C4K-CN122	---
I/O Link Connecting Cable	Cable length: 70 cm; for I/O Link Units only		C20P-CN711	---
EPROM	2764		ROM-H	---
Battery Set	Built into CPU (same for all C-Series PCs)		3G2A9-BAT08	---
Relay	24-VDC contact relay		G6B-1174P-FD-US	U, C
	24-VDC transistor relay		G3SD-Z01P-PD-US	U, C
	24-VDC triac relay		G3S-201PL-PD-US	U, C

- U: UL, C: CSA, N: NK

See Omron sales representatives concerning operating conditions under which UL, CSA, and NK standards were met (Aug. 1988).

## DIN Products

Name	Specifications		Model number	Standards
DIN Track	Length: 50 cm	Not usable with C60K	PFP-50N	---
	Length: 1 m		PFP-100N	
			PFP-100N2	
End Plate	---		PFP-M	
Spacer	---		PFP-S	

## Factory Intelligent Terminal (FIT)

Name	Specifications	Model number	Standards
FIT	<ol style="list-style-type: none"> <li>1. FIT Computer</li> <li>2. SYSMATE Ladder Pack (2 system disks, 1 data disk)</li> <li>3. MS-DOS</li> <li>4. GPC Communications Adapter (C500-IF001)</li> <li>5. Peripheral Connecting Cable (3G2A2-CN221)</li> <li>6. Power Cord and 3-pin/2-pin plug</li> <li>7. Carrying Case</li> </ol>	FIT10-SET11-E	---

## Graphic Programming Console (GPC)

Name	Specifications		Model number	Standards
GPC (LCD display)	W/battery; power supply: 32 kw, 100 VAC; w/comments; System Memory Cassette ordered separately.		3G2C5-GPC03-E	---
	W/battery; power supply: 32 kw, 200 VAC; w/comments; System Memory Cassette ordered separately.		3G2C5-GPC04-E	
GPC Carrying Case	W/side pocket for accessories		C500-CS001	
GPC System Memory Cassette	For K-Type PCs	W/comments	3G2C5-MP304-EV3	
Cassette Interface Unit	Used to load programs in V8, M1R, M5R, POR, or S6 cassettes into the GPC and print them out through a Printer Interface Unit.		3G2A5-CMT01-E	

- U: UL, C: CSA, N: NK

See Omron sales representatives concerning operating conditions under which UL, CSA, and NK standards were met (Aug. 1988).

## Peripheral Devices

Name	Specifications	Model number	Standards	
Programming Console	Vertical, w/backlight	3G2A5-PRO13-E	U, C	
	Horizontal, w/backlight	3G2A6-PRO15-E	---	
	Hand-Held, w/backlight. The Programming Console Adapter AP003 and connecting cable CN222/CN422 are necessary. They are sold separately.	C200H-PR027-E	U, C	
Programming Console Mounting Bracket	Used to attach Hand-Held Programming Console to a panel.	C200H-ATT01	---	
Programming Console Connecting Cables	For C20K/C28K/C40K/C60K	1 m	3G2C7-CN122	---
		50 cm	3G2C7-CN512	---
	For Hand-Held Programming Console	2 m	C200H-CN222	U, C
		4 m	C200H-CN422	U, C
Programming Console Adapter	Attached to PC when connecting Programming Console via cable (for 3G2A5-PRO13-E or 3G2A6-PRO15-E).	3G2A5-AP001-E	---	
	Required to use Hand-Held Programming Console.	3G2A5-AP003	---	
Programming Console Base	Attached to Programming Console when connecting Programming Console via cable.	3G2A5-BP001	---	
Cassette Recorder Connecting Cable	Used to connect Programming Console, GPC, or Cassette Deck Interface Unit to a cassette deck; length: 1 m.	SCYPOR-PLG01	---	
PROM Writer	Used for all K-Type PCs.	C500-PRW06	---	
Printer Interface Unit	Interface for X-Y plotter or printer; System Memory Cassette ordered separately.	3G2A5-PRT01-E	---	
Memory Rack	K-Type PCs w/comment printing function	C500-MP102-EV3	---	
	K-Type PCs	C20-MP009-EV3		
Printer Connecting Cable	2 m (also used for X-Y plotter)	SCY-CN201	---	
Floppy Disk Interface Unit	C20K/C28K/C40K/C60K. GPC required; w/comment file; able to connect to NEC floppy disk controller	3G2C5-FDI03-E	---	
Peripheral Interface Unit	To connect GPC or FIT to K-Type PCs	3G2C7-IP002-V2	---	
Connecting Cable	Used to connect FIT or GPC to Peripheral Interface Unit and to connect Programming Console Adapter and Programming Console Base.	2 m	3G2A2-CN221	---
		5 m	3G2A5-CN523	
		10 m	3G2A5-CN131	
		20 m	3G2A5-CN231	
		30 m	3G2A5-CN331	
		40 m	3G2A5-CN431	
		50 m	3G2A5-CN531	

- U: UL, C: CSA, N: NK

See Omron sales representatives concerning operating conditions under which UL, CSA, and NK standards were met (Aug. 1988).

# Appendix B Specifications

## General Ratings

Supply voltage	-A suffix: 100 to 240 VAC 50/60 Hz -D suffix: 24 VDC
Operating voltage range	-A suffix: 85 to 264 VAC -D suffix: 20.4 to 26.4 VDC
Power consumption	-A suffix: 60 VA max. -D suffix: 40 W max.
24-VDC output *	0.3 A 24 VDC $\pm$ 10% (Use as DC power supply)
Insulation resistance	10 M $\Omega$ min. (at 500 VDC) between AC terminals and housing
Dielectric strength	2,000 VAC 50/60 Hz for 1 minute (between AC terminals and housing) 500 VAC 50/60 Hz for 1 minute (between DC terminals and housing)
Noise immunity	1,000 V p-p, pulse width: 100 ns to 1 $\mu$ s, rise time 1 ns
Vibration	10 to 35 Hz, 2 mm double amplitude, in X, Y, and Z directions; 2 hours each. (When mounted on a DIN rail: 16.7 Hz, 1 mm double amplitude, in X, Y, and Z directions, 1 hour each.)
Shock	10 G in X, Y, and Z directions, 3 times each
Ambient temperature	Operating: 0° to 55°C Storage: -20° to 65°C
Humidity	35% to 85% RH (without compensation)
Grounding	Less than 100 $\Omega$
Structure	IEC IP-30 (mounted in a panel)
Weight CPUs Expan. I/O Units	C20K, C28K: 1.9 kg max; C40K: 2.2 kg max.; C60K: 2.6 kg max. C20P, C28P: 1.7 kg max.; C40P: 2.0 kg max.; C60P: 2.4 kg max.
Dimensions (CPUs and Expan. I/O Units)	C20K, C28K: 250(w) x 110(h) x 100(d); C40K: 300(w) x 110(h) x 100(d); C60K: 350(w) x 140 (h) x 100 (d)

\* This output is not provided on models with the suffix -D in the model number (models accepting a DC supply voltage).

## CPU Characteristics

Main control elements	MPU, C-MOS, LS-TTL	
Programming method	Ladder diagram	
Instruction length	1 address/instruction, 6 bytes/instruction	
Number of instructions	49	
Execution time	10 $\mu$ s/instruction (average)	
Memory capacity	1,194 addresses	
IR bits	136 (1000 to 1807) 1804 to 1806 are reserved for RDM: FUN60 if it is used. 1807 is reserved as software reset input for HDM: FUN 98 if it is used.	
SR bits	16 (1808 to 1907) Normally-ON, normally-OFF, battery failure, initial scan ON, 0.1-s pulse, 0.2-s pulse, 1.0-s pulse, etc.	
HR bits	160 (HR 000 to 915)	
TM bits	8 (TR0 to 7)	
DM words	64 (DM words 00 to 63) DM words 00 to 31 are reserved as upper and lower limit setting areas for RDM: FUN 60 if it is used. DM words 32 to 63 are reserved as upper and lower limit setting areas for HDM: FUN 61 if it is used.	
Timer/counters	48 (total of TIMs, CNTs, and CNTRs) TIM 00 to 47 (0 to 999.9 s) TIMH 00 to 47 (0 to 99.99 s) CNT 00 to 47 (0 to 9999 counts) CNTR 00 to 47 (0 to 9999 counts) CNT 46 is used for RDM(60), and CNT 47 is used for HDM(61). When these instructions are not used, CNT 46 and 47 can be used for other purposes.	
High-speed counter	Count input: 0000 Hardware reset input: 0001 Software reset: 1807 Maximum response frequency: 2 kHz Preset count range: 0000 to 9999 Number of outputs: 16	High-speed counter specifications apply to counters created with HDM(61) only.
Reversible drum counter	Reset: 1804 Count input: 1805 Reverse input: 1806 Preset count range: 0000 to 9999 Number of outputs: 16	Reversible drum counter specifications apply to counters created with RDM(60) only.
Memory protection	Status of HR bits, present value of counters, and contents of DM bits are retained during power failure.	
Battery life	5 years at 25°C Battery life is shortened at temperatures higher than 25°C. Replace battery with new one within 1 week when ALARM indicator blinks.	
Self-diagnostic features	CPU failure (watchdog timer) Memory failure I/O bus failure Battery failure, etc.	
Program check	Program check (executed on start of RUN operation) END instruction missing JMP-JME error Coil duplication Circuit error DIFU/DIFD over error IL/ILC error	

Input Specifications

	DC input (photocoupler-isolated)	AC input* (photocoupler-isolated)
Supply voltage	24 VDC ±10%	100 to 120 VAC + 10%, -15% 50/60 Hz
Input voltage	3 kΩ	9.7 kΩ (50 Hz), 8 kΩ (60 Hz)
Input current	7 mA at 24 VDC	10 mA at 100 VAC
ON voltage	15 VDC min.	60 VAC min.
OFF voltage	5 VDC max.	20 VAC max.
ON delay time	2.5 ms max. (input 0000 and 0001: 0.15 ms)	35 ms max.
OFF delay time	2.5 ms max. (input 0000 and 0001: 0.15 ms)	55 ms max.

\* Inputs 0000 and 0001 operate on DC input voltage. The circuit configuration of these two points is the same as the DC input circuit shown above.

Note : The 24 VDC power source can be connected to either the positive or the negative terminal. Therefore both PNP input (negative common) and NPN (positive common) can be used.

Output Specifications

	ON-delay	OFF-delay	Switching capacity		Circuit configuration
			Max.	Min.	
Relay (photocoupler-isolated)	15 ms max.	15 ms max.	2 A at 250 VAC 2 A at 24 VDC (p.f. 1) 0.5 A at 250 VAC (p.f.0.4) 4 A/Common (4 points/Common) 6 A/Common (8 points/Common)	10 mA at 5 VDC	
Transistor* (photocoupler-isolated)	1.5 ms max.	1.5 ms max.	1 A/point at 5 to 24 VDC, 1.6 to 4 A/4 points 4 A/Common (4 points/Common) 6 A/Common (8 points/Common)	10 mA at 5 VDC, saturation voltage: 1.5 V max.	
Triac* (photocoupler-isolated)	1.5 ms max.	1/2 of load frequency + 1 ms max.	1 A/point at 85 to 250 VAC, 1.6 to 4 A/4 points 4 A/Common (4 points/Common) 6 A/Common (8 points/Common)	10 mA at 100 VAC, 20 mA at 200 VAC	

**I/O Link Units**

Supply voltage	100 to 120/200 to 240 VAC 50/60 Hz
Operating voltage range	85 to 132/ 170 to 264 VAC
Power consumption	15 VA max.
Insulation resistance	10 MΩ min. (at 500 VDC) between AC terminals and housing
Dielectric strength	2,000 VAC 50/60 Hz for 1 minute (between AC terminals and housing)
Noise immunity	1,000 V p-p, pulse width: 100 ns to 1 μs, rise time: 1 ns
Vibration	10 to 35 Hz, 2 mm double amplitude, in X, Y, and Z directions, 2 hours each
Shock	10 G in X, Y, and Z directions, 3 times each
Ambient temperature	Operating: 0° to 55°C Storage: -20° to 65°C
Humidity	35% to 85% RH (without condensation)
Grounding	Less than 100 Ω
Structure	IEC IP-30 (mounted in a panel)
Weight	1 kg max.
Dimensions	120(w) x 250(h) x 43(d)

**Relay Service Life (at Maximum Switching Capacity)**

Electical	300,000 operations [under resistive load (p.f. 1)] 100,000 operations [under inductive load (p.f. 0.4)]
Mechanical	50,000,000 operations

**Transistor and Triac Specifications**

	<b>Transistor G3SD-Z01P-PD-US</b>	<b>Triac G3S-201PL-PD-US</b>
Max. switching capacity	1 A at 5 to 24 VDC	1 A at 85 to 250 VAC
Min. switching capacity	10 mA at 5 VDC	10 mA at 100 VAC 20 mA at 200 VAC
Leakage current	100 μA at 24 VDC	2 mA at 100 VAC 5 mA at 200 VAC
Residual voltage	1.5 V max.	1.5 V max.
ON-delay time	1.5 ms max.	1.5 ms max.
OFF-delay time	1.5 ms max.	1/2 of load frequency + 1 ms max.

Do not mix output devices within the same common circuit.

**Transistor Inrush Current**

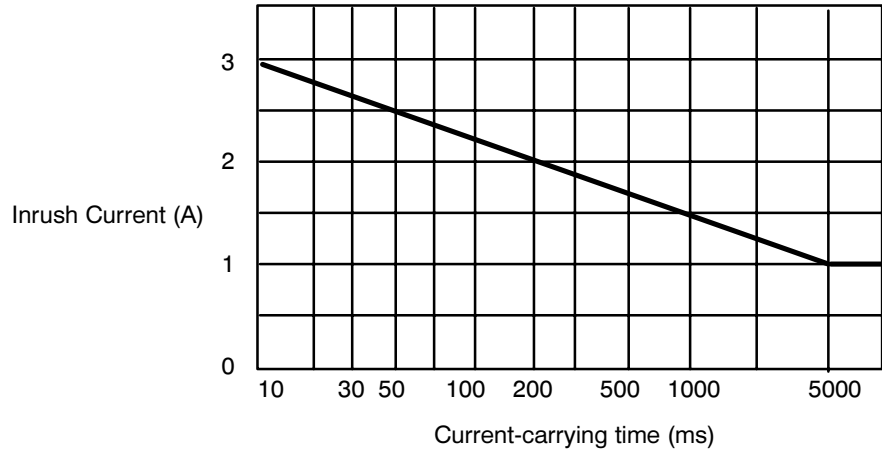

**Transistor and Triac Maximum Load Current**

The maximum load current for the four common circuits varies with the ambient temperature and is 4 to 1.6 A within a range of 20 to 55° C as shown below. Do not exceed the current value indicated in the chart at any given temperature.

**Ambient Temperature vs. Total Load Current of Each Common Circuit**

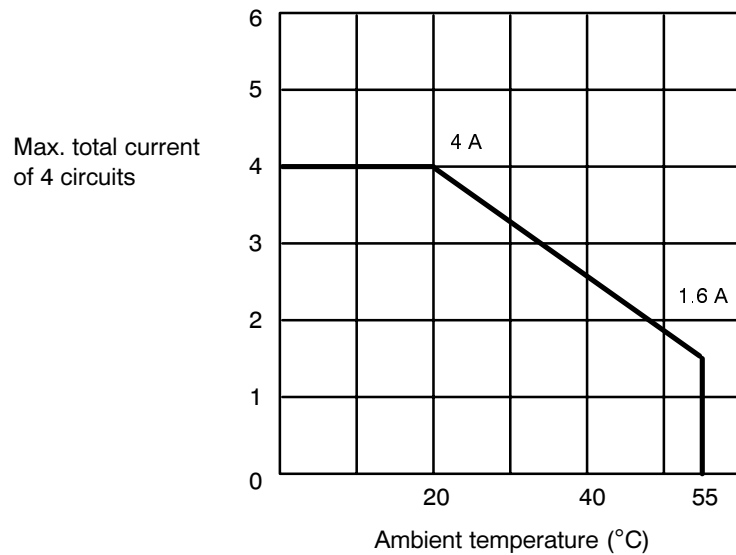

### Analog Timer Unit Specifications

Item	Specifications																																																																																																				
Oscillation method	RC oscillation																																																																																																				
Time setting range	Use the program to set any of the following four ranges, according to the chart shown below. 0.1 to 1 second 1 to 10 seconds 10 to 60 seconds 1 to 10 minutes																																																																																																				
Timer pause function	The timing operation can be paused if so specified by the program. Therefore, the timers can also be used as cumulative timers.																																																																																																				
Number of timer contacts	4																																																																																																				
Indicators	SET and TIME UP																																																																																																				
External variable resistor	External variable resistors can be used to set the time value when the IN/EXT selector is set to EXT. Use 20 kΩ external variable resistors																																																																																																				
Point number assignment	<table border="1" style="display: inline-table; margin-right: 20px;"> <thead> <tr> <th>Bit</th> <th>Word n</th> <th>Word(n + 5)</th> </tr> </thead> <tbody> <tr> <td>00</td> <td>Time-up contact T0</td> <td>T0 Start</td> </tr> <tr> <td>01</td> <td>Time-up contact T1</td> <td>T1 Start</td> </tr> <tr> <td>02</td> <td>Time-up contact T2</td> <td>T2 Start</td> </tr> <tr> <td>03</td> <td>Time-up contact T3</td> <td>T3 Start</td> </tr> <tr> <td>04</td> <td rowspan="4" style="vertical-align: middle;">Cannot be used</td> <td>T0 Pause</td> </tr> <tr> <td>05</td> <td>T1 Pause</td> </tr> <tr> <td>06</td> <td>T2 Pause</td> </tr> <tr> <td>07</td> <td>T3 Pause</td> </tr> <tr> <td>08</td> <td rowspan="4" style="vertical-align: middle;">Cannot be used</td> <td>T0 Range</td> </tr> <tr> <td>09</td> <td>T1 Range</td> </tr> <tr> <td>10</td> <td>T2 Range</td> </tr> <tr> <td>11</td> <td>T3 Range</td> </tr> <tr> <td>12</td> <td rowspan="4" style="vertical-align: middle;">Cannot be used</td> <td>T0 Range</td> </tr> <tr> <td>13</td> <td>T1 Range</td> </tr> <tr> <td>14</td> <td>T2 Range</td> </tr> <tr> <td>15</td> <td>T3 Range</td> </tr> </tbody> </table> <div style="display: inline-block; vertical-align: top; margin-left: 20px;"> <table border="1" style="margin-bottom: 10px;"> <tr> <td>Word n</td> <td>"1" when time is up</td> </tr> <tr> <td>Word (n + 5)</td> <td>"1" when time is set</td> </tr> </table> <table border="1" style="margin-bottom: 10px;"> <tr> <td>0</td> <td>Operates</td> </tr> <tr> <td>1</td> <td>Stops</td> </tr> </table> <table border="1"> <thead> <tr> <th>Timer no.</th> <th>Bit</th> <th>0.1 to 1 s</th> <th>1 to 10 s</th> <th>10 to 60 s</th> <th>1 to 10 m</th> </tr> </thead> <tbody> <tr> <td rowspan="2">T0</td> <td>06</td> <td>0</td> <td>1</td> <td>0</td> <td>0</td> </tr> <tr> <td>09</td> <td>0</td> <td>0</td> <td>1</td> <td>1</td> </tr> <tr> <td rowspan="2">T1</td> <td>10</td> <td>0</td> <td>1</td> <td>0</td> <td>0</td> </tr> <tr> <td>11</td> <td>0</td> <td>0</td> <td>1</td> <td>1</td> </tr> <tr> <td rowspan="2">T2</td> <td>12</td> <td>0</td> <td>1</td> <td>0</td> <td>0</td> </tr> <tr> <td>13</td> <td>0</td> <td>0</td> <td>1</td> <td>1</td> </tr> <tr> <td rowspan="2">T3</td> <td>14</td> <td>0</td> <td>1</td> <td>0</td> <td>0</td> </tr> <tr> <td>15</td> <td>0</td> <td>0</td> <td>1</td> <td>1</td> </tr> </tbody> </table> </div>	Bit	Word n	Word(n + 5)	00	Time-up contact T0	T0 Start	01	Time-up contact T1	T1 Start	02	Time-up contact T2	T2 Start	03	Time-up contact T3	T3 Start	04	Cannot be used	T0 Pause	05	T1 Pause	06	T2 Pause	07	T3 Pause	08	Cannot be used	T0 Range	09	T1 Range	10	T2 Range	11	T3 Range	12	Cannot be used	T0 Range	13	T1 Range	14	T2 Range	15	T3 Range	Word n	"1" when time is up	Word (n + 5)	"1" when time is set	0	Operates	1	Stops	Timer no.	Bit	0.1 to 1 s	1 to 10 s	10 to 60 s	1 to 10 m	T0	06	0	1	0	0	09	0	0	1	1	T1	10	0	1	0	0	11	0	0	1	1	T2	12	0	1	0	0	13	0	0	1	1	T3	14	0	1	0	0	15	0	0	1	1
Bit	Word n	Word(n + 5)																																																																																																			
00	Time-up contact T0	T0 Start																																																																																																			
01	Time-up contact T1	T1 Start																																																																																																			
02	Time-up contact T2	T2 Start																																																																																																			
03	Time-up contact T3	T3 Start																																																																																																			
04	Cannot be used	T0 Pause																																																																																																			
05		T1 Pause																																																																																																			
06		T2 Pause																																																																																																			
07		T3 Pause																																																																																																			
08	Cannot be used	T0 Range																																																																																																			
09		T1 Range																																																																																																			
10		T2 Range																																																																																																			
11		T3 Range																																																																																																			
12	Cannot be used	T0 Range																																																																																																			
13		T1 Range																																																																																																			
14		T2 Range																																																																																																			
15		T3 Range																																																																																																			
Word n	"1" when time is up																																																																																																				
Word (n + 5)	"1" when time is set																																																																																																				
0	Operates																																																																																																				
1	Stops																																																																																																				
Timer no.	Bit	0.1 to 1 s	1 to 10 s	10 to 60 s	1 to 10 m																																																																																																
T0	06	0	1	0	0																																																																																																
	09	0	0	1	1																																																																																																
T1	10	0	1	0	0																																																																																																
	11	0	0	1	1																																																																																																
T2	12	0	1	0	0																																																																																																
	13	0	0	1	1																																																																																																
T3	14	0	1	0	0																																																																																																
	15	0	0	1	1																																																																																																
Programming and timing chart	<p>Timer start input</p> <p>Word n 00 to 03</p> <p>Timer up output</p> <p>Timer start input</p> <p>Timer-up output</p> <p>Timer start 00 to 03, Word(n + 1)</p> <p>Time-up Word n 00 to 03</p>																																																																																																				

# Appendix C

## Programming Console Operations

Operation	Mode			Key Sequence
	RUN	MON.	PROG	
Clearing Memory	No	No	Yes	
Setting and Reading from Program Memory Address	Yes	Yes	Yes	
Checking the Program	No	No	Yes	
Program Searches	Yes	Yes	Yes	
Inserting and Deleting Instructions	No	No	Yes	<p>Locate position in program then enter: [Instruction] → INS → ↓</p> <p>Instruction currently displayed → DEL → ↑</p>

Operation	Mode			Key Sequence
	RUN	MON.	PROG	
Displaying and Clearing Error Messages	Yes	Yes	Yes	
Bit/Digit Monitor	Yes	Yes	Yes	
Force Set/Reset	No	Yes	Yes	<p>Bit or Timer/Counter currently monitored on left of display.</p>
Hexadecimal/BCD Data Modification	No	Yes	Yes	<p>Word currently monitored on left of display.</p>
Changing Timer/Counter SV	No	Yes	No	<p>Timer/Counter currently displayed.</p>
Saving Program Memory Data	No	No	Yes	
Restoring or Comparing Program Memory Data	No	No	Yes	

# Appendix D

## Programming Instructions

### Ladder Diagram Instructions

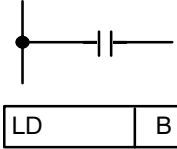
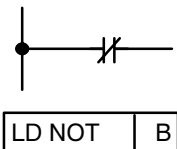
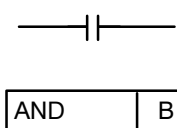
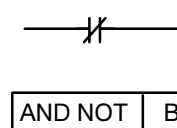
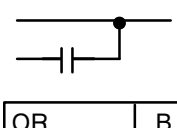
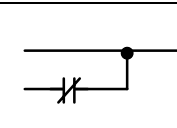
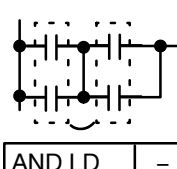
Name Mnemonic	Symbol	Function	Operands
<b>Load</b> LD		Used to start instruction block with status of designated bit.	<b>B:</b> IR SR HR TC TR
<b>Load Inverse</b> LD NOT		Used to start instruction block with inverse of designated bit.	<b>B:</b> IR SR HR TC TR
<b>AND</b> AND		Logically ANDs status of designated bit with execution condition.	<b>B:</b> IR SR HR TC TR
<b>AND Inverse</b> AND NOT		Logically ANDs inverse of designated bit with execution condition.	<b>B:</b> IR SR HR TC TR
<b>OR</b> OR		Logically ORs status of designated bit with execution condition.	<b>B:</b> IR SR HR TC TR
<b>OR Inverse</b> OR NOT		Logically ORs inverse of designated bit with execution condition.	<b>B:</b> IR SR HR TC TR
<b>Block AND</b> AND LD		Logically ANDs results of preceding blocks.	None

Area	IR	SR	HR	TR	TC	DM	#
Bits/Words	0000 to 1807	1808 to 1907	HR 000 to 915	TR 0 to 7	TC 00 to 47	DM 00 to DM 63	0000 to 9999 or 0000 to FFFF

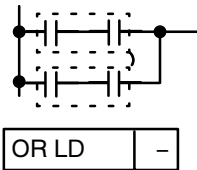
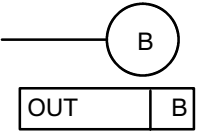
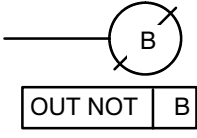
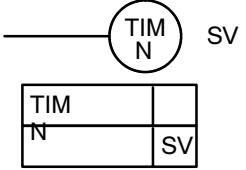
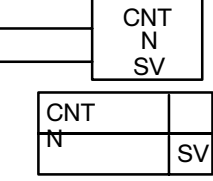
Name Mnemonic	Symbol	Function	Operands
<b>Block OR</b> OR LD		Logically ORs results of preceding blocks.	None
<b>Output</b> OUT		Turns ON designated bit.	<b>B:</b> IR HR TR
<b>Output Inverse</b> OUT NOT		Turns OFF designated bit.	<b>B:</b> IR HR TR
<b>Timer</b> TIM		ON-delay (decrementing) timer operation. Set value: 999.9 s; accuracy: +0.0/-0.1 s. Same TC bit cannot be assigned to more than one timer/counter. The TC bit is input as a constant.	<b>N:</b> TC <b>SV:</b> IR HR #
<b>Counter</b> CNT		A decrementing counter. SV: 0 to 9999; CP: count pulse; R: reset input. The TC bit is input as a constant.	<b>N:</b> TC <b>SV:</b> IR HR #

Special Instructions

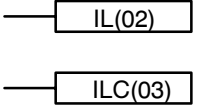
Name Mnemonic	Symbol	Function	Operands
<b>No Operation</b> NOP (00)	None	Nothing is executed and next instruction is moved to.	None
<b>End</b> END(01)		Required at the end of the program.	None
<b>Interlock</b> IL(02) <b>Interlock Clear</b> ILC(03)		If interlock condition is OFF, all outputs are turned OFF and all timer PVs reset between this IL(02) and the next ILC(03). Other instructions are treated as NOP; counter PV are maintained.	None

Area	IR	SR	HR	TR	TC	DM	#
Bits/Words	0000 to 1807	1808 to 1907	HR 000 to 915	TR 0 to 7	TC 00 to 47	DM 00 to DM 63	0000 to 9999 or 0000 to FFFF

Name Mnemonic	Symbol	Function	Operands
<b>Jump</b> JMP(04) <b>Jump End</b> JME(05)		Cause all instructions between JMP(04) and the corresponding JME(05) to be ignored. Corresponding JME is next one in program; only 8 JMP-JME pairs allowed per program.	None
<b>Single Step</b> STEP(08)		Is used in the definition of program sections. STEP N marks the beginning of the section identified by N. STEP without an operand indicates the end of a series of program sections.	<b>N:</b> HR
<b>Step Advance</b> SNXT(09)		SNXT resets the timers and clears the data areas used in the previous program section. SNTX must also be present at the end of a series of program sections.	<b>N:</b> HR
<b>Shift Register</b> SFT(10)		Creates a bit shift register from the starting word (St) through the ending word (E). I: input bit; P: shift pulse; R: reset input. St must be less than or equal to E and Bg and E must be in the same data area.	<b>St/E:</b> IR HR
<b>Latching Relay</b> KEEP(11)		Defines a bit (B) as a latch controlled by set (S) and reset (R) inputs.	<b>B:</b> IR HR
<b>Reversible Counter</b> CNTR (12)		Increases or decreases PV by one whenever the increment input (II) or decrement input (DI) signal goes from OFF to ON. SV: 0 to 9999; R: reset input. Must not access the same TC bit as another timer/counter. The TC bit is input as a constant.	<b>N:</b> TC <b>SV:</b> IR HR #
<b>Differentiate Up</b> DIFU(13) <b>Differentiate Down</b> DIFD(14)		DIFU turns ON the designated bit (B) for one scan on the rising edge of the input signal; DIFD turns ON the bit for one scan on the trailing edge. The maximum number of DIFU/DIFDs is 48.	<b>B:</b> IR HR
<b>High-speed Timer</b> TIMH(15)		A high-speed ON-delay (decrementing) timer. SV: 0.01 to 99.99 s; accuracy: +0.00/-0.01 s. Must not be assigned the same TC bit as another timer/counter. The TC bit is input as a constant.	<b>N:</b> TC <b>SV:</b> IR HR #

Area	IR	SR	HR	TR	TC	DM	#
Bits/Words	0000 to 1807	1808 to 1907	HR 000 to 915	TR 0 to 7	TC 00 to 47	DM 00 to DM 63	0000 to 9999 or 0000 to FFFF

Name Mnemonic	Symbol	Function	Operands
<b>Word Shift</b> WSFT(16)		Shifts data between the start and end words in word units.	<b>St/E:</b> IR HR DM
<b>Compare</b> CMP(20)		Compares two sets of four-digit hexadecimal data (Cp1 and Cp2) and outputs result to GR, EQ, and LE.	<b>Cp1/Cp2:</b> IR SR HR TC DM #
<b>Move</b> MOV(21)		Transfers source data (S) (word or four-digit constant) to destination word (D).	<b>S:</b> IR SR HR TC DM # <b>D:</b> IR HR DM
<b>Move Inverse</b> MVN(22)		Inverts source data (S) (word or four-digit constant) and then transfers it to destination word(D).	<b>S:</b> IR SR HR TC DM # <b>D:</b> IR HR DM
<b>BCD to Binary</b> BIN(23)		Converts four-digit, BCD data in source word (S) into 16-bit binary data, and outputs converted data to result word (R).  	<b>S:</b> IR SR HR TC DM <b>R:</b> IR HR DM
<b>Binary to BCD</b> BCD(24)		Converts binary data in source word (S) into BCD, and outputs converted data to result word (R).  	<b>S:</b> IR SR HR DM <b>R:</b> IR HR DM
<b>BCD Add</b> ADD(30)		Adds two four-digit BCD values (Au and Ad) and content of CY, and outputs result to specified result word (R).  $Au + Ad + \boxed{CY} \rightarrow R \boxed{CY}$	<b>Au/Ad:</b> IR SR HR TC DM # <b>R:</b> IR HR DM

Area	IR	SR	HR	TR	TC	DM	#
Bits/Words	0000 to 1807	1808 to 1907	HR 000 to 915	TR 0 to 7	TC 00 to 47	DM 00 to DM 63	0000 to 9999 or 0000 to FFFF

Name Mnemonic	Symbol	Function	Operands				
<b>BCD Subtract</b> SUB(31)	<table border="1"> <tr><td>SUB(31)</td></tr> <tr><td>Mi</td></tr> <tr><td>Su</td></tr> <tr><td>R</td></tr> </table>	SUB(31)	Mi	Su	R	Subtracts both four-digit BCD subtrahend (Su) and content of CY from four-digit BCD minuend (Mi) and outputs result to specified result word (R).  $Mi - Su \rightarrow \boxed{CY} \rightarrow R \boxed{CY}$	<b>Mi/Su:</b> IR SR HR TC DM #  <b>R:</b> IR HR DM
SUB(31)							
Mi							
Su							
R							
<b>BCD Multiply</b> MUL(32)	<table border="1"> <tr><td>MUL(32)</td></tr> <tr><td>Md</td></tr> <tr><td>Mr</td></tr> <tr><td>R</td></tr> </table>	MUL(32)	Md	Mr	R	Multiplies a words data or a four-digit BCD value(Md) and another words data (Mr) and outputs the result to a specified result word (R).  $Md \times Mr \rightarrow \boxed{R} \boxed{R + 1}$	<b>Md/Mr:</b> IR SR HR TC DM #  <b>R:</b> IR HR DM
MUL(32)							
Md							
Mr							
R							
<b>BCD Divide</b> DIV(33)	<table border="1"> <tr><td>DIV(33)</td></tr> <tr><td>Dd</td></tr> <tr><td>Dr</td></tr> <tr><td>R</td></tr> </table>	DIV(33)	Dd	Dr	R	Divides a word's data or a four-digit BCD dividend (Dd) and another words data (Dr) and outputs result to specified result word (R).  $\boxed{R} \boxed{R + 1}$	<b>Dd/Dr:</b> IR SR HR TC DM #  <b>R:</b> IR HR DM
DIV(33)							
Dd							
Dr							
R							
<b>Set Carry</b> STC(40)	<table border="1"> <tr><td>STC(40)</td></tr> </table>	STC(40)	Sets carry flag (i.e., turns CY ON).	None			
STC(40)							
<b>Clear Carry</b> CLC(41)	<table border="1"> <tr><td>CLC(41)</td></tr> </table>	CLC(41)	CLC clears carry flag (i.e, turns CY OFF).	None			
CLC(41)							
<b>Reversible Drum Counter</b> RDM(60)	<table border="1"> <tr><td>RDM(60)</td></tr> <tr><td>D</td></tr> </table>	RDM(60)	D	High-speed UP-DOWN counter operation.	<b>D:</b> IR HR DM		
RDM(60)							
D							
<b>High-speed Drum Counter</b> HDM(61)	<table border="1"> <tr><td>HDM(61)</td></tr> <tr><td>D</td></tr> </table>	HDM(61)	D	A 2-kHz counter with both software and hardware resets.	<b>D:</b> IR HR DM		
HDM(61)							
D							
<b>End Wait</b> ENDW(62)	<table border="1"> <tr><td>ENDW(62)</td></tr> <tr><td>N</td></tr> </table>	ENDW(62)	N	Used to force a scan time longer than normal causing the CPU to wait.	<b>N:</b> IR HR TC DM #		
ENDW(62)							
N							
<b>Network Identifier</b> NETW(63)	<table border="1"> <tr><td>NETW(63)</td></tr> <tr><td>#</td></tr> </table>	NETW(63)	#	Used to leave comments in the program.	#		
NETW(63)							
#							

Area	IR	SR	HR	TR	TC	DM	#
Bits/Words	0000 to 1807	1808 to 1907	HR 000 to 915	TR 0 to 7	TC 00 to 47	DM 00 to DM 63	0000 to 9999 or 0000 to FFFF

Name Mnemonic	Symbol	Function	Operands
<b>4 to 16 Decoder</b> MLPX(76)		<p>Converts up to four hexadecimal digits in source word (S) into decimal values from 0 to 15 and turns ON, in result word(s) (R), bit(s) corresponding to converted value. Digits designated in Di digits (rightmost digit: first digit to be converted; next digit to left: number of digits to be converted minus 1).</p>	<p><b>S:</b> IR SR HR TC DM</p> <p><b>Di:</b> IR HR TC DM #</p> <p><b>R:</b> IR HR DM</p>
<b>16 to 4 Encoder</b> DMPX(77)		<p>Determines position of highest ON bit in source word(s) (starting word: S) and turns ON corresponding bit(s) in result word (R). Digit designations made with Di digits (rightmost digit: first digit to receive converted value; next digit to left: number of words to be converted minus 1).</p>	<p><b>S:</b> IR SR HR TC DM</p> <p><b>R:</b> IR HR DM</p> <p><b>Di:</b> IR HR TC DM #</p>
<b>Reversible Shift Register</b> SFT(84)		<p>Shifts data in a specified word or series of words one bit to either the left or the right.</p>	<p><b>St/E:</b> IR HR DM</p> <p><b>C:</b> IR HR DM</p>
<b>Subroutine Entry</b> SBS(91)		<p>Transfers control of a program over to a subroutine N.</p>	<p><b>N:</b> 00 to 15</p>
<b>Subroutine Definition Start</b> SBN(92)		<p>Indicates the beginning of a subroutine definition.</p>	<p><b>N:</b> 00 to 15</p>
<b>Subroutine Definition End</b> RET(93)		<p>Indicates the end of a subroutine definition.</p>	<p>None</p>
<b>I/O Refresh</b> IORF(97)		<p>Refreshes I/O words between a specified range. Refreshes words in word units.</p>	<p><b>St/E:</b> 00 to 09</p>

Area	IR	SR	HR	TR	TC	DM	#
Bits/Words	0000 to 1807	1808 to 1907	HR 000 to 915	TR 0 to 7	TC 00 to 47	DM 00 to DM 63	0000 to 9999 or 0000 to FFFF

# Appendix E

## System Configuration Chart

A K-type PC can be configured with a CPU Unit and one or more of the following Units: Expansion I/O Units, Analog Timer Units, or an I/O Link Unit. All of these Units are connected in series with the CPU Unit at one end. An I/O Link Unit, if included, must be on the other end (meaning only one I/O Link Unit can be used) and an Analog Timer Unit cannot be used. The rest of the Units can be in any order desired.

There is a restriction in the number of Units which can be included. To compute the number of Units for this restriction, add up all of the Units counting the C40K CPU Unit, C60K CPU Unit, C40K Expansion I/O Unit and C60K Expansion I/O Unit as two Units each and any other Units as one Unit each. This total must be no more than five.

The following table shows some of the combinations that can be used to achieve specific numbers of I/O points. The numbers in the table indicate the number of Units of that size to be used as either the CPU or Expansion I/O Unit; any one of the Units can be the CPU Unit. This table does not include the C4P or C16P Expansion I/O Units, the Analog Timer Unit, or the I/O Link Unit, which can be used for greater system versatility or special applications. Refer to the remaining tables in this section for other combinations.

I/O points			Count as 2 each		Count as 1 each	
Total	In	Out	C60 (32/28)	C40 (24/16)	C28 (16/12)	C20 (12/8)
20	12	8	---	---	---	1
28	16	12	---	---	1	---
40	24	16	---	---	---	2
			---	1	---	---
48	28	20	---	---	1	1
56	32	24	---	---	2	---
60	32	28	1	---	---	---
	36	24	---	---	---	3
---			1	---	1	
68	40	28	---	---	1	2
			---	1	1	---
76	44	32	---	---	2	1
80	48	32	---	---	---	4
			---	1	---	2
			---	2	---	---
			1	---	---	2
84	48	36	---	---	3	---
88	48	40	1	---	1	---
	52	36	---	---	1	3
---			1	1	1	
96	56	40	---	---	2	2
			---	1	2	---
100	56	44	1	---	---	2
			1	1	---	---

I/O points			Count as 2 each		Count as 1 each			
Total	In	Out	C60 (32/28)	C40 (24/16)	C28 (16/12)	C20 (12/8)		
100	60	40	---	---	---	5		
			---	1	---	3		
			---	2	---	1		
104	60	44	---	---	3	1		
108	60	48	1	---	1	1		
			64	44	---	---	1	4
					---	1	1	2
---	---	2	1	---				
112	64	48	---	---	4	---		
116	64	52	1	---	2	---		
			68	48	---	---	2	3
					---	1	2	1
120	64	56	2	---	---	---		
			68	52	1	---	---	3
					1	1	---	1
124	72	52	---	---	3	2		
			---	1	3	---		
128	72	56	1	---	1	2		
			1	1	1	---		
132	76	56	---	---	4	1		
136	76	60	1	---	2	1		
140	76	64	2	---	---	1		
	80	60	---	---	5	---		
144	80	64	1	---	3	---		
148	80	68	2	---	1	---		

The tables on the following pages show the possible configurations for a K-type PC. Although the tables branch to show the various possibilities at any one point, there can be no branching in the actual PC connections. You can choose either branch at any point and go as far as required, i.e., you can break off at any point to create a smaller PC System. When implementing a system there is a physical restriction on the total cable length allowable. The sum of the lengths of all cables in the system must be limited to less than 1.2 meters.

The tables also show which words will be input words and which words will be output words. All of these are determined by the position of the Unit in the configuration except for the C4P and C16P Expansion I/O Units, in which case the model of the Unit determines whether the words are input or output.

The symbols used in the table represent the following:

C20K/C28K		C20K or C28K CPU Unit
Input	Output	

C40K/C60K				C40K or C60K CPU Unit
Input	Output	Input	Output	

C4K/C16P	C4P or C16P Expansion I/O Unit
In/Output	

C20P/C28P/TU/LU.		C20P Expansion I/O Unit, C28K Expansion I/O Unit, Analog Timer Unit, or I/O Link Unit
Input	Output	

C40P/C60P				C40P or C60P Expansion I/O Unit
Input	Output	Input	Output	

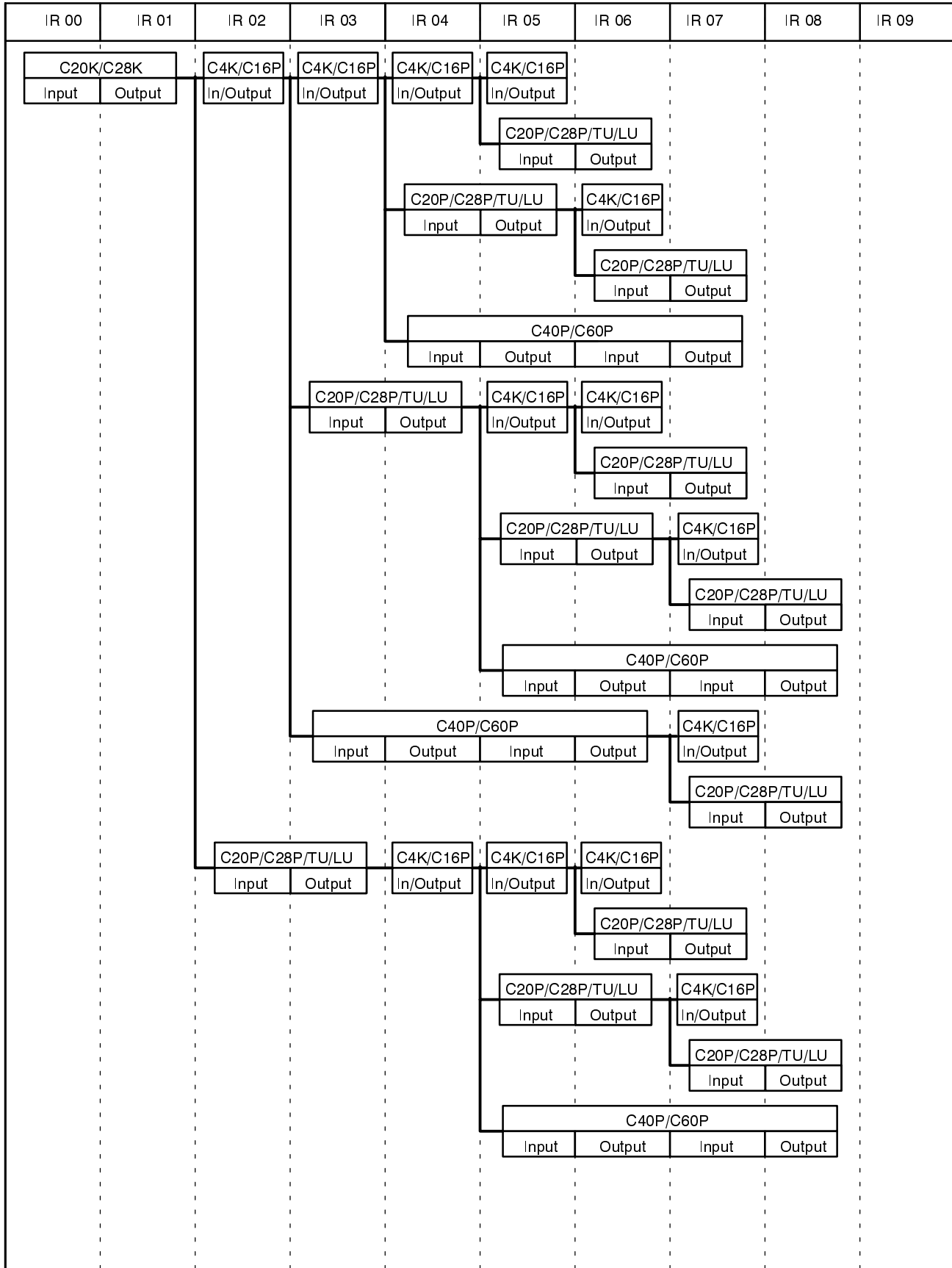

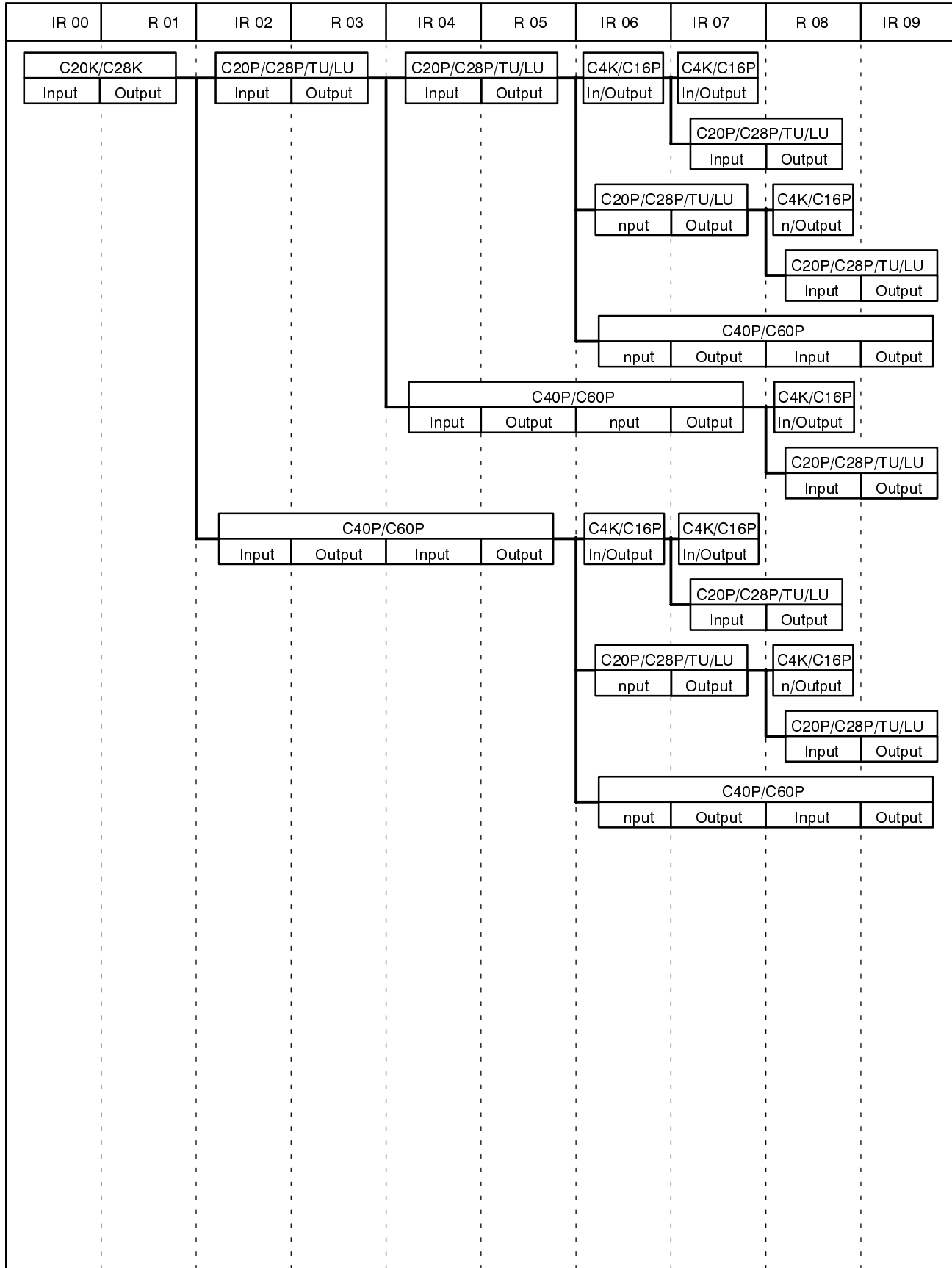

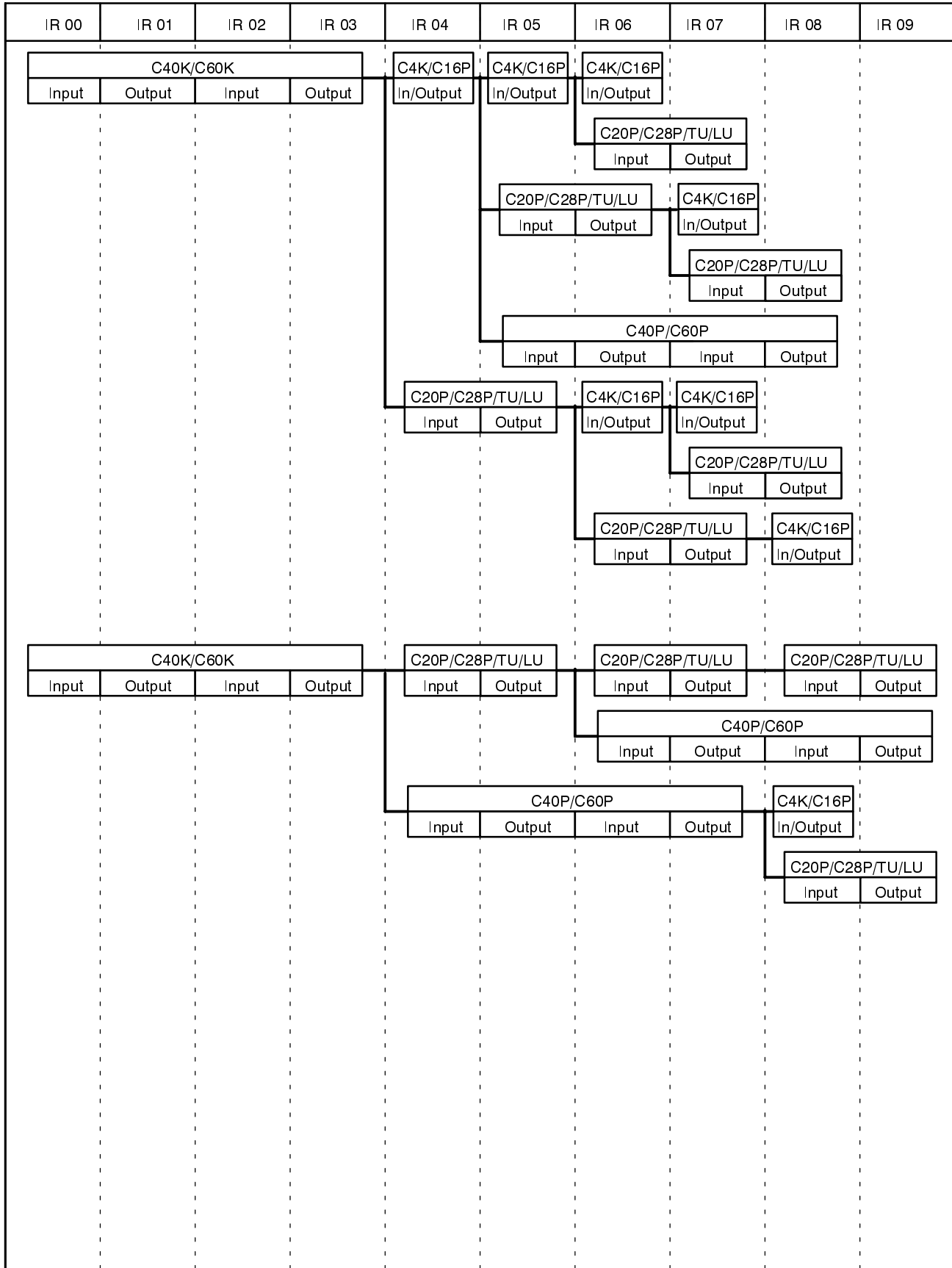

## Revision History

A manual revision code appears as a suffix to the catalog number on the front cover of the manual.

Cat. No. W147-E3-01

↑  
Revision code

The following table outlines the changes made to the manual during each revision. Page numbers refer to the previous version.

Revision code	Date	Revised content
1	September 1993	Original production