

Machine Automation Controller NJ-series

EtherCAT Connection Guide

OMRON Corporation

3G3RX-V1-Series Inverter

Network
Connection
Guide

Table of Contents

1. Related Manuals	1
2. Terms and Definition	2
3. Remarks	3
4. Overview	5
5. Applicable Devices and Support Software	5
5.1. Applicable Devices.....	5
5.2. Device Configuration.....	6
6. EtherCAT Settings	7
6.1. EtherCAT Communications Settings	7
6.2. Assignment of EtherCAT Communications	7
7. Connection Procedure	8
7.1. Work Flow	8
7.2. Setting Up the Inverter	9
7.3. Setting Up the Controller.....	15
7.4. Connection Status Check.....	23
8. Initialization Method	29
8.1. Controller	29
8.2. Inverter.....	29
9. Revision History	30

1. Related Manuals

The table below lists the manuals related to this document.

To ensure system safety, make sure to always read and heed the information provided in all Safety Precautions, Precautions for Safe Use, and Precaution for Correct Use of manuals for each device which is used in the system.

Cat. No.	Model	Manual name
W500	NJ501-□□□□ NJ301-□□□□	NJ-series CPU Unit Hardware User's Manual
W501	NJ501-□□□□ NJ301-□□□□	NJ-series CPU Unit Software User's Manual
W505	NJ501-□□□□ NJ301-□□□□	NJ-series CPU Unit Built-in EtherCAT Port User's Manual
W504	SYSMAC-SE2□□□□	Sysmac Studio Version 1 Operation Manual
I578	3G3RX-V1 series	High-function General-purpose Inverter 3G3RX-V1 User's Manual
I574	3G3AX-MX2-ECT 3G3AX-RX-ECT	MX2 series/RX-V1 series EtherCAT Communication Unit USER'S MANUAL

2. Terms and Definition

Terms	Explanation and Definition
PDO Communications (Communications using Process Data objects)	<p>This method is used for cyclic data exchange between the master unit and the slave units.</p> <p>PDO data (i.e., I/O data that is mapped to PDOs) that is allocated in advance is refreshed periodically each EtherCAT process data communications cycle (i.e., the period of primary periodic task).</p> <p>The NJ-series Machine Automation Controller uses process data communications for commands to refresh I/O data in a fixed control period, including I/O data for EtherCAT Slave Units, and the position control data for the Servomotors.</p> <p>It is accessed from the NJ-series Machine Automation Controller in the following ways.</p> <ul style="list-style-type: none"> •With device variables for EtherCAT slave I/O •With Axis Variables for Servo Drive and encoder input slaves to which assigned as an axis
SDO Communications (Communications using Service Data objects)	<p>This method is used to read and write the specified slave unit data from the master unit when required.</p> <p>The NJ-series Machine Automation Controller uses SDO communications for commands to read and write data, such as for parameter transfers, at specified times.</p> <p>The NJ-series Machine Automation Controller can read/write the specified slave data (parameters and error information, etc.) with the EC_CoESDORead (Read CoE SDO) instruction or the EC_CoESDOWrite (Write CoE SDO) instruction.</p>
Slave Unit	<p>There are various types of slaves such as Servo Drives that handle position data and I/O terminals that control the bit signals.</p> <p>The slave receives output data sent from the master, and transmits input data to the master.</p>
Node address	<p>An address to identify the unit connected to EtherCAT.</p>
ESI file (EtherCAT Slave Information file)	<p>The ESI files contain information unique to the EtherCAT slaves in XML format.</p> <p>Install an ESI file into the Sysmac Studio, to allocate slave process data and make other settings.</p>

3. Remarks

- (1) Understand the specifications of devices which are used in the system. Allow some margin for ratings and performance. Provide safety measures, such as installing safety circuit in order to ensure safety and minimize risks of abnormal operation
- (2) To ensure system safety, always read and heed the information provided in all Safety Precautions, Precautions for Safe Use, and Precaution for Correct Use of manuals for each device used in the system.
- (3) The users are encouraged to confirm the standards and regulations that the system must conform to.
- (4) It is prohibited to copy, to reproduce, and to distribute a part of or whole of this document without the permission of OMRON Corporation.
- (5) This document provides the latest information as of March 2013. The information contained in this document is subject to change for improvement without notice.

About Intellectual Property Right and Trademarks

Microsoft product screen shots reprinted with permission from Microsoft Corporation.

Windows is a registered trademark of Microsoft Corporation in the USA and other countries.

EtherCAT® is registered trademark and patented technology, licensed by Beckhoff Automation GmbH, Germany.

Company names and product names in this document are the trademarks or registered trademarks of their respective companies.

The following notation is used in this document.

**WARNING**

Indicates a potentially hazardous situation which, if not avoided, could result in death or serious injury. Additionally, there may be severe property damage.

**Caution**

Indicates a potentially hazardous situation which, if not avoided, may result in minor or moderate injury, or property damage.



The filled circle symbol indicates operations that you must do. The specific operation is shown in the circle and explained in text. This example shows a general precaution for something that you must do.

**Precautions for Safe Use**

Indicates precautions on what to do and what not to do to ensure using the product safely.

**Precautions for Correct Use**

Indicates precautions on what to do and what not to do to ensure proper operation and performance.

**Additional Information**

Provides useful information.

Additional information to increase understanding or make operation easier.

4. Overview

This document describes the procedure for connecting the Inverter (3G3RX-V1 series) of OMRON Corporation (hereinafter referred to as OMRON) to NJ-series Machine Automation Controller (hereinafter referred to as Controller) on EtherCAT and provides the procedure for checking their connection.

Refer to *Section 7 Connection Procedure* to understand the setting method and key points to connect the devices via EtherCAT.

5. Applicable Devices and Support Software

5.1. Applicable Devices

The following devices can be connected.

Manufacturer	Name	Model	Version
OMRON	NJ series CPU Unit	NJ501-□□□□□ NJ301-□□□□□	-
OMRON	Inverter	3G3RX-A□□□□□-V1	2.0
OMRON	EtherCAT Communications Unit	3G3AX-RX-ECT	-



Additional Information

As applicable devices above, the devices listed in Section 5.2. are actually used in this document to check the connection. When using devices not listed in Section 5.2, check the connection by referring to the procedure in this document.



Additional Information

This document describes the procedure to establish the network connection. It does not provide information about operation, installation nor wiring method of each device.

For details on the products (other than communication connection procedures) listed above, refer to the manuals for the corresponding products or contact your OMRON representative.

5.2. Device Configuration

The hardware components to reproduce the connection procedure in this document are as follows.

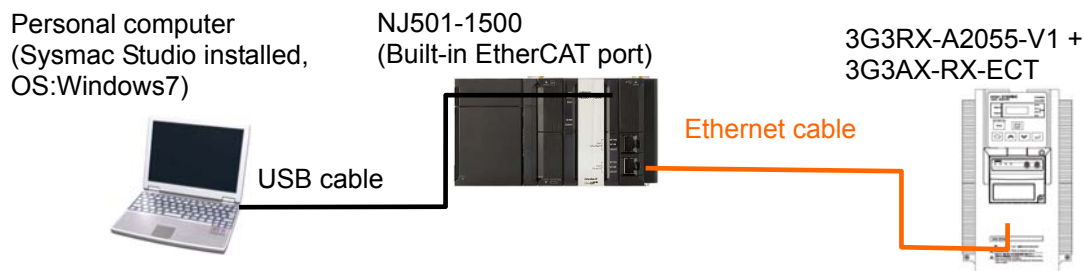

Manufacturer	Name	Model	Version
OMRON	CPU Unit (Built-in EtherCAT port)	NJ501-1500	Ver.1.01
OMRON	Power Supply Unit	NJ1W-PA3001	
OMRON	Sysmac Studio	SYSMAC-SE2□□□□	Ver.1.03
-	Personal computer (OS: Windows7)		
-	USB cable (USB 2.0 type B connector)		
OMRON	Ethernet cable (with industrial Ethernet connector)	XS5W-T421-□M□-K	
OMRON	Inverter	3G3RX-A2055-V1	V2.0
OMRON	EtherCAT Communications Unit	3G3AX-RX-ECT	



Precautions for Correct Use

The connection line of EtherCAT communication cannot be shared with other networks, such as Ethernet or EtherNet/IP.

The switching hub for Ethernet cannot be used for EtherCAT.

Please use the cable of Category 5 or higher, double-shielded with aluminum tape and braided shielding and the shielded connector of Category 5 or higher.

Connect the cable shield to the connector hood at both ends of the cable.



Additional Information

For information on the specifications of the Ethernet cable and network wiring, refer to *Section 4 EtherCAT Network Wiring* in the *NJ-series CPU Unit Built-in EtherCAT Port User's Manual* (Cat. No. W505).



Additional Information

The system configuration in this document uses USB for the connection between the personal computer and the NJ-series CPU Unit. For information on how to install a USB driver, refer to *A-1 Driver Installation for Direct USB Cable Connection* of the *Sysmac Studio Operation Manual* (Cat.No. W504).

6. EtherCAT Settings

This section describes the specifications such as communication parameters and variables that are set in this document.

Hereinafter, the Inverter is referred to as "destination device" in some descriptions.

6.1. EtherCAT Communications Settings

The setting required for EtherCAT communications is as follows.

	3G3RX-A2055-V1
Node address	01

6.2. Assignment of EtherCAT Communications

The device variables of the destination device are allocated to the Controller's global variables.

The relationship between the device data and the global variables is shown below.

■ Output area (Controller → Destination device)

Destination device data	Device variable name	Data type
Operation command to Inverter	E001_Command	WORD
Output frequency	E001_Frequency_reference	INT

■ Input area (Controller ← Destination device)

Destination device data	Global variable name	Data type
Status	E001_Status	WORD
Output frequency monitor	E001_Output_frequency_monitor	INT

■ Details of the status allocation (Controller ← Destination device)

Destination device data	Global variable name	Data type
Sysmac Error Status	E001_Sysmac_Error_Status	BYTE
Error information at observation level	E001_Observation	BOOL
Error information at minor fault level	E001_Minor_Fault	BOOL

7. Connection Procedure

This section describes how to connect the Controller via EtherCAT.

This document explains the procedures for setting up the Controller and Inverter from the factory default setting. For the initialization, refer to *Section 8 Initialization Method*.

7.1. Work Flow

The following is the procedure for connecting to EtherCAT.

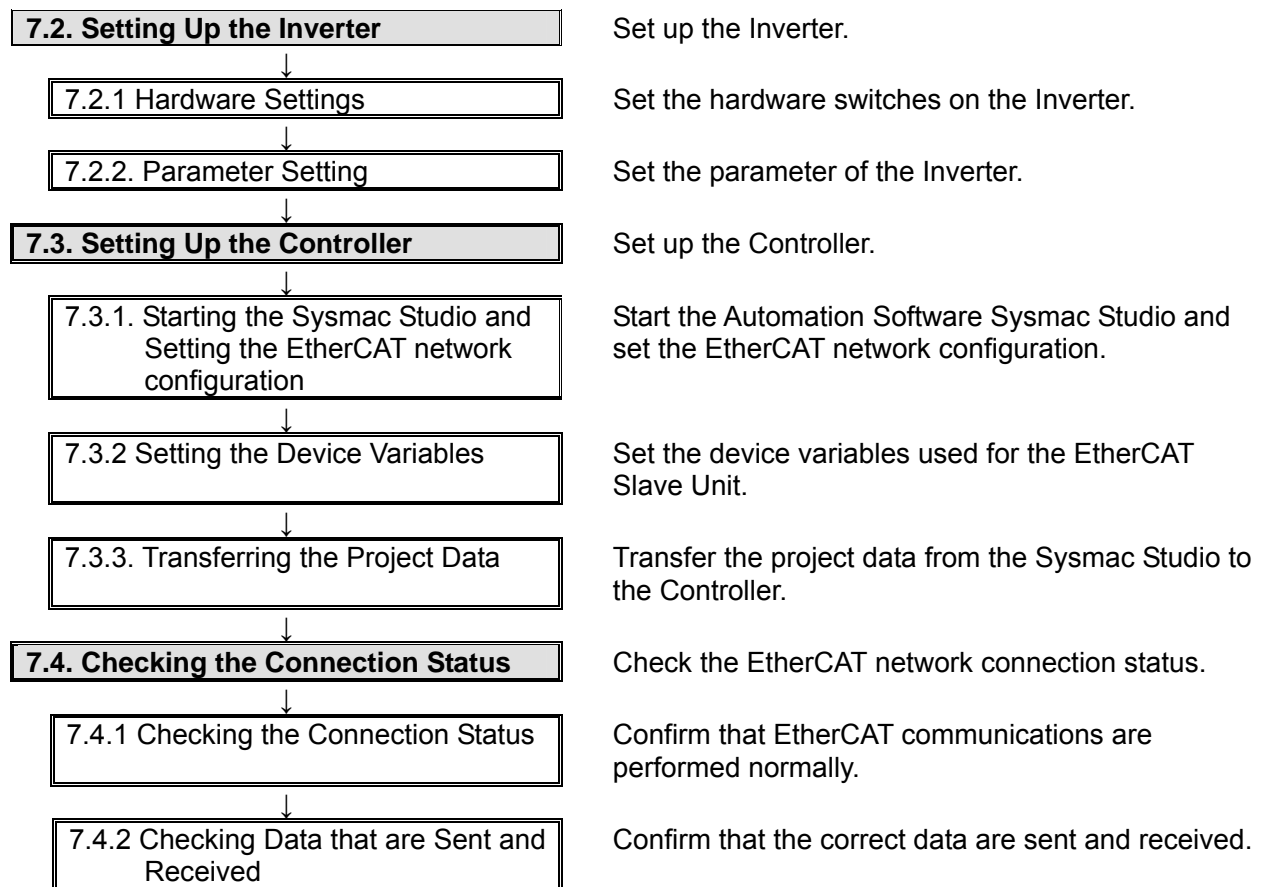

7.2. Setting Up the Inverter

Set up the Inverter.

7.2.1. Hardware Setting

Set the hardware switches on the Inverter.



Precautions for Correct Use

Make sure that the power supply is OFF when you perform the settings.

- 1 Mount the EtherCAT Communications Unit on the Inverter.

*For details on how to mount the EtherCAT Communications Unit, refer to *2-5 Mounting and Wiring for the EtherCAT Communication Unit* in the *3G3AX-RX-ECT (RX-V1) EtherCAT Communication Unit User's Manual* (Cat.No. I574)

Remove the front cover from the Inverter.

Remove the following parts from the RX-V1 Inverter.

- A. Digital operator
- B. Spacer cover
- C. Terminal cover
- D. Front cover

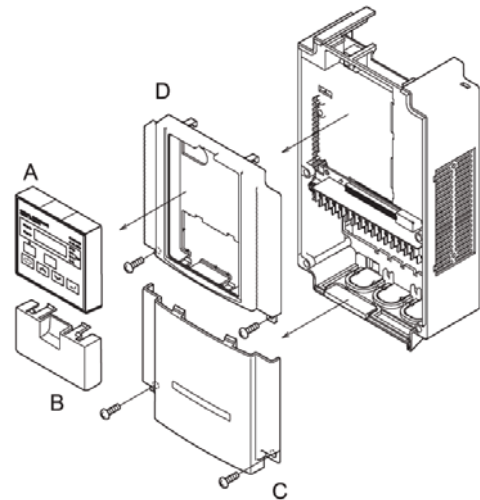

- 2 Remove the two break-outs from the front cover.

Confirm that there are no burrs left.

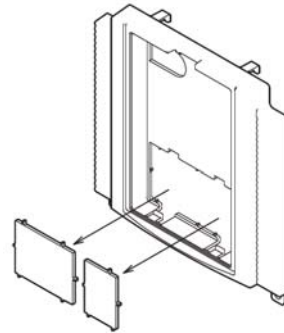

- 3 Mount the conversion board onto the Inverter.

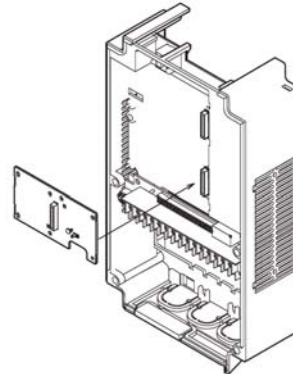

- 4 Mount the front cover as before and tighten the screws.

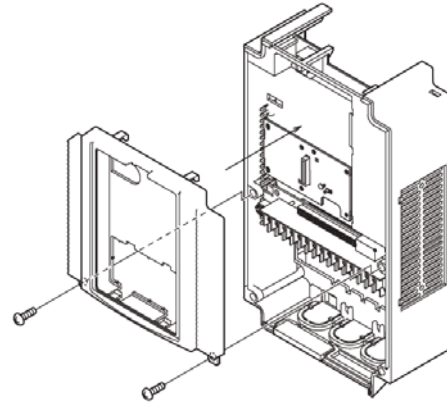

- 5 Connect the connector on the Inverter connection board of the EtherCAT Communication Unit to the conversion board mounted on the Inverter.

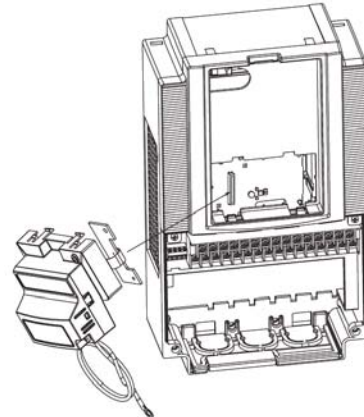

- 6 Mount the EtherCAT Communication Unit onto the Inverter.

Plug the two lock pins (A) of the EtherCAT Communication Unit into the Inverter. Then insert the bottom part of the EtherCAT Communication Unit and mount it by pushing down.

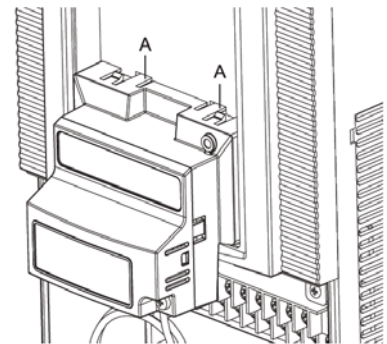

(a) Insert the two tabs on the top of the EtherCAT Communications Unit in the hole and push it up.

(b) While pushing it up, insert the bottom part of the EtherCAT Communications Unit.

(c) Securely mount the EtherCAT Communications Unit by sliding it down.

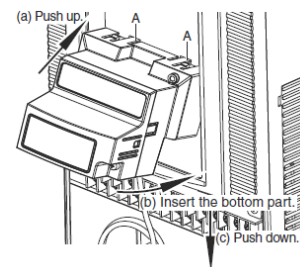

- 7 Connect the grounding cable of the EtherCAT Communication Unit to the grounding terminal of the Inverter.

Make sure that the grounding terminal is marked with a grounding symbol.

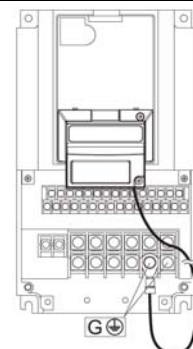

8 Mount the Digital Operator (C) and the terminal cover and secure the terminal cover by tightening the screws.

Mount the terminal cover below the EtherCAT Communication Unit to the Inverter (B). Tighten the two screws (A).

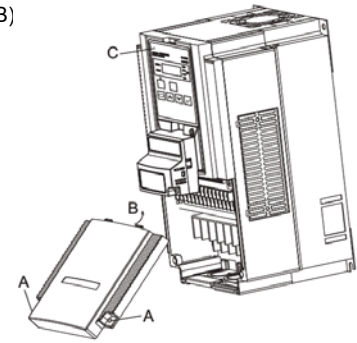

9 Refer to the right figure and check the hardware switches located on the front panel of the EtherCAT Communications Unit.

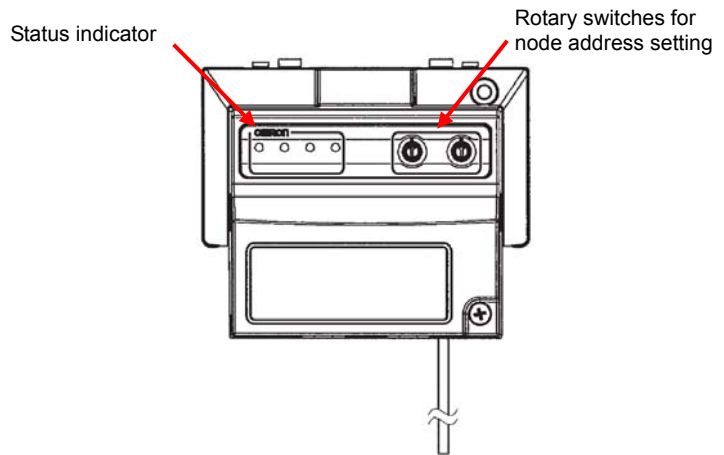

10 Set the node address setting switches to "01".

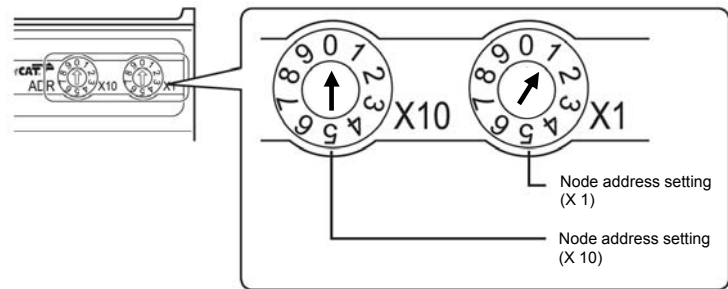

11 Connect the communication cable to the communication connector IN.

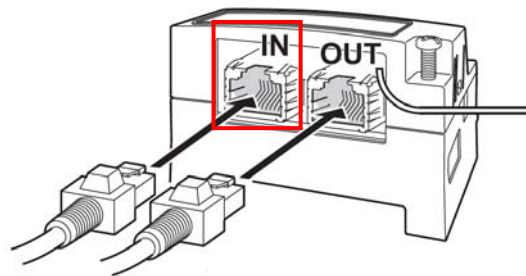

In this document, OUT side is not used.

7.2.2. Parameter Setting

Set the parameters of the Inverter.

- 1 Turn ON the power supply to the Inverter.

*Set the parameters by using the digital operator that is on the front of the Inverter.

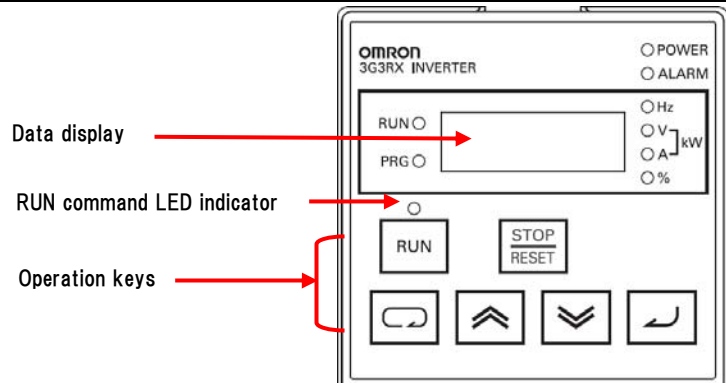

	Data display	Displays relevant data, such as frequency reference, output current, and set values.
	RUN key	Activates the Inverter. Available only when operation via the Digital Operator is selected. (Confirm that the RUN command LED indicator is lit.)
	STOP/RESET key	Decelerates and stops the Inverter. Functions as a reset key if an Inverter error occurs.
	Mode key	Switches between: the monitor mode (d000), the basic function mode (F000), and the extended function mode (A000, b000, C000, H000).
	Enter key	Enters the set value. (To change the set value, be sure to press the Enter key.)
	Increment key	Changes the mode. Also, increases the set value of each function.
	Decrement key	Changes the mode. Also, decreases the set value of each function.

- 2 Turn ON the power supply. The display shows the monitor value. Set the parameters by following the procedure on the right.

[A001] Frequency Reference
Selection 1: 05.
[A002] RUN Command
Selection 1: 05

*Set "05" (Option 2).

*The d001 (Output frequency monitor) data is displayed during power ON. (Default setting)

0.00

After turning ON the power supply, the panel displays as shown on the left.



Press the Mode Key  3 times.

A001

A001 parameter is displayed.



Press the Enter Key .

02

The initial data is displayed.



Press the Increment Key  three times.

05

Change the data to "05".



Press the Enter Key .

A001

The parameter is displayed again.



Press the Increment Key  once.

A002

A002 parameter is displayed.



Press the Enter Key .

02

The initial data is displayed.



Press the Increment Key  three times.

05

Change the data to "05".



Press the Enter Key .

A002

The parameter is displayed again.

3 Use the procedure on the right to set the parameter.

[C102] Reset selection: 03

*Set "03" (Trip reset only).

A002

The parameter is displayed



Press the Mode Key  twice.

C001

C001 parameter is displayed.



Press the Increment Key  to move to C102.

C 102

C102 parameter is displayed.



Press the Enter Key 

00

The initial data is displayed



Press the Increment Key  three times.

03

Change the data to "03"



Press the Enter Key 

C 102

The parameter is displayed again.

4 Cycle the power supply to the Inverter.

7.3. Setting Up the Controller

Set up the Controller.

7.3.1. Starting the Sysmac Studio and Setting the EtherCAT Network Configuration

Start the Automation Software Sysmac Studio and set the EtherCAT network configuration. Install the software and USB driver beforehand.

- 1 Start the Sysmac Studio.
Click the **New Project** Button.

*If a confirmation dialog for an access right is displayed at start, select to start.

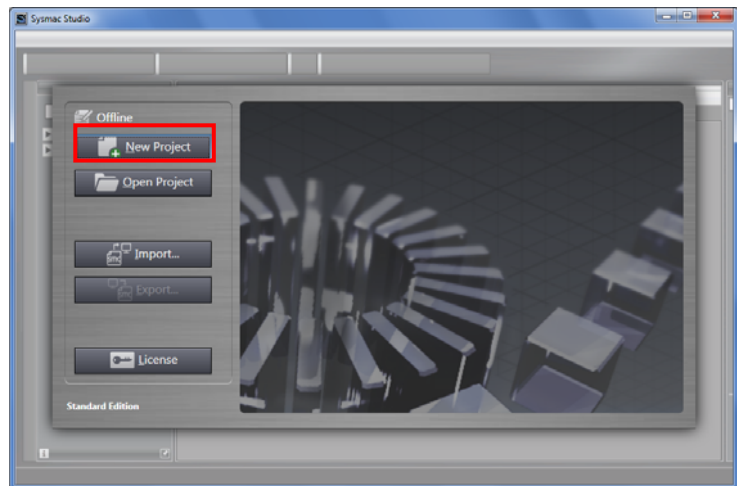

- 2 The Project Properties Dialog Box is displayed.

*In this document, New Project is set as the project name.

Select **1.01** from the Version pull-down menu.

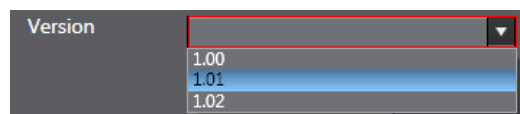
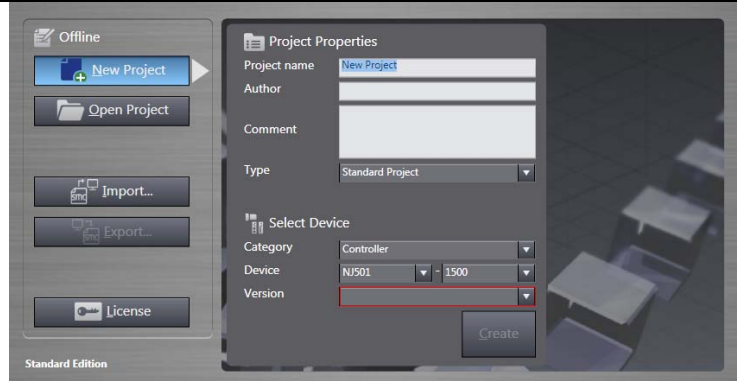

- 3 Click the **Create** Button.

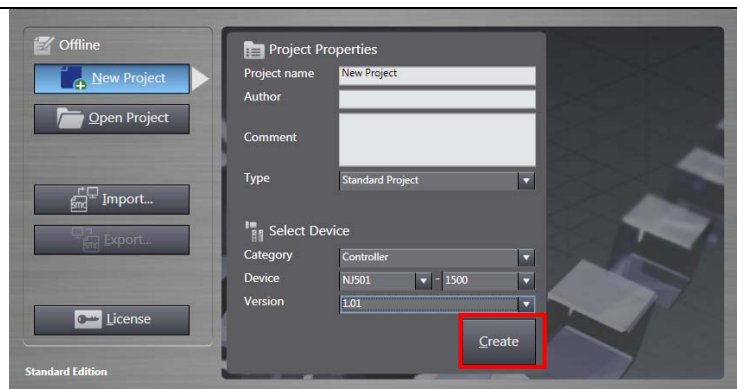

- 4 The New Project is displayed. The left pane is called Multiview Explorer, the right pane is called Toolbox and the middle pane is called Edit Pane.

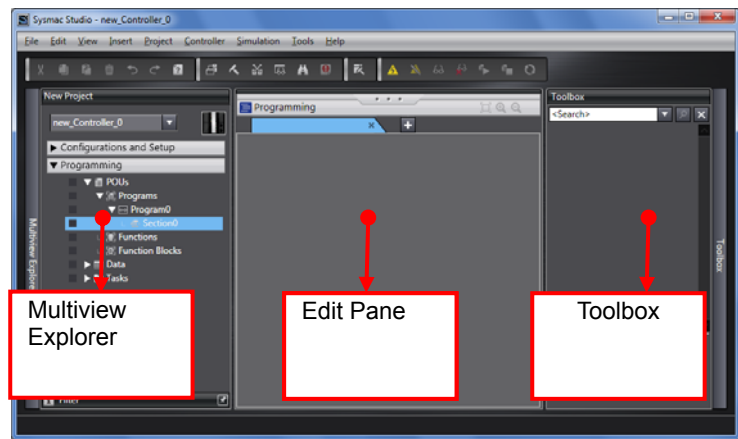

- 5 Select the **Communications Setup** from the Controller Menu.

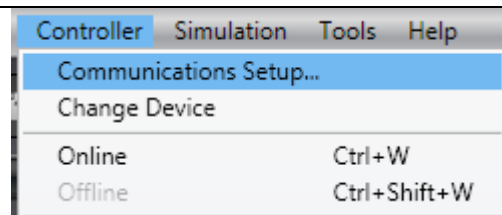

- 6 The Communications Setup Dialog Box is displayed. Select **Direct Connection via USB** Option from Connection Type.

Click the **OK** Button.

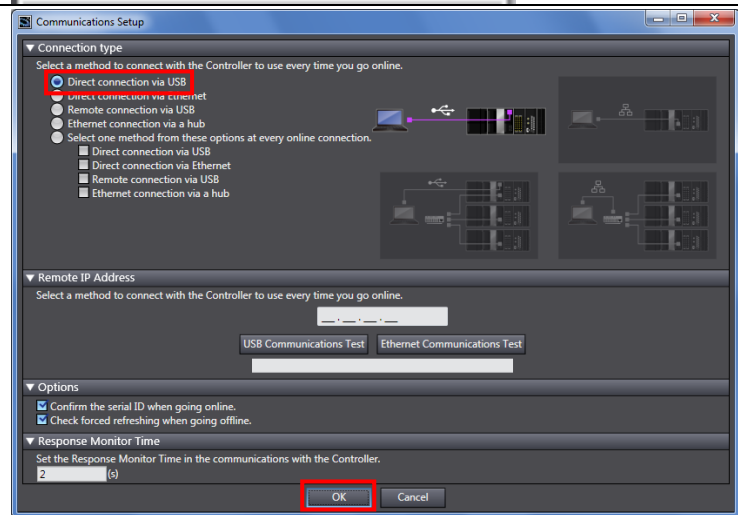

- 7 Select **Online** from the Controller Menu.



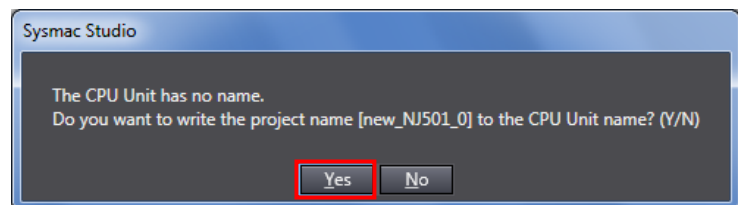
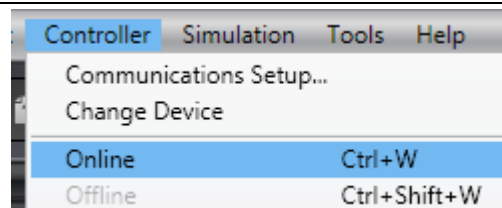

A confirmation dialog is displayed. Click the **Yes** Button.
 *A displayed dialog depends on the status of the Controller used. Select the **Yes** Button or other button to proceed with the processing.



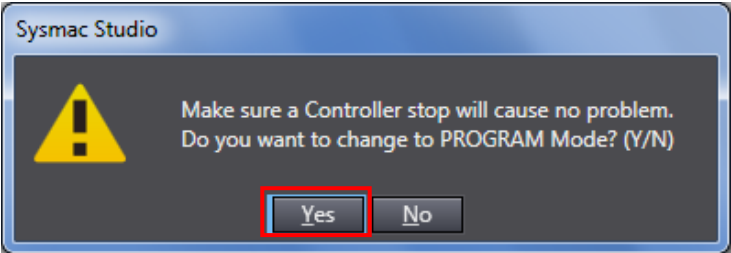
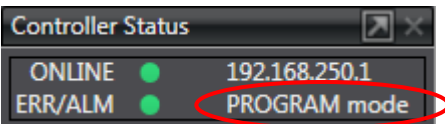
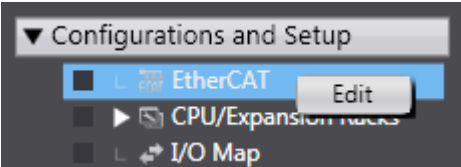

Additional Information

For details on the online connections to a Controller, refer to *Section 5 Going Online with a Controller* of the *Sysmac Studio Version 1.0 Operation Manual* (Cat. No. W504).

8	When an online connection is established, a yellow bar is displayed on the top of the Edit Pane.	
9	Select Mode - Program Mode from the Controller Menu.	
10	<p>A confirmation dialog is displayed. Click the Yes Button.</p> <p>Confirm that the controller status on the Toolbox is changed to the PROGRAM mode.</p>	 <p style="text-align: center;">↓</p> 
11	<p>Double-click EtherCAT under Configurations and Setup in the Multiview Explorer.</p> <p>Or, right-click EtherCAT under Configurations and Setup and select Edit.</p>	
12	The EtherCAT Tab Page is displayed in the Edit Pane.	

13 Right-click **Master** on the EtherCAT Tab Page, and select the **Compare and Merge with Actual Network Configuration**.

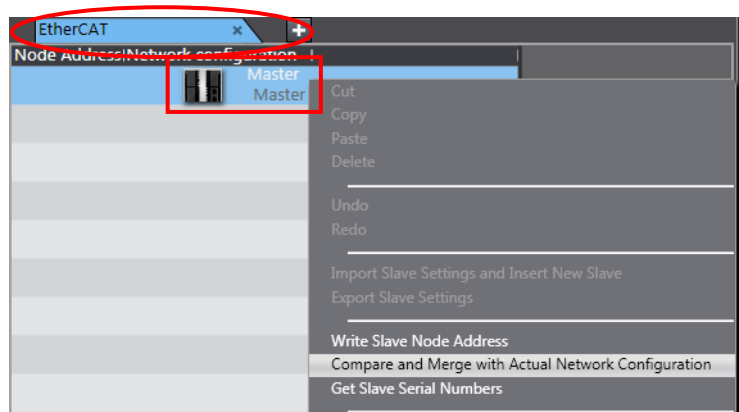

A screen is displayed stating "Get information is being executed".

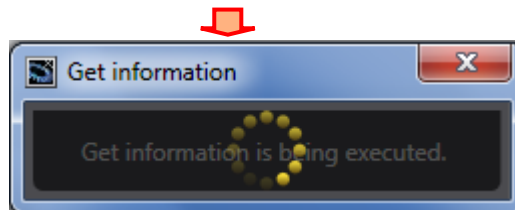

14 The Compare and Merge with Actual Network Configuration Pane is displayed. Node address 1 and 3G3AX-RX-ECT Rev:1.0 are added to the Actual network configuration after the comparison.

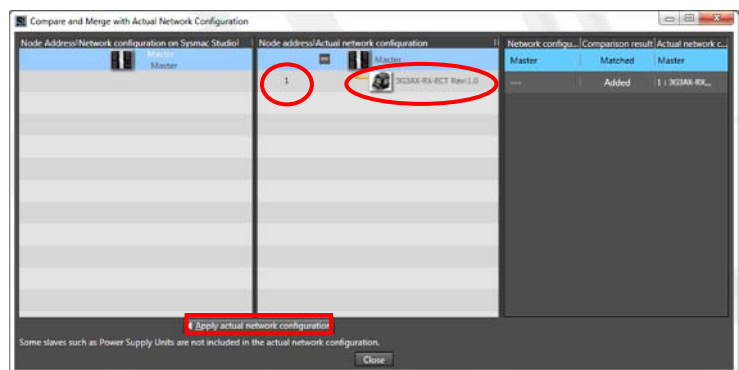

Click the **Apply actual network configuration** Button.

15 A confirmation dialog box is displayed. Click the **Apply** Button.

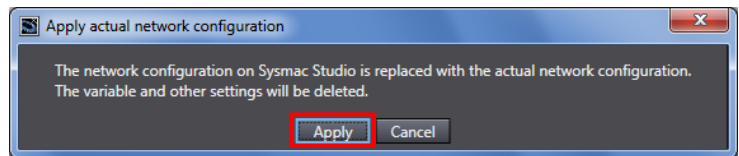

Confirm that node address 1 and E001 3G3AX-RX-ECT Rev:1.0 are added to the Network configuration on Sysmac Studio.

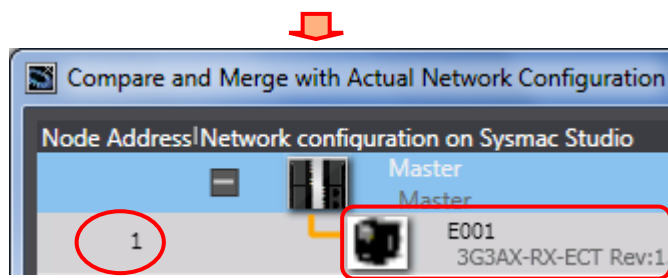

Click the **Close** Button.

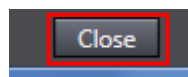

16 Node address 1 and E001 3G3AX-RX-ECT Rev:1.0 are added to the EtherCAT Tab Page in the Edit Pane.

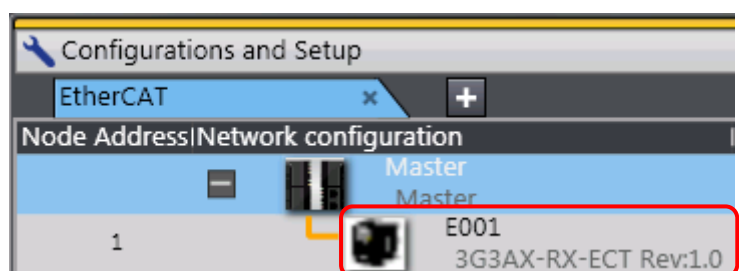

7.3.2. Setting the Device Variables

Set the device variables used for the EtherCAT Slave Unit.

- 1 Select **Offline** from the Controller Menu.

The yellow bar on the top of the Edit Pane disappears.

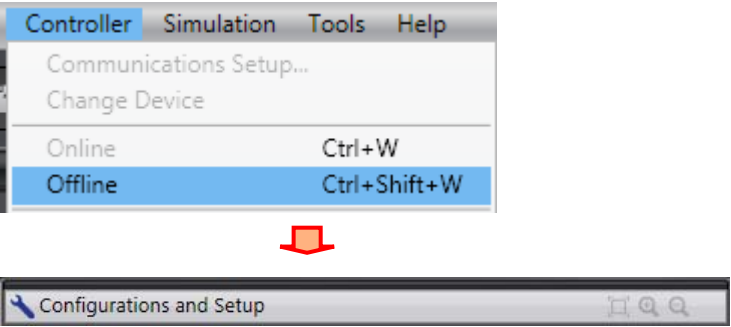

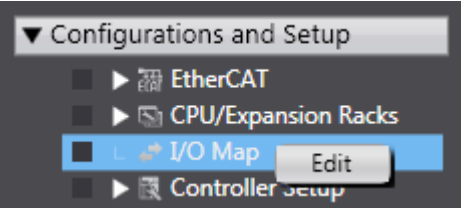
- 2 Double-click **I/O Map** under Configurations and Setup on the Multiview Explorer. Or right-click **I/O Map** under Configurations and Setup and select **Edit**.

- 3 The I/O Map Tab is displayed on the Edit Pane.

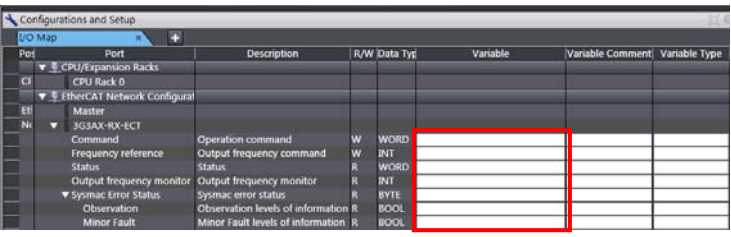
*In this document, create variable names automatically by following step 4. To enter variable names individually, click a column under Variable.

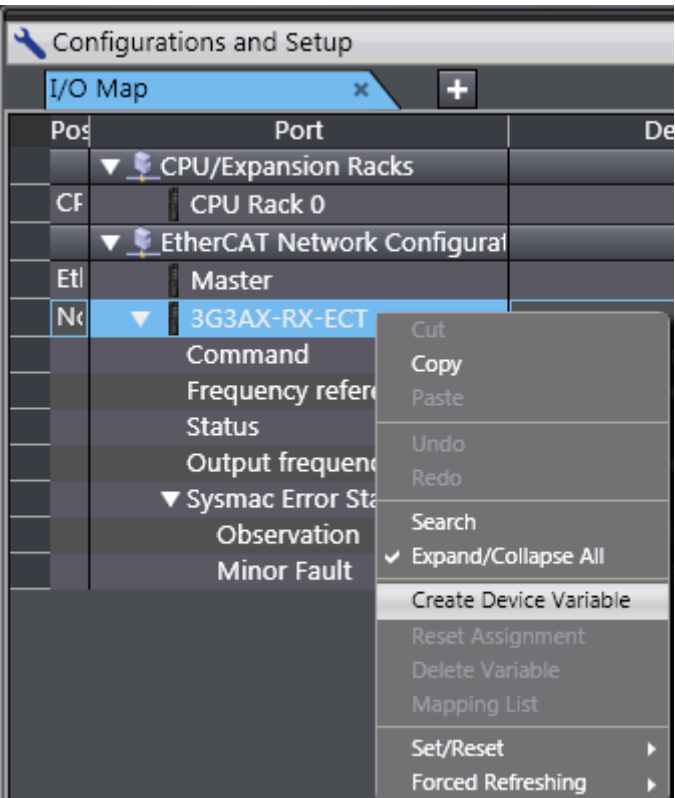

Pos	Port	Description	R/W	Data Typ	Variable	Variable Comment	Variable Type
	▼ CPU/Expansion Racks						
CF	CPU Rack 0						
	▼ EtherCAT Network Configurati						
Etl	Master						
Nc	▼ 3G3AX-RX-ECT						
	Command	Operation command	W	WORD			
	Frequency reference	Output frequency command	W	INT			
	Status	Status	R	WORD			
	Output frequency monitor	Output frequency monitor	R	INT			
	▼ Sysmac Error Status						
	Sysmac error status	Sysmac error status	R	BYTE			
	Observation	Observation levels of information	R	BOOL			
	Minor Fault	Minor fault levels of information	R	BOOL			
- 4 Right-click the row for Node1 and 3G3AX-RX—ECT. Then, select **Create Device Variable**.



7.3.3. Transferring Project Data

Transfer the project data from the Sysmac Studio to the Controller.

WARNING

Always confirm safety at the destination node before you transfer a user program, configuration data, setup data, device variables, or values in memory used for CJ-series Units from the Sysmac Studio.

The devices or machines may perform unexpected operation regardless of the operating mode of the CPU Unit.

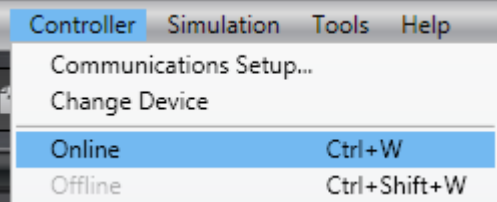
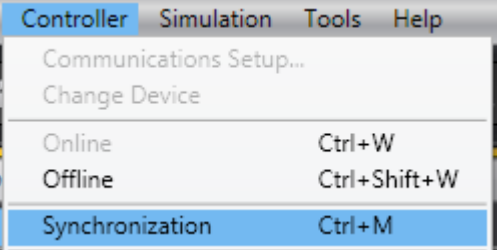
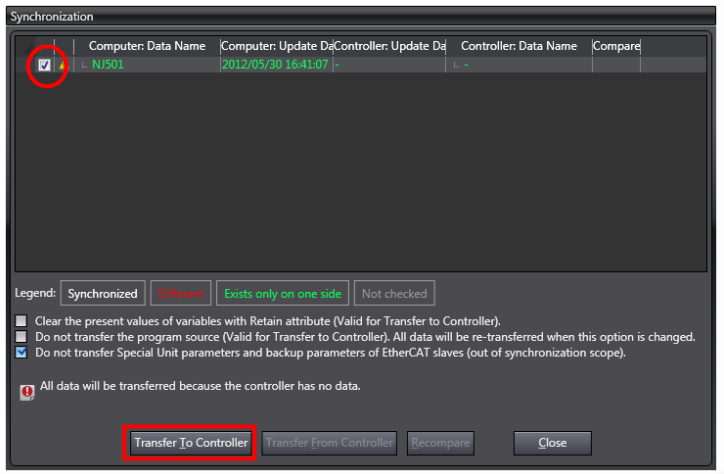
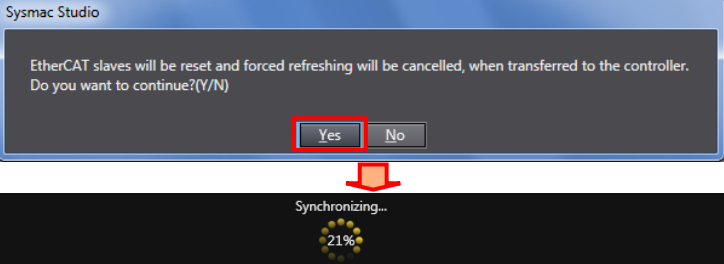

1	Select Online from the Controller Menu.	
2	Select Synchronization from the Controller Menu.	
3	<p>The Synchronization Dialog Box is displayed.</p> <p>Confirm that the data to transfer (NJ501 in the right figure) is selected. Then, click the Transfer to Controller Button.</p>	
4	<p>A confirmation dialog is displayed. Click the Yes Button.</p> <p>A screen stating "Synchronizing" is displayed.</p>	

- 5 Confirm that the synchronized data is displayed with the color specified by "Synchronized" and that a message is displayed stating "The synchronization process successfully finished".

If there is no problem, click the **Close** Button.

*If the synchronization fails, check the wiring and repeat the procedure described in this section.

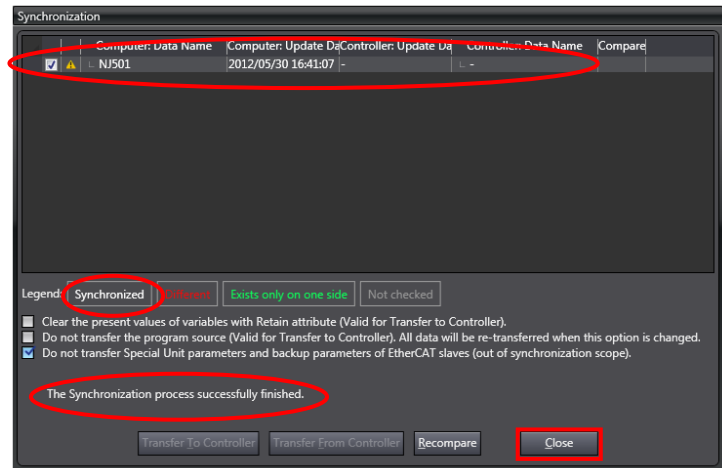

7.4. Connection Status Check

Check the EtherCAT network connection status.

7.4.1. Checking the Connection Status

Confirm that EtherCAT communications are performed normally.

- 1 Check the LED indicators on the Controller and confirm that the EtherCAT communications are performed normally.

LED indicators in normal status:

[NET RUN]: Lit green

[NET ERR]: Not lit

[LINK/ACT]: Flashing yellow

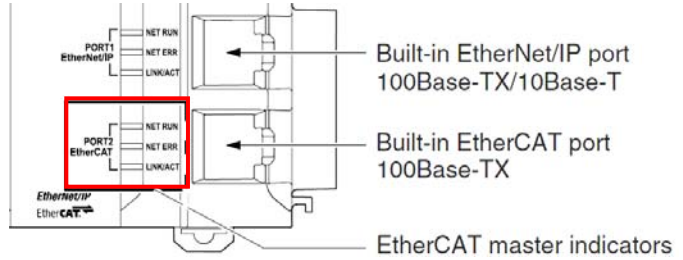

Label	Name	Color	Status	Meaning
EtherCAT NET RUN	RUN	Green	Lit	EtherCAT communications are in progress. • I/O data is being input and output.
			Flashing	EtherCAT communications are established. Communications is in one of the following states: • Only message communications is functioning. • Only message communications and I/O data input operations are functioning.
			Not lit	EtherCAT communications are stopped. • Power is OFF or the Unit is being reset. • There is a MAC address error, communications controller error, or other error.
EtherCAT NET ERR	ERROR	Red	Lit	There is an unrecoverable error, such as a hardware error or an exception.
			Flashing	There is a recoverable error.
			Not lit	There is no error.
EtherCAT LINK/ACT	Link/Activity	Yellow	Lit	The link is established.
			Flashing	A link is established and data is being sent and received. The indicator flashes whenever data is sent or received.
			Not lit	The link is not established.

2 Check the LED indicators on the Inverter.

LED indicators in normal status:

[L/A IN]: Flickering

[RUN]: Lit green

[ERR]: Not lit

The LED indicators flash at the same timing as those of the Controller.



[PWR] indicator

Indicates the unit power supply state.

Color	State	Contents
Green	OFF	Unit power OFF state
	ON	The unit power (24 VDC) is supplied to the Slave Unit.

[L/A IN] indicator

Indicates the communication state (input side).

Color	State	Contents
Green	OFF	Link not established in physical layer
	Flickering	In operation after establishing link
	ON	Link established in physical layer

[RUN] indicator

It indicates the operation state.

Color	State	Contents
Green	OFF	Init state
	Blinking	Pre-Operational state
	Single flash	Safe-Operational state
	ON	Operational state

[ERR] indicator

It indicates the information of an error.

Color	State	Contents
Red	OFF	No error
	Blinking	Communications setting error
	Single flash	Synchronization error or communications data error
	Double flash	Application WDT timeout
	Flickering	Boot error
	ON	PDI WDT timeout

7.4.2. Checking Data That Are Sent and Received

Confirm that the correct data are sent and received.

⚠ WARNING

The Inverter will run if you proceed to this section. Confirm safety before operation. If you cannot confirm safety, do not proceed to this section after completing until Section 7.4.1. If you proceed to this section, make sure to complete all the steps and place the Inverter in the safe state.



⚠ Caution

Sufficiently confirm safety before you change the values of variables on a Watch Tab Page when the Sysmac Studio is online with the CPU Unit. Incorrect operation may cause the devices that are connected to Output Units to operate regardless of the operating mode of the Controller.



- 1 Select **Mode - RUN Mode** from the Controller Menu.

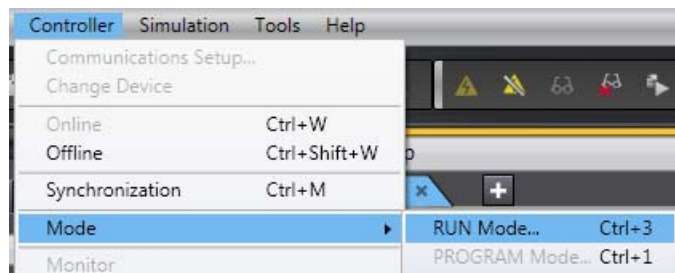

A confirmation dialog box is displayed. Click the **Yes** Button.

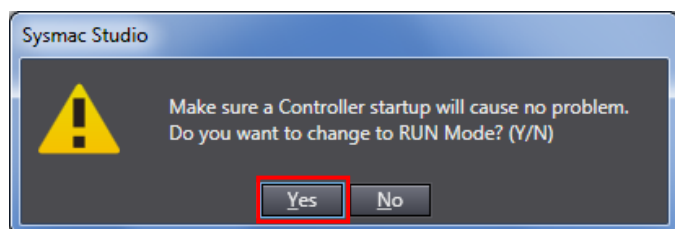

- 2 RUN mode is displayed on the Controller Status Pane.

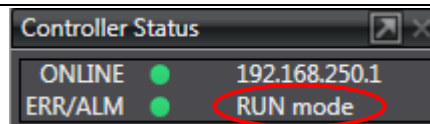

3 Select **Watch Tab Page** from the View Menu.

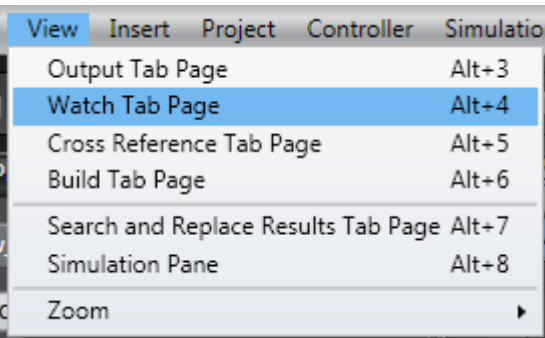

4 The Watch Window (Controller) Tab Page is displayed in the lower section of the Edit Pane.

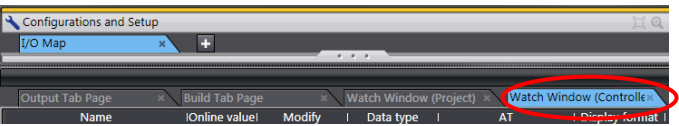

5 Click the column that says Input Name... under Name at the bottom of the Watch Window (Controller).

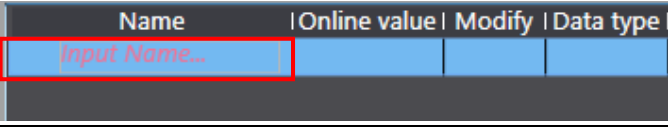

6 Now, characters can be entered. Enter the device variable name. Enter *E001_Command* (operation command to Inverter). Type the first character E. A list of device variables starting with E is displayed. Scroll the list and select *E001_Command*. Double-click *E001_Command*. *E001_Command* is entered in the Name Column.

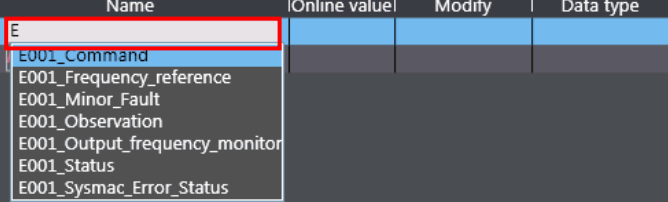
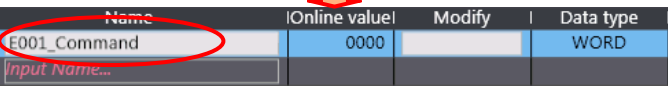
7 In the same way, enter the following variables.

Output frequency:
E001_Frequency_reference
Status: E001_Status
Output frequency monitor:
E001_Output_frequency_monitor

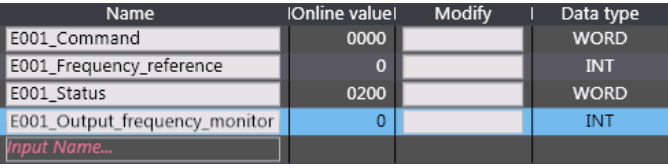

8 Check that the online value of *E001_Status* is 0200 (bit 9: Remote is 1).

*Status bit 9: Remote
0:Local (Operations from EtherCAT are disabled)
1:Remote (Operations from EtherCAT are enabled)

Status

15	-	-	12	-	-	9	-	7	-	-	-	3	-	1	0
----	---	---	----	---	---	---	---	---	---	---	---	---	---	---	---

Bit	Name	Meaning
0	Forward operation in progress	0:Stopped/during reverse operation 1:During forward operation
1	Reverse operation in progress	0:Stopped/during forward operation 1:During reverse operation
3	Fault	0:No error or trip occurred for the unit or Inverter 1:Error or trip occurred for the unit or Inverter
7	Warning	0:No warning occurred for the unit or Inverter 1:Warning occurred for the unit or Inverter
9	Remote	0:Local (Operations from EtherCAT are disabled) 1:Remote (Operations from EtherCAT are enabled)
12	Frequency matching	0:During acceleration/deceleration 1:Frequency matching
15	Connection error between the Optional Unit and Inverter	0:Normal 1:Error (Cannot update data for the Inverter. To restore, turn the power OFF and then ON again.)
-	(Reserved)	The reserved area.

9 Enter "100" in (E001_Frequency_reference) Output frequency.

Name	Online value	Modify	Data type
E001_Command	0000		WORD
E001_Frequency_reference	0	100	INT
E001_Status	0200		WORD
E001_Output_frequency_monitor	0		INT
Input Name...			

10 Check that the RUN LED indicator on the Inverter is unlit and the 7-segment display (Output frequency) shows "0.00"

11 Enter "1" in the E001_Command (Operation command to Inverter).

*Command bit 0: Forward/stop
0:Stop
1:Forward command

Name	Online value	Modify	Data type
E001_Command	0000	1	WORD
E001_Frequency_reference	100	100	INT
E001_Status	0200		WORD
E001_Output_frequency_monitor	0		INT
Input Name...			

Command

-	-	-	-	-	-	-	-	7	-	-	-	-	-	-	1	0
Bit	Name	Meaning														
0	Forward/stop	0:Stop 1:Forward command														
1	Reverse/stop	0:Stop 1:Reverse command														
7	Fault reset	Resets an error or trip for the unit or Inverter.														
-	(Reserved)	The reserved area. Set 0.														

12 Check that E001_Status is "1201" and E001_Output_frequency_monitor (Output frequency monitor) is "100".

*Status bit 0: Forward Operation in progress
0:Stopped/during reverse operation
1:During forward operation
*Status bit 12: Frequency matching
0:During acceleration/deceleration
1:Frequency matched

Name	Online value	Modify	Data type
E001_Command	0001	1	WORD
E001_Frequency_reference	100	100	INT
E001_Status	1201		WORD
E001_Output_frequency_monitor	100		INT
Input Name...			

Status

15	-	-	-	12	-	-	-	9	-	-	-	7	-	-	-	3	-	-	1	0
Bit	Name	Meaning																		
0	Forward operation in progress	0:Stopped/during reverse operation 1:During forward operation																		
1	Reverse operation in progress	0:Stopped/during forward operation 1:During reverse operation																		
3	Fault	0:No error or trip occurred for the unit or Inverter 1:Error or trip occurred for the unit or Inverter																		
7	Warning	0:No warning occurred for the unit or Inverter 1:Warning occurred for the unit or Inverter																		
9	Remote	0:Local (Operations from EtherCAT are disabled) 1:Remote (Operations from EtherCAT are enabled)																		
12	Frequency matching	0:During acceleration/deceleration 1:Frequency matching																		
15	Connection error between the Optional Unit and Inverter	0:Normal 1:Error (Cannot update data for the Inverter. To restore, turn the power OFF and then ON again.)																		
-	(Reserved)	The reserved area.																		

13 Check that the RUN LED indicator on the Inverter is lit and the 7-segment LED indicator (Output frequency) shows "1.00".

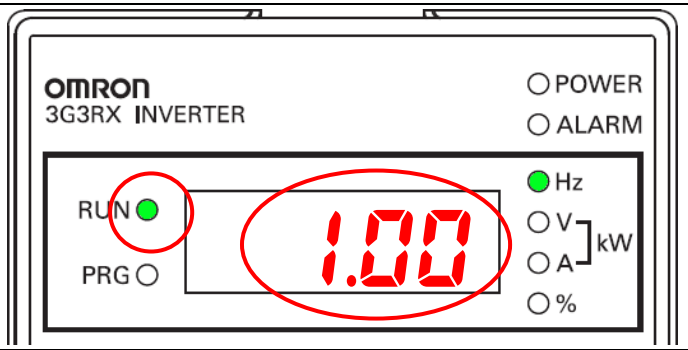

14 Enter "0" in *E001_Frequency_reference* (Output frequency).
Enter "0" in *E001_Command* (Operation command to Inverter).

Name	Online value	Modify	Data type
E001_Command	0000	0	WORD
E001_Frequency_reference	0	0	INT
E001_Status	0200		WORD
E001_Output_frequency_monitor	0		INT
Input Name...			

15 Check that the 7-segment LED display (Output frequency) on the Inverter returns to "0.00" and RUN LED indicator is unlit.

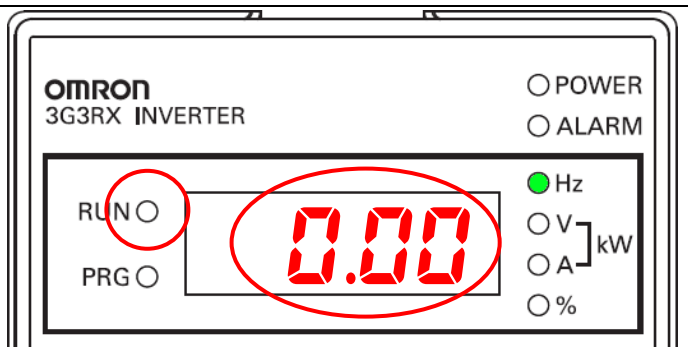

8. Initialization Method

This document explains the setting procedure from the factory default setting.

If the device settings have been changed from the factory default setting, some settings may not be applicable as described in this procedure.

8.1. Controller

To initialize the settings of the Controller, select **Clear All Memory** from the Controller Menu of the Sysmac Studio.

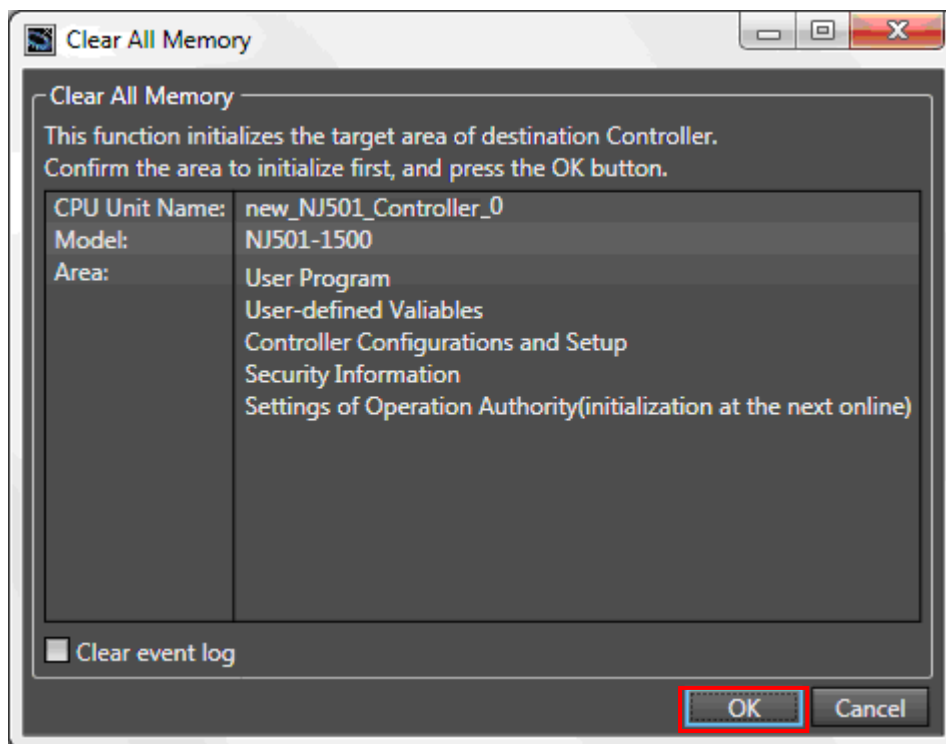

8.2. Inverter

For information on how to initialize the Inverter, refer to *5-1-2 Parameter Initialization* in the *High-function General-purpose Inverter 3G3RX-V1 User's Manual* (Cat. No. I578).

9. Revision History

Revision code	Date of revision	Revision reason and revision page
01	Mar. 26, 2013	First edition

OMRON Corporation Industrial Automation Company

Tokyo, JAPAN

Contact: www.ia.omron.com

Regional Headquarters

OMRON EUROPE B.V.

Wegalaan 67-69-2132 JD Hoofddorp
The Netherlands

Tel: (31)2356-81-300/Fax: (31)2356-81-388

OMRON ELECTRONICS LLC

One Commerce Drive Schaumburg,
IL 60173-5302 U.S.A.

Tel: (1) 847-843-7900/Fax: (1) 847-843-7787

OMRON ASIA PACIFIC PTE. LTD.

No. 438A Alexandra Road # 05-05/08 (Lobby 2),
Alexandra Technopark,
Singapore 119967

Tel: (65) 6835-3011/Fax: (65) 6835-2711

OMRON (CHINA) CO., LTD.

Room 2211, Bank of China Tower,
200 Yin Cheng Zhong Road,
PuDong New Area, Shanghai, 200120, China

Tel: (86) 21-5037-2222/Fax: (86) 21-5037-2200

Authorized Distributor:

© OMRON Corporation 2013 All Rights Reserved.
In the interest of product improvement,
specifications are subject to change without notice.

Cat. No. P527-E1-01

0911(-)