



CJ-series

DeviceNet™ Connection Guide

OMRON Corporation

3G3RX-V1 Series Inverter

About Intellectual Property Rights and Trademarks

Microsoft product screen shots reprinted with permission from Microsoft Corporation.

Windows is a registered trademark of Microsoft Corporation in the USA and other countries.

ODVA and DeviceNet™ are trademarks of ODVA.

Company names and product names in this document are the trademarks or registered trademarks of their respective companies.

Table Of Contents

1. Related Manuals	1
2. Terms and Definitions	1
3. Remarks	2
4. Overview	4
5. Applicable Products and Support Software	4
5.1. Applicable Products	4
5.2. Device Configuration	5
6. Connection Procedure	7
6.1. Unit Setting Example	7
6.2. Work Flow	9
6.3. Setting Up the Inverter	10
6.4. Setting Up the DeviceNet	17
6.5. Connection Status Check	33
7. Initialization Method	40
7.1. PLC	40
7.2. Inverter	41
8. Revision History	42

1. Related Manuals

The table below lists the manuals that relate to this document.

To ensure system safety, make sure to always read and heed the information provided in all Safety Precautions, Precautions for Safe Use, and Precaution for Correct Use of manuals for each device which is used in the system.

Cat.No.	Model	Manual Name
W472	CJ2H-CPU6[] CJ2M-CPU[[]]	CJ-series CJ2 CPU Unit Hardware User's Manual
W473	CJ2H-CPU6[] CJ2M-CPU[[]]	CJ-series CJ2 CPU Unit Software User's Manual
W267	-	DeviceNet™ Operation Manual
W380	CJ1W-DRM21	CJ-series DeviceNet™ Unit Operation Manual
W446	-	SYSMAC CX-Programmer Operation Manual
W464	-	SYSMAC CX-Integrator Operation Manual
I578	3G3RX-[[]][[]][[]]-V1	RX Series Type V1 High-function General-purpose Inverter User's Manual
I581	3G3AX-RX-DRT-E	MX2/RX Series DeviceNet Communications Unit User's Manual



2. Terms and Definitions

Term	Explanation and Definition
Master/Slave	<p>A master is a unit that controls the DeviceNet communications.</p> <p>A master sends output data to multiple slaves and receives input data from the slaves.</p> <p>Slaves receive output data that are sent from the master, and send input data to the master.</p> <p>At least one master is required for DeviceNet communications.</p>
EDS file	<p>An EDS file is a file that contains the I/O points of DeviceNet slave units and the parameters that can be set via DeviceNet.</p>
Node address (MAC ID)	<p>A node address is an address to identify a unit connected to a DeviceNet network.</p> <p>With DeviceNet, a MAC (Media Access Control) ID is used as a node address. Thus, a node address is a MAC ID.</p>
Scan list	<p>A scan list is used to register slaves with which a master communicates in DeviceNet remote I/O communications. A master communicates with the slaves based on the scan list settings.</p>

3. Remarks

- (1) Understand the specifications of devices which are used in the system. Allow some margin for ratings and performance. Provide safety measures, such as installing safety circuit in order to ensure safety and minimize risks of abnormal occurrence.
- (2) To ensure system safety, always read and heed the information provided in all Safety Precautions, Precautions for Safe Use, and Precaution for Correct Use of manuals for each device used in the system.
- (3) The user is encouraged to confirm the standards and regulations that the system must conform to.
- (4) It is prohibited to copy, to reproduce, and to distribute a part of or whole part of this document without the permission of OMRON Corporation.
- (5) The information contained in this document is current as of January 2013. It is subject to change without notice for improvement.

The following notation is used in this document.

 WARNING	Indicates a potentially hazardous situation which, if not avoided, will result in minor or moderate injury, or may result in serious injury or death. Additionally there may be significant property damage.
 Caution	Indicates a potentially hazardous situation which, if not avoided, may result in minor or moderate injury or in property damage.



Precautions for Safe Use

Precautions on what to do and what not to do to ensure safe usage of the product.



Application precautions

Precautions on what to do and what not to do to ensure proper operation and performance.



Additional Information

Additional information to read as required.

This information is provided to increase understanding or make operation easier

Symbols



The circle and slash symbol indicates operations that you must not do. The specific operation is shown in the circle and explained in text. This example indicates prohibiting disassembly.



The triangle symbol indicates precautions (including warnings). The specific operation is shown in the triangle and explained in text. This example indicates a precaution for electric shock.



The triangle symbol indicates precautions (including warnings). The specific operation is shown in the triangle and explained in text. This example indicates a general precaution.



The filled circle symbol indicates operations that you must do. The specific operation is shown in the circle and explained in text. This example shows a general precaution for something that you must do.

4. Overview

This document describes the procedure for connecting the Inverter (3G3RX-V1 series) of OMRON Corporation (hereinafter referred to as OMRON) to the DeviceNet Unit and provides the procedure for checking their connection.

Refer to *Section 6 Connection Procedure* to understand the setting method and key points to connect the devices via DeviceNet.

5. Applicable Products and Support Software

5.1. Applicable Products

The applicable devices are as follows:

Manufacturer	Name	Model	Version
OMRON	DeviceNet Unit (Master)	CJ1W-DRM21	Versions listed in Section 5.2 or higher versions
OMRON	CJ1-series CPU Unit CJ2-series CPU Unit	CJ1[-]CPU[] CJ2[-]CPU[]	
OMRON	Inverter	3G3RX -[]-[]-[]-[]-V1	
OMRON	DeviceNet Communications Unit	3G3AX-RX-DRT-E	



Precautions for Correct Use

As applicable devices above, the devices with the models and versions listed in Section 5.2. are actually used in this document to describe the procedure for connecting devices and checking the connection.

You cannot use devices with versions lower than the versions listed in Section 5.2.

To use the above devices with versions not listed in Section 5.2 or versions higher than those listed in Section 5.2, check the differences in the specifications by referring to the manuals before operating the devices.



Additional Information

This document describes the procedure to establish the network connection. Except for the connection procedure, it does not provide information on operation, installation or wiring method. It also does not describe the functionality or operation of the devices. Refer to the manuals or contact your OMRON representative.

5.2. Device Configuration

The hardware components to reproduce the connection procedure of this document are as follows:

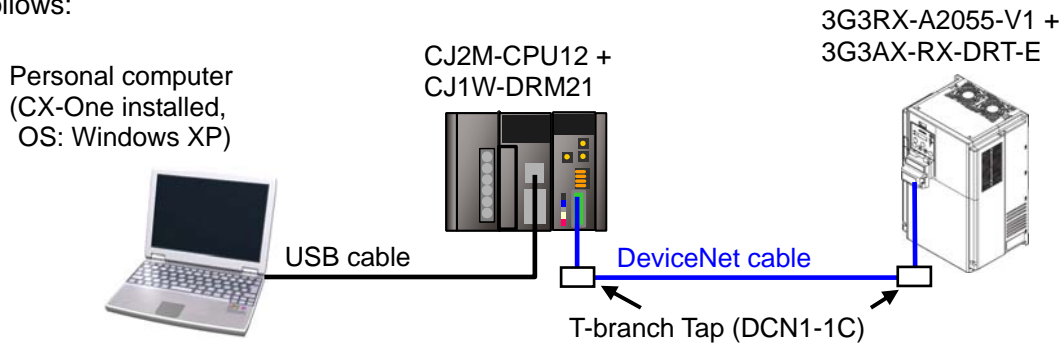

Manufacturer	Name	Model	Version
OMRON	DeviceNet Unit (Master)	CJ1W-DRM21	Ver.1.1
OMRON	CJ2 CPU Unit	CJ2M-CPU12	Ver.2.0
OMRON	Power Supply Unit	CJ1W-PA202	
OMRON	DeviceNet cable	DCA1-5C10	
OMRON	T-branch Tap	DCN1-1C	
OMRON	CX-One	CXONE-AL[]C-V4 /AL[]D-V4	Ver.4.[]
OMRON	CX-Programmer	(Included in CX-One)	Ver.9.41
OMRON	CX-Integrator	(Included in CX-One)	Ver.2.55
-	USB cable	-	
-	Personal computer (OS: Windows XP)	-	
OMRON	Inverter	3G3RX -A2055-V1	
OMRON	DeviceNet Communications Unit	3G3AX-RX-DRT-E	



Precautions for Correct Use

Update the CX-Programmer and CX-Integrator to the version specified in this section or higher version using the auto update function. If a version not specified in this section is used, the procedures described in Section 6 and subsequent sections may not be applicable. In that case, use the equivalent procedures described in the SYSMAC CX-Programmer Operation Manual (Cat.No. W446) and SYSMAC CX-Integrator Operation Manual (Cat. No. W464).



Additional Information

For information on the DeviceNet cable and network wiring, refer to *Chapter 2 Network Configuration and Wiring* of the *DeviceNet Operation Manual* (Cat. No. W267). Connect a terminating resistance to each end of the trunk line of the DeviceNet.



Additional Information

The system configuration in this document uses USB for the connection between the personal computer and CJ2.

For information on how to install the USB driver, refer to *A-5 Installing the USB Driver* in the *CJ2 CPU Unit Hardware User's Manual* (Cat. No. W472).

6. Connection Procedure

6.1. Unit Setting Example

This section explains the procedure for connecting the DeviceNet Unit.

This document explains the procedures for setting up the DeviceNet Unit and Inverter from the factory default setting. For information on how to initialize each device, refer to *Section 7 Initialization Method*.

6.1.1. Settings

The settings for the DeviceNet Unit and Inverter are shown below.

	DeviceNet Unit	Inverter
Unit number	0	-
Node address (MAC ID)	63	0
Baud rate (bps)	500kbps	(Automatically follows the Master Unit)
Remote I/O	-	1 (Extended Speed I/O)

6.1.2. I/O Memory Area Allocation

The memory area of the PLC is allocated to the Inverter as shown below.

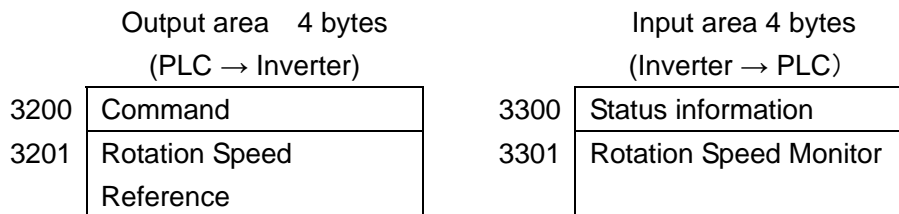

■ Output format

Word	Bit allocation															
	15	14	13	12	11	10	9	8	7	6	5	4	3	2	1	0
3200	-	-	-	-	-	-	-	-	-	REF	CTR	-	-	RS	RV	FW
3201	Rotation Speed Reference															

■Details on output area

Name		Meaning
FW	Forward/stop	0: Stop, 1: Forward
RV	Reverse/Stop	0: Stop, 1: Reverse
RS	Fault reset	0:-, 1: Fault reset
CTR	Net Ctrl.	0: Follow the setting of parameter A002. 1: Follow the reference from network control.
REF	Net Ref.	0: Follow the setting of parameter A001. 1: Follow the reference from network control.
Rotation Speed Reference		If parameter P049 (Number of Poles for Rotation Speed Setting) is set appropriately, the rotational speed unit is [min -1]. If parameter P049 (Number of Poles for Rotation Speed Setting) is set to 0, the frequency unit is [0.01 Hz].

■Input format

Word	Bit allocation															
	15	14	13	12	11	10	9	8	7	6	5	4	3	2	1	0
3300	Drive status								FA1	RFN	CFN	IRDY	RVR	FWR	WR	AL
3301	Rotation Speed Monitor															

■Details on input area

Name		Meaning			
AL	Alarm output	0: Normal, 1: Fault/Trip			
WR	Warning	0: Normal, 1: Warning			
FWR	During forward operation	0: During reverse run/Stopping, 1: During forward run			
RVR	During reverse operation	0: During forward run/Stopping, 1: During reverse run			
IRDY	Operation ready	0: Not ready, 1: Ready			
CFN	Ctrl. From Net	0: Follow the setting of parameter A002. 1: DeviceNet reference			
RFN	Ref. From Net	0: Follow the setting of parameter A001. 1: DeviceNet reference			
FA1	Constant speed reached	0: Accelerating or decelerating/Stopping, 1: Frequency agree			
Drive Status	Bit	[15] to [11]	[10]	[9]	[8]
	1: Startup	0	0	0	1
	2: Not ready	0	0	1	0
	3: Ready	0	0	1	1
	4: Operation in progress	0	1	0	0
	5: Stopping	0	1	0	1
	6: Fault/Trip stop	0	1	1	0
7: Fault/Trip	0	1	1	1	
Rotation Speed Monitor		If parameter P049 (Number of Poles for Rotation Speed Setting) is set appropriately, the rotational speed unit is [min -1]. If parameter P049 (Number of Poles for Rotation Speed Setting) is set to 0, the frequency is monitored in units of [0.01 Hz].			

6.2. Work Flow

Take the following steps to connect the DeviceNet Unit.

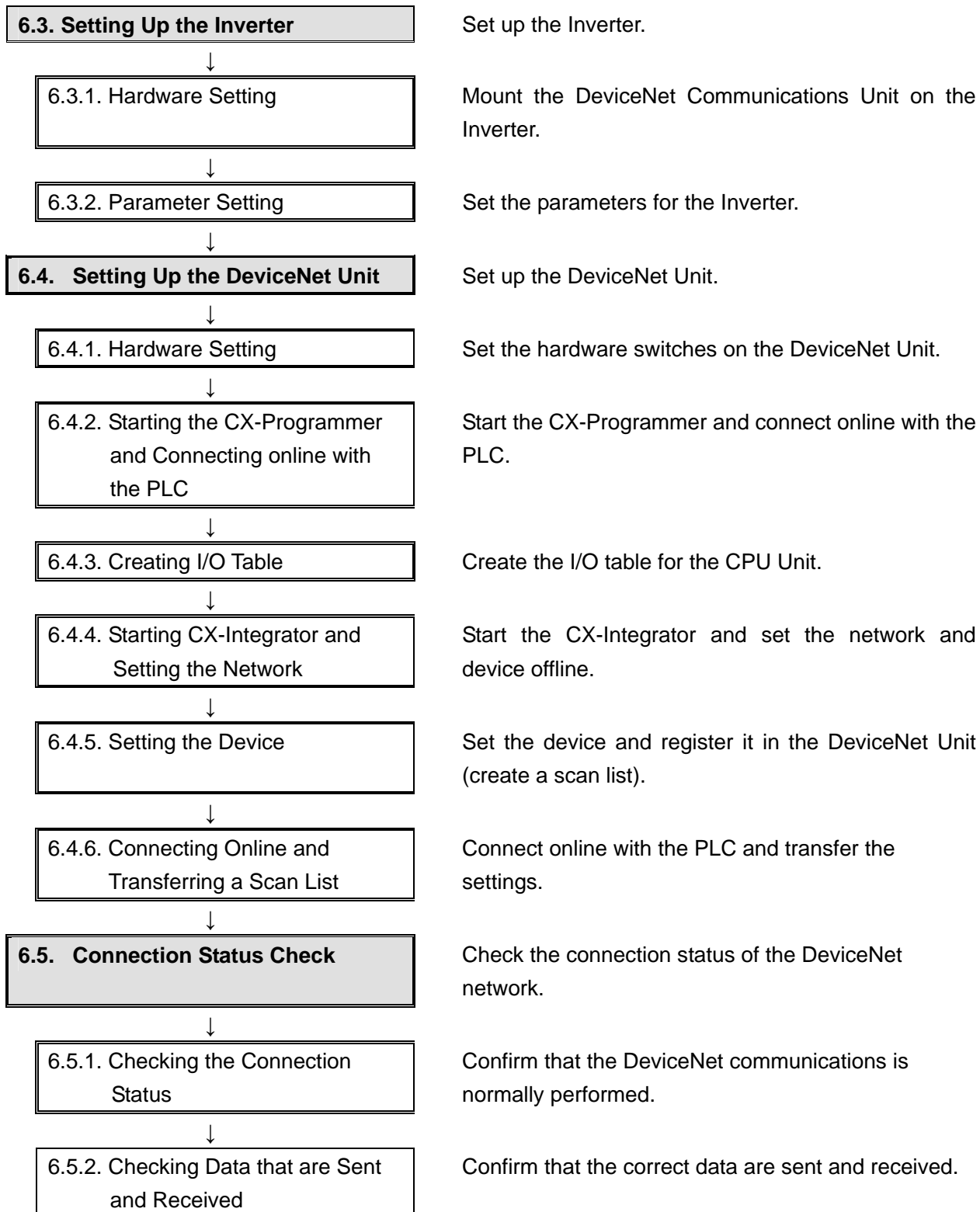

6.3. Setting Up the Inverter

Set up the Inverter.

6.3.1. Hardware Setting

Mount the DeviceNet Communications Unit on the Inverter.



Precautions for Correct Use

Make sure that the power supply is OFF when you perform the setting up.

- 1 Check the name of each part on the Inverter and the DeviceNet Communications Unit by referring to the right figure.

- Inverter
 - A. Digital Operator
 - B. Spacer cover
 - C. Terminal cover
 - D. Front cover
 - E. Operator connector

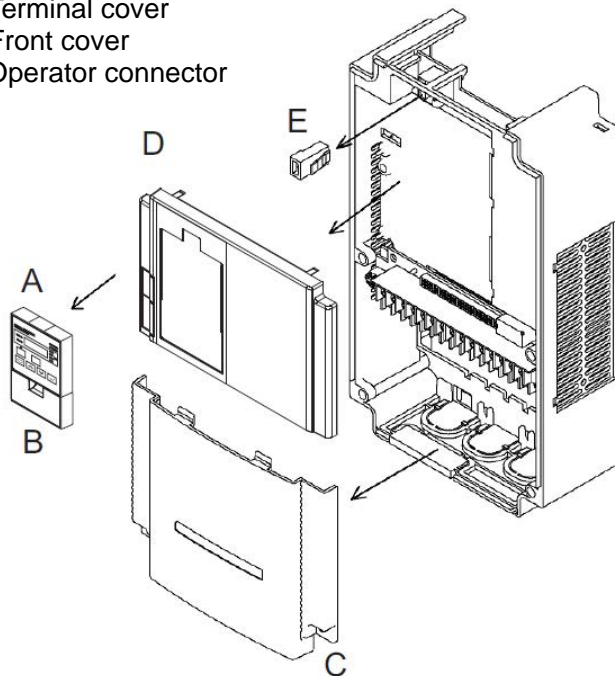

- DeviceNet Communications Unit

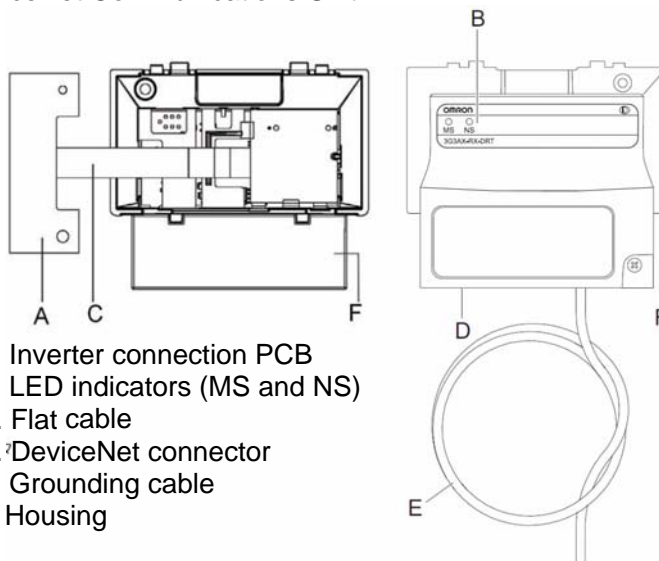

- A. Inverter connection PCB
- B. LED indicators (MS and NS)
- C. Flat cable
- D. DeviceNet connector
- E. Grounding cable
- F. Housing

- 2 Mount the DeviceNet Communications Unit on the Inverter.
- *For the mounting procedure of the DeviceNet Communications Unit, refer to *2-2-2 Mounting Procedure of DeviceNet Communications Unit on RX-series Inverter* in the *MX2/RX Series DeviceNet Communication Unit User's Manual* (Cat. No. I581).

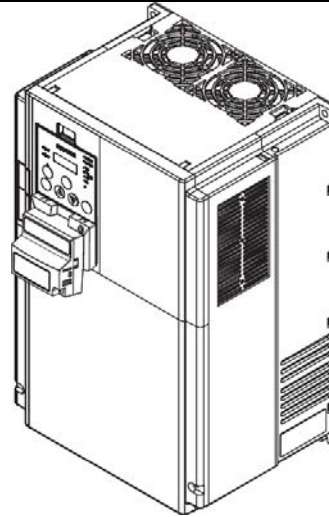

- 3 Connect the power supply to the main power supply input terminal.
- *The location of the power supply input terminal differs depending on the model. Refer to *2-3-4 Wiring for Main Circuit Terminals* in the *RX Series Type V1 High-function General-purpose Inverter User's Manual* (Cat. No. I578).

6.3.2. Parameter Setting

Set the parameter (node address) for the Inverter.



Additional Information

Make sure that DeviceNet is not connected when you perform the setting up.

- 1 Turn ON the power supply to the Inverter.

*Set the parameter by using the Digital Operator on the front of the Inverter.

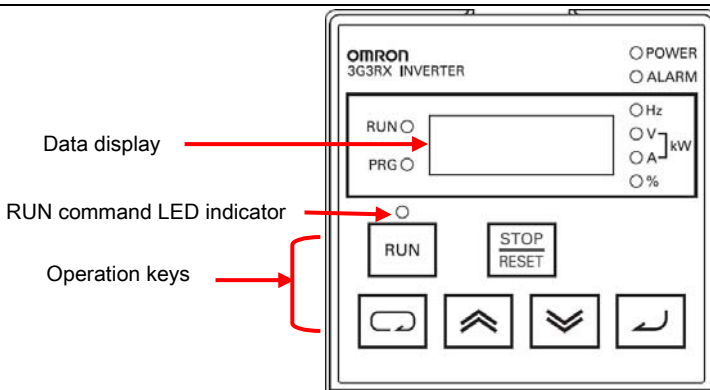

	Data display	Displays the frequency reference value, output current value or set value, or other relevant data.
	RUN key	Runs the Inverter. This key is enabled when RUN Command Selection is set to Digital Operator. (Check that the RUN command LED indicator is lit.)
	STOP/RESET key	Decelerates to stop the inverter. This key is used to reset an error when an error is occurring in the Inverter.
	Mode key	Switches between Monitor Mode (d [] [] []), Basic Function Mode (F000) and Extended Function Mode (A [] [] [], b [] [] [], C [] [] [], H [] [] []).
	Enter key	Enters the set value. (Make sure to press this key when you change the set value.)
	Increment Key	Switches each mode. This Key is also used to increment the set value of each function.
	Decrement Key	Switches each mode. This Key is also used to decrement the set value of each function.

2 When you turn ON the power supply, the display shows data as shown on the right. Set the parameters by using the procedure on the right.

[A001] Frequency Reference
Selection 1: 05
[A002] RUN Command
Selection 1: 05

*Set 05 (Option 2).

0.00

After turning ON the power supply, the display shows data. (By default, the display shows the data of d001 (Output Frequency Monitor).)



Press the Mode Key three times.

A001

Parameter A001 is displayed.



02

The default data is displayed.



Press the Increment Key three times.

05

The data is changed to 05.



Press the Enter Key.

A001

The parameter is displayed again.



Press the Increment Key once.

A002

Parameter A002 is displayed.



Press the Enter Key.

02

The default data is displayed.



Press the Increment Key three times.

05

The data is changed to 05.



Press the Enter Key.

A002

The parameter is displayed again.

3 Set the parameter by using the procedure on the right.

[C102] Reset selection: 03

*Set 03 (Trip reset only).
By setting this value, the communications connection is not reset even if the Inverter is reset.

A002

The parameter is displayed.



Press the Mode Key twice.

C001

Parameter C001 is displayed.



Press the Increment Key and display C102.

C102

Parameter C102 is displayed.



Press the Enter Key.

02

The default data is displayed.



Press the Increment Key once.

03

The data is changed to 03.



Press the Enter Key.

C102

The parameter is displayed again.

<p>4 Check the parameter by using the procedure on the right.</p>		<p>The parameter is displayed.</p>
<p>[P046] Assembly Instance Number : 1 (Default value: Extended Speed I/O)</p>		<p>Press the Mode Key twice.</p>
<p>*Confirm that the default value (1: Extended Speed I/O) is set.</p>		<p>Parameter P001 is displayed.</p>
		<p>Press the Increment Key to display P046.</p>
		<p>Parameter P046 is displayed.</p>
		<p>Press the Enter Key.</p>
		<p>The default data is displayed.</p>
		<p>Press the Enter Key.</p>
		<p>The parameter is displayed again.</p>
<p>5 Set the parameter by using the procedure on the right.</p>		<p>The parameter is displayed.</p>
<p>[P192] DeviceNet MAC ID: 00 *Set the node address to 00.</p>		<p>Press the Increment Key to display P192.</p>
		<p>Parameter P192 is displayed.</p>
		<p>Press the Enter Key.</p>
		<p>The default data is displayed.</p>
		<p>Press the Decrement Key.</p>
		<p>The data is changed to 00.</p>
		<p>Press the Enter Key.</p>
		<p>The parameter is displayed again.</p>

6 Turn OFF the power supply to the Inverter.

Connect the DeviceNet cable.

Cycle the power supply to the Inverter.

*To enable the changes described above, make sure to cycle the power supply to the Inverter.

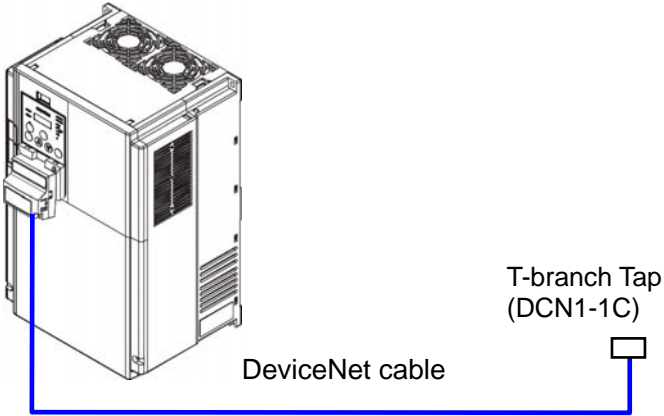

6.4. Setting Up the DeviceNet

Set up the DeviceNet Unit.

6.4.1. Hardware Setting

Set the hardware switches on the DeviceNet Unit.



Precautions for Correct Use

Make sure that the power supply is OFF when you perform the setting up.

<p>1</p> <p>Make sure that the power supply to the PLC is OFF when you perform the setting up.</p> <p>*If the power supply is turned ON, settings may not be applicable as described in the following procedure.</p>	
<p>2</p> <p>Check the hardware switches on the front panel of the DeviceNet Unit by referring to the right figure.</p>	<p>Indicators</p> <p>Unit No. switch This switch sets the unit number of the DeviceNet Unit as a one-digit hexadecimal value.</p> <p>Node address switches These switches set the node address as a two-digit decimal value.</p> <p>DIP switch The pins have the following functions: Pins 1 and 2: Baud rate Pin 3: Continue/Stop communications for error (when used as a Master) Pin 4: Hold/clear I/O for communications error (when used as a Slave)</p> <p>Communications connector Connect the Network communications cable to this connector. The communications power for this Unit is also supplied through this connector. A parallel connector with screws (XW4B-O5C1-H1-D) is provided for node connection.</p>
<p>3</p> <p>Set the Unit No. Switch to 0.</p>	<p>Setting method: One-digit hexadecimal Setting range: 0 to F Note: The unit number is set to 0 at the factory.</p>
<p>4</p> <p>Set the Node Address Switches to 63.</p>	<p>Setting method: Two-digit decimal Setting range: 0 to 63 Note: The node address is set to 63 at the factory.</p>

5 Set pin 2 of the DIP switch to ON. (Set pins 1, 3 and 4 of the DIP switch to OFF.)

*The baud rate is set to 500 kbps.

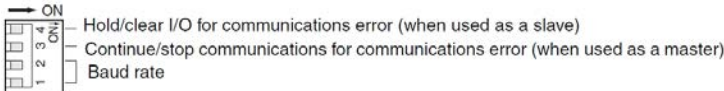

Pin	Function	Setting
1	Baud rate	See the next table.
2		
3	Continue/stop remote I/O communications for communication errors (when used as a master)	OFF: Continue communications ON: Stop communications
4	Hold/clear remote outputs for communications error (when used as a slave)	OFF: Clear remote outputs ON: Hold remote outputs

Pin 1	Pin 2	Baud rate
OFF	OFF	125 kbps
ON	OFF	250 kbps
OFF	ON	500 kbps
ON	ON	Not allowed.



All pins are set to OFF at the factory.

6.4.2. Starting the CX-Programmer and Connecting Online with the PLC

Start the CX-Programmer and connect online with the PLC.

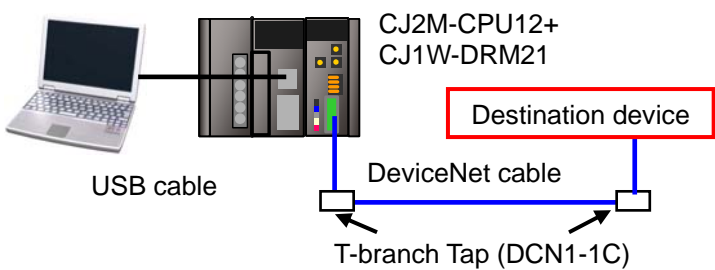
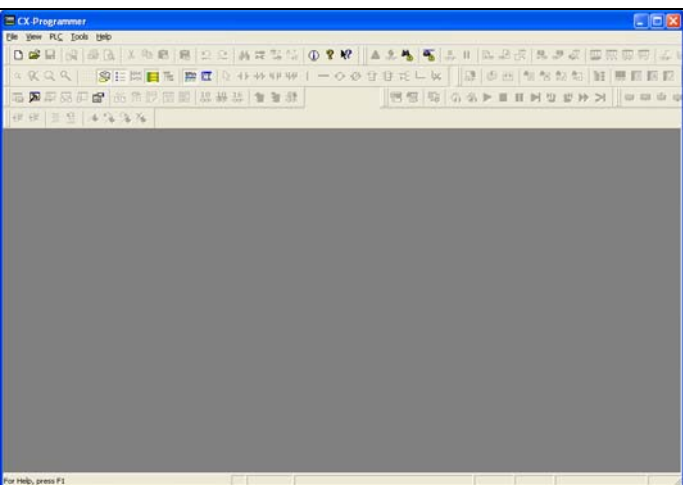
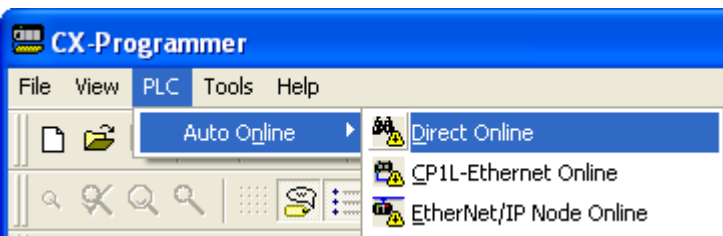
Install the CX-Programmer and USB driver in the personal computer beforehand.

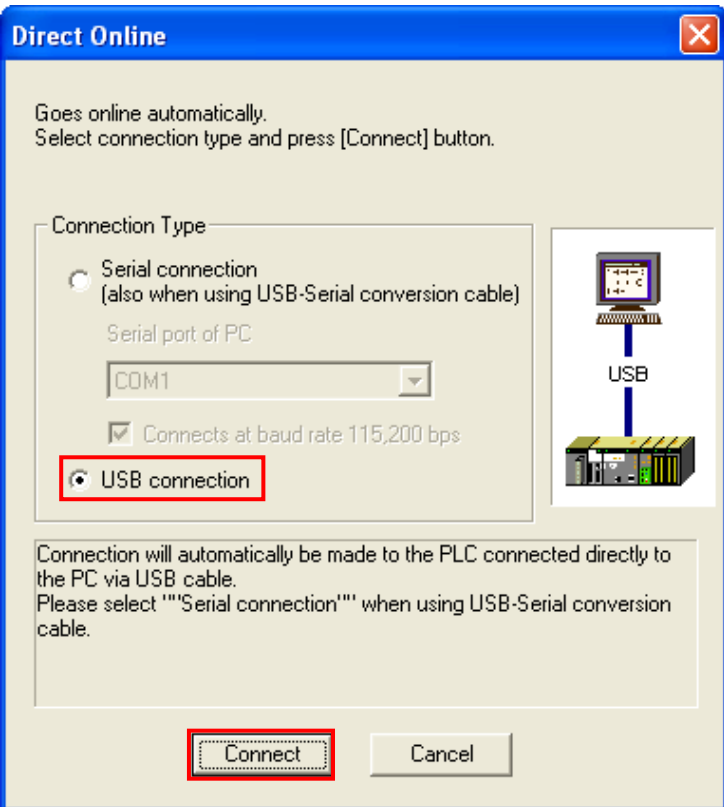
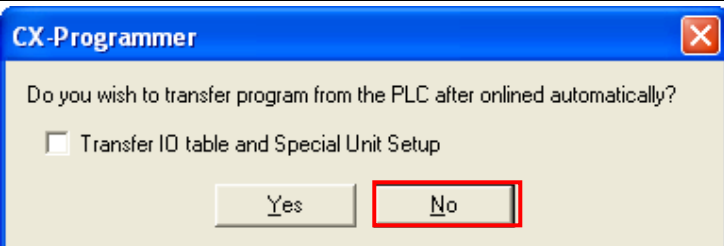
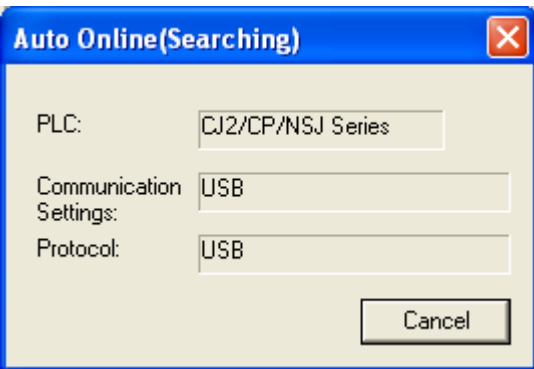
<p>1 Mount the DeviceNet Unit on the PLC and connect each cable (DeviceNet cable and USB cable). Turn ON the power supply to the PLC and communications power supply.</p>	 <p>CJ2M-CPU12+ CJ1W-DRM21</p> <p>USB cable</p> <p>DeviceNet cable</p> <p>T-branch Tap (DCN1-1C)</p> <p>Destination device</p>
<p>2 Start the CX-Programmer.</p>	
<p>3 Select Auto Online - Direct Online from the PLC Menu.</p>	

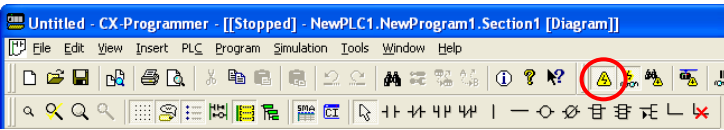
<p>4 The Direct Online Dialog Box is displayed. Select the <i>USB Connection</i> Option for the Connection Type and click the Connect Button.</p>	
<p>5 The dialog box on the right is displayed. Click the No Button.</p>	
<p>6 The dialog box on the right is displayed, and the CX-Programmer and the PLC is automatically connected.</p>	
<p>7 Confirm that the CX-Programmer and the PLC are normally connected online.</p> <p>*The  icon is pressed during online connection.</p>	



Additional Information

If the CX-Programmer and PLC are not connected online, please check the connection of the cable.

Or, return to step 2 and check the setting that was set in step 3 and try to connect them again. Refer to *Connecting Directly to a CJ2 CPU Unit Using a USB Cable* in *Chapter Communications* in *PART 3: CX-Server Runtime* of the *SYSMAC CX-Programmer Operation Manual* (Cat. No. W466) for details.



Additional Information

The dialogs explained in the following procedures may not be displayed depending on the environmental setting of CX-Programmer.

For details on the environmental setting, refer to *Options and Preferences* in *Chapter 3 Project Reference* in *PART 1: CX-Programmer* of the *SYSMAC CX-Programmer Operation Manual* (Cat. No. W466).

This document explains the setting procedure when the *Confirm all operations affecting the PLC* Check Box is selected.

6.4.3. Creating the I/O Table

Create the I/O table for the CPU Unit.

1 If the operating mode of the PLC is RUN Mode or Monitor Mode, change it to Program Mode by following the steps below.

(1) Select **Operating Mode - Program** from the PLC Menu of the CX-Programmer.

(2) The dialog box on the right is displayed. Click the **Yes** Button.

*Please refer to *Additional Information* on the previous page for the settings concerning the dialog display.

(3) Confirm that Program Mode is displayed on the right of the PLC model in the Project Tree of the CX-Programmer.

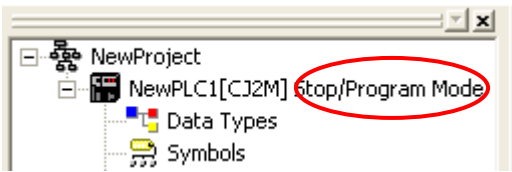
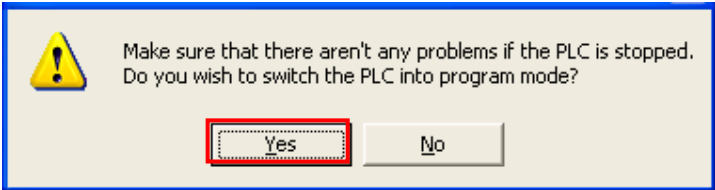
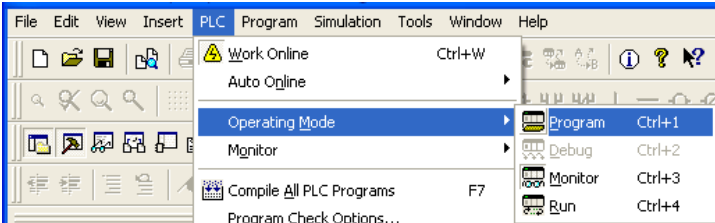
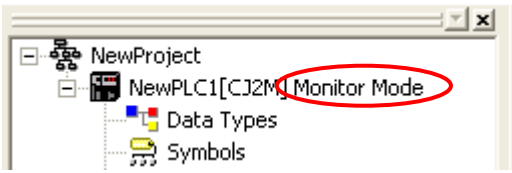

(Project workspace)

2 Select **Edit - I/O Table and Unit Setup** from the PLC Menu of the CX-Programmer.

The PLC IO Table Window is displayed.

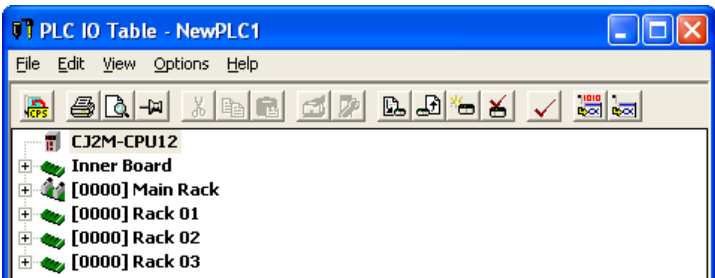
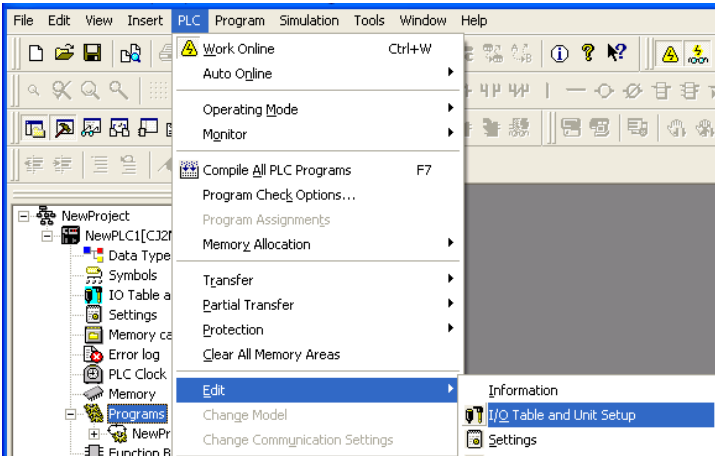

3 Select **Create** from the Options Menu of the PLC IO Table Window.

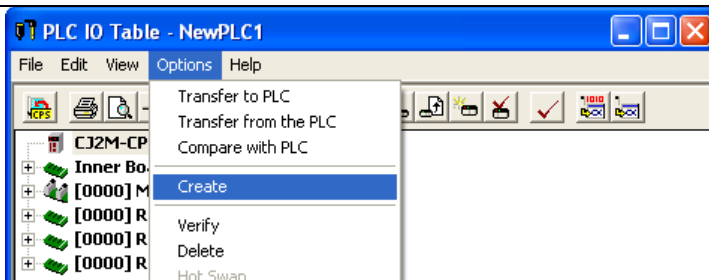

The dialog box on the right is displayed. Click the **Yes** Button.

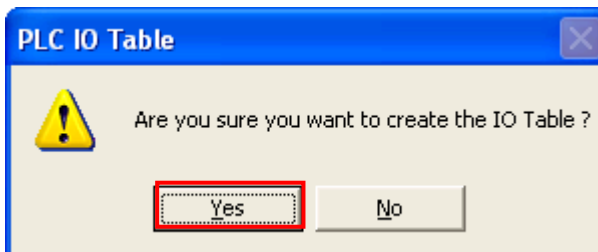

The dialog box on the right is displayed. Click the **Yes** Button.

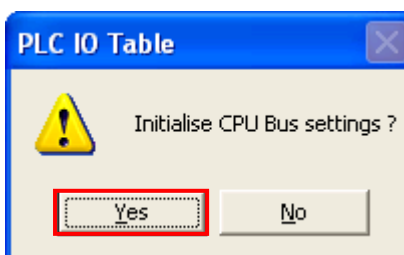

4 The Transfer from PLC Dialog Box is displayed. Select the *I/O Table* Check Box and *SIO Unit Parameters* Check Box, and click the **Transfer** Button.

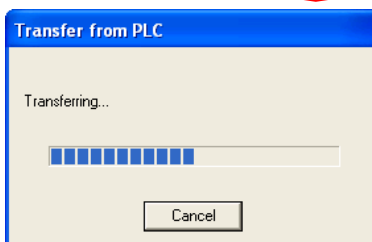
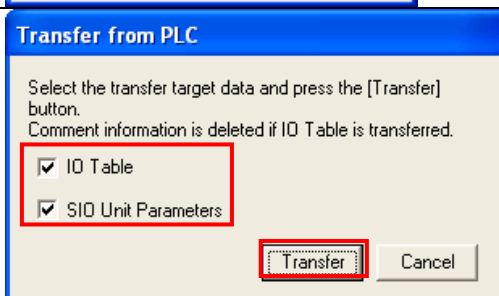

When the transfer is completed, Transfer Results Dialog Box is displayed.

Confirm that transfer was normally executed by referring to the message in the dialog box.

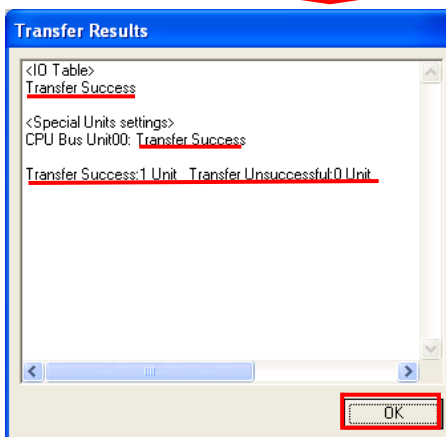

When the I/O table is normally transferred, the dialog box shows the following:
Transfer Success: 1 Unit
Transfer Unsuccessful: 0 Unit

Click the **OK** Button.

5 Go offline with the CX-Programmer. Select **Work Online** from the PLC Menu.

*The  icon is not pressed during offline connection.

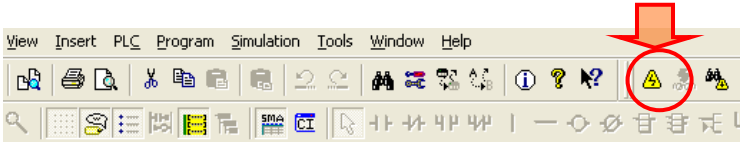
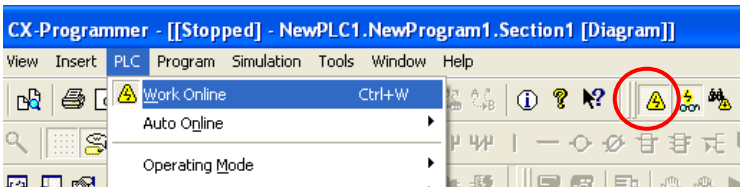

6.4.4. Starting the CX-Integrator and Registering and Setting the Device

Start the CX-Integrator and create the network and device offline.

1 Start the CX-Integrator.

*If the Component List Window is not displayed, select **Windows - Component List Window** from the View Menu.

Component List Window

Online Connection Information Window

Network Configuration Window

Output Tab Page

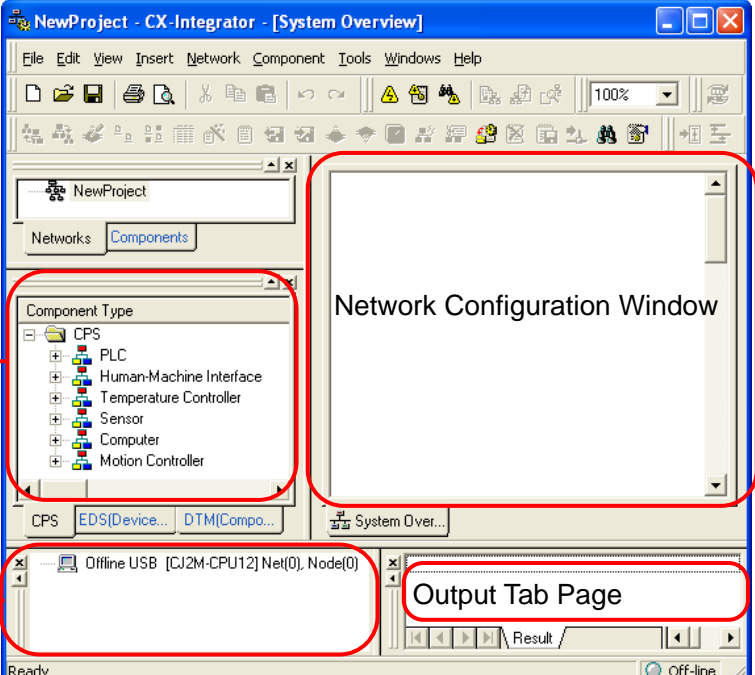

2 Select **Network** from the Insert Menu of the CX-Integrator.

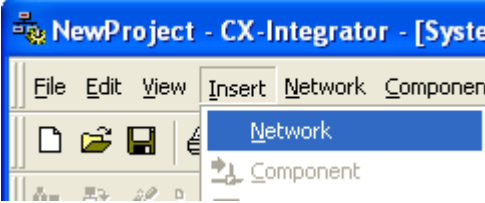

3 Select **DeviceNet** and click the **Next** Button.

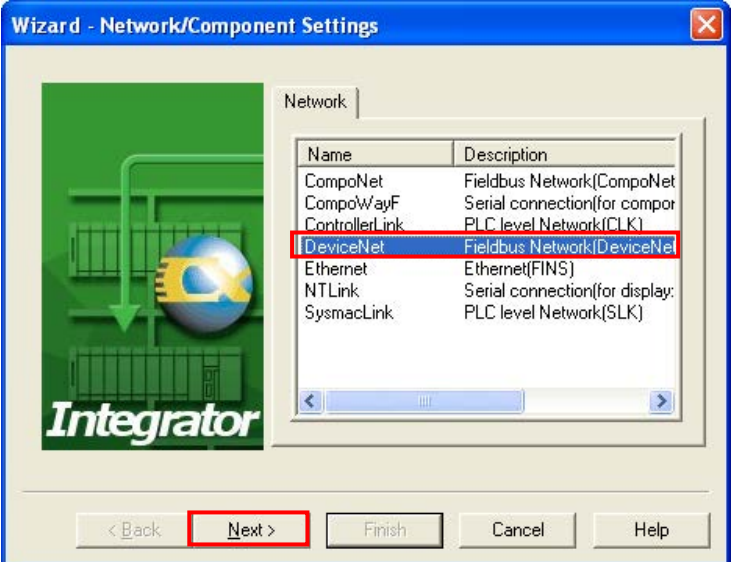

Name	Description
CompoNet	Fieldbus Network(CompoNet)
CompoWayF	Serial connection(for compor)
ControllerLink	PLC level Network(CLK)
DeviceNet	Fieldbus Network(DeviceNet)
Ethernet	Ethernet(FINS)
NTLink	Serial connection(for display)
SysmacLink	PLC level Network(SLK)

4 Select the *Not Used* Check Box in the Network Address Field and click the **Finish** Button.

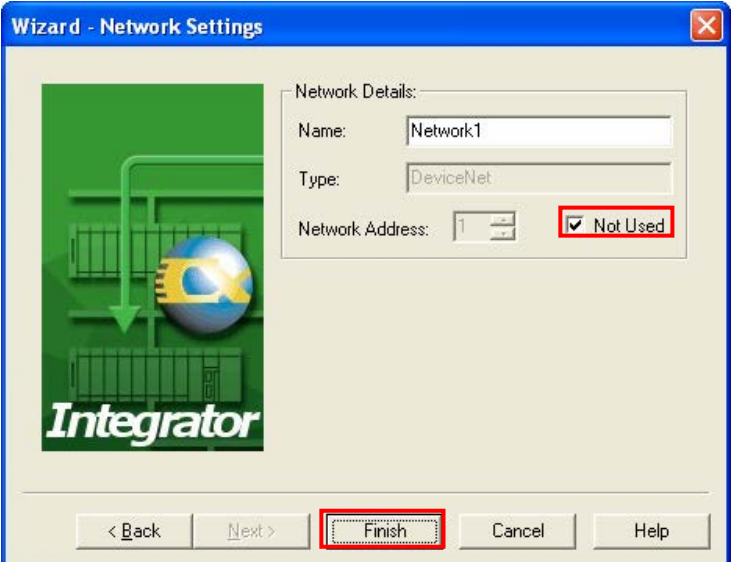

5 Register the DeviceNet Unit in the Network. Select **Component** from the Insert Menu.

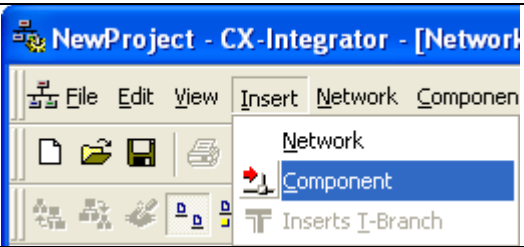

6 Select the DeviceNet Unit from the component list and click the **Finish** Button. Here, select **OMRON Corporation - Communications Adapter - CJ1W-DRM21**.

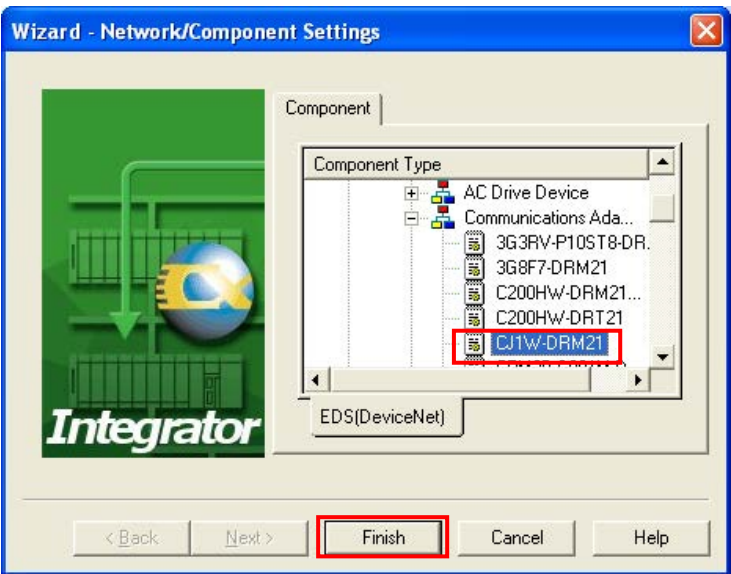

7 Enter the node address (63 is entered here) in the Node Address Setup Dialog Box, and click the **OK** Button.

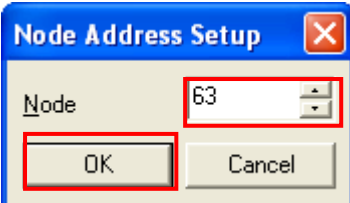

8 Confirm that the DeviceNet Unit is registered in the Network Configuration Window.

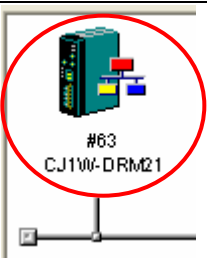

- 9 Register the Inverter (hereinafter referred to as the Slave Unit) in the network. Select **Component** from the Insert Menu.

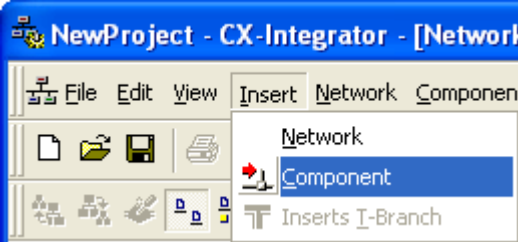
- 10 Select the Slave Unit to connect from the component list, and click the **Finish** Button. Here, select **3G3AX-RX-DRT-A2055**.

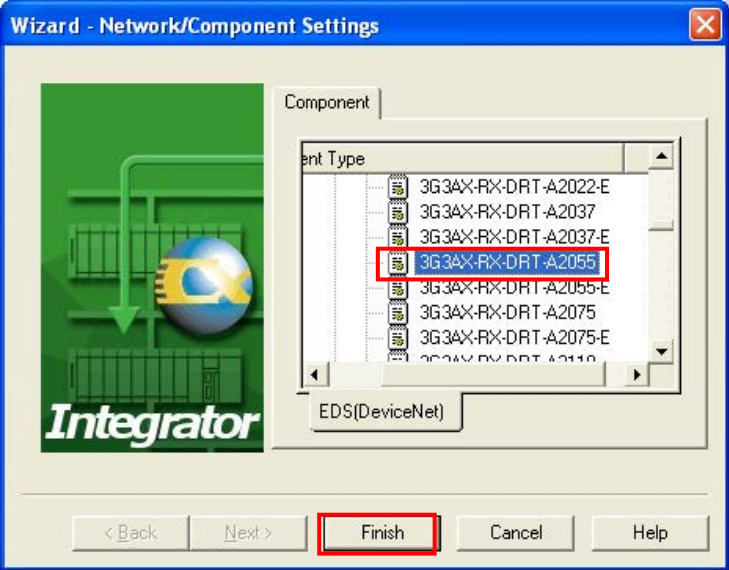
- 11 Enter the node address (0 is entered here) in the Node Address Setup Dialog Box, and click the **OK** Button.

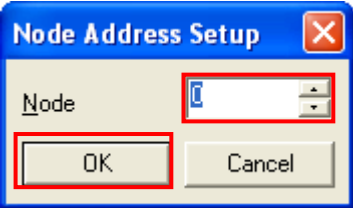

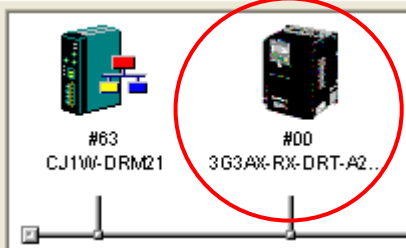
- 12 Confirm that the Slave Unit is registered in the Network Configuration Window.



6.4.5. Setting the Device

Set the device and register it in the DeviceNet Unit (create a scan list).

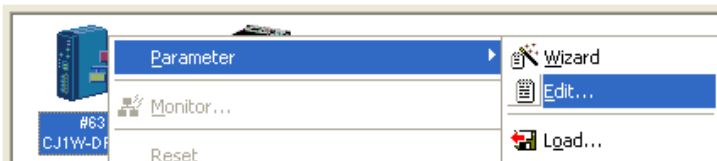
- 1 Right-click the DeviceNet icon and select **Parameter - Edit**.



- 2 The Edit Device Parameters Dialog Box is displayed. Slave Unit (#00) is displayed in the Unregister Device List.

Select the *Auto allocation as is registered* Check Box. Click the ↓ button.

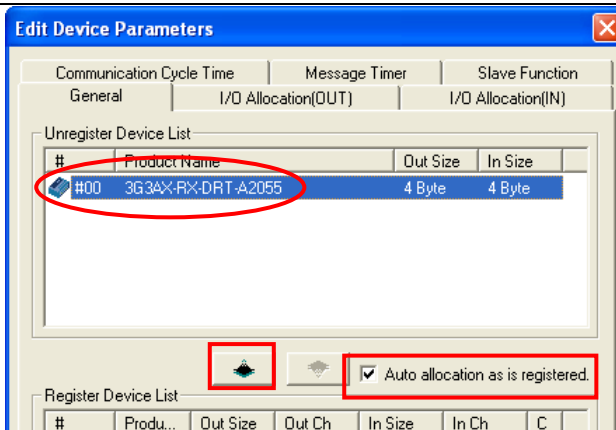

Slave Unit (#00) is registered in the Register Device List.

Confirm that the sizes and channels are set as follows, and click the **OK** Button.

- OUT Size: 4 Byte
- Out Ch: 3200:Bit00
- In Size: 4 Byte
- In Ch: 3300:Bit00

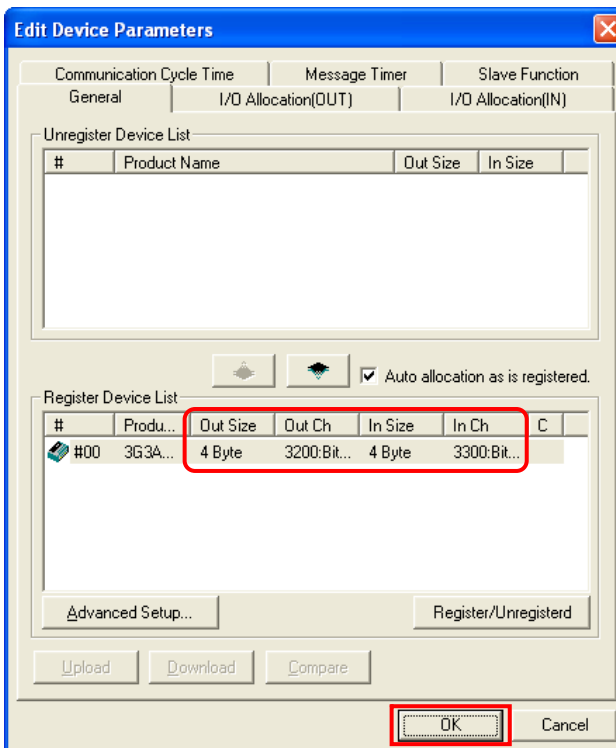

- 3 Confirm that node address #63 is displayed under the slave unit icon on the Network Configuration Window.

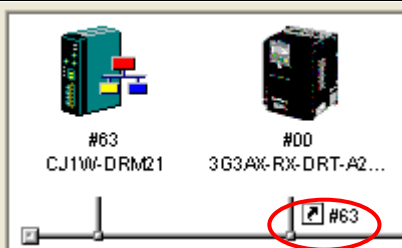

6.4.6. Connecting Online and Transferring the Scan List

Connect online with the Controller, and transfer the setting (scan list) of the set device to the DeviceNet Unit via the Controller. When the transfer is completed, remote I/O communications start automatically.



Precautions for Correct Use

Please confirm that the DeviceNet cable is connected before proceeding to the following procedure.

If it is not connected, turn OFF the power to the devices, and then connect the DeviceNet cable.

- 1 Select **Auto Online** from the Network Menu.

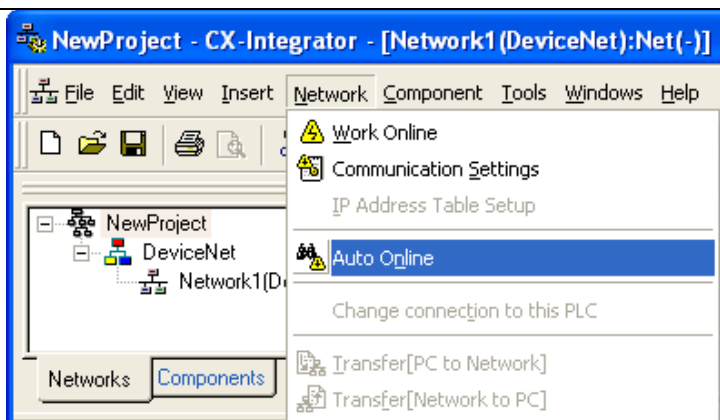

- 2 The Auto Online Dialog Box is displayed. Select the **USB connection** Option in the Connection type Field, and click the **Connect** Button.

A screen is displayed indicating the connection is being established.

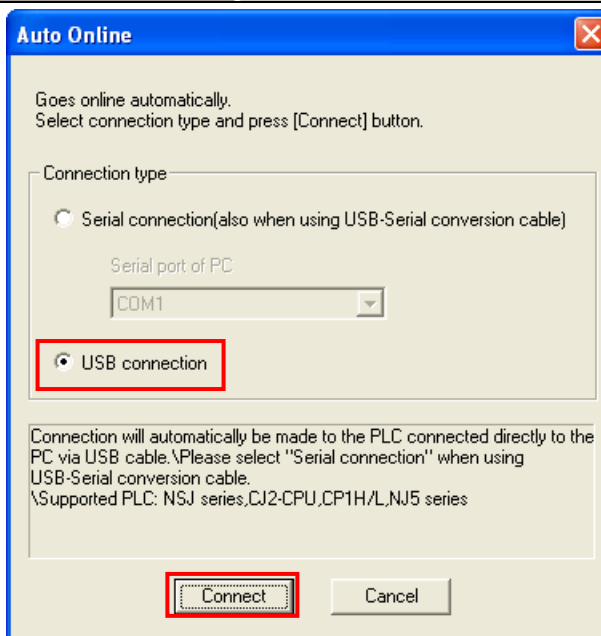

3 After an online connection is established, the background color of the Network Configuration Window changes as shown in the right figure.

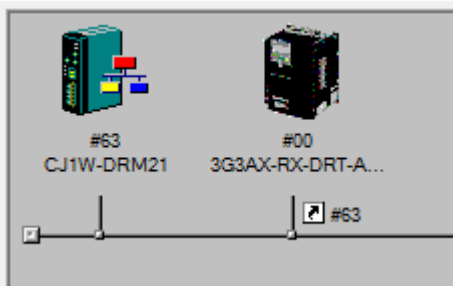

Precautions for Correct Use

If an online connection cannot be made to the Controller, check the cable connection. Or, check the settings such as a connection type and try again from step 1.



Additional Information

For details on the online connections to a Controller, refer to *Section 2 Basic Operations in the Communications of the CX-Integrator Ver.2.[.] Operation Manual (Cat. No. W446)*.

4 Right-click *DeviceNet* in the Online Connection Information Window, and select **Connect**.

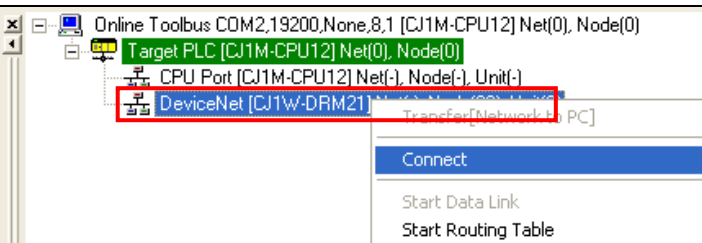

5 Select DeviceNet in the Select Network Dialog Box, and click the **OK** Button.

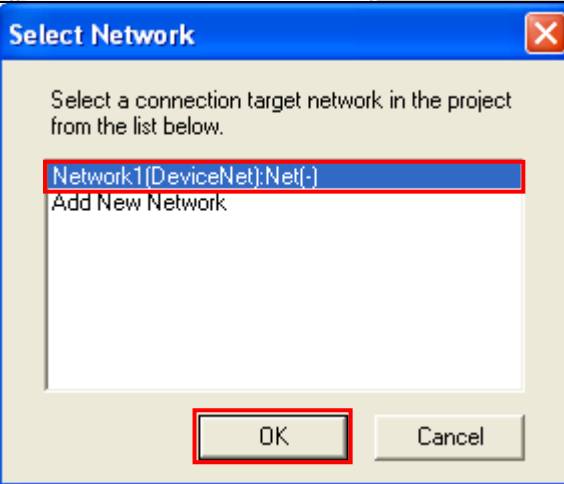

6 Confirm that the DeviceNet is in online status ( icon) in the Online Connection Information Window.

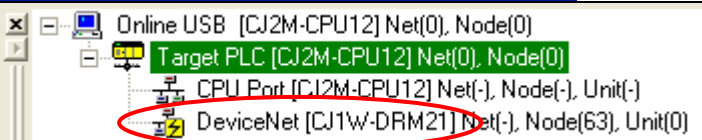

7 Right-click CJ1W-DRM21 on the Network Configuration Window, and select **Parameter - Edit**.

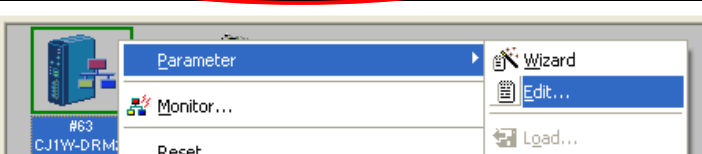

8 The Edit Device Parameters Dialog Box is displayed. Click the **Download** Button.

*If the operating mode of the PLC is not PROGRAM mode when download is executed, a dialog box is displayed confirming whether to change the mode. If the dialog box is displayed, click the **OK** Button.

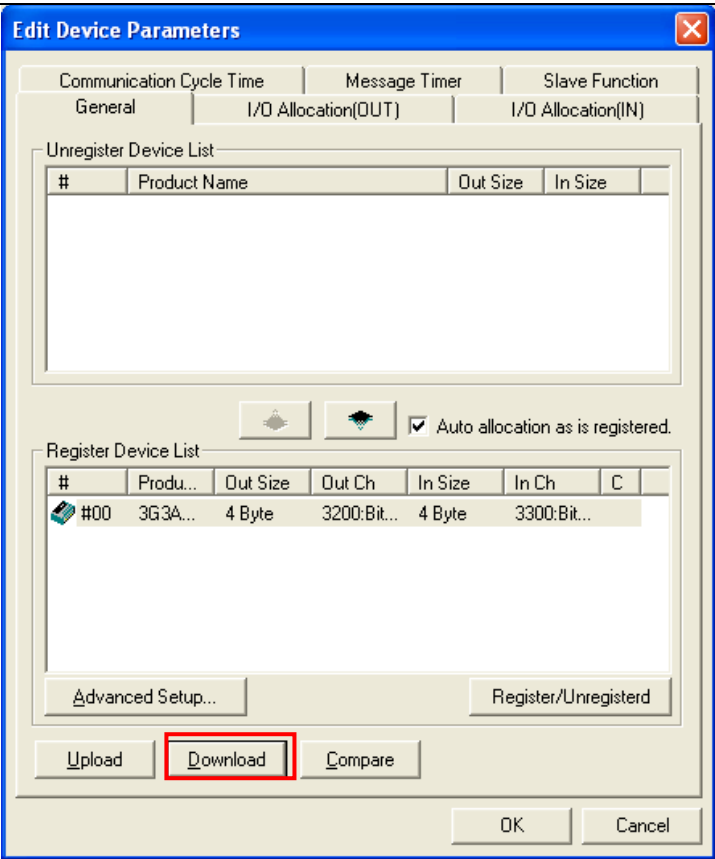

9 A download confirmation dialog box is displayed. Click the **Yes** Button to download the parameters.

*If the mode was changed in the previous step, a dialog box is displayed confirming whether to return the PLC operating mode. Click the **No** Button and remain in the current mode.

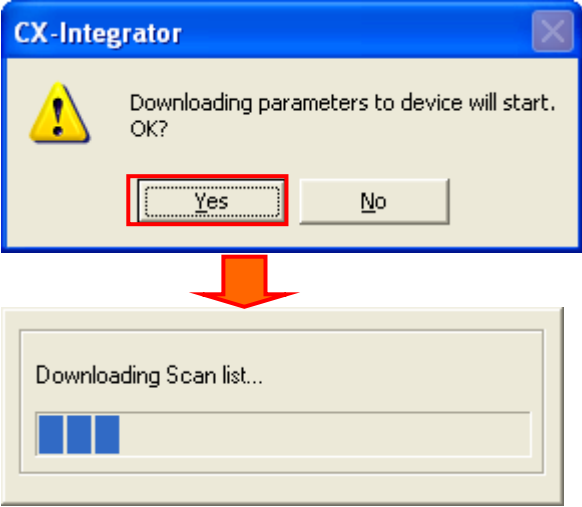

10 The Edit Device Parameters Dialog Box is displayed again. Click the **Compare** Button.

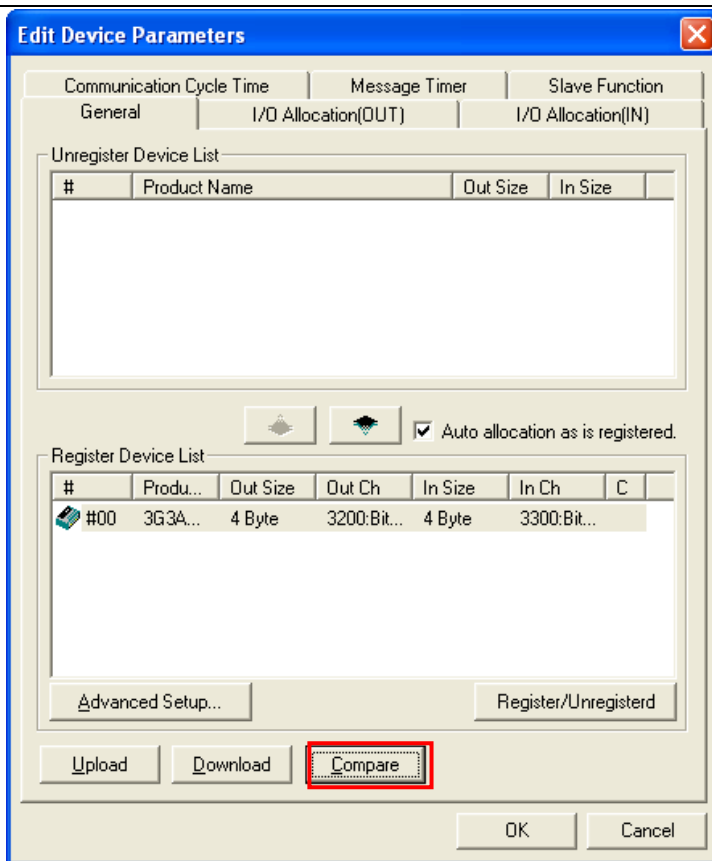

11 A dialog box shown on the right is displayed. Click the **Yes** Button to compare the parameters.

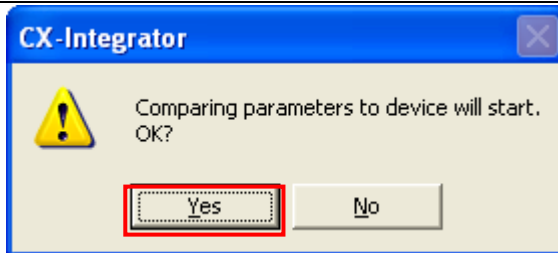

When the comparison is completed, a dialog box shown on the right is displayed. Click the **OK** Button.

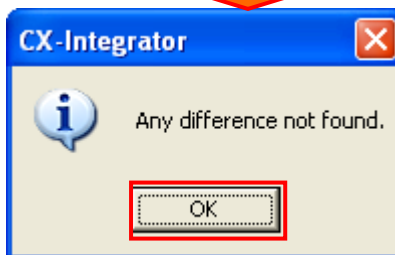

The Edit Device Parameters Dialog Box is displayed again. Click the **OK** Button.

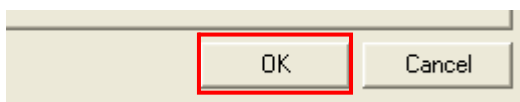

6.5. Connection Status Check

Check the connection status of the DeviceNet network.

6.5.1. Checking the Connection Status

Confirm that the DeviceNet communications is working.

- 1 Confirm that the DeviceNet communications is performed normally by checking the LED indicators on each unit.
 - DeviceNet Unit
 - LED indicators in normal status
 - MS: Lit green
 - NS: Lit green
 - During normal operation, the 7-segment display shows 63. (63: Master node address, remote I/O communications active and normal)

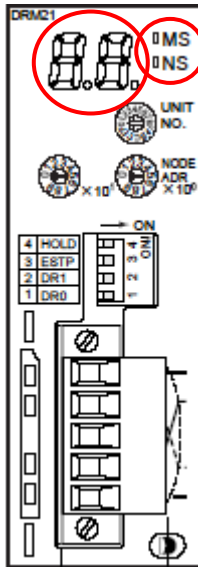

(DeviceNet Unit)

- Inverter
 - LED indicators in normal status
 - MS: Lit green
 - NS: Lit green

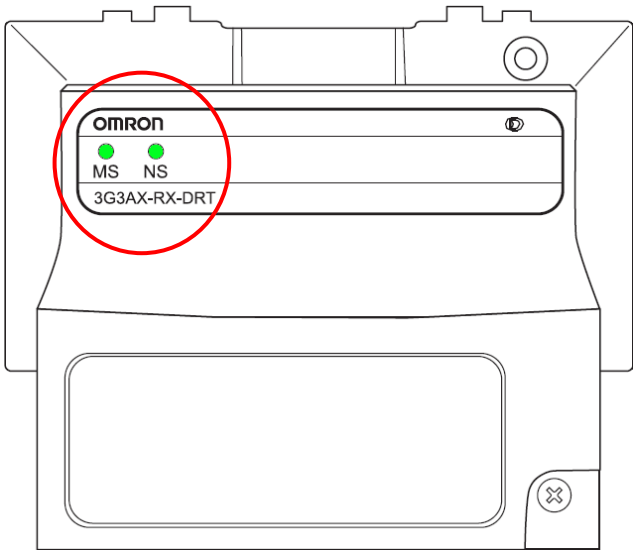

(Inverter)

- 2 Confirm that the DeviceNet communications are performed normally from the CX-Integrator by referring to the status information on the Monitor Device Dialog Box.

Right-click the DeviceNet Unit icon on the Network Configuration Window, and select **Monitor**.

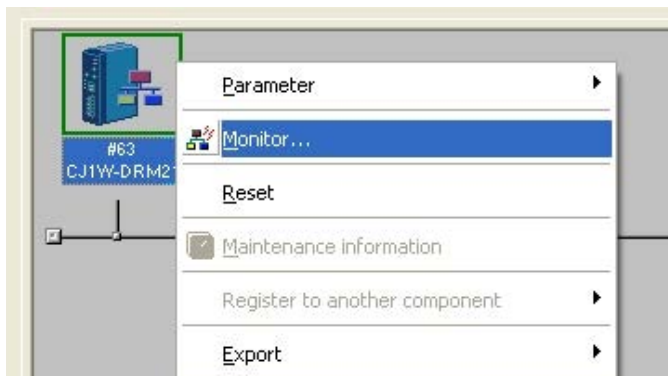

- 3 The figure on the right shows the Status Tab Page of the Monitor Device Dialog Box.

DeviceNet communications are normally performed if the same items are selected in the Master Status Field, #00 is lit blue in the Slave Status Field, and the *Remote I/O Communications Running* Check Box is selected.

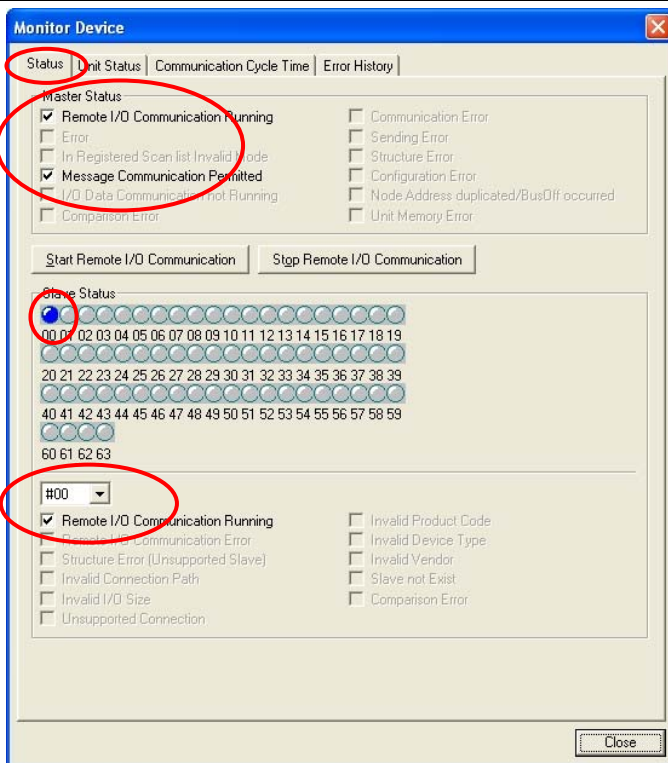

(Monitor Device Dialog Box)

- 4 Click the **Close** Button on the bottom right of the Monitor Device Dialog Box to close the Monitor Device Dialog Box.

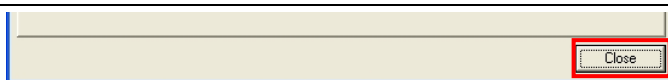

- 5 Go offline with the CX-Integrator. Select **Work Online** from the Network Menu.

*The  icon is not pressed during offline connection.



6.5.2. Checking Data That Are Sent and Received

Confirm that the correct data are sent and received.

WARNING

Confirm safety sufficiently before monitoring power flow and present value status in the Ladder Section window or before monitoring present values in the Watch window. If force-set/reset or set/reset operations are incorrectly performed by pressing short-cut keys, the devices connected to Output Units may malfunction, regardless of the operating mode of the CPU Unit.



WARNING

The Inverter will run if you proceed to this section. Confirm safety before operation. If you cannot confirm safety, do not proceed to this section after completing until Section 6.5.1.
If you proceed to this section, make sure to complete all the steps and place the Inverter in the safe state.



1 Select **Work Online** from the PLC Menu of the CX-programmer.

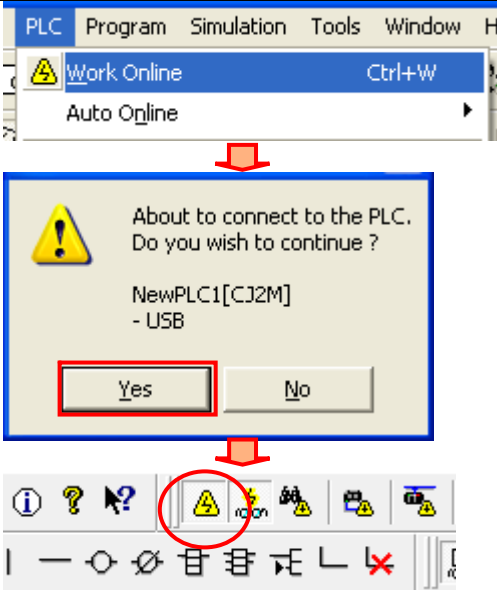

A confirmation dialog box is displayed. Click the **Yes** Button.

The icon is pressed.



Precautions for Correct Use

If an online connection can not be established, check the CX-Integrator's connection status. If it is online, disconnect it from the PLC. Or, check the cable connection and connection settings.

2 Confirm that the operating mode of the PLC is PROGRAM mode.
 *If it is not PROGRAM mode, refer to step 1 of 6.4.3. Creating I/O Table and change to PROGRAM mode.

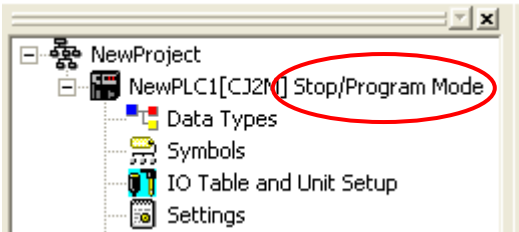

3 Select **Edit - Memory** from the PLC Menu.

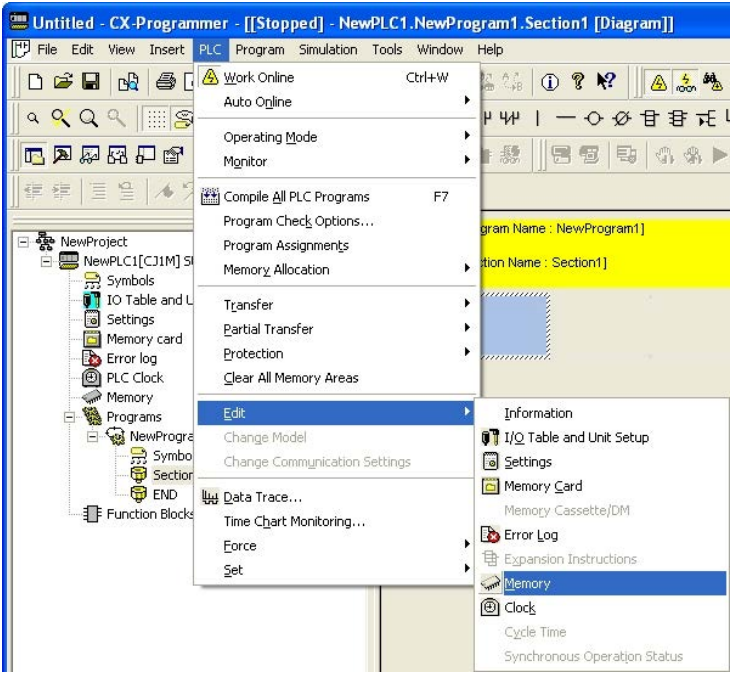

4 Double-click **CIO** from a list in the PLC Memory Window.

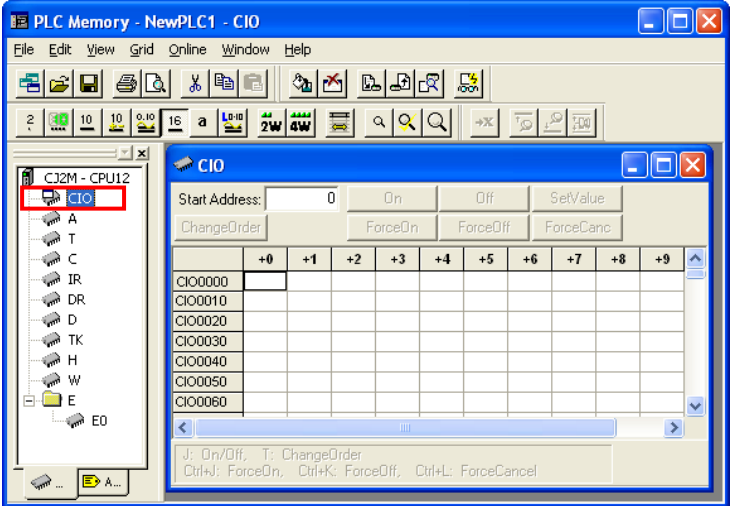

(PLC Memory Window)

5 Select **Display - Binary** from the View Menu.

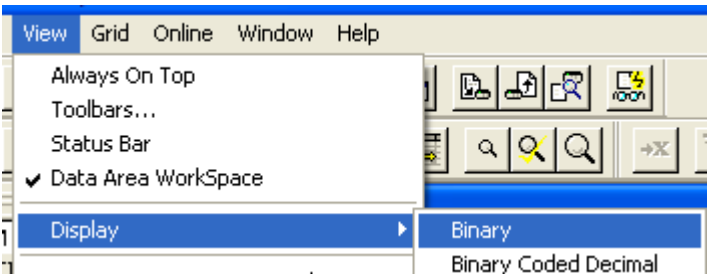

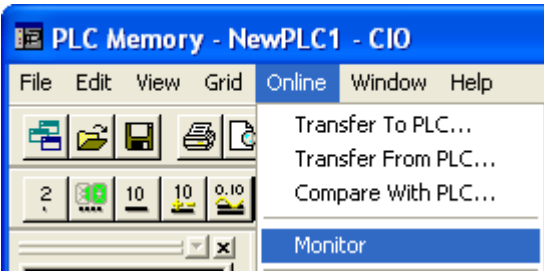
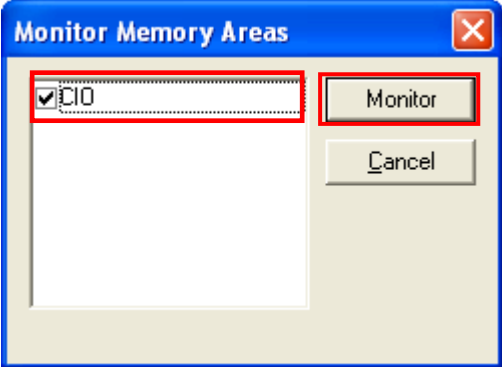
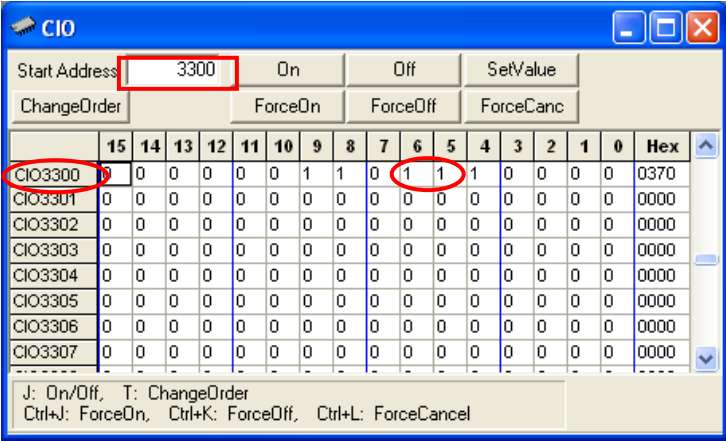
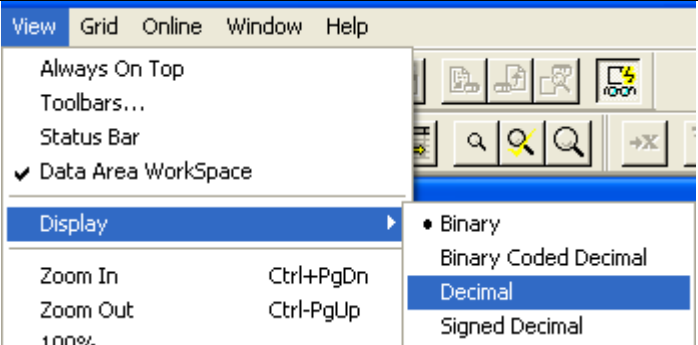
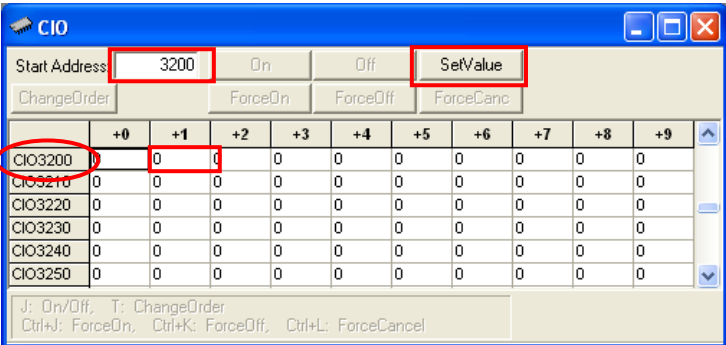
- 6 Select **Monitor** from the Online Menu.
- 
- 7 The Monitor Memory Areas Dialog Box is displayed. Select the **CIO** Check Box and click the **Monitor** Button.
- 
- 8 On the CIO Window, enter 3300 in Start Address. Confirm that the start address was changed to CIO 3300.
- Confirm that 1 is set in both bit 5 and bit 6 of CIO 3300.
- *[CIO3300.05: CFN]
0: Follow the setting of parameter A002.
1: DeviceNet reference
- *[CIO3300.06: RFN]
0: Follow the setting of parameter A001.
1: DeviceNet reference
- 
- 9 Select **Display - Decimal** from the View Menu.
- 
- 10 On the CIO Window, enter 3200 in Start Address. Confirm that the start address was changed to CIO 3200. Select CIO 3201 and click the **Set Value** Button.
- 

11 Enter 100 in Value on the Set Value: Decimal Dialog Box and click the **OK** Button.

*[CIO 3201: Rotation Speed Reference]
The unit of the rotation speed is 0.01 Hz.

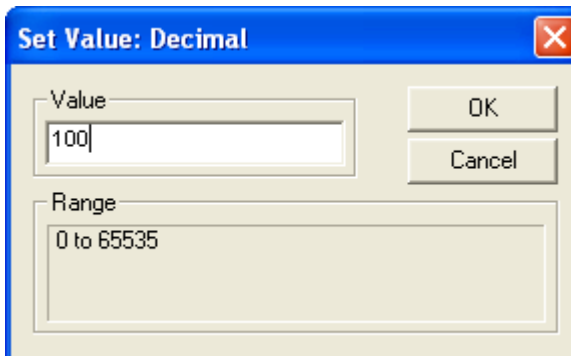

12 Confirm that RUN LED indicator of the Inverter is not lit and **0.00** is shown on the data display (Output frequency setting).

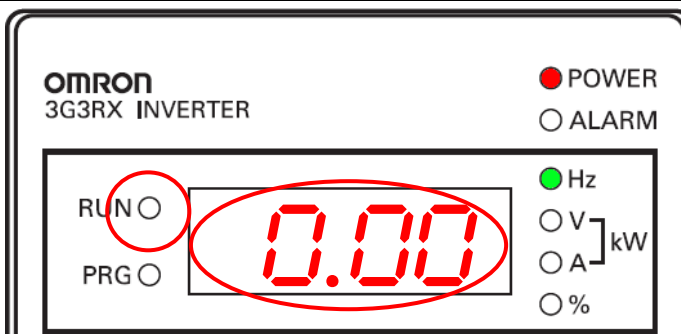

13 Select CIO 3200 and click the **Set Value** Button.

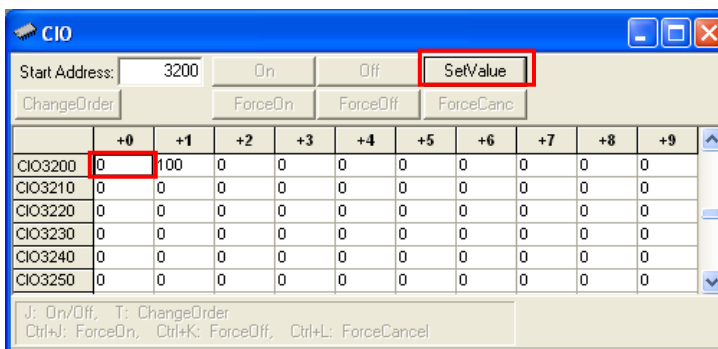

14 Enter 1 in Value on the Set Value: Decimal Dialog Box and click the **OK** Button.

*[CIO 3200 Bit 0: FW]
0: Stop/1: Forward

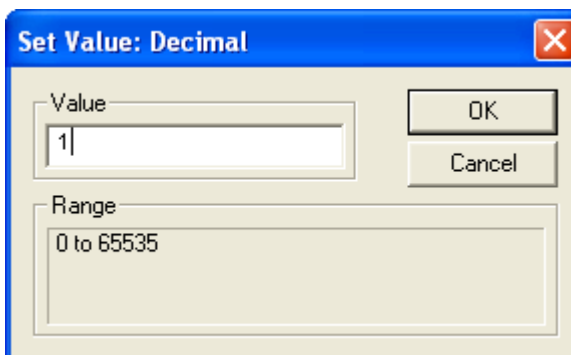

15 Confirm that RUN LED indicator of the Inverter is lit and **1.00** is shown on the data display (Output frequency).

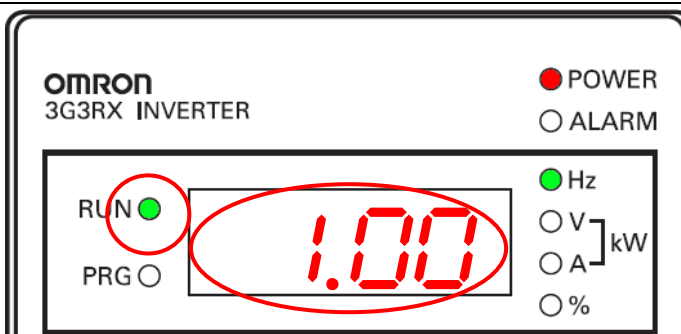

16 Select CIO 3200 and click the **Set Value** Button.

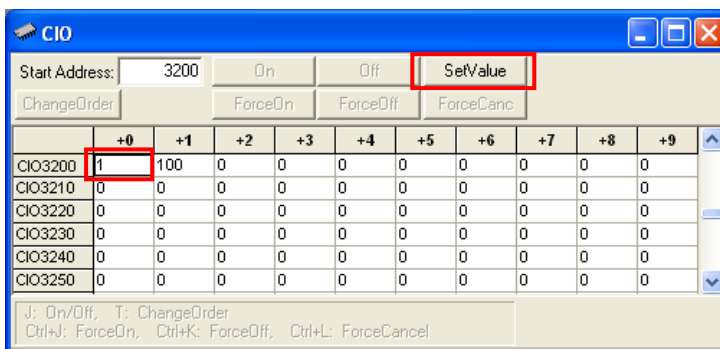

17 Enter 0 in Value on the Set Value: Decimal Dialog Box and click the **OK** Button.

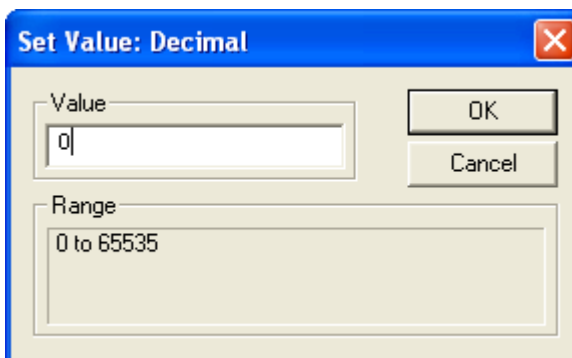

*[CIO3200 Bit 0: FW]
0: Stop/1: Forward

18 CIO3200 is changed to 0.

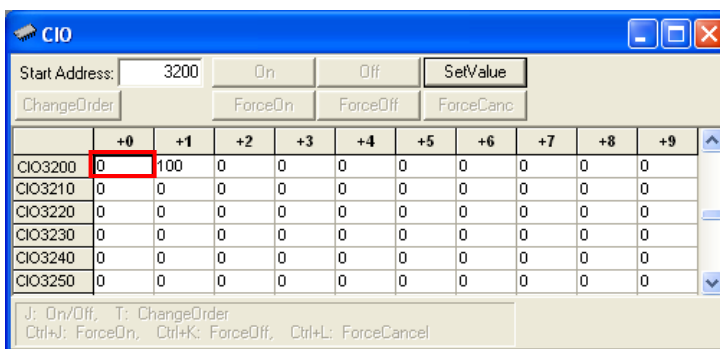

19 Confirm that RUN LED indicator of the Inverter is lit and **0.00** is shown on the data display (Output frequency).

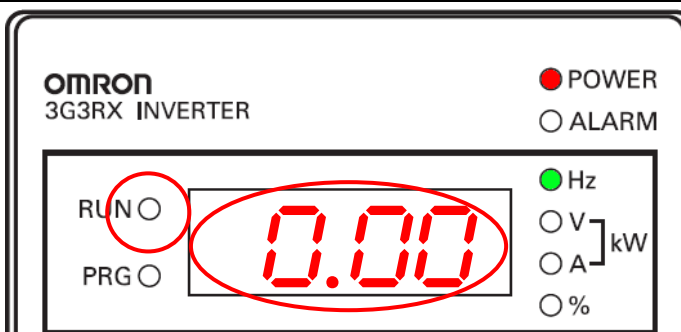

7. Initialization Method

This document explains the setting procedure from the factory default setting.

Some settings may not be applicable as described in this document unless you use the devices with the factory default setting.

7.1. PLC

To initialize the PLC, it is necessary to initialize the DeviceNet Unit and the CPU Unit. Place in PROGRAM Mode before the initialization.

7.1.1. DeviceNet Unit

Use the following procedure to initialize the settings of the DeviceNet Unit.

- (1) Right-click **CJ1W-DRM21** on the PLC IO Table of the CX-Programmer and select **Unit Setup** from the menu.

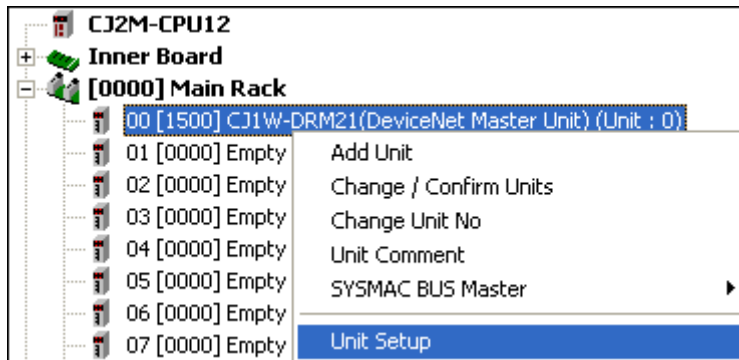

- (2) On the CJ1W-DRM21 [View Parameters] Dialog Box, select *Clears the scan list* from Scan List Clear Switch.

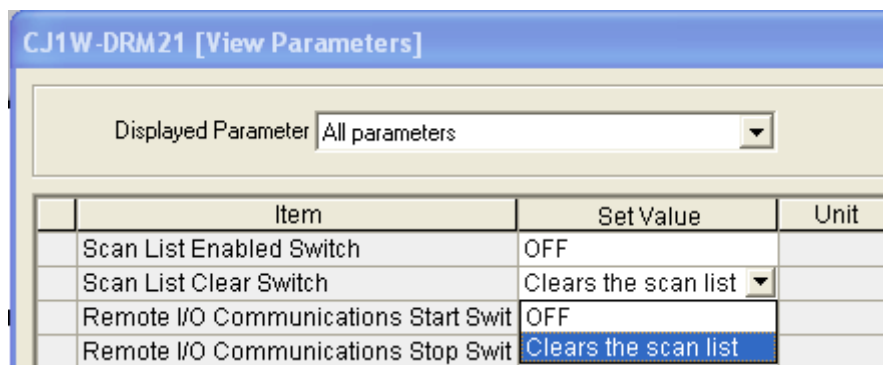

- (3) Click the Transfer [PC to Unit] Button.



7.1.2. CPU Unit

To initialize the settings of the CPU Unit, select **Clear All Memory Areas** from the PLC Menu of the CX-Programmer. Select the **Initialize** Button on the Confirm All Memory Area Clear Dialog Box and click the **OK** Button.

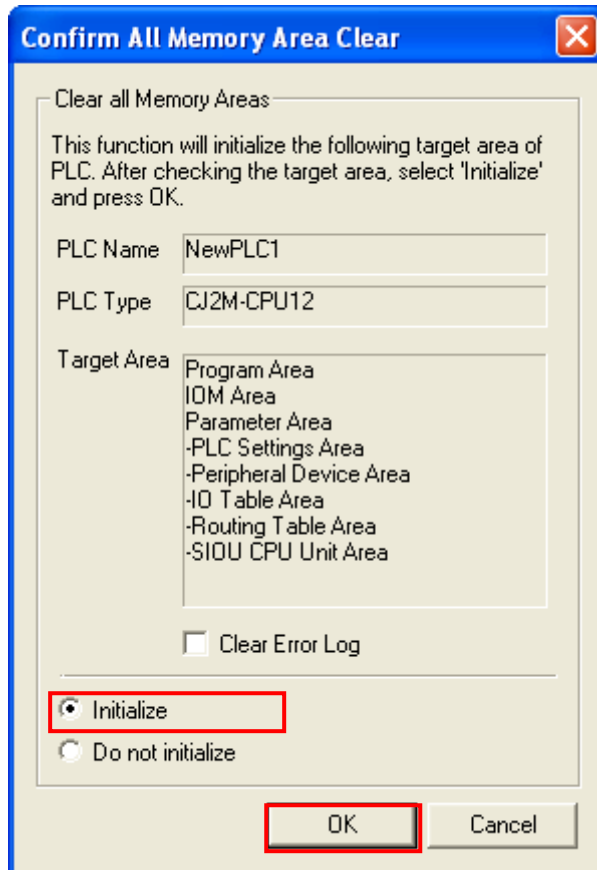

7.2. Inverter

For the initialization of the Inverter, refer to *Initialization Setting of 5-1-2 Parameter Initialization* in the *RX Series Type V1 High-function General-purpose Inverter User's Manual* (Cat. No. I578).

8. Revision History

Revision code	Date of revision	Revision reason and revision page
01	Mar. 5, 2013	First edition

OMRON Corporation Industrial Automation Company

Tokyo, JAPAN

Contact: www.ia.omron.com

Regional Headquarters

OMRON EUROPE B.V.

Wegalaan 67-69-2132 JD Hoofddorp
The Netherlands

Tel: (31)2356-81-300/Fax: (31)2356-81-388

OMRON ELECTRONICS LLC

One Commerce Drive Schaumburg,
IL 60173-5302 U.S.A.

Tel: (1) 847-843-7900/Fax: (1) 847-843-7787

OMRON ASIA PACIFIC PTE. LTD.

No. 438A Alexandra Road # 05-05/08 (Lobby 2),
Alexandra Technopark,
Singapore 119967

Tel: (65) 6835-3011/Fax: (65) 6835-2711

OMRON (CHINA) CO., LTD.

Room 2211, Bank of China Tower,
200 Yin Cheng Zhong Road,
PuDong New Area, Shanghai, 200120, China

Tel: (86) 21-5037-2222/Fax: (86) 21-5037-2200

Authorized Distributor:

© OMRON Corporation 2013 All Rights Reserved.
In the interest of product improvement,
specifications are subject to change without notice.

Cat. No. P547-E1-01

0911(-)