

OMRON

Faster, More Accurate and Easier to Use A New Concept in Servo Systems

SMARTSTEP

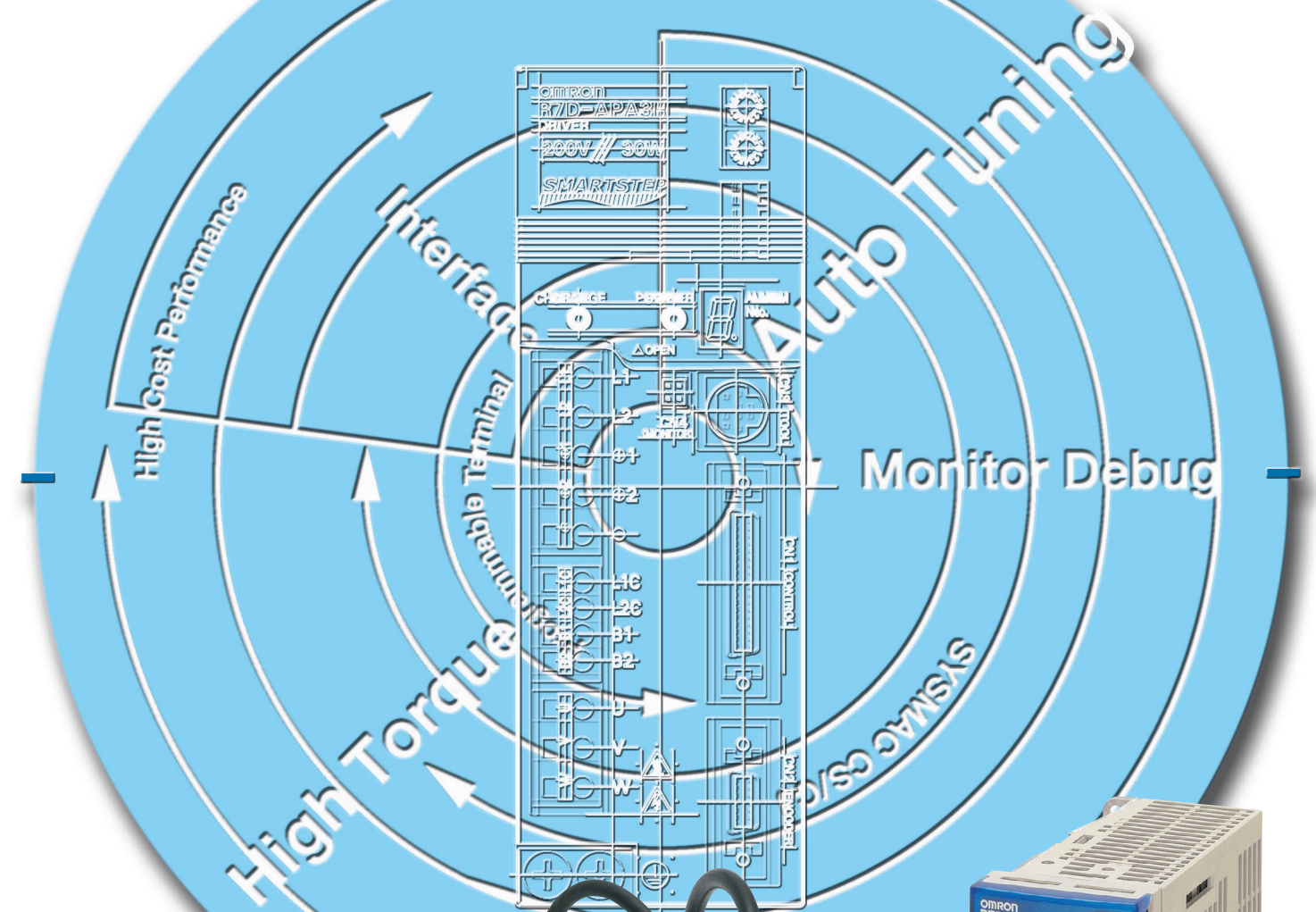

Note: Do not use this document to operate the Unit.

OMRON Corporation

Control Devices Division H.Q.
Shiokoji Horikawa, Shimogyo-ku,
Kyoto, 600-8530
Japan
Tel: (81)75-344-7109
Fax: (81)75-344-7149

Regional Headquarters

OMRON EUROPE B.V.
Wegalaan 67-69, NL-2132 JD Hoofddorp
The Netherlands
Tel: (31)2356-81-300/
Fax: (31)2356-81-388

OMRON ELECTRONICS LLC

1 East Commerce Drive, Schaumburg,
IL 60173 U.S.A.
Tel: (1)847-843-7900/Fax: (1)847-843-8568

OMRON ASIA PACIFIC PTE. LTD.

83 Clemenceau Avenue,
#11-01, UE Square,
Singapore 239920
Tel: (65)6835-3011/Fax: (65)6835-2711

OMRON (CHINA) CO., LTD.

Room 2211, Bank of China Tower,
200 Yin Cheng Zhong Road,
PuDong New Area, Shanghai, 200120 China
Tel: (86)21-5037-2222/Fax: (86)21-5037-2200

Authorized Distributor:

Note: Specifications subject to change without notice.

Cat. No. I807-E1-04
Printed in Japan
0405-1M

Quick, High-Torque, High-Precision Positioning for Up to 15 Axes. Plus, an Operating Environment that Ensures Fast and Easy Setup.



Backed by the trend toward increasing complexity in motor control, more advanced functions, multifunctional versatility and greater applications compatibility are demanded in servo systems.

This is further combined with the need to raise productivity and improve cost performance.

SMARTSTEP meets these needs with high-speed, high-precision positioning, fewer process steps, speedier setup, and a variety of functions that allow easy operation and quick and efficient connection with peripheral components.

Super-easy

Connection

Control cables for connecting drivers and controllers are available for every type of controller for easy connection. Motors are also connected with a single cable. Special decelerators are also available.

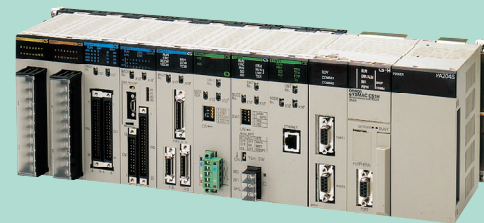

Super-easy

Operation

OMRON PLCs and PTs combine to make monitoring and debugging easier than ever. This functionality is further enhanced by Programming Devices like Monitoring Software and Parameter Units.

NS 12 Programmable Terminal



SYSMAC CJ/CS-series PLC

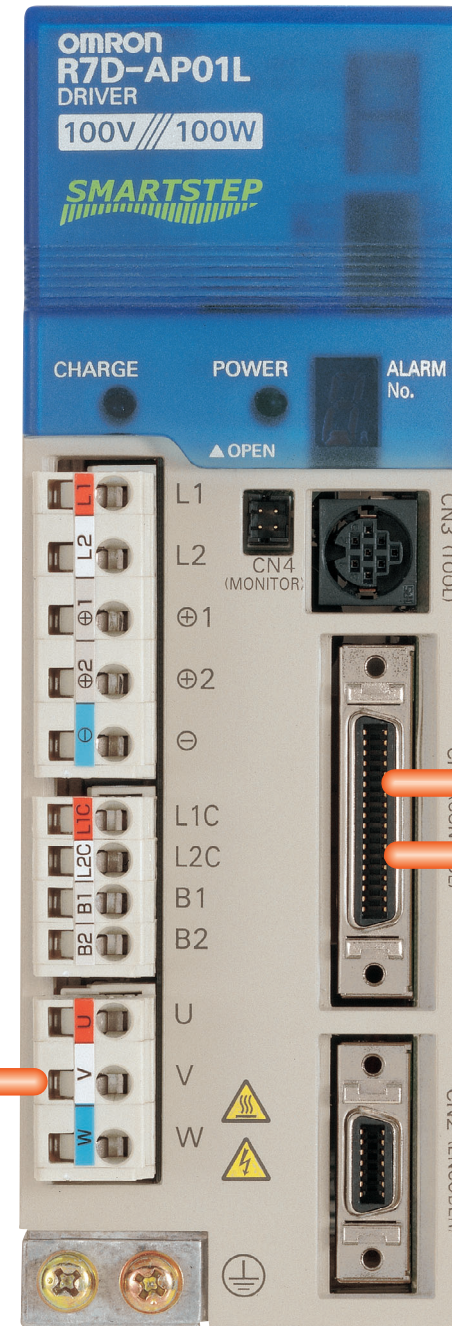

Super-easy

Setup

Basic setup requires no adjustments. Front-panel switches make settings easy and eliminate the need for time-consuming parameter settings whenever adjustment is required. Ease of use is equivalent to that of a stepping motor.



Super-easy

Performance

Positioning is stable because SMARTSTEP prevents out-of-step operation, making high-speed, high-torque, high-precision positioning easier than ever.

● Speed vs. torque comparison for a 100-W motor

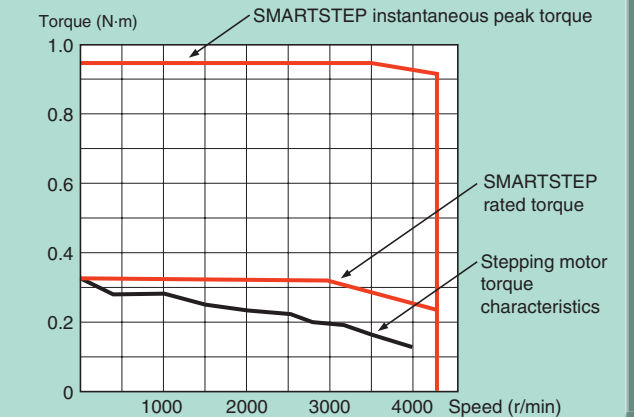

International standards

SMARTSTEP conforms to CE, UL, cUL and other standards for international use.

Flexible System Configurations for a Variety of Applications

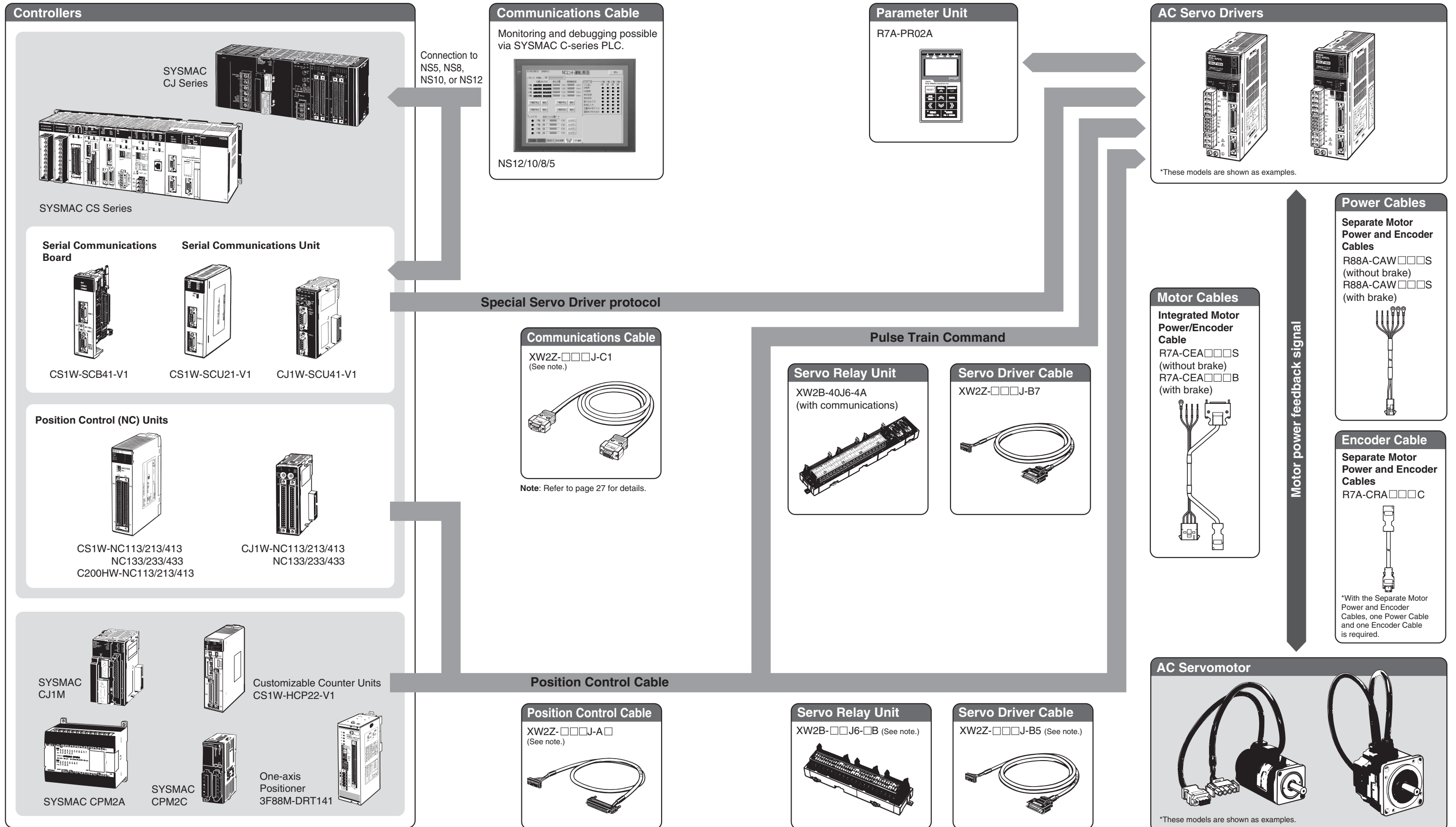

Communications Cable

Monitoring and debugging possible via SYSMAC C-series PLC.

NS12/10/8/5

Parameter Unit

R7A-PR02A

AC Servo Drivers

*These models are shown as examples.

Power Cables

Separate Motor Power and Encoder Cables

R88A-CAW□□□S (without brake)
R88A-CAW□□□S (with brake)

Motor Cables

Integrated Motor Power/Encoder Cable

R7A-CEA□□□S (without brake)
R7A-CEA□□□B (with brake)

Encoder Cable

Separate Motor Power and Encoder Cables

R7A-CRA□□□C

*With the Separate Motor Power and Encoder Cables, one Power Cable and one Encoder Cable is required.

Communications Cable

XW2Z-□□□J-C1 (See note.)

Note: Refer to page 27 for details.

Servo Relay Unit

XW2B-40J6-4A (with communications)

Servo Driver Cable

XW2Z-□□□J-B7

Position Control Cable

XW2Z-□□□J-A□ (See note.)

Note: Refer to page 27 for details.

Servo Relay Unit

XW2B-□□J6-□B (See note.)

Servo Driver Cable

XW2Z-□□□J-B5 (See note.)

AC Servomotor

*These models are shown as examples.

Components and Functions

■ Components

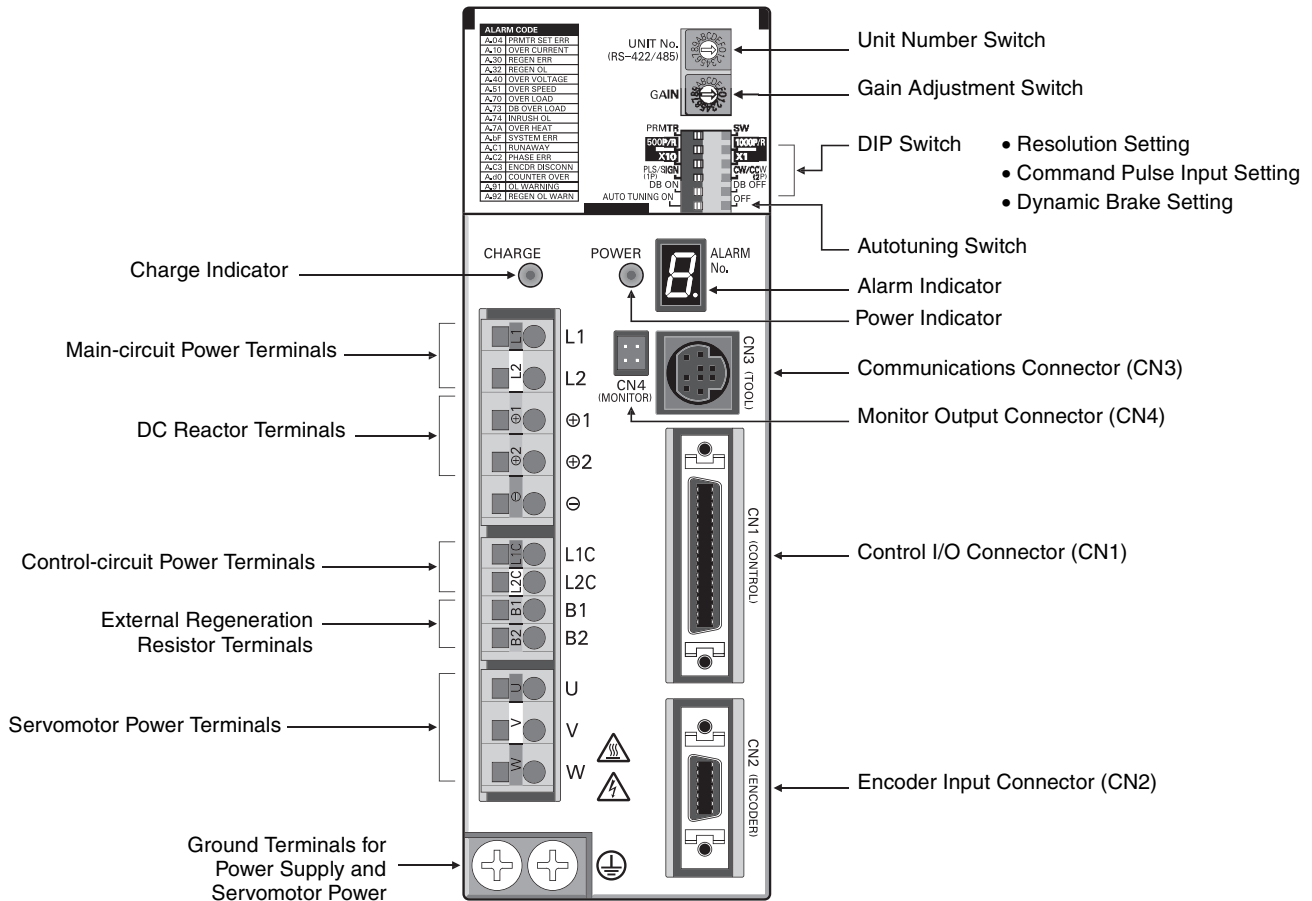

■ Switch Operations

Gain Adjustment Switch

Adjusts the motor's responsiveness.

When this switch is set to 0, the Unit will operate according to the settings in the internal parameters (Pn100, Pn101, Pn102, and Pn401).

When this switch is set to 1 through F, the Unit will operate according to the rotary switch's setting.

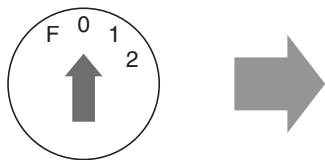

Decrease the switch setting to lower the motor's responsiveness (i.e., so that it moves more smoothly). Increase the switch setting to raise the motor's responsiveness (i.e., so that it moves faster).

Setting	Position Loop Gain	Speed Loop Gain	Speed Loop Integral Constant	Torque Command Filter Time Constant
0	Enables parameter settings (including settings other than gain settings).			
1	15	15	4,000	250
2	20	20	3,500	200
3	30	30	3,000	150
4	40	40	2,000	100
5	60	60	1,500	70
6	85	85	1,000	50
7	120	120	800	30
8	160	160	600	20
9	200	200	500	15
A	250	250	400	10
B	250	250	400	10
C	250	250	400	10
D	250	250	400	10
E	250	250	400	10
F	250	250	400	10

Components and Functions

Enable Switch/Parameter Settings

Pin 6 of the DIP switch selects whether the Servo Driver operates according to the DIP switch settings or parameter settings.

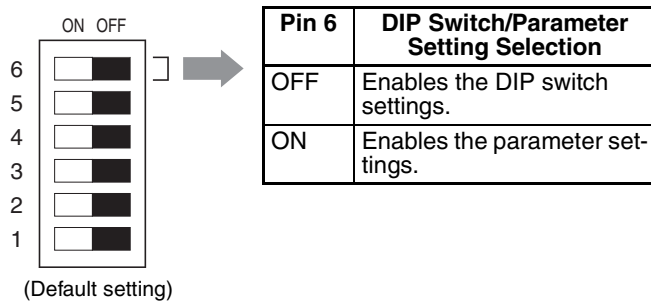

Command Pulse Input Setting

Pin 3 selects the command pulse mode. Select "Forward pulse/Reverse pulse: positive logic" or "Feed pulses/Direction signal: positive logic."

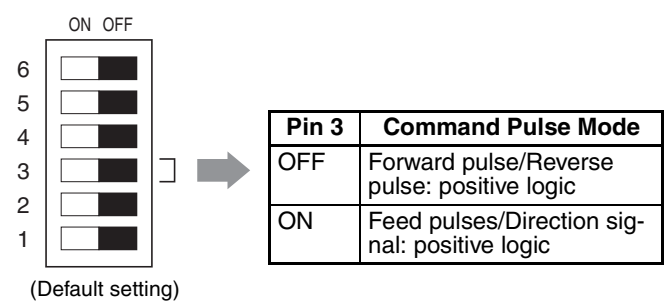

Online Autotuning Setting

The Autotuning Switch selects whether the gain will be adjusted automatically during operation.

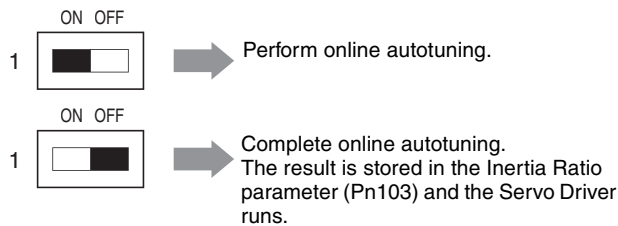

Dynamic Brake Setting

Pin 2 enables or disables dynamic brake operation. If the dynamic brake is enabled, the motor can be brought to an emergency stop when the RUN command goes OFF or an alarm occurs.

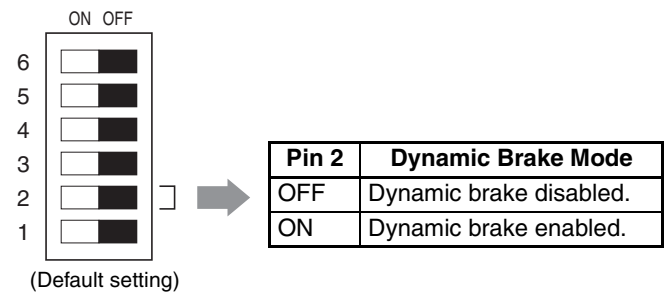

Resolution Setting

Pins 4 and 5 select the positioning resolution. If the resolution is set to 1,000 (the default setting), the motor makes one revolution for every 1,000 pulses input.

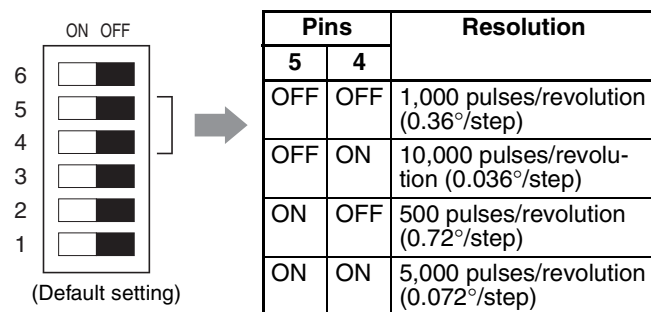

Alarm Table

Display	ALM output	Error detection function
A.04*	OFF	Parameter setting error
A.10*	OFF	Overcurrent
A.30	OFF	Regeneration error
A.32	OFF	Regeneration overload
A.40	OFF	Overvoltage/Undervoltage
A.51	OFF	Overspeed
A.70	OFF	Overload
A.73	OFF	Dynamic brake overload
A.74	OFF	Inrush resistance overload

Display	ALM output	Error detection function
A.7A	OFF	Overheat
A.bF*	OFF	System error
A.C1	OFF	Runaway detected
A.C2*	OFF	Phase not detected
A.C3*	OFF	Encoder disconnect detected
A.d0	OFF	Deviation counter overflow
CPF00	---	Parameter Unit transmission error 1
CPF01	---	Parameter Unit transmission error 2
A.91	---	Overload warning
A.92	---	Regeneration overload warning

* These errors are not cleared by resetting the alarm. The power must be turned ON again to clear the alarm.

Servo Driver Specifications

■ General Specifications

Item		Specification	
Ambient operating temperature		0 to 55°C	
Ambient operating humidity		90% max. (with no condensation)	
Ambient storage temperature		-20 to 85°C	
Ambient storage humidity		90% max. (with no condensation)	
Storage/operating atmosphere		No corrosive gases.	
Vibration resistance		10 to 55 Hz in X, Y, and Z directions with 0.1-mm double amplitude or acceleration of 4.9 m/s ² max., whichever is smaller	
Impact resistance		Acceleration 19.6 m/s ² max., in X, Y, and Z directions, three times	
Insulation resistance		Between power line terminals and case: 0.5 MΩ min. (at 500 V DC)	
Dielectric strength		Between power line terminals and FG: 1,500 V AC for 1 min at 50/60 Hz Between each control signal and FG: 500 V AC for 1 min	
Protective structure		Built into panel (IP10).	
International standards	EC Directives	EMC Directive	EN55011 class A group 1 EN61000-6-2
		Low Voltage Directive	EN50178
	UL Standards		UL508C
	cUL Standards		cUL C22.2 No. 14

■ Performance Specifications

Control Specifications for 100-V AC Input Type

Item	100 V AC				
	30 W	50 W	100 W	200 W	400 W
	R7D-APA3L	R7D-APA5L	R7D-AP01L	R7D-AP02L	R7D-AP04L
Applicable Servomotor (R7M-)	A03030	A05030	A10030 AP10030	A20030 AP20030	A40030 AP40030
Continuous output current (rms)	0.42	0.6	0.89	2.0	2.6
Momentary maximum output current (rms)	1.3	1.9	2.8	6.0	8.0
Control power supply	Single-phase 100/115 V AC (85 to 127 V) 50/60 Hz				
Main-circuit power supply	Single-phase 100/115 V AC (85 to 127 V) 50/60 Hz (Voltage doubler method)				
Control method	All-digital servo				
Speed feedback	2,000 pulses/revolution Incremental Encoder				
Inverter method	PWM method based on IGBT				
PWM frequency	11.7 kHz				
Weight	0.8	0.8	0.8	0.8	1.1
Compatible motor voltage	200 V				
Compatible motor capacity	30 W	50 W	100 W	200 W	400 W
Command pulse response	250 kHz				

Control Specifications for 200-V AC Input Type

Item	200 V AC					
	30 W	50 W	100 W	200 W	400 W	750 W
	R7D-APA3H	R7D-APA5H	R7D-AP01H	R7D-AP02H	R7D-AP04H	R7D-AP08H
Applicable Servomotor (R7M-)	A03030	A05030	A10030 AP10030	A20030 AP20030	A40030 AP40030	A75030 AP75030
Continuous output current (rms)	0.42	0.6	0.89	2.0	2.6	4.4
Momentary maximum output current (rms)	1.3	1.9	2.8	6.0	8.0	13.9
Control power supply	Single-phase 200/230 V AC (170 to 253 V) 50/60 Hz					
Main-circuit power supply	Single-phase 200/230 V AC (170 to 253 V) 50/60 Hz (Three-phase 200/230 V AC can be used with the 750-W model.)					
Control method	All-digital servo					
Speed feedback	2,000 pulses/revolution Incremental Encoder					
Inverter method	PWM method based on IGBT					
PWM frequency	11.7 kHz					
Weight	0.8	0.8	0.8	0.8	1.1	1.7
Compatible motor voltage	200 V					
Compatible motor capacity	30 W	50 W	100 W	200 W	400 W	750 W
Command pulse response	250 kHz					

Servo Driver Specifications

■ I/O Specifications

Terminal Specifications

Symbol	Name	Function
L1 and L2 or L1, L2, and L3	Main-circuit Power Supply Terminals	These are the input terminals for the main-circuit power supply.
⊕1	DC Reactor Terminals	Normally short-circuit between +1 and +2. If harmonic control measures are required, connect a DC Reactor between +1 and +2.
⊕2		
⊖	Main-circuit DC Output	Do not connect anything to this terminal.
L1C L2C	Control Circuit Power Supply Terminals	These are the input terminals for the control power supply.
B1 and B2 or B1, B2, and B3	External Regeneration Resistance Terminals	Connect an External Regeneration Resistor to these terminals if the regenerative capacity of the internal capacitor is exceeded. (An External Regeneration Resistor cannot be connected to the 30 to 200-W models.)
U	Servomotor Terminals	These are the terminals for outputs to the Servomotor.
V		
W		
⊕	Frame ground	This is the ground terminal.

Control I/O (CN1) Specifications

Pin	Symbol	Name	Function/interface
1	+PULS/CW/A	Feed pulses, reverse pulses, or 90° phase difference pulses (A phase)	Line-driver input: 7 mA at 3 V Open-collector input: 7 to 15 mA Input impedance: 200 Ω Maximum response frequency: 250 kpps Position control is performed based on the pulses that have been input.
2	-PULS/CW/A		
3	+SIGN/CCW/B	Direction signal, forward pulses, or 90° phase difference pulses (B phase)	
4	-SIGN/CCW/B		
5	+ECRST	Deviation counter reset	Line-driver input: 7 mA at 3 V Open-collector input: 7 to 15 mA Input impedance: 200 Ω ON: Resets deviation counter.
6	-ECRST		
7	BKIR	Brake interlock output	Outputs holding brake timing signals.
8	INP	Positioning completed output	ON when the position error is within the positioning completed range.
10	OGND	Output ground common	Ground common for output signals (pins 7 and 8).
13	+24V	+24V DC power input for control	Power supply input (+24 V DC) for pins 14 and 18.
14	RUN	RUN command input	ON: Servo ON (Starts power to Servomotor.)
18	RESET	Alarm reset input	ON: Servo alarm status is reset.
19	GND	RS-422A ground	Ground for RS-422A
20	RXD+	RS-422A reception data	Interface for RS-422A data transfers
21	RXD-		
22	TXD+	RS-422A transmission data	
23	TXD-		
24	RT	Termination resistance terminal	Connect to RXD- (pin 21) in the Unit at the end of the line.
32	Z	Encoder phase-Z open-collector output	Output goes ON when the encoder's phase-Z signal (1 pulse/revolution) is detected. Open-collector output: 20 mA max. at 30 V DC
33	ZCOM		
34	ALM	Alarm output	Output goes OFF when alarm is detected. Open-collector output: 50 mA max. at 30 V DC
35	ALMCOM		
Shell	FG	Cable shield ground	Ground for cable's shield wire.

Compatible Connectors

Receptacle at Servo Driver: 10236-52A2JL (Sumitomo 3M) or equivalent

Cable solder plug: 10136-3000VE (Sumitomo 3M)

Cable case: 10336-52A0-008 (Sumitomo 3M)

Servo Driver Specifications

Encoder Connector (CN2) Specifications

Pin	Symbol	Name	Function
1, 2, 3	E0V	Encoder power supply GND	Power supply outlet for encoder
4, 5, 6	E5V	Encoder power supply +5 V	
8	S+	Encoder + phase-S input	Line driver input (conforms to EIA-RS422A) (Input impedance: 220 Ω ± 5%)
9	S-	Encoder - phase-S input	
10	A+	Encoder + phase-A input	Line driver input (conforms to EIA-RS422A) (Input impedance: 220 Ω ± 5%)
11	A-	Encoder - phase-A input	
12	B+	Encoder + phase-B input	Line driver input (conforms to EIA-RS422A) (Input impedance: 220 Ω ± 5%)
13	B-	Encoder - phase-B input	
Shell	FG	Cable shield ground	Ground for cable's shield wire.

Compatible Connectors

Receptacle at Servo Driver: 10214-52AJL (Sumitomo 3M) or equivalent

Cable plug: 10114-3000VE (Sumitomo 3M)

Cable case: 10314-52A0-008 (Sumitomo 3M)

Communications Connector (CN3) Specifications

Pin	Symbol	Name	Function/
1	/TXD	Transmission data	Transmission data: RS-232C output
2	/RXD	Reception data	Reception data: RS-232C input
3	PRMU	Unit switching	Switching terminal for a Parameter Unit
7	+5V	+5 V output	This is the +5 V power supply output to the Parameter Unit.
8	GND	Ground	
Shell	FG	Cable shield ground	Ground for cable's shield wire.

Compatible Connectors

Receptacle at Servo Driver: HR12-10R-8 SDL (Hirose Electric)

Cable connector: HR212-10P-8P (Hirose Electric)

Monitor Output (CN4) Specifications

Pin	Symbol	Name	Function/
1	NM	Speed monitor	Speed monitor output: 1 V per 1,000 r/min
2	AM	Current monitor	Current monitor: 1 V / rated torque
3	GND	Ground	Grounds for monitor output
4	GND	Ground	

Compatible Connectors

Receptacle at Servo Driver: DF11-4DP-2DSA (01) (Hirose Electric)

Cable socket: DF11-4DS-2C (Hirose Electric)

Cable case: DF11-2428SCF (Hirose Electric)

Motor Specifications

■ General Specifications

Item	Specification
Ambient operating temperature	0 to 40°C
Ambient operating humidity	20% to 80% (with no condensation)
Ambient storage temperature	-20 to 60°C
Ambient storage humidity	20% to 80% (with no condensation)
Storage/operating atmosphere	No corrosive gases.
Vibration resistance	10 to 2,500 Hz in X, Y, and Z directions with 0.2-mm double amplitude or acceleration of 24.5 m/s ² max., whichever is smaller
Impact resistance	Acceleration 98 m/s ² max., in a vertical direction, two times
Insulation resistance	Between power line terminals and FG: 10 MΩ min. (at 500 V DC)
Dielectric strength	Between power line terminals and FG: 1,500 V AC for 1 min at 50/60 Hz
Run position	Any direction
Insulation grade	Type B
Structure	Totally-enclosed self-cooling
Protective structure	IP55 for both the Cylindrical and Flat Servomotors
Vibration grade	V-15
Mounting method	Flange-mounting
International standards	Approval obtained for UL, cUL, and EN (EMC directive and low-voltage directive)

■ Performance Specifications

Flat Servomotors

Item	R7M-AP10030	R7M-AP20030	R7M-AP40030	R7M-AP75030	
Applicable Servo Driver (R7D-)	AP01H AP01L	AP02H AP02L	AP04H AP04L	AP08H	
Rated output	100 W	200 W	400 W	750 W	
Rated torque	0.318 N·m	0.637 N·m	1.27 N·m	2.39 N·m	
Rated rotation speed	3,000 r/min	3,000 r/min	3,000 r/min	3,000 r/min	
Momentary maximum rotation speed	4,500 r/min	4,500 r/min	4,500 r/min	4,500 r/min	
Momentary maximum torque	0.96 N·m	1.91 N·m	3.82 N·m	7.1 N·m	
Rated current	0.89 A (rms)	2.0 A (rms)	2.6 A (rms)	4.1 A (rms)	
Momentary maximum current	2.8 A (rms)	6.0 A (rms)	8.0 A (rms)	13.9 A (rms)	
Rotor inertia	6.5×10^{-6} kg·m ²	2.09×10^{-5} kg·m ²	3.47×10^{-5} kg·m ²	2.11×10^{-4} kg·m ²	
Power rate	15.7 kW/s	19.4 kW/s	46.8 kW/s	26.9 kW/s	
Allowable radial load	78 N	245 N	245 N	392 N	
Allowable thrust load	49 N	68 N	68 N	147 N	
Weight	Without brake	0.7 kg	1.4 kg	2.1 kg	
	With brake	0.9 kg	1.9 kg	2.6 kg	
Encoder resolution	2,000 pulses/revolution for phase-A and phase-B, 1 pulse/revolution for phase-Z				
Radiation shield dimensions	t6 × 250 mm square			t12 × 300 mm square	
Brake Specifications	Brake inertia	3.1×10^{-6} kg·m ²	1.52×10^{-5} kg·m ²	1.52×10^{-5} kg·m ²	
	Excitation voltage	24 V DC ±10%			
	Power consumption (at 20°C)	7.5 W	7.6 W	8.2 W	7.5 W
	Current consumption (at 20°C)	0.31 A	0.32 A	0.34 A	0.31 A
	Static friction torque	0.4 N·m min.	0.9 N·m min.	1.9 N·m min.	3.5 N·m min.
	Attraction time	60 ms max.	40 ms max.	60 ms max.	20 ms max.
	Release time	20 ms max.	20 ms max.	20 ms max.	40 ms max.
	Backlash	1°	1°	1°	1°
	Rating	Continuous	Continuous	Continuous	Continuous
	Insulation grade	Type F	Type F	Type F	Type F

Motor Specifications

■ Torque and Rotation Speed Characteristics

Flat Servomotors

The following graphs show the characteristics with a 3-m standard cable and an R7D-AP□L Servo Driver (100-V AC input) or R7D-AP□H Servo Driver (200-V AC input).

R7M-AP10030 (100 W)

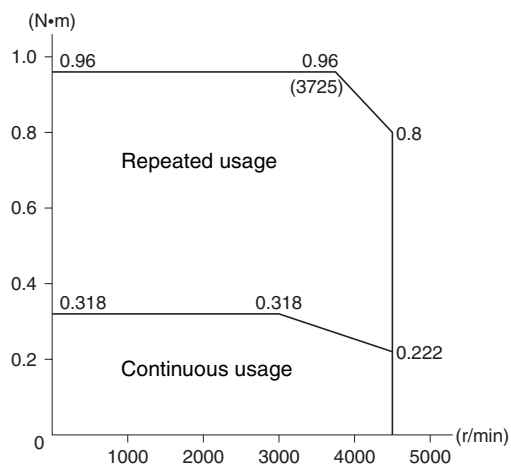

R7M-AP20030 (200 W)

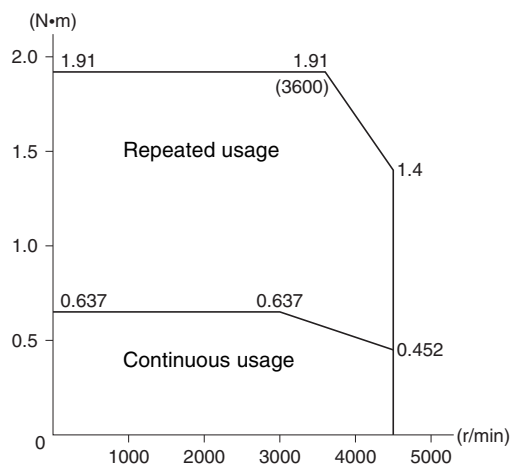

R7M-AP40030 (400 W)

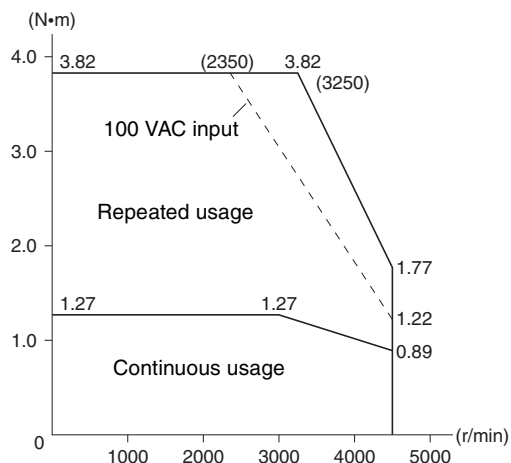

R7M-AP75030 (750 W)

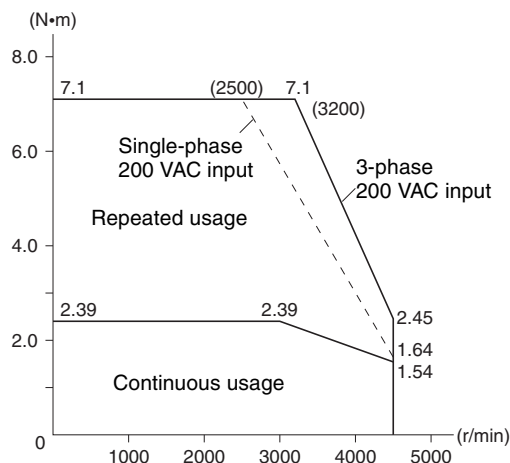

Motor Specifications

■ Performance Specifications

Cylindrical Servomotors

Item	R7M-A03030	R7M-A05030	R7M-A10030	R7M-A20030	R7M-A40030	R7M-A75030	
Applicable Servo Driver (R7D-)	APA3H APA3L	APA5H APA5L	AP01H AP01L	AP02H AP02L	AP04H AP04L	AP08H	
Rated output	30 W	50 W	100 W	200 W	400 W	750 W	
Rated torque	0.095 N·m	0.159 N·m	0.318 N·m	0.637 N·m	1.27 N·m	2.39 N·m	
Rated rotation speed	3,000 r/min	3,000 r/min	3,000 r/min	3,000 r/min	3,000 r/min	3,000 r/min	
Momentary maximum rotation speed	4,500 r/min	4,500 r/min	4,500 r/min	4,500 r/min	4,500 r/min	4,500 r/min	
Momentary maximum torque	0.29 N·m	0.48 N·m	0.96 N·m	1.91 N·m	3.82 N·m	7.1 N·m	
Rated current	0.42 A (rms)	0.6 A (rms)	0.87 A (rms)	2.0 A (rms)	2.6 A (rms)	4.4 A (rms)	
Momentary maximum current	1.3 A (rms)	1.9 A (rms)	2.8 A (rms)	6.0 A (rms)	8.0 A (rms)	13.9 A (rms)	
Rotor inertia	1.7×10^{-6} kg·m ²	2.2×10^{-6} kg·m ²	3.6×10^{-6} kg·m ²	1.19×10^{-5} kg·m ²	1.87×10^{-5} kg·m ²	6.67×10^{-5} kg·m ²	
Power rate	5.31 kW/s	11.5 kW/s	28.1 kW/s	34.1 kW/s	86.3 kW/s	85.6 kW/s	
Allowable radial load	68 N	68 N	78 N	245 N	245 N	392 N	
Allowable thrust load	54 N	54 N	54 N	74 N	74 N	147 N	
Weight	Without brake	0.3 kg	0.4 kg	0.5 kg	1.1 kg	1.7 kg	3.4 kg
	With brake	0.6 kg	0.7 kg	0.8 kg	1.6 kg	2.2 kg	4.3 kg
Encoder resolution	2,000 pulses/revolution for phase-A and phase-B, 1 pulse/revolution for phase-Z						
Radiation shield dimensions	t6 × 250 mm square						
Brake Specifications	Brake inertia	0.85×10^{-6} kg·m ²	0.85×10^{-6} kg·m ²	0.85×10^{-6} kg·m ²	6.4×10^{-6} kg·m ²	6.4×10^{-6} kg·m ²	1.7×10^{-5} kg·m ²
	Excitation voltage	24 V DC ±10% V					
	Power consumption (at 20°C)	6 W	6 W	6 W	7 W	7 W	7.7 W
	Current consumption (at 20°C)	0.25 A	0.25 A	0.25 A	0.29 A	0.29 A	0.32 A
	Static friction torque	0.2 N·m min.	0.2 N·m min.	0.34 N·m min.	1.47 N·m min.	1.47 N·m min.	2.45 N·m min.
	Attraction time	30 ms max.	30 ms max.	30 ms max.	60 ms max.	60 ms max.	60 ms max.
	Release time	60 ms max.	60 ms max.	60 ms max.	20 ms max.	20 ms max.	20 ms max.
	Backlash	1°	1°	1°	1°	1°	1°
	Rating	Continuous	Continuous	Continuous	Continuous	Continuous	Continuous
Insulation grade	Type F	Type F	Type F	Type F	Type F	Type F	

Motor Specifications

■ Torque and Rotation Speed Characteristics

Cylindrical Servomotors

The following graphs show the characteristics with a 3-m standard cable and an R7D-AP□L Servo Driver (100-V AC input.) or R7D-AP□H Servo Driver (200-V AC input.)

R7M-A03030 (30 W)

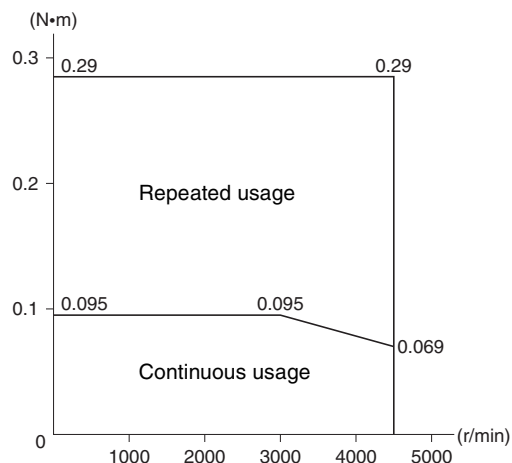

R7M-A05030 (50 W)

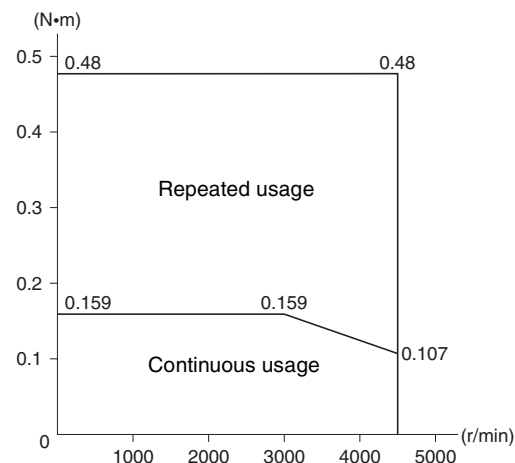

R7M-A10030 (100 W)

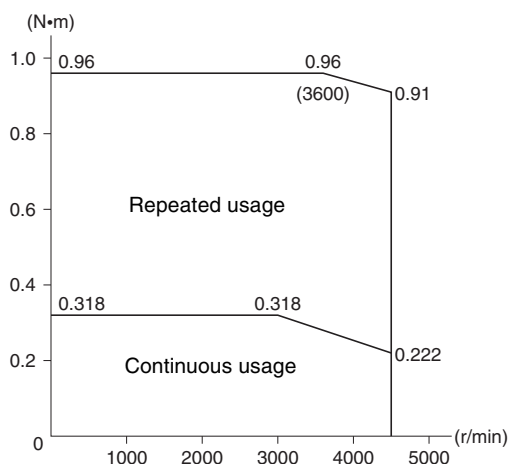

R7M-A20030 (200 W)

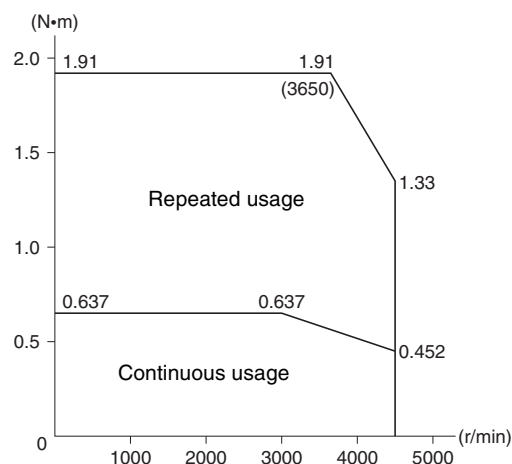

R7M-A40030 (400 W)

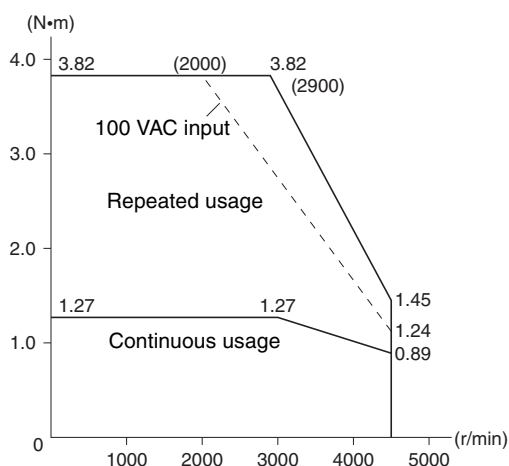

R7M-A75030 (750 W)

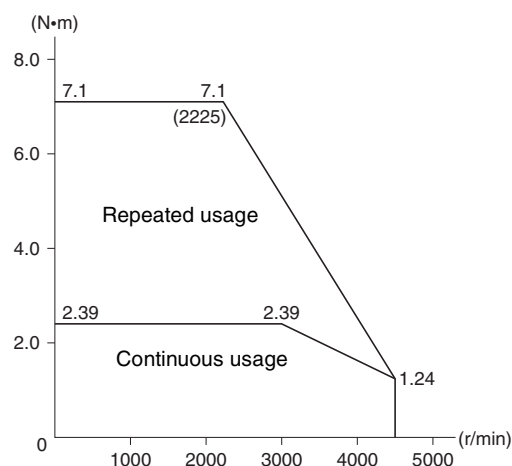

Decelerator Specifications

■ Performance Specifications

Backlash within 45 Minutes

Motor capacity	Deceleration ratio	Model (R7G-)		Rated rotation speed	Rated torque	Efficiency	Instantaneous peak rotation speed	Instantaneous peak torque	Decelerator inertia (See note 1.)	Allowable radial load (shaft center) (See note 4.)	Allowable thrust load
		For Cylindrical Servomotors	For Flat Servomotors								
50 W	1/5	RGSF05B50	---	600	0.517	65	900	1.56	4.13×10^{-6}	392	196
	1/9	RGSF09B50	---	333	0.93	65	500	2.81	3.53×10^{-6}	441	220
	1/15	RGSF15B50	---	200	1.67	70	300	5.04	3.67×10^{-6}	588	294
	1/25	RGSF25B50	---	120	2.78	70	180	8.40	3.59×10^{-6}	686	343
100 W	1/5	RGSF05B100	RGSF05B100P	600	1.19	75	900	3.60	4.08×10^{-6}	392	196
	1/9	RGSF09B100	RGSF09B100P	333	2.29	80	500	6.91	3.43×10^{-6}	441	220
	1/15	RGSF15B100	RGSF15B100P	200	3.82	80	300	11.5	3.62×10^{-6}	588	294
	1/25	RGSF25B100	RGSF25B100P	120	4.02 (See note 2.)	50	180	12.0 (See note 2.)	3.54×10^{-6}	686	343
200 W	1/5	RGSF05B200	RGSF05B200P	600	2.71	85	900	8.12	1.53×10^{-5}	392	196
	1/9	RGSF09C400	RGSF09C400P	333	3.78	66	500	11.3	2.68×10^{-5}	931	465
	1/15	RGSF15C400	RGSF15C400P	200	6.31	66	300	18.9	2.71×10^{-5}	1176	588
	1/25	RGSF25C400	RGSF25C400P	120	11.1	70	180	33.4	2.67×10^{-5}	1323	661
400 W	1/5	RGSF05C400	RGSF05C400P	600	5.4	85	900	16.2	3.22×10^{-5}	784	392
	1/9	RGSF09C400	RGSF09C400P	333	9.49	83	500	28.5	2.68×10^{-5}	931	465
	1/15	RGSF15C400	RGSF15C400P	200	15.8	83	300	47.6	2.71×10^{-5}	1176	588
	1/25	RGSF25C400	RGSF25C400P	120	21.7 (See note 2.)	68	180	65.1 (See note 2.)	2.67×10^{-5}	1323	661
750 W	1/5	RGSF05C750	RGSF05C750P	600	10.8	90	900	32.0	7.17×10^{-5}	784	392
	1/9	RGSF09C750	RGSF09C750P	333	9.7 (See note 2.)	45	500	29.1 (See note 2.)	6.23×10^{-5}	931	465
	1/15	RGSF15C750	RGSF15C750P	200	16.2 (See note 2.)	45	300	48.6 (See note 2.)	6.56×10^{-5}	1176	588
	1/25	RGSF25C750	RGSF25C750P	120	21.7 (See note 2.)	36	180	65.1 (See note 2.)	6.5×10^{-5}	1323	661

- Note:**
1. This inertia is for Cylindrical Servomotors. Refer to the *Flat Servomotor User's Manual* (Cat. No. I533) for applicable inertia for that model.
 2. This torque is for the decelerator. Be sure to select a motor capacity with torque no higher than this value.
 3. This decelerator is for a Servomotor with a straight shaft without a key.
 4. The value given for the allowable radial load is the value at the center of the shaft.

Backlash within 3 Minutes

Motor capacity	Deceleration ratio	Model (R7G-)		Rated rotation speed	Rated torque	Efficiency	Instantaneous peak rotation speed	Instantaneous peak torque	Decelerator inertia (See note 1.)	Allowable radial load (shaft center) (See note 3.)	Allowable thrust load
		For Cylindrical Servomotors	For Flat Servomotors								
50 W	1/5	VRSFPB05B50	---	600	0.517	65	900	1.56	4.13×10^{-6}	392	196
	1/9	VRSFPB09B50	---	333	0.93	65	500	2.81	3.53×10^{-6}	441	220
	1/15	VRSFPB15B50	---	200	1.67	70	300	5.04	3.67×10^{-6}	588	294
	1/25	VRSFPB25B50	---	120	2.78	70	180	8.40	3.59×10^{-6}	686	343
100 W	1/5	VRSFPB05B100	VRSFPB05B100P	600	1.19	75	900	3.60	4.08×10^{-6}	392	196
	1/9	VRSFPB09B100	VRSFPB09B100P	333	2.29	80	500	6.91	3.43×10^{-6}	441	220
	1/15	VRSFPB15B100	VRSFPB15B100P	200	3.82	80	300	11.5	3.62×10^{-6}	588	294
	1/25	VRSFPB25C100	VRSFPB25C100P	120	6.36	80	180	19.2	3.92×10^{-6}	1323	661
200 W	1/5	VRSFPB05B200	VRSFPB05B200P	600	2.71	85	900	8.12	1.53×10^{-5}	392	196
	1/9	VRSFPB09C400	VRSFPB09C400P	333	3.78	66	500	11.3	2.68×10^{-5}	931	465
	1/15	VRSFPB15C400	VRSFPB15C400P	200	6.31	66	300	18.9	2.71×10^{-5}	1176	588
	1/25	VRSFPB25C200	VRSFPB25C200P	120	11.1	70	180	33.4	2.67×10^{-5}	1323	661
400 W	1/5	VRSFPB05C400	VRSFPB05C400P	600	5.40	85	900	16.2	3.22×10^{-5}	784	392
	1/9	VRSFPB09C400	VRSFPB09C400P	333	9.49	83	500	28.5	2.68×10^{-5}	931	465
	1/15	VRSFPB15C400	VRSFPB15C400P	200	15.8	83	300	47.6	2.71×10^{-5}	1176	588
	1/25	VRSFPB25D400	VRSFPB25D400P	120	26.4	83	180	79.3	2.79×10^{-5}	1617	808
750 W	1/5	VRSFPB05C750	VRSFPB05C750P	600	10.8	90	900	32.0	7.17×10^{-5}	784	392
	1/9	VRSFPB09D750	VRSFPB09C750P	333	18.3	85	500	54.3	6.50×10^{-5}	1176	588
	1/15	VRSFPB15D750	VRSFPB15D750P	200	30.5	85	300	90.5	7.09×10^{-5}	1372	686
	1/25	VRSFPB25E750	VRSFPB25E750P	120	50.8	85	180	151	7.05×10^{-5}	2058	1029

- Note:**
1. This inertia is for Cylindrical Servomotors. Refer to the *Flat Servomotor User's Manual* (Cat. No. I533) for applicable inertia for that model.
 2. This decelerator is for a Servomotor with a straight shaft without a key.
 3. The value given for the allowable radial load is the value at the center of the shaft.

Dimensions

■ Servo Drivers

200 V AC: 30 W/50 W/100 W/200 W
 (R7D-APA3H/APA5H/AP01H/AP02H)
100 V AC: 30 W/50 W/100 W/200 W
 (R7D-APA3L/APA5L/AP01L/AP02L)

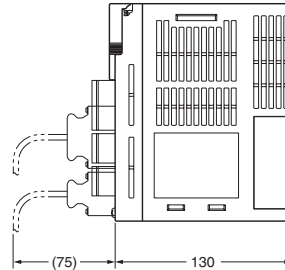
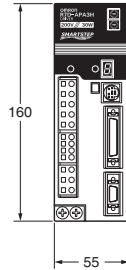

Mounting dimensions

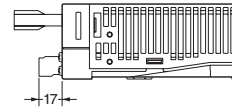
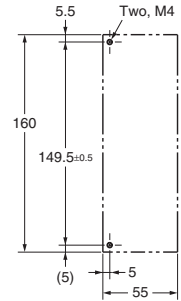

200 V AC: 400 W
 (R7D-AP04H)
100 V AC: 400 W
 (R7D-AP04L)

5 dia. hole

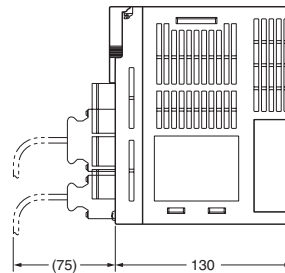
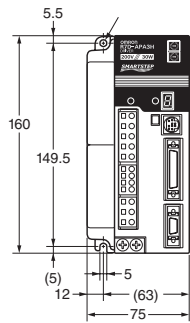

Mounting dimensions

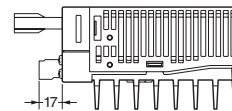
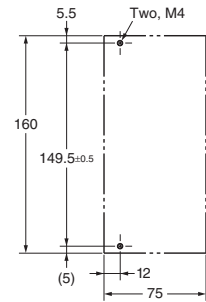

200 V AC: 750 W
 (R7D-AP08H)

5 dia. hole

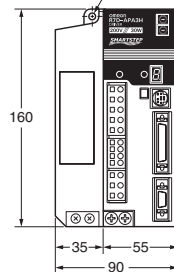
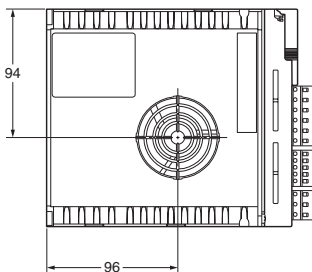

Mounting dimensions

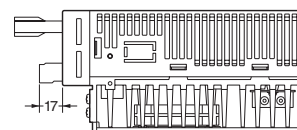
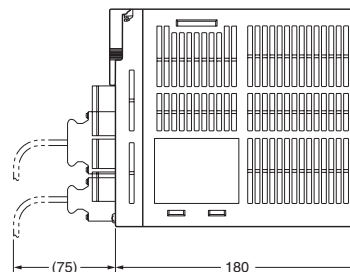
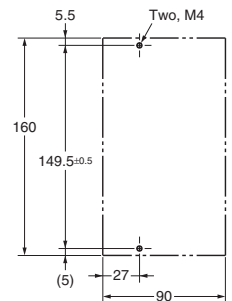

Dimensions

■ Servomotors

Cylindrical Servomotors (3,000 r/min)

200 V AC: 30 W/50 W/100 W/200 W/400 W/750 W

Without Brake: R7M-A03030(-S1)/A05030(-S1)/A10030(-S1)/A20030(-S1)/A40030(-S1)/A75030(-S1)

With Brake: R7M-A03030-B(S1)/A05030-B(S1)/A10030-B(S1)/A20030-B(S1)/A40030-B(S1)/A75030-B(S1)

Model	Dimensions (mm)														
	LL		LR	Flange surface						Axis end					
	Without B	With B		C	D1	D2	F	G	Z	S	QK*	b*	h*	t1*	
R7M-A03030□	69.5	101	25	40	46	30 ^{h7}	2.5	5	Two, 4.3 dia.	6 ^{h6}	14	2	2	1.2	
R7M-A05030□	77	108.5								g ^{h6}		3	3	1.8	
R7M-A10030□	94.5	135								14 ^{h6}		20	5	5	3
R7M-A20030□	96.5	136	30	60	70	50 ^{h7}	3	6	Four, 5.5 dia.	14 ^{h6}	20	5	5	3	
R7M-A40030□	124.5	164								16 ^{h6}					30
R7M-A75030□	145	189.5								40					80

* Dimensions of R7M-A□□□S1(with key)

R7M-A□□□30(-S1) (Without Brake)

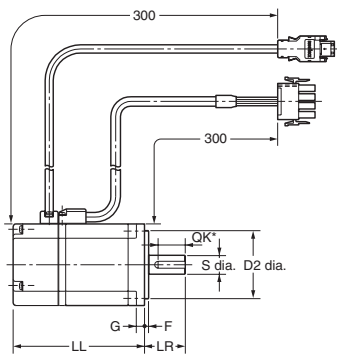

R7M-A□□□30-B(-S1) (With Brake)

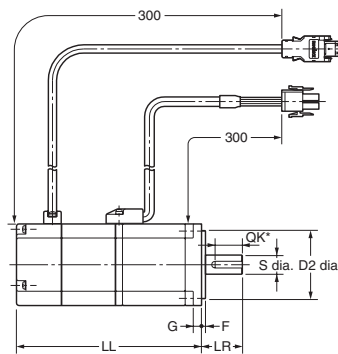

*Axis end dimensions

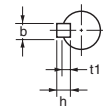

Hole with "Z" mark

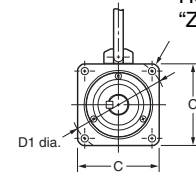

Flat Servomotors (3,000 r/min)

200 V AC: 100 W/200 W/400 W/750 W

Without Brake: R7M-AP10030(-S1)/AP20030(-S1)/AP40030(-S1)/AP75030(-S1)

With Brake: R7M-AP10030-B(S1)/AP20030-B(S1)/AP40030-B(S1)/AP75030-B(S1)

Model	Dimensions (mm)														
	LL		LR	Flange surface						Axis end					
	Without B	With B		C	D1	D2	F	G	Z	S	QK*	b*	h*	t1*	
R7M-AP10030□	62	91	25	60	70	50 ^{h7}	3	6	5.5	8 ^{h6}	14	3	3	1.8	
R7M-AP20030□	67	98.5	30	80	90	70 ^{h7}	3	8	7	14 ^{h6}	16	5	5	3	
R7M-AP40030□	87	118.5								16 ^{h6}					22
R7M-AP75030□	86.5	120								40					120

* Dimensions of R7M-A□□□S1(with key)

R7M-AP□□□30(-S1) (Without Brake)

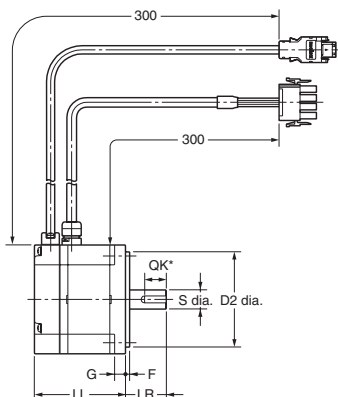

R7M-AP□□□30-B(-S1) (With Brake)

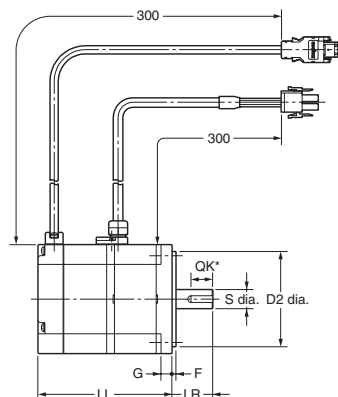

*Axis end dimensions

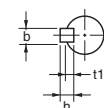

Four, Z-dia. mounting holes

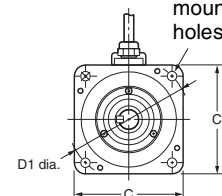

Circuit Diagram

Single-phase 200 to 230 V AC +10%/–15% (50/60 Hz) or Single-phase 100 to 115 V AC +10%/–15% (50/60 Hz)
 (The 750-W Servo Drivers can input three-phase 200 to 230 V AC.)

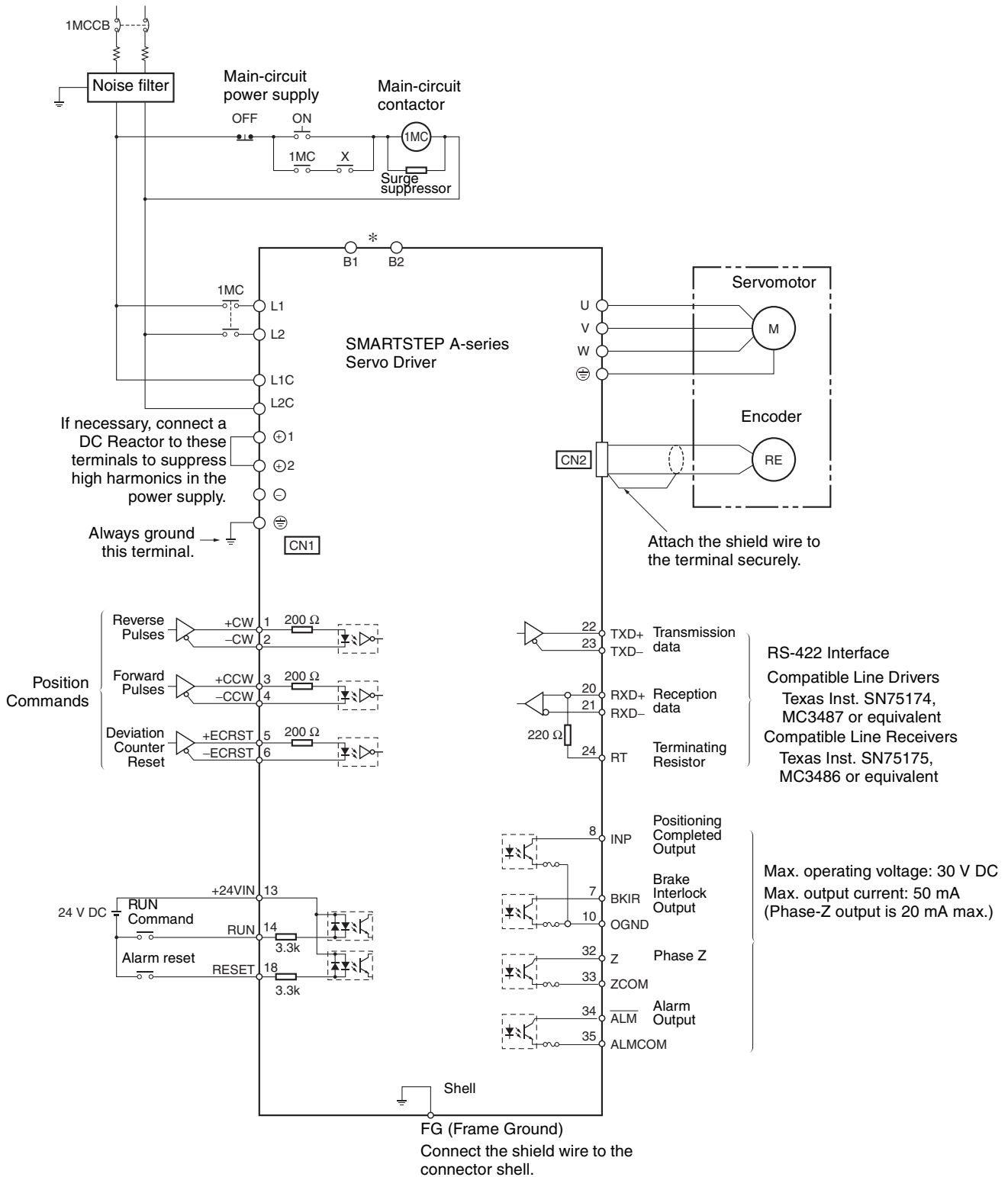

* A Regeneration Resistor can be connected across the B1 and B2 terminals with 400-W and 750-W Servo Drivers. When using an external Regeneration Resistor with a 400-W Servo Driver, just connect it across the B1 and B2 terminals. When using an external Regeneration Resistor with a 750-W Servo Driver, remove the jumper bar from the B2 and B3 terminals and then connect the Regeneration Resistor across the B1 and B2 terminals.

Parameter Specifications

General Specifications

Item	Specification
Ambient operating temperature	0 to 55°C
Ambient operating humidity	90% max. (with no condensation)
Ambient storage temperature	-20 to 85°C
Ambient storage humidity	90% max. (with no condensation)
Storage/operating atmosphere	No corrosive gases.
Vibration resistance	10 to 55 Hz in X, Y, and Z directions with 0.1-mm double amplitude or acceleration of 9.8 m/s ² max., whichever is smaller
Impact resistance	Acceleration 19.6 m/s ² max., in X, Y, and Z directions, three times

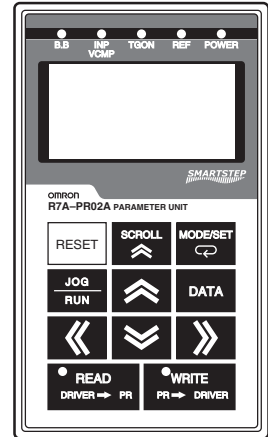

R7A-PR02A

Function Specifications

Item	Function
Setting mode	Display or change parameter settings.
Monitor mode	Display monitor values.
Execute Function mode	Execute each function mode.
Display Alarms	Display alarms that have occurred.
Copy Parameters	Read or save parameters from the Servo Driver. Write parameters to the Servo Driver. Compare parameters in the Servo Driver with parameters in the Parameter Unit.

Mode Change Specifications

Power ON

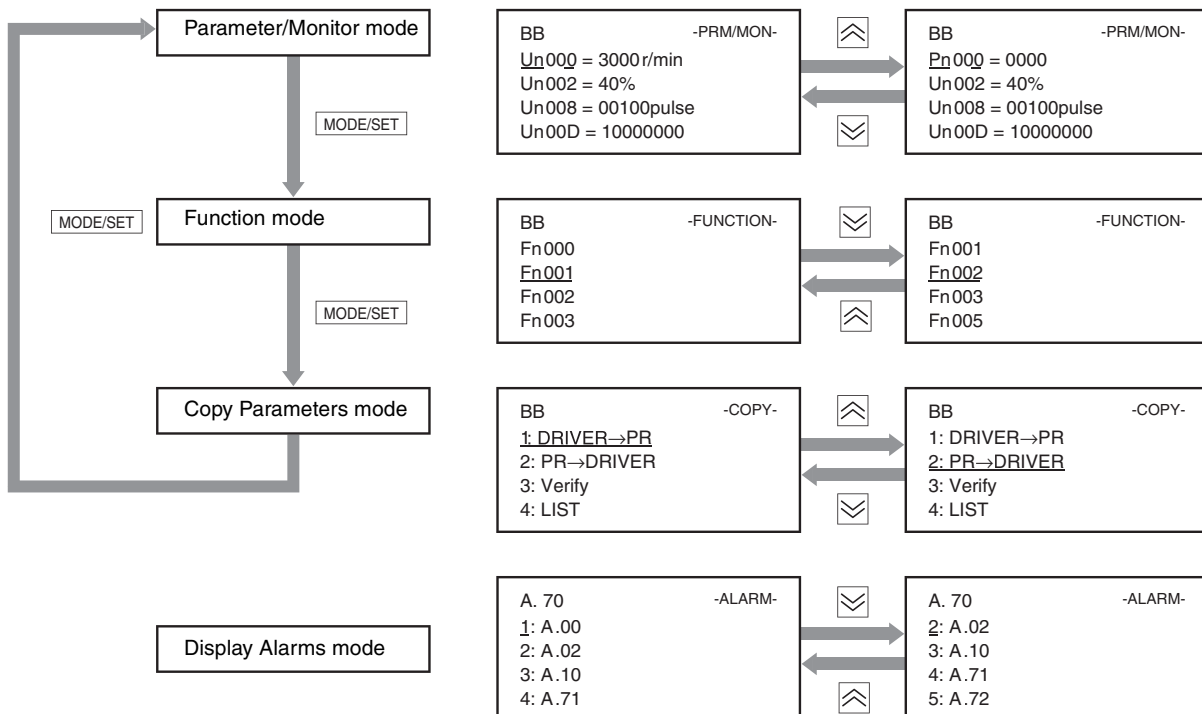

Parameter Specifications

■ Parameter Details

Parameter number	Parameter name	Digit	Name	Setting	Explanation	Default setting	Unit	Setting range
Pn000	Function selection basic switch 1 (See note 1.)	0	Reverse rotation	0	CCW direction is taken for positive command	0010	---	---
				1	CW direction is taken for positive command			
		1	Control mode	1	Position control by pulse train command			
		2 to 3	Not used.	---	---			
Pn001	Function selection basic switch 2 (See note 1.)	0	Select stop method if an alarm occurs when Servomotor is OFF	0	Servomotor stopped by dynamic brake.	1002	---	---
				1	Stop by dynamic brake and release brake after Servomotor stops.			
				2	Servomotor stopped with free run			
		1 to 3	Not used.	---	---			
Pn100	Speed loop gain	Adjusts speed loop's responsiveness.			80	Hz	1 to 2,000	
Pn101	Speed loop integral constant	Speed loop integral time constant			2000	0.01 ms	15 to 51,200	
Pn102	Position loop gain	Adjusts position loop's responsiveness.			40	1/s	1 to 2,000	
Pn103	Inertia ratio	Set using the ratio between the machine system inertia and the Servomotor rotor inertia.			300	%	0 to 10,000	
Pn109	Feed-forward amount	Position control feed-forward compensation value			0	%	0 to 100	
Pn10A	Feed-forward command filter	Sets position control feed-forward command filter.			0	0.01 ms	0 to 6,400	
Pn110	Online autotuning setting (See note 1.)	0	Selects online auto-tuning	0	Auto-tunes initial operations only after power is turned ON.	0012	---	---
				1	Always auto-tunes.			
				2	No auto-tuning			
		1	Not used.	---	---			
		2	Selects adhesive friction compensation function	0	Friction compensation: OFF			
				1	Friction compensation: rated torque ratio small			
				2	Friction compensation: rated torque ratio large			
		3	Not used.	---	---			

Parameter Specifications

Parameter number	Parameter name	Digit	Name	Setting	Explanation	Default setting	Unit	Setting range
Pn200	Position control setting 1 (See note 1.)	0	Command pulse mode	0	Feed pulses/Direction signal: Positive logic	1011	---	---
				1	Forward pulse/Reverse pulse: Positive logic			
				2	90° phase difference (A/B phase) signal (x1): Positive logic			
				3	90° phase difference (A/B phase) signal (x2): Positive logic			
				4	90° phase difference (A/B phase) signal (x4): Positive logic			
				5	Feed pulses/Direction signal: Negative logic			
				6	Forward pulse/Reverse pulse: Negative logic			
				7	90° phase difference (A/B phase) signal (x1): Negative logic			
				8	90° phase difference (A/B phase) signal (x2): Negative logic			
		9	90° phase difference (A/B phase) signal (x4): Negative logic					
		1	Deviation counter reset	0	High level signal			
				1	Rising signal (low to high)			
				2	Low level signal			
3	Falling signal (high to low)							
2	Deviation counter reset if an alarm occurs when the Servomotor is OFF	0	Deviation counter reset if an alarm occurs when Servomotor is OFF.					
		1	Deviation counter not reset if an alarm occurs when Servomotor is OFF.					
		2	Deviation counter reset only if alarm occurs.					
3	Not used.	---	---					
Pn202	Electronic gear ratio G1 (numerator) (See note 1.)	Sets the pulse rate for the command pulses and Servo Servomotor travel distance.			4	---	1 to 65,535	
Pn203	Electronic gear ratio G2 (denominator) (See note 1.)	Setting range: $0.01 \leq G1/G2 \leq 100$			1	---	1 to 65,535	
Pn204	Position command filter time constant 1 (primary filter)	Sets soft start for command pulse. (Soft start characteristics are for the primary filter.)			0	0.01 ms	0 to 6,400	
Pn207	Position control setting 2 (See note 1.)	0	Selects position command filter.	0	Primary filter	0000	---	---
				1	Linear acceleration and deceleration			
		1 to 3	Not used.	---	---			
Pn208	Position command filter time constant 2 (linear acceleration and deceleration) (See note 1.)	Sets soft start for command pulse. (soft start characteristics are for the linear acceleration and deceleration.)			0	0.01 ms	0 to 6,400	
Pn304	Jog speed	Sets rotation speed during jog operation.			500	r/min	0 to 10,000	
Pn401	Torque command filter time constant	Sets the constant when filtering the internal torque command.			40	0.01 ms	0 to 65,535	
Pn402	Forward torque limit	Forward rotation output torque limit (percentage of rated torque ratio).			350	%	0 to 800	
Pn403	Reverse torque limit	Reverse rotation output torque limit (percentage of rated torque ratio).			350	%	0 to 800	
Pn500	Positioning completion range	Sets the range of positioning completed output signal			3	Command units	0 to 250	
Pn505	Deviation counter overflow level	Sets the detection level for the deviation counter over alarm.			1024	×256 command units	1 to 32767	
Pn600	Regeneration resistor capacity (See note 2).	Setting for regeneration resistance load ratio monitoring calculations.			0	10 W	See model specs.	

- Note:**
1. These parameters are read when the power is turned ON. Parameter Pn110.2 is valid when online.
 2. When using a Regeneration Resistor, set the resistor's capacity when the temperature has risen to 120°C. Set this parameter to 0 if a Regeneration Resistor is not being used.

Parameter Specifications

■ Function Mode Details

Number	Name	Explanation
Fn000	Alarm history display	Displays up to 10 alarm entries.
Fn001	Rigidity setting during online auto-tuning	Sets the control target during online auto-tuning.
Fn002	Jog operation	Makes the Servomotor rotate using key operations from the Parameter Unit.
Fn003	Servomotor origin search	Makes the Servomotor rotate using key operations from the Parameter Unit and fixes the position of phase Z after phase Z is detected.
Fn005	User parameter initialization	Restores user parameters to their default settings.
Fn006	Alarm history data clear	Clears the data stored in the alarm history.
Fn007	Store online auto-tuning results	Writes the load data calculated using online auto-tuning to Pn103 (inertia ratio).
Fn00C	Analog monitor output offset manual adjustment	Manually adjusts the analog output monitor offset.
Fn00D	Analog monitor output scaling	Changes the analog monitor output scaling (output voltage adjustment).
Fn00E	Servomotor current detection offset automatic adjustment	Automatically adjusts the offset for Servomotor current detection.
Fn00F	Servomotor current detection offset manual adjustment	Manually adjusts the offset for Servomotor current detection.
Fn010	Password setting	You can permit or prohibit writing to user parameters.
Fn012	Version check	Check the Servo Driver's version information.

■ Monitor Mode Details

Number	Contents	Units	Explanation
Un000	Speed feedback	r/min	Displays actual rotation speed of Servomotor.
Un002	Torque command	%	Displays command values to current loop (rated torque = 100%).
Un003	Number of pulses from phase-Z edge	Pulses	Displays rotation position from phase-Z edge (4X calculation).
Un004	Electrical angle	°	Displays the electrical angle of the Servomotor.
Un005	Input signal monitor	---	Displays the control input signal (CN1) status using ON/OFF bits.
Un006	Output signal monitor	---	Displays the control output signal (CN1) status using ON/OFF bits.
Un007	Command pulse speed display	r/min	Calculates and displays command pulse frequency in r/min.
Un008	Position deviation (deviation counter)	Command units	Displays number of residual pulses in deviation counter (input pulse standard).
Un009	Cumulative load ratio	%	Displays effective torque (rated torque = 100%, 10-s cycle)
Un00A	Regeneration load ratio	%	Displays regeneration absorption power due to regeneration resistance (calculates internal resistance capacity or Pn600 setting as 100% in 10-s cycles).
Un00B	Dynamic brake resistance load ratio	%	Displays power consumption during dynamic brake operation (calculates tolerance power consumption as 100% in 10-s cycles).
Un00C	Input pulse counter	Command units	Counts and displays input pulses (displayed in hexadecimal).
Un00D	Feedback pulse counter	Pulses	Counts and displays feedback pulses (4X calculation, displayed in hexadecimal).

Model Number Legends

AC Servomotors

R7M-A□□□□□□-□□□□
 1 2 3 4 5 6 7

No.	Item	Code	Specification
1	Indicates a Servomotor		
2	Series	A	---
3	Type	Blank	Cylinder motor
		P	Flat motor
4	Motor capacity	030	30 W
		050	50 W
		100	100 W
		200	200 W
		400	400 W
		750	750 W
5	Speed	30	3000 r/min
6	Brake	Blank	No brake
		B	24-V DC brake
7	Shaft	Blank	Straight shaft without key
		S1	Straight shaft with key

AC Servo Drivers

R7M-AP□□□□
 1 2 3 4

No.	Item	Code	Specification
1	Indicates a Servo Driver		
2	Series	AP	---
3	Maximum output capacity	A3	30 W
		A5	50 W
		01	100 W
		02	200 W
		04	400 W
		08	750 W
4	Power supply specification	H	200 VAC
		L	100 VAC

Connecting Cables

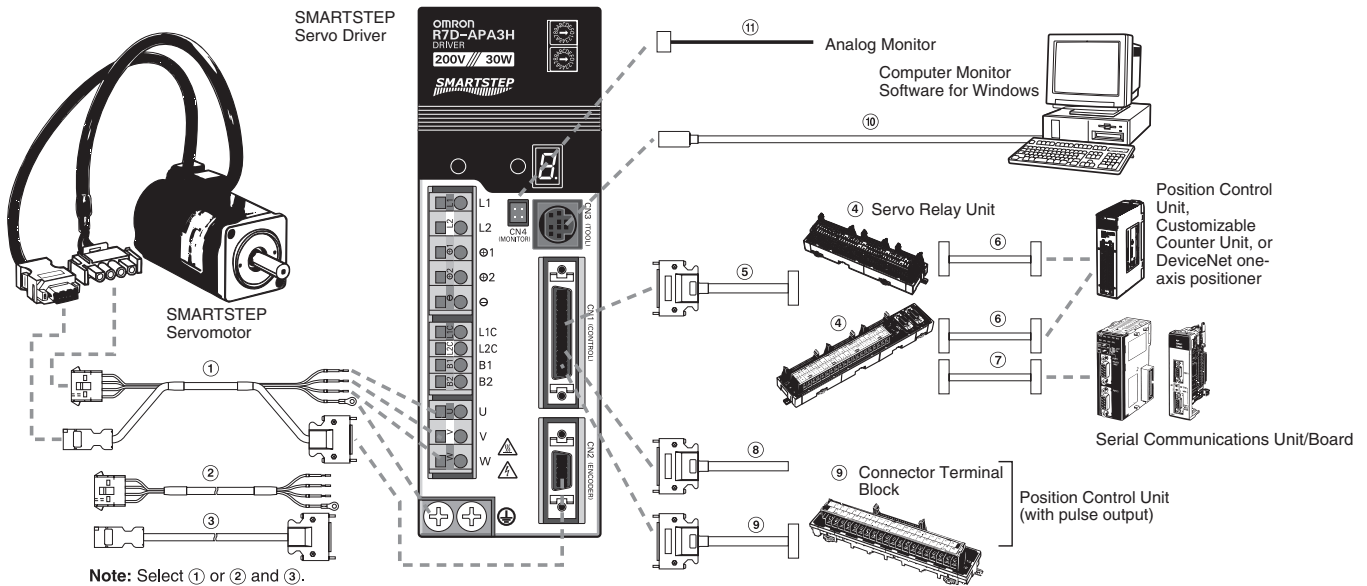



■ Integrated Motor Cables (For CN2)

Symbol	Name	Compatible Servomotors	Model	Description
①	Servomotor Cable (for Servomotor without brake)	R7M-A□□□30 R7M-A□□□30-S1 R7M-AP□□□30 R7M-AP□□□30-S1	R7A-CEA□□□S The boxes in the model number are for the cable length: 1 m, 3 m, 5 m, 10 m, 15 m, or 20 m.	<p>Power Cable Servomotor connector (Taiko Electronics Amp) Connector Cap: 350780-1 Connector Socket: 350570-3</p> <p>Encoder Cable Motor Connector (Molex) Connector: 54280-0800</p> <p>Driver Connector (Sumitomo 3M) Connector Plug: 10114-3000VE Connector Case: 10314-52A0-008</p>
	Servomotor Cable (for Servomotor with brake)	R7M-A□□□30-B R7M-A□□□30-BS1 R7M-AP□□□30-B R7M-AP□□□30-BS1	R7A-CEA□□□B The boxes in the model number are for the cable length: 1 m, 3 m, 5 m, 10 m, 15 m, or 20 m.	<p>Power Cable Servomotor connector (Taiko Electronics Amp) Connector Cap: 350781-1 Connector Socket: 350570-3</p> <p>Encoder Cable Motor Connector (Molex) Connector: 54280-0800</p> <p>Driver Connector (Sumitomo 3M) Connector Plug: 10114-3000VE Connector Case: 10314-52A0-008</p>

Connecting Cables

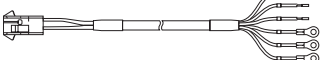
■ Separate Motor Cables (For CN2)

Symbol	Name	Compatible Servomotors	Model	Description
②	Power Cable (for Motor without brake)	R7M-A□□□30 R7M-A□□□30-S1 R7M-AP□□□30 R7M-AP□□□30-S1	R88A-CA-WA□□□S The boxes in the model number are for the cable length: 3 m, 5 m, 10 m, 15 m, or 20 m.	Motor Connector (Tyco Electronics Amp) Connector Cap: 350780-1 Connector Socket: 350570-3 
	Power Cable (for Motor with brake)	R7M-A□□□30-B R7M-A□□□30-BS1 R7M-AP□□□30-B R7M-AP□□□30-BS1	R88A-CA-WA□□□B The boxes in the model number are for the cable length: 3 m, 5 m, 10 m, 15 m, or 20 m.	Motor Connector (Tyco Electronics Amp) Connector Cap: 350781-1 Connector Socket: 350570-3 
③	Encoder Cable	R7M-A□□□30□ R7M-AP□□□30□	R88A-CRA□□□C The boxes in the model number are for the cable length: 3 m, 5 m, 10 m, 15 m, or 20 m.	Motor Connector (Molex) Driver Connector (Sumitomo 3M) Connector Socket: 54280-0800 Connector Plug: 10114-3000VE Crimp Terminal: 10134-52AD-008 

Note: A ② Power Cable and an ③ Encoder Cable are required for Separate Motor Cables.

Ordering Guide

■ Servomotors

Cylindrical Servomotors (3,000-r/min)

Specifications			Model	
Straight shaft without key	Without brake	30 W	R7M-A03030	
		50 W	R7M-A05030	
		100 W	R7M-A10030	
		200 W	R7M-A20030	
		400 W	R7M-A40030	
		750 W	R7M-A75030	
		With brake	30 W	R7M-A03030-B
	50 W		R7M-A05030-B	
	100 W		R7M-A10030-B	
	200 W		R7M-A20030-B	
	400 W		R7M-A40030-B	
	750 W		R7M-A75030-B	
	Straight shaft with key		Without brake	30 W
		50 W		R7M-A05030-S1
100 W		R7M-A10030-S1		
200 W		R7M-A20030-S1		
400 W		R7M-A40030-S1		
750 W		R7M-A75030-S1		
With brake		30 W		R7M-A03030-BS1
		50 W	R7M-A05030-BS1	
		100 W	R7M-A10030-BS1	
		200 W	R7M-A20030-BS1	
		400 W	R7M-A40030-BS1	
		750 W	R7M-A75030-BS1	

Flat Servomotors (3,000-r/min)

Specifications			Model		
Straight shaft without key	Without brake	100 W	R7M-AP10030		
		200 W	R7M-AP20030		
		400 W	R7M-AP40030		
		750 W	R7M-AP75030		
	With brake	100 W	R7M-AP10030-B		
		200 W	R7M-AP20030-B		
		400 W	R7M-AP40030-B		
		750 W	R7M-AP75030-B		
		Straight shaft with key	Without brake	100 W	R7M-AP10030-S1
				200 W	R7M-AP20030-S1
400 W	R7M-AP40030-S1				
750 W	R7M-AP75030-S1				
With brake	100 W		R7M-AP10030-BS1		
	200 W		R7M-AP20030-BS1		
	400 W		R7M-AP40030-BS1		
	750 W		R7M-AP75030-BS1		

■ Servo Drivers

Specifications		Model
200 V AC	30 W	R7D-APA3H
	50 W	R7D-APA5H
	100 W	R7D-AP01H
	200 W	R7D-AP02H
	400 W	R7D-AP04H
	750 W	R7D-AP08H
100 V AC	30 W	R7D-APA3L
	50 W	R7D-APA5L
	100 W	R7D-AP01L
	200 W	R7D-AP02L
	400 W	R7D-AP04L

■ Control Cables (For CN1)

Symbol	Name	Compatible Units	Model	
④	Servo Relay Unit	Use with Position Control Units (Doesn't support communications functions.) Units: CS1W-NC113/133, CJ1W-NC113/133, C200HW-NC113, C200H-NC112, and 3F88M-DRT141	XW2B-20J6-1B	
		Use with Position Control Units (Doesn't support communications functions.) Units: CS1W-NC213/233/413/433, CJ1W-NC213/233/413/433, C200HW-NC213/413, C500-NC113/211, and C200H-NC211	XW2B-40J6-2B	
		Use with Other Units (Doesn't support communications functions.) Units: CS1W-HCP22, CQM1H-PLB21, and CQM1-CPU43-V1	XW2B-20J6-3B	
		Use with Position Control Units. (Supports communications functions.) CS1W-NC213/233/413/433, CJ1W-NC213/233/413/433	XW2B-40J6-4A	
		For CS1W-HCP22-V1 Customizable Counter Unit	XW2B-80J7-1A	
		One-axis Servo Relay Unit for CJ1M-CPU21/22/23 CPU Unit	XW2B-20J6-8A	
		Two-axis Servo Relay Unit for CJ1M-CPU21/22/23 CPU Unit	XW2B-40J6-9A	
⑤	Cable to Servo Driver	Doesn't support communications functions. (For the XW2B-□□J6-□B)	1 m	XW2Z-100J-B5
			2 m	XW2Z-200J-B5
		Supports communications functions. (For the XW2B-40J6-4A)	1 m	XW2Z-100J-B7
			2 m	XW2Z-200J-B7

Ordering Guide

Symbol	Name	Compatible Units	Model	
⑥	Cable to Position Control Unit	CQM1H-PLB21 and CQM1-CPU43-V1	0.5 m	XW2Z-050J-A3
			1 m	XW2Z-100J-A3
		C200H-NC112	0.5 m	XW2Z-050J-A4
			1 m	XW2Z-100J-A4
		C200H-NC211 and C500-NC113/211	0.5 m	XW2Z-050J-A5
			1 m	XW2Z-100J-A5
		CS1W-NC113 and C200HW-NC113	0.5 m	XW2Z-050J-A8
			1 m	XW2Z-100J-A8
		CS1W-NC213/413 and C200HW-NC213/413	0.5 m	XW2Z-050J-A9
			1 m	XW2Z-100J-A9
		CS1W-NC133	0.5 m	XW2Z-050J-A12
			1 m	XW2Z-100J-A12
		CS1W-NC233/433	0.5 m	XW2Z-050J-A13
			1 m	XW2Z-100J-A13
		CJ1W-NC113	0.5 m	XW2Z-050J-A16
			1 m	XW2Z-100J-A16
		CJ1W-NC213/413	0.5 m	XW2Z-050J-A17
			1 m	XW2Z-100J-A17
		CJ1W-NC133	0.5 m	XW2Z-050J-A20
			1 m	XW2Z-100J-A20
CS1W-NC233/433	0.5 m	XW2Z-050J-A21		
	1 m	XW2Z-100J-A21		
CS1W-HCP22-V1	General-purpose I/O Cables	0.5 m	XW2Z-050J-A29	
		1 m	XW2Z-100J-A29	
	Control I/O Cables	0.5 m	XW2Z-050J-A32	
		1 m	XW2Z-100J-A32	
For the 3F88M-DRT141		0.5 m	XW2Z-050J-A25	
		1 m	XW2Z-100J-A25	
	CJ1M-CPU21/22/23, for 2 axes	1 m	XW2Z-100J-A26	
⑦	RS-422 Cable (with the XW2B-40J6-4A only)	1 m	XW2Z-100J-C1	
		2 m	XW2Z-200J-C1	
⑧	Control Cable	For general-purpose Controllers	1 m	R88A-CPU001S
			2 m	R88A-CPU002S
⑨	Connector Terminal Block Cable	For general-purpose Controllers	1 m	R88A-CTU001N
			2 m	R88A-CTU002N
	Connector Terminal Block		---	XW2B-40F5-P

Options for CN3

Symbol	Name	Model
⑩	Computer Monitor Cable	R7A-CCA002P2

Other Options

Symbol	Name	Model
⑪	Analog Monitor Cable	R88A-CMW001S

Motor Cables (Integrated Encoder and Power Cable)

Symbol	Specifications	Model	
①	For Motors without brakes	1 m	R7A-CEA001S
		3 m	R7A-CEA003S
		5 m	R7A-CEA005S
		10 m	R7A-CEA010S
		15 m	R7A-CEA015S
		20 m	R7A-CEA020S
		For Motors with brakes	1 m
	3 m		R7A-CEA003B
	5 m		R7A-CEA005B
	10 m		R7A-CEA010B
	15 m		R7A-CEA015B
	20 m		R7A-CEA020B

Power Cables (Separate Motor Cables)

Symbol	Specifications	Model			
②	Power Cables	For Motors without brakes	3 m	R88A-CAWA003S	
			5 m	R88A-CAWA005S	
			10 m	R88A-CAWA010S	
			15 m	R88A-CAWA015S	
			20 m	R88A-CAWA020S	
			For Motors with brakes	3 m	R88A-CAWA003B
				5 m	R88A-CAWA005B
				10 m	R88A-CAWA010B
				15 m	R88A-CAWA015B
				20 m	R88A-CAWA020B

Encoder Cables (Separate Motor Cables)

Symbol	Specifications	Model	
③	Encoder Cables	3 m	R7A-CRA003C
		5 m	R7A-CRA005C
		10 m	R7A-CRA010C
		15 m	R7A-CRA015C
		20 m	R7A-CRA020C

Ordering Guide

Accessories

■ Connectors

Specifications	Model
Encoder Connector (Motor side)	R7A-CNA02R
Encoder Connector (Driver side)	R7A-CNA01R
Control I/O Connector	R88A-CNU01C

■ Parameter Copy Unit

Specifications	Model
Parameter Unit (with cable)	R7A-PR02A

■ External Regeneration Resistor

Specifications	Model
Resistor	R88A-RR22047S

■ DC Reactor

Specifications	Model
For the R7D-APA3L, R7D-APA5L, or R7D-AP01L	R88A-PX5063
For the R7D-AP02L	R88A-PX5062
For the R7D-APA3H, R7D-APA5H, or R7D-AP01H	R88A-PX5071
For the R7D-AP02H	R88A-PX5070
For the R7D-AP04H	R88A-PX5069
For the R7D-AP04L or R7D-AP08H	R88A-PX5061

■ Front Mounting Bracket

Specifications	Model
Front Mounting Bracket	R88A-TK01W

■ Computer Monitor Software

Specifications	Catalog number
WMON Win Version 2.0	SBCE-011

■ Decelerator (Straight Shaft with Key: Nihon Densan Shinpo)

Cylindrical Servomotor (Backlash within 45 Minutes)

Motor capacity	Model	Deceleration (deceleration ratio)			
		1/5	1/9	1/15	1/25
50 W	R7G-RGSF05B50	○			
	R7G-RGSF09B50		○		
	R7G-RGSF15B50			○	
	R7G-RGSF25B50				○
100 W	R7G-RGSF05B100	○			
	R7G-RGSF09B100		○		
	R7G-RGSF15B100			○	
	R7G-RGSF25B100				○
200 W	R7G-RGSF05B200	○			
	R7G-RGSF09C400		○		
	R7G-RGSF15C400			○	
	R7G-RGSF25C400				○
400 W	R7G-RGSF05C400	○			
	R7G-RGSF09C400		○		
	R7G-RGSF15C400			○	
	R7G-RGSF25C400				○
750 W	R7G-RGSF05C750	○			
	R7G-RGSF09C750		○		
	R7G-RGSF15C750			○	
	R7G-RGSF25C750				○

Cylindrical Servomotor (Backlash within 3 Minutes)

Motor capacity	Model	Deceleration (deceleration ratio)			
		1/5	1/9	1/15	1/25
50 W	R7G-VRSFPB05B50	○			
	R7G-VRSFPB09B50		○		
	R7G-VRSFPB15B50			○	
	R7G-VRSFPB25B50				○
100 W	R7G-VRSFPB05B100	○			
	R7G-VRSFPB09B100		○		
	R7G-VRSFPB15B100			○	
	R7G-VRSFPB25C100				○
200 W	R7G-VRSFPB05B200	○			
	R7G-VRSFPB09C400		○		
	R7G-VRSFPB15C400			○	
	R7G-VRSFPB25C400				○
400 W	R7G-VRSFPB05C400	○			
	R7G-VRSFPB09C400		○		
	R7G-VRSFPB15C400			○	
	R7G-VRSFPB25D400				○
750 W	R7G-VRSFPB05C750	○			
	R7G-VRSFPB09D750		○		
	R7G-VRSFPB15D750			○	
	R7G-VRSFPB25E750				○

Ordering Guide

Flat Servomotor (Backlash within 45 Minutes)

Motor capacity	Model	Deceleration (deceleration ratio)			
		1/5	1/9	1/15	1/25
100 W	R7G-RGSF05F100P	○			
	R7G-RGSF09F100P		○		
	R7G-RGSF15F100P			○	
	R7G-RGSF25F100P				○
200 W	R7G-RGSF05B200P	○			
	R7G-RGSF09C400P		○		
	R7G-RGSF15C400P			○	
	R7G-RGSF25C400P				○
400 W	R7G-RGSF05C400P	○			
	R7G-RGSF09C400P		○		
	R7G-RGSF15C400P			○	
	R7G-RGSF25C400P				○
750 W	R7G-RGSF05C750P	○			
	R7G-RGSF09C750P		○		
	R7G-RGSF15C750P			○	
	R7G-RGSF25C750P				○

Flat Servomotor (Backlash within 3 Minutes)

Motor capacity	Model	Deceleration (deceleration ratio)			
		1/5	1/9	1/15	1/25
100 W	R7G-VRSFPB05B100P	○			
	R7G-VRSFPB09B100P		○		
	R7G-VRSFPB15B100P			○	
	R7G-VRSFPB25C100P				○
200 W	R7G-VRSFPB05B200P	○			
	R7G-VRSFPB09C400P		○		
	R7G-VRSFPB15C400P			○	
	R7G-VRSFPB25C200P				○
400 W	R7G-VRSFPB05C400P	○			
	R7G-VRSFPB09C400P		○		
	R7G-VRSFPB15C400P			○	
	R7G-VRSFPB25D400P				○
750 W	R7G-VRSFPB05C750P	○			
	R7G-VRSFPB09D750P		○		
	R7G-VRSFPB15D750P			○	
	R7G-VRSFPB25E750P				○

Read and Understand this Catalog

Please read and understand this catalog before purchasing the product. Please consult your OMRON representative if you have any questions or comments.

Warranty and Limitations of Liability

WARRANTY

OMRON's exclusive warranty is that the products are free from defects in materials and workmanship for a period of one year (or other period if specified) from date of sale by OMRON.

OMRON MAKES NO WARRANTY OR REPRESENTATION, EXPRESS OR IMPLIED, REGARDING NON-INFRINGEMENT, MERCHANTABILITY, OR FITNESS FOR PARTICULAR PURPOSE OF THE PRODUCTS. ANY BUYER OR USER ACKNOWLEDGES THAT THE BUYER OR USER ALONE HAS DETERMINED THAT THE PRODUCTS WILL SUITABLY MEET THE REQUIREMENTS OF THEIR INTENDED USE. OMRON DISCLAIMS ALL OTHER WARRANTIES, EXPRESS OR IMPLIED.

LIMITATIONS OF LIABILITY

OMRON SHALL NOT BE RESPONSIBLE FOR SPECIAL, INDIRECT, OR CONSEQUENTIAL DAMAGES, LOSS OF PROFITS OR COMMERCIAL LOSS IN ANY WAY CONNECTED WITH THE PRODUCTS, WHETHER SUCH CLAIM IS BASED ON CONTRACT, WARRANTY, NEGLIGENCE, OR STRICT LIABILITY.

In no event shall the responsibility of OMRON for any act exceed the individual price of the product on which liability is asserted.

IN NO EVENT SHALL OMRON BE RESPONSIBLE FOR WARRANTY, REPAIR, OR OTHER CLAIMS REGARDING THE PRODUCTS UNLESS OMRON'S ANALYSIS CONFIRMS THAT THE PRODUCTS WERE PROPERLY HANDLED, STORED, INSTALLED, AND MAINTAINED AND NOT SUBJECT TO CONTAMINATION, ABUSE, MISUSE, OR INAPPROPRIATE MODIFICATION OR REPAIR.

Application Considerations

SUITABILITY FOR USE

OMRON shall not be responsible for conformity with any standards, codes, or regulations that apply to the combination of the product in the customer's application or use of the product.

Take all necessary steps to determine the suitability of the product for the systems, machines, and equipment with which it will be used.

Know and observe all prohibitions of use applicable to this product.

NEVER USE THE PRODUCT FOR AN APPLICATION INVOLVING SERIOUS RISK TO LIFE OR PROPERTY WITHOUT ENSURING THAT THE SYSTEM AS A WHOLE HAS BEEN DESIGNED TO ADDRESS THE RISKS, AND THAT THE OMRON PRODUCT IS PROPERLY RATED AND INSTALLED FOR THE INTENDED USE WITHIN THE OVERALL EQUIPMENT OR SYSTEM.

PROGRAMMABLE PRODUCTS

OMRON shall not be responsible for the user's programming of a programmable product, or any consequence thereof.

Disclaimers

CHANGE IN SPECIFICATIONS

Product specifications and accessories may be changed at any time based on improvements and other reasons. Consult with your OMRON representative at any time to confirm actual specifications of purchased product.

DIMENSIONS AND WEIGHTS

Dimensions and weights are nominal and are not to be used for manufacturing purposes, even when tolerances are shown.

PERFORMANCE DATA

Performance data given in this catalog is provided as a guide for the user in determining suitability and does not constitute a warranty. It may represent the result of OMRON's test conditions, and the users must correlate it to actual application requirements. Actual performance is subject to the OMRON Warranty and Limitations of Liability.