

Trajexia motion control system

TJ1-MC04

TJ1-MC16

QUICK START GUIDE



1	Introduction	4
1.1	About this guide	4
1.2	Overview of this guide	5
1.3	What you need.....	6
2	From box to rail.....	7
2.1	Rules of a Trajexia system	7
2.2	Contents of the boxes	8
2.3	Install the Trajexia system	10
3	Connections	13
3.1	Before work.....	13
3.2	Power Supply Units	13
3.2.1	Recommended Power Supply Unit.....	14
3.2.2	Optional Power Supply Units.....	15
3.3	TJ1-MC__	16
3.4	TJ1-ML__	17
3.4.1	Attach the MECHATROLINK-II Interface Unit to the Servo Driver	18
3.4.2	Connect the 200 V single-phase Servo Driver	19
3.4.3	Connect the 400 V three-phase Servo Driver.....	20
3.4.4	Connect the NS115	21
3.4.5	Set the dipswitches and address of the NS115.....	22
3.5	Complete installation	23
4	Trajexia Tools.....	24
4.1	Minimum PC configuration.....	24
4.2	Install the Trajexia Tools software	24
4.3	Connection to the TJ1-MC__	29
4.4	Create a project for the first time	34
4.5	Complete installation	42
5	More information.....	43
5.1	The Trajexia system	43
5.2	Trajexia highlights.....	44
5.2.1	Direct connectivity via Ethernet	44
5.2.2	Keep your know-how safe	44
5.2.3	Serial port and local I/Os	44
5.2.4	MECHATROLINK-II	44
5.2.5	TJ1-FL02	44
5.2.6	Drivers and inverters	45
5.2.7	Remote I/Os	45

5.2.8	PROFIBUS	45
5.2.9	DeviceNet	45
5.3	Trajexia manuals	45

1 Introduction

This Quick Start Guide intends the user to get familiar quickly with the Trajexia system. This Quick Start Guide explains how to get a single axis moving in a simple desktop set-up by the Trajexia system and a Sigma-II Servo Driver by MECHATROLINK-II.

This Quick Start Guide is intended for personnel with knowledge of electrical systems (electrical engineers or equivalent).

The engineer has to make sure to operate safely with respect to the power (power supply for Trajexia and power for the Servo Driver, which may be 380 VAC) and moving parts of the motor.

When the Trajexia system is used in a real application, the safety warnings and cautions listed in the Hardware Reference Manual must be followed.

For detailed information of the Trajexia system, please refer to the manuals listed in section 5.3.

1.1 About this guide

This Quick Start Guide describes how to connect a Trajexia system to a Sigma-II Servo Driver by MECHATROLINK-II communication. Also the installation of the Trajexia Tools operating software is described, and an example program that controls one servo motor is given.

This Quick Start Guide contains both procedures and descriptive information. Procedure steps that the reader must execute are numbered. All other information is plain text or bulleted text.

1.2 Overview of this guide

Chapter 2 describes how to unpack the boxes and install the Trajexia units on a rail.

Chapter 3 describes how to connect a servo motor to the Trajexia system.

Chapter 4 describes how to connect the Trajexia system to a PC and write an example program to operate the servo motor.

fig. 1

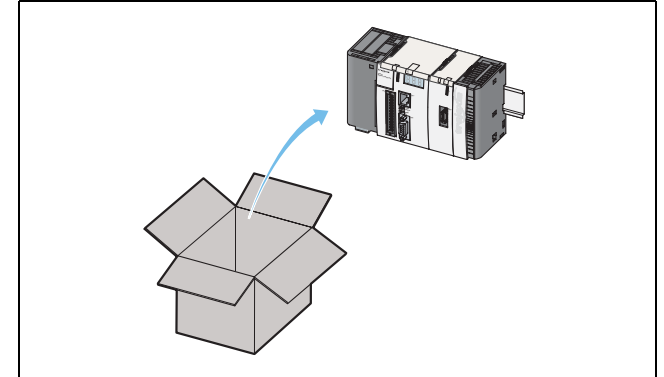

fig. 2

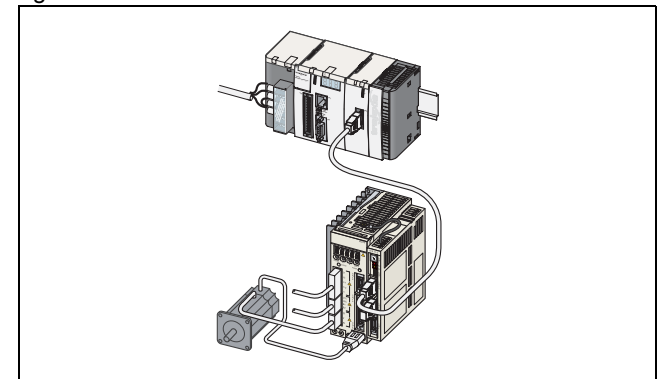
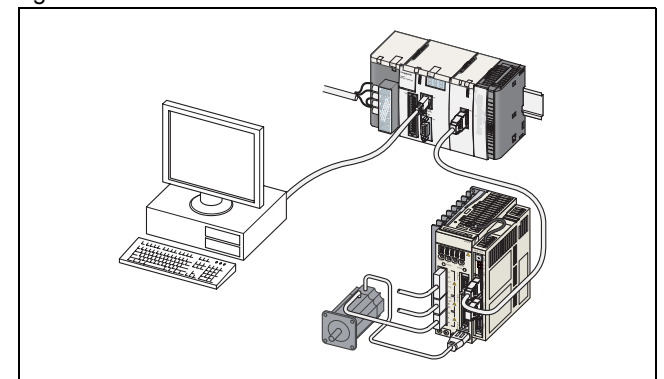

fig. 3



1.3 What you need

You need these items for the installation described in this Quick Start Guide.

1.3.1 Trajexia units

- A Power Supply Unit. This can be one of these:
 - CJ1W-PA202.
 - CJ1W-PA205R.
 - CJ1W-PD025.
- A TJ1-MC__ (Motion Controller Unit). This can be one of these:
 - TJ1-MC04.
 - TJ1-MC16.
- A TJ1-ML__ (MECHATROLINK-II Master Unit). This can be one of these:
 - TJ1-ML04.
 - TJ1-ML16.
- A TJ1-TER (Terminator Unit). Supplied together with the TJ1-MC__ unit.

1.3.2 Other units

- A MECHATROLINK-II Interface Unit (NS115).
- A MECHATROLINK-II cable.
- A MECHATROLINK-II terminator.
- A 200 V single-phase Servo Driver or a 400 V three-phase Servo Driver.
- A servo motor.
- A PC.
- The Trajexia Tools software CD-ROM.
- Power and encoder cables from Servo Driver to motor.

2 From box to rail

This chapter describes the actions needed to attach the units to a DIN rail.

2.1 Rules of a Trajexia system

Before you attach the units together, make sure these rules of attachment are followed:

- The first unit on the left is a Power Supply Unit.
- You must attach one TJ1-MC__ to the Power Supply Unit.
- You can attach no more than seven units plus a TJ1-TER to the TJ1-MC__.
- The last unit must be a TJ1-TER.
- You can install up to four TJ1-ML__ units in the system.
- You can install up to seven TJ1-FL02 units (Flexible Axis Unit) in the system with the TJ1-MC16. You can install up to three TJ1-FL02 units in the system with the TJ1-MC04.
- You can install either one TJ1-PRT (PROFIBUS-DP Slave Unit) or one TJ1-DRT (DeviceNet Slave Unit) in the system.
- You can fit the units between the TJ1-MC__ and the TJ1-TER in any order.

Do not change the positions of the units after programs have been written. Programs can become invalid.

2.2 Contents of the boxes

This section lists the Trajexia units you need for the installation.

2.2.1 Power Supply Unit

The box of the Power Supply Unit contains:

- Safety sheet.
- Power Supply Unit.
- Protection label attached to the top surface of the unit.

2.2.2 TJ1-MC__

The box of the TJ1-MC__ contains:

- Safety sheet.
- TJ1-MC__.
- Protection label attached to the top surface of the TJ1-MC__.
- TJ1-TER, attached to the TJ1-MC__.
- Parts for a serial connector.
- Parts for an I/O connector.
- Two metal DIN-rail clips, to prevent the Trajexia system from sliding off the rail.
- White clip, to replace the yellow clip of the Power Supply Unit.

2.2.3 TJ1-ML__

The box of the TJ1-ML__ contains:

- Safety sheet.
- TJ1-ML__.
- Protection label attached to the top surface of the unit.

2.2.4 Software

The software box contains:

- Trajexia Tools CD-ROM.
- Label with the software licence number, attached to the CD jewel case.
- Warranty Registration Form card.

- Address labels.
- Licence envelope.

2.3 Install the Trajexia system

1. Remove all the units from the packaging. Make sure all units are complete.
2. Do not remove the protection labels from the units.
3. To disconnect the TJ1-MC__ and the TJ1-TER, push the clips (A) on top and bottom of the TJ1-TER to the front.
4. Disconnect the TJ1-TER from the TJ1-MC__.
5. Push the clips (A) on top and bottom of all the units to the front.

fig. 1

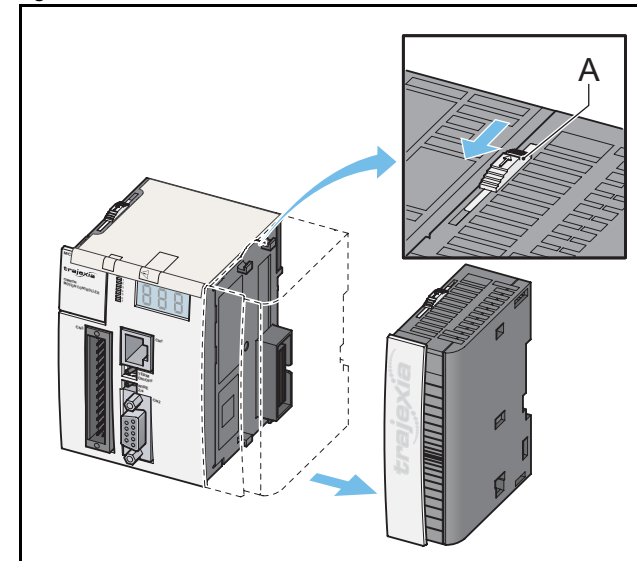
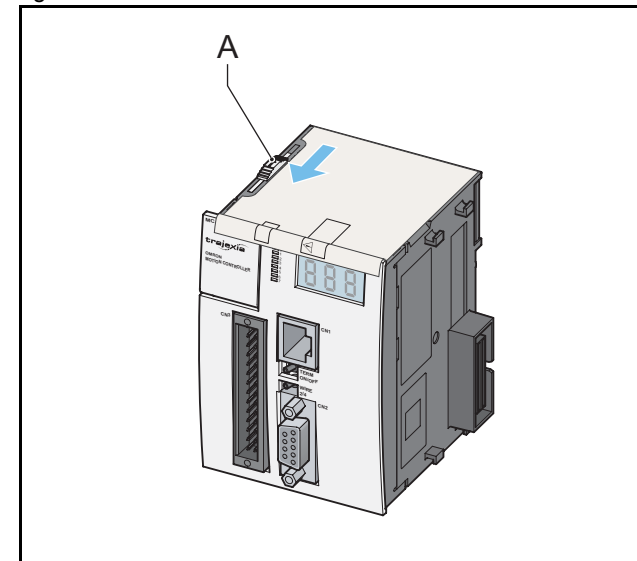
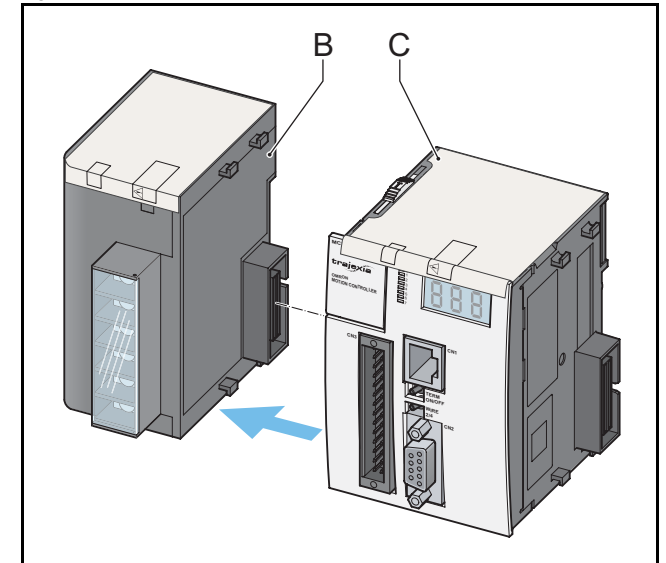

fig. 2



6. Attach the TJ1-MC__ (C) to the Power Supply Unit (B).

fig. 3



7. Push the clips (A) on top and bottom to the rear.

fig. 4

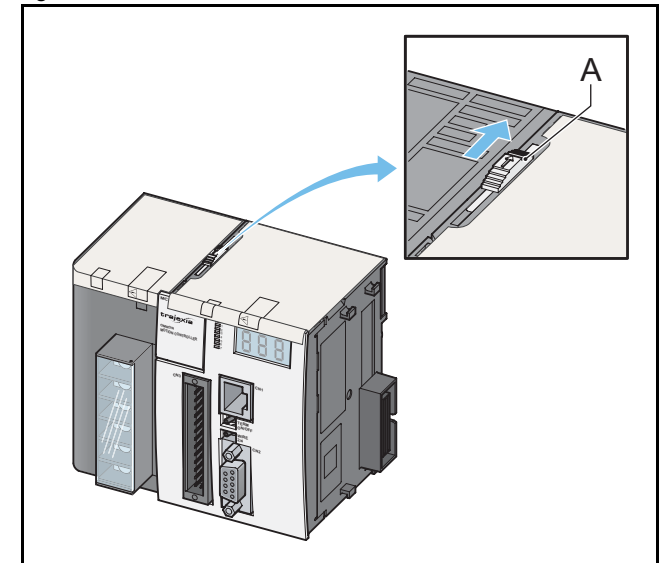

8. Repeat the previous two steps for all other units.
9. Make sure the last unit is the TJ1-TER.

10. Pull down all the clips (D) on all units.
11. Attach the Trajexia system to the DIN rail.
12. Push all the clips (D) up on all units.

fig. 5

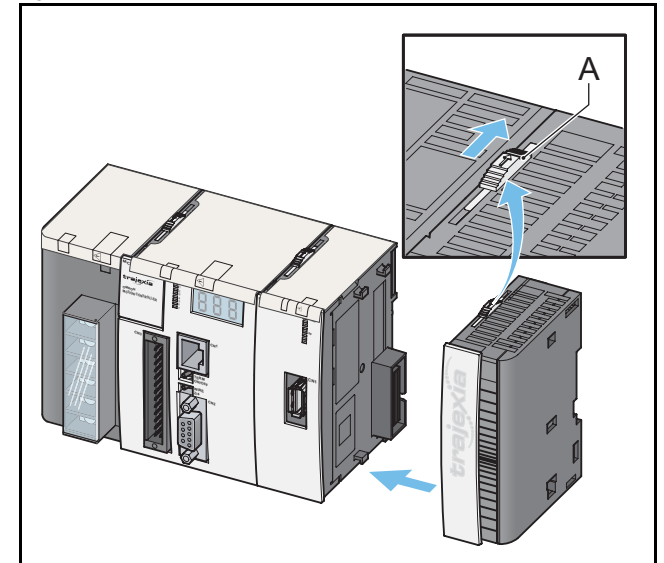
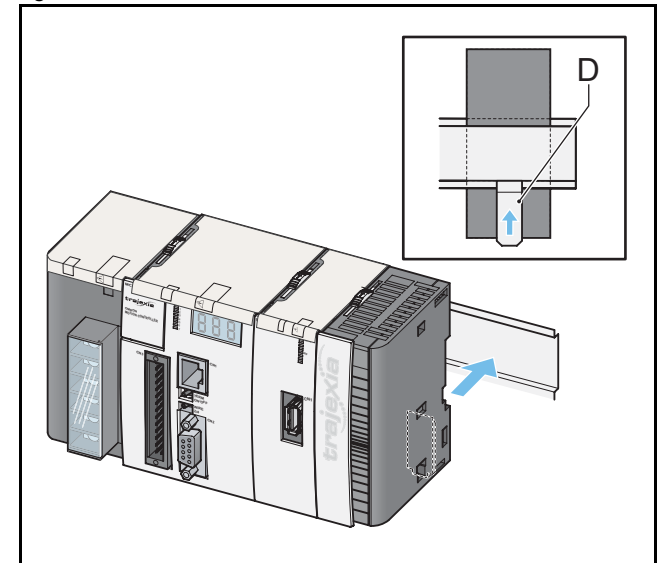

fig. 6



3 Connections

This chapter describes the connections of the Trajexia units.

3.1 Before work

In this desktop environment the emergency stops, interlock circuits and limit switches are not installed.



Caution

The electrical engineer has to make sure to operate safely with respect to the power (power supply for Trajexia and power for the Servo Driver, which may be 380 VAC) and moving parts of the motor.

3.2 Power Supply Units

You can use three different types of Power Supply Unit:

Power Supply Unit	Current	Input voltage	Operating voltage limits	Operating frequency limits	Output power
CJ1W-PA202	AC	110 - 240 V	85 - 264 V	47 - 63 Hz	14 W
CJ1W-PA205R	AC	110 - 240 V	85 - 264 V	47 - 63 Hz	25 W
CJ1W-PD025	DC	24 V	21.6 - 26.4 V	N/A	25 W

3.2.1 Recommended Power Supply Unit

The recommended Power Supply Unit is the CJ1W-PA202.

1. Connect the CJ1W-PA202 Power Supply Unit as follows:

Terminal	Description	Connection
A	110 - 240 V power supply	Live VAC
B	110 - 240 V power supply	Live VAC
C	Line earth	Short-circuit to terminal D
D	Earth	<ul style="list-style-type: none"> Short-circuit to terminal C Earth

fig. 1

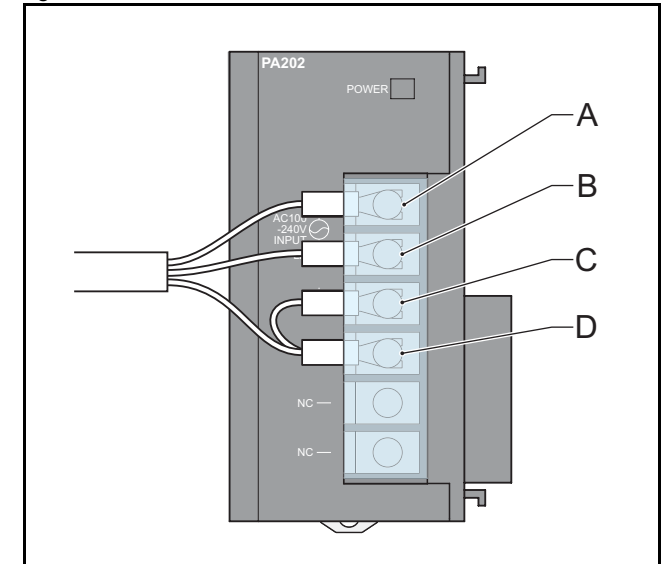

3.2.2 Optional Power Supply Units

1. Connect the CJ1W-PA205R Power Supply Unit as follows:

Terminal	Description	Connection
A	110 - 240 V power supply	Live VAC
B	110 - 240 V power supply	Live VAC
C	Line earth	Short-circuit to terminal D
D	Earth	<ul style="list-style-type: none"> Short-circuit to terminal C Earth

fig. 2

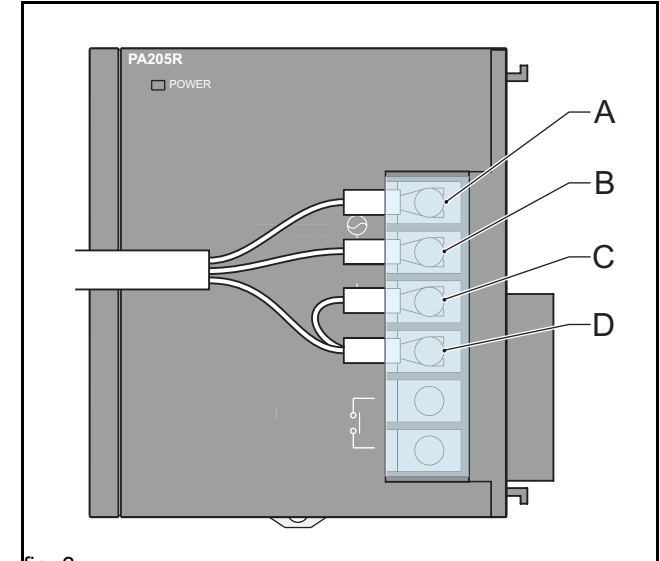

1. Connect the CJ1W-PD025 Power Supply Unit as follows:

Terminal	Description	Connection
A	24 V power supply	24 VDC
B	0 V power supply	0 V
C	Line earth	Short-circuit to terminal D
D	Earth	<ul style="list-style-type: none"> Short-circuit to terminal C Earth

fig. 3

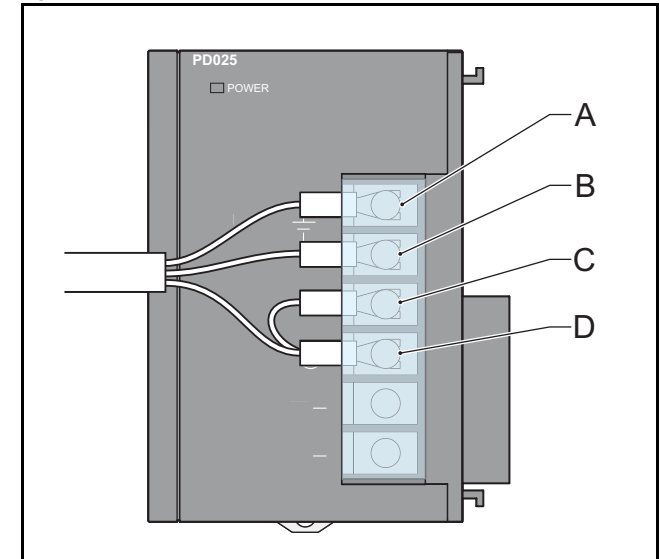

3.3 TJ1-MC__

3.3.1 Ethernet port

If you set the power of the Trajexia system on, the three-digit LED display (A) shows the IP address and the subnet mask of the TJ1-MC__.

Use the Ethernet port (B) to connect the TJ1-MC__ to a PC. You can use both a crossover and a patch Ethernet cable. If you connect the PC directly to the TJ1-MC__, and not via a hub or any other network device, the PC must have a fixed IP address.

The TJ1-MC__ automatically detects when you insert an Ethernet cable into the Ethernet port. When you insert an Ethernet cable into the Ethernet port, the LED display (A) shows the IP address of the TJ1-MC__.

3.3.2 Serial port

The serial port (D) is used to connect the TJ1-MC__ to a device that needs serial connection. It is described in the Hardware Reference Manual. You do not need this port in the example installation.

3.3.3 28-Pin I/O port

The 28-pin I/O port (C) contains 16 digital inputs and 8 digital outputs. It is described in the Hardware Reference Manual. You do not need this port in the example installation.

fig. 4

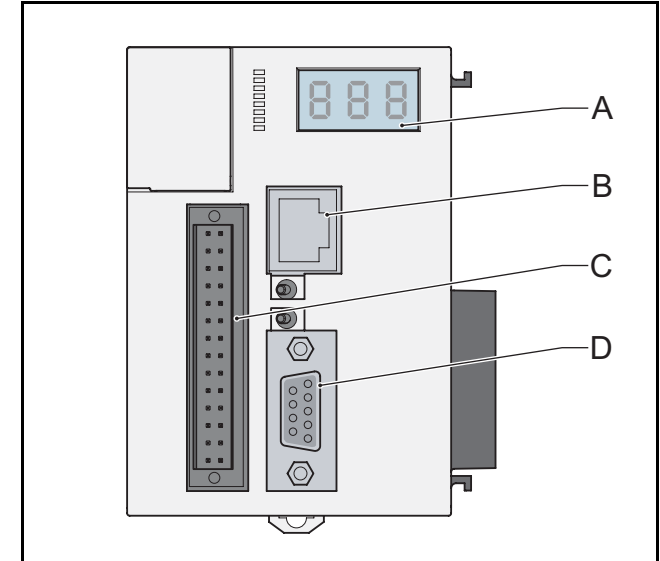

3.4 TJ1-ML__

The TJ1-ML__ is the master of a number of MECHATROLINK-II devices. MECHATROLINK-II devices are Servo Drivers, I/Os or inverters. I/Os and inverters are described in the Hardware Reference Manual.

The TJ1-ML__ has one port (A) to connect it to the first MECHATROLINK-II device.

fig. 5

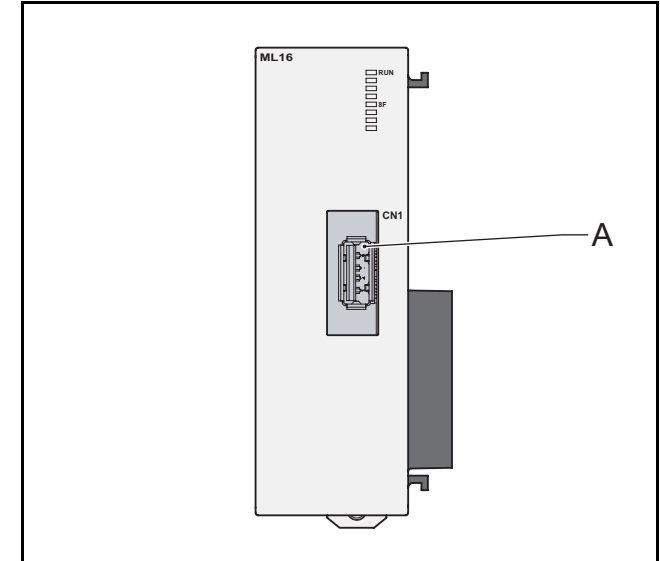

3.4.1 Attach the MECHATROLINK-II Interface Unit to the Servo Driver

You can use a 200 V single-phase Servo Driver (see page 19) or a 400 V three-phase Servo Driver (see page 20).

1. Insert the clips (A) of the MECHATROLINK-II Interface Unit (NS115) into the openings (B) of the Servo Driver.
 2. Make sure the port (C) of the Servo Driver is located opposite to the slot of the NS115.
 3. Insert the clip (D) of the NS115 into the opening (E) of the Servo Driver.
-
4. Connect the earth wire (F) of the NS115 to the point marked **G** (G) on the Servo Driver.

fig. 6

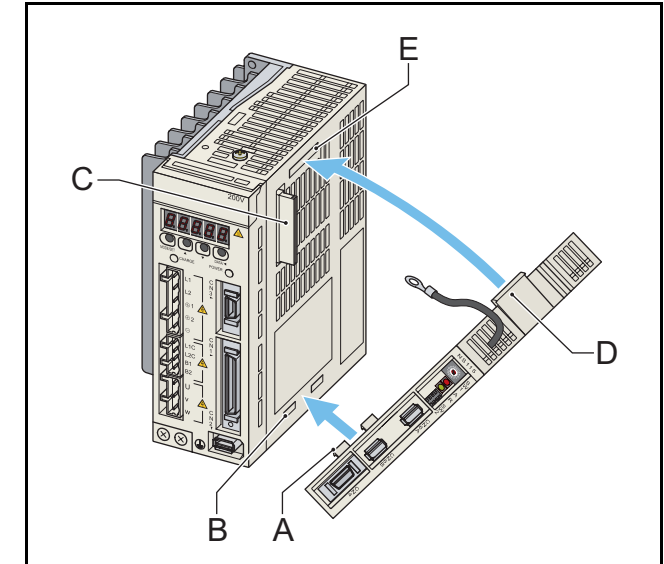
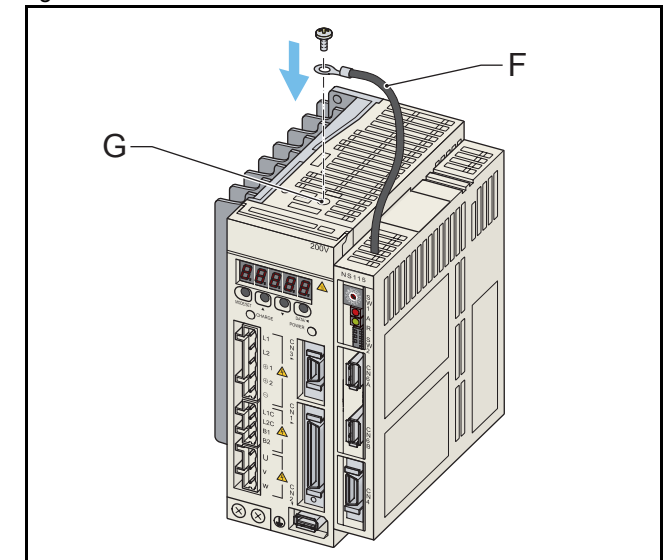

fig. 7



3.4.2 Connect the 200 V single-phase Servo Driver

- The terminals in group A are for the mains supply input that is used to generate power output to the motor (group C). Connect the terminals as follows:

Terminal	Description	Connection
D, E	200 - 230 V power supply	Live VAC
F	+DC bus 1	Short-circuit to terminal G
G	+DC bus 2	Short-circuit to terminal F

- The terminals in group B are for the mains supply input for the internal power needs of the Servo Driver (display, LEDs). Connect the terminals as follows:

Terminal	Description	Connection
H	200 - 230 V control supply	Live VAC
I	200 - 230 V control supply	Live VAC

- The terminals in group C are terminals for the power output to the motor. Connect the terminals as follows:

Terminal	Description	Connection
U	Motor phase U	The U terminal on the motor
V	Motor phase V	The V terminal on the motor
W	Motor phase W	The W terminal on the motor

- Connect the encoder input port (J) to the servo motor encoder cable.

fig. 8

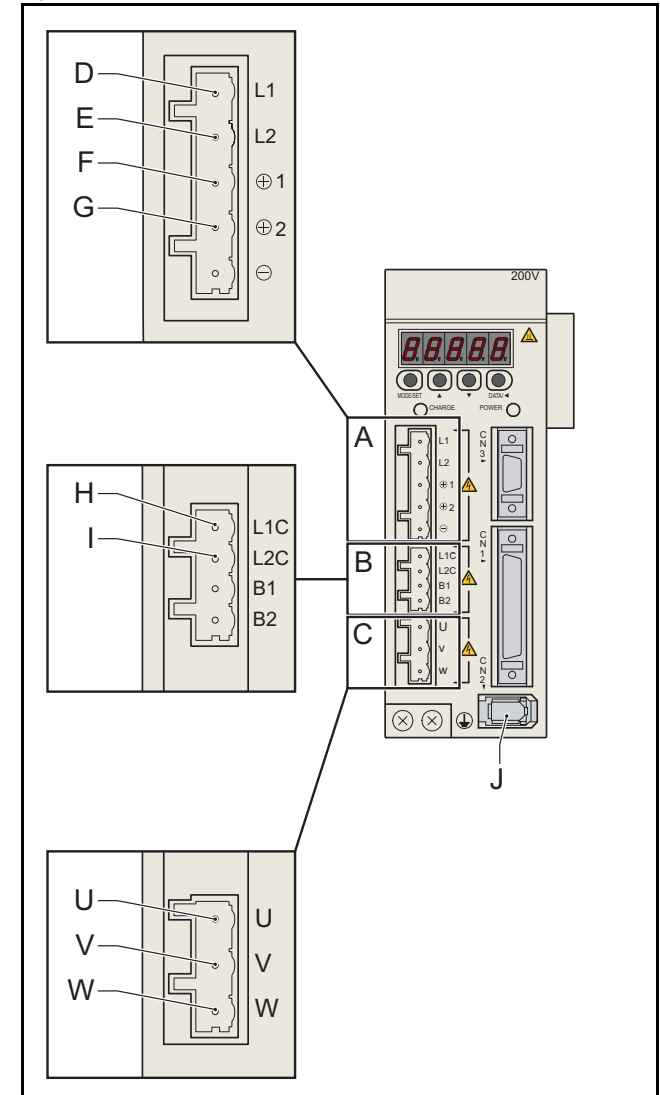

3.4.3 Connect the 400 V three-phase Servo Driver

- The terminals in group A are for the mains supply input that is used to generate power output to the motor (group C). Connect the terminals as follows:

Terminal	Description	Connection
D, E, F	400 V three-phase power supply	Live VAC
G	+DC bus 1	Short-circuit to terminal H
H	+DC bus 2	Short-circuit to terminal G

- The terminals in group B are for the mains supply input for the internal power needs of the Servo Driver (display, LEDs). Connect the terminals as follows:

Terminal	Description	Connection
I	Control supply	24 VDC
J	Control supply	0 VDC
K	Common for regenerative resistance	Short-circuit to terminal L ¹
L	Internal regenerative resistance	Short-circuit to terminal K ¹

1. If the internal resistor is used.

- The terminals in group C are terminals for the power output to the motor. Connect the terminals as follows:

Terminal	Description	Connection
U	Motor phase U	The U terminal on the motor
V	Motor phase V	The V terminal on the motor
W	Motor phase W	The W terminal on the motor

- Connect the encoder input port (M) to the servo motor encoder cable.

fig. 9

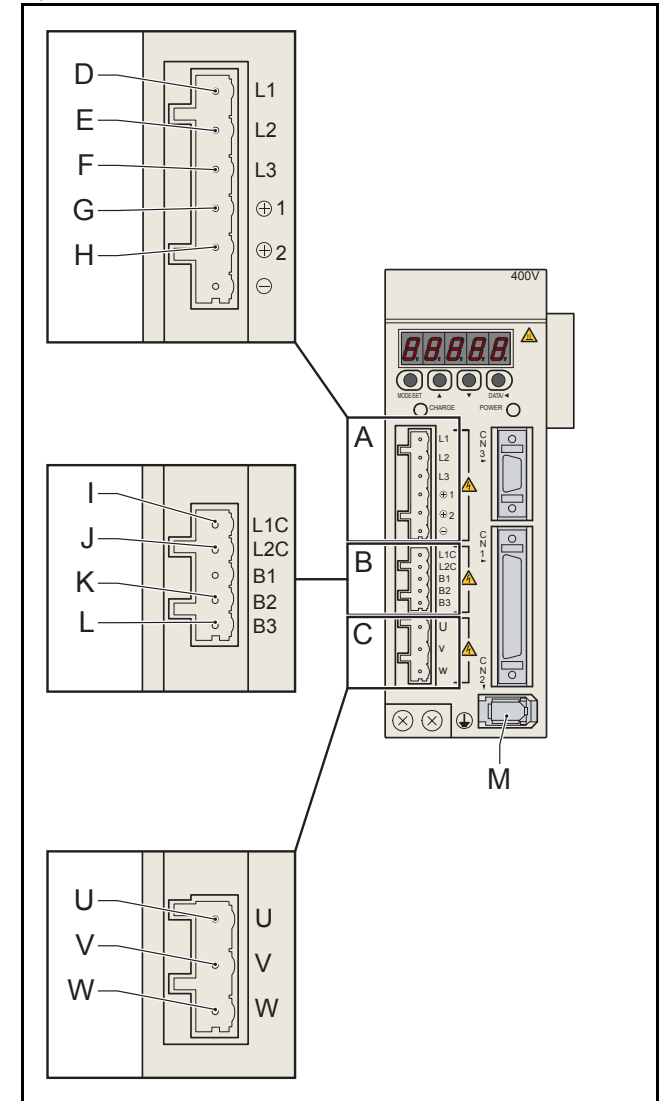

3.4.4 Connect the NS115

The NS115 has one dipswitch, one address selector, and two MECHATROLINK-II bus ports.

Port or switch	Description
A	Address selector
B	Dipswitch
C	MECHATROLINK-II bus ports

1. Connect a MECHATROLINK-II cable (E) to the TJ1-ML__ (D) and to one of the bus ports of the NS115.
2. Connect a MECHATROLINK-II terminator (F) to the other bus port of the NS115.

fig. 10

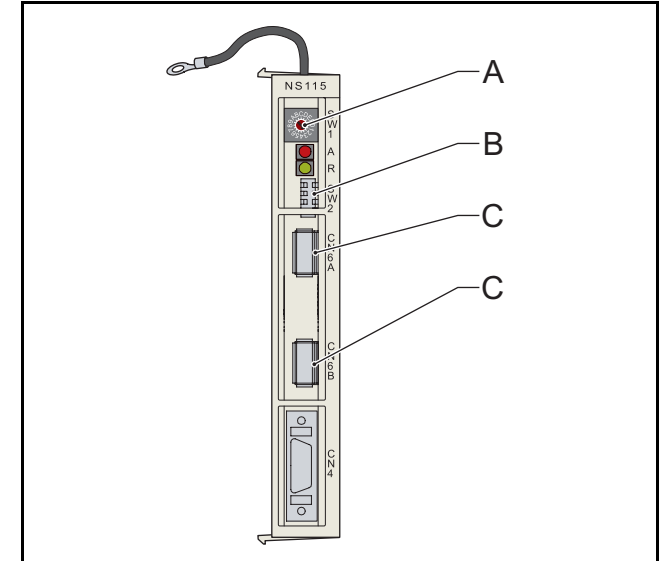
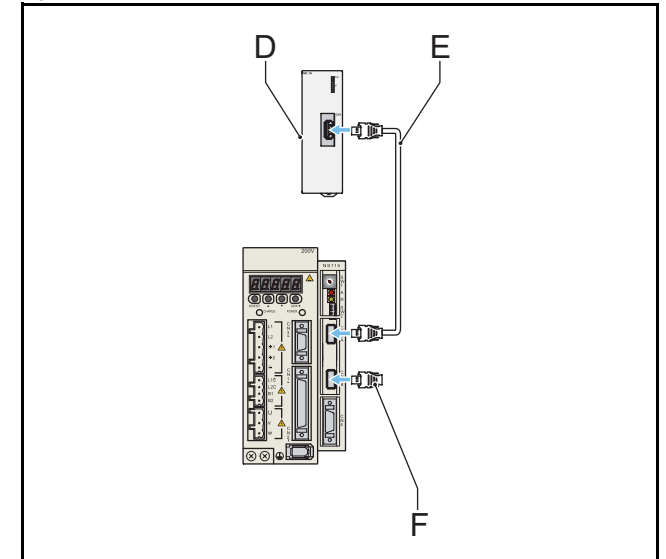

fig. 11



3.4.5 Set the dipswitches and address of the NS115

The dipswitches on the NS115 configure its communication settings.

1. Set the dipswitches as follows:

Dipswitch	Function	Setting	Description
1	Baud rate	ON	10 Mbps
2	Data length	ON	32-byte data transmission
3	Address range	OFF	Addresses 40-4F
4	Maintenance (Reserved)	OFF	Must always be set to OFF. ON is not used

2. Set the address selector of the NS115 to 1. This assigns logical address 41 to the Servo Driver.

fig. 12

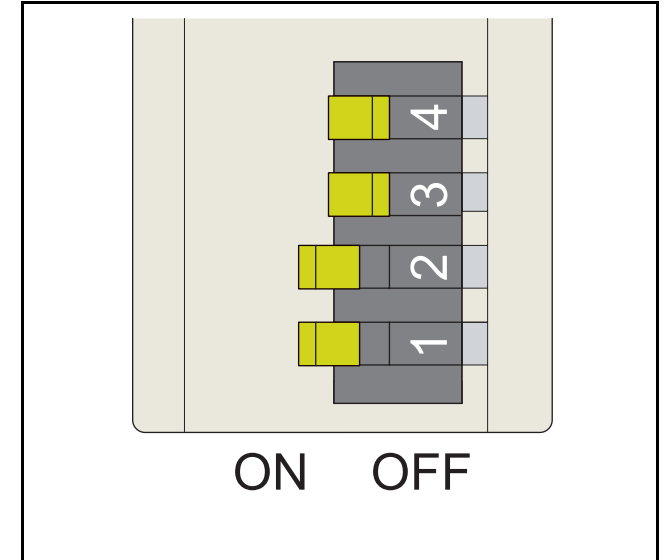
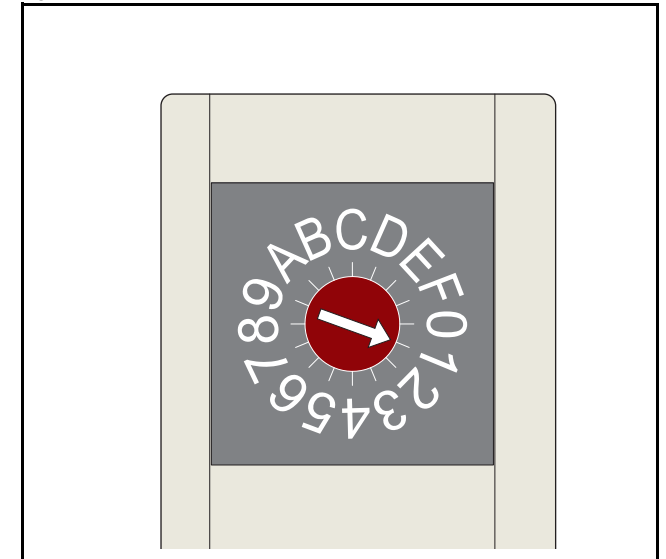

fig. 13



3.5 Complete installation

The complete installation of this example consists of a Power Supply Unit (A), a TJ1-MC__ (B), a TJ1-ML__ (C), a Servo Driver (D), an NS115 (E), a motor (F) and a TJ1-TER (G).

You can now remove the protection labels from the units.

fig. 14

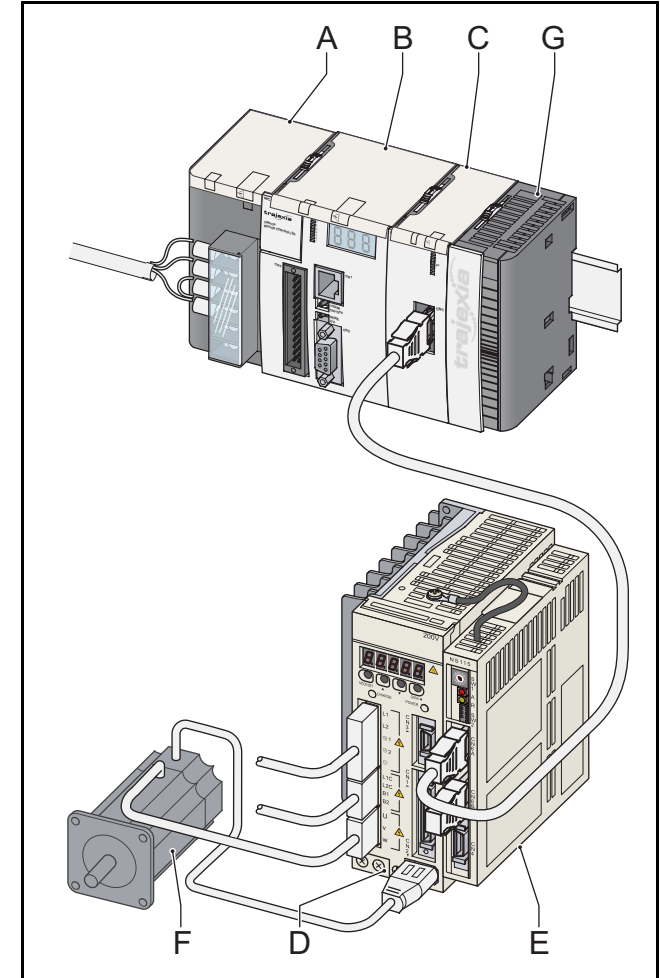

4 Trajexia Tools

4.1 Minimum PC configuration

You need a PC with this minimum configuration to install Trajexia Tools:

- Windows 98 SE.
- 300 MHz Pentium CPU.
- 64 MB RAM.
- 140 MB hard disk space.
- An Ethernet port.
- If your operating system is Windows 98 SE or Windows ME:
Internet Explorer 5.0.
- If your operating system is Windows 2000 or Windows XP:
Internet Explorer 6.0.

4.2 Install the Trajexia Tools software

1. Insert the Trajexia Tools CD into the CD-ROM drive of the PC.
2. The Trajexia Tools Setup program starts automatically.
3. If the Trajexia Tools Setup program does not start automatically, start it manually: execute **setup.exe** in the root directory of the CD.
4. Select the language you want to use from the drop-down list. Click **OK**.

fig. 1

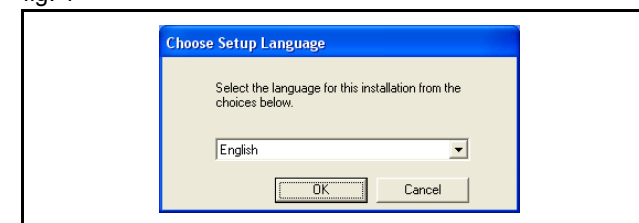

5. The Trajexia Tools Setup window shows. Click **Next**.

fig. 2

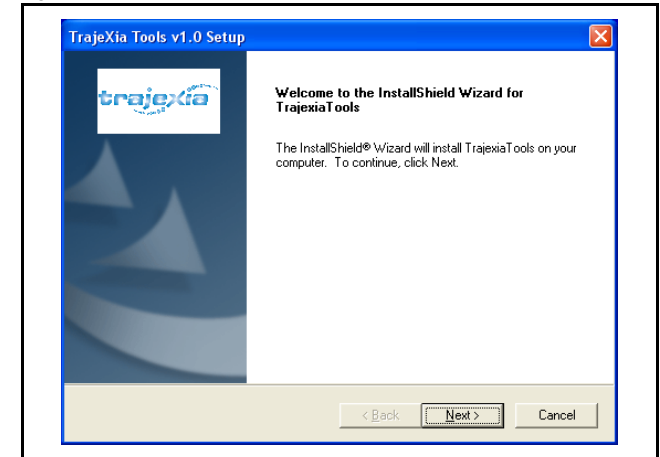

6. Click **Yes** to accept the licence agreement and continue.

fig. 3

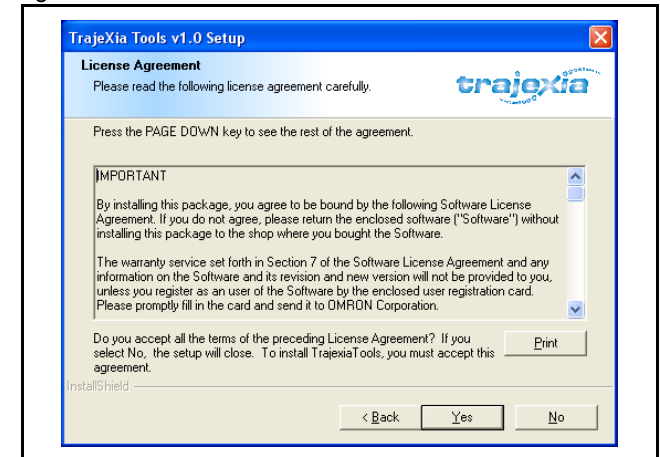

7. Type your name in the **Name** field.
8. Type your company name in the **Company** field.
9. Type your user licence number in the **Licence** fields. Your user licence number is on the label attached to the jewel case of the Trajexia Tools CD.
10. Click **Next**.

11. Click **Yes**.

12. Click **Next**.

fig. 4

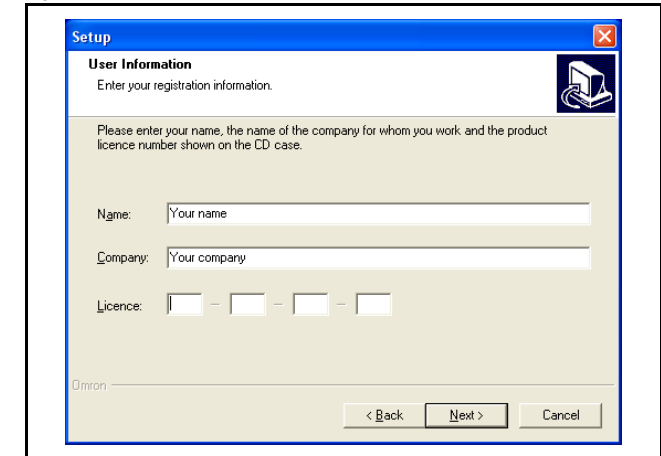
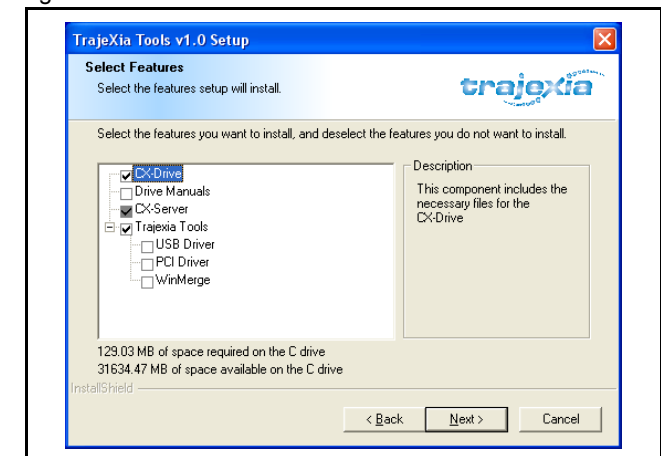

fig. 5



fig. 6



13. Click **Next**.

14. Click **Next**.

fig. 7

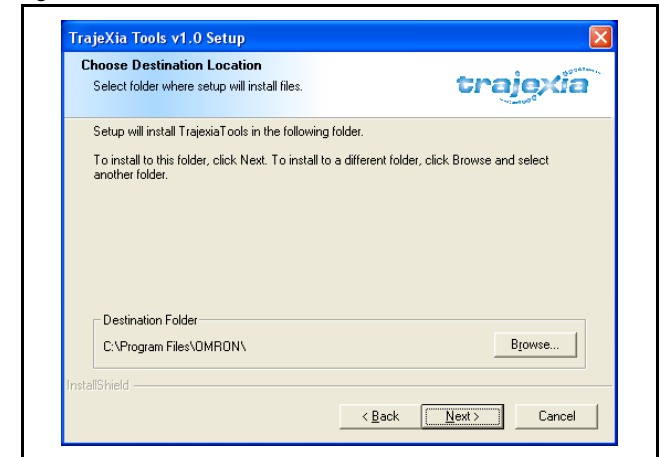
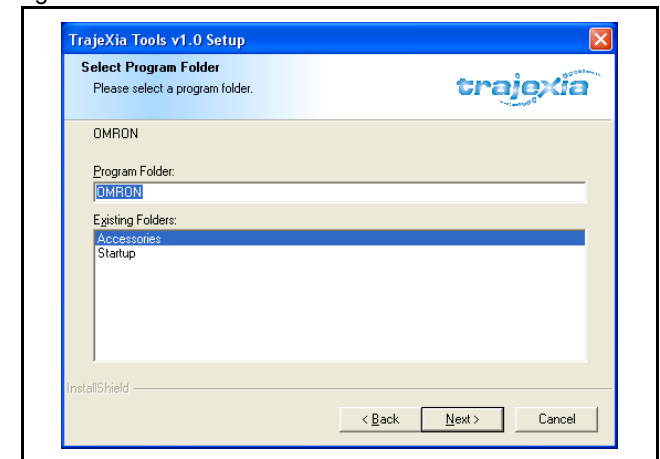

fig. 8



- 15. Click **Next**.
- 16. The Trajexia Tools Setup program copies files to your PC. This can take a few minutes.

- 17. Click **Finish**. The CX-Drive Readme File window shows. Close this window.

fig. 9

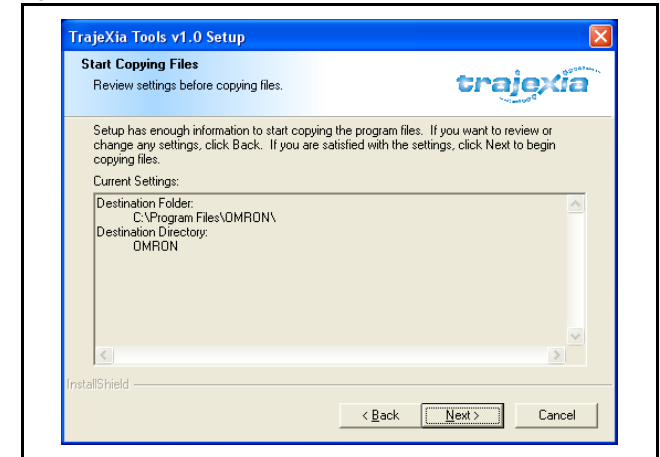
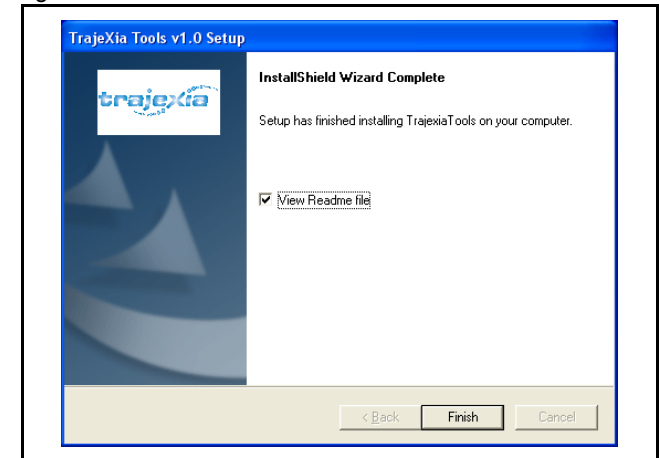

fig. 10



4.3 Connection to the TJ1-MC__

You need a patch or crossover Ethernet cable to connect the PC to the TJ1-MC__.

1. Connect the Trajexia system to the mains power supply.
2. The IP address and subnet mask of the TJ1-MC__ show 3 times in the LED display (A). The default IP address of the TJ1-MC__ is 192.168.0.250. The default subnet mask is 255.255.255.0.
3. If you need to see the IP address and the subnet mask of the TJ1-MC__ again, set the power of the Trajexia system off and then again on.
4. Connect the Ethernet cable to the Ethernet port of the PC.
5. Connect the Ethernet cable to the Ethernet port of the TJ1-MC__. The IP address of the TJ1-MC__ shows 4 times in the LED display.

fig. 11

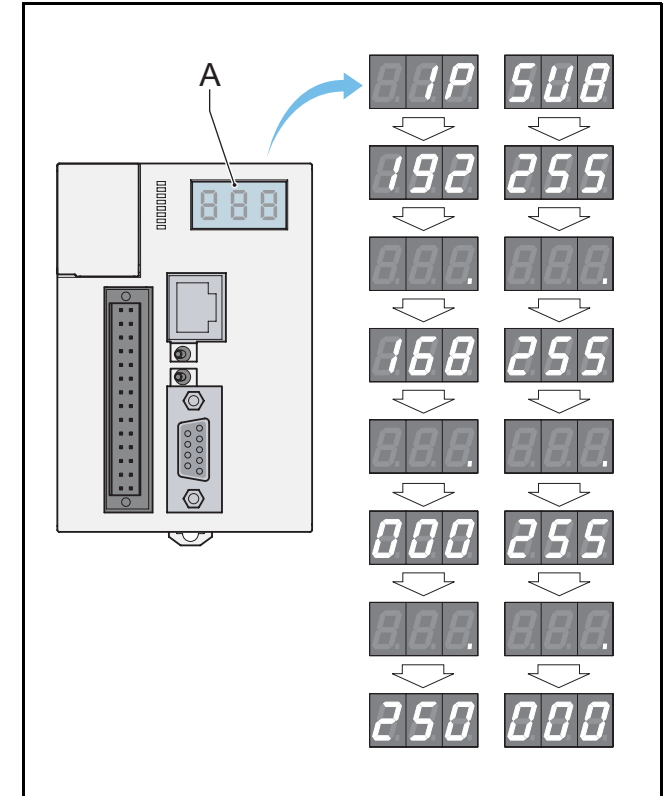

6. Start the Trajexia Tools program on your PC. Select from the Windows **Start** menu:
 - **Programs**
 - **OMRON**
 - **Trajexia Tools**
 - **Trajexia Tools**
7. The **Motion Perfect 2** start-up screen shows. Wait until the **Cancel** button is visible. Then click **Cancel**.

fig. 12



8. Select the menu:
 - **Options**
 - **Communications**

fig. 13

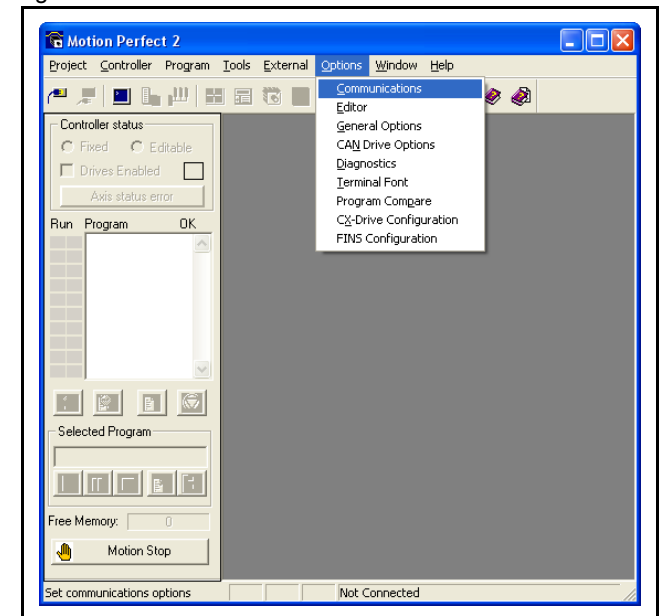

9. Make sure **ENet0** in the list is selected.
10. Click **Configure**.

11. Type **192.168.0.250** in the **Server name/IP address** field.
12. Click **OK**.

13. Click **OK**.

fig. 14

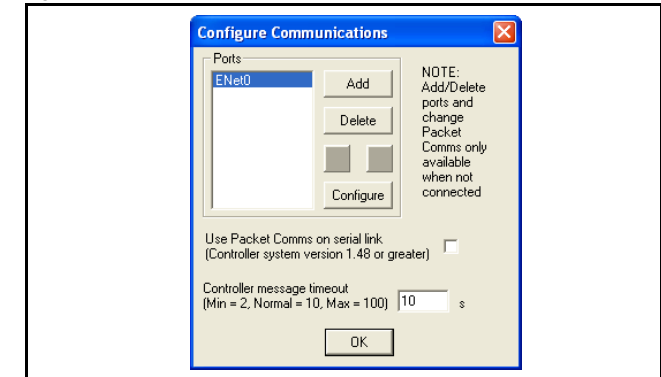

fig. 15

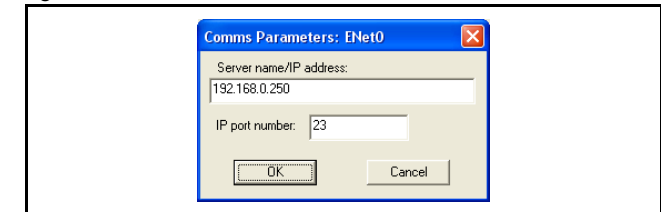
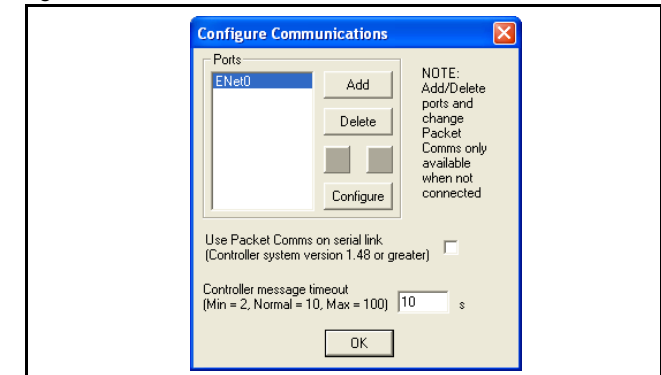

fig. 16



14. Open the Windows Control Panel on your PC.
15. Double-click on the **Network Connections** icon.
16. Right-click on the **Local Area Connection** icon. Click on the **Properties** menu.

17. Click on the **General** tab.
18. Select **Internet Protocol (TCP/IP)** in the list.
19. Click **Properties**.

fig. 17

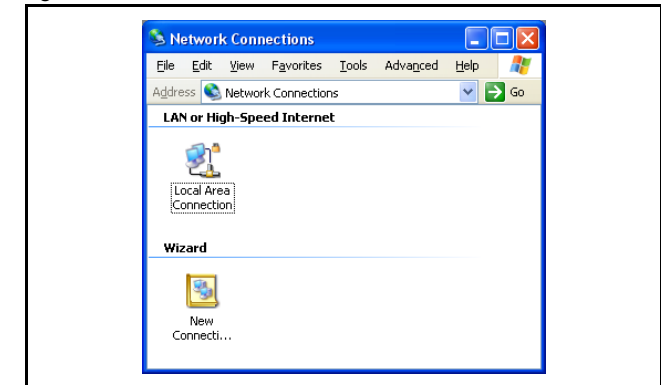
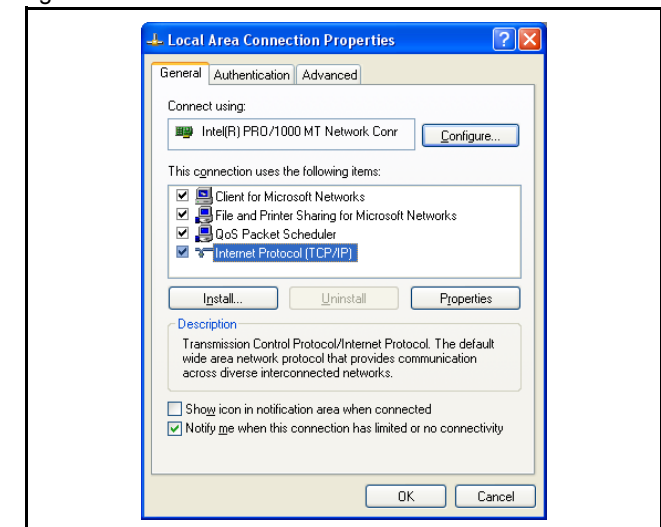
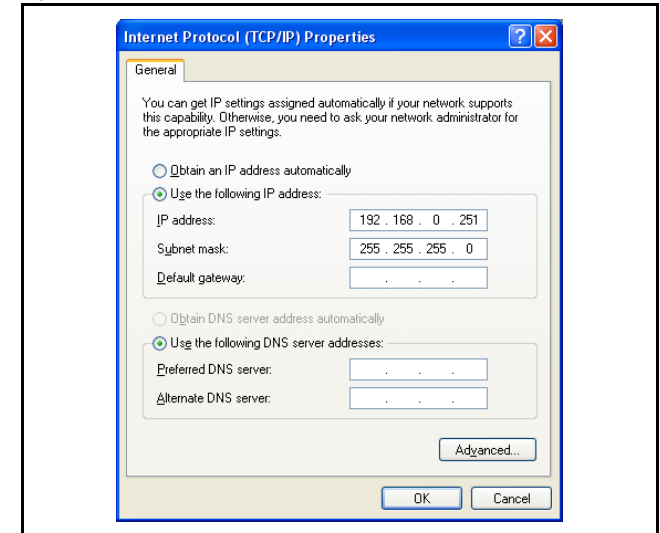

fig. 18



20. Click on the **General** tab.
21. Select **Use the following IP address**.
22. Type **192.168.0.251** address in the **IP address** field.
23. Type **255.255.255.0** in the **Subnet mask** field.
24. Click **OK**.
25. Click **OK**.
26. Close the Network Connections screen.

fig. 19



4.4 Create a project for the first time

1. Set the power of the Trajexia system and the Servo Driver and NS115 off.
2. Set the power of the Servo Driver and NS115 on.
3. Set the power of the Trajexia system on.
4. Go to the Motion Perfect 2 program on your PC.
5. Select the menu:
 - **Controller**
 - **Connect**

fig. 20

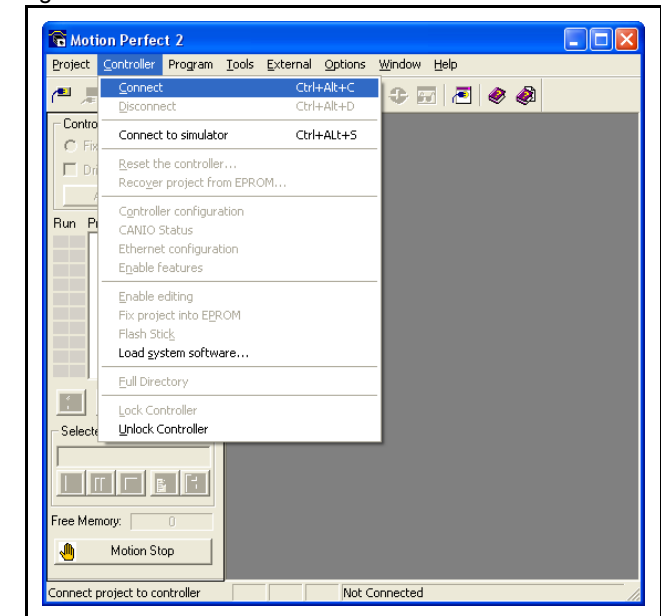

6. Wait until the **OK** button is visible. Then click **OK**.

fig. 21



7. Click **New**.

fig. 22

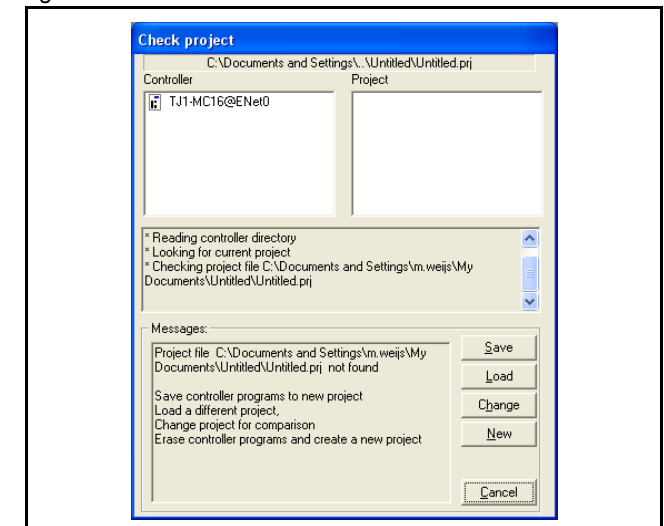

8. Click **Yes**.

9. Browse to the location where you want to save the new project in the **Disk directory** tree.

10. Type a name for the new project in the **Project name** field.

11. Click **Create**.

fig. 23

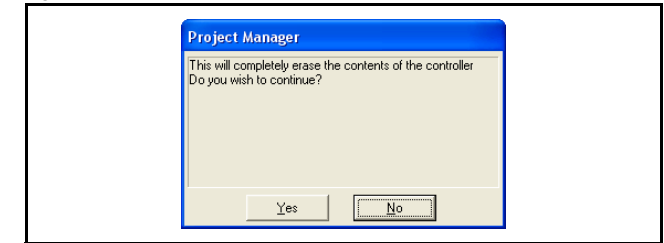
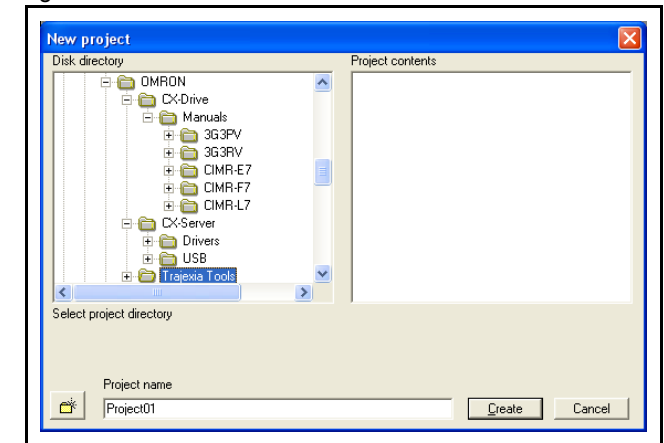
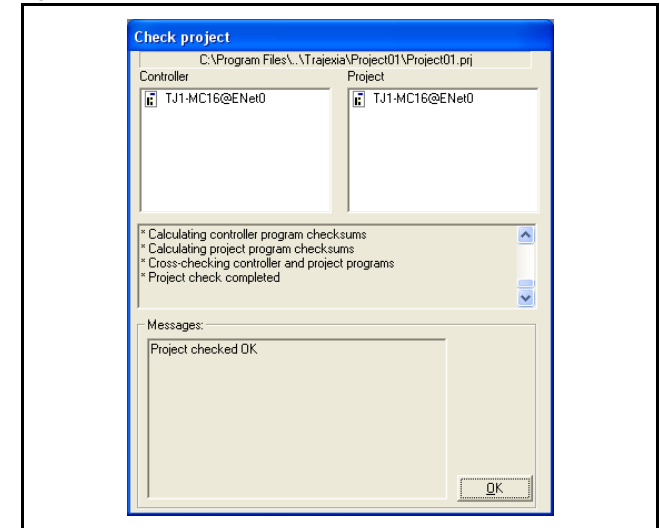

fig. 24



12. Click **OK**.

fig. 25



13. Click the **Intelligent drives** button (A) on the tool bar.

fig. 26

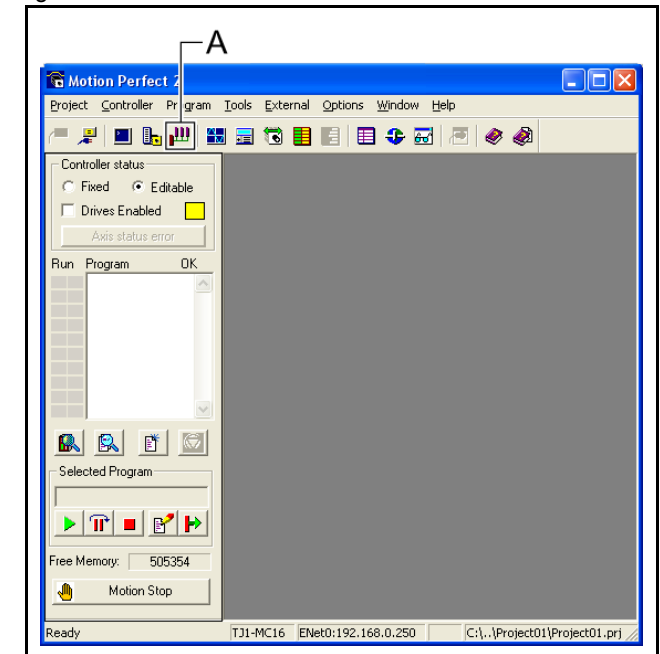

14. Click the **Config** button.

fig. 27

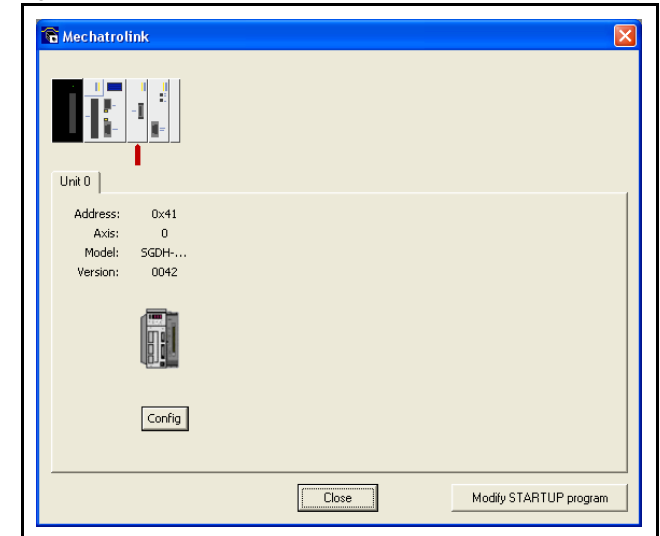

15. Wait until the **MECHATROLINK Drive SGD-01AE-OY** window shows.

16. Click on the **Configuration** tab.

fig. 28

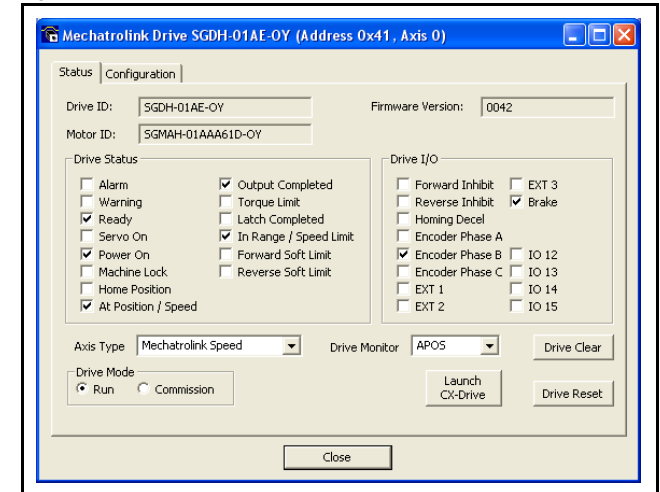

17. Scroll to the row in the list where the value of the **Index** column is **Pn50A.3**.
18. In this row, click on the item in the **Value** column. A drop-down list shows.
19. Select the value **8:Sets signal OFF.** in the drop-down list.
20. Press the **Enter** key. The icon in the first column of the row is now red, to indicate that you have changed the setting of this row.

fig. 29

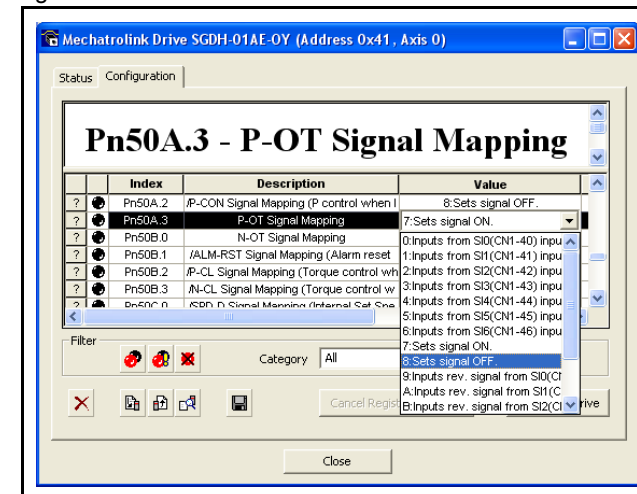

21. Scroll to the row in the list where the value of the **Index** column is **Pn50B.0**.
22. In this row, click on the item in the **Value** column. A drop-down list shows.
23. Select the value **8:Sets signal OFF.** in the drop-down list.
24. Press the **Enter** key. The icon in the first column of the row is now red, to indicate that you have changed the setting in this row.
25. Click the **Download to Drive** button (A).
26. Click **Close**.

fig. 30

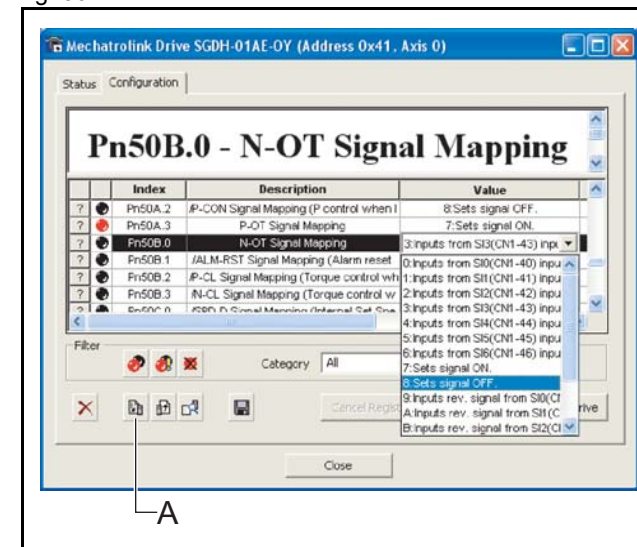

27. Click **Close**.

28. Click **Yes**.

29. Set the power of the Trajexia system and the Servo Driver off to make the driver settings effective.

30. Set the power of the Servo Driver and NS115 on.

31. Set the power of the Trajexia system on.

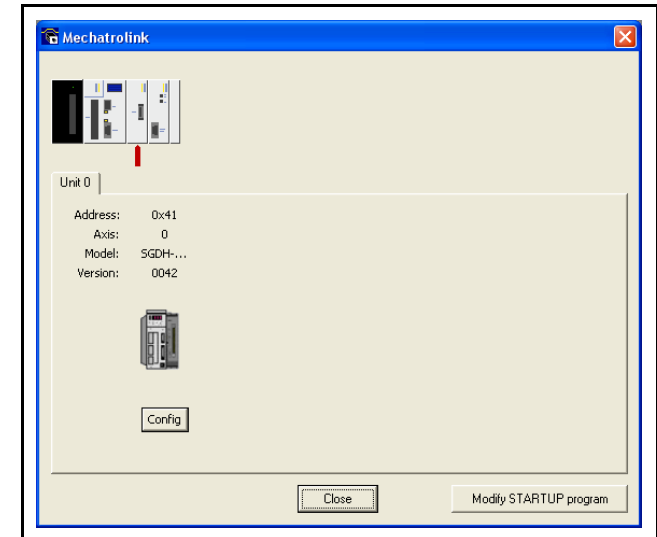
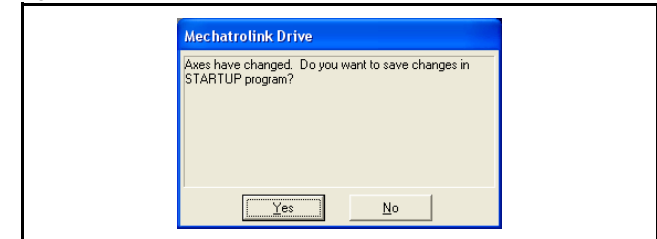

fig. 31



32. Select the menu:

- **Program**
- **New**

fig. 32

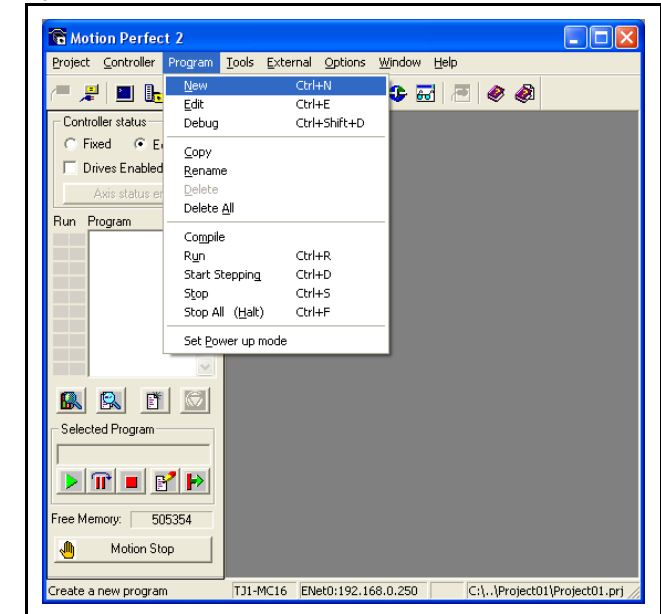

33. Enter a name for the new program in the **Enter new program name** field.

34. Click **OK**.

fig. 33

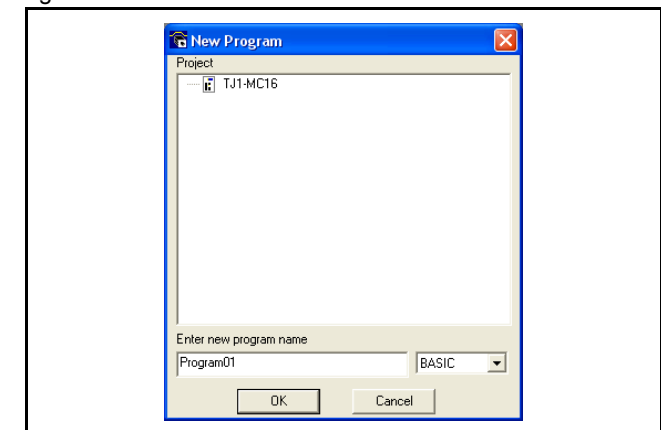

35. Select the **Edit** window.

36. Type this example program in the edit window:

```

BASE(0)
SERVO=ON
WDOG=ON
loop:
  MOVE(10000)
  WAIT IDLE
  WA(1000)
GOTO loop

```

37. Click the **Run** button (A) on the tool bar.



Note:

The default parameters are suitable for use with 13-bit encoders. If the example program does not work, do these steps:

38. Check the motor specification or the motor manual for information on the encoder type.

39. If the motor has a higher resolution, decrease the value of the parameter **P_GAIN** and increase the values of the parameters **SPEED**, **ACCEL** and **DECEL**. See the Programming Manual.

40. Run the example program again.

4.5 Complete installation

Congratulations. You are successful in the completion of this guide. You now have a Power Supply Unit, a TJ1-MC__ and a TJ1-ML__ that is connected to a servo motor, and an example program to control the servo motor.

fig. 34

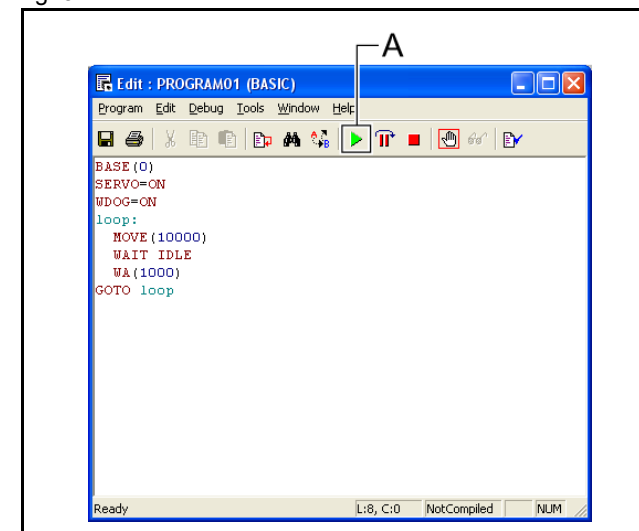

5 More information

5.1 The Trajexia system

Trajexia is OMRON's motion platform that offers you the performance and the ease of use of a dedicated motion system.

Trajexia is a stand-alone modular system that allows maximum flexibility and scalability. At the heart of Trajexia lies the TJ1 multi-tasking motion coordinator. Powered by a 32-bit DSP, it can do motion tasks such as e-cam, e-gearbox, registration control and interpolation, all via simple motion commands.

Trajexia offers control of up to 16 axes over a MECHATROLINK-II motion bus or traditional analogue or pulse control with independent position, speed or torque control for every axis. And its powerful motion instruction set makes programming intuitive and easy.

You can select from a wide choice of best-in-class rotary, linear and direct-driver servos as well as inverters. The system is scalable up to 16 axes and 8 inverters & I/O modules.

fig. 1

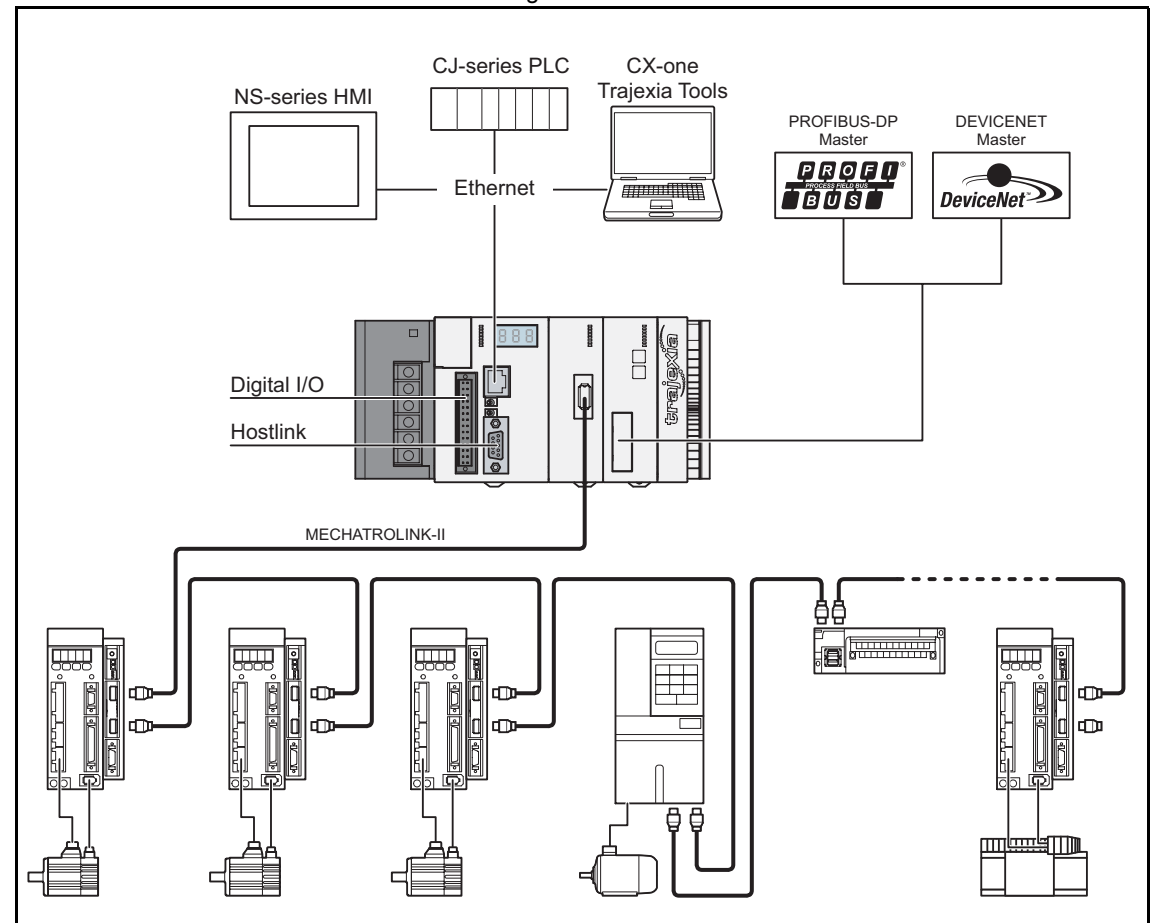

5.2 Trajexia highlights

5.2.1 Direct connectivity via Ethernet

Trajexia's Ethernet built-in port provides direct and fast connectivity to PCs, PLCs, HMIs and other devices while providing full access to the drivers over a MECHATROLINK-II motion bus. It allows explicit messaging over Ethernet and through MECHATROLINK-II to provide full transparency down to the actuator level, and making remote access possible.

5.2.2 Keep your know-how safe

Trajexia's encryption method guarantees complete protection and confidentiality for your valuable know-how.

5.2.3 Serial port and local I/Os

A serial port provides direct connectivity with any OMRON PLC, HMI or any other field device. 16 Inputs and 8 outputs are freely configurable embedded I/Os in the controller to enable you to tailor Trajexia to your machine design.

5.2.4 MECHATROLINK-II

The TJ1-ML__ performs control of up to 16 Servo Drivers, inverters or I/Os while allowing complete transparency across the whole system. MECHATROLINK-II offers the communication speed and time accuracy essential to guarantee perfect motion control of Servo Drivers. The motion cycle time is selectable between 0.5 ms, 1 ms or 2 ms.

5.2.5 TJ1-FL02

The TJ1-FL02 is an analogue control unit. It controls up to two axes in these modes:

More information

- Analogue speed reference plus encoder feedback.
- Encoder input, pulse or absolute.
- Pulse output.

You can connect any Servo Driver to the TJ1-FL02.

5.2.6 Drivers and inverters

A wide choice of rotary, linear and direct-driver servos as well as inverters are available to fit your needs in compactness, performance and reliability. The inverters connected to the MECHATROLINK-II are driven at the same update cycle time as the Servo Drivers.

5.2.7 Remote I/Os

The I/Os on the MECHATROLINK-II motion bus provide for system expansion while keeping the devices under one motion bus.

5.2.8 PROFIBUS

The TJ1-PRT is an interface between the Trajexia system and a PROFIBUS network.

5.2.9 DeviceNet

The TJ1-DRT is an interface between the Trajexia system and a DeviceNet network.

5.3 Trajexia manuals

All the information about the Trajexia system is described in these manuals:

Name	Cat. No.	Contents
Trajexia motion control system Hardware Reference Manual	I51E	Describes the installation and hardware specification of the Trajexia units, and explains the Trajexia system philosophy.
Trajexia motion control system Programming Manual	I52E	Describes the BASIC commands to be used for programming Trajexia, explains the communication protocols and Trajexia Tools software, gives practical examples and troubleshooting information.

Revision history

A manual revision code shows as a suffix to the catalogue number on the front cover of the manual.

Revision code	Date	Revised content
01	August 2006	Original
02	October 2006	DeviceNet update
03	May 2007	Updated with TJ1-MC04 and TJ1-ML04. Updated with general Trajexia system information and Trajexia highlights.



OMRON EUROPE B.V. Wegalaan 67-69, NL-2132 JD, Hoofddorp, The Netherlands. Tel: +31 (0) 23 568 13 00 Fax: +31 (0) 23 568 13 88 www.omron-industrial.com

Austria

Tel: +43 (0) 1 80 19 00
www.omron.at

Belgium

Tel: +32 (0) 2 466 24 80
www.omron.be

Czech Republic

Tel: +420 234 602 602
www.omron.cz

Denmark

Tel: +45 43 44 00 11
www.omron.dk

Finland

Tel: +358 (0) 207 464 200
www.omron.fi

France

Tel: +33 (0) 1 56 63 70 00
www.omron.fr

Germany

Tel: +49 (0) 2173 680 00
www.omron.de

Hungary

Tel: +36 (0) 1 399 30 50
www.omron.hu

Italy

Tel: +39 02 32 68 777
www.omron.it

Middle East & Africa

Tel: +31 (0) 23 568 11 00
www.omron-industrial.com

Netherlands

Tel: +31 (0) 23 568 11 00
www.omron.nl

Norway

Tel: +47 (0) 22 65 75 00
www.omron.no

Poland

Tel: +48 (0) 22 645 78 60
www.omron.pl

Portugal

Tel: +351 21 942 94 00
www.omron.pt

Russia

Tel: +7 495 745 26 64
www.omron.ru

Spain

Tel: +34 913 777 900
www.omron.es

Sweden

Tel: +46 (0) 8 632 35 00
www.omron.se

Switzerland

Tel: +41 (0) 41 748 13 13
www.omron.ch

Turkey

Tel: +90 (0) 216 474 00 40
www.omron.com.tr

United Kingdom

Tel: +44 (0) 870 752 08 61
www.omron.co.uk

Authorised Distributor:

Note:

Although we do strive for perfection, Omron Europe BV and/or its subsidiary and affiliated companies do not warrant or make any representations regarding the correctness or completeness of information described in this catalogue. Product information in this catalogue is provided 'as is' without warranty of any kind, either express or implied, including, but not limited to, the implied warranties of merchantability, fitness for a particular purpose, or non-infringement. In a jurisdiction where the exclusion of implied warranties is not valid, the exclusion shall be deemed to be replaced by such valid exclusion, which most closely matches the intent and purpose of the original exclusion. Omron Europe BV and/or its subsidiary and affiliated companies reserve the right to make any changes to the products, their specifications, data at its sole discretion at any time without prior notice. The material contained in this catalogue may be out of date and Omron Europe BV and/or its subsidiary and affiliated companies make no commitment to update such material.