

NT600M

Programmable Terminal

OPERATION MANUAL

OMRON

NT600M

Programmable Terminal

Operation Manual

Revised October 1997

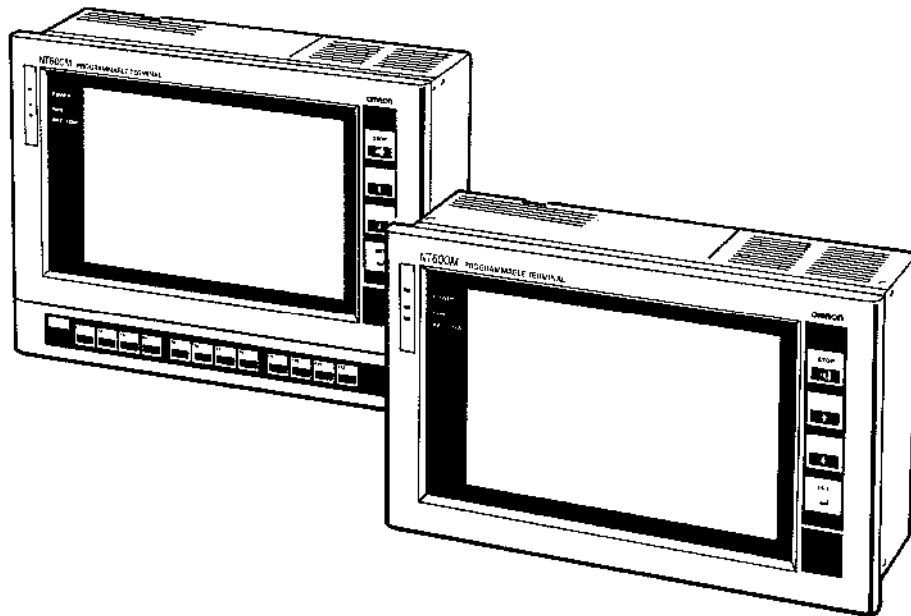

OMRON Product References

All OMRON products are capitalized in this manual. The word "Unit" is also capitalized when it refers to an OMRON product, regardless of whether or not it appears in the proper name of the product.

The abbreviation “Ch,” which appears in some displays and on some OMRON products, often means “word” and is abbreviated “Wd” in documentation in this sense.

The abbreviation “PC” means Programmable Controller and is not used as an abbreviation for anything else.

IBM and IBM PC/AT are registered trademarks of International Business Machines Corporation.

MS-DOS is a registered trademark of Microsoft Corporation.

Visual Aids

The following headings appear in the left column of the manual to help you locate different types of information.

Note Indicates information of particular interest for efficient and convenient operation of the product.

1, 2, 3... 1. Indicates lists of one sort or another, such as procedures, checklists, etc.

© OMRON, 1991

All rights reserved. No part of this publication may be reproduced, stored in a retrieval system, or transmitted, in any form, or by any means, mechanical, electronic, photocopying, recording, or otherwise, without the prior written permission of OMRON.

No patent liability is assumed with respect to the use of the information contained herein. Moreover, because OMRON is constantly striving to improve its high-quality products, the information contained in this manual is subject to change without notice. Every precaution has been taken in the preparation of this manual. Nevertheless, OMRON assumes no responsibility for errors or omissions. Neither is any liability assumed for damages resulting from the use of the information contained in this publication.

About this Manual:

This manual describes the installation and operation of the NT600M Programmable Terminals (PTs) and includes the sections described below. Further information is provided in manuals on the Host Interface Units and Support Tool. Refer to the list in *Section 1 Introduction*.

Please read this manual completely and be sure you understand the information provide before attempting to install and operate a Programmable Terminal.

Section 1 introduces the PTs, describes the terminology used in this manual, and provides examples of system configurations for programming and operation.

Section 2 provides procedures and specifications required to set up a PT system, including hardware switch settings and installation.

Section 3 provides steps required for initial PT operation.

Section 4 describes functions used to create screens and control display attributes on the PT. Included is automatic transfer of data from the host computer via character string and numeral tables.

Section 5 describes functions used to input data on-screen and transfer it to the host computer via the numeral table.

Section 6 describes basic data transfer and maintenance functions.

Section 7 describes transferring screens online to and from the host computer.

Section 8 provides troubleshooting and basic maintenance methods, including battery replacement.

Appendices of OMRON products used with PTs, PT specifications, and a memory check table are provided at the back of the manual.

 **WARNING** Failure to read and understand the information provided in this manual may result in personal injury or death, damage to the product, or product failure. Please read each section in its entirety and be sure you understand the information provided in the section and related sections before attempting any of the procedures or operations given.

TABLE OF CONTENTS

| | |
|--|-----------|
| PRECAUTIONS | ix |
| 1 Intended Audience | x |
| 2 General Precautions | x |
| 3 Safety Precautions | x |
| SECTION 1 – Introduction | 1 |
| 1-1 Introduction | 2 |
| 1-2 Features | 4 |
| 1-3 Terminology and NT-series Manuals | 5 |
| 1-4 Models | 6 |
| 1-4-1 NT600M Programmable Terminals | 6 |
| 1-4-2 Screen Data Memory Boards | 6 |
| 1-4-3 System ROM | 7 |
| 1-4-4 Host Interface Units | 8 |
| 1-4-5 12-key Function Key Units (for DN-type) | 9 |
| 1-5 Support Tools | 9 |
| 1-6 System Configuration | 10 |
| 1-7 Nomenclature and Functions | 13 |
| 1-7-1 Front Panel | 13 |
| 1-7-2 Rear Panel | 14 |
| SECTION 2 – Switch Settings, Installation, and Wiring | 15 |
| 2-1 Switch Settings | 16 |
| 2-1-1 System DIP Switch Settings (SW1) | 16 |
| 2-1-2 Mounting System ROM | 17 |
| 2-1-3 Screen Data Memory Board Settings and Installation | 18 |
| 2-2 Installation Environment | 20 |
| 2-2-1 Installation Site | 20 |
| 2-2-2 Mounting Position | 21 |
| 2-3 Dimensions | 22 |
| 2-3-1 Terminals with Function Keys (DF-type) | 22 |
| 2-3-2 PTs With (DT-type) and Without (DN-type) Touch Panels | 23 |
| 2-4 Installing the NT600M PT in a Panel | 23 |
| 2-5 Wiring and Connectors | 25 |
| 2-5-1 Terminal Block | 25 |
| 2-5-2 AC INPUT Terminals | 25 |
| 2-5-3 LG and GR Terminals | 26 |
| 2-5-4 HOST RUN INPUT Terminals | 26 |
| 2-5-5 ALM OUTPUT Terminals | 27 |
| 2-6 RS-232C Interface Connector | 27 |
| 2-7 12-key Function Key Units (for DN-type PTs) | 28 |
| 2-8 Mounting Function Key Units (to DN-type PTs) | 28 |
| SECTION 3 – Initial Operation | 31 |
| 3-1 Powering Up | 32 |
| 3-2 Initialization | 32 |
| 3-2-1 Initializing Memory | 32 |
| 3-2-2 Menus | 34 |
| 3-3 Transferring Data to and from the Support Tool | 35 |
| 3-4 Trial Operation | 37 |

| | |
|--|-----------|
| SECTION 4 – Display Functions | 39 |
| 4-1 Character Displays | 40 |
| 4-1-1 Types of Characters | 40 |
| 4-1-2 Designating Display Positions | 40 |
| 4-1-3 Character Scale | 40 |
| 4-1-4 Display Attributes | 41 |
| 4-2 Display Graphics | 41 |
| 4-3 Normal Screen Changes | 42 |
| 4-3-1 Procedure for Changing Screens | 42 |
| 4-4 Continuous Screens | 42 |
| 4-5 Overlapping Screens | 43 |
| 4-6 Numeric Displays | 45 |
| 4-7 Character Strings | 46 |
| 4-8 Bar Graphs | 47 |
| 4-9 Lamps | 47 |
| 4-10 Graphics Display | 48 |
| 4-11 Special Controls | 48 |
| 4-11-1 Backlight ON/OFF | 48 |
| 4-11-2 Alarm Output On/Off | 49 |
| 4-11-3 Buzzer On/Off | 49 |
| 4-11-4 Initialize Display History | 49 |
| 4-11-5 HOST RUN INPUT | 49 |
| 4-11-6 Normal/Inverse Display (LCD-type Only) | 50 |
| 4-12 Terminal Function | 50 |
| 4-13 Display Speed | 50 |
| SECTION 5 – Input Functions | 53 |
| 5-1 On-screen Switch Inputs | 54 |
| 5-1-1 Transmitting to the Host | 54 |
| 5-1-2 Creating Touch Switches (DT-type PTs Only) | 55 |
| 5-1-3 Function Keys (NT600M-DF122) | 56 |
| 5-2 Inputting Numeric Settings | 56 |
| 5-3 Standalone Function | 59 |
| SECTION 6 – System Menu | 61 |
| 6-1 Configuration of System Menu | 62 |
| 6-2 System Menu and Transmit Mode | 63 |
| 6-2-1 Quit | 63 |
| 6-2-2 Transmit Mode | 63 |
| 6-2-3 Maintenance Mode | 63 |
| 6-2-4 Expansion Mode | 63 |
| 6-2-5 Display History | 63 |
| 6-2-6 I/O Checks | 65 |
| 6-2-7 PT Settings Check | 69 |
| 6-2-8 Initialization | 70 |
| 6-3 Memory Switch Settings | 71 |
| SECTION 7 – Online Transfer | 75 |
| 7-1 Host to PT | 76 |
| 7-2 PT to Host | 76 |

Table of contents

| | |
|---|-----------|
| SECTION 8 – Maintenance and Inspection | 79 |
| 8-1 Checking Operation | 80 |
| 8-2 Changing the Lithium Backup Battery | 80 |
| 8-3 Maintenance and Inspection | 81 |
| 8-3-1 Spare Terminals | 81 |
| 8-3-2 Inspection | 81 |
| 8-3-3 Precautions When Cleaning the PT Screen | 82 |
| 8-4 RUN Mode Function Configuration | 83 |
| Appendix | 85 |
| A – Standard Models | 85 |
| B – Specifications | 87 |
| C – Memory Check Table | 91 |
| D – Special Characters | 93 |
| Index | 95 |

PRECAUTIONS

This section provides general precautions for using the Programmable Terminal.

The information contained in this section is important for the safe and reliable application of the Programmable Terminal. You must read this section and understand the information contained before attempting to set up or operate a Programmable Terminal.

| | | |
|---|---------------------------|---|
| 1 | Intended Audience | x |
| 2 | General Precautions | x |
| 3 | Safety Precautions | x |

1 Intended Audience

This manual is intended for the following personnel, who must also have knowledge of electrical systems (an electrical engineer or the equivalent).

- Personnel in charge of installing FA systems.
- Personnel in charge of designing FA systems.
- Personnel in charge of managing FA systems and facilities.

2 General Precautions

The user must operate the product according to the performance specifications described in the operation manuals.

Before using the product under conditions which are not described in the manual or applying the product to nuclear control systems, railroad systems, aviation systems, vehicles, combustion systems, medical equipment, amusement machines, safety equipment, and other systems, machines, and equipment that may have a serious influence on lives and property if used improperly, consult your OMRON representative.

Make sure that the ratings and performance characteristics of the product are sufficient for the systems, machines, and equipment, and be sure to provide the systems, machines, and equipment with double safety mechanisms.

This manual provides information for using the Programmable Terminal. Be sure to read this manual before attempting to use the software and keep this manual close at hand for reference during operation.

 **WARNING** It is extremely important that Programmable Terminals and related devices be used for the specified purpose and under the specified conditions, especially in applications that can directly or indirectly affect human life. You must consult with your OMRON representative before applying Programmable Terminals to the abovementioned applications.

 **WARNING** Do not use input functions such as PT touch switches for applications where danger to human life or serious damage is possible, or for emergency switch applications.

3 Safety Precautions

Read these safety precautions carefully and make sure you understand them before using the Programmable Terminal so that you can use it safely and correctly.

Safety Conventions and their Meanings

This operation manual uses the following conventions and symbols to indicate cautions, warnings, and dangers in order to ensure safe use of the PT. The cautions, warnings, and dangers shown here contain important information related to safety. The instructions in these cautions, warnings, and dangers must be observed.

The conventions used and their meanings are presented below.

 **DANGER** Indicates information that, if not heeded, is likely to result in loss of life or serious injury.

 **WARNING** Indicates information that, if not heeded, could possibly result in loss of life or serious injury.

 **Caution** Indicates information that, if not heeded, could result in relatively serious or minor injury, damage to the product, or faulty operation.

 **Caution**

- The ROM may be destroyed if it is mounted while power is being supplied to the PT.
- Screen memory must be initialized before using a new PT. If the PT is used as shipped from the factory without initialization, messages indicating errors in the host will not be displayed.
- After the transfer has been completed, be sure to return to RUN Mode by pressing the Buzzer Key, Up Key, and Down Key simultaneously. If the power is turned off or if a reset is executed without having first returned to RUN Mode, the data that has been transmitted will be corrupted. If that occurs, a message will be displayed on the screen to indicate that the data has been corrupted.
- If a load (e.g., a buzzer or alarm light) is connected to a 10/02 Terminal or a 32/16 Terminal, it will actually operate. This can be potentially dangerous, so exercise caution.
- The lithium battery can explode if placed into a fire, or it can explode, burn, or leak if the + and – terminals are short-circuited or if the battery is recharged or dismantled. Handle the battery with care.

SECTION 1

Introduction

This section provides information necessary to familiarize you with the features and parts of a PT system.

| | | |
|-------|---|----|
| 1-1 | Introduction | 2 |
| 1-2 | Features | 4 |
| 1-3 | Terminology and NT-series Manuals | 5 |
| 1-4 | Models | 6 |
| 1-4-1 | NT600M Programmable Terminals | 6 |
| 1-4-2 | Screen Data Memory Boards | 6 |
| 1-4-3 | System ROM | 7 |
| 1-4-4 | Host Interface Units | 8 |
| 1-4-5 | 12-key Function Key Units (for DN-type) | 9 |
| 1-5 | Support Tools | 9 |
| 1-6 | System Configuration | 10 |
| 1-7 | Nomenclature and Functions | 13 |
| 1-7-1 | Front Panel | 13 |
| 1-7-2 | Rear Panel | 14 |

1-1 Introduction

This manual describes the installation and operation of NT600M Programmable Terminals (PTs). Programmable Terminals have three main functions: 1) monitoring operating conditions, 2) directing on-site personnel, and 3) inputting data.

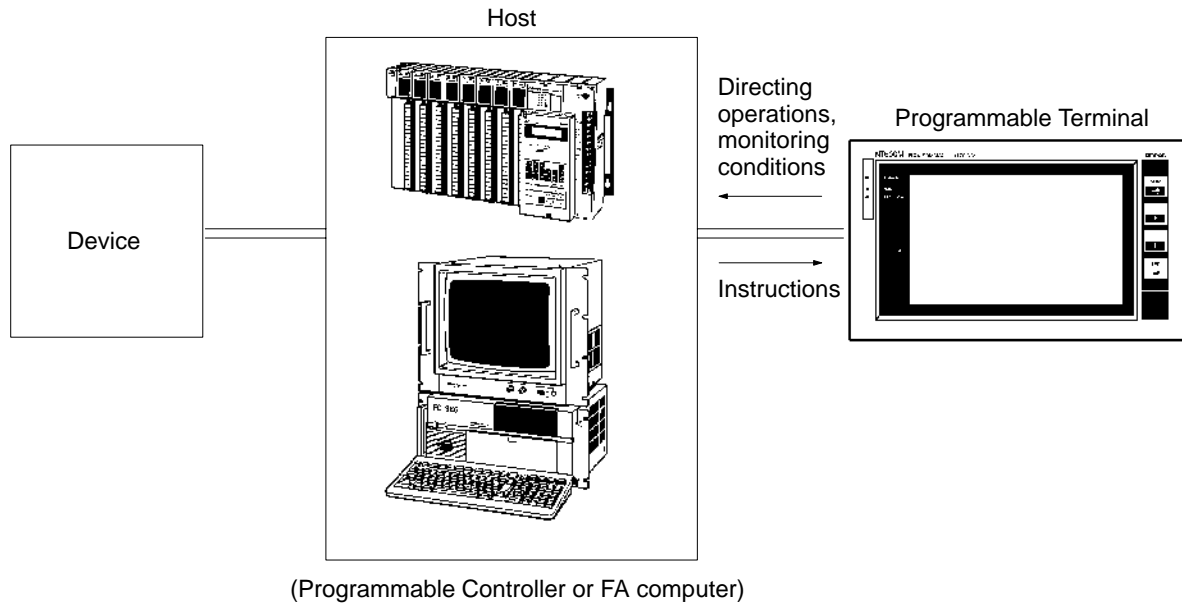

1) PTs can monitor, in real time, system and equipment operating conditions, production quantities, and so on. The PT display can show, for example, whether the production line is operating normally, and what percentage of the production target has been met. Bar graphs can be continually updated as data is received from the host. On-screen characters can be displayed as plain, reverse video, blinking, or reverse blinking. In addition, lamps, bar graphs, and figures can all be created. Screen data can be registered at the PT in advance, and can be displayed simply by transmitting the appropriate screen number from the host.

Lamp Display

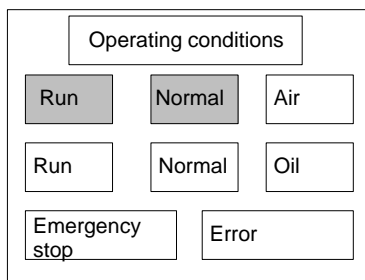

Bar Graph Display

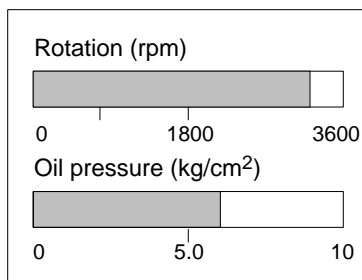

Graphics Display

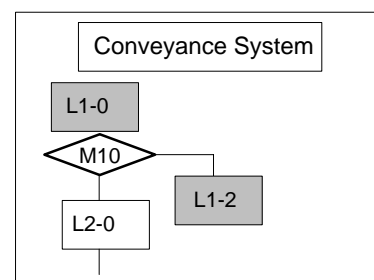

2) PTs can inform on-site personnel of current conditions that need to be addressed. Depending on the nature of the situation, built-in or external buzzers can be sounded to alert personnel to problems that have developed. Depending on factors such as distance from the host, the number of devices

connected, and the response time, any of a variety of communications methods may be selected.

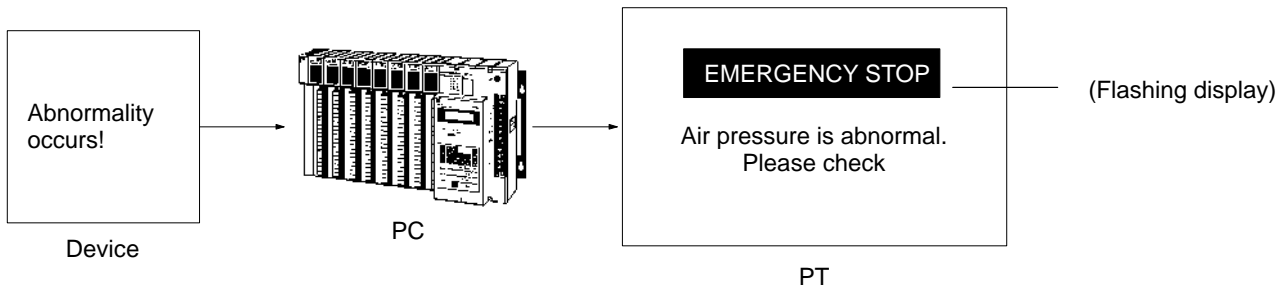

3) PTs can input data for controlling certain operations and communicating information to the host. Setting switches and a ten-key pad allows a PT to be used as a control panel. In the example shown below, touch switches used for inputs to the host are displayed. When this screen is displayed, the on-site operator can control a device by means of touch switches.

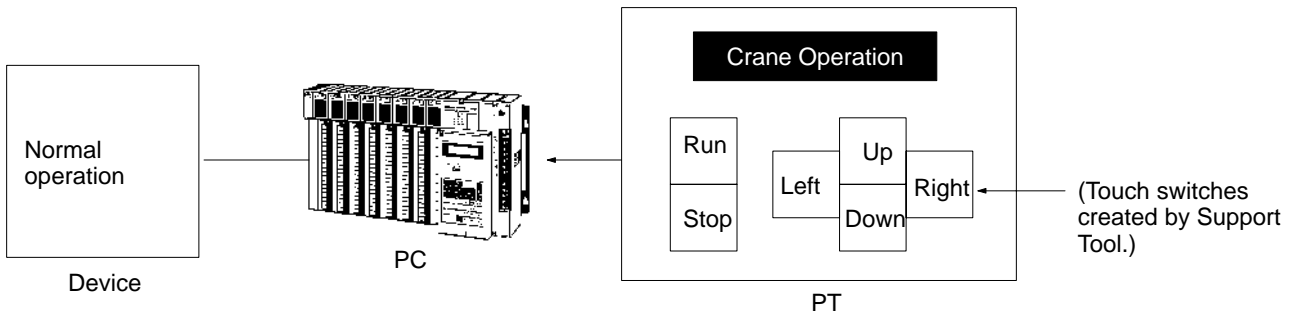

Aside from touch switches, the PT can provide inputs by means of numeric settings and externally connected switches. The illustration below shows a numeric setting screen that can be used for inputting numeric data.

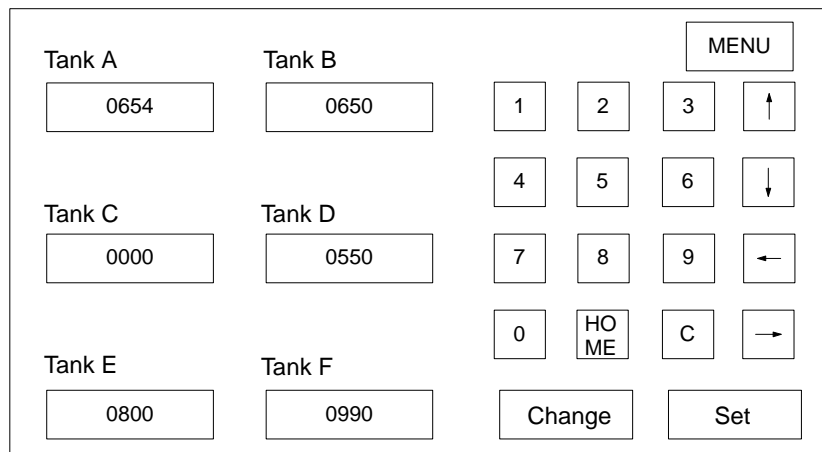

The screens used for these operations can be created in advance by using the "Support Tool" software on a personal computer. The screen data that is created using the Support Tool can be printed out, saved to a diskette, or transferred to the PT. An FA Computer, a Programmable Controller, or a compatible device can be used as the host.

1-2 Features

| | |
|---|---|
| Wide Selection of Models | The NT600-series PTs provide a choice of three models depending on the input specifications of your system. You can also choose either of two types of display devices. Any of six methods can be selected for communicating with the host, which may be an FA Computer, a Programmable Controller, or a compatible device. |
| Drip-proof Structure | The PTs have a drip-proof front panel structure when the dust cover is mounted to protect the display area and the key input area. |
| Clear Display | Either of two types of display can be selected: an STN liquid crystal display with a backlight, or a yellow-orange EL (electro-luminescent) display. |
| Two-way Communications with Host | Screens at the PT can be changed, messages can be received, and numbers can be displayed from the host. The PT, in turn, can transmit key inputs and numbers back to the host. |
| Display Functions | A maximum of 1000 screens can be registered. As many as 64 rectangular or circular lamps can be created for a single screen, up to a total of 256 and direct connection can be used without restrictions. Character strings, numerals, bar graphs and simple graphics can also be created and registered. |
| Input Options | Depending on the input specifications of the control system, any of three NT600M types may be selected: the touch panel (DT) type, the non-touch-panel type (DN), and the function key type (DF). DT-type PTs enable the user to create and use as many as 64 touch switches per screen, up to a total of 256 and direct connection can be used without restrictions. DN-type PTs allow the connection of 12-key Function Key Units, up to a maximum of 32 input points and 16 output points. DF-type PTs enable various inputs by means of 12 function keys. |
| Standalone Capability | Screens can be changed on-site, using touch switches, function keys, or external inputs. The screen-changing capability can be allocated to touch switches or function keys at the time that the screens are created in advance by the Support Tool. |
| Online Transfer | Screen data can be written by means of commands from the host when an RS-232C or RS-422A Host Interface Unit is mounted. |
| Direct Connection | The direct connection function can be used to directly correlate host data areas with PT operations. Ordinarily, instructions to the PT and inputs from the PT are executed in response to commands from the host. Such commands are not required for direct connection, however, and thus the size of the host program can be greatly reduced. The direct connection can only be used by DT-type PTs, with the restrictions on Host I/F Units, System ROM, and Support Tool versions shown in the following table. |

| PT | System ROM | Host Interface Unit | Support Tool |
|--------------|----------------|---|---|
| NT600M-DT12 | NT600M-SMR31-E | NT600M-LK201 Host Link Interface Unit | NT20M-ZASAT-EV4 (Version 4.0 or later) NT-ZA3AT-EV2 |
| NT600M-DT211 | NT600M-SMR32-E | NT600M-LB122-V1 C200H Host Interface Unit | |

When direct connection is used, the PT data is as follows:

| | |
|-------------------------------------|---|
| Lamps | 255 per screen (with no limit on number registered) |
| Touch switches | 128 per screen (with no limit on number registered) |
| Character string data memory | 50 places per screen (with a maximum of 512 registered) |

1-3 Terminology and NT-series Manuals

Names of items in this manual related to the NT-series Programmable Terminals and SYSMAC C-series Programmable Controllers are defined in the following tables.

Abbreviations

The following abbreviations are used in the text.

| Abbreviation | Term | Meaning |
|--------------|-------------------------|---|
| PT | Programmable Terminal | Refers to an OMRON NT-series Programmable Terminal. |
| PC | Programmable Controller | Refers to an OMRON SYSMAC C-series or CV-series Programmable Controller, or programmable controllers manufactured by other companies. |
| I/F | interface | A communications device that connects the Programmable Terminal with peripheral devices. |
| I/O | input/output | Refers to PT and PC inputs and outputs. |

SYSMAC Terminology

| Terminology | Explanation |
|------------------|---|
| SYSMAC | A generic name for OMRON's Programmable Controllers. |
| Host Link System | A system employing SYSMAC C-series Host Link Units used to create a communications bus between PCs, between PCs and PTs, etc. |
| SYSMAC BUS | A remote I/O network created between SYSMAC C-series PCs and input/output devices. |
| C200H | An OMRON SYSMAC C-series Programmable Controller. |

Reference Manuals

The NT20M/NT2000M Series and NT600M Series are covered in the seven manuals described below.

| Name of Manual | Contents | Manual No. |
|--|---|------------|
| NT20M/NT2000M Operation Manual | This manual provides specifications, functions, and operating instructions for the NT20M and NT2000M Programmable Terminals. | V001 |
| NT600M Operation Manual | This manual provides specifications, functions, and operating instructions for NT600M Programmable Terminals. | V002 |
| NT-series Host Interface Unit Operation Manual | This manual covers the commands, controls, and communications specifications for operating the NT20M and the NT600M. Refer to this manual when programming host computer communications. | V003 |
| NT20M/NT600M Support Tool Operation Manual | This manual covers methods for creating screens, including screen data preparation, switches, lights, and alarms. (for NT20M-ZASAT-EV4) | V004 |
| NT-series Host Interface Unit Direct Connection Operation Manual | This manual covers the Direct Connection feature which has been added to the Host Interface Unit. | V015 |
| NT-series RS-232C/RS-422A Interface Unit Operation Manual | This manual covers the commands, controls, and communications specifications for operating the NT20M and the NT600M with the RS-232C/RS-422 Interface Unit. Refer to this manual when programming host computer communications. | V016 |
| NT-series Support Tool Operation Manual | This manual covers methods for creating screens, including screen data preparation, switches, lights, and alarms. (NT-ZA3AT-EV2) | V028 |

1-4 Models

1-4-1 NT600M Programmable Terminals

There are three types of NT600M PTs, shown in the following table. There are also two types of display from which to choose.

| PT | Display device | Model number | System ROM | Screen data mem. |
|--------------------------|--------------------|--------------|---|---|
| Touch panel (DT) | LCD with backlight | NT600M-DT122 | Purchased separately. Varies according to which Host Interface Unit is installed. | Purchased separately. Screen data memory boards can be SRAM or IC sockets for commercially available EPROM or EEPROM. |
| | EL | NT600M-DT211 | | |
| Without touch panel (DN) | EL | NT600M-DN211 | | |
| Function Key Unit (DF) | LCD with backlight | NT600M-DF122 | | |

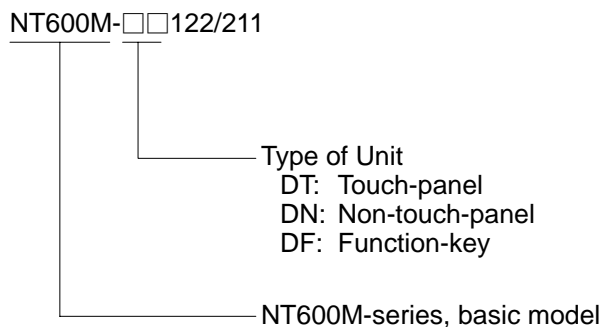

1-4-2 Screen Data Memory Boards

A Screen Data Memory Board is required for registering screen, character string, and numeric data. The Screen Data Memory Board is not built into the PT and must be purchased separately.

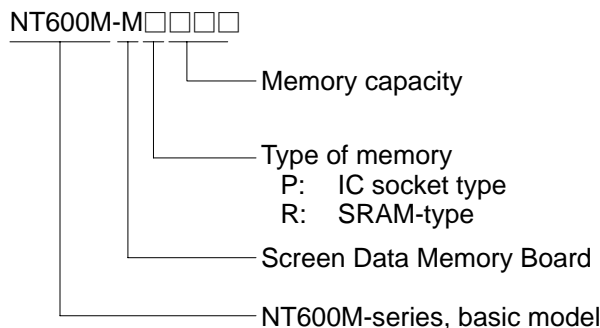

| Model | Type of memory | Memory capacity | Remarks |
|--------------|----------------|---------------------------|----------------------------|
| NT600M-MP251 | IC socket type | (Depends on memory chip.) | IC-socket for memory chip* |
| NT600M-MR641 | SRAM | 64K | Type and capacity fixed. |
| NT600M-MR151 | SRAM | 128K | Type and capacity fixed. |
| NT600M-MR251 | SRAM | 256K | Type and capacity fixed. |

Note *The NT600M-MP251 provides only an IC socket and is not equipped with a memory chip. The memory chip must be installed by the user.

Memory Chips

The memory chips that can be installed in the NT600M-MP251 IC socket are shown in the table below. Use either the model shown here or an equivalent.

If an equivalent is not used, the capacity of the memory backup battery may not be sufficient.

| Type | Memory capacity | Model | Recommended memory chips |
|--------|-----------------|-----------|-----------------------------|
| SRAM | 32K bytes | RAM22-15 | HM62256ALP-15 (Hitachi). |
| | 128K bytes | RAM13-10 | HM628128LP-10 (Hitachi). |
| EPROM | 64K bytes | ROM-KD-B | M5M27C512AK-12 (Mitsubishi) |
| | 128K bytes | ROM13-12B | HN27C101AG-12 (Hitachi). |
| | 256K bytes | ROM23-15B | M5M27C201K-15 (Mitsubishi) |
| EEPROM | 32K bytes | EER22-20 | HN58C256P-20 (Hitachi). |

Memory Capacity and Number of Screens

Screen memory capacity varies according to which Screen Data Memory Board is installed. The screen memory capacity, in turn, determines the number of screens that can be registered. Use the table below as a guide to select the amount of memory suitable for your needs.

| Screen memory capacity | Number of registered screens |
|------------------------|--|
| 32K bytes | Mostly messages: 40 screens Mostly graphics: 15 screens |
| 64K bytes | Mostly messages: 120 screens Mostly graphics: 40 screens |
| 128K bytes | Mostly messages: 250 screens Mostly graphics: 100 screens |
| 256K bytes | Mostly messages: 600 screens Mostly graphics: 200 screens |

Note The table above is strictly a guide. If the messages or other display data per screen increase, the number of screens that can be registered will decrease. Likewise, if the messages decrease, the number of screens that can be registered will increase.

1-4-3 System ROM

Purchase the System ROM according to the NT600M and Host Interface Unit models that are used.

| Host I/F Unit \ NT600M | NT600M-DT122/211 NT600M-DN122/211 NT600M-DF122 | NT600M-DT122 NT600M-DT211 |
|---|--|--|
| NT600M-LK201 (RS-232C) (see note 1) NT600M-LK202 (RS-422A) NT600M-LK201 (Host Link) (see note 1) NT600M-RT201 (SYSMAC BUS) | NT600M-SMR01-EV1 | --- |
| NT600M-LB122-V1 (C200H) (see note 1) | NT600M-SMR02-EV1 | --- |
| NT600M-LK201 (see note 1) (Host Link) | --- | NT600M-SMR31-E (Direct connection can be used when version 4 of the Support Tool is used.) |
| NT600M-LB122-V1 (C200H) (see note 2) | --- | NT600M-SMR32-E (Direct connection can be used when version 4 of the Support Tool is used.) |

- Note** 1. RS-232C Interface Units and Host Link Interface Units are the same (NT600M-LK201). Change the communications specifications by means of the internal DIP switch.

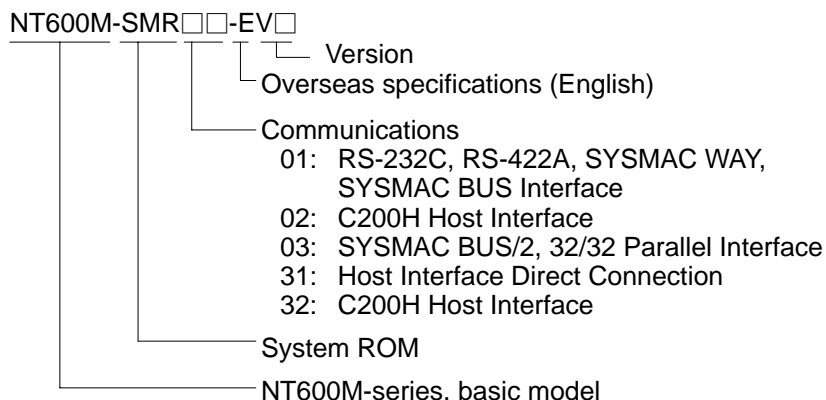

2. For the NT600M-LB122-V1, set the pin 4 of the Interface Unit's DIP switch SW2 ON or OFF to determine whether to allow direct connection or not.
 Without direct connection: Turn ON pin 4 of SW2
 With direct connection: Turn OFF pin 4 of SW2.

1-4-4 Host Interface Units

The Host Interface Unit provides the interface for communications between the PT and the host (either a Programmable Controller or an FA computer). The Host Interface Unit models that can be used with the NT600M PT are shown in the table below. Select the Host Interface Unit to match the communications specifications of the system.

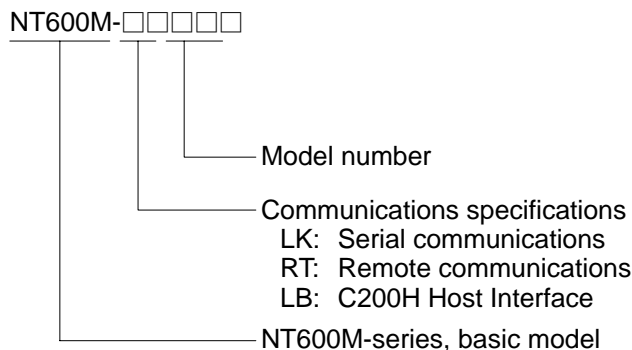

| Name | Model number | Remarks |
|---------------------------|-----------------|---|
| RS-232C Interface Unit | NT600M-LK201 | Connect for general-purpose communications with an FA computer or personal computer. For communications with a SYSMAC PC, connect to an ASCII Unit. |
| RS-422A Interface Unit | NT600M-LK202 | |
| SYSMAC BUS Interface Unit | NT600M-RT121 | Can be connected as a Slave Unit in a SYSMAC Wired Remote I/O System. |
| Host Link Interface Unit | NT600M-LK201 | Can communicate one-to-one with a SYSMAC Host Link Unit. |
| C200H Host Interface Unit | NT600M-LB122-V1 | Can be connected to a SYSMAC C200H, C20H, C40H, or C60H PC to provide the functions of an Expansion I/O Rack. |

1-4-5 12-key Function Key Units (for DN-type)

Function-key input for NT600M non-touch panel (DN) type models is made possible by attaching an NT600M-FK210 12-key Function Key Unit.

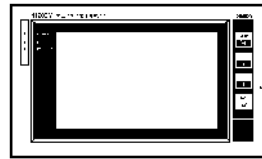

NT600M-DN211 PT
(Without touch panel)



NT600M-FK210
12-key Function Key Unit

1-5 Support Tools

NT600M screen data, memory table data, and system data are all created by the Support Tool. In order to fully utilize the functions of the NT600M PTs, use the NT-ZA3AT-EV2 Support Tool or a version of NT20M-ZASAT-EV4 or higher.

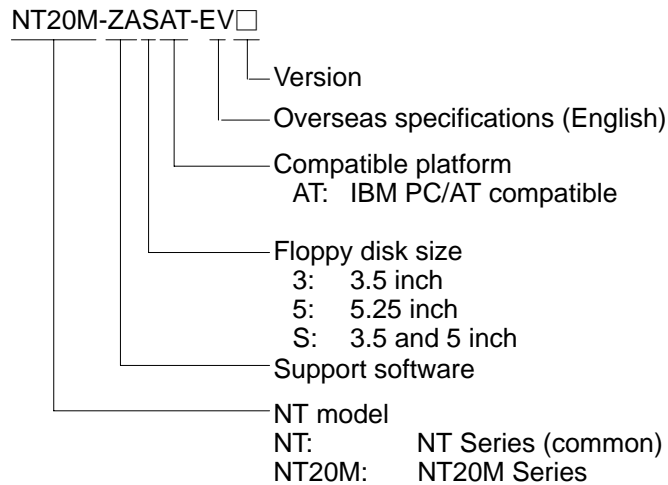

Contrast Between Functions when New and Old Versions of Peripheral Devices are Used

(1) I/O Functions

| Function | NT20M-ZASAT Support Tool | | NT600M-SMR□□□ System ROM | | PT Models | Remarks |
|--|--------------------------|------|--------------------------|----|--------------|---|
| | -EV4 onwards | -EV1 | -EV1 | -E | | |
| Lamps (bit designation) Display attributes: Lit or flashing | ● | X | ● | X | All models | X: Only "lit" is available for bit designation control. |
| Touch switches: Reverse video display during input (yes or no) | ● | X | ● | X | DT-type only | X: Setting not possible. |
| Standalone function | ● | X | ● | X | All models | X: Cannot be used. |

(2) Display Functions

| Function | | NT20M-ZASAT Support Tool | | NT600M-SMR□□□ System ROM | | PT Models | Remarks |
|--|---|-------------------------------|---------------|-----------------------------|-----------------------------|---|-----------------------------------|
| | | -EV4 onwards | -EV1 | -EV1 | -E | | |
| Bar graphs | Vertical and horizontal display | ● | X | ● | X | All models | X: Horizontal only. |
| | Display width enlargement (2 to 255 dots) | | | | | | X: Select either 8 or 16 dots. |
| | +/- display | | | | | | X: + direction only. |
| | % value enlargement display | | | | | | X: Equivalent display only. |
| Lamp display: Rectangular or circular | X: Rectangular only. | | | | | | |
| Lamps/touch switches: Guide character mark input | X: Mark input not possible. | | | | | | |
| Touch switches: Solid or rectangular frame | DT-type only | X: Rectangular frame only. | | | | | |
| Numeric setting 10-key layout | ● | X | ● | X | All models (See note 1.) | Only when the screen attribute "10-key" is set to "User." | |
| Numeric display enlargement (64x max.) | ● | X | ● | X | All models | X: Equivalent display only. | |
| Direct connection | See note 3. | | SMR 31-E/32-E | | DT-type only | | |

Notes 3. Some restrictions may apply, depending on the PT model.

4. In order to use the direct connection function, a Support Tool version of "-EV4" or higher must be used.

1-6 System Configuration

In order to operate the NT600M, connect a personal computer or a Programmable Controller, to serve as a host, to the Host Interface Unit (sold separately) at the back of the NT600M. For details on connecting the Host Interface Unit, and on host programs, refer to the *Host Interface Unit Operation Manual*.

The following interfaces can be used for communications: RS-232C, RS-422A, Wired Remote I/O System (SYSMAC BUS), Host Link System (SYSMAC WAY), or C200H Host Interface. A Screen Data Memory Board, NT600M-MP/MR□□□, is also required and must be purchased separately.

RS-232C Interface

Using the NT600M-LK201 Host Interface Unit, the Programmable Terminal can be connected one-to-one to a personal computer or to an ASCII Unit mounted to a Programmable Controller.

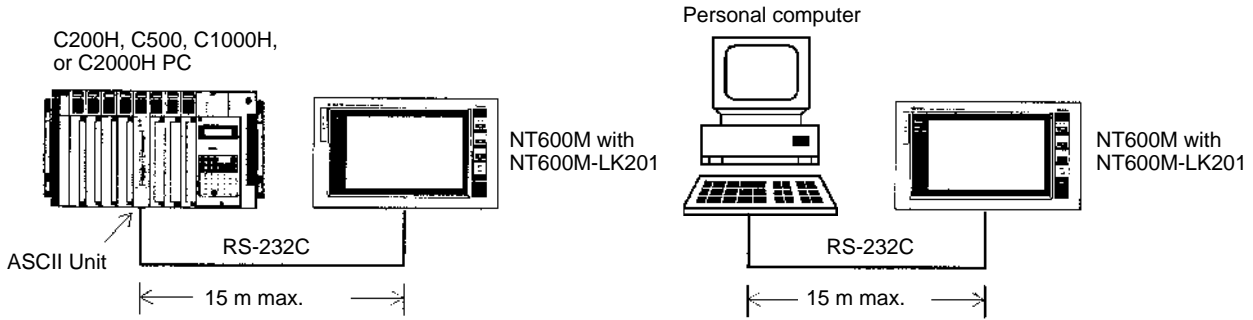

RS-422A Interface

Using the NT600M-LK202 Host Interface Unit and 3G2A9-AL004-(P) and 3G2A9-AL001 Link Adapters, up to 16 Programmable Terminals can be connected to a PC through an ASCII Unit, or to an FA computer.

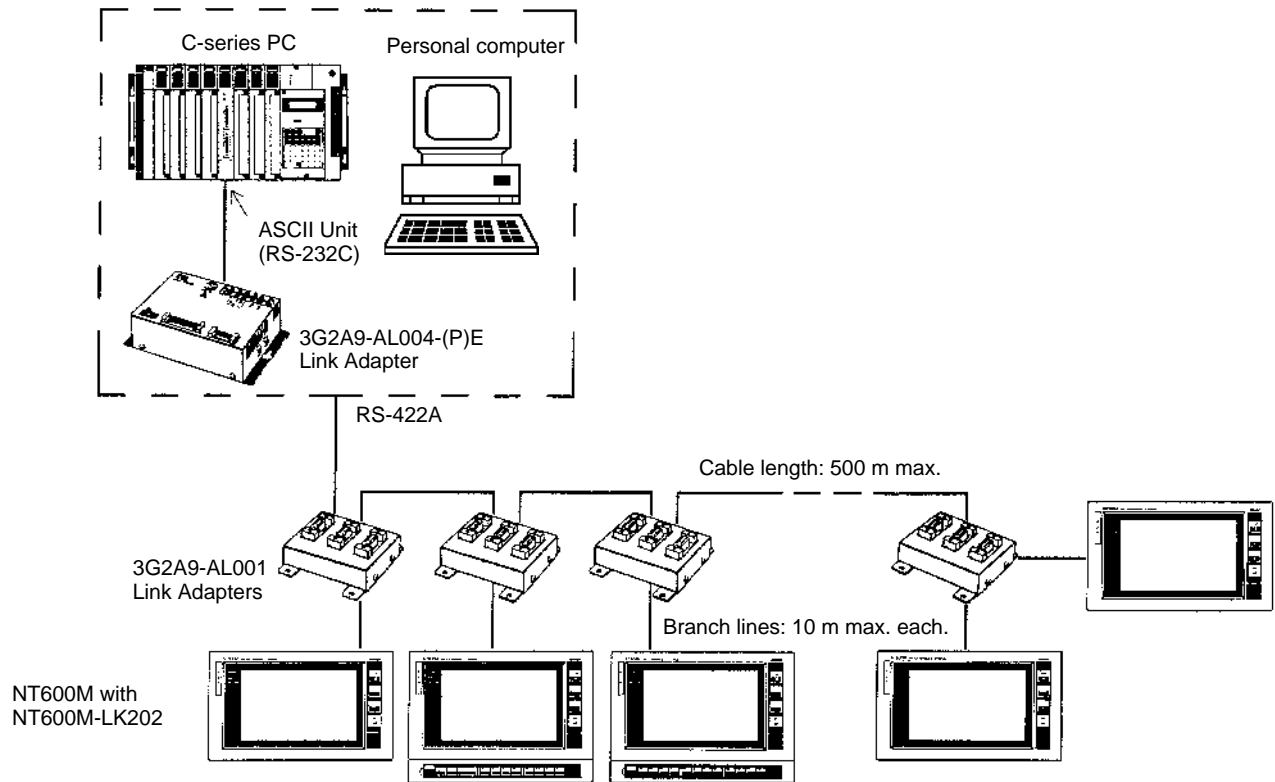

Host Link Interface

Using the NT600M-LK201 Host Interface Unit, the Programmable Terminal can be connected one-to-one to a Host Link Unit mounted to a Programmable Controller.

Mini H-type, C200H, C500, C1000H, C2000H PC

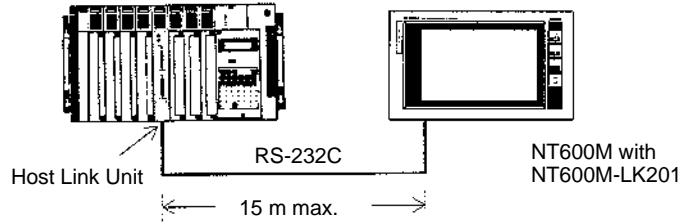

SYSMAC BUS Interface

Using NT600M-RT121 Host Interface Units, up to 8 Programmable Terminals can be connected to a PC through a Wired Remote I/O Master Unit.

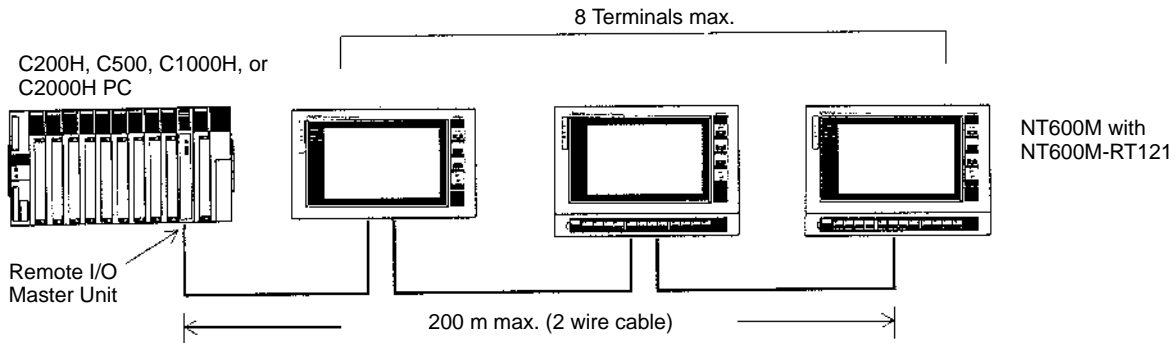

C200H Host Interface

With an NT600M-LB122-V1 (for direct connection) Interface Unit, the interface is set up simply by connecting one-to-one with C200H-CN221 Connection Cable to a C200H CPU Rack or Expansion I/O Rack. It is also possible to connect a PT to a C20H, C28H, C40H, or C60H CPU Unit or I/O Units. Be sure to use a noise filter when connecting C□□H. Refer to the *Host Interface Units Operation Manual* for details.

Be sure to use a noise filter (TDK's ZGB2202-O1U or equivalent) when connecting to the Mini H-type PC.

- 1, 2, 3...**
1. The noise filter must be inserted into the power line of the Mini H-type PC.
 2. The distance between the noise filter and the Mini H-type PC must be as short as possible.
 3. Keep the noise filter away from high-tension lines.
 4. The case of the noise filter must be grounded to the FG terminal of the Mini H-type PC.

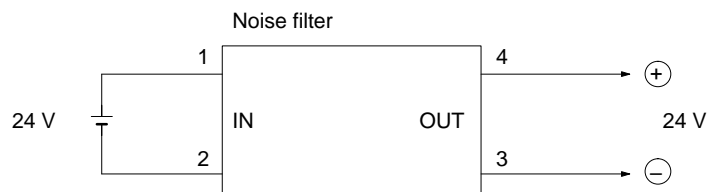

In a C200H PC System, you can ordinarily connect two Expansion I/O Racks to the CPU Rack. The C200H Host Interface Unit itself, however, functions as an Expansion I/O Rack, and therefore when using a C200H Host Interface Unit, you can only connect one other Expansion I/O Rack. (If the CPU Rack is either C200H-CPU02 or C200H-CPU22, it is not possible to connect both an Expansion Rack and a PT.)

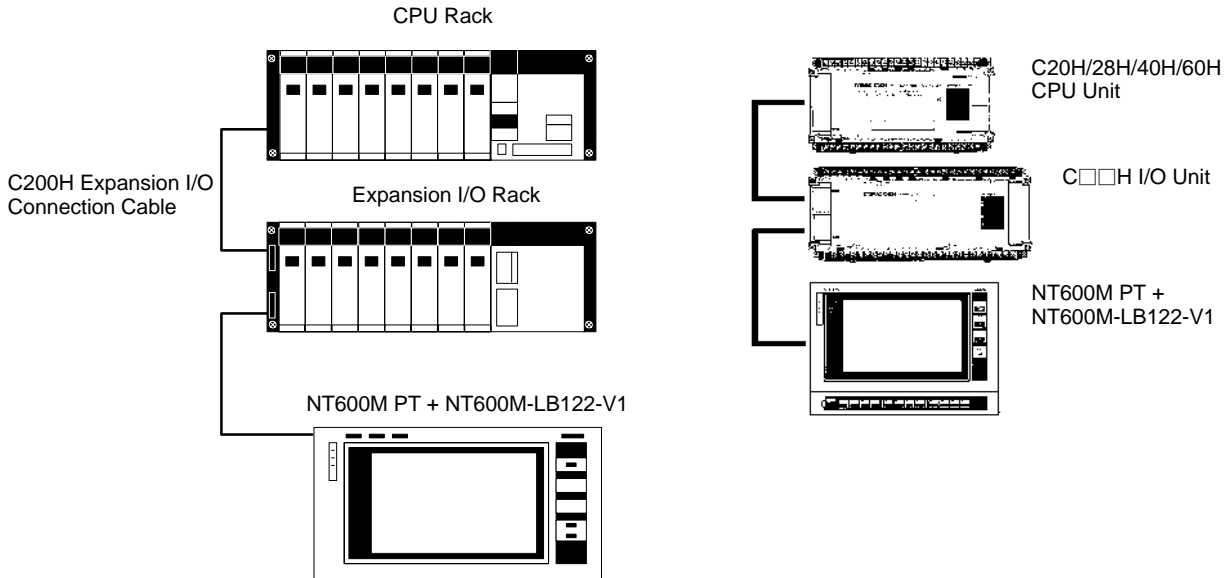

1-7 Nomenclature and Functions

1-7-1 Front Panel

The illustrations below show the front panels of PTs with and without touch panels (i.e., DT-type and DN-type PTs) and PTs with function keys (i.e., DF-type PTs). A 12-key Function Key Unit can be attached to a DN-type PT to give it the same outer appearance and functions of a DF-type PT.

NT600M-DT/DN□□□: Programmable Terminals With and Without a Touch Panel

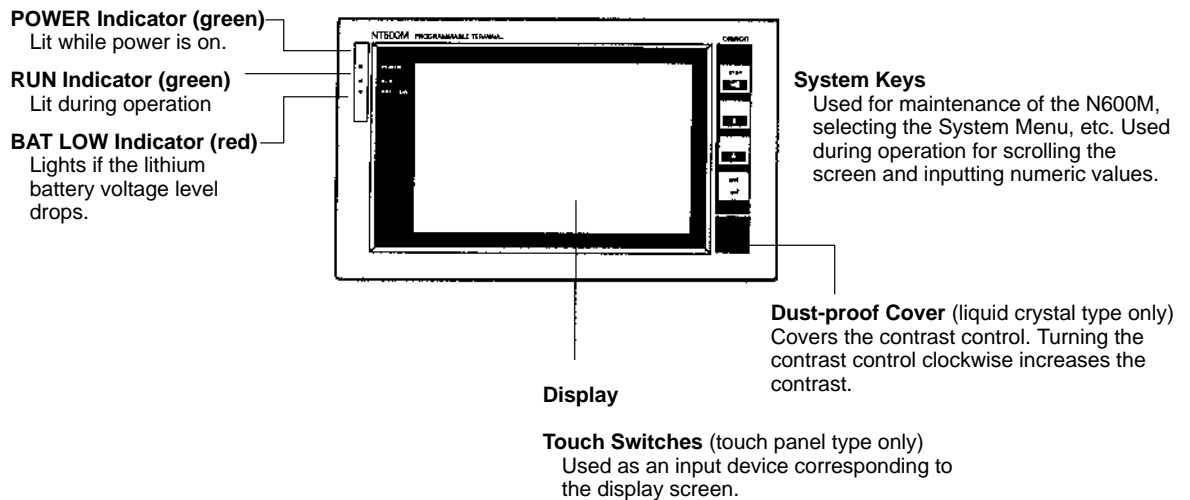

NT600M-DF122: Programmable Terminals with Function Keys

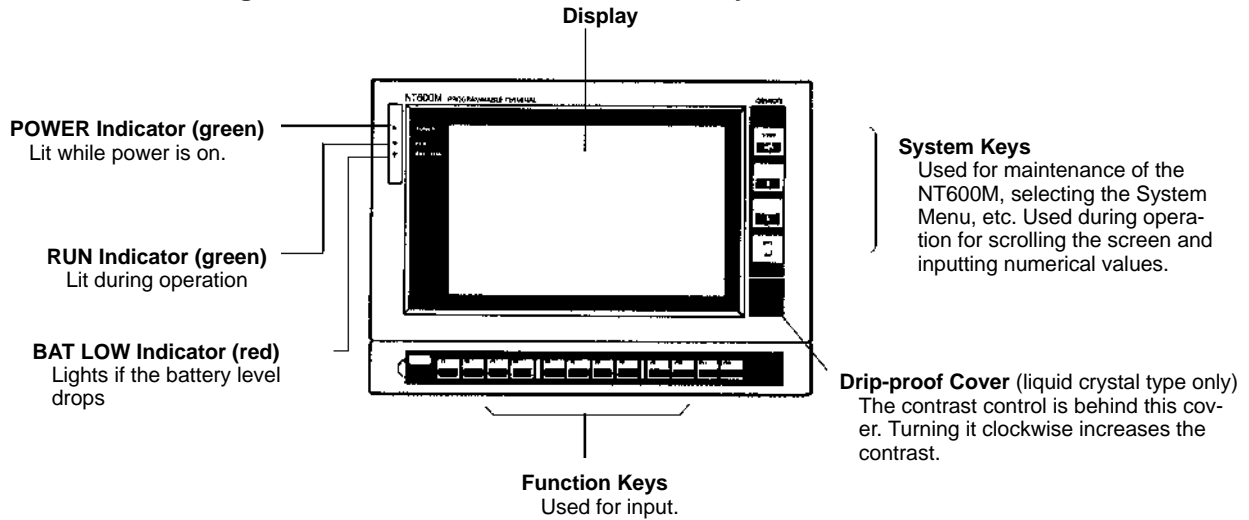

Note The operation of the BAT LOW LED will be unstable if a battery is not installed.

1-7-2 Rear Panel

All Models (NT600M-DT/DN/DF□□□□)

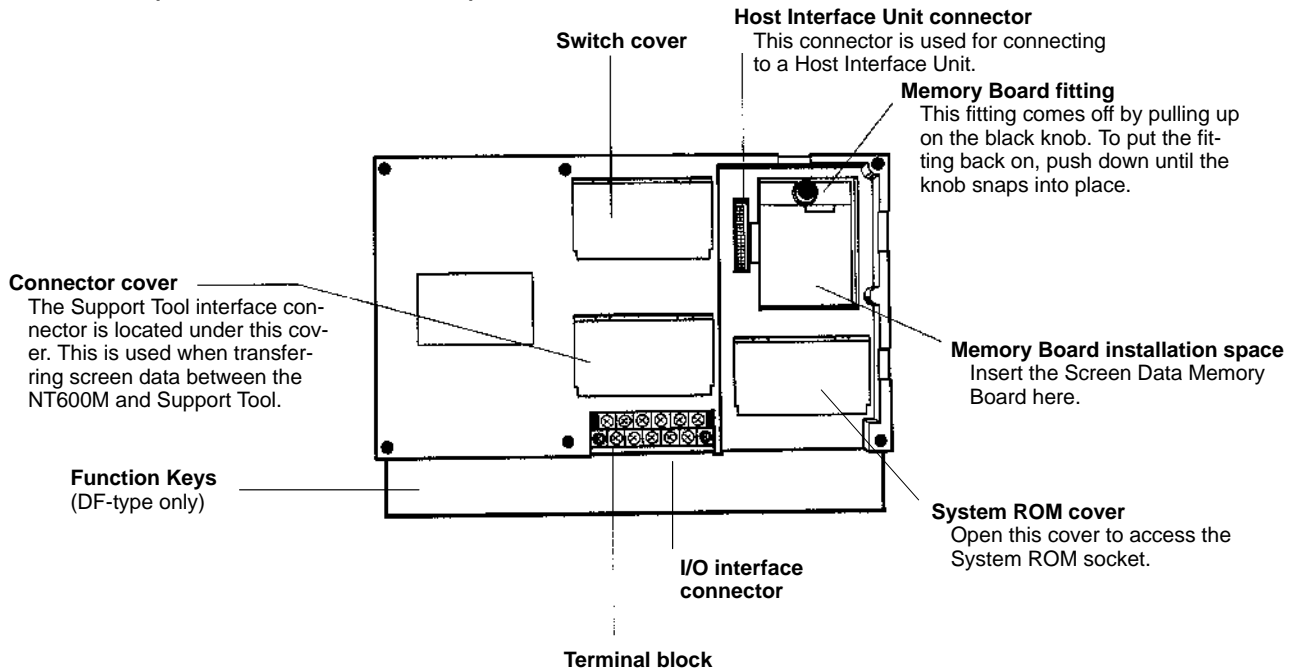

Switch Cover Area

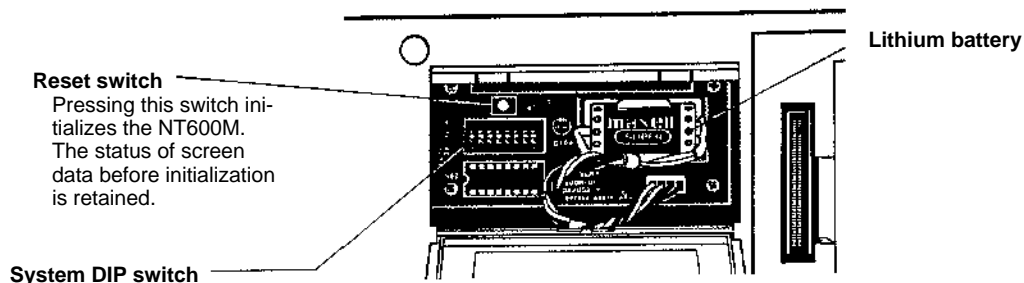

SECTION 2

Switch Settings, Installation, and Wiring

This section provides procedures to set hardware switches and install the PT.

| | | |
|-------|---|----|
| 2-1 | Switch Settings | 16 |
| 2-1-1 | System DIP Switch Settings (SW1) | 16 |
| 2-1-2 | Mounting System ROM | 17 |
| 2-1-3 | Screen Data Memory Board Settings and Installation | 18 |
| 2-2 | Installation Environment | 20 |
| 2-2-1 | Installation Site | 20 |
| 2-2-2 | Mounting Position | 21 |
| 2-3 | Dimensions | 22 |
| 2-3-1 | Terminals with Function Keys (DF-type) | 22 |
| 2-3-2 | PTs With (DT-type) and Without (DN-type) Touch Panels | 23 |
| 2-4 | Installing the NT600M PT in a Panel | 23 |
| 2-5 | Wiring and Connectors | 25 |
| 2-5-1 | Terminal Block | 25 |
| 2-5-2 | AC INPUT Terminals | 25 |
| 2-5-3 | LG and GR Terminals | 26 |
| 2-5-4 | HOST RUN INPUT Terminals | 26 |
| 2-5-5 | ALM OUTPUT Terminals | 27 |
| 2-6 | RS-232C Interface Connector | 27 |
| 2-7 | 12-key Function Key Units (for DN-type PTs) | 28 |
| 2-8 | Mounting Function Key Units (to DN-type PTs) | 28 |

2-1 Switch Settings

There are switches to set under the switch cover on the back of the Terminal and also on the Host Interface Unit. For Host Interface Unit switch settings, refer to the *Host Interface Unit Operation Manual*.

2-1-1 System DIP Switch Settings (SW1)

The 8-position DIP switch for system settings is located under the DIP switch cover on the back of the Terminal. Be sure that power is off when changing switch settings.

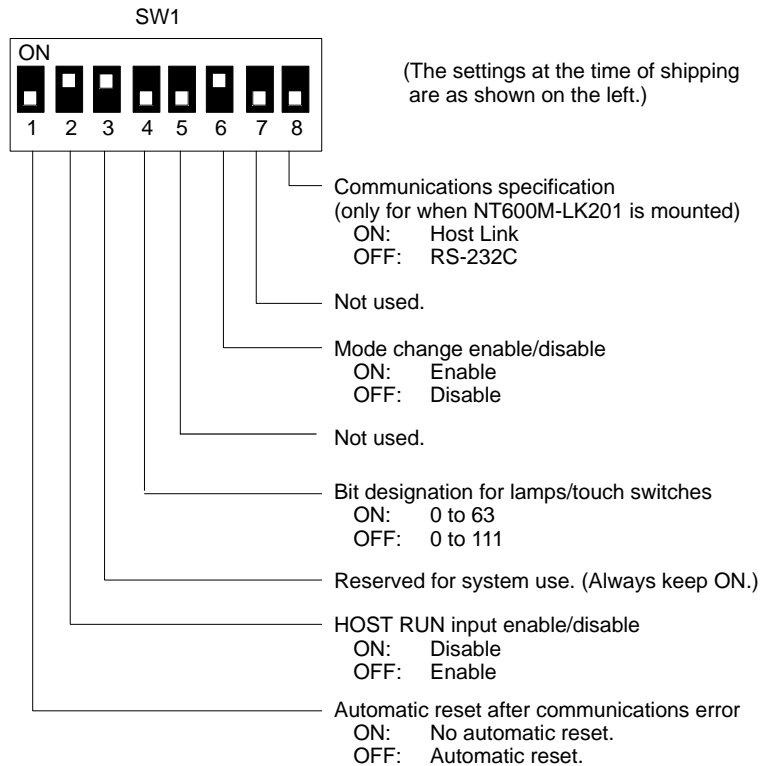

| Pin no. | Setting | Content |
|---------|---|--|
| 1 | Automatic reset after communications error. ON: No automatic reset. OFF: Automatic reset. | “Automatic reset” means that, when an error occurs, no error message will be displayed and the next command will be executed when received. “No Automatic reset” means that, when an error occurs, an error message will be displayed and operation will stop. If an RS-232C or RS-422A Interface Unit is mounted, the host will be notified that an error occurred and there will be no automatic reset regardless of whether this pin is set to ON or OFF. |
| 2 | Host RUN input enable/disable ON: Disable OFF: Enable | If this pin is turned OFF, then the host RUN input will be enabled and PT operation can be controlled by external sequences. If this pin is set to ON, the PT will operate but when the host RUN input turns OFF, Host Error will be displayed and operation will stop. |
| 3 | ON | This pin is reserved for system use, and must remain set to ON. If this pin is set to OFF, messages will not display properly. |
| 4 | Bit designation for lamps and touch switches | This pin designates the bits for lamp and touch switch display control for when Host Link Interface Units or C200H Host Interface Units are used. |
| 5 | Not used. | --- |
| 6 | Mode change enabled/disable ON: Enable OFF: Disable | “Mode change” refers to changing between the System Menu and Transmit Mode, Maintenance Mode, or RUN Mode. When an RS-232C or RS-422A Host Interface Unit is used, mode changes can be prohibited by means of a command from the host. |
| 7 | Not used. | --- |
| 8 | Communications specification setting (only when NT600M-LK201 is used) ON: Host Link Unit OFF: RS-232C | The NT600M-LK201 can be used as either a Host Link Interface Unit or an RS-232C Interface Unit. Operation will not be possible if the setting of this switch does not match the communications system. If another type of Host Interface Unit is mounted, this setting will be ignored. |

2-1-2 Mounting System ROM

Turn off the power supply to the PT and mount the System ROM into the PT as described below.

- 1, 2, 3... 1. Open the System ROM cover on the back of the PT.

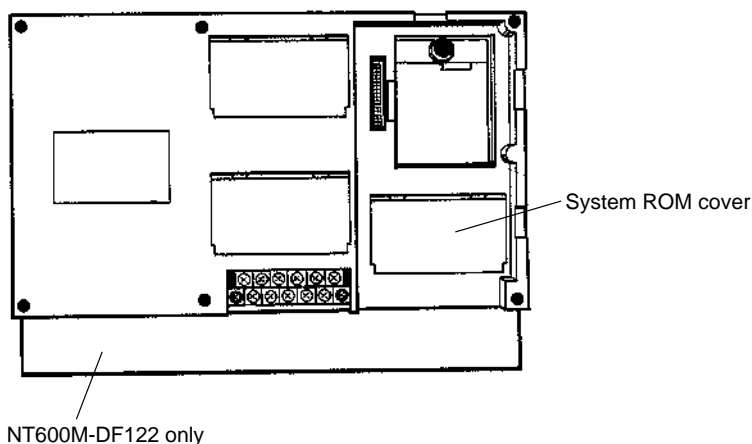

- When the System ROM cover is opened, the IC socket will be exposed. Turn the tightening screw (located to the left of the IC socket) to align the slot with the O (open).

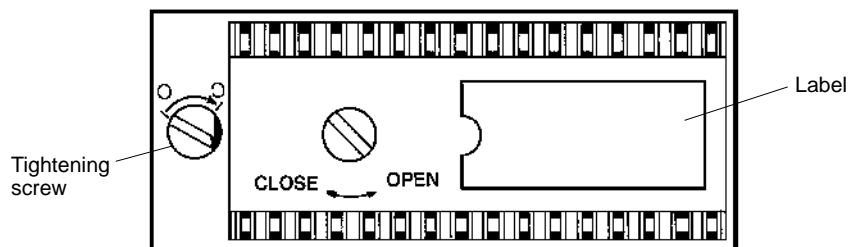

- Mount the ROM to the socket in the direction indicated on the label and turn the tightening screw clockwise to the C (close) secure the ROM.

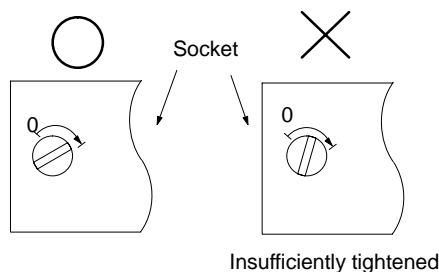

Caution The ROM may be destroyed if mounted while power is being supplied to the PT. Turn off the power supply before mounting the System ROM.

- Notes**
- The PT may not operate properly if the IC socket is not completely secured. Be sure to install the System ROM securely.
 - OMRON reserves all copyrights to the programs on the System ROM. Copying these programs is forbidden.

2-1-3 Screen Data Memory Board Settings and Installation

There are two types of Screen Data Memory Board: SRAM type and IC socket type. The NT600M-MP251 Screen Data Memory Board does not come with a memory chip installed, and the memory chip must be purchased separately.

The memory type and capacity must be set for the NT600M-MP251. Switches SW M1 and SW M2 are used to set the type and capacity of the screen data memory chip installed in the top socket of the Screen Data

Memory Board. Set these switches to match the memory chip which is installed.

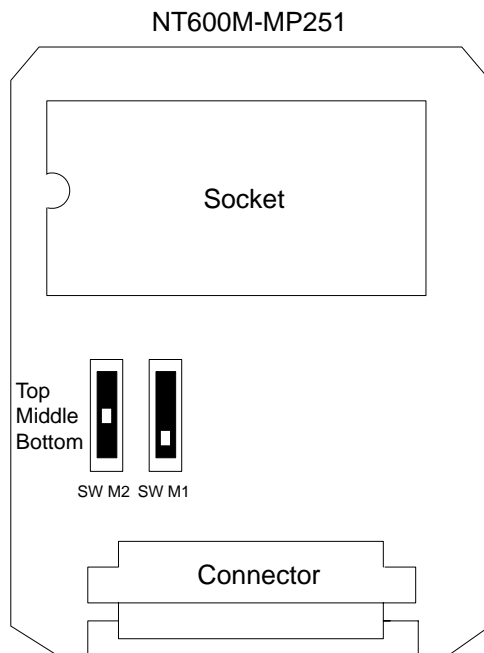

The factory-set default setting is shown at the left.

Settings

| SW M2 | SW M1 | Screen data memory |
|--------|--------|--------------------|
| Top | Bottom | 64K, EPROM |
| Middle | Bottom | 128K, EPROM |
| Bottom | Bottom | 256K, EPROM |
| Top | Middle | 32K, EEPROM |

- Note**
1. Be sure that the power is off when changing the settings. If settings are made with the power on, memory may be lost or damaged.
 2. Carefully check the switch settings and the memory chip before turning the power on. If the memory is different from that specified on the switch settings, the PT will not operate correctly.

Installation

Install the Screen Data Memory Board in the order shown below. If the Host Interface Unit is mounted, remove it before installation.

- 1, 2, 3...**
1. Turn off the power supply to the PT.

- Place the Screen Data Memory Board on the main rail, push the spacer in the direction of the arrow until it makes a clicking sound, and line the board up with the connector.

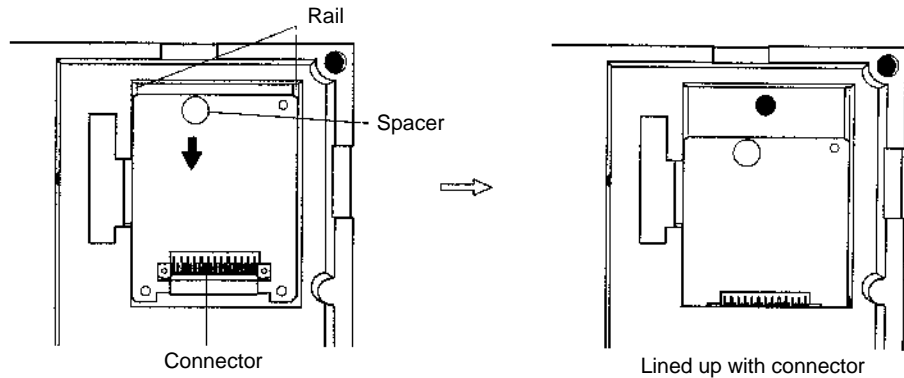

- Holding the Memory Board's installation fitting as shown in diagram A, insert the black latch on the bottom into the hole in the main unit and press the black knob down until it clicks into place.

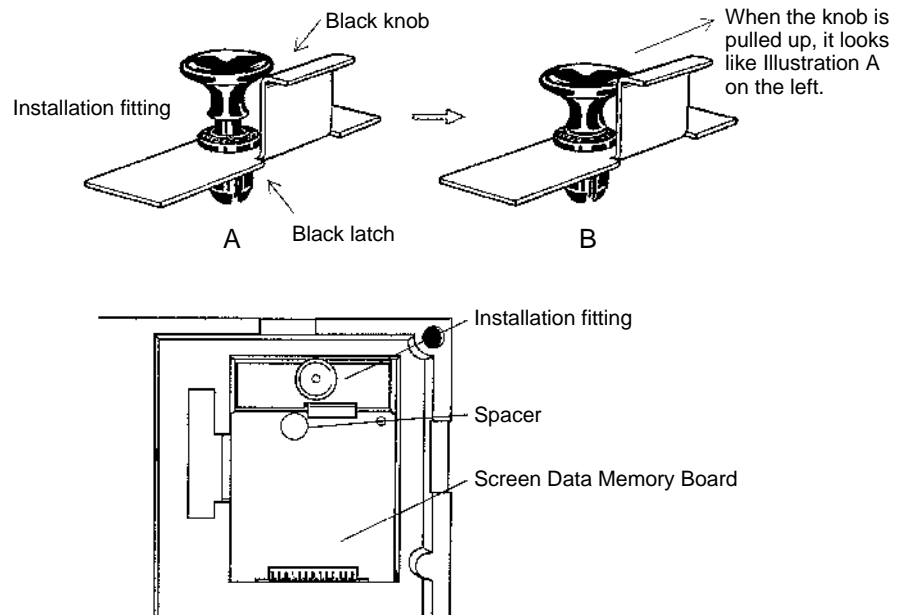

When removing the Screen Data Memory Board, first turn off the power to the PT and then remove the installation fitting by pulling up on the black knob. Then pull the Memory Board's spacer in the opposite direction of that shown above and take out the Memory Board.

2-2 Installation Environment

The NT600M has strong environmental resistance and high reliability, but you can maximize system reliability and make the most of its functions by observing the following considerations during installation.

2-2-1 Installation Site

Avoid installing the NT600M where any of the following conditions exist.

- Ambient temperatures exceeding a range of 5°C to 40°C for liquid crystal display PTs or 0°C to 50°C for EL display PTs.
- Abrupt temperature changes and condensation.

- Relative humidity exceeding a range of 35% to 85%.
- Corrosive or inflammable gasses.
- Strong magnetism.
- Excessive dust, salt, or iron dust.
- Direct vibration or shock.
- Direct sunlight.
- Spray from water, oil, or chemicals (the front panel is basically drip-proof).

2-2-2 Mounting Position

Mounting Location

PTs with LCD display have a field of vision of 20° up, 30° down, and 30° right and left. Install the Terminal at a height and direction that make it easy for the operator to see.

Ambient Temperature

The ambient operating temperature range is 5°C to 40°C for liquid crystal display PTs and 0°C to 50°C for EL display PTs. Take the following factors into consideration.

- Leave sufficient ventilation space.
- Do not install directly above machinery that puts out a lot of heat (e.g., heaters, transformers, high-capacity resistors).
- If the ambient temperature of a PT with LCD display rises above 40°C or that of a PT with EL display rises above 50°C, set up a fan or air conditioner.

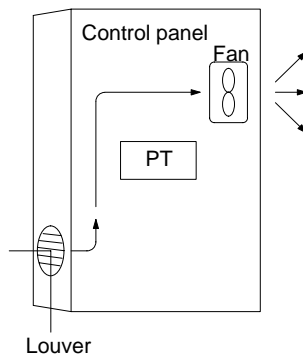

Operation and Maintenance

For safety during operation and maintenance, place the Terminal as far as possible from high-voltage machinery and power equipment.

Improving Noise Resistance

Do not install in a panel with high-voltage devices and install at least 200 mm from electric power lines. To avoid noise interference from external devices, separate them with a transformer or noise filter when wiring.

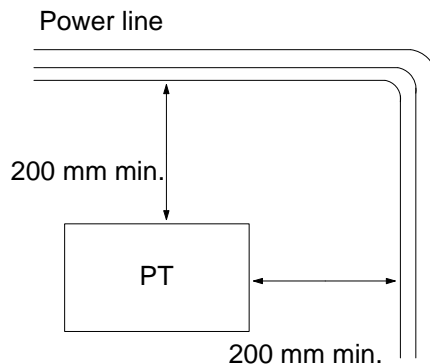

- When installing the Terminal near devices with strong electrical or magnetic fields (such as solenoids), allow a distance of at least 40 mm, more if necessary.

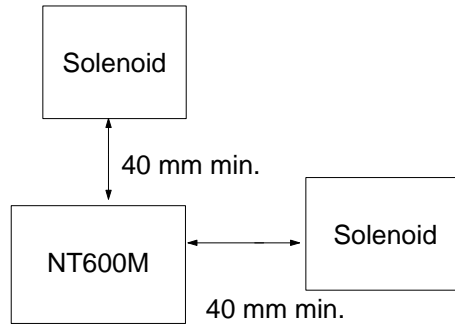

2-3 Dimensions

All dimensions are in millimeters.

2-3-1 Terminals with Function Keys (DF-type)

The dimensions illustrated below are for PTs with function keys (i.e., DF-type PTs). PTs without a touch panel (i.e., a DN-type PT) will have the same outer appearance and dimensions as a DF-type PT.

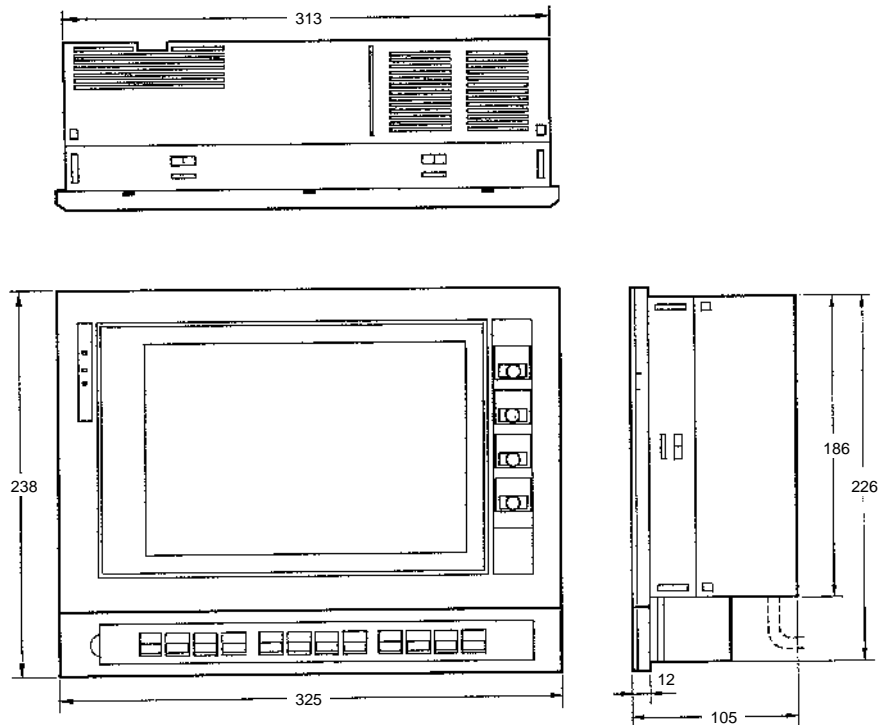

2-3-2 PTs With (DT-type) and Without (DN-type) Touch Panels

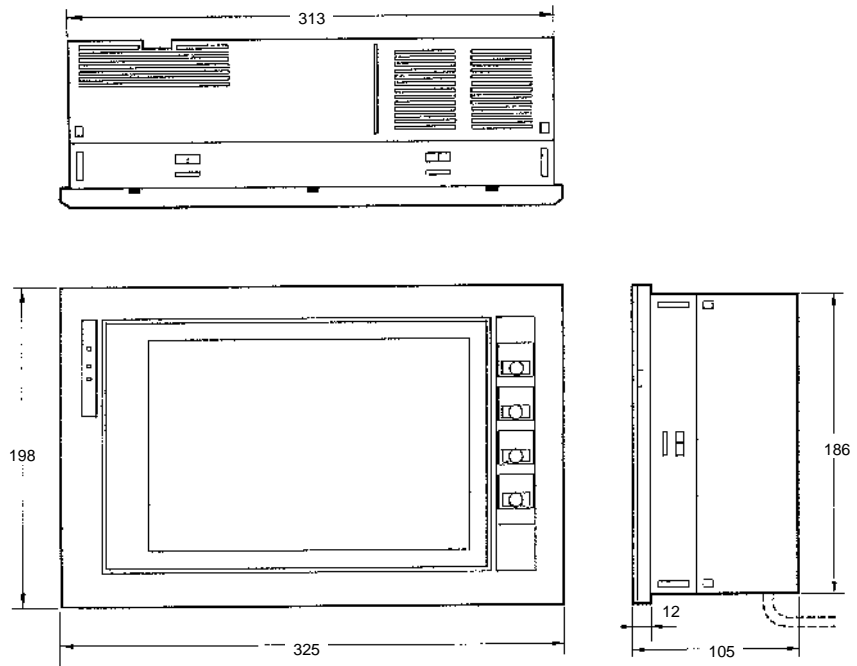

2-4 Installing the NT600M PT in a Panel

The NT600M is designed to be inserted in a panel. Install as follows:

- 1, 2, 3... 1. Cut a hole in the panel in accordance with the recommended dimensions shown below. The panel should be between 1.6 and 4.8 mm thick. All dimensions are in millimeters.

NT600M-DF122 or NT600M-DN□□□ + 12-key Function Key Unit

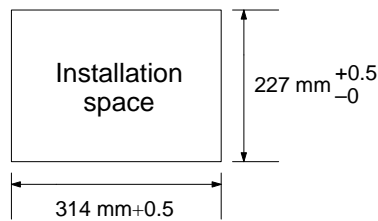

NT600M-DT□□□/DN□□□

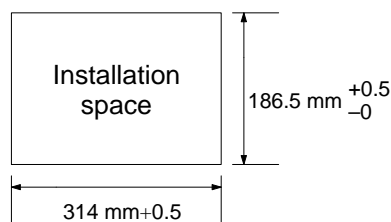

2. Insert the PT into the hole from the front of the panel.

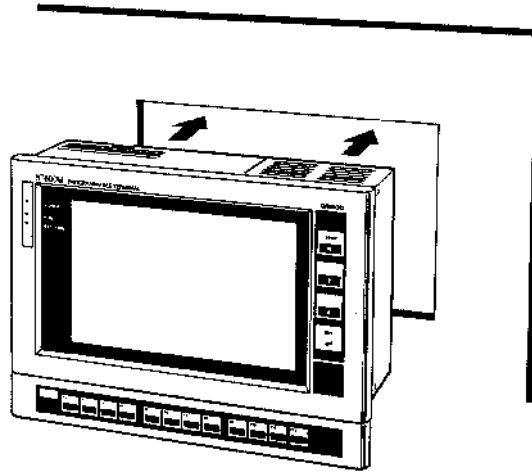

3. Use the accessory metal fittings and tool to fasten the PT to the panel surface. Do not use a screwdriver. A screwdriver may damage the fittings or the PT.

After setting the PT in the panel, secure it as shown below.

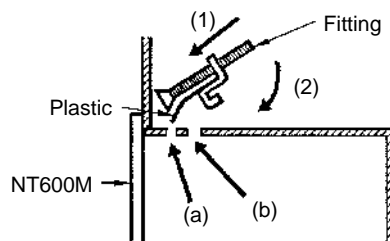

- (1) First pass the plastic part of the fitting through slot (a).
- (2) Next, put the hook of the fitting into slot (b) and pull so that the leg catches in the PT case.

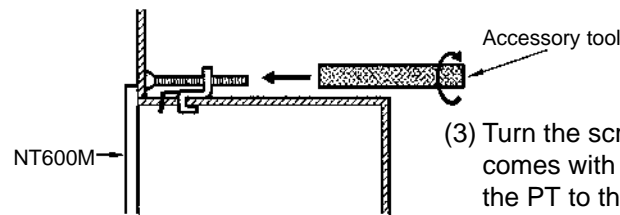

- (3) Turn the screw with the tool that comes with the PT, and secure the PT to the panel. There are six places to be secured. When you are finished, rotate the tool in the inverse direction and remove it from the screw.

4. To remove the PT from the panel, use a flat-blade screwdriver.

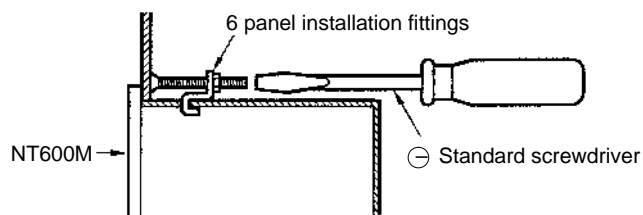

2-5 Wiring and Connectors

2-5-1 Terminal Block

The terminal block shown in the following illustration is located on the PT's rear panel.

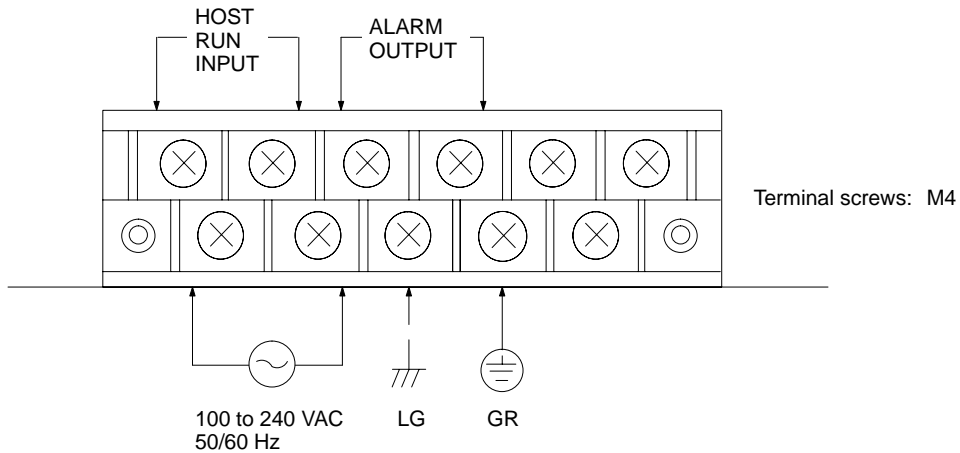

Use crimp-style terminals for wiring. If twisted wires are connected directly, there is a possibility of poor contact or short-circuiting. Use crimp-style terminals with holes to match M3.5 screws.

Fork-type

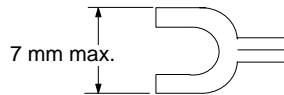

Round-type

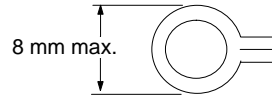

Recommended Crimp-style Terminals

| Maker | Fork-type | Round-type | Conforming wire (twisted) |
|-------------------------------|-----------|------------|------------------------------|
| Japan Solderless Terminal MFG | 2-YS3A | 2-3.5 | 1.04 to 2.63 mm ² |
| Fuji Terminals | 2-YAS3.5 | V2-S3.5 | |
| Nichifu Terminals | 2Y-3.5 | 2-3.5 | |

2-5-2 AC INPUT Terminals

These terminals are the power supply input terminals to run the NT600M.

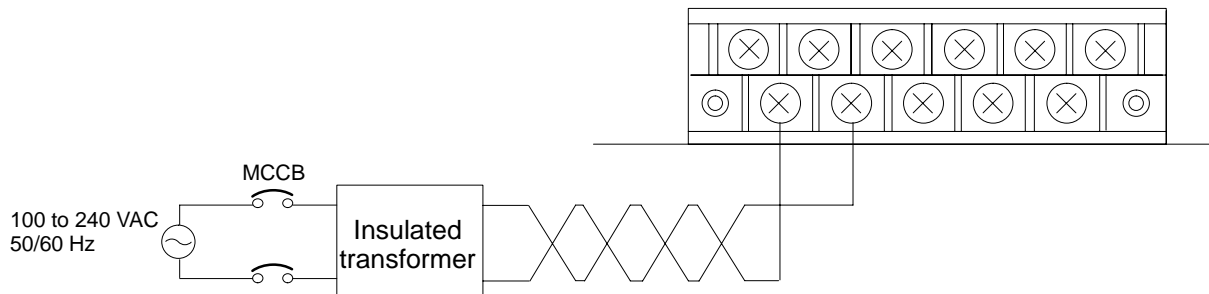

Power Supply Wiring

- Provide a 100 to 240 VAC power.
- Use a power supply within the allowable voltage range.

| Power supply voltage | Allowable voltage range |
|----------------------|-------------------------|
| 100 to 240 VAC | 85 to 264 VAC |

- Insulated Transformer
The NT600M has built-in anti-noise features which are sufficient for handling general noise from power lines, but ground noise can be greatly reduced by supplying power through a 1:1 insulated transformer. The secondary side of the insulated transformer should be an isolated neutral system.
- Power Capacity
Use a rated power supply (100 to 240 VAC; 50/60 Hz) of at least 50 VA.
- If power lines are long, then use wires of at least 2 mm² to avoid a drop in voltage.
- Use twisted-pair cables.

2-5-3 LG and GR Terminals

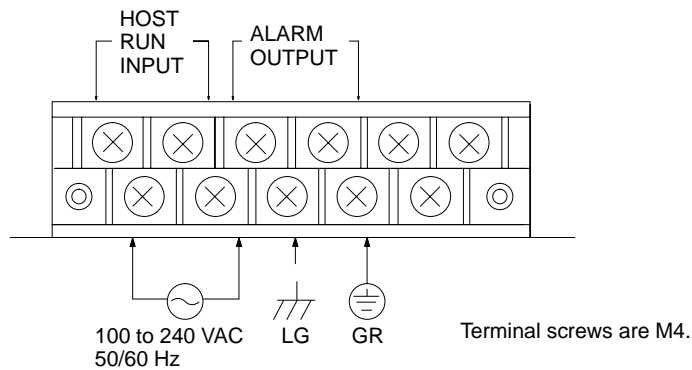

- GR is the ground terminal. In order to avoid electric shock, use separate ground wire (at least 2 mm²) and a class-3 ground (ground resistance 100 W or less).
- LG is the noise filter neutral terminal. If malfunction results from excessive noise, or to prevent electrical shock, short-circuit LG and GR and use a class-3 dedicated ground.
- The ground line should be 20 m or less.
- Sharing a ground line with other machinery or grounding to the girders of a building may be harmful.

2-5-4 HOST RUN INPUT Terminals

Use the HOST RUN INPUT when you want to monitor the RUN status of the host.

- Enable: Turn OFF SW1, pin 2.
- Disable: Turn ON SW1, pin 2.

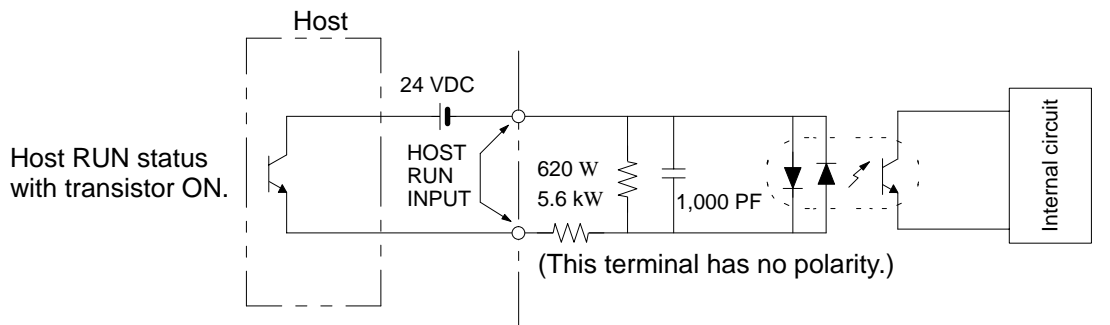

| Item | Content |
|---------------------|----------------------------|
| Rated input voltage | 24 VDC +10%/−15% |
| Input impedance | 5.6 kW |
| Input current | 4.1 mA typical (at 24 VDC) |
| ON voltage | 14.4 V min. |
| OFF voltage | 5.0 V max. |

If host RUN input goes OFF when this terminal is enabled, a host error is displayed regardless of other conditions and processing is halted. This status is maintained until the host RUN is restored. When errors are displayed on the PT screen, it allows for rapid recognition of problems at the host.

2-5-5 ALM OUTPUT Terminals

DC Load

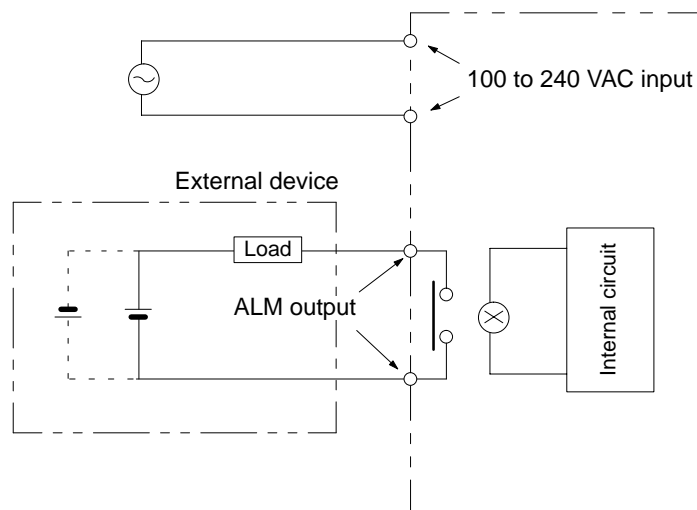

| Item | Content |
|----------------------------|-----------------------------------|
| Output type | Relay output |
| Rated load | 0.5 A at 100 VAC or 1 A at 24 VDC |
| Maximum load current | 1 A |
| Minimum switching capacity | 10 mA at 5 VDC |

2-6 RS-232C Interface Connector

The RS-232C interface connector is used during communications between the NT600M and Support Tool. It is located under the RS-232C interface connector cover on the back of the NT600M.

Pin Allocation

| Pin no. | Symbol | Name |
|---------|--------|-------------------------|
| 1 | FG | Frame Ground (not used) |
| 2 | SD | Send Data |
| 3 | RD | Receive Data |
| 4 | RS | Request to Send |
| 5 | CS | Clear to Send |
| 9 | SG | Signal Ground |

Connection Diagram

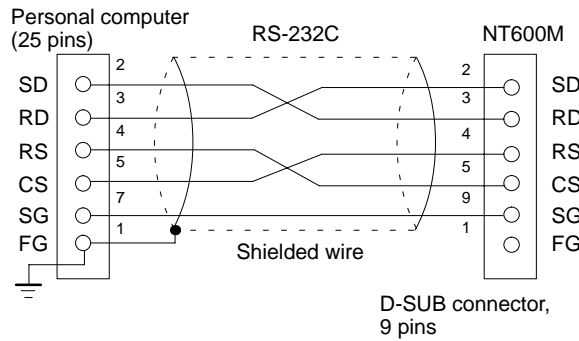

Note RS-232C communications conditions are set automatically by the Support Tool. Connectors can be put on and taken off even with power on.

Applicable Connectors (Cable Side)

Plug: XM2A-0901 (OMRON) or equivalent.
 Hood: XM2S-0911 (OMRON) or equivalent.

Recommended Cable

AWG28 x 5P IFVV-SB (Fujikura, Ltd.)
 CO-MA-VV-SB 5P x 28 AWG (Hitachi Cable, Ltd.)

Cable Set

CV500-CN228 (OMRON)
 Cable length: 2 m

2-7 12-key Function Key Units (for DN-type PTs)

12-key Function Key Unit (NT600M-FK210)

12-key Function Key Units can be connected to NT600M-DN122-E and NT600M-DN211-E Programmable Terminals.

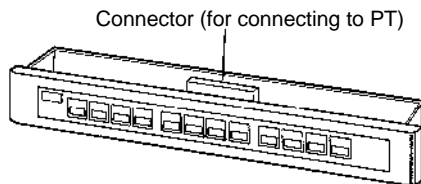

PT mounting screws and rubber packing are included with 12-key Function Key Units.

2-8 Mounting Function Key Units (to DN-type PTs)

Mounting Procedure

- 1, 2, 3... 1. Remove the rubber packing and bottom connector seal from the DN-type PT.
2. Mount the 12-key Function Key Unit to the PT, matching the connectors. Using a Phillips screwdriver, tighten the five mounting screws.

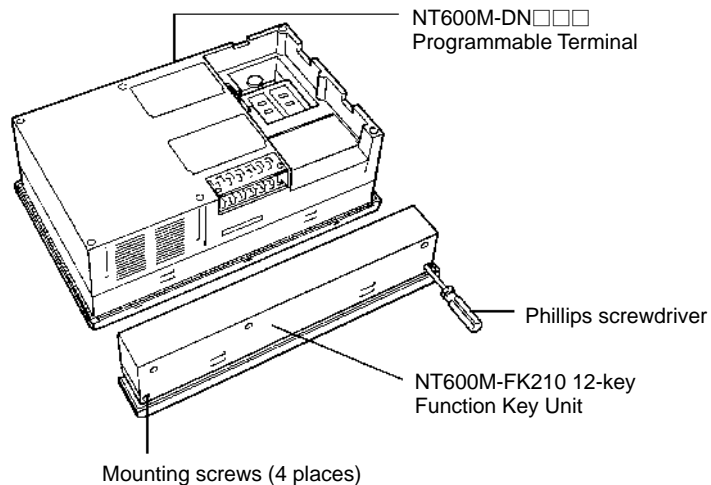

3. Attach the rubber packing that comes with the 12-key Function Key Unit.

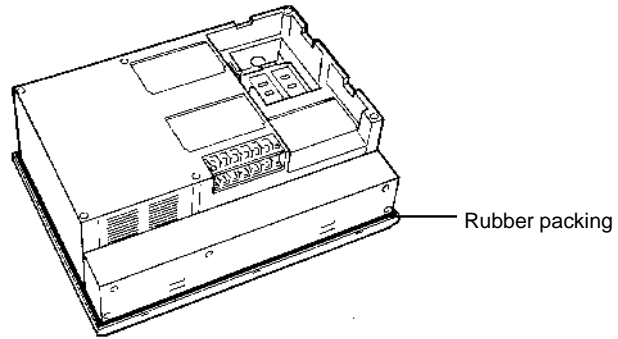

4. Mount to the panel.

SECTION 3

Initial Operation

This section provides an introduction to the operations necessary to use a PT for the first time and to the menus and keys used to control PT operation.

| | | |
|-------|--|----|
| 3-1 | Powering Up | 32 |
| 3-2 | Initialization | 32 |
| 3-2-1 | Initializing Memory | 32 |
| 3-2-2 | Menus | 34 |
| 3-3 | Transferring Data to and from the Support Tool | 35 |
| 3-4 | Trial Operation | 37 |

3-1 Powering Up

When first starting up the system, do not connect the Host Interface Unit to the host. When power is turned on to the PT, either a “Connecting to host” message or the initial screen set by the Support Tool will be displayed. The “Connecting to host” message will be displayed if a Host Link Interface Unit, a SYSMAC BUS Interface Unit, or a C200H Host Interface Unit is mounted. The initial screen will be displayed if an RS-232C or RS-422A Interface Unit is mounted.

If there is no screen data registered for the PT, or if there is an error in the screen data that is registered, then the System Menu will be displayed instead, with an error message at the bottom. In that case, it will be necessary to initialize the memory and transmit the correct data.

3-2 Initialization

Initialize the memory in the PT using the procedure described below. This procedure can also be used later to completely delete data from the PT. Data will be initialized regardless of the setting for the resume function. Always be careful not to initialize and delete essential data.

3-2-1 Initializing Memory

Perform the initialization if the screen memory is either SRAM or EEPROM. Check to be sure that the screen memory is installed.

Memory initialization can be used to initialize screen memory, memory tables, and history data. Initializing screen memory completely deletes the contents of the screen memory, including the contents of numeral tables and text string memory tables. Initializing memory tables overwrites numeral tables and text string memory tables with the initial values set by the Support Tool. Initializing the display history deletes all of the display history data.

To initialize the screen memory, for example, first access the System Menu by simultaneously pressing the Buzzer Key, Up Key, and Down Key. Then proceed as shown as shown in the following chart.

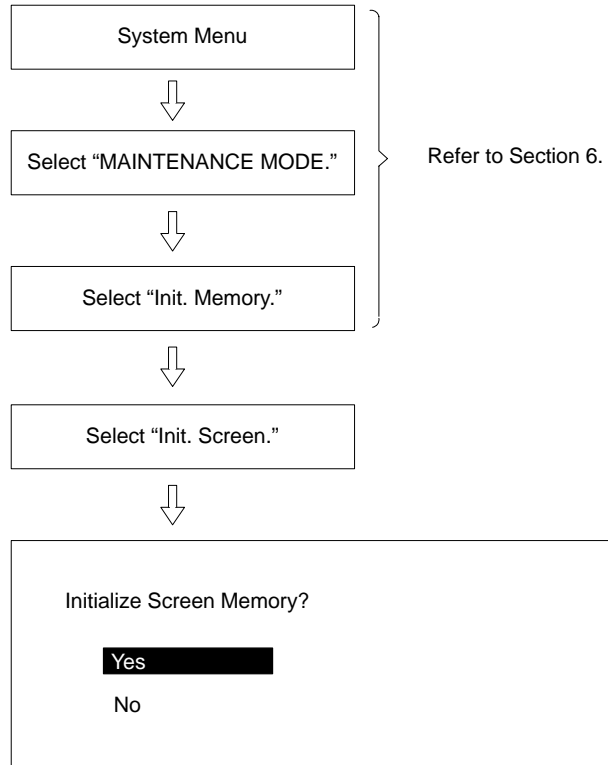

If you select yes, then memory will be initialized and all data used for displays will be erased. After initialization, operation will begin in RUN Mode.

If you select no, then operation will begin in RUN Mode without initialization.

When entering RUN Mode after initialization, nothing will be displayed on the screen and the Terminal will wait for a command from the host.

To initialize other data memory, return to the Maintenance Mode and follow the same procedure.

⚠ Caution Screen memory must be initialized before using a new PT. If the PT is used as shipped from the factory without initialization, messages indicating errors in the host will not be displayed properly.

3-2-2 Menus

The System Menu is called up by using the the system keys during operation. The System Menu can always be displayed regardless of the PT mode. If there is no key input for 10 seconds after the System Menu has been called up, the System Menu will be exited and RUN Mode will return.

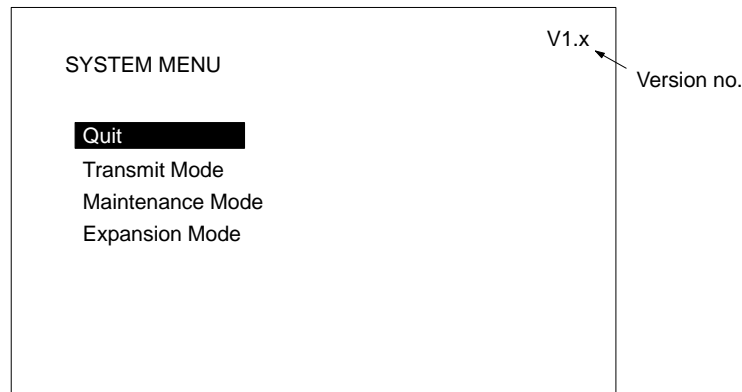

Using System Keys

| Operation | Content |
|--|--|
| Press the Buzzer Key, Up Key, and Down Key simultaneously. | Pressing the Up Key and Down Key while the Buzzer Key is being held down changes PT modes and menus in the following ways: RUN Mode → System Menu System Menu → RUN Mode Maintenance Mode → previous screen or RUN Mode Transmit Mode → RUN Mode |
| Press the Up Key. | Moves the bar cursor upward. |
| Press the Down Key. | Moves the bar cursor downward. |
| Press the Enter Key. | Selects the menu at the position of the bar cursor. |

Quit

Leave the system menu and return to operation by either of the following methods.

- 1, 2, 3... 1. Select "Quit."
- OR
2. Press the Buzzer Key, Up Key, and Down Key simultaneously. In addition, if there are no key inputs within 10 s of calling up the system menu, the system will automatically return to normal operation.

Selecting Items

To select an item, move the bar cursor to that item and press the Enter Key.

| Selected item | Function |
|------------------|---|
| Quit | Quits and return to normal operation. |
| Transmit Mode | Shifts to Transmit Mode. Select when transferring data between the NT600M and Support Tool. For details, refer to 3-3 <i>Transferring Data to and from the Support Tool.</i> |
| Maintenance Mode | Shifts to Maintenance Mode. Used to check the setting status of the NT600M and conduct self-testing. |
| Expansion Mode | Not used. Reserved for future function expansion. |

Error Messages

When there is an error in screen data registered in the NT600M, the System Menu will appear before entering RUN Mode, and the error message will be displayed on the bottom line.

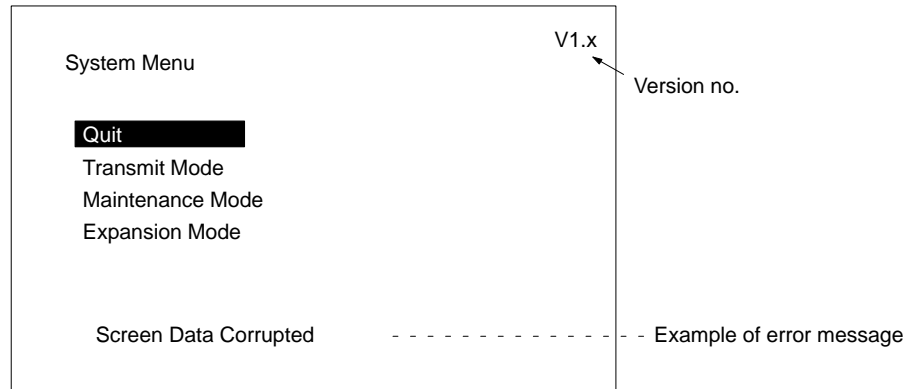

There are three types of error messages, as shown below. If an error message is displayed, first initialize the screen data memory before re-transmitting the data. Operation will not begin again until the error has been corrected.

| Error message | Error Content and Correction |
|-----------------------|---|
| Screen Data Corrupted | This is displayed when registered screen data is corrupted. Initialize the screen data and then re-register it. Operation will not begin again until the data is restored. |
| Mark Data Corrupted | This is displayed when registered mark data is corrupted. Initialize the screen data and transfer the screen data files. The mark data is included in the screen data files. Re-register the mark data. Operation will not begin again until the data is restored. |
| Memory Not Formatted | This is displayed when the screen data area is not formatted. Initialize the screen data memory. All registered screen data, mark data, and system data will be deleted by the initialization, so they will have to be transferred again from the Support Tool. In addition, if an IC socket-type Screen Data Memory Board is being used, recheck the socket's memory and its settings. |

3-3 Transferring Data to and from the Support Tool

Data can be transferred back and forth between the NT600M and the Support Tool. Transfer the screen data created by the Support Tool before operating the NT600M.

Procedure

Use the following procedure to transfer data.

- 1, 2, 3... 1. Connect the NT600M and personal computer running the Support Tool.
2. Select Transmit Mode from the System Menu.

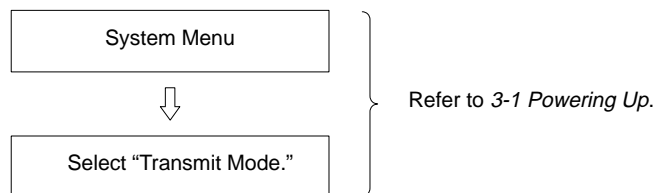

3. At the NT600M, it is only necessary to place the NT600M in Transmit Mode. The direction of transmission and the contents of the data to be transmitted are set at the Support Tool. (For instructions on operating the Support Tool, refer to the *NT-series Support Tool Operation Manual*.)

- When the data transfer begins, the direction of transmission, the type of data being transmitted, and the memory capacity are displayed on the screen.

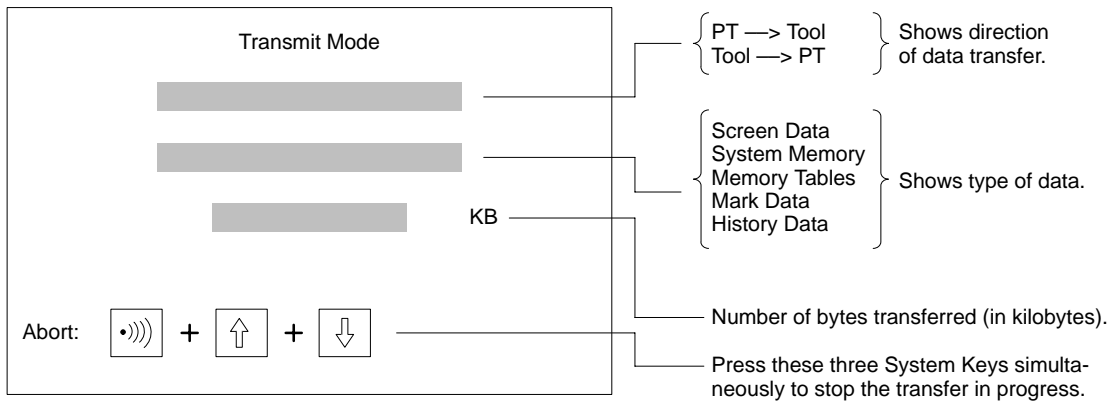

- When the data transfer has been completed, those items will no longer be displayed.

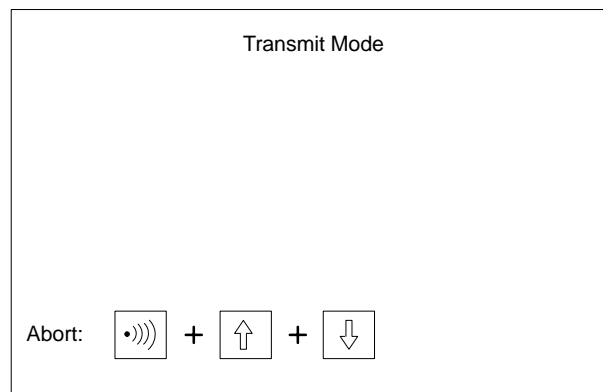

- In the event of a disconnected cable or other disruption while the transfer is in progress, the NT600M screen will go blank and a message telling you that transfer was not possible will be displayed at the Support Tool. If the transfer is completed successfully, then at the end of the transfer the NT600M screen will go blank and a message telling you that the transfer has been completed will be displayed at the Support Tool.
- To return from Transmit Mode to RUN Mode, press the Buzzer Key, Up Key, and Down Key simultaneously.

Caution After the transfer has been completed, be sure to return to RUN Mode by pressing the Buzzer Key, Up Key, and Down Key simultaneously. If the power is turned off or if a reset is executed without having first returned to RUN Mode, the data that has been transmitted will be corrupted. If that occurs, a message will be displayed on the screen to indicate that the data has been corrupted.

The following data can be transferred between the NT600M and the Support Tool.

| Data | Support Tool to NT600M | NT600M to Support Tool |
|--|---------------------------|---------------------------|
| Screen data | All screens or one screen | All screens or one screen |
| Character string table | YES | YES |
| Numeral table | YES | YES |
| Mark data | YES | YES |
| Display history data (in order of frequency or in order of occurrence) | None | YES |
| System Memory (Initial screen after power-up) | YES | YES |

Note When using the EEPROM as a screen data memory, screens cannot be transferred screen by screen from the Support Tool to the PT. The screen data must be transferred in file units after initializing the memory.

3-4 Trial Operation

After screen data has been transferred, or after a screen data memory chip has been installed (when EPROM is used), the following procedure can be used to carry out a trial operation.

- 1, 2, 3... 1. Connect the Host Interface Unit to the host. (Refer to the *Host Interface Operation Manual*.)
2. If the screen data memory is okay, then the PT will automatically go into RUN Mode when it is powered up, and the RUN indicator on the front panel will light.
3. Check the host-to-PT communications by transmitting a screen-change command from the host, and checking whether the screen is changed.
4. Check the PT-to-host communications by transmitting to the host by means of function keys, touch switches, and external inputs, and seeing that they are all transmitting properly.
5. If communications with the host cannot be executed properly, refer to 6-2-6 I/O Checks.

SECTION 4

Display Functions

This section describes the functions used to create screens and control display attributes on the PT. Functions used to input data on-screen are described in *Section 5 Input Functions*. Data transfer and maintenance functions are described in *Section 6 System Menu*. Transferring screens online to and from the host computer is described in *Section 7 Online Transfer*.

| | | |
|--------|--|----|
| 4-1 | Character Displays | 40 |
| 4-1-1 | Types of Characters | 40 |
| 4-1-2 | Designating Display Positions | 40 |
| 4-1-3 | Character Scale | 40 |
| 4-1-4 | Display Attributes | 41 |
| 4-2 | Display Graphics | 41 |
| 4-3 | Normal Screen Changes | 42 |
| 4-3-1 | Procedure for Changing Screens | 42 |
| 4-4 | Continuous Screens | 42 |
| 4-5 | Overlapping Screens | 43 |
| 4-6 | Numeric Displays | 45 |
| 4-7 | Character Strings | 46 |
| 4-8 | Bar Graphs | 47 |
| 4-9 | Lamps | 47 |
| 4-10 | Graphics Display | 48 |
| 4-11 | Special Controls | 48 |
| 4-11-1 | Backlight ON/OFF | 48 |
| 4-11-2 | Alarm Output On/Off | 49 |
| 4-11-3 | Buzzer On/Off | 49 |
| 4-11-4 | Initialize Display History | 49 |
| 4-11-5 | HOST RUN INPUT | 49 |
| 4-11-6 | Normal/Inverse Display (LCD-type Only) | 50 |
| 4-12 | Terminal Function | 50 |
| 4-13 | Display Speed | 50 |

4-1 Character Displays

The type, size, and attributes of characters that can be displayed on the NT600M screen are shown on the next page. Character type, size, and attributes are set at the time of creation on the Support Tool. When an RS-232C or RS-422A Host Interface Unit is used, coordinates, characters, etc. can be designated with commands from the host in Terminal Mode.

4-1-1 Types of Characters

| | | |
|--------------------|---|--|
| Character fonts | Half-size characters (8 x 8 dots) | Alphanumeric characters, symbols. |
| | Normal characters (8 X 16 dots) | Alphanumeric characters, symbols. |
| | Marks (16 X 16 dots) | Pictographs defined by the user (up to 64 possible) Character codes: FF20 to FF5F |
| Numeric display | Number of digits displayed | 1 to 8 |
| | Number of decimal digits | 0 to 7 |
| | Zero suppress (see note) | Select "yes" or "no." |
| | +/- sign | Select "yes" or "no." |
| Character scale | No sizing (equal), double-width, double-height, 4x, 9x, 16x, or 64x character sizes | |
| Display attributes | Standard display, inverse, blinking, and, inverse blinking | |

Note When zero suppress is in effect, zeros on the left of the number are not displayed. For example, "00028050" would be displayed as "28050".

4-1-2 Designating Display Positions

The display positions can be designated in increments of display dots. When characters overlap, characters written last overwrite those written earlier. (Terminal Mode)

4-1-3 Character Scale

You can designate no sizing (equal), double-width, double-height, 4x, 9x, 16x, or 64x character sizes. When enlarging by 4x or more, you can make the characters easier to read with the smoothing process (a process that removes the notches from characters when they are enlarged).

4-1-4 Display Attributes

Besides the standard display (black characters on a white background), you can designate individual characters as inverse, blinking, or inverse/blinking.



Note You cannot designate the blinking cycle.

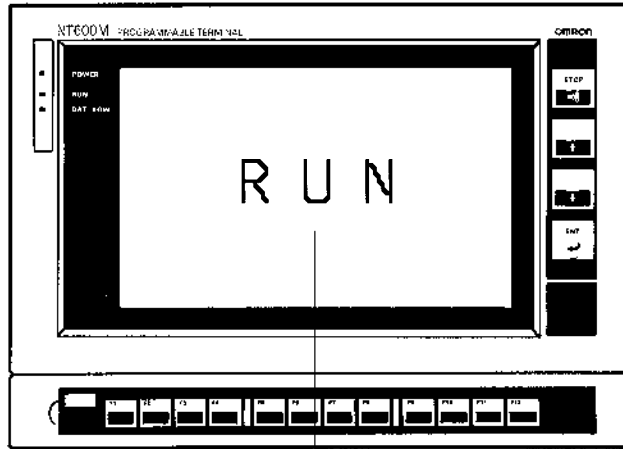

64x characters

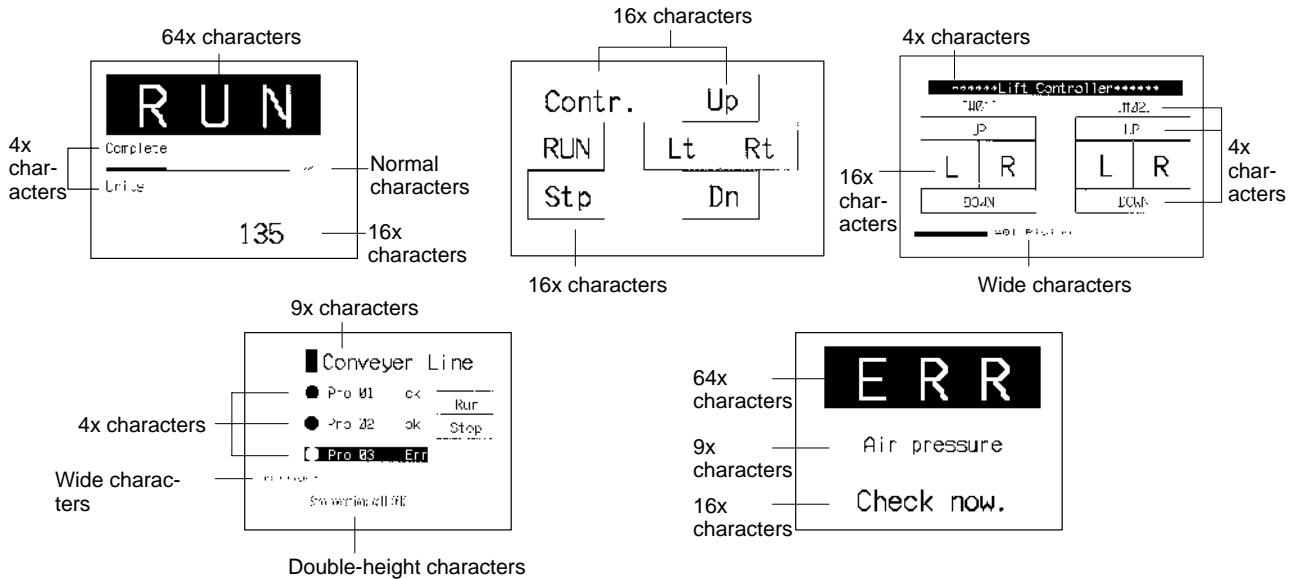

4-2 Display Graphics

Polylines (broken continuous lines) and circles can be created on the Support Tool for display on the PT. When using RS-232C or RS-422A communications, coordinates can also be designated through commands from the host in terminal mode.

Display positions for graphics can be designated at dot increments and can overlap characters on the display. When they overlap, graphics are displayed on top of characters.

Either continuous lines (called polylines) or circles can be designated. Line widths are 1 dot for either.

4-3 Normal Screen Changes

The displayed screen can be changed to another screen by designating the screen number from the host (a Programmable Controller or personal computer). The designated screen must have already been created at the Support Tool and downloaded to the NT600M or it must have been placed in ROM, with the Screen Data Memory Board installed.

4-3-1 Procedure for Changing Screens

- 1, 2, 3... 1. By designating a screen number (0 to 1,000) from the host, you can switch to the designated screen.

Note Screen no. 0 is blank (with no display).

2. When an ordinary screen is displayed, the screens cannot be changed by means of the Up and Down Keys on the front panel of the NT600M.
3. The screen-changing procedures vary for each interface. For details, refer to the *Host Interface Unit Operation Manual*.

Standalone Function

When Support Tool versions NT-ZA3AT-EV2 or NT20M-ZASAT-EV4 and later are used, screen changes can be made on-site. In order to be able to make on-site screen changes, when creating screen data use the expansion function to assign screen numbers to touch switches, function keys, or external inputs.

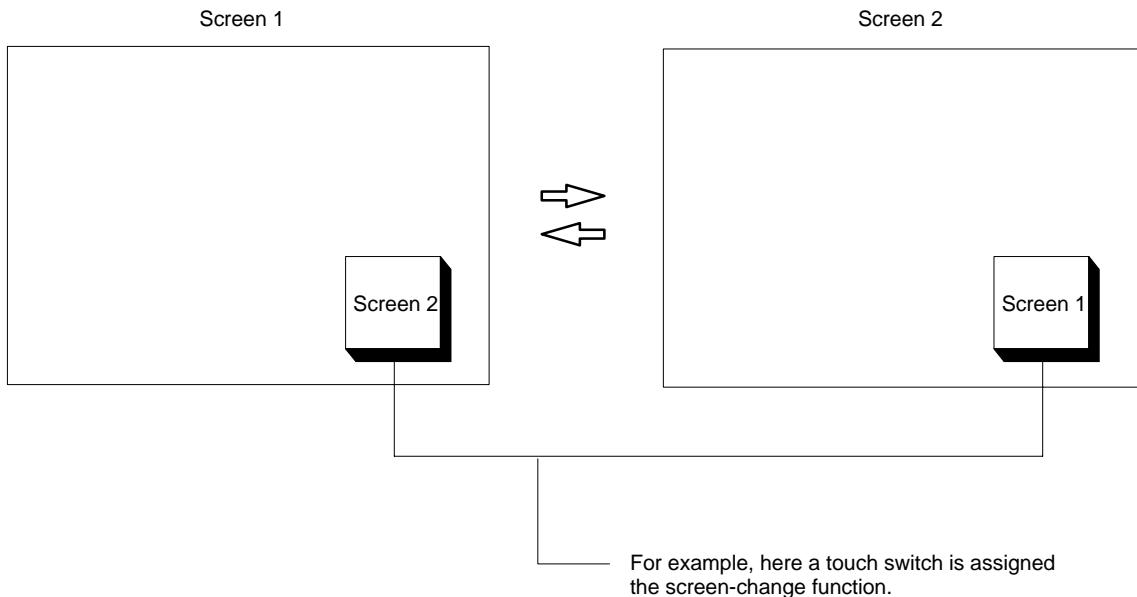

4-4 Continuous Screens

Screens can be linked to display consecutively, without breaks. A maximum of eight screens can be made consecutive, and treated as one screen.

- By pressing the Up Key and Down Key, you can scroll screens up or down.
- Page number displays are designated on the Support Tool at the time of registration.

Example

If screen 9 is designated from the host, the content of screen 20 is displayed first. If you press the Down Key, you scroll down to the next screens.

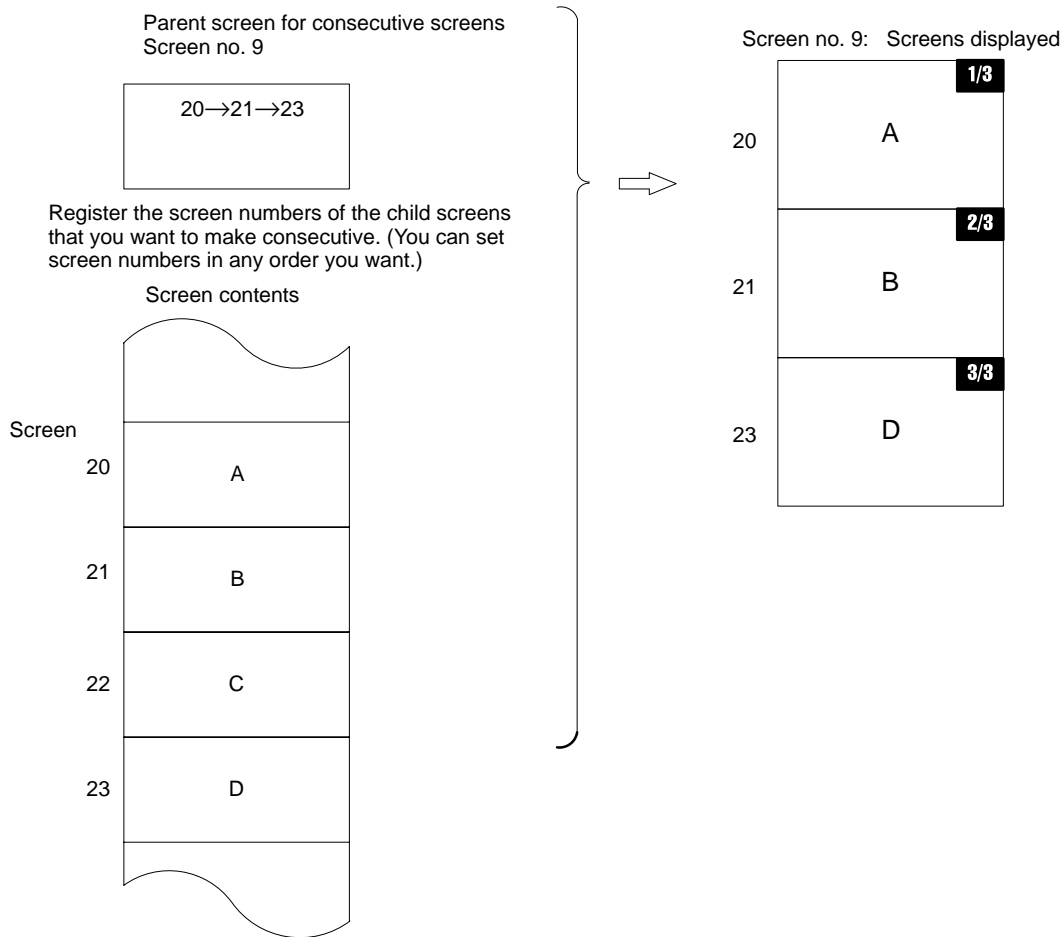

- Note**
1. Parent screens (screen no. 09 in this case) cannot have screen data. They can be treated only as parent screens.
 2. Scrolling is done in screen units.
 3. Screens with numeric settings cannot be designated as child screens.

4-5 Overlapping Screens

The contents of multiple screens can be laid one on top of another and registered as one screen, when the screens are created on the Support Tool. Just as with ordinary screens, if the number of a screen registered as an overlapping screen is designated from the host, then the overlapping screens corresponding to that number are displayed.

- A maximum of eight screens may be overlapped.
- Screens with touch switches, lamps, graphs, character strings, and numeric displays can be overlapped. If screens with numeric settings are to be overlapped with screens that have touch switches or lamps, then use touch switch/lamp numbers 0 to 243 (or 0 to 230 when the ten-key is registered to “user”). In addition, do not overlap touch switches/lamps with numeric keys.
- An overlapping screen cannot be set as a child screen of a continuous screen.

Example

If screen 02 is designated from the host, then screens 03, 05, and 08 are displayed.

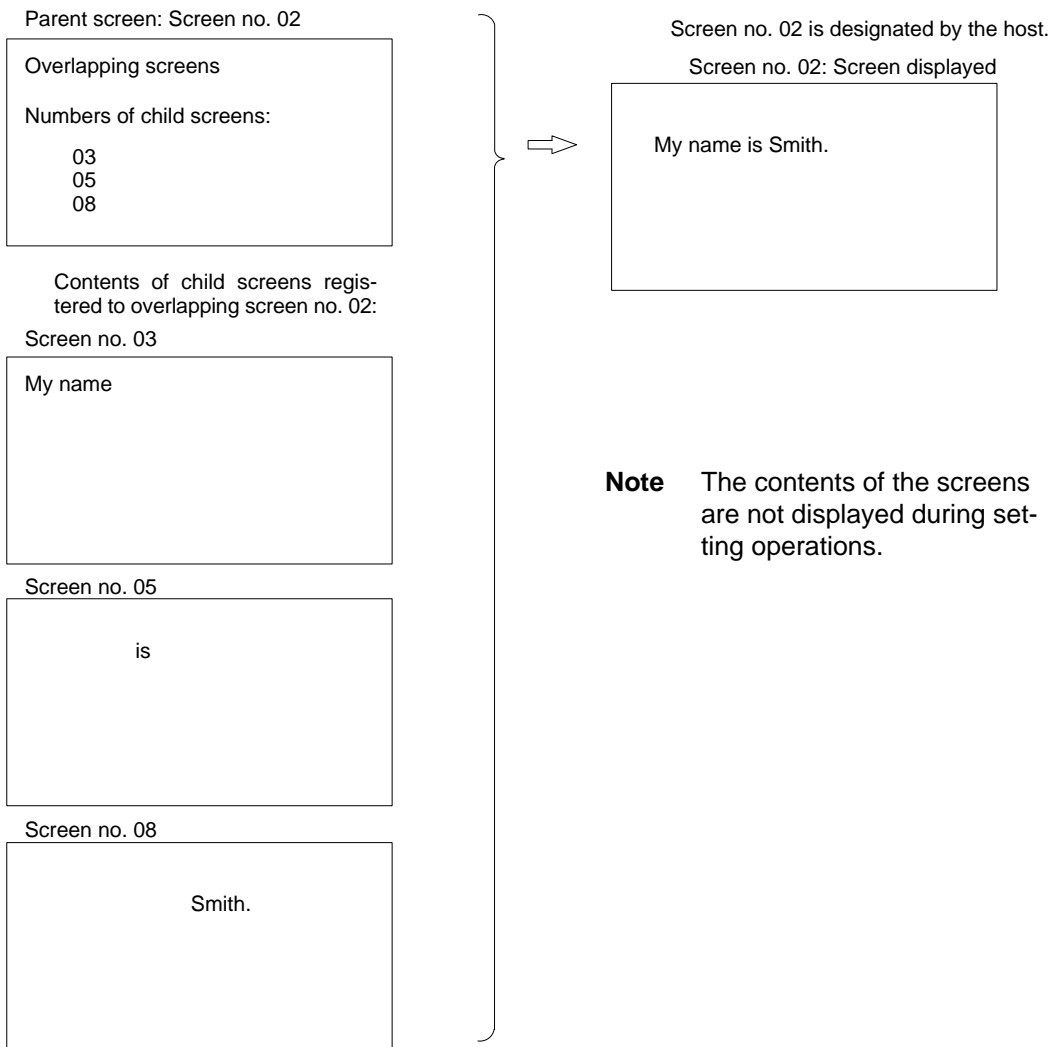

Note Parent screens (screen no. 02 in this case) cannot have screen data. They can be treated only as parent screens.

4-6 Numeric Displays

A numeral table is stored in the NT600M, and you can display numeric values from the table at designated positions on a screen. In addition, the values in the table can be transferred from the host so that they are renewed each time a new value is transferred. The display positions are set in advance with the Support Tool.

Example

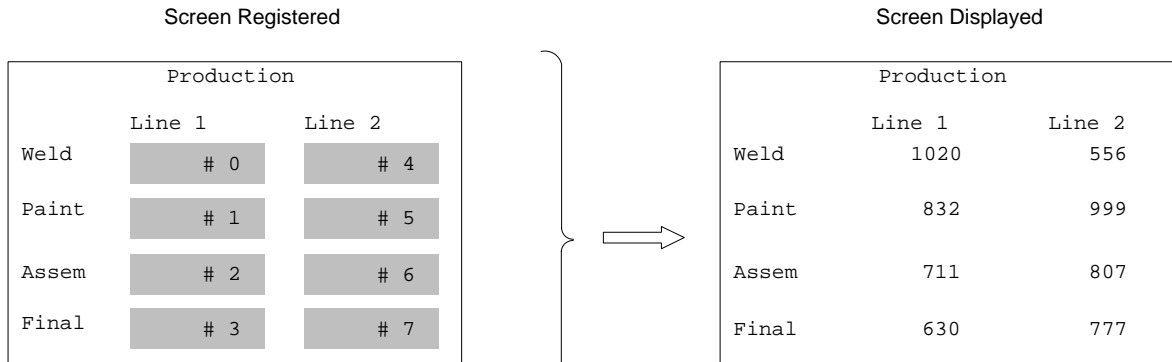

Contents registered to screens by Support Tool:
 Numeral table numbers
 Display positions (50/screen max.)
 Number of digits displayed (whole numbers, fractions)
 Character fonts
 Sizes of characters displayed

Numeral Table
(Maximum of 256 entries)

| Number | Contents |
|--------|----------|
| # 0 | 1020 |
| # 1 | 832 |
| # 2 | 711 |
| # 3 | 630 |
| # 4 | 556 |
| # 5 | 999 |
| # 6 | 807 |
| # 7 | 777 |
| to | |
| #255 | |

These contents are transmitted from the host.

When the PC is used as the host, for example, these values will be transferred via the Host Interface Unit and updated on screen when the contents of the DM Area are changed at the PC.

4-7 Character Strings

This function displays variable character strings on the screen. A character string memory table is stored in the NT600M. By changing, from the host, the memory table values corresponding to the display position, you can update the characters displayed. The designation of the display positions is set in advance at the Support Tool.

Example

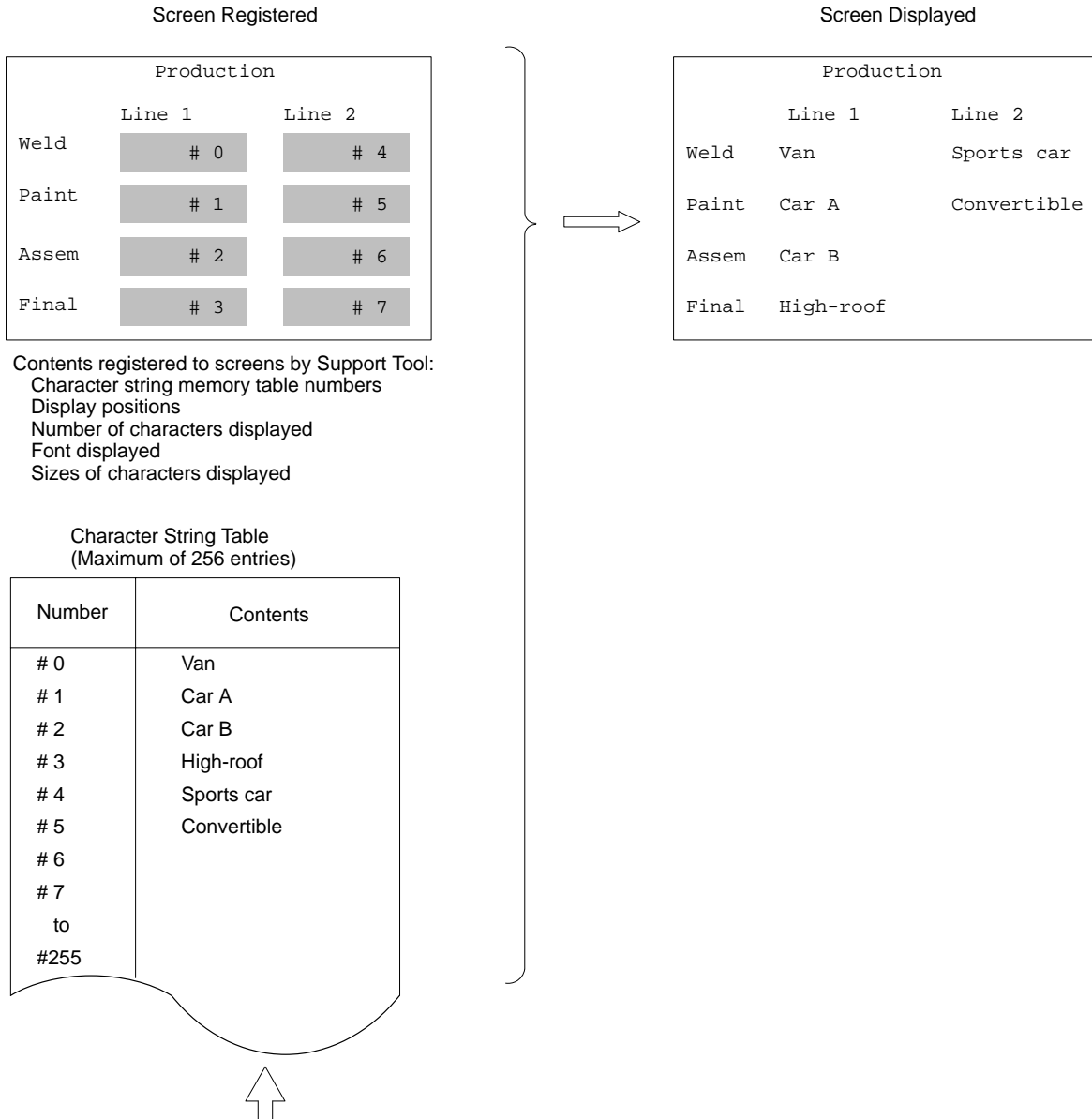

These contents are transmitted from the host.

When the PC is used as the host, for example, these values will be transferred via the Host Interface Unit and updated on screen when the contents of the DM Area are changed at the PC.

4-8 Bar Graphs

If the numeric values that you want to make into a bar graph have been input into the numeral table in advance, then that graph can be displayed simply by designating the screen on which the graph is registered. Just as with numeric displays, the graph display is also updated when the contents of the numeral table are updated. Bar graphs can be displayed either horizontally or vertically. They can also be displayed in the negative direction.

Example

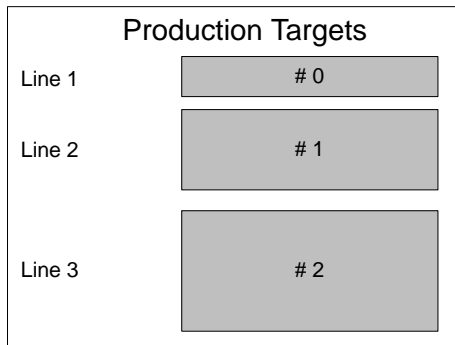

Contents registered to screens by Support Tool:
 Display positions (50 bars max.)
 Graph width (2 to 255 dots)
 100% value
 % display (yes/no)
 % display position
 Numeral table numbers for referencing
 Display direction
 Graph frame (yes/no) (see note)
 Sign display
 % display fonts
 % enlargement sizes
 +/- sign (yes/no)

Numeral Table
(Maximum of 256 entries)

| Number | Contents |
|--------|----------|
| # 0 | 1020 |
| # 1 | 832 |
| # 2 | 711 |
| to | |
| #255 | |

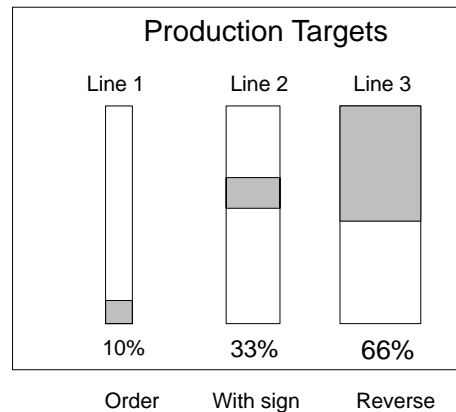
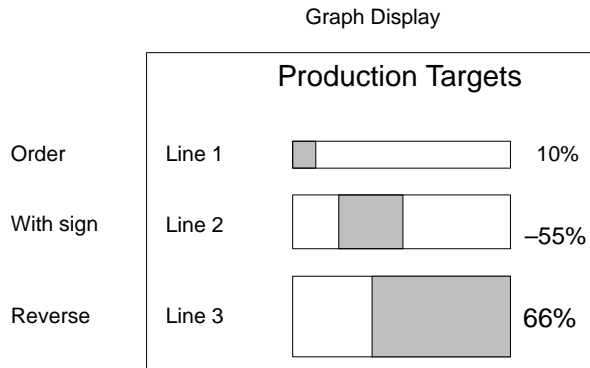

Note: When "with frame" is set for a graph, the width of the graph is reduced by two dots, so in that case the graph must have an original width of at least three dots.

4-9 Lamps

On the Support Tool you can set lamp areas in the display screen, and the lamps will light (or blink) by means of a designation from the host. Lamps are registered in advance at the Support Tool.

Display position: Can be set as desired, but must match the switch frames when combining lamps with the switch function.

Shape: Rectangle or circle

- Size: Can be freely set with a rectangle or a circle.
- Number: 128 maximum per screen
- Display attributes: Lit, blinking
- Guide characters: Select "yes" or "no."

Lamps set from the host can be turned on and off by either of two methods: number designation or bit designation (when there is no direct connection). For details, refer to the *Host Interface Unit Operation Manual*.

Example 1: Usage with Switch Frames

If using a lamp together with a switch, then set the lamp within the switch frames, of which there are 12 horizontal and 6 vertical.

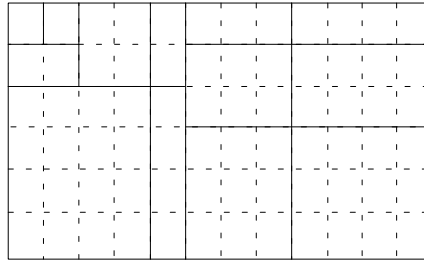

Example 2: Emphasis

The display of the number defective can be emphasized setting it to light.

| | |
|-----------|------|
| Goal | 1234 |
| Complete | 600 |
| Defective | 2 |

4-10 Graphics Display

Unbroken straight lines (polylines) and circles can be created by the Support Tool and displayed at the PT. When an RS-232C or RS-422A Interface Unit is used, the graphics can be displayed by using the terminal function and transmitting commands from the host.

Designating Display Positions

Graphics display positions can be designated in dot units. In cases where graphics and characters overlap, the graphics will be overwritten (Terminal Mode). Polylines and circles are both drawn with a width of one dot.

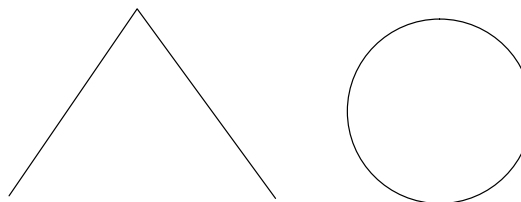

4-11 Special Controls

The status of the NT600M to be controlled from the host during operation.

4-11-1 Backlight ON/OFF

In order to prolong the life of the backlight, the backlight can be turned off by a backlight-off command from the host when it is not needed during operation.

Note If there is any key input or transmission while the backlight is off, the backlight will turn on again.

4-11-2 Alarm Output On/Off

The output of the ALM OUTPUT terminal, which is located in the terminal block on the rear panel of the NT600M, can be turned ON and OFF from the host. The ALM OUTPUT terminal is turned ON and OFF when a screen registered for an alarm is displayed, and also when there is an NT600M error.

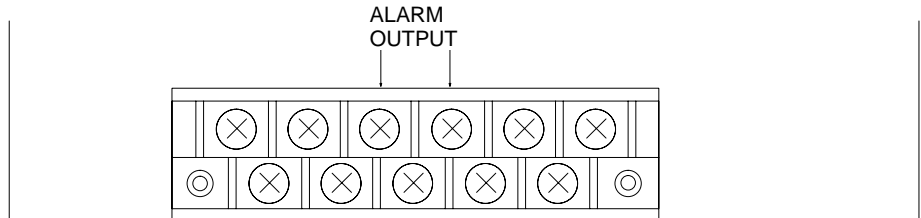

4-11-3 Buzzer On/Off

The built-in buzzer can be turned on and off from the host. There are two types of buzzers, continuous and intermittent. The buzzer also sounds when a screen registered with the buzzer is displayed. The buzzer stops when the Buzzer Key is pressed.

| | | |
|---------------------|--|----------------------|
| Continuous buzzer | | (Continuous sound) |
| Intermittent buzzer | | (Intermittent sound) |

4-11-4 Initialize Display History

History data in the NT600M can be cleared (initialized) by the host. Until this operation is executed, history data continues to be registered.

4-11-5 HOST RUN INPUT

The HOST RUN INPUT detects when the host is not in RUN, and displays the host error screen. Pin 2 of SW1 is used to enable and disable this input. When the HOST RUN INPUT is enabled, the host error screen is displayed if it turns OFF.

Pin 2 of SW1 ON:
Pin 2 of SW1 OFF:

HOST RUN INPUT disabled.
HOST RUN INPUT enabled.

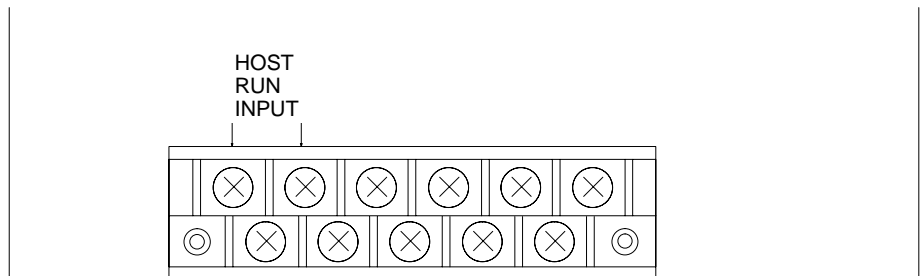

4-11-6 Normal/Inverse Display (LCD-type Only)

The display background can be set to either normal or inverse. The normal background is white, and the inverse background is black.

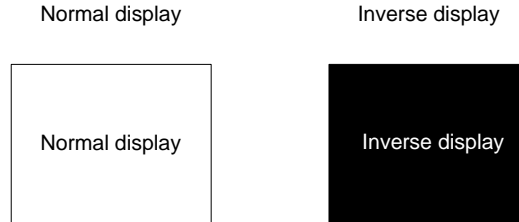

4-12 Terminal Function

This function allows you the option of displaying, by transmission on command, the codes (coordinates, type, etc.) of characters and figures you want to display from the host, in addition to screens registered in advance. This function is possible only when the Host Interface Unit is the NT600M-LK201 for the RS-232C or the NT600M-LK202 for the RS-422A. For details, refer to the terminal commands listed in the *RS-232C/RS-422A Interface Unit Operation Manual*.

| Item | Content |
|-----------------------|---|
| Display position | Optional |
| Character size | Normal, half-size, double-height, double-width, 4x, 9x, 16x, or 64x |
| Display attributes | Normal, inverse, blinking, inverse blinking |
| Character designation | ASCII |
| Graphics | Polyline, circle |

- Note**
1. If a displayed character string exceeds the line, that string is displayed beginning from the left side of the next line.
 2. In addition, strings that do not fit at the bottom of the screen over-write from the left side of the same screen.

4-13 Display Speed

NT600M display speed varies according to the amount of elements displayed on the screen. As a standard, the following diagrams shows the time required for changing displays on screens that include characters.

| | | |
|-------------------------------|----------------------|---|
| Measurement Conditions | System ROM: | NT600M-SMR02-EV1 |
| | Host Interface Unit: | NT600M-LB122-V1 |
| | Screen data: | Character display (1 to 40 characters) |
| | Measurement time: | Time (in ms) from when the PT receives the command until the display is executed. |

Time it Takes to Display the Same Normal Characters

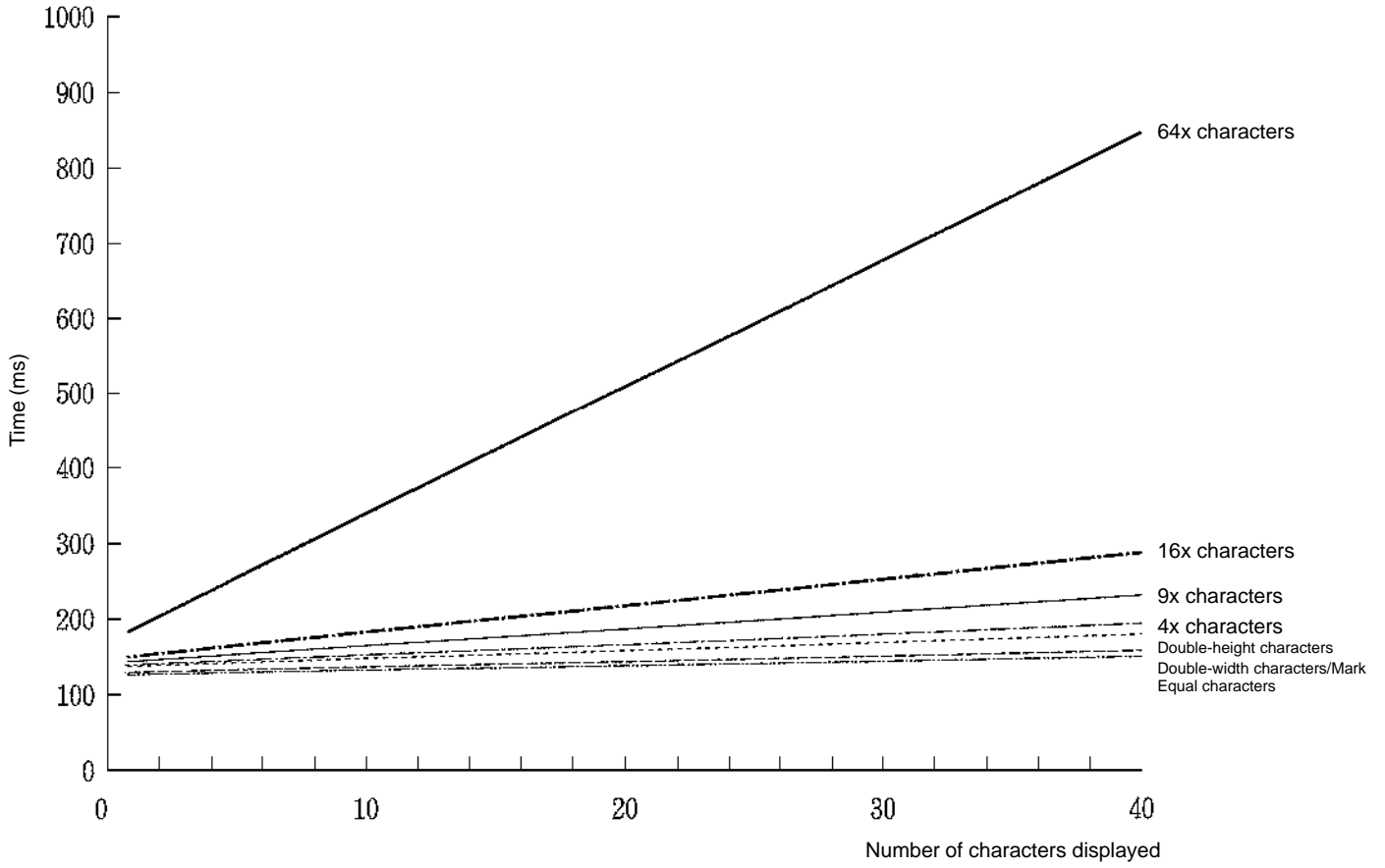

Time it Takes to Display a Variety of Normal Characters

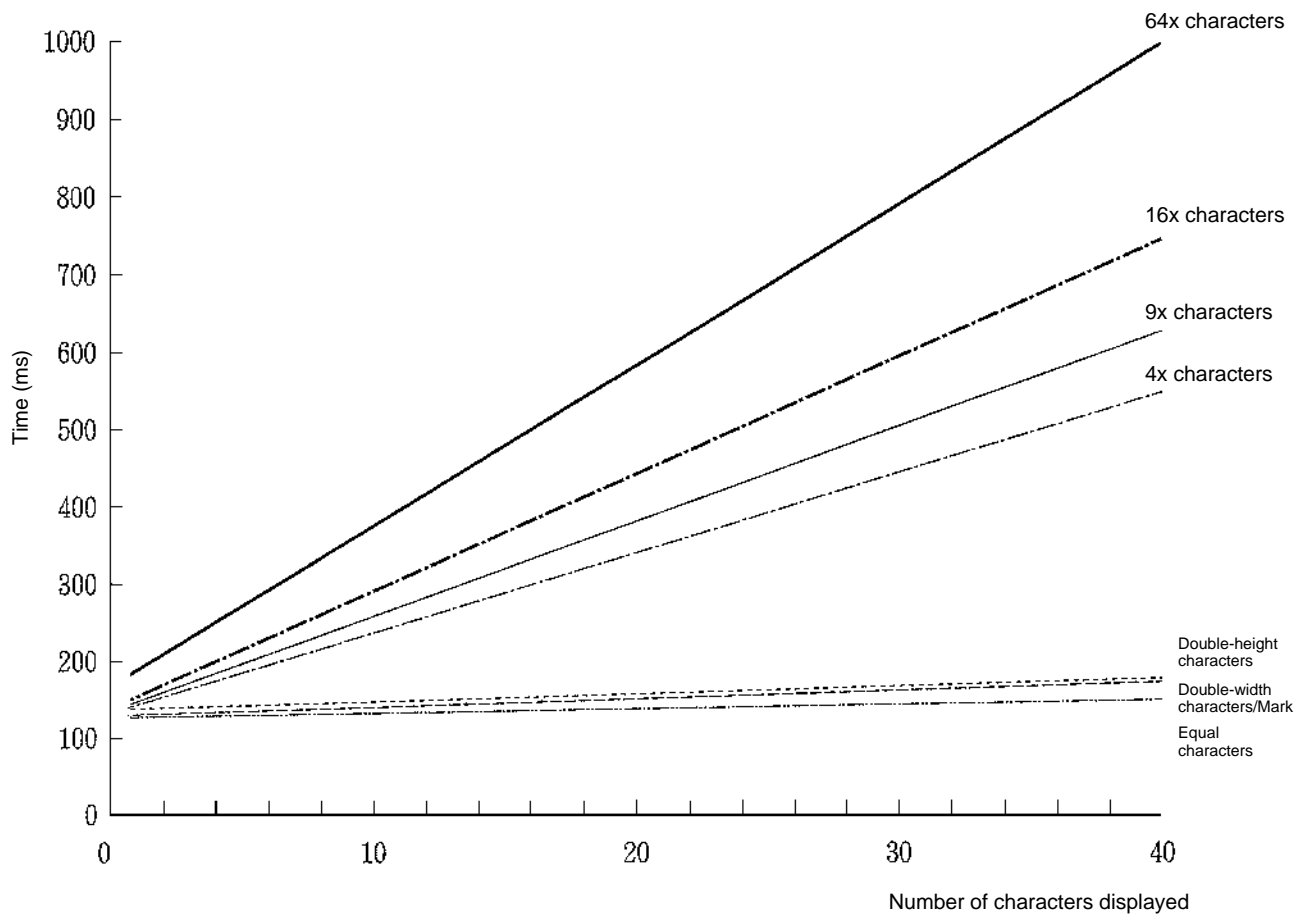

SECTION 5

Input Functions

This section describes the functions used to input data on-screen. Functions used to create screens and control display attributes on the PT are described in *Section 4 Display Functions*. Data transfer and maintenance functions are described in *Section 6 System Menu*. Transferring screens online to and from the host computer is described in *Section 7 Online Transfer*.

| | | |
|-------|--|----|
| 5-1 | On-screen Switch Inputs | 54 |
| 5-1-1 | Transmitting to the Host | 54 |
| 5-1-2 | Creating Touch Switches (DT-type PTs Only) | 55 |
| 5-1-3 | Function Keys (NT600M-DF122) | 56 |
| 5-2 | Inputting Numeric Settings | 56 |
| 5-3 | Standalone Function | 59 |

5-1 On-screen Switch Inputs

DT-type PTs can transmit to the host the input status of touch switches set on screens. A maximum of 64 switches can be set per screen. DN-type PTs can transmit to the host the inputs of 12-key Function Key Units. DF-type PTs can transmit to the host the input status of the function keys located at the bottom of the display. (The standard number of function keys is 12.)

5-1-1 Transmitting to the Host

There are two ways to transmit the input status of switches to the host. These two methods, which are determined by a “screen attributes” setting at the Support Tool, are described briefly below. For more detail, refer to the *Host Interface Unit Operation Manual*. For instructions on setting screen attributes, refer to the *NT-series Support Tool Operation Manual*.

Switch-number Method

In order to use the switch-number method, “bit input” screen attribute must be set to “disabled.” Using this method, when a switch is pressed the number corresponding to that switch is transmitted to the host as a numeric value in three digits of BCD. When two switches are pressed, the first one is given priority in transmission. When using an NT600M-LK201 or NT600M-RT121 Host Interface Unit, send the data to the host by means of the strobe signal in the PT status information which is output when switches are pressed.

Bit-switch Method

In order to use the switch-number method, “bit input” screen attribute must be set to “enabled.” When this method is used, the status of each switch is transmitted to the host as a bit status. This is the method used when substituting for ordinary operating switches. You can use it for ordinary bit input switches from a Programmable Controller.

Note With this method, it is possible to push a number of switches simultaneously. The following considerations must be taken into account, however, when configuring the switches.

Example 1: Switches Created at Points C and D, Which are Vertical and Horizontal Points of Intersection for Points A and B

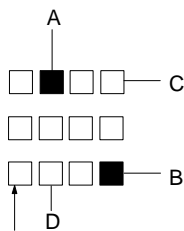

Minimum touch switch frame

If switches A, B, and C are turned ON simultaneously in this switch configuration, switch D will also turn ON.

If switches A, B, and D are turned ON simultaneously, switch C will also turn ON.

Example 2: Switches Created at Points E, F, and G

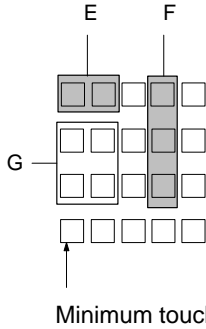

If switches E and F are turned ON simultaneously in this switch configuration, switch G will also turn ON.

5-1-2 Creating Touch Switches (DT-type PTs Only)

Just as with lamps, touch switches are created and registered with the Support Tool. The setting content is as follows:

Setting Parameters

Combine your choices of rectangular sections from the among the 128 blocks shown in the diagram below, and designate them as switches. The smallest possible switch is one block.

Number of Settings

A maximum total of 128 switches can be set per screen. If you wish, the entire screen can also be set as one input switch.

Settings by Support Tool

| | |
|--------------------------------|---------------------|
| Frame display | Standard/Solid/None |
| Reverse video display at input | Yes/No |
| Guide characters | Yes/No |

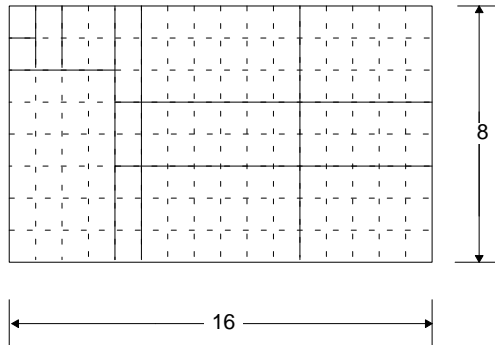

Example of On-screen Touch Switches

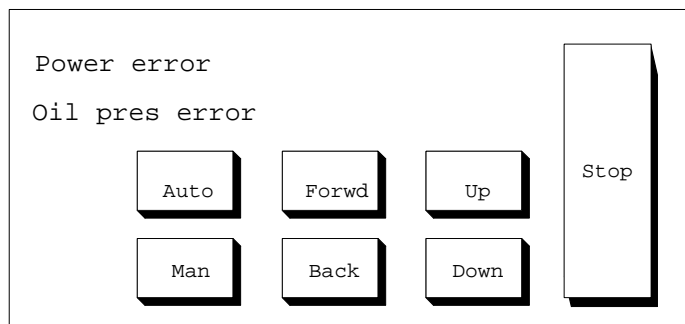

5-1-3 Function Keys (NT600M-DF122)

The NT600M-DF122 is the PT with function keys. DN-type PTs (NT600M-DN-221) can also be provided with function keys by connecting a 12-key Function Key Unit (NT600M-FK210).

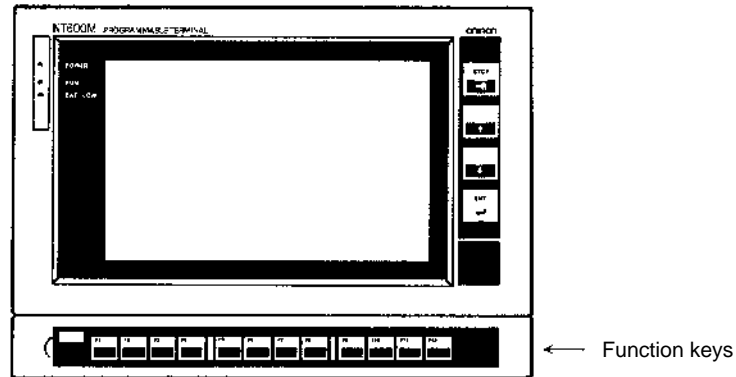

Example of Function Key Input Screen

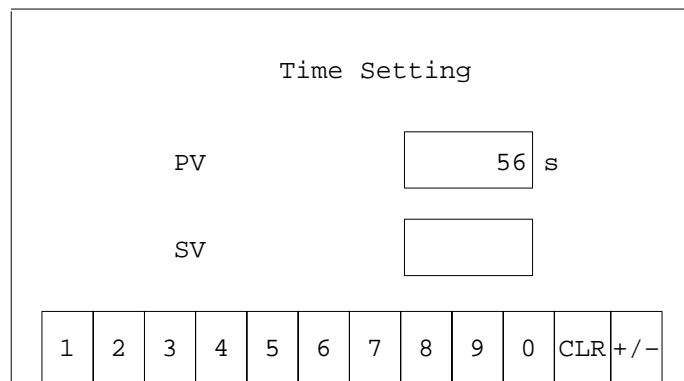

The function keys all have the same size screen display frames. You can display customized function names on the screen to identify them. Up to two function keys can be pressed simultaneously.

5-2 Inputting Numeric Settings

Numeric values input while the numeric setting screen is being displayed are written to the designated numeral table and transmitted to the host.

Numeric Setting Screens

The standard numeric setting screen is as shown below. This screen is reserved for system use by the Support Tool. Standard screen key arrangements and functions are fixed. In order to change the key arrangement or add keys (such as a decimal point) for numeric input, set the "numeric setting" item under "screen attributes" to "user." (When it is set to "system," the

standard screen will be displayed.) For instructions on registering numeric setting screens, refer to the *NT-series Support Tool Operation Manual*.

Standard Screen (Screen Attribute: System)

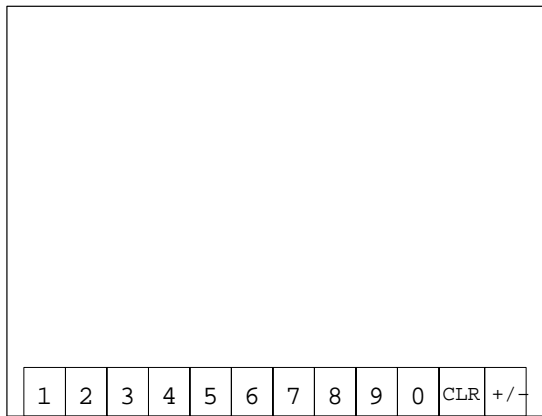

User-set Screen Example (Screen Attribute: User)

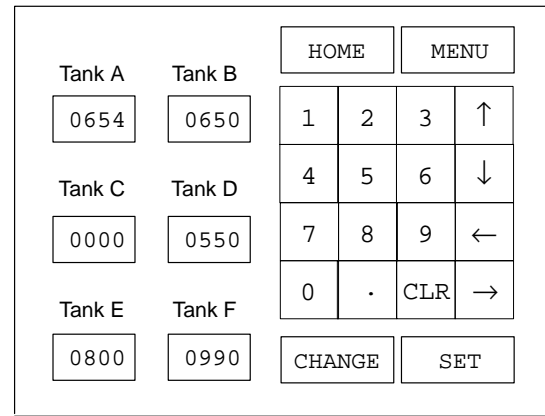

Creating Numeric Setting Screens

When creating a numeric setting screen with the Support Tool, take note of the following points.

- 1) A numeric setting screen cannot be set as the child screen of a continuous screen.
- 2) Ordinary touch switches can be set in numeric input screens, but touch switch numbers 244 through 255 cannot be used.
- 3) When “10-key” is set to “user” in the screen attributes, touch switch numbers 231 through 255 cannot be used for purposes other than numeric input.
- 4) The numeric setting function cannot be used when the screen attribute “bit input” is enabled for PTs with no touch panel.

Inputting Numeric Values (PTs With Touch Panels)

1) Inputting Numeric Values with the Standard Screen:

- The numeral shifts from the rightmost digit to the left each time a screen key is pressed.
- If a decimal point is set, the shift is from the rightmost digit in the decimal area to the integer side.

2) Inputting Numeric Values with a User-set Screen:

- The numeral shifts from the rightmost digit to the left each time a screen key is pressed.
- If a decimal point is set, the integer portion is received first, and with each numeric key input there is a shift from the rightmost digit to the left.
- When the decimal point key is pressed, the decimal portion will then be received. From that point on, with each numeric key input there is a shift from the rightmost digit in the decimal portion to the left.

Inputting Numeric Values (PTs Without Touch Panels)

Use the 12-key Function Key Unit).

1) Inputting Numeric Values with the Standard Screen:

Use the corresponding function keys. Numeric input is the same as for PTs with touch panels.

2) Inputting Numeric Values with a User-set Screen:

Use the corresponding function keys. Numeric input is the same as for PTs with touch panels.

Numeric Input Example

This example shows numeric input with a user-set screen. The display settings made with the Support Tool are as follows:

Number of digits displayed: 7
 Number of integer digits: 4
 Number of decimal digits: 3
 Zero suppress: No
 Plus/minus mark display: No

The following table shows the inputs and the resulting changes in the display.

| Input operation | Set value |
|-----------------|-----------|
| Initial display | 1234.567 |
| Input "CLR" | 0000.000 |
| Input "2" | 0002.000 |
| Input "7" | 0027.000 |
| Input "." | 0027.000 |
| Input "2" | 0027.002 |
| Input "1" | 0027.021 |
| Input "9" | 0027.219 |
| Input "↵" | 0027.219 |

Numeric values input with the input keys are stored in the numeral table justified to the right, as shown above. When the CLR Key is pressed for the first time, the initial display is cleared. If zero suppress were enabled, the number displayed would be "0.000" instead of "0000.000." When the "2" is then input, it is registered at the rightmost integer position, as described on the preceding table. The "2" is then shifted to the left as the "7" is input. After the decimal point is input, numerals are then registered at the rightmost decimal position. (To return to integer input status, press the CLR Key again.) Finally, pressing the Enter Key causes the numeral table data to be transmitted to the host.

Direction Keys and Home Key

Pressing the direction keys (i.e., the arrow keys) moves the cursor to other numeric setting columns. Pressing the Home Key moves the cursor to the upper left of the screen.

Differences in Cursor Movement

When multiple numeric setting areas are created for a numeric setting screen, cursor movement will be different depending on whether system keys or touch switches are used.

Screen Example

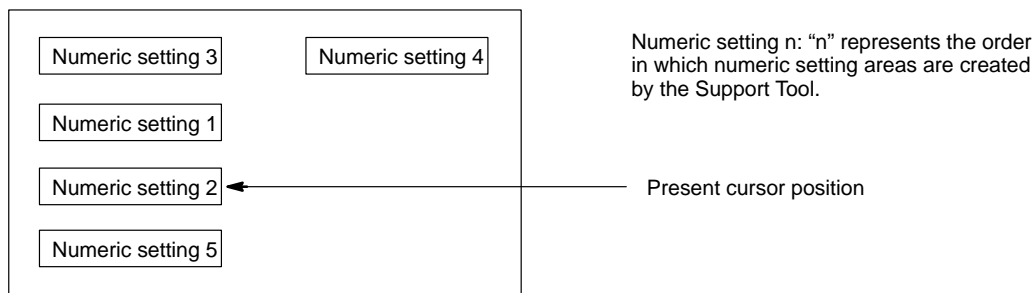

1) When System Keys are Used:

When system keys are used, the cursor moves from area to area in the order in which the areas were created by the Support Tool. Thus, in the screen example shown above, the cursor would start at numeric setting 2 and move in order to numeric settings 3, 4, 5, and back to 1.

2) When Touch Switches are Used:

When touch switches are used, the cursor moves from area to area according to the layout of the screen. Thus, in the screen example shown above, the Down Key would move the cursor from numeric setting 2 to numeric setting 5. After that, the Down Key cannot move the cursor any further.

Pressing the Up Key would then move the cursor back to numeric setting 2, and then continue to move it upward in order to numeric settings 1 and 3. The Right Key would then have to be used to move the cursor to numeric setting 4.

5-3 Standalone Function

When a screen for which the standalone function has been set by the Support Tool is displayed, the screen can be changed by means of touch switches and function keys.

Example

Registered Screen

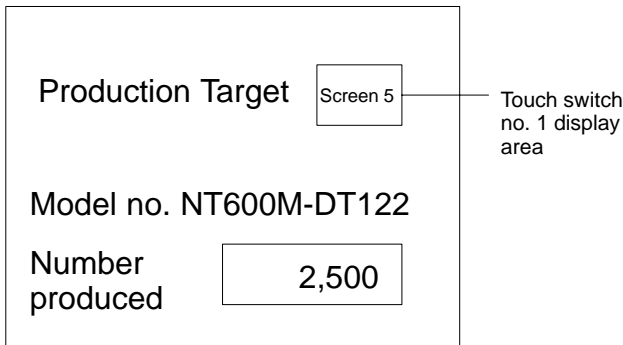

Screen No. 5

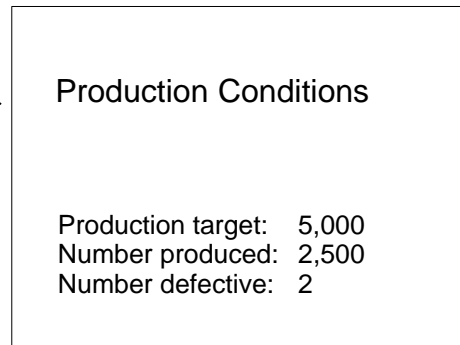

Items Registered to Screen by Support Tool

- Standalone function setting
- Touch switch or function key number
- Screen number to be displayed when touch switches or function keys are input

Example

Standalone function is set.
 Touch switch number: No. 1
 Screen to be displayed: No. 5

When touch switch no. 1 is input, screen no. 5 is displayed.

SECTION 6

System Menu

This section describes data transfer and maintenance functions. Functions used to create screens and control display attributes on the PT are described in *Section 4 Display Functions*. Functions used to input data on-screen are described in *Section 5 Input Functions*. Transferring screens online to and from the host computer is described in *Section 7 Online Transfer*.

| | | |
|-------|-------------------------------------|----|
| 6-1 | Configuration of System Menu | 62 |
| 6-2 | System Menu and Transmit Mode | 63 |
| 6-2-1 | Quit | 63 |
| 6-2-2 | Transmit Mode | 63 |
| 6-2-3 | Maintenance Mode | 63 |
| 6-2-4 | Expansion Mode | 63 |
| 6-2-5 | Display History | 63 |
| 6-2-6 | I/O Checks | 65 |
| 6-2-7 | PT Settings Check | 69 |
| 6-2-8 | Initialization | 70 |
| 6-3 | Memory Switch Settings | 71 |

6-1 Configuration of System Menu

The System Menu is used to set NT600M system parameters in advance and perform maintenance. With the System Menu you can, in addition to determining the NT600M's status, check switch settings and perform simple I/O checks.

- (1) If there is no key input within 10 seconds while the System Menu is being displayed, the system will automatically return to RUN Mode. To toggle between RUN Mode and the System Menu, press the Up, Down, and Buzzer keys simultaneously.
- (2) The RUN indicator will be OFF while the System Menu is being displayed.

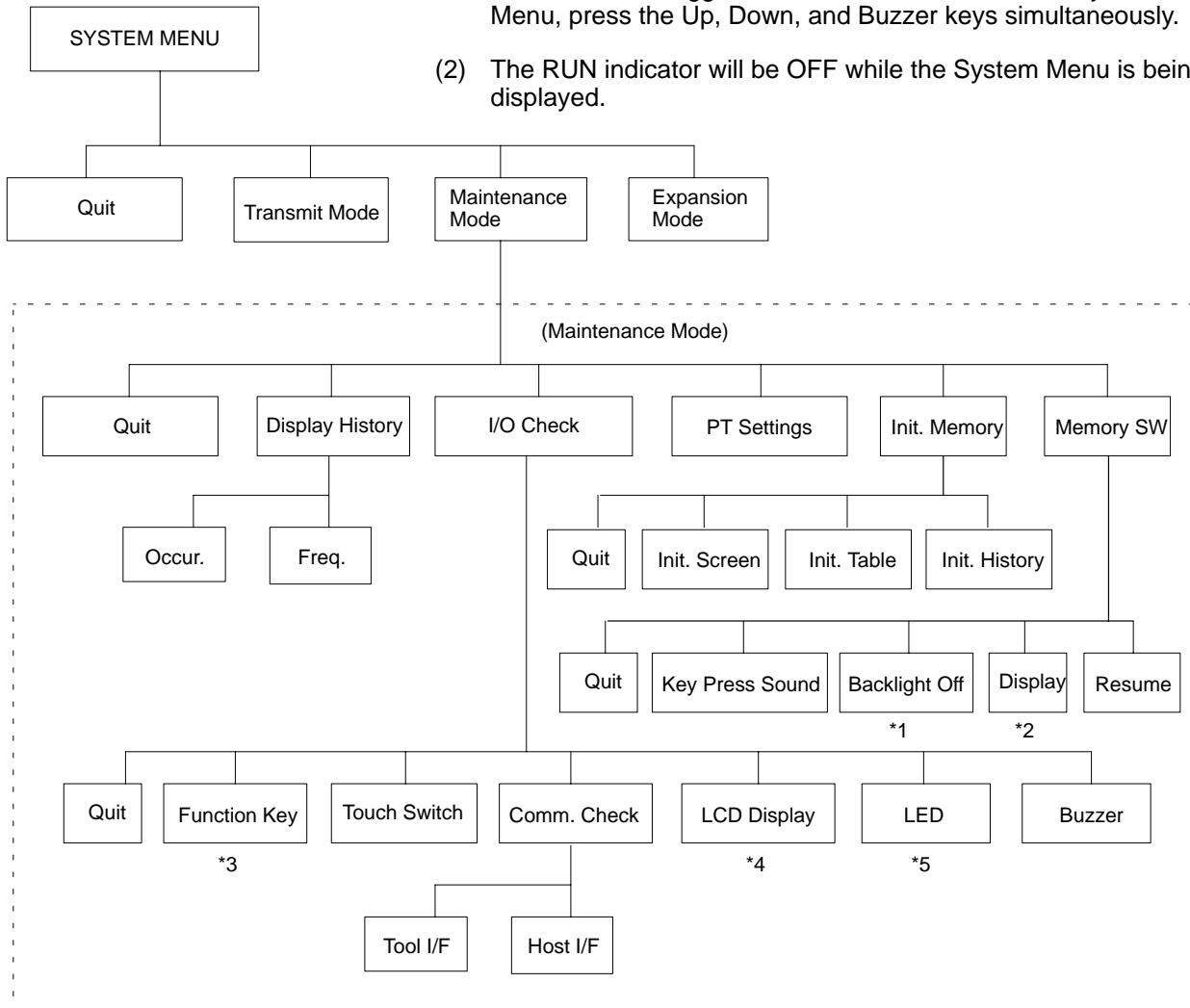

*1: For PTs with EL displays, this becomes the residual image elimination function.

*2: This does not apply to PTs with EL displays.

*3: This in turn has two submenus: "Function Key Check" and "Lamp Check."

*4: For PTs with EL displays, this becomes "EL Display."

*5: This applies only to PTs with EL displays.

6-2 System Menu and Transmit Mode

6-2-1 Quit

To leave the System Menu and return to RUN Mode, select Quit. If no key is pressed for 10 seconds, the PT will automatically return to RUN Mode.

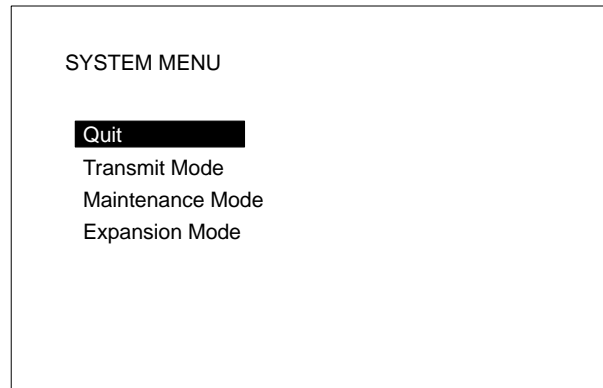

6-2-2 Transmit Mode

This mode is used to transfer data between the PT and the Support Tool.

6-2-3 Maintenance Mode

When making initial settings or when there is an operating error, select Maintenance Mode and conduct all the checks.

Maintenance Mode Menu

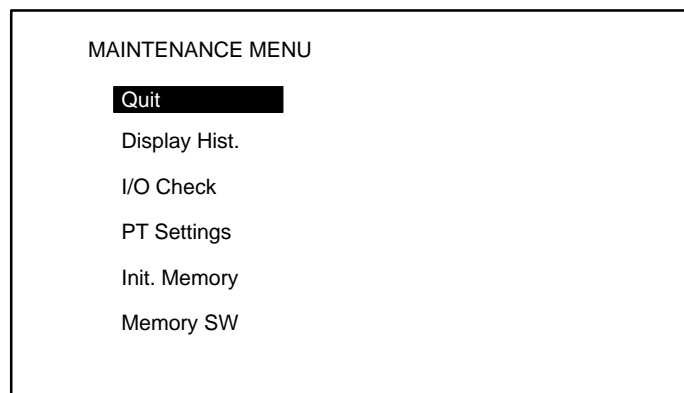

Move the bar cursor with the Up key and Down key, and select with the Enter Key.

6-2-4 Expansion Mode

This mode is not presently being used. This mode is being reserved for future expansion of functions.

6-2-5 Display History

The NT600M saves into memory and can display the history of screens displayed during operation, as long as the history attribute has been set for them by the Support Tool. The history can be displayed either in order of occurrence or in order of frequency. This function can be used to help identify the causes of malfunctions or to enable the operator to know which functions are often being used.

Setting History Data

(1) When creating screens with the Support Tool, use screen attribute designations to register history attributes and messages (within 24 characters) for the screens you want to save in the history.

(2) Whenever the screen number registered for history attributes is designated by the host, the occurrence and message are saved in memory. The capacity of the history is 1,023 screens in chronological order or 255 occurrences per screen in frequency order. The only things that can be recorded are screen numbers and messages. History record data is backed up by a battery, so, as long as the battery is installed, the contents will be retained even when the power is turned off.

(3) Before beginning to record, initialize the history data by transmitting an Initialize History command from the host, or by selecting Init. Hist. from the Maintenance Mode. If the history data capacity is exceeded, newly occurring history data will not be saved.

Reading History Data

Enter Maintenance Mode from the System Menu.

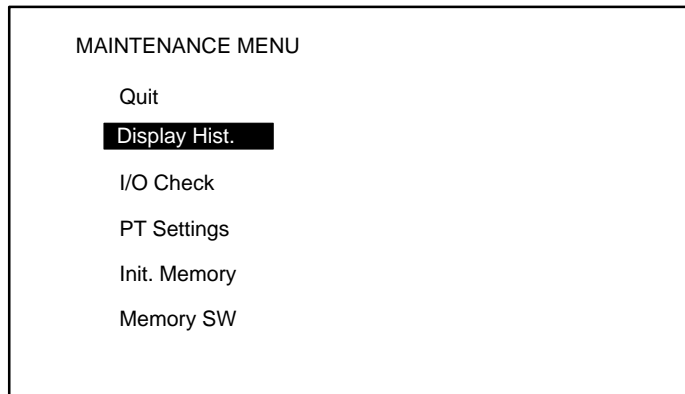

Move the bar cursor to History Record by pressing the Up and Down Keys. Then press the Enter Key.



Select whether the history is to be displayed in order of occurrence or in order of frequency. First move the bar cursor to your selection by means of the Up and Down Keys, and then press the Enter Key.

Order of Occurrence

Record data is displayed in order of occurrence.

| No. | Times | Message |
|-----|-------|--------------|
| 1 | () | Coolant Mal. |
| 5 | () | Motor Mal. |
| 200 | () | Comp. Mal. |
| 150 | () | Press Mal. |

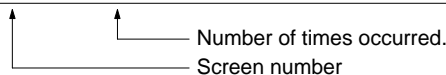

- Up to 48 items of registered data can be displayed on a screen.
- If not all of the record data shows on the screen, then use the Down Key to scroll down.
- To return to the System Menu, press the Buzzer Key, Up Key, and Down key simultaneously.

Order of Frequency

Record data is displayed in order of frequency.

| No. | Of | Times | Message |
|-----|----|-------|--------------|
| 200 | (| 2) | Comp. Mal. |
| 1 | (| 1) | Coolant Mal. |
| 5 | (| 1) | Motor Mal. |

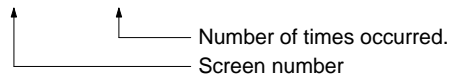

When different messages occur with the same frequency, they are displayed in order beginning with the lowest screen number.

When there is no display data, the following message will be displayed (for both order of occurrence and order of frequency).

| |
|--------------------------|
| History Record Not Found |
|--------------------------|

Initializing History Data

To delete history data, first select Maintenance Mode from the System Menu. The Maintenance Mode Menu will be displayed. Then select "Init. Memory," followed by "Init. History." A message will then be displayed asking for confirmation that you want to initialize the history.

Select whether or not the history is to be initialized. If you select Yes, then initialization will be executed. All recorded history will be deleted. If you select No, then operation will commence without initialization.

6-2-6 I/O Checks

In the Maintenance Mode Menu, use the Up and Down Keys to move the bar cursor to I/O Check. When you then press the Enter Key, one of the following menu will be displayed, depending on the input switch specifications. With the I/O Check Menu displayed, move the bar cursor to the item you want to check, and then press the Enter Key.

(1) DT-type PT with LCD Display

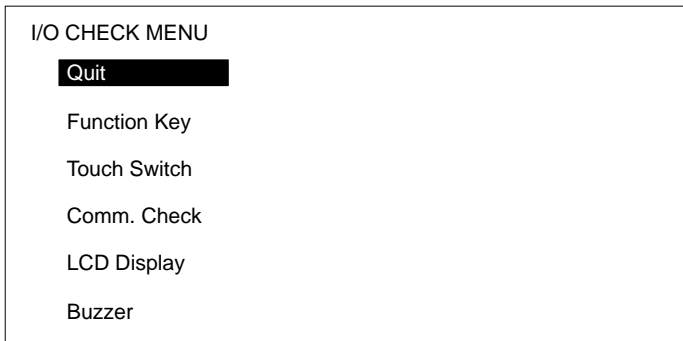

(2) DT-type PT with EL Display

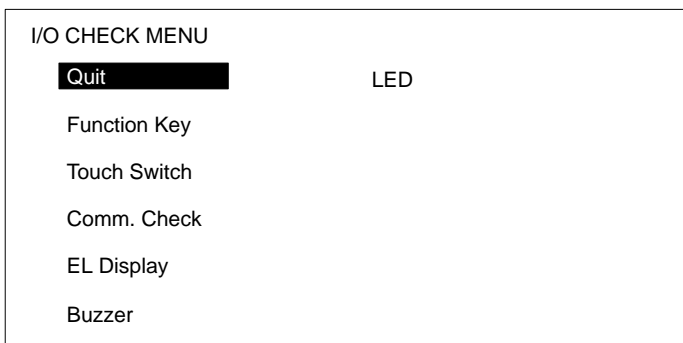

(3) DF-type PT with LCD Display

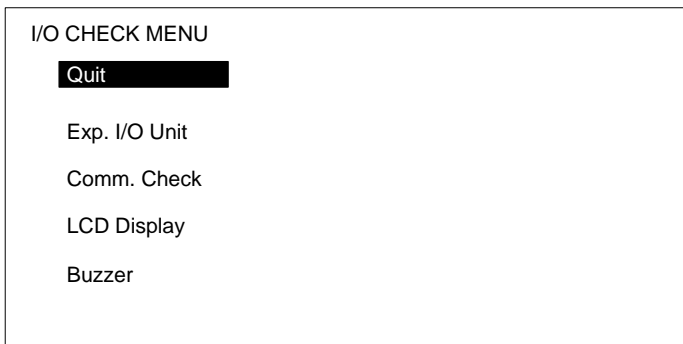

(4) DN-type PT with EL Display

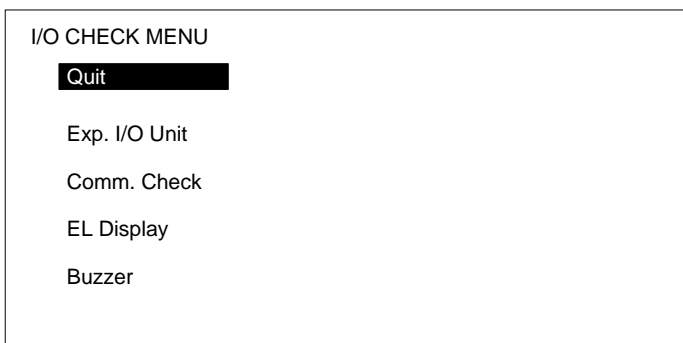

Function Key Check (DN-type PTs)

| | | | | | | | |
|-----|-----|-----|-----|-----|-----|-----|-----|
| F1 | F2 | F3 | F4 | F5 | F6 | F7 | F8 |
| F9 | F10 | F11 | F12 | F13 | F14 | F15 | F16 |
| F17 | F18 | F19 | F20 | F21 | F22 | F23 | F24 |
| F25 | F26 | F27 | F28 | F29 | F30 | F31 | F32 |
| F33 | F34 | F35 | F36 | F37 | F38 | F39 | F40 |
| F41 | F42 | F43 | F44 | F45 | F46 | F47 | F48 |
| F49 | F50 | F51 | F52 | F53 | F54 | F55 | F56 |
| F57 | F58 | F59 | F60 | F61 | F62 | F63 | F64 |

The operation of the function keys can be checked. Press a function key. If the number of that key is displayed in reverse video on the screen, then it is operating properly.

To return to the I/O Check Menu, press the Buzzer Key, Up Key, and Down Key simultaneously.

Touch Switch Check (DT-type PTs)

| | | | | | | | | | | | | | | | | | |
|--|--|--|--|--|--|--|--|--|--|--|--|--|--|--|--|--|--|
| | | | | | | | | | | | | | | | | | |
| | | | | | | | | | | | | | | | | | |
| | | | | | | | | | | | | | | | | | |
| | | | | | | | | | | | | | | | | | |
| | | | | | | | | | | | | | | | | | |
| | | | | | | | | | | | | | | | | | |
| | | | | | | | | | | | | | | | | | |
| | | | | | | | | | | | | | | | | | |

The operation of the touch switches can be checked. Press each switch displayed on the screen. If the switch that has been pressed (for approximately 0.5 s) is displayed in reverse video on the screen, then it is operating properly. Switch numbers are not transmitted to the host during the check operation.

If “Key Press Sound” (under the Memory SW Menu in Maintenance Mode) is set to “ON,” then the buzzer will sound simultaneously with the inverse video display.

To return to the I/O Check Menu, press the Buzzer Key, Up Key, and Down Key simultaneously.

12-key Function Key Unit Check (DN-type PTs)

12-key Function Key Unit inputs and outputs can be checked if the Programmable Terminal is a DN type. Select “Exp. I/O Unit,” and then select either “Function Key Input Check” or “Lamp Output Check.”

External Function Key Input Check

When the external input terminals are turned on one-by-one, the corresponding function keys are displayed in reverse video and can be checked. When

a 12-key Function Key Unit is connected, F1 through F12 correspond to IN0 through IN11.

| | | | | | | | |
|-----|-----|-----|-----|-----|-----|-----|-----|
| F1 | F2 | F3 | F4 | F5 | F6 | F7 | F8 |
| F9 | F10 | F11 | F12 | F13 | F14 | F15 | F16 |
| F17 | F18 | F19 | F20 | F21 | F22 | F23 | F24 |
| F25 | F26 | F27 | F28 | F29 | F30 | F31 | F32 |
| F33 | F34 | F35 | F36 | F37 | F38 | F39 | F40 |
| F41 | F42 | F43 | F44 | F45 | F46 | F47 | F48 |
| F49 | F50 | F51 | F52 | F53 | F54 | F55 | F56 |
| F57 | F58 | F59 | F60 | F61 | F62 | F63 | F64 |

To return to the I/O Check Menu, press the Buzzer Key, Up Key, and Down Key simultaneously.

Lamp Output Check

When “Lamp Output” is selected, “L1” is displayed in reverse video and output 1 turns ON. Use the Up Key and the Down Key to check all of the lamp outputs. (The Up Key moves the reverse video location from left to right, and the Down Key moves it from right to left.)

When a 10/02 Terminal or a 32/16 Terminal is connected, the corresponding output turns on simultaneously with the lamp number that is displayed in reverse video.

| | | | | | | | |
|-----|-----|-----|-----|-----|-----|-----|-----|
| L1 | L2 | L3 | L4 | L5 | L6 | L7 | L8 |
| L9 | L10 | L11 | L12 | L13 | L14 | L15 | L16 |
| L17 | L18 | L19 | L20 | L21 | L22 | L23 | L24 |
| L25 | L26 | L27 | L28 | L29 | L30 | L31 | L32 |
| L33 | L34 | L35 | L36 | L37 | L38 | L39 | L40 |
| L41 | L42 | L43 | L44 | L45 | L46 | L47 | L48 |
| L49 | L50 | L51 | L52 | L53 | L54 | L55 | L56 |
| L57 | L58 | L59 | L60 | L61 | L62 | L63 | L64 |

To return to the I/O Check Menu, press the Buzzer Key, Up Key, and Down Key simultaneously.



Caution

If a load (e.g., a buzzer or alarm light) is connected to a 10/02 Terminal or a 32/16 Terminal, it will actually operate. This can be potentially dangerous, so exercise caution.

Communications Check

When “Communications Check” is selected, the Communications Check Menu is displayed. Use the Up and Down Keys to move the bar cursor to the item you want to check, and then press the Enter Key.

| | |
|------------------|---|
| COMM. CHECK MENU | |
| Tool I/F | █ |
| Host I/F | |

To return to the I/O Check Menu, press the Buzzer Key, Up Key, and Down Key simultaneously.

Tool Interface Check

Data transmitted from the Support Tool is displayed in hexadecimal. If any numeral is displayed, then the interface is operating properly. If no numerals are displayed, then there is a Support Tool operation error, communications cable error, or communications hardware error.

Host Interface Units with RS-232C Specifications (NT600M-LK201)

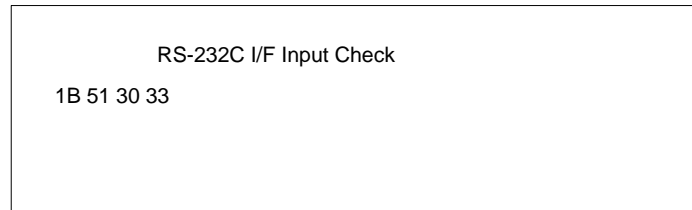

LCD/EL Display Check



The display check can be carried out for both the LCD display and EL display.

The lines of the display are reversed one at a time, starting from the top of the screen. When the reversal is finished, then they are cleared one at a time. When all of them have been cleared, the I/O Check Menu is returned to. You can interrupt the check and return to the I/O Check Menu by pressing the Buzzer Key, Up Key, and Down Key simultaneously while the check is in progress.

Buzzer Check

By selecting "Buzzer" from the I/O Check Menu, the PT buzzer can be checked. The buzzer should produce a continuous sound. To stop the buzzer, press the Buzzer Key. While the buzzer is sounding, it will not be possible to change screens or stop the buzzer by pressing the Buzzer Key, Up Key, and Down Key simultaneously.

LED Check

When PTs with EL displays (i.e., NT600M-DT/DN211 PTs) are used, a lighting check can be carried out for the front panel RUN and BAT LOW indicators. When "LED" is selected, the RUN and BAT LOW indicators should begin to blink if they are operating properly. If the battery voltage is low, the BAT LOW indicator will remain steadily lit.

6-2-7 PT Settings Check

The status of the NT600M and Host Interface Unit can be checked, as well as the settings of switches. First select "PT Settings" from the Maintenance Menu. There are two screens. One displays the contents of PT settings, and the other displays the contents of Host Interface Unit settings. Use the Up Key and the Down Key to change back and forth between the screens.

PT Settings

When "PT Settings" is selected, the status of internal NT600M settings is displayed first.

1) DT-type PTs

| | | |
|--------------|---------|---|
| PT Settings | | Next Page i |
| Memory Type | RAM | |
| Memory Size | 128 KB | |
| Host RUN | Disable | |
| Mode Changes | No | |

Memory type and memory size are displayed only after the screen memory has been initialized. If it has not been initialized, then "N.A." is displayed.

2) DN-type PTs

| | | |
|---------------|----------|---|
| PT Settings | | Next Page i |
| Memory Type | RAM | |
| Memory Size | 128 KB | |
| Host RUN | Disable | |
| Mode Changes | No | |
| Exp. I/O Unit | Standard | |

- When an Expansion I/O Unit is connected to a DN-type PT, the 12-key Function Key Unit type is displayed.

Standard: 12-key Function Key Unit
 Not Connected; No Expansion I/O Unit is connected.

- If a 12-key Function Key Unit becomes disconnected during operation, a continuous buzzer will sound and a "No Expansion I/O Unit" error message will be displayed.

Host Interface Unit Settings

The DIP switch settings on the Host Interface Unit can be displayed by pressing the Down Key while PT settings are being displayed. The following display example is for the NT600M-LK201 Host Link Interface Unit. For examples of other Host Interface Units, see the *Host Interface Unit Operation Manual*.

| | | |
|------------------------|----------|--|
| Host Link I/F Settings | | Page j |
| Beginning word | DM0000 | |
| Number tables | 32 | |
| String tables | 8 | |
| Baud Rate | 9600 bps | |

To return to the PT Settings display, press the Up Key.

6-2-8 Initialization

You must initialize the internal memory when using the SRAM or EEPROM for the first time. Initialization can also be used to clear all of the data already registered in the NT600M. Screen data can be initialized regardless of the setting for the resume function.

Initializing Screen Memory

In order to initialize screen memory, for example, first select “Init. Memory” from the Maintenance Menu. The Memory Initialization Menu will then be displayed, offering several choices of memory to initialize.

| | |
|----------------------|---|
| Screen data | Screen data and all kinds of set values |
| Memory table data | Numeral tables, string tables (Initialization restores values set by Support Tool.) |
| Display history data | Retains the number of times a screen for which “history attributes have been set is displayed by means of commands from the host. (Only when battery is installed.) |

When “Init. Screen is selected, the following screen will be displayed for confirmation.

Initialize Screen Memory?

Yes

No

If you select Yes, then initialization will be executed and all screen data will be deleted. After processing has been completed, RUN Mode will be restored.

If you select No, then RUN Mode will be restored without initialization.

If you also wish to initialize any other data, display the System Menu again and start the process from the beginning.

Initializing Display History

The display history can be saved either in terms of order of occurrence or order of frequency. Once the capacity is full, history records beyond that point will not be saved, so it is necessary to periodically initialize the history.

To initialize the history, first select “Init. History” from the Memory Initialization Menu. The following message will then be displayed for confirmation.

Initialize History?

Yes

No

If you select Yes, then initialization will be executed and history data will be deleted and RUN Mode will be restored. If you select No, then RUN Mode will be restored without initialization.

It is also possible to initialize the display history by means of a command from the host. For details, refer to the *Host Interface Unit Operation Manual*.

6-3 Memory Switch Settings

Memory switch settings set the NT600M display and key input sounds.

Select "Memory SW" from the Maintenance Mode Menu.

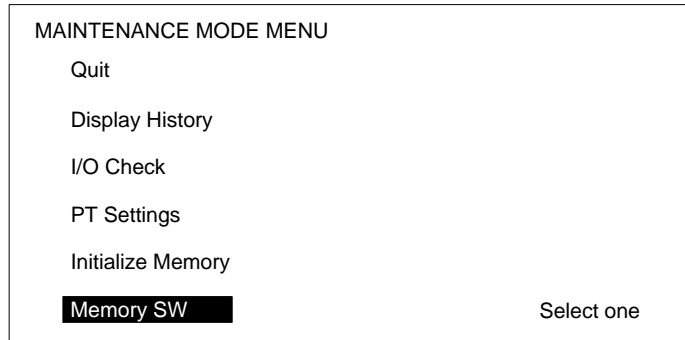

Liquid Crystal Display Type

Move the cursor to the item that is to be set and press the Enter Key. Each time that it is pressed, the set value will change. After the settings have been made, press the Buzzer, Up, and Down keys to return to RUN Mode. If the power to the NT600M is turned off at this point, the settings will not be registered.

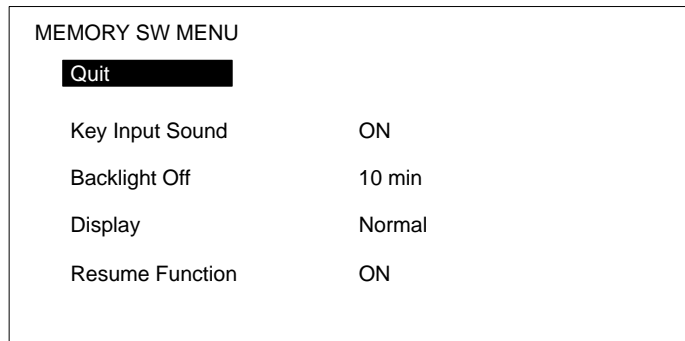

EL Display Type

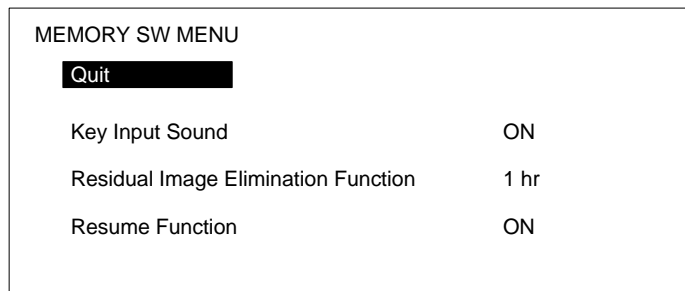

Contents of Settings

| Item | Setting | Contents | |
|--------------------------|---------|---|--|
| Key input sound | ON | The buzzer sounds for 0.2 second when a system key, touch switch, or function key is input. | |
| | OFF | The buzzer does not sound when a system key, touch switch, or function key is input. | |
| Backlight off (LCD type) | 10 min | If no key input (see note 1) or command (see note 2) is received for 10 minutes while a screen is being displayed, the backlight turns off. | If a backlight-off command is transmitted from the host, the backlight turns off regardless of this setting. |
| | 1 hr | If no key input (see note 1) or command (see note 2) is received for one hour while a screen is being displayed, the backlight turns off. | |
| | None | The backlight stays on constantly. | |

| Item | Setting | Contents |
|---|---------------|--|
| Display (LCD type) | Normal | The screen display is normal. |
| | Reverse video | The screen is displayed with dark and light reversed. |
| Residual image elimination function (EL type) | 10 min | If no key input (see note 1) or command (see note 2) is received for 10 minutes while a screen is being displayed, the screen turns off. |
| | 1 hr | If no key input (see note 1) or command (see note 2) is received for one hour while a screen is being displayed, the screen turns off. |
| | None | The screen stays on constantly. The residual image elimination function does not operate, so turn off the screen periodically by means of the host program. |
| Resume function | ON | The contents of memory tables written by the host during operation are retained even if the NT600M power turns off or a reset is executed. |
| | OFF | If power to the NT600M is turned off or a reset is executed, the contents of the memory table are overwritten by the contents of data created by the Support Tool. |

Note 1. Key Inputs

System keys, touch switches, function keys

2. Commands

Screen-change command

Setting screen overlap command (serial type communications only)

On-line transfer completed command (Restart with change to RUN Mode)

Backlight-on command

3. indicates a default setting.

Operating Conditions for the Backlight Off and Residual Image Elimination Functions

When either “backlight off” or “residual image elimination” is set to either “10 minutes” or “one hour,” the internal timer starts counting as soon as the key input or command is received. When the time is up, the backlight or EL screen turns off. The relevant key inputs and commands are as follows:

When any one of the above key inputs or commands is received, the backlight will be turned back on and the internal timer will start counting again. If a key input or command is then received before the time is up, the timer will be reset and the count will start over.

Resume Function

The resume function retains character string and numeral table data when power is interrupted or when the reset switch is pressed.

1, 2, 3...**1. When the Resume Function is Set to Off**

The contents of character string and numeral tables are cleared when the power to the PT is turned off or when the reset switch is pressed. After the power is turned back on, or after the reset, character string and numeral table data is read from the screen memory and operation begins again. If new character string or numeral table data is transferred from the Support Tool, that new data overwrites the data in the memory tables.

2. When the Resume Function is Set to On

If the power to the PT is turned off, or if the reset switch is pressed, the character string or numeral table data prior to the power interruption or reset is retained. If new character string or numeral table data is transferred from the Support Tool, the contents of the screen memory are refreshed but the memory table data does not change. In order to return the contents of the memory tables to the initial values that were created by the Support Tool, execute “initialize memory table.”

Display Examples

Depending on the setting of the resume function, the display at the time of powering up will be as follows:

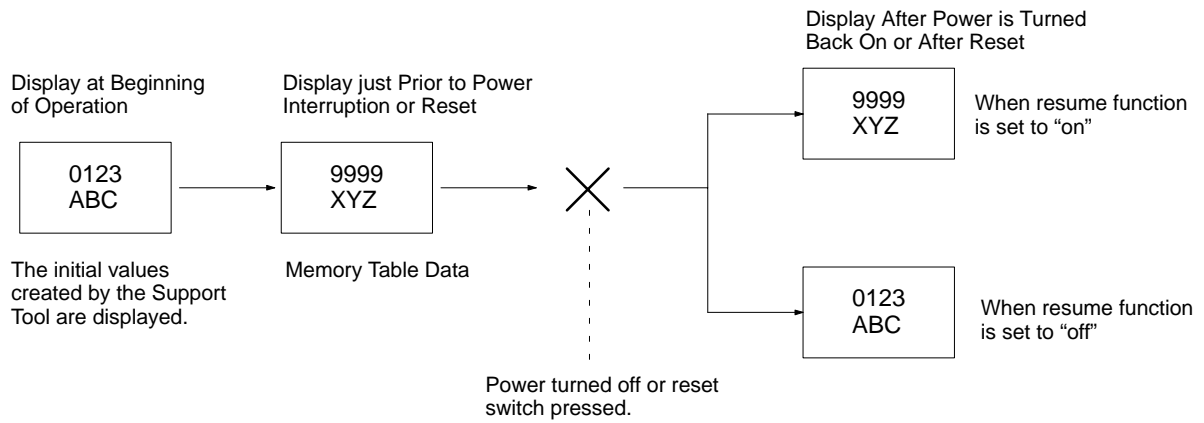

SECTION 7

Online Transfer

This section describes transferring screens online to and from the host computer. This function can only be used with RS-232C and RS-422A Host Interface Units. For details on Host Interface Unit commands, refer to information on on-line transfers in the Host Interface Unit Operation Manual. Functions used to create screens and control display attributes on the PT are described in *Section 4 Display Functions* of this manual. Functions used to input data on-screen are described in *Section 5 Input Functions*. Data transfer and maintenance functions are described in *Section 6 System Menu*.

| | | |
|-----|------------------|----|
| 7-1 | Host to PT | 76 |
| 7-2 | PT to Host | 76 |

7-1 Host to PT

- Screen data can be transferred along with screen numbers. Set the desired screen number. If you set a screen number which is identical with one already registered in the NT600M, then the screen data for that number will be overwritten.
- In addition to screen data, it is possible to transfer memory tables and marks.
- A data transfer can be aborted by pressing the Buzzer Key, Up Key and Down Key simultaneously. If that is done in the middle of a transmission, that portion of the data which has already been transferred will be stored, but all data beyond that point will be destroyed.
- If a transfer of mark data is interrupted, the data may be corrupted. If that occurs, a message will be displayed to that effect when the System Menu is next opened.

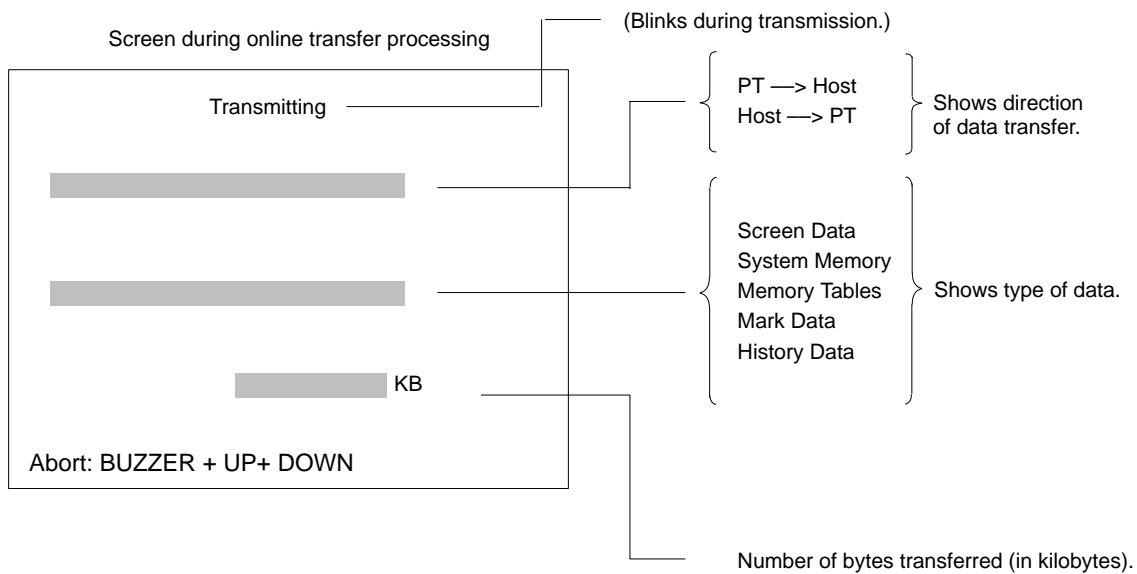

7-2 PT to Host

PT to Host

Screen data can be transferred along with screen numbers. All screens can be transferred together, or any particular screen can be transferred individually. In addition to screen data, memory tables, marks, and display histories can also be transferred. Screen data is not lost even if the transmission is interrupted by a system key input.

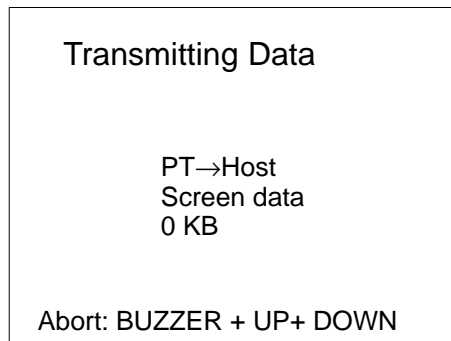

Relationship Between On-line Transfer and the Resume Function

Just as when transferring data from the Support Tool, on-line transfer writes data directly from the host to the screen memory. The display contents, therefore, are affected by the resume function.

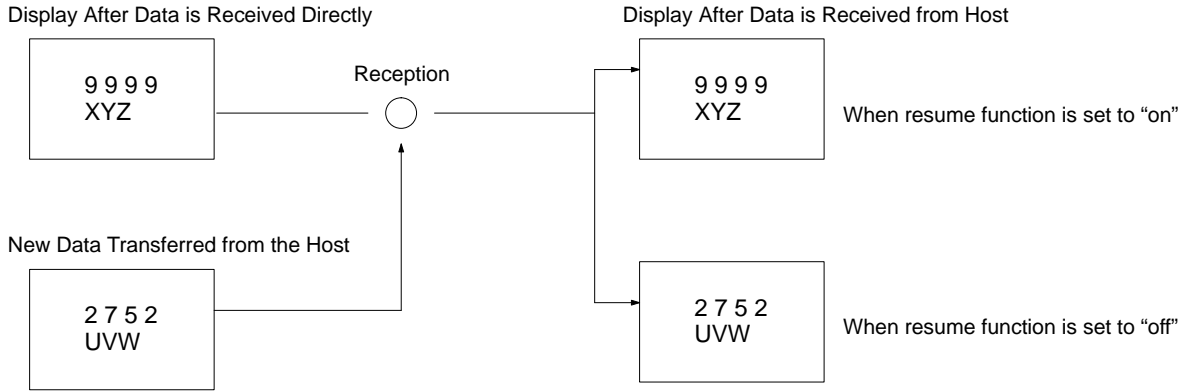

SECTION 8

Maintenance and Inspection

This section provides troubleshooting and basic maintenance methods, including battery replacement.

| | | |
|-------|---|----|
| 8-1 | Checking Operation | 80 |
| 8-2 | Changing the Lithium Backup Battery | 80 |
| 8-3 | Maintenance and Inspection | 81 |
| 8-3-1 | Spare Terminals | 81 |
| 8-3-2 | Inspection | 81 |
| 8-3-3 | Precautions When Cleaning the PT Screen | 82 |
| 8-4 | RUN Mode Function Configuration | 83 |

8-1 Checking Operation

The hardware status of the NT600M can be checked with the Maintenance Menu. Symptoms and corrective measures for errors that cannot be checked are shown in the table below.

| Symptom | Probable cause | Corrective measures, processing |
|---|---|--|
| POWER indicator does not light. | Power is not being input. | Provide a power supply with a rated voltage of 100 to 240 VAC. |
| | A fuse is blown. | Contact your OMRON representative. |
| Screen does not display. | It is waiting for a command from the host, or there is no screen data, or the contrast is poorly adjusted. | Transfer a command from the host. Screen data should be registered at the Support Tool in advance. Adjust the contrast. |
| | The System ROM is not installed correctly. | Mount the System ROM into the socket in the correct direction, and make sure that it is secured. |
| Screen suddenly goes blank. | Screen no. 0 has been called by the host. | There is no problem. Correct the application program. |
| Cannot communicate with Support Tool. | PT is not in Transmit Mode. | Select Transmit Mode from the System Menu. |
| | There is a faulty connection with the Support Tool. | Check connecting cables. |
| Cannot communicate using Host Interface Unit (Serial communications type) | DIP switch settings are not correct. | Check PT settings under the Maintenance Mode and be sure that settings match the host settings. |
| | Host Interface Unit connections are faulty. | Check wiring of connecting cables. Use shielded wire. Check whether the cables are within the maximum lengths. |
| | For the NT600M-LK202, terminator settings are not correct. | When using RS-422A communications, specify only the last Terminal from the host as the terminator (turn on termination resistance on the last terminal only). |
| Cannot communicate using Host Interface Unit (Parallel communications type)) | Communications timing with Host Interface Unit is incorrect. | Check switch setting and the host's strobe cycle time. The Maintenance Mode can be used to check communications. |
| Message displayed indicating Host Interface Unit is missing. | The Host Interface Unit is not installed properly. | Install the Host Interface Unit. Check to be sure that the specifications match for the System ROM and the Host Interface Unit. |
| Lamp remains lit when screens are changed. | Lamp and touch switch are overlapping. | Touch switches can be used as lamps just as they are. (They have shared functions.) |
| Message displayed indicating screen data is corrupted. | 1) Screen memory is defective. 2) There was a power interruption or the reset button was pressed while data was being transferred. | 1) Replace the screen memory. 2) Initialize the screen memory, and then re-transmit the data. |
| Buzzer sounds and RUN indicator turns off. Operation suddenly stops. Displays go out and do not return. | 1) System ROM is not properly installed. 2) There was a malfunction due to external noise | 1) Mount the System ROM into the socket in the correct direction, and make sure that it is secured. 2) Keep the communications cable separate from sources of noise. Install noise filters in power supply lines. |
| System messages display is wrong. | DIP switch 1-3 is OFF. | Turn off the power, then set DIP switch 1-3 to ON and turn the power on again. |

8-2 Changing the Lithium Backup Battery

In the NT600M, a lithium cell is used for a memory backup. If the BAT LOW indicator on the front panel lights, replace the battery within five days.

| | |
|---------------------|---|
| Battery model | 3G2A9-BAT08 |
| Battery backup time | 5 years at 25°C. |
| Replacement time | Within 5 minutes from the time power is turned off. |

- Note**
1. The battery can also be replaced while the power is on. If you do it that way, then there is no need to replace the battery within five minutes, but you must exercise care in handling.
 2. Even if the BAT LOW indicator does not light, the battery should be replaced after five years.

Replacing the Battery

- 1, 2, 3... 1. Turn the power off. If the power has not been on, turn it on for at least one minute and then turn it off again before replacing the battery.
2. Take off the switch cover on the back of the Terminal.
3. Remove the battery from the connector and put in a new battery. Be sure that the connector is straight when inserted.

- Note**
- a) Do not take more than five minutes to replace the battery, otherwise the internal memory may be lost.
 - b) The battery can be replaced with the PT turned on, in which case there is no limitation for battery replacement time.

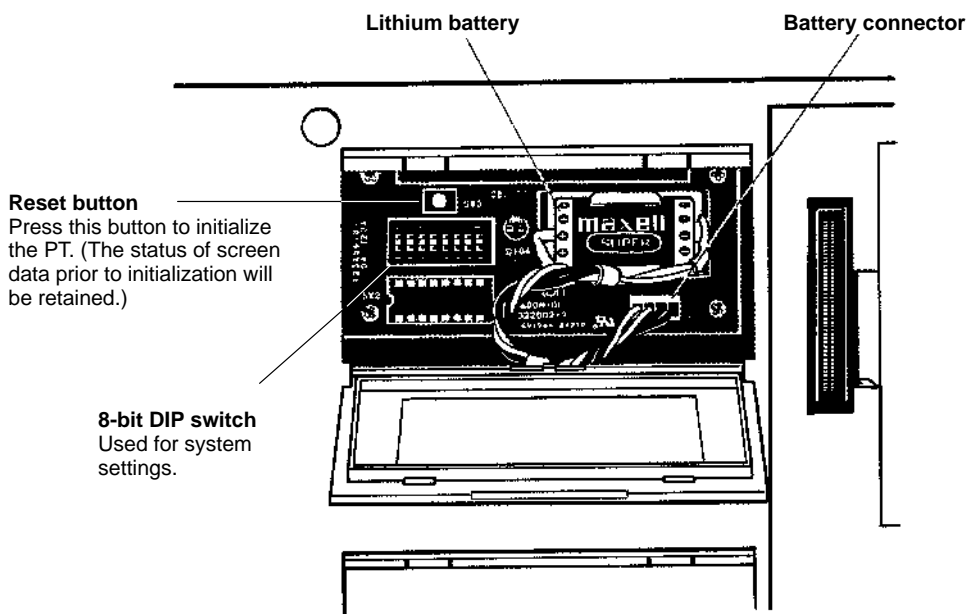

4. Replace the cover.

Caution The lithium battery can explode if placed into a fire, or it can explode, burn, or leak if the + and – terminals are short-circuited or if the battery is recharged or dismantled. Handle the battery with care.

Note If no battery is connected, BAT LOW indicator operation is not stable.

8-3 Maintenance and Inspection

8-3-1 Spare Terminals

In order to restore operations as quickly as possible in the event of a NT600M breakdown, it is a good idea to always keep a spare Terminal on hand.

8-3-2 Inspection

- The NT600M's liquid crystal display and backlight can wear out. If they become hard to see, replace the Terminal.

- The standard inspection period is once every 6 to 12 months, but it should be moved up if the operating environment is harsh. If there is any deviation from the criterion, then it should be corrected.

| Inspection item | Inspection content | Criterion | Remarks |
|-----------------------|--|---|----------------------|
| Power supply | Measure at the power supply terminal block. Are voltage fluctuations within the criterion? | Voltage fluctuation range (85 VAC to 264 VAC) | Tester |
| Operating environment | Is the ambient temperature (the temperature inside of the panel) suitable? | 5°C to 40°C | Thermometer |
| | Is the ambient humidity (the humidity inside of the panel) suitable? | 35% to 85% There should be no condensation. | Hydroscope |
| | Is dust collecting? | There should be no dust. | Visual |
| Installation | Is each Terminal firmly secured? | There should be no loose screws. | Accessory tool |
| | Are the connectors for the connecting cable inserted perfectly and locked? | There should be no loose screws. | --- |
| | Are any screws for the external wiring coming loose? | There should be no loose screws. | Phillips screwdriver |
| | Is any external wiring loose or disconnected? | There should be no external abnormalities. | Visual |
| Replaceable parts | Can you read the characters on the liquid crystal display? Is the backlight illumination as bright as it should be? | Average life expectancy of liquid crystal: 50,000 hrs Average life expectancy of backlight: 20,000 hrs | Visual |

Tools for Inspection

- Phillips and Flat-blade screwdrivers
- Voltage tester or digital voltmeter
- Industrial alcohol and all-cotton cloth

Measuring Instruments (Depending on Case)

- Synchroscope
- Oscilloscope with pen output
- Thermometer
- Hydroscope

Precautions for Handling

- Turn off the power before replacing Terminals.
- When you discover a defective Terminal and replace it, check again to be sure that the problem was actually with the Terminal.
- When returning a defective Terminal for service, please describe the problem in as much detail as possible. Send the Terminal to the OMRON offices closest to you.

8-3-3 Precautions When Cleaning the PT Screen

If the NT600M screen gets dirty, it will become hard to read. Be careful of the following points when cleaning it.

- When cleaning, wipe with a dry, soft cloth. If the dirt does not come off, then moisten the rag with water and rub hard.
- Wiping with a chemical cloth or with volatile solutions such as benzine or thinner may cause degeneration. A little alcohol may be used if necessary.
- Prolonged contact with rubber, vinyl products, or tape may leave marks.

8-4 RUN Mode Function Configuration

RUN Mode Chart

This chart shows the measures to be taken in response to an error which occurs in RUN Mode.

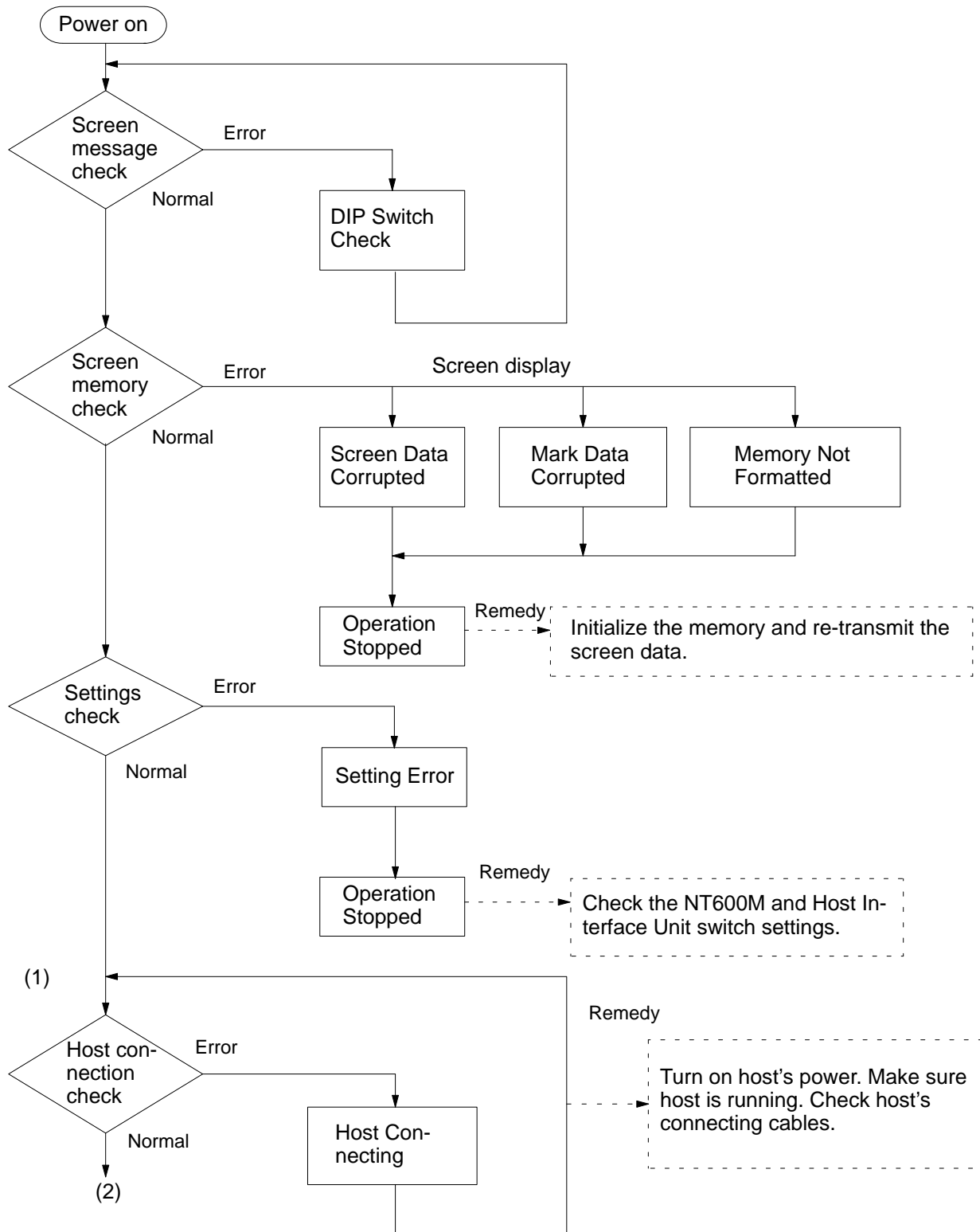

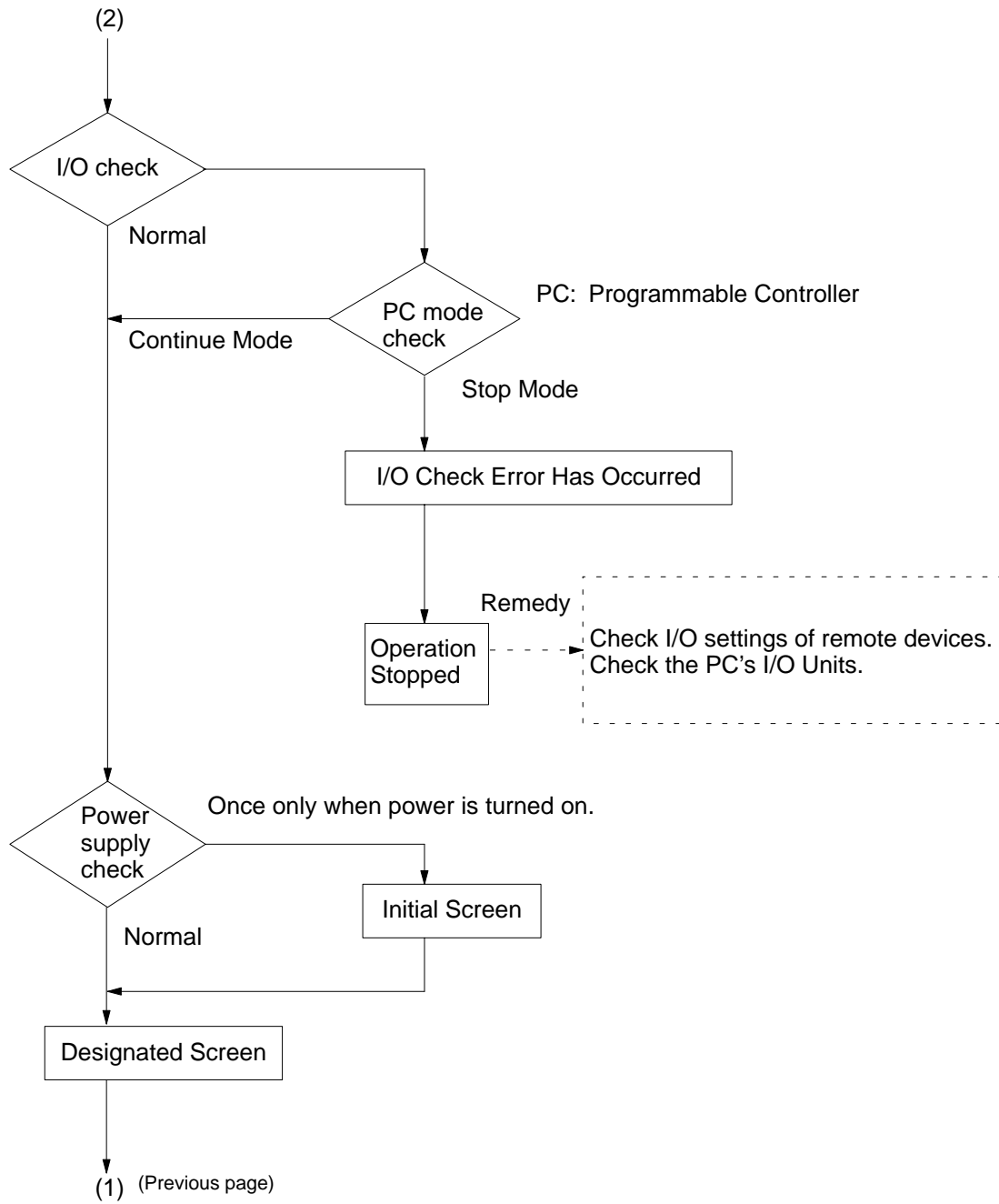

Appendix A

Standard Models

RS-232C Cable for Connecting Devices (CV500-CN228)

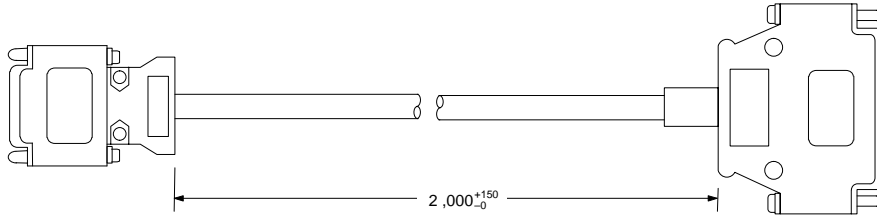

Note The personal computer end of the CV500-CN228 Connecting Cable is a 25-pin D-sub male connector. To connect to an IBM PC/AT or compatibles, a 9-pin or 25-pin D-sub female adapter is required.

Dustproof Cover

NT600M-KBA01 (for NT600M-DT/DN□□□)

NT600M-KBA02 (for NT600M-DF122 and NT600M-DN211 + NT600M-FK210)

Under severe conditions, this can be used to protect the display area and the controls from oil and dust.

NT600M-KBA01 Dimensions

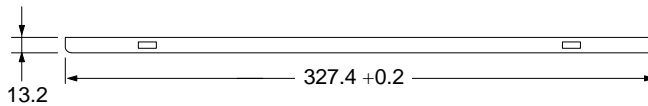
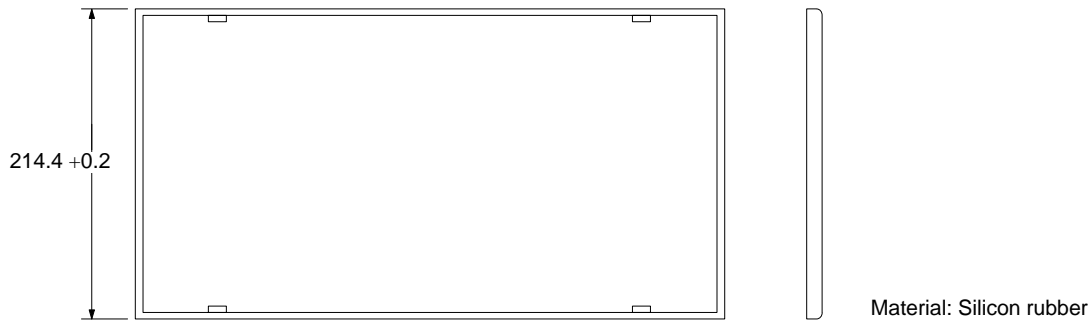

Dimensions (mm)

NT600M-KBA02 Dimensions

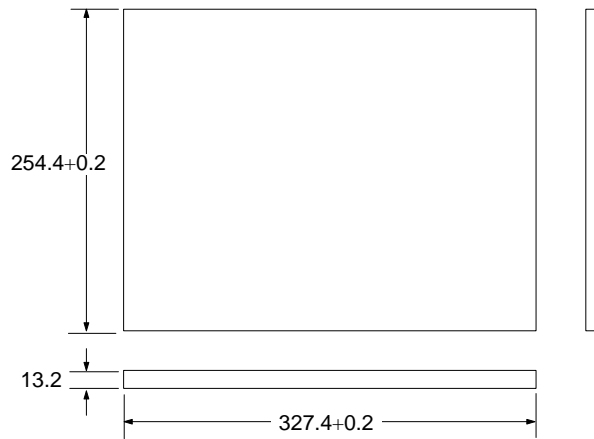

Protective Sheet

NT600M-KBA11 (for NT600M-DT/DN/DF122)

NT600M-KBA12 (for NT600M-DT/DN211)

The protective sheet protects the display screen from dirt and scratches, and eliminates reflection and glare. (The back side of the sheet has a sticky surface. Peel the paper off of the back and attach the sheet.)

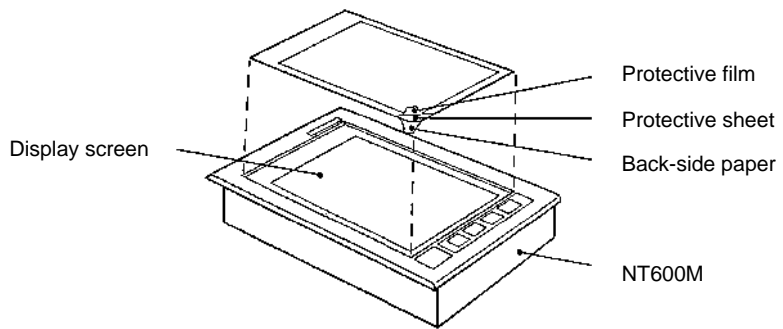

Dimensions

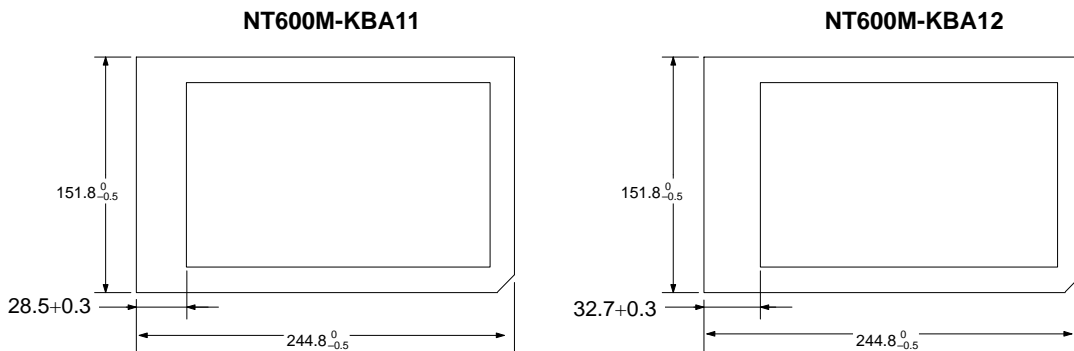

NT600M-DF122 Key Sheets (Five Sheets)

Use these sheets for NT600M-DF122 and NT600M-FK210 function keys. By simply peeling them off of the paper, you can easily write on them and attach them. You can also rub off anything written with oil-base ink. If they get dirty, you can easily remove and replace them.

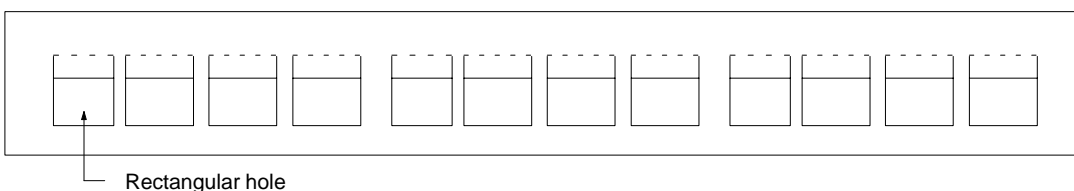

Appendix B Specifications

General Specifications

| Item | Specifications |
|--------------------------------------|---|
| Power supply voltage | 100 to 240 VAC |
| Allowable power supply voltage range | 85 to 264 VAC, 50/60 Hz |
| Power consumption | 40 VA max. |
| Insulating resistance | Between AC terminal block and GR: 20 MW min. (at 500 VDC) |
| Dielectric strength | Between AC terminal block and GR: 2,300 VAC at 50/60 Hz for 1 min Leakage current: 0.8 mA max. |
| Noise resistance | 1000 VAC _{p-p} Pulse width: 100 ns to 1 ms Pulse rise time: 1 ns |
| Vibration resistance | NT600M-DT/DF-122: 10 Hz to 22 Hz with 1.5-mm double amplitude in X, Y, and Z directions 22 Hz to 500 Hz (1.5 G; 14.7 m/s ²) in X, Y, and Z directions for 30 min total NT600M-DT/DN211: 10 Hz to 50 Hz with 0.5-mm single amplitude (acceleration: 2.0 G; 19.6 m/s ²) in X, Y, and Z directions for 1 hr each |
| Shock resistance | Destruction: 30G (294 m/s ²) 3 times each in X, Y, and Z directions Malfunction: 20G (196 m/s ²) 3 times each in X, Y, and Z directions |
| Ambient operating temperature | NT600M-DT/DF-122: 5°C to 40°C NT600M-DT/DN211: 0°C to 50°C |
| Ambient operating humidity | 35% to 85% (with no condensation) |
| Operating environment | No corrosive gas |
| Storage temperature | NT600M-DT/DF-122: -20°C to 60°C NT600M-DT/DN211: -20°C to 70°C |
| Enclosure ratings | Front control panel IP52 (Drip-proof when dust cover is installed.) Rear case IP20 Terminal section IP00 |
| Weight | Approx. 3 kg |
| Dimensions | NT600M-DT122/DT211/DN211: 325 x 198 x 105 (WxHxD) NT600M-DF122: 325 x 238 x 105 (WxHxD) (These dimensions do not include the cable.) |

Characteristics

Display Specifications

| Item | Specifications |
|-------------------------------------|--|
| LCD-type display: (NT600M-D□122) | Dot matrix STN liquid crystal display device (9.5 inches equivalent) No. of dots: 640 x 400 Effective display area: 206 mm x 130 mm Angle of vision: Up 20°; down 35°; right/left ±30° Life expectancy: 50,000 hrs min. Backlight Cold-cathode tube Life expectancy: 10,000 hrs min. (20,000 hrs average) Automatic turn-off: Can be set to not turn off, or to turn off in 10 min or 1 hr |
| EL-type display (NT600M-D□211) | EL display (9 inches equivalent) No. of dots: 640 x 400 Effective display area: 192 mm x 120 mm Display color: Yellow-orange Life expectancy (with a 30% decrease in brightness): Approx. 30,000 hrs Automatic turn-off: Can be set to none, 10 min or 1 hr |
| Indicators | Three indicators: POWER indicator (Green LED): Lit when power is being supplied. RUN indicator (Green LED): Lit during operation. BAT LOW indicator (Red LED): Lit when battery level drops. |

Control Panel Specifications

| Item | Specifications |
|--|--|
| System keys | Four keys: buzzer-stop, up-scroll, down-scroll, execute (enter) Functions: System Menu selection, buzzer off, bar cursor movement, up/down scroll for continuous screens, execution of numeric settings |
| Touch panel (DT type) | Number of switches: 128 per screen max. Input switch type: Pressure-sensitive Operating force: 100 g min. Life expectancy: 1,000,000 operations min. |
| 12-key Function Key Unit (DN type) NT600M-FK210 Function Keys (DF type) | No. of keys: 12 (fixed) Input switch type: Pressure-sensitive Key sheets are replaceable. |

Display Capacity

| Item | Specifications |
|----------------------|--|
| Display characters | Half-size character (8 x 8 dots): Alphanumeric and symbols Normal character (8 x 16 dots): Alphanumeric and symbols Mark (16 x 16 dots): User defined, 64 max. |
| Character size | Half-size characters: Approx. 2.5 x 2.5 mm Normal characters: Approx. 2.5 x 5.0 mm Marks: Approx. 5.0 x 5.0 mm |
| Enlargement function | Horizontal, vertical, 4 times, 9 times, 16 times, 64 times |
| Display attributes | Inverse, blinking, inverse blinking |
| Graphics | Polyline, circle |

Display Capacity

| Item | | Specifications |
|----------------------------|---------------------------|--|
| Terminal mode | | Characters, numeric values, and graphics designated by the host are displayed (RS-232C or RS-422A interface required). |
| Display elements | Character | Displays optional characters (screen number designation). |
| | Graphics | Polylines (broken continuous line) and circles |
| | String displays | Maximum 256 total, 50 places per screen and 40 bytes per string |
| | Numeral displays | Maximum 256 total, 50 places per screen, 8-digit display |
| | Bar graph display | 2 to 255 dots; 50 places per screen % and \pm display capability |
| | Lamps | Maximum 256, 128 places/screen |
| | Touch-switch | Maximum 256, 128 places/screen |
| | Numeral settings | 50 places/screen |
| Screen types | Normal screen | Displays screen. |
| | Overlapping screens | Overlapping of a maximum of 8 screens is possible. |
| | Continuous screens | Scrolling the display for a maximum of 8 registered screens is possible. Page scroll with system Up and Down Keys. |
| Screen attributes | | Alarm, continuous buzzer, intermittent buzzer, bit function keys, bit touch-switch, display history recording, ten key |
| No. of screens | No. of registered screens | 1,000 max. |
| | Screen numbers | 0: No display (Full screen designation at time of screen data upload.) 1 to 1,000: User-registered screens |
| Screen registration method | | Transfer data to the PT from IBM PC/AT compatible or write to EPROM chip and then install it. |
| Screen saving method | | Can be saved to SRAM (with battery backup), EEPROM, or EPROM chip. Memory format: Special NT600M format |

Data Quantities

| Item | Specifications |
|--------------|--|
| String data | 40 characters (normal size characters) x 256 strings max. |
| Numeral data | 8 columns x 256 values max. |
| Mark data | 64 items |
| Switches | Switches and lamps combined: 256 max. |
| Lamps | (There is no limit when the direct connection method is used.) |

Special Features

| Item | Specifications |
|-------------------------|---|
| Alarm output | Relay output on rear terminal block; NO contact. Rating: 1 A at 24 VDC or 0.5 A at 100 VAC, with resistance load Output condition: NO Contact (Closes when a command is received from the host or when there is a screen displayed with an alarm-ON specification.) |
| Host RUN input | Photocoupler input on rear terminal block. Rating 24 VDC +10%/-15% When this input goes OFF, the display "host error" regardless of other conditions. |
| Buzzers | Two types: Continuous sound and intermittent sound. ON: The buzzer will sound when a key input is made, when a buzzer-ON command is received from the host, or when a screen with a buzzer-ON specification is called. OFF: The buzzer is turned OFF when the Buzzer Key is pressed, when a buzzer-OFF command is received from the host, or when a screen without a buzzer-ON specification is displayed. Loudness: 80 dB min. and 87 dB on average (measured at a distance of 10 cm) |
| Maintenance functions | Self-test for memory, switches, etc. Status setting confirmation for communications and other conditions. Simple communications confirmation. |
| Battery backup | Data backed up by battery when screen memory is SRAM. Data backup time: 5 years (at 25°C) If there is a voltage drop, the BAT LOW indicator on the front panel will light and the Battery Low Flag to the host will turn ON. The battery can be replaced from the rear of the Terminal during operation. |
| Key input sound setting | If Key Input Sound is set to ON in the Memory Switch Menu, a beep will sound for 0.2 s when a system key, function key, or touch switch is pressed. |

Appendix C

Memory Check Table

This table shows the amount of memory required for creating various kinds of screen data. It can be used a standard for selecting screen memory.

| Data | Item | Without direct connection (Unit: byte) | With direct connection (Unit: byte) | Remarks |
|-----------------------------|--------------------------------|---|--|---|
| Tables, error screens, etc. | File units | 13,480 | 20,146 | Minimum amount required for lower limit. |
| Basic information | Single screen units | W/o history: 10 With history: 34 | 62 | Number of screens required. |
| Link information | Normal screens only | 2 | 4 | |
| Each header | Command units | Fixed information: 6 Other: 4 | 6 | Required first time only. |
| Character input | 1 character | 14 | 14 | Fixed information |
| | 1 character added | +1 | +1 | 1 byte added when all sums are odd numbers. |
| Polyline | One | 10 | 10 | --- |
| | One added | +4 | +4 | |
| Circle | --- | 6 | 6 | |
| Standalone | --- | 8 | --- | |
| Character string display | --- | 12 | 16 | Variable information |
| Numeric display | --- | 12 | 16 | |
| Bar graph | --- | 24 | 38 | |
| Touch switch | No guide characters | 16 | 30 | --- |
| | 1 guide character | +12 | +12 | |
| | 1 character added | +1 | +1 | 1 byte added when result is odd number. |
| Lamp | Circle: no guide characters | 16 | 30 | --- |
| | Rectangle: no guide characters | 16 | 34 | |
| | 1 guide character | +12 | +12 | |
| | 1 character added | +1 | +1 | 1 byte added when result is odd number. |
| Numeric setting | --- | 4 | 18 | --- |
| Function key | --- | --- | 18 | |
| Overlapping screen | --- | 18 | 18 | Basic screen information added regardless of number of child screens. |
| Continuous screen | --- | 18 | 18 | |

Note If the edge of a screen goes beyond 64K bytes, the data will move to the next page (when 128 bytes or 256 bytes). 32K bytes = 32,768; 64K bytes = 65,536; 128K bytes = 131,072; 256K bytes = 262,144
 I/O headers: 62 bytes (even for only one) + number x 20 bytes

Appendix D

Special Characters

English Character Codes

Pin 2 of SW2 must be ON to enable English language messages to use the following codes.

Example: Hex code is represented by 30, decimal code by 48, and character by 0.

| | |
|----|---|
| 30 | 0 |
| 48 | |

Code 20 and 32 in the table represents a space, as indicated by "SP."

| | 2- | | 3- | | 4- | | 5- | | 6- | | 7- | | 8- | | 9- | |
|-----------|----|----|----|---|----|---|----|---|-----|---|-----|---|-----|---|-----|----|
| -0 | 20 | SP | 30 | 0 | 40 | @ | 50 | P | 60 | ' | 70 | p | 80 | Ç | 90 | É |
| | 32 | | 48 | | 64 | | 80 | | 96 | | 112 | | 128 | | 144 | |
| -1 | 21 | ! | 31 | 1 | 41 | A | 51 | Q | 61 | a | 71 | q | 81 | ü | 91 | æ |
| | 33 | | 49 | | 65 | | 81 | | 97 | | 113 | | 129 | | 145 | |
| -2 | 22 | " | 32 | 2 | 42 | B | 52 | R | 62 | b | 72 | r | 82 | é | 92 | Æ |
| | 34 | | 50 | | 66 | | 82 | | 98 | | 114 | | 130 | | 146 | |
| -3 | 23 | # | 33 | 3 | 43 | C | 53 | S | 63 | c | 73 | s | 83 | â | 93 | ô |
| | 35 | | 51 | | 67 | | 83 | | 99 | | 115 | | 131 | | 147 | |
| -4 | 24 | \$ | 34 | 4 | 44 | D | 54 | T | 64 | d | 74 | t | 84 | ä | 94 | ö |
| | 36 | | 52 | | 68 | | 84 | | 100 | | 116 | | 132 | | 148 | |
| -5 | 25 | % | 35 | 5 | 45 | E | 55 | U | 65 | e | 75 | u | 85 | à | 95 | ò |
| | 37 | | 53 | | 69 | | 85 | | 101 | | 117 | | 133 | | 149 | |
| -6 | 26 | & | 36 | 6 | 46 | F | 56 | V | 66 | f | 76 | v | 86 | â | 96 | û |
| | 38 | | 54 | | 70 | | 86 | | 102 | | 118 | | 134 | | 150 | |
| -7 | 27 | ' | 37 | 7 | 47 | G | 57 | W | 67 | g | 77 | w | 87 | ç | 97 | ù |
| | 39 | | 55 | | 71 | | 87 | | 103 | | 119 | | 135 | | 151 | |
| -8 | 28 | (| 38 | 8 | 48 | H | 58 | X | 68 | h | 78 | x | 88 | ê | 98 | ÿ |
| | 40 | | 56 | | 72 | | 88 | | 104 | | 120 | | 136 | | 152 | |
| -9 | 29 |) | 39 | 9 | 49 | I | 59 | Y | 69 | i | 79 | y | 89 | ë | 99 | Ö |
| | 41 | | 57 | | 73 | | 89 | | 105 | | 121 | | 137 | | 153 | |
| -A | 2A | * | 3A | : | 4A | J | 5A | Z | 6A | j | 7A | z | 8A | è | 9A | Ü |
| | 42 | | 58 | | 74 | | 90 | | 106 | | 122 | | 138 | | 154 | |
| -B | 2B | + | 3B | ; | 4B | K | 5B | [| 6B | k | 7B | { | 8B | ï | 9B | ø |
| | 43 | | 59 | | 75 | | 91 | | 107 | | 123 | | 139 | | 155 | |
| -C | 2C | , | 3C | < | 4C | L | 5C | \ | 6C | l | 7C | | 8C | î | 9C | £ |
| | 44 | | 60 | | 76 | | 92 | | 108 | | 124 | | 140 | | 156 | |
| -D | 2D | - | 3D | = | 4D | M | 5D |] | 6D | m | 7D | } | 8D | ì | 9D | ¥ |
| | 45 | | 61 | | 77 | | 93 | | 109 | | 125 | | 141 | | 157 | |
| -E | 2E | . | 3E | > | 4E | N | 5E | ^ | 6E | n | 7E | ~ | 8E | Ä | 9E | Pt |
| | 46 | | 62 | | 78 | | 94 | | 110 | | 126 | | 142 | | 158 | |
| -F | 2F | / | 3F | ? | 4F | O | 5F | _ | 6F | o | 7F | ⊂ | 8F | Å | 9F | f |
| | 47 | | 63 | | 79 | | 95 | | 111 | | 127 | | 143 | | 159 | |

Index

Numbers

12-key Function Key Units, checking, 67

A

abbreviations, 5
alarms, controlling from host, 49
ALM OUTPUT terminals, 27
ASCII Unit, 11

B

backlight, controlling from host, 48
bar graphs, displaying, 47
battery, replacing, 80
buzzer, controlling from host, 49

C

C200H, host interface, 12
cable, 85
child screens, 43 , 44
cleaning, precautions, 82
communications
 checking, 68
 setting for NT600-LK201-EV1, 16
communications errors, automatic reset setting, 16
contrast control, 14
control panel, specifications, 88
cover, 85

D

data transfer, PT to host, 54
dimensions, 22
DIP switch, 16
direct designation, applicable models, 4
display
 attributes, 41
 capacity, 88 , 89
 character scale, 40
 characters, 40
 controlling from host, 50
 data quantities, 89
 LCD/EL check, 69
 positioning, 40
 specifications, 88
 speed, 50
 types available, 4
display history, 63
 controlling from host, 49
 initializing, 70 , 71

E

error messages, 35
Expansion Mode, 63

F

Function Key Units, 9
function keys, 14 , 56
 checking, 67
 external input check, 67

H

host computer
 controlling PT operation, 48
 data transfer, 45 , 46 , 47 , 50 , 54 , 56
Host Interface Units, 8
 displaying settings, 69
Host Link Unit, interface, 12
HOST RUN INPUT
 controlling from host, 49
 enable/disable setting, 16
HOST RUN INPUT terminals, 26

I

I/O checks, 65
indicators, 14
initialization, 70
 memory, 32
installation
 environment, 20
 mounting position, 21
 panel mounting, 23

K

Key Sheets, 86

L

lamps
 attributes, 47
 displaying, 47
 number per screen, 4
 output check, 68
language, setting, 16
LG and GR terminals, 26

M

maintenance, inspection, 81
Maintenance Mode, 63
manuals, 5
memory, initializing, 32
memory capacity, 7

memory chips, 6
memory switch settings, 71
menus
 overview, 34
 selecting items, 34
 system menu, 62
mode changes, enable/disable setting, 16
models, 6

N

nomenclature, 13
numeral table, 45 , 47 , 56
numeric display, 45
numeric settings, 56

P

parent screens, 43 , 44
power supply, wiring, 25
precautions, general, ix
protective sheet, 86
PT settings, displaying, 69

R

RS-232C interface, 11
RS-232C interface, connector, 27
RS-422A interface, 11

S

Screen Data Memory Boards, 6
 installation, 18 , 19
 switch settings, 18
screen memory, initializing, 70
screens
 changing, 42

 continuous screens, 42
 examples, 41
 maximum limit, 7
 maximum registered, 4
 overlapping screens, 43
 transferring online, 76
specifications, 87
standalone function, 4 , 59
string table, 46
Support Tool, 9
 checking interface, 69
Support Tools, data transfer, 35
switch inputs, transferring to host, 54
switch settings, 16
SYSMAC BUS, interface, 12
system configuration, 10
system keys, 14 , 34

T

terminology, 5
text strings, displaying, 46
touch panel, 13
touch switches, 13
 checking, 67
 creating, 55
Transmit Mode, 63
troubleshooting, 80

W

wiring
 ALM OUTPUT terminals, 27
 HOST RUN INPUT terminals, 26
 LR and GR terminals, 26
 power supply, 25
 RS-232C connector, 27
 terminal block, 25