

New!

OMRON

Programmable Controllers
SYSMAC CP1H

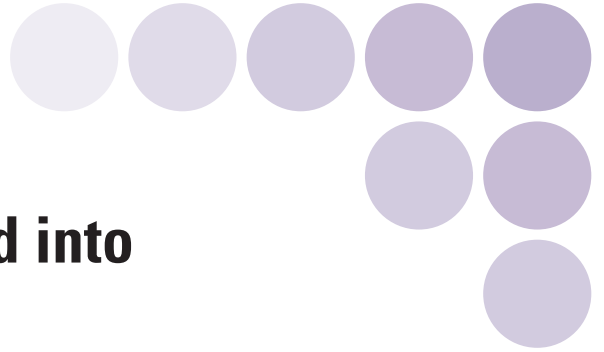

Multi-functionality Condensed into an All-in-one Package



Expanded Range of Applications with Built-in Pulse Outputs for 4 Axes, Analog I/O, and Serial Communications, and with a USB Port as a Standard Feature.

realizing

A New All-in-one Package Controller with Condensed Multi-functionality in a New Black Body

With accelerating globalization and the diversification of market needs, added value is being sought in equipment as never before. The need for enhanced functionality, handling of advanced systems, and improved ease of maintenance and reliability make this a complex matter. OMRON's latest solution is the release of a new package-type terminal-block PLC that combines full basic functionality with advanced expandability.

- A full complement of built-in functions enables increased applicability.
- Reducing the design time required for expanded and more complex programming helps in giving added value to equipment.

Programmable Controllers SYSMAC CP1H

Error Stop Flag

Stopping Flag

Standby Flag

Continuous

Constant

Built-in Analog I/O
XA CPU Units provide 4 input words and 2 output words.

Pulse Outputs
Four axes are standard features.

Counters
4-axis differential phase control is a standard feature.

USB Peripheral Port
Another standard feature.

Serial Communications
Two ports supporting both RS-232C and RS-485.

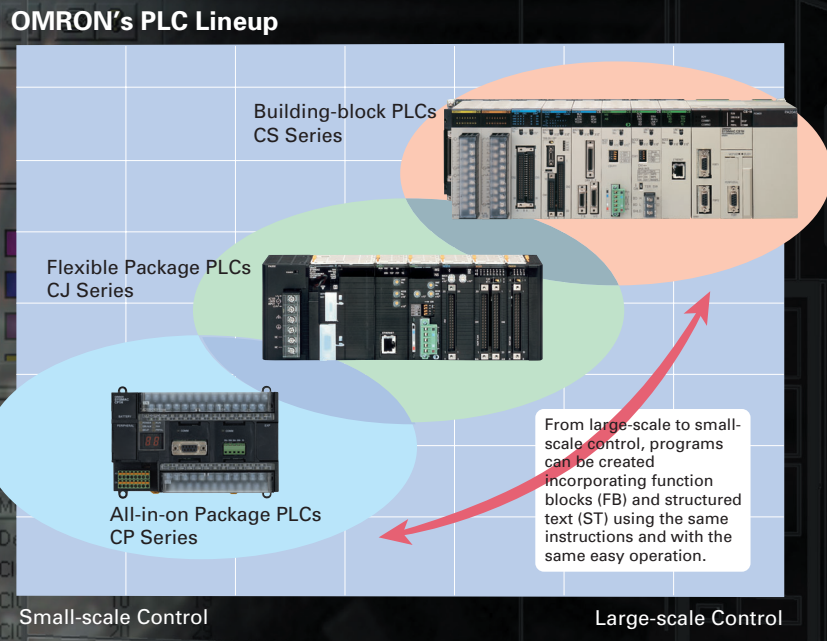

A Choice of Three Basic CP1H CPU Units Lets You Select the Functions You Need.

High-speed Positioning CP1H-Y CPU Units	Built-in Analog I/O CP1H-XA CPU Units	Standard CP1H-X CPU Units
<p>Pulse Outputs for 4 Axes ▶</p> <p>Two axes for 1 MHz and two axes for 100 kHz</p> <p>High-speed Counters ▶</p> <p>Two axes at 1 MHz for single-phase (500 kHz for differential phases) and two axes at 100 kHz for single-phase (50 kHz for differential phases)</p> <p>Built-in Analog I/O ▶</p> <p>Four axes at 100 kHz</p> <p>Serial Communications ▶</p> <p>Two ports supporting both RS-232C and RS-485</p>	<p>Four axes at 100 kHz</p> <p>Four axes at 100 kHz for signal-phase (50 kHz for differential phases)</p> <p>Four analog inputs and two analog outputs</p>	<p>Up to two Option Boards can be mounted.</p>
<p>Option Boards: RS-232C Option Board, RS-422A/485 Option Board</p>		

* The pulse output functionality of CP1H-X/XA CPU Units has been improved from version 1.1.

	Ver. 1.1	Ver. 1.0
Pulse outputs	4 axes at 100 kHz	2 axes at 100 kHz and 2 axes at 30 kHz

Version 1.1 for CP1H-Y CPU Units

Smart Micro PLC

Pulse Output Function

Four Axes are Standard.

Advanced Power for High-precision Positioning Control.

Electrolytic Capacitor Assembly by Electronic Component Manufacturing Equipment

Sheet Feeding for Vertical Pillow Packer

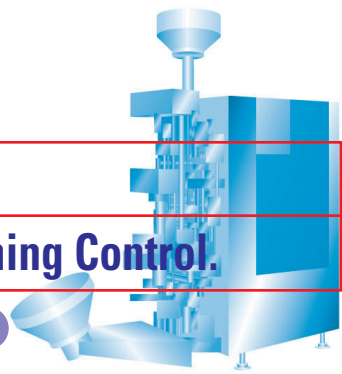

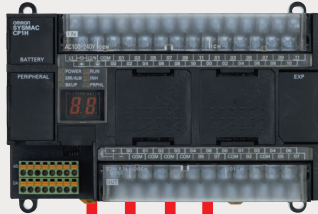

CP1H

Pulse Output Function for Up to Four Axes.
CP1H-Y CPU Units: Two axes at 1 MHz and two axes at 100 kHz
CP1H-X□ CPU Units: Four axes at 100 kHz

Along with greater precision and more flexibility in multi-product manufacturing, high-speed multi-axis pulse output control responds to the increase in servo applications.



Servo Drivers

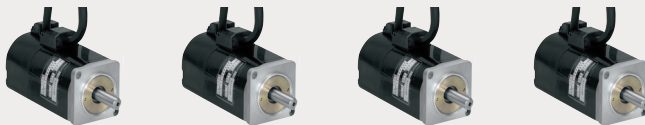

Servomotors

Example: Four-axis Control in Electronic Component Manufacturing Equipment

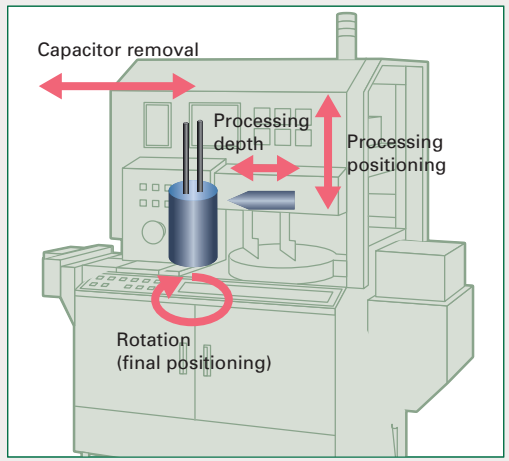

A Full Range of Functions

- Origin Search Function (ORG Instruction)**
 Origin searches are possible with a single ORG instruction.
- Positioning with Trapezoidal Acceleration and Deceleration (PLS2 Instruction)**
 Easily achieved with special positioning instruction (PLS2).

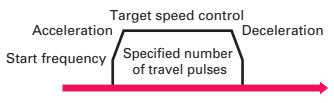

- S-curve acceleration/ deceleration can be used to reduce vibration in high-speed positioning.

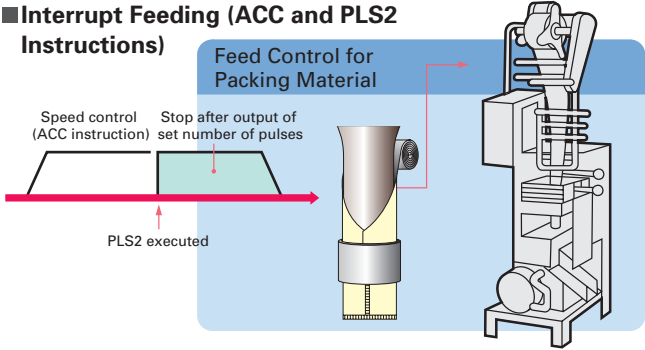

- Interrupt Feeding (ACC and PLS2 Instructions)**
Feed Control for Packing Material

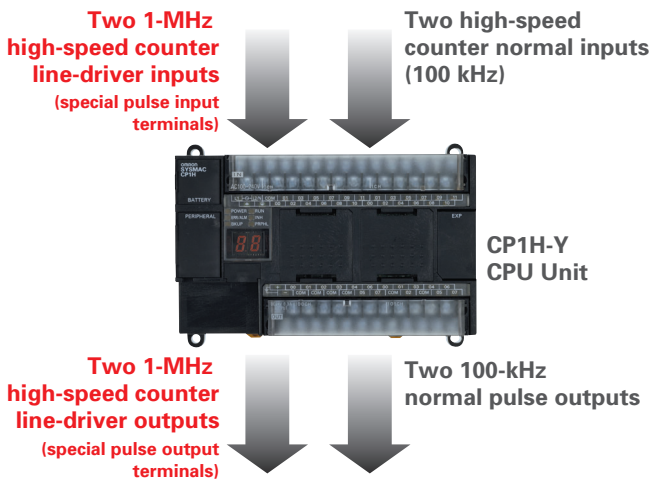

1MHz High-speed Pulse Output (CP1H-Y CPU Units : To be released soon.)



CP1H-Y CPU Units offer built-in 1-MHz line-driver I/O.

- Line-driver outputs: Two each for CW and CCW.
- Line-driver inputs: Two each for phases A, B, and Z.

CP1H-Y CPU Units also have 20 normal I/O points (12 inputs and 8 outputs), and can provide 100-kHz high-speed counter inputs for two axes and 100-kHz pulse outputs for two axes.

High-speed Counter Function

Differential Phases for Four Axes Are Standard

Easily Handles Multi-axis Control with a Single Unit.

Main-axis Control for Equipment Such as Textile Machinery or Spinning Machinery

Positioning Conveyance for Equipment Such as Building Material Manufacturing Machinery and Stone-cutting Machinery

Four-axis Counter Function (Single-phase or Differential Phases)

CP1H-Y CPU Units: Two axes, single-phase at 1 MHz or differential phases at 500 kHz plus two axes, single-phase at 100 kHz or differential phases at 50 kHz

CP1H-X CPU Units: Four axes, single-phase at 100 kHz or differential phases at 50 kHz

Multi-axis counter inputs enable calculations for inverter positioning, spindle speed control in textile manufacturing, and much more.

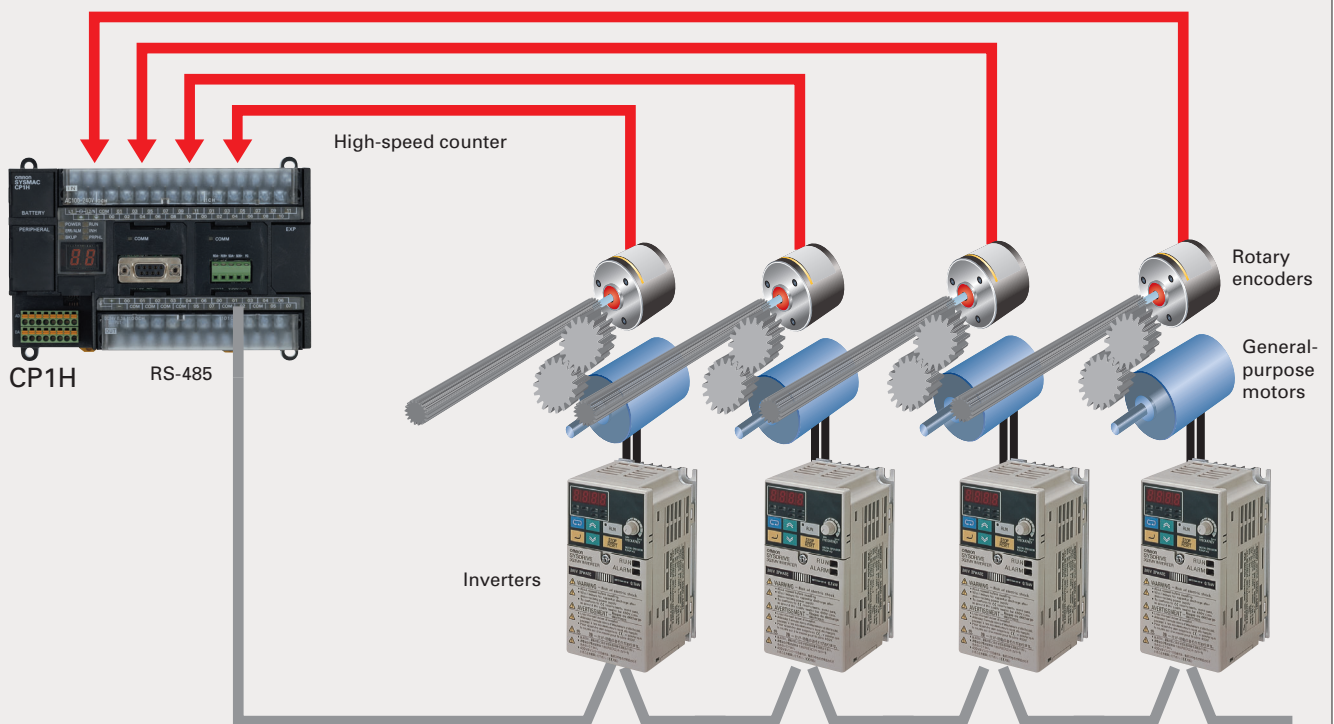

Up to Eight Interrupt Inputs Can Be Used

Eight interrupt inputs are built in. Quick-response inputs for pulse widths of 50 μ s. The interrupt inputs can also be used as single-phase counters. (Response frequency: 5 kHz total for 8 inputs)

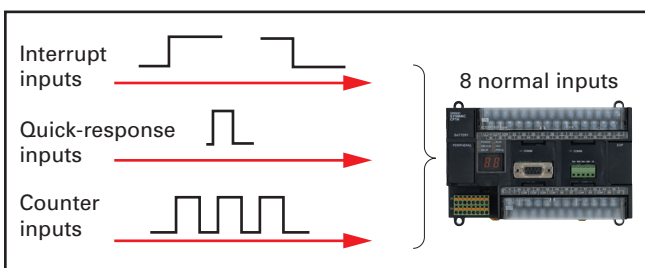

The 8 normal inputs (6 for Y CPU Units) can be selected in the PLC Setup as interrupt, quick-response, or counter inputs.

Compared with the CPM2A, Basic Instructions Are Processed at Least Six Times Faster and MOV Instructions are Processed 26 Times Faster.

Processing has been speeded up for not only basic instructions but for special instructions as well. Faster processing of approximately 400 instructions helps to speed up the entire system.

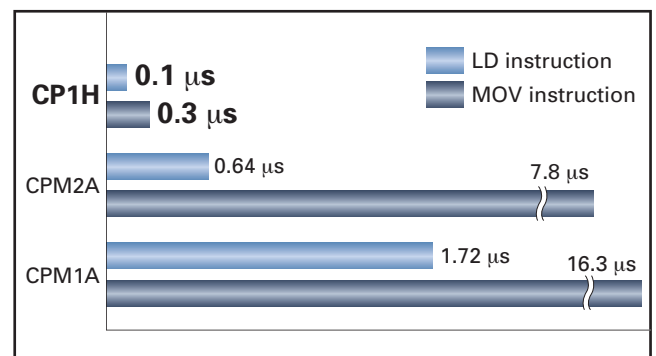

Four Input Words and Two Output Words for XA CPU Units. Analog Control and Monitoring with Only a Single CPU Unit

Surface Inspections Using Inspection Devices

Mechanisms to Prevent Careless Mistakes in Cell Production (Such as Forgetting to Tighten Screws)

Oil Pressure Control in Forming Machines

Analog Control without Using Expansion Units

Four analog inputs and two analog outputs are built in.
CP1H-XA CPU Units handle a wide range of applications with a single PLC.

Previously

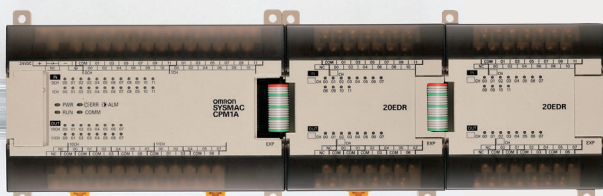

CPM2A CPU Unit with Two CPM1A-MAD11 Analog I/O Units
(2 Analog Inputs and 1 Analog Output)

CP1H

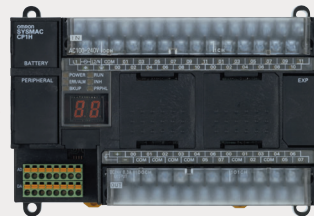

CP1H-XA

Up to 4 input words and 2 output words.
No Expansion Units required.

●Oil Pressure Control

Oil pressure control can also be handled by this CPU Unit.



Analog I/O

Pressure Position Control valves

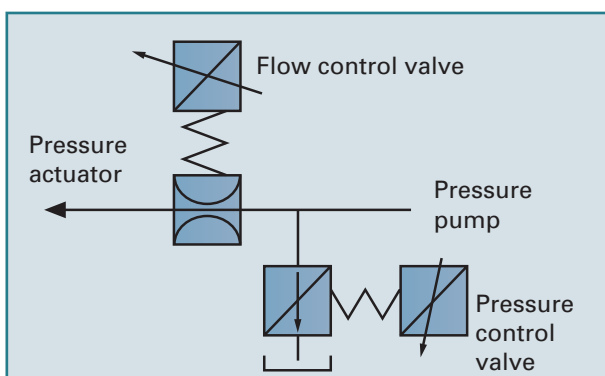

●Inspection Devices

Inspection devices are required more and more to enhance quality.

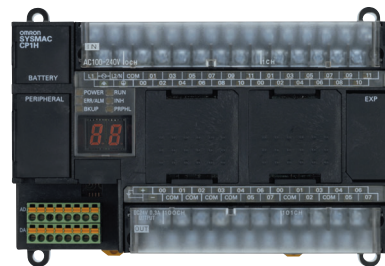

Displacement sensors

Inspection for warping and twisting

Serial Communications

A Standard USB Port and Two Serial Ports Enable Connections and Communications with a Wide Range of Components.

Up to two Option Boards can be mounted for RS-232C or RS-422A/485 communications. A peripheral USB port has been added to connect to a personal computer for a total of three communications ports, making it easy to simultaneously connect to a PT, various components (such as Inverters, Temperature Controllers, and Smart Sensors), Serial PLC Link for linking to other PLCs, and a personal computer.

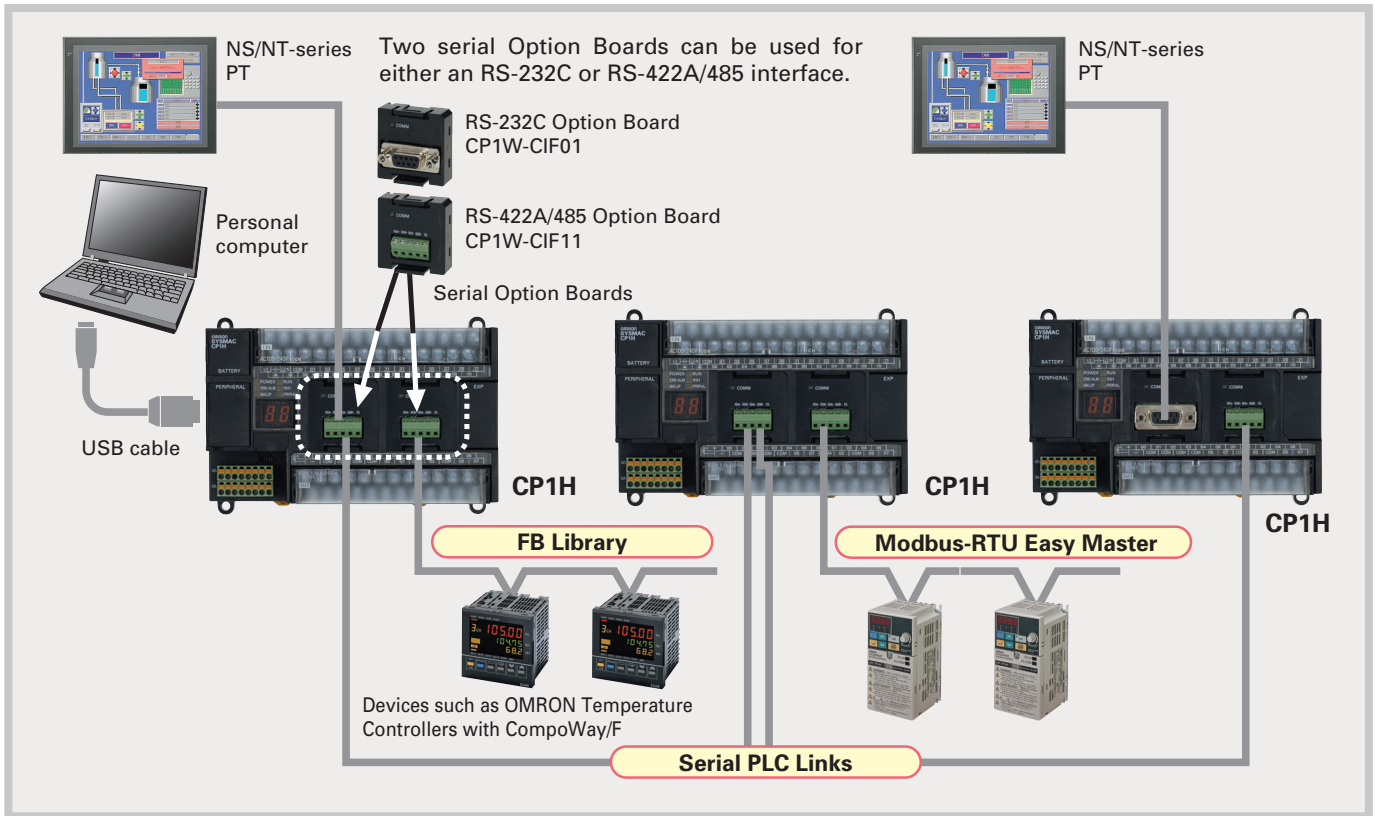

Modbus-RTU Easy Master

Connecting Inverter Speed Control Is Made Simple Using the Modbus-RTU Easy Master. When the address, function, and data for a slave device are preset in a fixed memory area (DM Area), a message can be sent or received simply by turning ON an AR Area bit (A640.00 for port 1 or A641.00 for port 2) in the PLC.

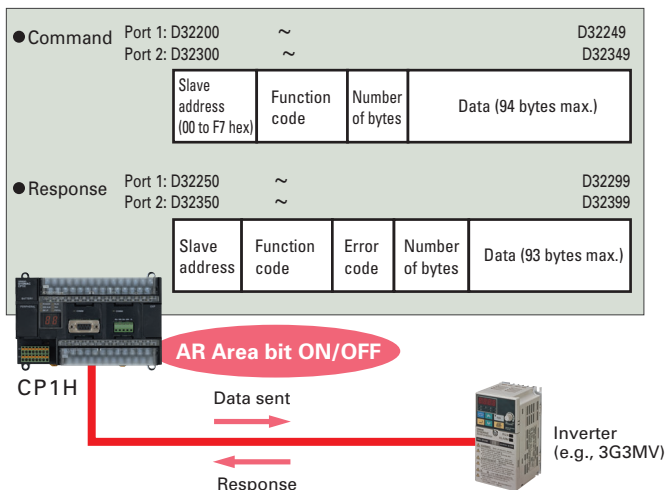

Serial PLC Links

When multiple boilers are being controlled, up to 10 words/Unit of data for settings and monitoring can be exchanged using data links between up to nine CP1H (or CJ1M) CPU Units. PLC Links can be used with either serial port 1 or serial port 2.

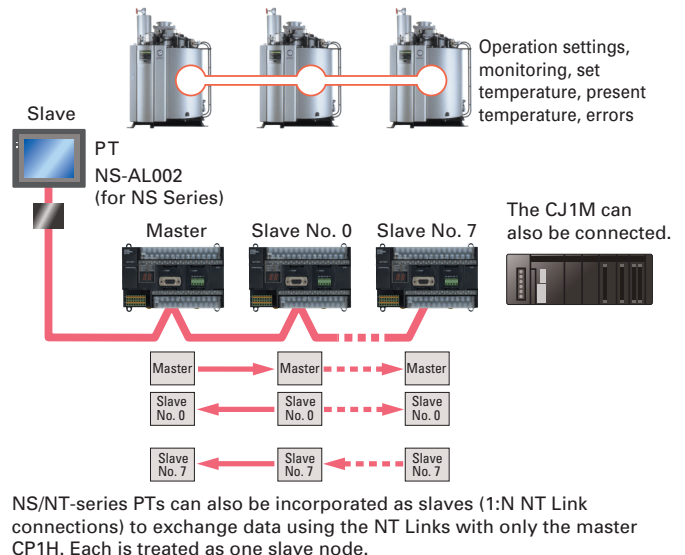

A Programming Environment That Shortens Design Time for the Ever-increasing Size and Complexity of Programs.

■ Plug-and-play USB Connection

Just install the CX-Programmer (Ver. 6.1 or higher) and connect the USB cable to the CP1H. The driver will be installed automatically to enable making a connection.

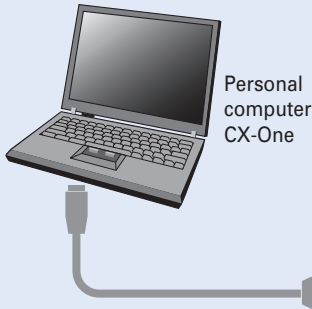

Personal computer CX-One

■ A Built-in USB Port (USB 1.1, Type B) Enables a Personal Computer to Be Connected using an Over-the-counter Cable.

Over-the-counter USB cables (A-type male to B-type male) can be used.

Costs can be reduced, even factoring in the cost of the cable.

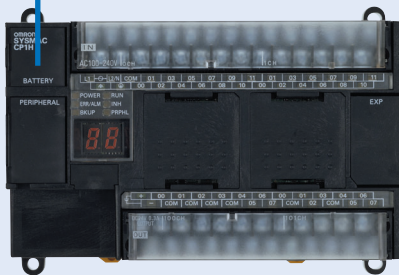

Note: Programming Consoles (e.g., CQM1H-PRO01 and C200H-PRO27) cannot be used with the CP1H.

A Wealth of Instructions

● PID Instruction with Autotuning

PID constants can be automatically tuned for the PID instruction. The limit cycle method is used for tuning, allowing tuning to be completed quickly.

● Floating-point Decimal Instructions, Trigonometric Instructions, and More.

Just like the CS/CJ-series PLCs, the CP1H has approximately 400 instructions for ladder programming.

The Structured Text (ST) Language Makes Arithmetic Operations Even Easier.

In addition to ladder programming, function block logic can be written in ST language, which conforms to IEC 61131-3. Arithmetic processing is also possible with ST, including processing of absolute values, square roots, logarithms, and trigonometric functions (SIN, COS, and TAN). Processing that is difficult to write in ladder programming becomes easy using structured text.

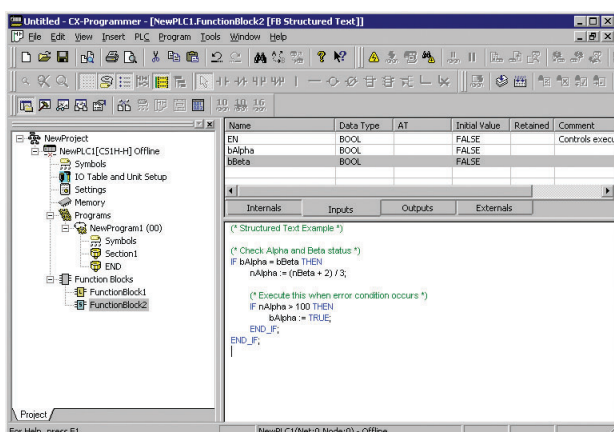

Flexible Package PLCs
CJ Series



Building-block PLCs
CS Series



Common Architecture



All-in-one Package PLCs
CP Series

Structured Text Commands (Keywords)

TRUE, FALSE.
IF, THEN, ELSE, ELSIF, END_IF.
DO, WHILE, END_WHILE.
REPEAT, UNTIL, END_REPEAT.
FOR, TO, BY, DO, END_FOR.
CASE, OF, END_CASE.
EXIT, RETURN.

Operators

Addition (+), Subtraction (-), Multiplication (*), Division (/)
Parenthesis (brackets), Array Indexing (square brackets [])
Assignment Operator (:=), Less Than Comparison Operator (<),
Less Than or Equal To Comparison Operator (<=),
Greater Than Comparison Operator (>),
Greater Than or Equal To Comparison Operator (>=),
Equals Comparison Operator (=),
Is Not Equal To Comparison Operator (<>),
Bitwise AND (AND or &), Bitwise OR (OR), Exclusive OR (XOR),
NOT (NOT), Exponentiation (**)

Numerical Functions and Arithmetic Functions

ABS, SQRT, SQR, LN, LOG, EXP, SIN, COS, TAN, ASIN, ACOS,
ATAN, EXPT

Communications Programs Are Provided by the Function Block Library.

The OMRON Function Block (FB) Library provides function blocks for setting SPs, reading PVs, and reading and writing RUN/STOP status and other Temperature Controller parameters. The programmer simply pastes function blocks from the FB Library into the ladder program. The desired functions can be utilized simply by inputting the Temperature Controller unit number and address. The ladder programs used for various communications can be created from the FB Library, thereby greatly reducing the number of working hours required for program development and debugging.

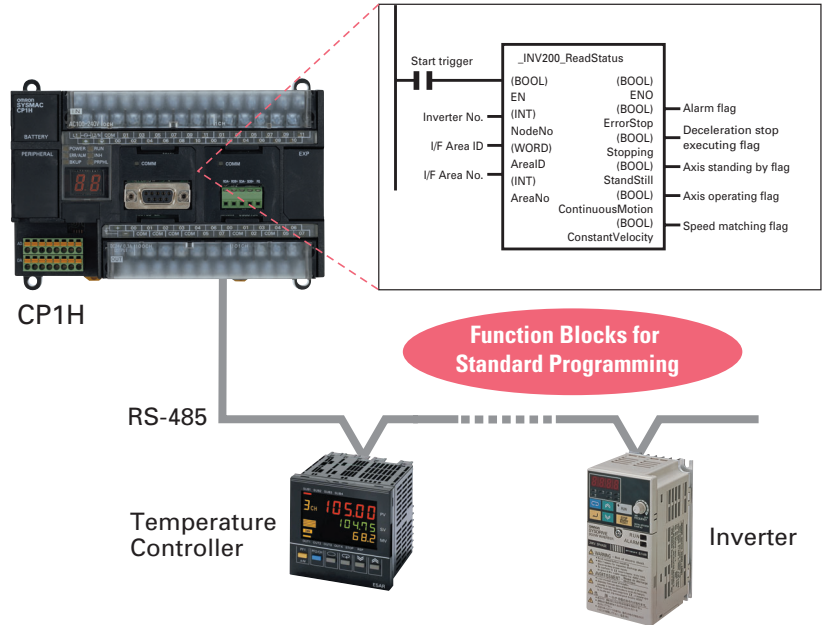

● A FB Library for Pulse Outputs.

Function blocks are also provided for pulse outputs to make it easy to write programs for positioning in addition to communications function blocks. These function blocks will reduce the time required for developing programs for applications such as for OMRON's SMARTSTEP Servo System.

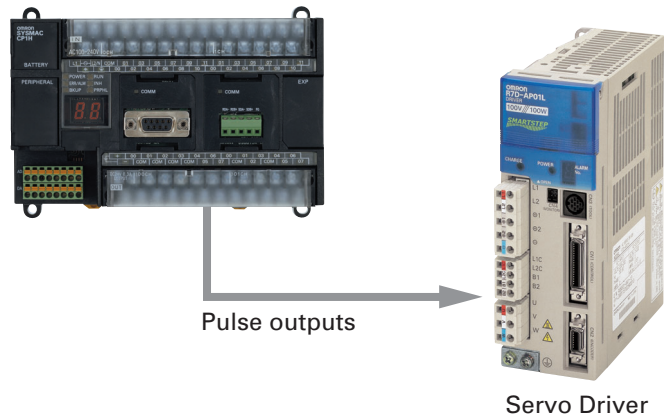

● Security

Eight-character Password Protection

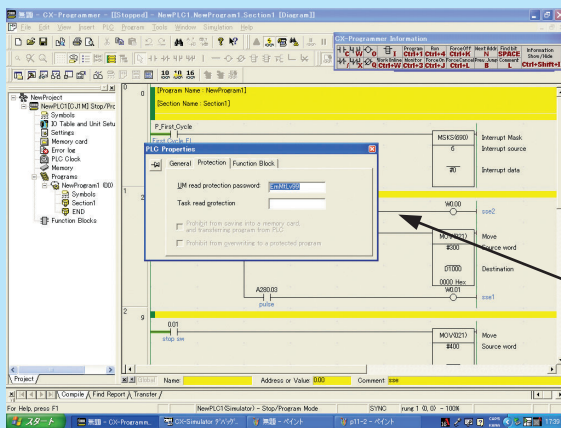

Important programs can be protected by setting a password from the CX-Programmer (with the PLC online).

Password setting: Up to 8 alphanumeric characters (A-Z, a-z, 0-9)

Advanced Settings Can Be Made with No Need for a Manual, Not Only for the PLC but Even for Special I/O Unit and CPU Bus Unit Parameters and FA Networks.

Easy-to-use Programming Software.

Programming with Function Blocks (Ladder Diagrams/ST Language) Is Also Standard.

CX-Programmer (Ver. 6.1 or Higher, but Ver. 6.2 or Higher for CP1H-X/XA CPU Units with Version 1.1 and CP1H-Y CPU Units)

Easy Operation Simplifies Programming and Debugging.

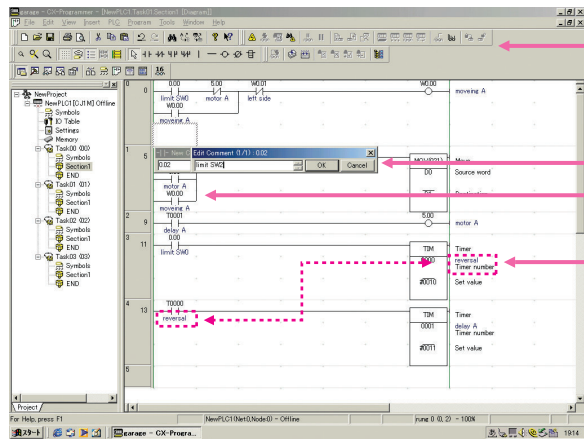

Shortcut keys can be easily checked using the ladder key guide.

Programming is simplified by key inputs, such as the **C** Key for an NC input (contact), the **O** Key for an OUT instruction, and the **I** Key for special instructions.

Key inputs are as easy as this: **C** Key, address, **↶** Key, comment, **↷** Key. The CX-Programmer automatically goes into character input mode when it is time to enter a comment. Special instructions can be input as follows:



Simple key inputs are also available to connect lines.



Comments can be added for timer and counter instructions through timer and counter input bits.

3 Cross Reference Pop-up Icon

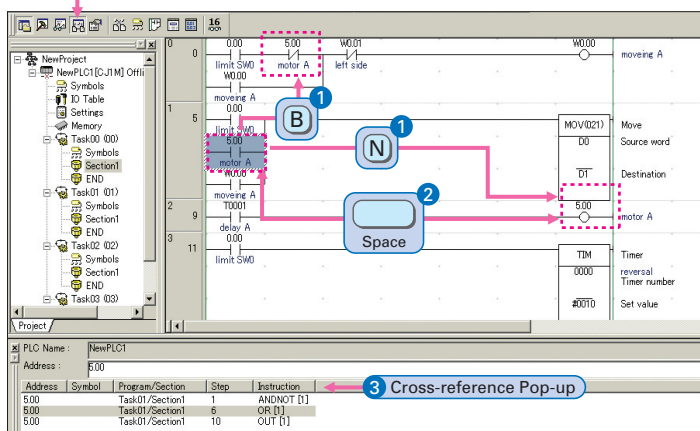

1 Consecutive Address Searches

Pressing the **N** Key (Next) jumps to the next input or output bit with the same address.

Pressing the **B** Key (Back) jumps back to the previous input or output bit with the same address.

2 Trace Searches

Space Pressing the Space Bar with the cursor at an input bit jumps to the output bit with the same address. Pressing the Space Bar with the cursor at an output bit jumps to the input bit with the same address.

3 Cross-reference Popups

Cross-reference information can be displayed for the input or output bit at the cursor to show where the address of the input or output bit is used in the program. Just click a cross-reference to jump to that location in the program.

Handle Function Blocks (FB) and Structured Text (ST) Language with Only the CX-Programmer.

Programs using function blocks and ST language can be created by reading function blocks into ordinary ladder programs.

Function Block

Programmed as a ladder diagram.

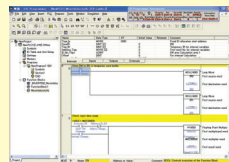

Programmed in ST Language. Standard text can be entered into function blocks.

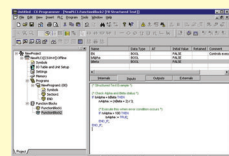

FB Library (provided with CX-Programmer)

Function Block called.

Paste the Function Block into a Ladder Program.

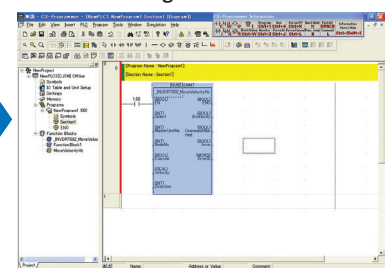

Integrating OMRON PLCs and Component Peripheral Devices.

FA Integrated Tool Package



The CX-One is an FA Integrated Tool Package for connecting, setting, and programming OMRON components including PLCs. CP1H programming and settings can be done with just the CX-Programmer alone, but CX-One is packaged with tools for setting and programming NS-series PTs, Temperature Controllers, and many other components. Using CX-One together with the CP1H makes programming and setup easy, shortening the total lead time required for starting up machines and equipment.

CX-One Configuration

CX-Integrator System Integration Software Ver. 2.0

PLC Software	CX-Programmer CX-Simulator SwitchBox Utility
Network Software	CX-Protocol CX-FLnet
HMI Software	CX-Designer <small>Ladder Monitor software included. (See note.)</small>
Motion Controller Software	CX-Motion CX-Motion-NCF CX-Motion-MCH CX-Position CX-Drive
PLC-based Process Control Software	CX-Process Tool NS-series Face Plate Auto-Builder
Component Software (for Temperature Controllers)	CX-Thermo

Note: The Ladder Monitor is required to monitor ladder programs running on CS/CJ-series PLCs from an NS-series PT.

CX-Integrator

Settings and communications for devices such as other PLCs, NS-series PTs, and Temperature Controllers that are connected to a PLC can all be executed together from the CX-One CX-Integrator connected to the PLC.

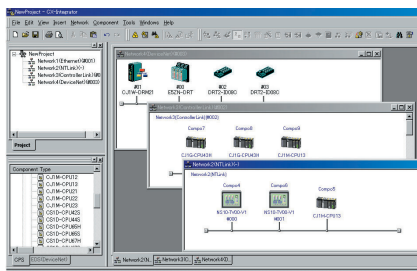

CX-Simulator

Online CP1H CPU Unit operations, such as program monitoring, I/O memory manipulation, PV monitoring, forced setting/resetting memory bits, differential monitoring, data tracing, and online editing, can be executed without the actual PLC.

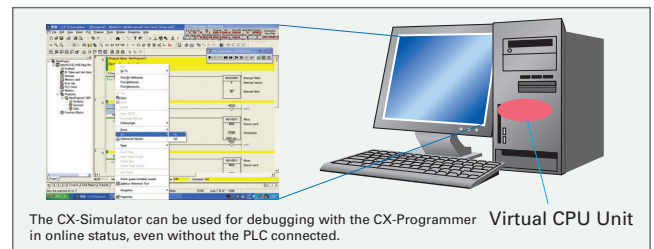

The CX-Simulator can be used for debugging with the CX-Programmer Virtual CPU Unit in online status, even without the PLC connected.

Improved Functional Connectivity with HMI Design Software and Integration of Component Software

Configured with an NS-series PT

CX-Designer

The CX-Designer can be started from the CX-Integrator's NT Link Window. It can be used to design screens such as, for example, setting screens for Temperature Controllers. In addition, the Smart Active Parts (SAP) library is provided with the CX-Designer to enable easily creating setting screens for Temperature Components or other components.

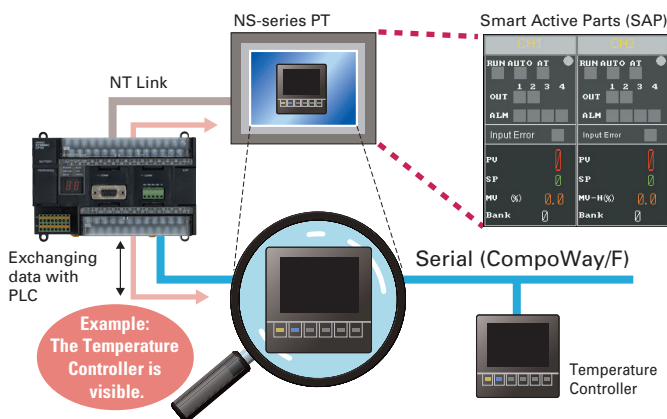

Configured with a Temperature Controller

CX-Thermo

The Support Software for Temperature Controllers (CX-Thermo) can be started from the CX-Integrator's Serial Communications Window.

The CX-Thermo Software can be started from a device in the CX-Integrator's serial communications (CompoWay/F) network.

Parameters can be created, edited, and transferred at the computer. The time required to make settings can be reduced when setting the same parameters in multiple devices.

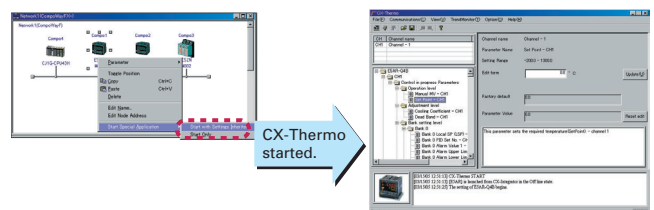

Support Software for the CP1H
CX-One: Ver. 1.1 or higher
Purchased Individually
CX-Programmer: Ver. 6.1 or higher
CX-Simulator: Ver. 1.6 or higher
CX-Protocol: Ver. 1.6.0.4 or higher

Handy Built-in Functions Make Maintenance Easier.

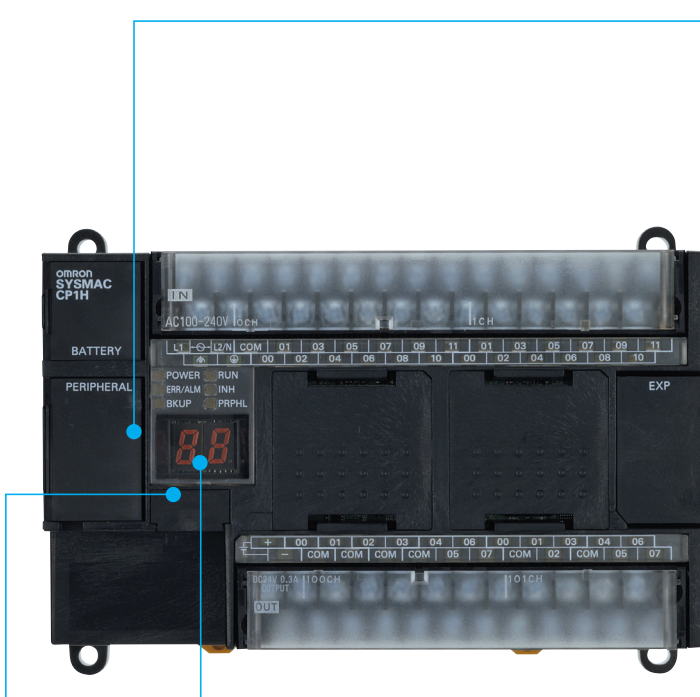

■ **Analog Inputs Are Made Simple.**
An analog adjustment and an external analog setting input connector are provided.



● **Analog Adjustment**
The analog adjustment has a resolution of 256. Values are entered in A642 and can be used in the ladder program. When the value is changed, it is displayed (0 to FF) for three seconds on the 7-segment display.

● **External Analog Setting Input Connector**

This connector has a resolution of 256 and is used for an analog input set to 0 to 10 V. Each CP1H CPU Unit has one of these connectors built in. (The built-in analog I/O for CP1H-XA CPU Units is separate.) A device, such as a potentiometer, can be connected to enable direct manual operation and control from a control panel. The maximum cable length is 3 meters. A connecting cable (1 m) is included with the CPU Unit.



■ Memory Cassette

- Data, such as programs and initial memory values, can be stored on a Memory Cassette (optional) and copied to other systems.
- The Memory Cassette can also be used when installing new versions of application programs.

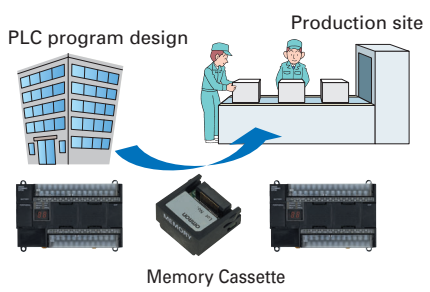

■ Status Displayed on 7-segment Display

- The 7-segment display provides two display digits.
- In addition to displaying error codes for errors detected by the PLC, codes can be displayed on the display from the ladder program.
- The 7-segment display is useful for maintenance as well, allowing problems that arise during system operation to be grasped without using any Support Software.

■ Battery-free Operation

- The values in the DM Area (32 Kwords) are saved in the CPU Unit's built-in flash memory as initial values, and can be read at startup.
- Battery-free operation is also possible when saving production data and machine parameters in the DM Area, turning OFF the power, and using then same data again for the next production run.

Example display: A memory error occurs in the UM (error code 80F1, error details 0001).

That's a memory error.

System development

- Note:**
- A battery is required for the clock function and to retain the status of HR Area bits and counter values.
 - A battery is provided as a standard feature with the CPU Unit.
 - The user program (ladder program) is stored in built-in flash memory, so no battery is required to back it up.

Flexibly Adjust the System Configuration to the Application by Adding Up to 7 CPM-series Expansion I/O Units, Expanding Functionality, and Connecting to Networks.

CJ-series Special I/O Units and CPU Bus Units Can Be Connected to Meet Current Needs or to Expand the System in the Future.

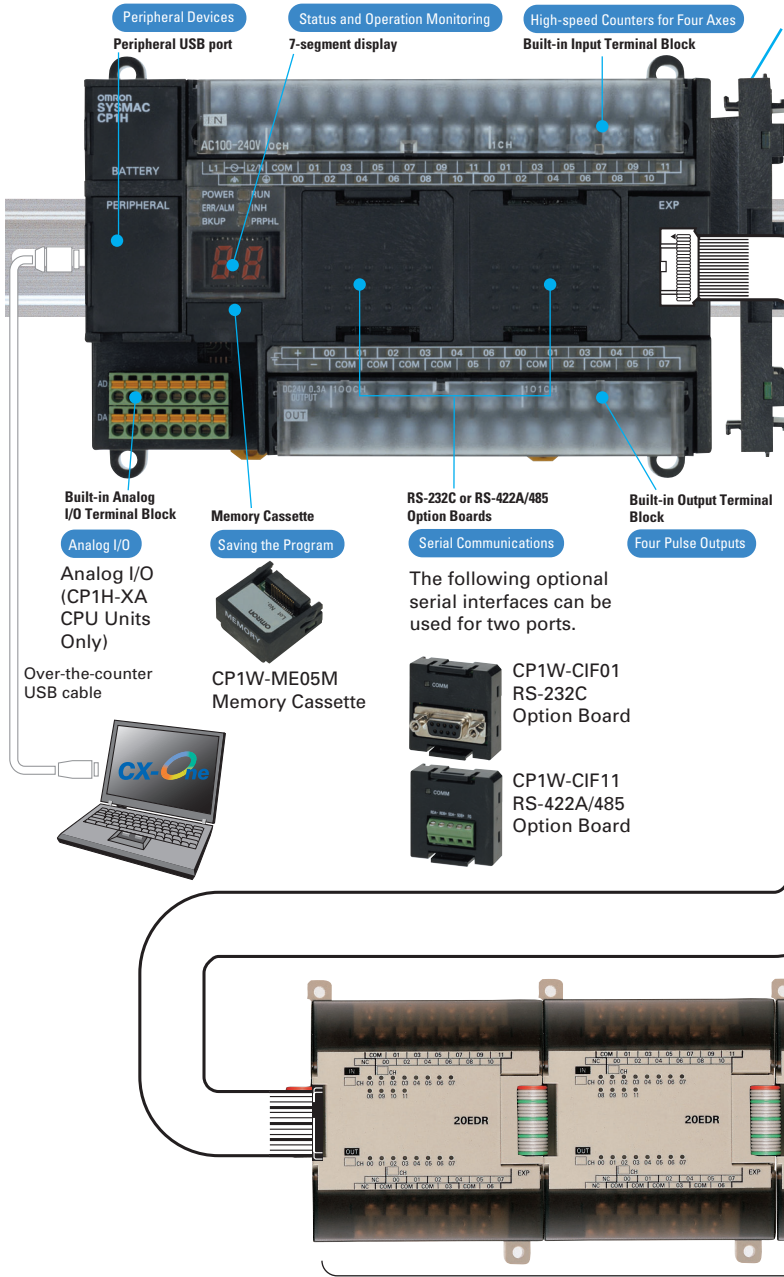

A maximum of two CJ-series Special I/O Units or CPU Bus Units can be connected. (For details on Units that can be connected, refer to page 16.)

Communications Expansion to Higher and Lower Network Layers, System Expansion, and Information Management Are Made Easy.

Use a CP1W-CN811 I/O Connecting Cable when using CPM1A Expansion I/O Units with a CJ Unit Adapter.

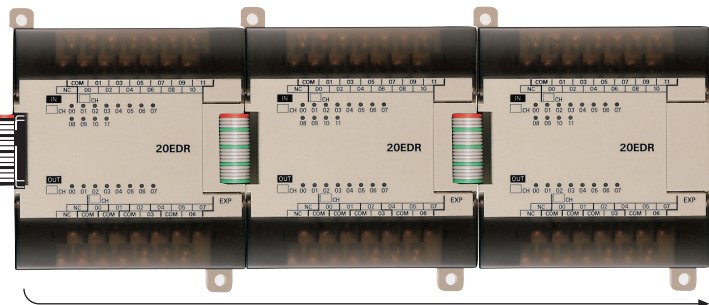

Up to 320 I/O points can be obtained by connecting seven Expansion I/O Units.

Only one I/O Connecting Cable can be used. **7 Units max.**

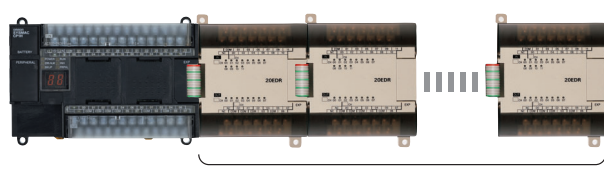

A maximum of seven CPM1A Expansion I/O Units can be connected. For details on Unit restrictions, refer to page 16.

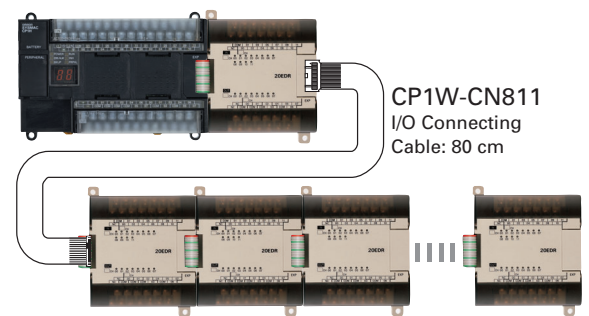

Expansion I/O Units can also be wired below by using CP1W-CN811 I/O Connecting Cable.

An Complete CPU Unit Lineup Lets You Select the Optimum Unit for Your Applications.

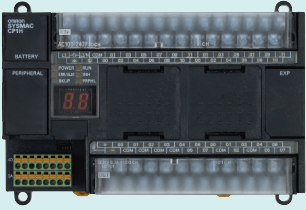
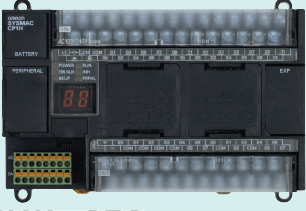
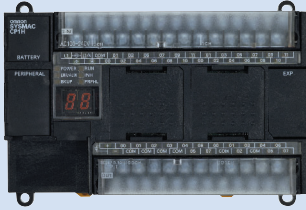
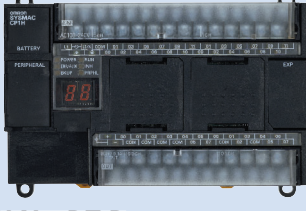
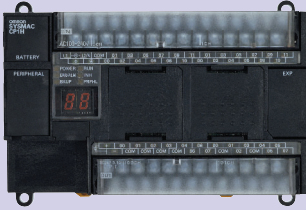
CP1H-XA40D□-□ (CP1H-XA CPU Units) Built-in Analog I/O	CP1H-X40D□-□ (CP1H-X CPU Units) Basic Model	CP1H-Y20D□-□ (CP1H-Y CPU Units) High-speed Positioning (To be released soon.)
 <p>CP1H-XA40DR-A AC power supply, 24 DC inputs, 16 relay outputs, 4 analog inputs, 2 analog outputs</p>  <p>CP1H-XA40DT-D DC power supply, 24 DC inputs, 16 transistor (sinking) outputs, 4 analog inputs, 2 analog outputs</p> <p>CP1H-XA40DT1-D DC power supply, 24 DC inputs, 16 transistor (sourcing) outputs, 4 analog inputs, 2 analog outputs</p>	 <p>CP1H-X40DR-A AC power supply, 24 DC inputs, 16 relay outputs</p>  <p>CP1H-X40DT-D DC power supply, 24 DC inputs, 16 transistor (sinking) outputs</p> <p>CP1H-X40DT1-D DC power supply, 24 DC inputs, 16 transistor (sourcing) outputs</p>	 <p>CP1H-Y20DT-D DC power supply, 12 DC inputs, 8 transistor (sinking) outputs</p> <p>Two 1-MHz line-driver inputs (phases A, B, and Z) and two 1-MHz line-driver outputs (CW and CCW) are provided separately.</p>



	CP1H-XA CPU Units	CP1H-X CPU Units	CP1H-Y CPU Unit
I/O capacity	24 inputs, 16 outputs		12 inputs, 8 outputs Line-driver inputs: Phases A, B, and Z for 2 axes Line-driver outputs: CW and CCW for 2 axes
High-speed counter	100 kHz (single-phase), 50 kHz (differential phases), 4 axes		1 MHz (single-phase), 500 kHz (differential phases) for 2 axes (line-driver input), 100 kHz (single-phase), 50 kHz (differential phases) for 2 axes (4 axes total)
Pulse output function (Models with Transistor Outputs only)	100 kHz for 4 axes		1 MHz for 2 axes (line-driver output), 100 kHz for 2 axes (4 axes total)
Serial communications	USB port (peripheral port) and 2 optional serial ports (either RS-232C or RS-422A/485 Option Boards)		
Analog I/O	4 analog inputs and 2 analog outputs	—	—
Interrupt inputs Quick-response inputs (50-ms width min.)	8 inputs		6 inputs
User program capacity	20 ks		
DM capacity	32 kw		
Maximum number of CPM1A Expansion I/O Units	7 (Refer to page16 for Unit restrictions.)		
Maximum number of CJ-series Units	2 (CJ-series Special I/O Units and CPU Bus Units only. Refer to page16 for information on Units that can be used.)		

● Options



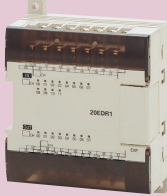

CPM-series Expansion I/O Can Be Used without Alteration for Easy System Expansion.

● Expansion I/O Units

 <p>CPM1A-8ED</p> <ul style="list-style-type: none"> ● Input points: 8 ● DC input 	 <p>CPM1A-20EDR1</p> <ul style="list-style-type: none"> ● Input points: 12 DC inputs ● Output points: 8 relay outputs 	 <p>CPM1A-40EDR</p> <ul style="list-style-type: none"> ● Input points: 24 DC inputs ● Output points: 16 relay outputs
<p>CPM1A-8ER</p> <ul style="list-style-type: none"> ● Output points: 8 ● Relay output 	<p>CPM1A-20EDT</p> <ul style="list-style-type: none"> ● Input points: 12 DC inputs ● Output points: 8, transistor outputs (sinking) 	<p>CPM1A-40EDT</p> <ul style="list-style-type: none"> ● Input points: 24 DC inputs ● Output points: 16 relay outputs
<p>CPM1A-8ET</p> <ul style="list-style-type: none"> ● Output points: 8 ● Transistor output (sinking) 	<p>CPM1A-20EDT1</p> <ul style="list-style-type: none"> ● Input points: 12 DC inputs ● Output points: 8, transistor outputs (sourcing) 	<p>CPM1A-40EDT</p> <ul style="list-style-type: none"> ● Input points: 24 DC inputs ● Output points: 16 transistor outputs (sinking)
<p>CPM1A-8ET1</p> <ul style="list-style-type: none"> ● Output points: 8 ● Transistor output (sourcing) 	<p>CPM1A-20EDT1</p> <ul style="list-style-type: none"> ● Input points: 12 DC inputs ● Output points: 8, transistor outputs (sourcing) 	<p>CPM1A-40EDT1</p> <ul style="list-style-type: none"> ● Input points: 24 DC inputs ● Output points: 16 transistor outputs (sourcing)

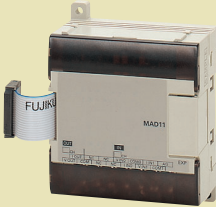
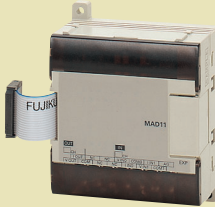
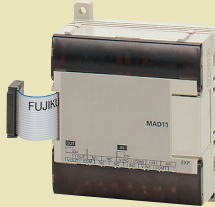
● Analog Units

 <p>Analog Input Unit CPM1A-AD041</p> <ul style="list-style-type: none"> ● Analog inputs: 4 (resolution: 6,000) 	 <p>Analog Output Unit CPM1A-DA041</p> <ul style="list-style-type: none"> ● Analog outputs: 4 (resolution: 6,000) 	 <p>Analog I/O Unit CPM1A-MAD11</p> <ul style="list-style-type: none"> ● Analog inputs: 2 (resolution: 6,000) ● Analog outputs: 1 (resolution: 6,000) 	 <p>Analog I/O Unit CPM1A-MAD01</p> <ul style="list-style-type: none"> ● Analog inputs: 2 (resolution: 256) ● Analog outputs: 1 (resolution: 256)
---	---	---	--

● Temperature Sensor Units

 <p>Temperature Sensor Unit CPM1A-TS001</p> <ul style="list-style-type: none"> ● Thermocouple inputs: 2 	<p>Temperature Sensor Unit CPM1A-TS101</p> <ul style="list-style-type: none"> ● Platinum resistance thermometer inputs: 2
<p>CPM1A-TS002</p> <ul style="list-style-type: none"> ● Thermocouple inputs: 4 	<p>CPM1A-TS102</p> <ul style="list-style-type: none"> ● Platinum resistance thermometer inputs: 4

● CompoBus/S I/O Link Unit

	<p>CompoBus/S I/O Link Unit CPM1A-SRT21</p> <ul style="list-style-type: none"> ● Input points: 8 ● Output points: 8
---	--

● I/O Connecting Cable

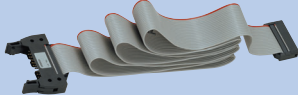
	<p>I/O Connecting Cable 80 cm CP1W-CN811</p>
---	---

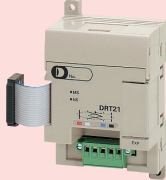

Note: An I/O Connecting Cable (approx. 6 cm) to connect the CPM1A Expansion Unit horizontally is included.

● DeviceNet I/O Link Unit

	<p>DeviceNet I/O Link Unit CPM1A-DRT21</p> <ul style="list-style-type: none"> ● Input points: 32 ● Output points: 32
---	---

● CJ-series Special I/O Units and CPU Bus Units

Two CJ-series Special I/O Units or CPU Bus Units can be connected by using a CJ Unit Adapter. (For details on Units that can be used, refer to page16.)

 <p>CJ Unit Adapter CP1W-EXT01</p>	<p>CJ-series Special I/O Units</p> <p>Analog Input Unit CJ1W-AD□□□-V1</p> <p>Analog Output Unit CJ1W-DA□□□</p> <p>Analog I/O Unit CJ1W-MAD42</p> <p>Process Input Unit CJ1W-PTS□□</p> <p>CJ1W-PDC15</p> <p>Temperature Control Unit CJ1W-TC□□□</p> <p>CompoBus/S Master Unit CJ1W-SRM21</p> <p>Position Control Units CJ1W-NC□□□</p> <p>High-speed Counter Units CJ1W-CT021</p> <p>ID Sensor Units CJ1W-V600C1□</p>	 <p>CJ-series CPU Bus Units</p> <p>Ethernet Unit CJ1W-ETN21</p> <p>Controller Link Unit CJ1W-CLK21-V1</p> <p>Serial Communications Unit CJ1W-SCU□□-V1</p> <p>DeviceNet Unit CJ1W-DRM21</p> <p>MECHATROLINK-II Position Control Unit CJ1W-NCF71</p> <p>MECHATROLINK-II Motion Control Unit CJ1W-MCH71</p> <p>FL-net Unit CJ1W-FLN22</p> <p>Storage/Processing Unit CJ1W-SPU01</p>
--	--	--

Maximum Number of Expansion Units That Can Be Connected

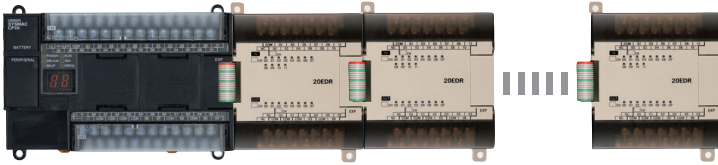

A maximum of seven CPM1A Expansion I/O Units can be connected, but the following restrictions apply.

$$7 \text{ Units} \geq \text{Number of Group A Units} + \text{Number of Group B Units} \times 2$$

Group A Units Counted in the Seven Connectable Units

Unit type	Model	
Expansion I/O Units	40 I/O points	CPM1A-40EDR
		CPM1A-40EDT
		CPM1A-40EDT1
	20 I/O points	CPM1A-20EDR1
		CPM1A-20EDT
		CPM1A-20EDT1
	8 inputs	CPM1A-8ED
	8 outputs	CPM1A-8ER
		CPM1A-8ET
CPM1A-8ET1		
Analog Unit	2 analog inputs, 1 analog output	CPM1A-MAD01
		CPM1A-MAD11
Temperature Sensor Units	2 thermocouple inputs	CPM1A-TS001
	2 platinum resistance thermometer inputs	CPM1A-TS101
CompoBus/S I/O Link Unit	8 inputs, 8 outputs	CPM1A-SRT21
DeviceNet I/O Link Unit	32 inputs, 32 outputs	CPM1A-DRT21

Group B Units that Each Count as Two of the Seven Connectable Units

Unit type	Model	
Analog Units	4 analog inputs	CPM1A-AD041
	4 analog outputs	CPM1A-DA041
Temperature Sensor Units	4 thermocouple inputs	CPM1A-TS002
	4 platinum resistance thermometer inputs	CPM1A-TS102

For example, if only Group B Units are used, a maximum of three Units can be connected. It would then be possible to additionally connect one Group A Unit and two CJ-series Special I/O Units or CPU Bus Units.

● CJ-series Special I/O Units and CPU Bus Units

A maximum of two CJ-series Special I/O Units or CPU Bus Units can be connected by using a CP1W-EXT01 CJ Unit Adapter. The number of Units that can be used with the CP1H is as described below.

Use CP1W-CN811 I/O Connecting Cable when using CPM1A Expansion I/O Units at the same time as a CJ Unit Adapter. In this situation the number of CPM1A Expansion I/O Units that can be connected is subject to the restrictions described above.

■ CJ-series Special I/O Units

Unit name	Model
Analog Input Units	CJ1W-AD081-V1
	CJ1W-AD041-V1
Analog Output Units	CJ1W-DA08V
	CJ1W-DA08C
	CJ1W-DA041
	CJ1W-DA021
Analog I/O Unit	CJ1W-MAD42
Process Input Units	CJ1W-PTS51
	CJ1W-PTS52
	CJ1W-PTS15
	CJ1W-PTS16
	CJ1W-PDC15

Unit name	Model	
Temperature Control Units	CJ1W-TC001	
	CJ1W-TC002	
	CJ1W-TC003	
	CJ1W-TC004	
	CJ1W-TC101	
	CJ1W-TC102	
	CJ1W-TC103	
	CJ1W-TC104	
	CompoBus/S Master Unit	CJ1W-SRM21
	Position Control Units	CJ1W-NC113
CJ1W-NC213		
CJ1W-NC413		
CJ1W-NC233		
CJ1W-NC433		
High-speed Counter Unit	CJ1W-CT021	
ID Sensor Units	CJ1W-V600C11	
	CJ1W-V600C12	

■ CJ-series CPU Bus Units

Unit name	Model
Serial Communications Units	CJ1W-SCU41-V1
	CJ1W-SCU21-V1
Ethernet Unit	CJ1W-ETN21
DeviceNet Unit	CJ1W-DRM21
Controller Link Unit	CJ1W-CLK21-V1
MECHATROLINK-II Position Control Unit	CJ1W-NCF71
MECHATROLINK-II Motion Control Unit	CJ1W-MCH71
FL-net Unit	CJ1W-FLN22
Storage/Processing Unit	CJ1W-SPU01

Precautions when Using CP1W-CN811 I/O Connecting Cable

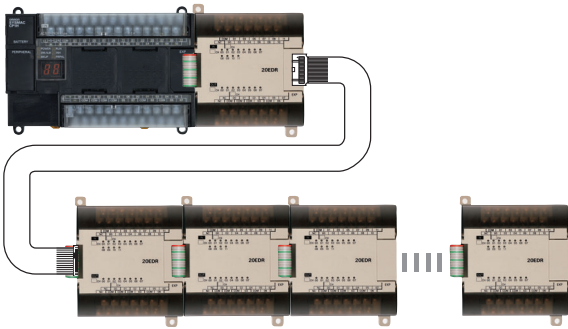

- I/O Connecting Cable can be used only between the CPU Unit and the fourth Expansion I/O Unit.
- Only one I/O Connecting Cable can be used in a single configuration.
- Even when I/O Connecting Cable is used, the above restrictions on the number of connectable CPM1A Expansion I/O Units still apply.

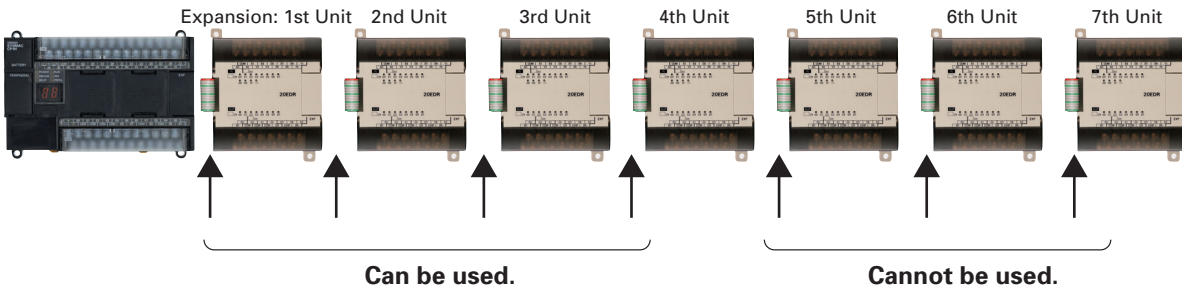

Specifications

■ CPU Unit Specifications



Item	AC power supply models: CP1H-□□□-A	DC power supply models: CP1H-□□□-D
Power supply	100 to 240 VAC 50/60 Hz	24 VDC
Operating voltage range	85 to 264 VAC	20.4 to 26.4 VDC (21.6 to 26.4 VDC with four or more Expansion Units.)
Power consumption	100 VA max.	50 W max.
Inrush current	100 to 120 VAC inputs: 20 A max. 8 ms max./200 to 240 VAC inputs: 40 A max. 8 ms max.	30 A max. 20 ms max.
External power supply	300 mA at 24 VDC	None
Insulation resistance	20 MW min. (at 500 VDC) between the external AC terminals and GR terminals	20 MW min. (at 500 VDC) between the external DC terminals and GR terminals
Dielectric strength	2,300 VAC at 50/60 Hz for 1 min between the external AC and GR terminals, leakage current: 5 mA max.	1,000 VAC at 50/60 Hz for 1 min between the external DC and GR terminals, leakage current: 5 mA max.
Noise immunity	Conforming to IEC 61000-4-4. 2 kV (power supply line)	
Vibration resistance	10 to 57 Hz, 0.075-mm amplitude, 57 to 150 Hz, acceleration: 9.8 m/s ² in X, Y, and Z directions for 80 minutes each (Sweep time: 8 minutes x 10 sweeps = total time 80 minutes)	
Shock resistance	147 m/s ² , three times each in X, Y, and Z directions	
Ambient operating temperature	0 to 55°C	
Ambient humidity	10% to 90% (with no condensation)	
Ambient operating environment	No corrosive gas	
Ambient storage temperature	-20 to 75°C (Excluding battery.)	
Power holding time	10 ms min.	2 ms min.
Dimensions	150 x 90 x 85 mm (W x H x D)	
Weight	740 g max.	590 g max.

Item	XA CPU Units: CP1H-XA□□□-□	X CPU Units: CP1H-X□□□-□	Y CPU Units: CP1H-Y□□□-□
Control method	Stored program method		
I/O control method	Cyclic scan with immediate refreshing		
Program language	Ladder diagram		
Function blocks	Maximum number of function block definitions: 128 Maximum number of instances: 256 Languages usable in function block definitions: Ladder diagrams, structured text (ST)		
Instruction length	1 to 7 steps per instruction		
Instructions	Approx. 400 (function codes: 3 digits)		
Instruction execution time	Basic instructions: 0.10 μs min. Special instructions: 0.15 μs min.		
Common processing time	0.7 ms		
Program capacity	20 Ksteps		
Number of tasks	288 (32 cyclic tasks and 256 interrupt tasks) Scheduled interrupt tasks: 1 (interrupt task No. 2, fixed) Input interrupt tasks: 8 (interrupt task No. 140 to 147, fixed), 6 for Y CPU Units High-speed counter interrupt tasks: 256 (interrupt task No. 0 to 255)		
Maximum subroutine number	256		
Maximum jump number	256		
I/O areas (See note.)	Input bits	1,600 bits (100 words): CIO 0.00 to CIO 99.15 (The 24 built-in inputs are allocated in CIO 0.00 to CIO 0.11 and CIO 1.00 to CIO 1.11.)	
	Output bits	1,600 bits (100 words): CIO 100.00 to CIO 199.15 (The 16 built-in outputs are allocated in CIO 100.00 to CIO 100.07 and CIO 101.00 to CIO 101.07.)	
	Built-in Analog Inputs	CIO 200 to CIO 203	—
	Built-in Analog Outputs	CIO 210 to CIO 211	—
	Serial PLC Link Area	1,440 bits (90 words): CIO 3100.00 to CIO 3189.15 (CIO 3100 to CIO 3189)	
Work bits	8,192 bits (512 words): W000.00 to W511.15 (W0 to W511) 37,504 bits (2,344 words): CIO 3800.00 to CIO 6143.15 (CIO 3800 to CIO 6143)		
TR Area	16 bits: TR0 to TR15		
Holding Area	8,192 bits (512 words): H0.00 to H511.15 (H0 to H511)		
AR Area	Read-only (Write-prohibited): 7168 bits (448 words): A0.00 to A447.15 (A0 to A447) Read/Write: 8192 bits (512 words): A448.00 to A959.15 (A448 to A959)		
Timers	4,096 bits: T0 to T4095		
Counters	4,096 bits: C0 to C4095		
DM Area (See note.)	32 Kwords: D0 to D32767		
Data Register Area	16 registers (16 bits): DR0 to DR15		
Index Register Area	6 registers (16 bits): IR0 to IR15		
Task Flag Area	32 flags (32 bits): TK0000 to TK0031		
Trace Memory	4,000 words (500 samples for the trace data maximum of 31 bits and 6 words.)		
Memory Cassette	A special Memory Cassette (CP1W-ME05M) can be mounted. Note: Can be used for program backups and auto-booting.		
Clock function	Supported. Accuracy (monthly deviation): -3.5 min to -0.5 min (ambient temperature: 55°C), -1.5 min to +1.5 min (ambient temperature: 25°C), -3 min to +1 min (ambient temperature: 0°C)		
Communications functions	One built-in peripheral port (USB1.1): For connecting Support Software only. A maximum of two Serial Communications Option Boards can be mounted.		
Memory backup	Flash memory: User programs, parameters (such as the PLC Setup), comment data, and the entire DM Area can be saved to flash memory as initial values. Battery backup: The Holding Area, DM Area, and counter values (flags, PV) are backed up by a battery.		
Battery service life	5 years at 25°C. (Use the replacement battery within two years of manufacture.)		

Note: The memory areas for CJ-series Special I/O Units and CPU Bus Units are allocated the same as for the CJ Series. For details, refer to the CJ Series catalog (Cat. No. P052).

Item	XA CPU Units: CP1H-XA□□□-□	X CPU Units: CP1H-X□□□-□	CY CPU Units: CP1H-Y□□□-□
Built-in input terminals	40 (24 inputs, 16 outputs)		20 (12 inputs, 8 outputs) Line-driver inputs: Two axes for phases A, B, and Z Line-driver outputs: Two axes for CW and CCW
Number of connectable Expansion (I/O) Units	CPM1A Expansion I/O Units: 7 max.; CJ-series Special I/O Units or CPU Bus Units: 2 max.		
Max. number of I/O points	320 (40 built in + 40 per Expansion (I/O) Unit x 7 Units)		300 (20 built in + 40 per Expansion (I/O) Unit x 7 Units)
Interrupt inputs	8 inputs (Shared by the external interrupt inputs (counter mode) and the quick-response inputs.)		6 inputs (Shared by the external interrupt inputs (counter mode) and the quick-response inputs.)
Interrupt inputs counter mode	8 inputs (Response frequency: 5 kHz max. for all interrupt inputs), 16 bits		6 inputs (Response frequency: 5 kHz max. for all interrupt inputs), 16 bits
Quick-response inputs	8 points (Min. input pulse width: 50 μs max.)		6 points (Min. input pulse width: 50 μs max.)
Scheduled interrupts	1		
High-speed counters	4 inputs: Differential phases (4x), 50 kHz or Single-phase (pulse plus direction, up/down, increment), 100 kHz Value range: 32 bits, Linear mode or ring mode Interrupts: Target value comparison or range comparison		2 inputs: Differential phases (4x), 500 kHz or Single-phase, 1 MHz and 2 inputs: Differential phases (4x), 50 kHz or Single-phase (pulse plus direction, up/down, increment), 100 kHz Value range: 32 bits, Linear mode or ring mode Interrupts: Target value comparison or range comparison
Pulse outputs (models with transistor outputs only)	Trapezoidal or S-curve acceleration and deceleration (Duty ratio: 50% fixed) 4 outputs, 1 Hz to 100 kHz (CCW/CW or pulse plus direction) PWM outputs: (Duty ratio: 0.0% to 100.0% (Unit: 0.1%)) 2 outputs, 0.1 to 1 kHz (Accuracy: ±5% at 1 kHz)		Trapezoidal or S-curve acceleration and deceleration (Duty ratio: 50% fixed) 2 outputs, 1 Hz to 1 MHz (CCW/CW or pulse plus direction) 2 outputs, 1 Hz to 100 kHz (CCW/CW or pulse plus direction) PWM outputs: (Duty ratio: 0.0% to 100.0% (Unit: 0.1%)) 2 outputs, 0.1 to 1 kHz (Accuracy: ±5% at 1 kHz)
Built-in analog I/O terminals	4 analog inputs and 2 analog outputs (Refer to separate detailed specifications.)	None	
Analog control	1 (Setting range: 0 to 255)		
External analog input	1 input (Resolution: 1/256, Input range: 0 to 10 V)		

Serial Communications Specifications

Item	Function	Interface
Peripheral USB port	For connecting Peripheral Device.	Conforms to USB 1.1, B-type connector
Serial port 1	Host Link, No-protocol, NT Link (1: N), Serial PLC Link (See note.), Serial Gateway (CompoWay/F master, Modbus-RTU master), Modbus-RTU easy master function	The CP1W-CIF01 RS-232C Option Board 
Serial port 2	Host Link, No-protocol, NT Link (1: N), Serial PLC Link (See note.), Serial Gateway (CompoWay/F master, Modbus-RTU master), Modbus-RTU easy master function	or the CP1W-CIF11 RS-422A/485 Option Board  can be used with either port.

Note: Serial PLC Link can be used with either serial port 1 or serial port 2.

Analog I/O Specifications (CP1H-XA CPU Units Only)

Item	Voltage I/O	Current I/O	
Analog Input Section	Number of analog inputs	4	
	Input signal range	0 to 5 V, 1 to 5 V, 0 to 10 V, or -10 to 10 V	0 to 20 mA or 4 to 20 mA
	Max. rated input	±15 V	±30 mA
	External input impedance	1 MΩ min.	Approx. 250 Ω
	Resolution	1/6,000 or 1/12,000 (full scale)	
	Overall accuracy	25°C: ±0.3% full scale/0 to 55°C: ±0.6% full scale	25°C: ±0.4% full scale/0 to 55°C: ±0.8% full scale
	A/D conversion data	Full scale for -10 to 10 V: F448 (E890) to 0BB8 (1770) Hex Full scale for other ranges: 0000 to 1770 (2EE0) Hex	
	Averaging	Supported (Set for individual inputs in the PLC Setup.)	
	Open-circuit detection	Supported (Value when disconnected: 8000 Hex)	
Analog Output Section	Number of outputs	2 outputs	
	Output signal range	0 to 5 V, 1 to 5 V, 0 to 10 V, or -10 to 10 V	0 to 20 mA or 4 to 20 mA
	Allowable external output load resistance	1 kΩ min.	600 Ω max.
	External output impedance	0.5 Ω max.	—
	Resolution	1/6,000 or 1/12,000 (full scale)	
	Overall accuracy	25°C: ±0.4% full scale/0 to 55°C: ±0.8% full scale	
	D/A conversion data	Full scale for -10 to 10 V: F448 (E890) to 0BB8 (1770) hex Full scale for other ranges: 0000 to 1770 (2EE0) hex	
Conversion time	1 ms/point		
Isolation method	Photocoupler isolation between analog I/O terminals and internal circuits. No isolation between analog I/O signals.		

I/O Specifications

Built-in Input Area

■ XA and X CPU Units

PLC Setup	Input operation			High-speed counter operation	Pulse output origin search function set to be used.	
	Normal inputs	Interrupt inputs	Quick-response inputs	High-speed counters	Origin search	
CIO 0	00	Normal input 0	Interrupt input 0	Quick-response input 0		Pulse 0: Origin input signal
	01	Normal input 1	Interrupt input 1	Quick-response input 1	High-speed counter 2 (phase-Z/reset)	Pulse 0: Origin proximity input signal
	02	Normal input 2	Interrupt input 2	Quick-response input 2	High-speed counter 1 (phase-Z/reset)	Pulse output 1: Origin input signal
	03	Normal input 3	Interrupt input 3	Quick-response input 3	High-speed counter 0 (phase-Z/reset)	Pulse output 1: Origin proximity input signal
	04	Normal input 4			High-speed counter 2 (phase-A, increment, or count input)	
	05	Normal input 5			High-speed counter 2 (phase-B, decrement, or direction input)	
	06	Normal input 6			High-speed counter 1 (phase-A, increment, or count input)	
	07	Normal input 7			High-speed counter 1 (phase-B, decrement, or direction input)	
	08	Normal input 8			High-speed counter 0 (phase-A, increment, or count input)	
	09	Normal input 9			High-speed counter 0 (phase-B, decrement, or direction input)	
	10	Normal input 10			High-speed counter 3 (phase-A, increment, or count input)	
	11	Normal output 11			High-speed counter 3 (phase-B, decrement, or direction input)	
CIO 1	00	Normal input 12	Interrupt input 4	Quick-response input 4	High-speed counter 3 (phase-Z/reset)	Pulse output 2: Origin input signal
	01	Normal input 13	Interrupt input 5	Quick-response input 5		Pulse output 2: Origin proximity input signal
	02	Normal input 14	Interrupt input 6	Quick-response input 6		Pulse output 3: Origin input signal
	03	Normal input 15	Interrupt input 7	Quick-response input 7		Pulse output 3: Origin proximity input signal
	04	Normal input 16				
	05	Normal input 17				
	06	Normal input 18				
	07	Normal input 19				
	08	Normal input 20				
	09	Normal input 21				
	10	Normal input 22				
	11	Normal input 23				

■ Y CPU Units

PLC Setup	Input operation setting			High-speed counter operation setting	Pulse output origin search function set to be used.	
	Normal inputs	Interrupt inputs	Quick-response inputs	High-speed counters	Origin search	
A0				High-speed counter 0 (phase-A, increment, or count input) fixed		
B0				High-speed counter 0 (phase-B, decrement, or direction input) fixed		
Z0				High-speed counter 0 (phase-Z/reset) fixed	Pulse 0: Origin input signal (line driver)	
A1				High-speed counter 1 (phase-A, increment, or count input) fixed		
B1				High-speed counter 1 (phase-B, decrement, or direction input) fixed		
Z1				High-speed counter 1 (phase-Z/reset) fixed	Pulse 1: Origin input signal (line driver)	
CIO 0	Bit 00	Normal input 0	Interrupt 0	Quick-response input 0		Pulse 2: Origin proximity input signal
	Bit 01	Normal input 1	Interrupt 1	Quick-response input 1	High-speed counter 2 (phase-Z/reset)	
	Bit 04	Normal input 2			High-speed counter 2 (phase-A, increment, or count input)	
	Bit 05	Normal input 3			High-speed counter 2 (phase-B, decrement, or direction input)	
	Bit 10	Normal input 4			High-speed counter 3 (phase-A, increment, or count input)	
	Bit 11	Normal input 5			High-speed counter 2 (phase-B, decrement, or direction input)	Pulse 3: Origin proximity input signal
CIO 1	Bit 00	Normal input 6	Interrupt 2	Quick-response input 2	High-speed counter 2 (phase-Z/reset)	Pulse 3: Origin input signal
	Bit 01	Normal input 7	Interrupt 3	Quick-response input 3		Pulse 2: Origin input signal
	Bit 02	Normal input 8	Interrupt 4	Quick-response input 4		Pulse 1: Origin input signal (open collector)
	Bit 03	Normal input 9	Interrupt 5	Quick-response input 5		Pulse 0: Origin input signal (open collector)
	Bit 04	Normal input 10				Pulse 1: Origin proximity input signal
	Bit 05	Normal input 11				Pulse 0: Origin proximity input signal

These areas are for line-driver inputs, so they can be used only for high-speed counters (1 MHz) and not for other purposes, such as normal inputs.

Built-in Output Area

■ XA and X CPU Units

Instructions/ PLC Setup		When the instructions to the right are not executed Normal output	When a pulse output instruction (SPED, ACC, PLS2, or ORG) is executed		When the origin search function is set to be used in the PLC Setup, and an origin search is executed by the ORG instruction	When the PWM instruction is executed	
			Fixed duty ratio pulse output			When the origin search function is used	Variable duty ratio pulse output PWM output
			CW/CCW	Pulse plus direction			
CIO 100	00	Normal output 0	Pulse output 0 (CW)	Pulse output 0 (pulse)			
	01	Normal output 1	Pulse output 0 (CCW)	Pulse output 1 (pulse)			
	02	Normal output 2	Pulse output 1 (CW)	Pulse output 0 (direction)			
	03	Normal output 3	Pulse output 1 (CCW)	Pulse output 1 (direction)			
	04	Normal output 4	Pulse output 2 (CW)	Pulse output 2 (pulse)			
	05	Normal output 5	Pulse output 2 (CCW)	Pulse output 2 (direction)			
	06	Normal output 6	Pulse output 3 (CW)	Pulse output 3 (pulse)			
CIO 101	00	Normal output 7	Pulse output 3 (CCW)	Pulse output 3 (direction)			
	00	Normal output 8				PWM output 0	
	01	Normal output 9				PWM output 1	
	02	Normal output 10			Origin search 0 (Error counter reset output)		
	03	Normal output 11			Origin search 1 (Error counter reset output)		
	04	Normal output 12			Origin search 2 (Error counter reset output)		
	05	Normal output 13			Origin search 3 (Error counter reset output)		
	06	Normal output 14					
	07	Normal output 15					

■ Y CPU Units

PLC Setup		When the instructions to the right are not executed Normal output	When a pulse output instruction (SPED, ACC, PLS2, or ORG) is executed		When the origin search function is set to be used in the PLC Setup, and an origin search is executed by the ORG instruction	When the PWM instruction is executed	
			Fixed duty ratio pulse output			When the origin search function is used	Variable duty ratio pulse output PWM output
			CW/CCW	Pulse plus direction			
CW0		Not supported.	Pulse output 0 (CW) fixed	Pulse output 0 (pulse) fixed			
CCW0		Not supported.	Pulse output 0 (CCW) fixed	Pulse output 1 (pulse) fixed			
CW1		Not supported.	Pulse output 1 (CW) fixed	Pulse output 0 (direction) fixed			
COW1		Not supported.	Pulse output 1 (CCW) fixed	Pulse output 1 (direction) fixed			
CIO 100	Bit 04	100.04	Pulse output 2 (CW)	Pulse output 2 (pulse)			
	Bit 05	100.05	Pulse output 2 (CCW)	Pulse output 2 (direction)			
	Bit 06	100.06	Pulse output 3 (CW)	Pulse output 3 (pulse)			
	Bit 07	100.07	Pulse output 3 (CCW)	Pulse output 3 (direction)			
CIO 101	Bit 00	101.00			Origin search 2 (Error counter reset output)	PWM output 0	
	Bit 01	101.01			Origin search 3 (Error counter reset output)	PWM output 1	
	Bit 02	101.02			Origin search 0 (Error counter reset output)		
	Bit 03	101.03			Origin search 1 (Error counter reset output)		

These areas are for line-driver inputs, so they can be used only for high-speed counters (1 MHz) and not for other purposes, such as normal inputs.

CP1H CPU Unit Terminal Block Arrangement

● CP1H-X□ CPU Units with AC power supply

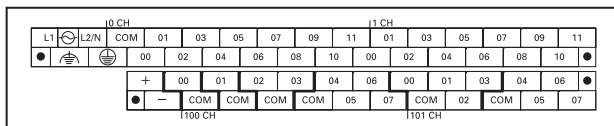

● CP1H-X□ CPU Units with DC power supply

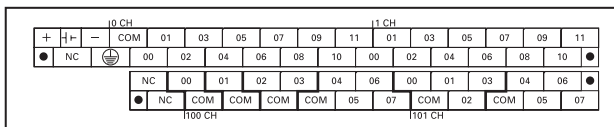

● CP1H-Y CPU Units

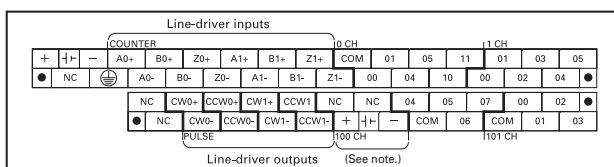

● Built-in Analog I/O Terminal Block Arrangement for CP1H-XA CPU Units

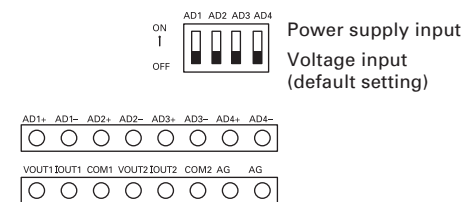

Note: Supply 24 VDC to the bottom 24 VDC input terminals when using bits 04 to 07 of output word CIO 100.

I/O Specifications

Input Specifications

Item	Specifications		
CP1H-XA/X CPU Units	CIO 0.04 to CIO 0.11	CIO 0.00 to CIO 0.03 and CIO 1.00 to CIO 1.03	CIO 1.04 to CIO 1.11
CP1H-Y CPU Units	CIO 0.04, CIO 0.05, CIO 0.10, CIO 0.11	CIO 0.00, CIO 0.01 and CIO 1.00 to CIO 1.03	CIO 1.04, CIO 1.05
Input voltage	24 VDC +10%/-15%		
Applicable sensors	2-wire sensors		
Input impedance	3.3 kΩ	3.0 kΩ	4.7 kΩ
Input current	7.5 mA typical	8.5 mA typical	5 mA typical
ON voltage	17.0 VDC min.	17.0 VDC min.	14.4 VDC min.
OFF voltage/current	1 mA max. at 5.0 VDC	1 mA max. at 5.0 VDC	1 mA max. at 5.0 VDC
ON delay	2.5 μs max.	50 μs max.	1 ms max.
OFF delay	2.5 μs max.	50 μs max.	1 ms max.
Circuit configuration			

CP1H-XA/X CPU Units

Input bits: CIO 0.04, CIO 0.06, CIO 0.08, CIO 0.10 (Phase A)
CIO 0.05, CIO 0.07, CIO 0.09, CIO 0.11 (Phase B)

CP1H-Y CPU Units

Input bits: CIO 0.04, CIO 0.10 (Phase A)
CIO 0.05, CIO 0.11 (Phase B)

Pulse plus direction input mode
Increment mode
Up/down input mode

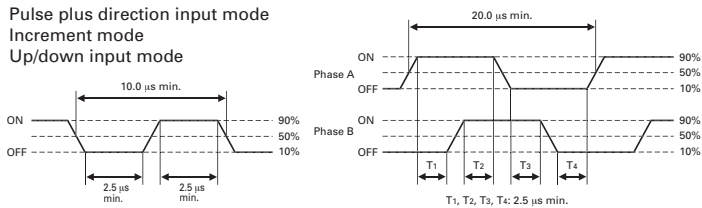

CP1H-XA/X CPU Units

Input bits: CIO 0.00 to CIO 0.03, CIO 1.00 to CIO 1.03

CP1H-Y CPU Units

Input bits: CIO 0.00, CIO 0.11, CIO 1.00 to CIO 1.03

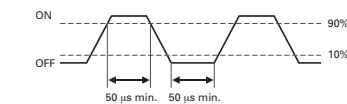

High-speed Counter Inputs (Line-driver Inputs, CP1H-Y CPU Units Only)

Item	High-speed counter input phases A and B	High-speed counter input phase Z
Input voltage	RS-422A line-driver, AM26LS31 or equivalent (See note.)	
Input type	Line-driver input	
Input current	10 mA typical	13 mA typical
Circuit configuration		
ON/OFF delay	<p>Phase A and B pulses + direction input mode, incrementing mode, acceleration/deceleration pulse input mode: 1-MHz pulse with duty ratio of 50%</p>	<p>Phase Z</p>

Note: The power supply voltage on the line-driver side must be 5 V ± 5% max.

Output Specifications

CPU Units with Relay Outputs

Item	Specifications	
Max. switching capacity	2 A, 250 VAC (cos φ = 1), 2 A, 24 VDC 4 A/common	
Min. switching capacity	5 VDC, 10 mA	
Service life of relay	Electrical	
	Resistive load	100,000 operations (24 VDC)
	Inductive load	48,000 operations (250 VAC, cos φ = 0.4)
	Mechanical	20,000,000 operations
ON delay	15 ms max.	
OFF delay	15 ms max.	
Circuit configuration	<p>Maximum 250 VAC: 2 A, 24 VDC: 2 A</p>	

Under the worst conditions, the service life of output contacts is as shown on the left.

The service life of relays is as shown in the following diagram as a guideline.

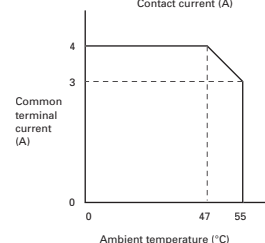
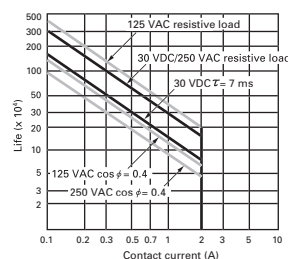

CPU Units with Transistor Outputs (Sinking/Sourcing)

Item	Specifications		
	CP1H-XA/X CPU Units	CIO 100.00 to CIO 100.07	CIO 101.00, CIO 101.01
CP1H-Y CPU Units	CIO 100.04 to CIO 100.07	CIO 101.00, CIO 101.01	CIO 101.02, CIO 101.03
Max. switching capacity	4.5 to 30 VDC: 300 mA/point, 0.8 A/common, 3.6 A/Unit (See notes 2 and 3.)		
Min. switching capacity	4.5 to 30 VDC, 1 mA		
Leakage current	0.1 mA max.		
Residual voltage	0.6 V max.	1.5 V max.	
ON delay	0.1 ms max.		
OFF delay	0.1 ms max.		1 ms max.
Fuse	1/common (See note 1.)		
Circuit configuration	Sinking Outputs		Sinking Outputs
	Sourcing Outputs		Sourcing Outputs

- Note 1:** Fuses cannot be replaced by the user.
Note 2: Do not use more than 0.9 A total for CIO 100.00 to CIO 100.3.
Note 3: A maximum of 0.9 A per common can be switched at an ambient temperature of 50°C.

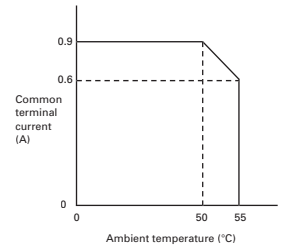

Note:

Do not apply a voltage or connect a load to an output terminal exceeding the maximum switching capacity.

Pulse Outputs

CP1H-XA/X CPU Units: Output bits CIO 100.00 to CIO 100.07
 CP1H-Y CPU Units: Output bits CIO 100.04 to CIO 100.07

Item	Specifications	Output waveform
Max. switching capacity	30 mA at 4.75 to 26.4 VDC	
Min. switching capacity	7 mA at 4.75 to 26.4 VDC	
Max. output frequency	100 kHz	

Pulse Outputs

CP1H-XA/X CPU Units: Output bits CIO 101.00 and CIO 101.01

Item	Specifications	Output waveform
Max. switching capacity	30 mA at 4.75 to 26.4 VDC	
Max. output frequency	1k Hz	
PWM output precision	ON duty +5%, -0% at output frequency of 1 kHz	

Pulse Outputs (Line-driver Outputs)

CP1H-Y CPU Units

Item	Specifications	Circuit configuration
Pulse outputs	Line-driver outputs, Am26LS31 or equivalent	
Max. output current	20 mA	
Max. output frequency	1 MHz	

Note: The above values assume a resistive load and do not consider the impedance of the cable connecting the load. The pulse widths during actual use may be smaller than the ones shown above due to pulse distortion caused by connecting cable impedance.

Note: Connect a load of 20 mA or less to the output. The Unit may be damaged if a current of more than 20 mA is output.

Input Specifications for CPM1A-40EDR/40EDT/40EDT1/20EDR1/20EDT/20EDT1/8ED

Item	Specifications	Circuit configuration
Input voltage	24 VDC +10%/-15%	
Input impedance	4.7 kΩ	
Input current	5 mA typical	
ON voltage	14.1 VDC min.	
OFF voltage	5.0 VDC max.	
ON delay	0 to 32 ms max. (Default: 8 ms) (See note 1.)	
OFF delay	0 to 32 ms max. (Default: 8 ms) (See note 1.)	

Note 1: Can be set in the PLC Setup to 0, 0.5, 1, 2, 4, 8, 16, or 32 ms. The CPM1A-40EDR/EDT/EDT1 are fixed at 16 ms.

Note:

Do not apply a voltage exceeding the rated voltage to an input terminal.

Output Specifications

Relay Outputs (CPM1A-40EDR/20EDR1/8ER)

Item	Specifications	Circuit configuration	
Max. switching capacity	2 A, 250 VAC (cosφ = 1), 2 A, 24 VDC 4 A/common		
Min. switching capacity	5 VDC, 10 mA		
Service life of relay	Electrical Resistive load		150,000 operations (24 VDC)
	Inductive load		100,000 operations (240 VAC, cosφ = 0.4)
Mechanical	20,000,000 operations		
ON delay	15 ms max.		
OFF delay	15 ms max.		

Under the worst conditions, the service life of output contacts is as shown on the left. The service life of relays is as shown in the following diagram as a guideline.

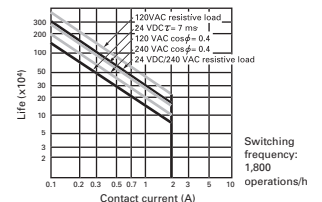

Note 1: The fuses cannot be replaced by the user.

Note 2: A maximum of 0.9 A per common can be switched at an ambient temperature of 50°C

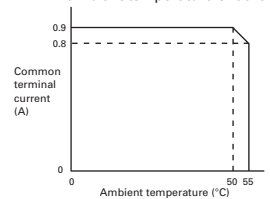

Note:

Do not apply a voltage or connect a load to an output terminal exceeding the maximum switching capacity.

Transistor Outputs (Sinking/Sourcing)

Item	Specifications			Circuit configuration
	CPM1A-40EDT CPM1A-40EDT1	CPM1A-20EDT CPM1A-20EDT1	CPM1A-8ET CPM1A-8ET1	Sinking Outputs
Max. switching capacity (See note 2.)	4.5 to 30 VDC: 0.3 A/point 0.9 A/common 3.6 A/common	4 VDC +10%/-5%: 0.3 A/point 0.9 A/common 1.8 A/common	• OUT00/OUT01: 0.2 A/point at 4.5 to 30 VDC • OUT02 to OUT07: 0.3 A/point at 4.5 to 30 VDC 0.9 A/common 1.8 A/common	
Leakage current	0.1 mA max.	0.1 mA max.	0.1 mA max.	Sinking Outputs
Residual voltage	1.5 V max.	1.5 V max.	1.5 V max.	
ON delay	0.1 ms max.	0.1 ms max.	0.1 ms max.	
OFF delay	1 ms max. at 24 VDC +10%/-5%, 5 to 300 mA	1 ms max. at 24 VDC +10%/-5%, 5 to 300 mA	1 ms max. at 24 VDC +10%/-5%, 5 to 300 mA	
Fuse (See note 1.)	None	1/common		

Expansion I/O

■ Analog Input Unit CPM1A-AD041

Item	CPM1A-AD041		
	Input voltage		Input current
Number of inputs	4		
Input signal range	0 to 5 V, 1 to 5 V, 0 to 10 V, or -10 to 10 V		0 to 20 mA or 4 to 20 mA
Max. rated input	±15 V		±30 mA
External input impedance	1 MΩ min.		Approx. 250 Ω
Resolution	6000		
Overall accuracy	25°C	±0.3% of full scale	±0.4% of full scale
	0 to 55°C	±0.6% of full scale	±0.8% of full scale
Conversion time	2.0 ms/point		
A/D conversion data	Binary data with resolution of 6,000 Full scale for -10 to 10 V: F448 (E890) to 0BB8 (1770) hex Full scale for other ranges: 0000 to 1770 (2EE0) hex		
Averaging	Supported		
Open-circuit detection	Supported		
Insulation resistance	20 MΩ min. (at 250 VDC, between isolated circuits)		
Dielectric strength	500 VAC for 1 min (between isolated circuits)		
Isolation method	Photocoupler isolation (between analog inputs and secondary internal circuits). No isolation between input signals.		

■ Analog Output Unit CPM1A-DA041

Item	CPM1A-DA041		
	Input voltage		Input current
Number of outputs	4		
Output signal range	0 to 5 V, 0 to 10 V, or -10 to 10 V		0 to 20 mA or 4 to 20 mA
Allowable external output load resistance	2 kΩ min.		350 kΩ max.
External output impedance	0.5 Ω max.		—
Resolution	6000		
Overall accuracy	25°C	±0.4% of full scale	
	0 to 55°C	±0.8% of full scale	
Conversion time	2.0 ms/point		
D/A conversion data	Binary data with resolution of 6,000 Full scale for -10 to 10 V: F448 (E890) to 0BB8 (1770) hex Full scale for other ranges: 0000 to 1770 (2EE0) hex		
Insulation resistance	20 MΩ min. (at 250 VDC)		
Dielectric strength	500 VAC for 1 min between isolated circuits		
Isolation method	Photocoupler isolation between analog inputs and secondary internal circuits. No isolation between analog input signals.		

■ Analog I/O Units CPM1A-MAD01/MAD11

Item	CPM1A-MAD01		CPM1A-MAD11	
	Voltage I/O	Current I/O	Voltage I/O	Current I/O
Analog Input Section	Number of inputs		2 inputs	
	Input signal range		0 to 10 V, 1 to 5 V	4 to 20 mA
	Max. rated input		±15V	±30mA
	External input impedance		1 MΩ min.	250 Ω rated
	Resolution		1/256	
	Overall accuracy	25°C	±0.3% of full scale	
		0 to 55°C	±0.6% of full scale	
A/D conversion data		8-bit binary		
Analog Output Section (See note 1.)	Averaging		—	
	Disconnection detection		—	
	Number of outputs		1 output	
	Output signal range		0 to 10 V, -10 to 10 V	4 to 20 mA
	External output max. current		5 mA	—
	Allowable external output load resistance		—	350 Ω
	External output impedance		—	1 kΩ min.
	Resolution		1/256 (1/512 for output signal range -10 to 10 V)	
	Overall accuracy	25°C	±0.4% of full scale	
		0 to 55°C	±0.8% of full scale	
Data setting		8-bit binary with sign bit		
D/A set data		—		
Conversion time		10 ms/Unit max. (See note 2.)		
Isolation method		Photocoupler isolation between I/O terminals and PLC signals (There is no isolation between the analog I/O signals.)		
		2 ms/point (6 ms for all points)		
		Photocoupler isolation between analog I/O and internal circuits (There is no isolation between the analog I/O signals.)		

Note 1: The voltage output and current output can be used at the same time for analog outputs, but the total output must not exceed 21 mA. **Note 2:** The conversion time is the total time for 2 analog inputs and 1 analog output.

2: The conversion time is the total time for 2 analog inputs and 1 analog output.

■ **CPM1A-TS001/TS002/TS101/TS102**
Temperature Sensor Units

By mounting a Temperature Sensor Unit to the PLC, inputs can be obtained from thermocouples or platinum resistance thermometers, and temperature measurements can be converted to binary data (4-digit hexadecimal) and stored in the input area of the CPU Unit.

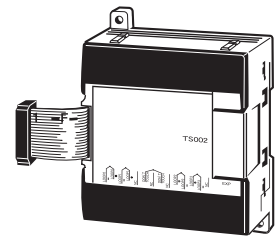

● **Specifications**

Item	CPM1A-TS001/002	CPM1A-TS101/102
Number of inputs	2 (TS001), 4 (TS002)	2 (TS101), 4 (TS102)
Input types	K, J switchable (Note: Same for all inputs.)	Pt100, JPt100 switchable (Note: Same for all inputs.)
Indication accuracy	[The larger of the indicated value $\pm 0.5\%$ and $\pm 2^\circ\text{C}$ (See note.)] ± 1 digit max.	[The larger of the indicated value $\pm 0.5\%$ and $\pm 1^\circ\text{C}$] ± 1 digit max.
Conversion time	250 ms/2 points (TS001, TS101); 250 ms/4 points (TS002, TS102)	
Converted temperature data	Binary (4-digit hexadecimal)	
Isolation method	Photocoupler isolation between the temperature input signals.	

Note: The indication accuracy when using a K-type thermocouple for temperatures less than -100°C is $\pm 4^\circ\text{C} \pm 1$ digit max.

● **Input Temperature Ranges for CPM1A-TS001/002**

(The rotary switch can be used to make the following range and input type settings.)

Input type	Range ($^\circ\text{C}$)	Range ($^\circ\text{F}$)
K	-200 to 1300	-300 to 2300
	0.0 to 500.0	0.0 to 900.0
J	-100 to 850	-100 to 1500
	0.0 to 400.0	0.0 to 750.0

● **Input Temperature Ranges for CPM1A-TS101/102**

(The rotary switch can be used to make the following range and input type settings.)

Input type	Range ($^\circ\text{C}$)	Range ($^\circ\text{F}$)
Pt100	-200 to 650.0	-300 to 1,200.0
JPt100	-200.0 to 650	-300 to 1,200.0

■ **CPM1A-SRT21**
CompoBus/S I/O Link Unit

The CompoBus/S I/O Link Unit functions as a slave for a CompoBus/S Master Unit (or an SRM1 CompoBus/S Master Control Unit) to form an I/O Link with 8 inputs and 8 outputs between the CompoBus/S I/O Link Unit and the Master Unit.

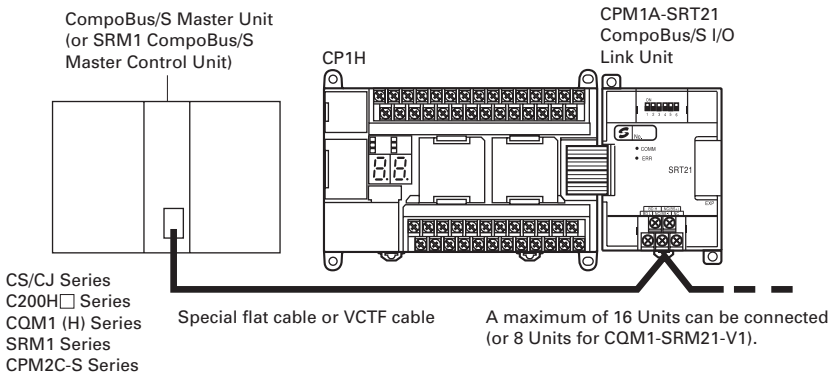

● **Specifications**

Item	CompoBus/S Slave
Master/Slave	CompoBus/S Slave
Number of I/O bits	8 input bits, 8 output bits
Number of words occupied in CPM2A I/O memory	1 input word, 1 output word (Allocated in the same way as for other Expansion Units)
Node number setting	Set using the DIP switch (before the CPU Unit is turned ON).

■ **CPM1A-DRT21**
DeviceNet I/O Link Unit

By connecting a CPM1A-DRT21 DeviceNet I/O Link Unit, a CPM2A can function as a slave for a DeviceNet Master Unit to establish I/O links for 32 inputs and 32 outputs between the CPM2A and the Master Unit.

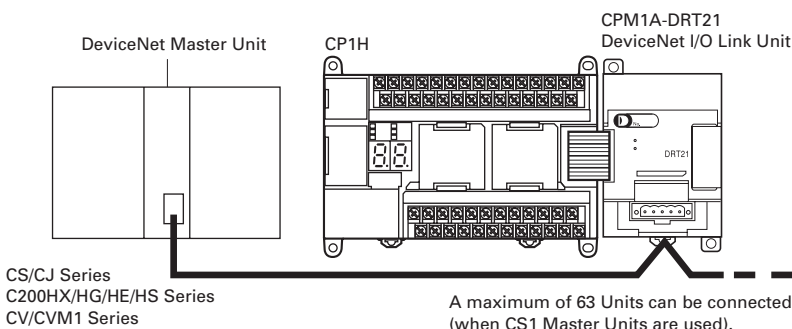

● **Specifications**

Item	CPM1A-DRT21
Master/Slave	DeviceNet Slave
Number of I/O points between Unit and Master	32 inputs, 32 outputs
Number of words allocated from CPM2A I/O memory	Input: 2 words Output: 2 words (Allocated in the same way as for other Expansion Units.)
Node address setting method	Set using DIP switch (before CPU Unit is powered up).
Maximum number of connectable nodes (CPU Series of mounted Master Unit)	63 (CS/CJ) 32 (CVM1/CV) 25 (C200HX/HG/HE) 16 (C200HS)

Dimensions

■ CP1H CPU Units

CP1H CPU Units (X/XA/Y Type)

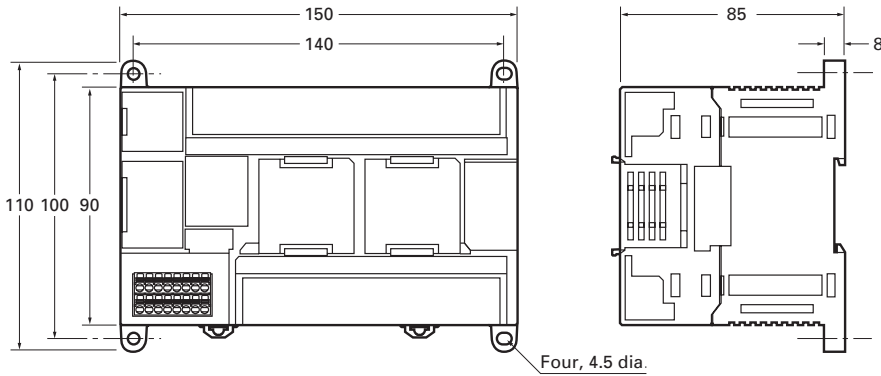

CPM1A-20ED□ CPM1A-AD041/CPM1A-DA041 CPM1A-MAD11/CPM1A-TS□□□

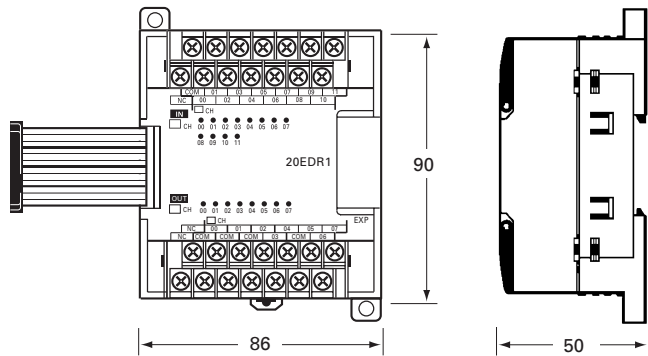

CPM1A-8E□□ CPM1A-SRT21/CPM1A-DRT21 CPM1A-MAD01

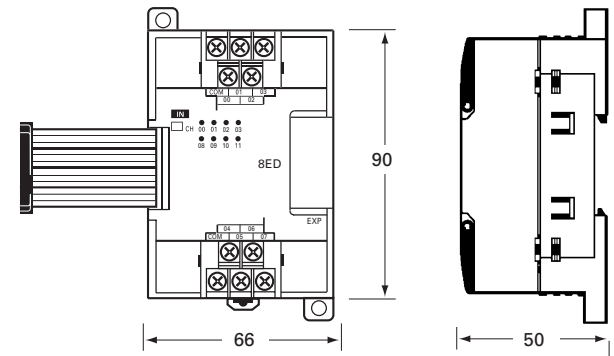

CPM1A-40ED□

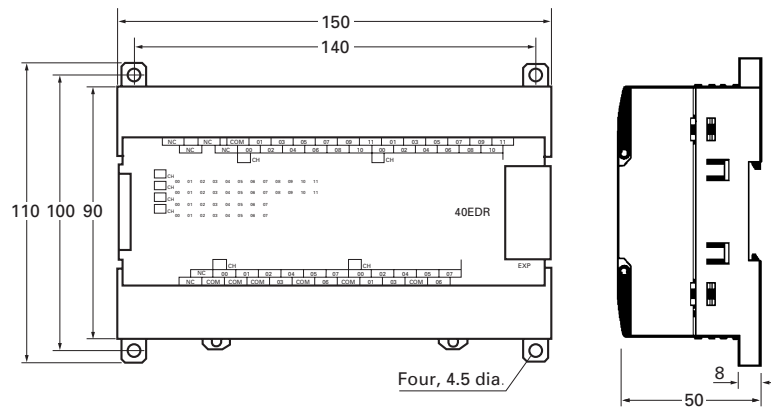

CP1W-EXT01

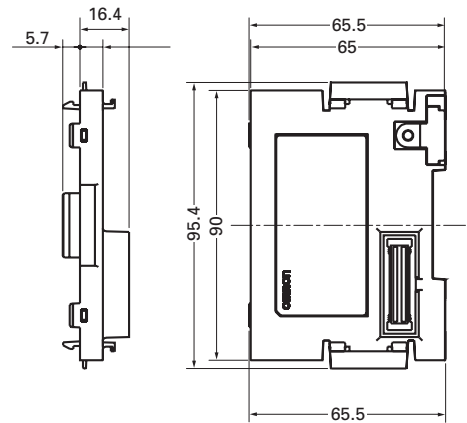

■ CJ-series Special I/O Units and CPU Bus Units

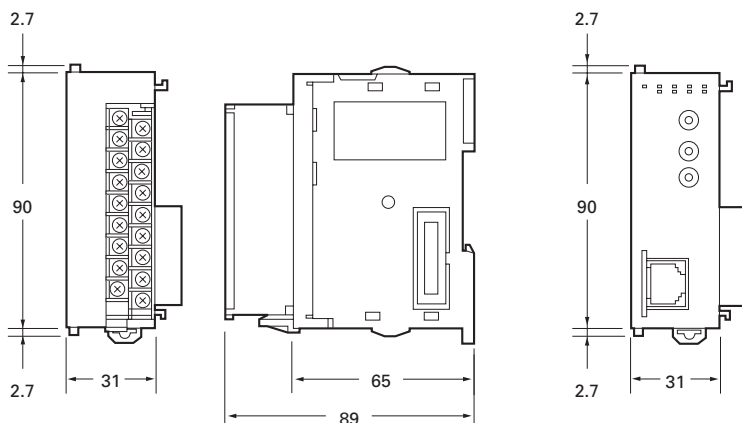

Instructions

Sequence Input Instructions

Instruction	Mnemonic	Function code
LOAD	LD	—
LOAD NOT	LD NOT	—
AND	AND	—
AND NOT	AND NOT	—
OR	OR	—
OR NOT	OR NOT	—
AND LOAD	AND LD	—
OR LOAD	OR LD	—
NOT	NOT	520
CONDITION ON	UP	521
CONDITION OFF	DOWN	522
BIT TEST	LD TST	350
BIT TEST	LD TSTN	351
BIT TEST	AND TST	350
BIT TEST	AND TSTN	351
BIT TEST	OR TST	350
BIT TEST	OR TSTN	351

Sequence Output Instructions

Instruction	Mnemonic	Function code
OUTPUT	OUT	—
OUTPUT NOT	OUT NOT	—
KEEP	KEEP	011
DIFFERENTIATE UP	DIFU	013
DIFFERENTIATE DOWN	DIFD	014
SET	SET	—
RESET	RSET	—
MULTIPLE BIT SET	SETA	530
MULTIPLE BIT RESET	RSTA	531
SINGLE BIT SET	SETB	532
SINGLE BIT RESET	RSTB	533
SINGLE BIT OUTPUT	OUTB	534

Sequence Output Instructions

Instruction	Mnemonic	Function code
END	END	001
NO OPERATION	NOP	000
INTERLOCK	IL	002
INTERLOCK CLEAR	ILC	003
MULTI-INTERLOCK DIFFERENTIATION HOLD	MILH	517
MULTI-INTERLOCK DIFFERENTIATION RELEASE	MILR	518
MULTI-INTERLOCK CLEAR	MILC	519
JUMP	JMP	004
JUMP END	JME	005
CONDITIONAL JUMP	CJP	510

Sequence Output Instructions

Instruction	Mnemonic	Function code
CONDITIONAL JUMP	CJPN	511
MULTIPLE JUMP	JMP0	515
MULTIPLE JUMP END	JME0	516
FOR-NEXT LOOPS	FOR	512
BREAK LOOP	BREAK	514
FOR-NEXT LOOPS	NEXT	513

Timer and Counter Instructions

Instruction	Mnemonic	Function code	
TIMER	BCD	TIM	—
	BIN	TIMX	550
COUNTER	BCD	CNT	—
	BIN	CNTX	546
HIGH-SPEED TIMER	BCD	TIMH	015
	BIN	TIMX	551
ONE-MS TIMER	BCD	TMHH	540
	BIN	TMHHX	552
ACCUMULATIVE TIMER	BCD	TTIM	087
	BIN	TTIMX	555
LONG TIMER	BCD	TIML	542
	BIN	TIMLX	553
MULTI-OUTPUT TIMER	BCD	MTIM	543
	BIN	MTIMX	554
REVERSIBLE COUNTER	BCD	CNTR	012
	BIN	CNTRX	548
RESET TIMER/COUNTER	BCD	CNR	545
	BIN	CNRX	547

Sequence Output Instructions

Instruction	Mnemonic	Function code
Symbol Comparison (Unsigned)	LD, AND, OR+,,	300 (=)
	<>, <, <=, >, >=	305 (<=)
	<>, <, <=, >, >=	310 (<)
	<>, <, <=, >, >=	315 (<=)
	<>, <, <=, >, >=	320 (>)
	<>, <, <=, >, >=	325 (>=)
Symbol Comparison (Double-word, unsigned)	LD, AND, OR+,,	301 (=)
	<>, <, <=, >, >=+L	306 (<=)
	<>, <, <=, >, >=	311 (<)
	<>, <, <=, >, >=	316 (<=)
	<>, <, <=, >, >=	321 (>)
	<>, <, <=, >, >=	326 (>=)
Symbol Comparison (Signed)	LD, AND, OR+,,	302 (=)
	<>, <, <=, >, >=+S	307 (<=)
	<>, <, <=, >, >=	312 (<)
	<>, <, <=, >, >=	317 (<=)
	<>, <, <=, >, >=	322 (>)
	<>, <, <=, >, >=	327 (>=)
Symbol Comparison (Double-word, signed)	LD, AND, OR+,,	303 (=)
	<>, <, <=, >, >=+SL	308 (<=)
	<>, <, <=, >, >=	313 (<)
	<>, <, <=, >, >=	318 (<=)
	<>, <, <=, >, >=	323 (>)
	<>, <, <=, >, >=	328 (>=)
Symbol Comparison (Double-word, signed)	LD, AND, OR+,,	303 (=)
	<>, <, <=, >, >=+SL	308 (<=)
	<>, <, <=, >, >=	313 (<)
	<>, <, <=, >, >=	318 (<=)
	<>, <, <=, >, >=	323 (>)
	<>, <, <=, >, >=	328 (>=)
Time Comparison	LD, AND, OR+ D, < DT, <= DT, > DT, >= DT	341 (=DT)
	<>, <, <=, >, >=	342 (<DT)
	<>, <, <=, >, >=	343 (<DT)
	<>, <, <=, >, >=	344 (<=DT)
	<>, <, <=, >, >=	345 (>DT)
	<>, <, <=, >, >=	346 (>=DT)
UNSIGNED COMPARE	CMP	020
DOUBLE UNSIGNED COMPARE	CMPL	060
SIGNED BINARY COMPARE	CPS	114
DOUBLE SIGNED BINARY COMPARE	CPSL	115
TABLE COMPARE	TCMP	085
MULTIPLE COMPARE	MCMP	019

Data Comparison Instructions

Instruction	Mnemonic	Function code
UNSIGNED BLOCK COMPARE	BCMP	068
EXPANDED BLOCK COMPARE	BCMP2	502
AREA RANGE COMPARE	ZCP	088
DOUBLE AREA RANGE COMPARE	ZCPL	116

Data Movement Instructions

Instruction	Mnemonic	Function code
MOVE	MOV	021
DOUBLE MOVE	MOVL	498
MOVE NOT	MVN	022
DOUBLE MOVE NOT	MVNL	499
MOVE BIT	MOVb	082
MOVE DIGIT	MOVD	083
MULTIPLE BIT TRANSFER	XFRB	062
BLOCK TRANSFER	XFER	070
BLOCK SET	BSET	071
DATA EXCHANGE	XCHG	073
DOUBLE DATA EXCHANGE	XCGL	562
SINGLE WORD DISTRIBUTE	DIST	080
DATA COLLECT	COLL	081
MOVE TO REGISTER	MOVR	560
MOVE TIMER/COUNTER PV TO REGISTER	MOVrW	561

Data Shift Instructions

Instruction	Mnemonic	Function code
SHIFT REGISTER	SFT	010
REVERSIBLE SHIFT REGISTER	SFTR	084
ASYNCHRONOUS SHIFT REGISTER	ASFT	017
WORD SHIFT	WSFT	016
ARITHMETIC SHIFT LEFT	ASL	025
DOUBLE SHIFT LEFT	ASLL	570
ARITHMETIC SHIFT RIGHT	ASR	026
DOUBLE SHIFT RIGHT	ASRL	571
ROTATE LEFT	ROL	027
DOUBLE ROTATE LEFT	ROLL	572
ROTATE LEFT WITHOUT CARRY	RLNC	574
DOUBLE ROTATE LEFT WITHOUT CARRY	RLNL	576
ROTATE RIGHT	ROR	028
DOUBLE ROTATE RIGHT	RORL	573
ROTATE RIGHT WITHOUT CARRY	RRNC	575
DOUBLE ROTATE RIGHT WITHOUT CARRY	RRNL	577
ONE DIGIT SHIFT LEFT	SLD	074
ONE DIGIT SHIFT RIGHT	SRD	075
SHIFT N-BIT DATA LEFT	NSFL	578
SHIFT N-BIT DATA RIGHT	NSFR	579
SHIFT N-BITS LEFT	NASL	580
DOUBLE SHIFT N-BITS LEFT	NSLL	582
SHIFT N-BITS RIGHT	NASR	581
DOUBLE SHIFT N-BITS RIGHT	NSRL	583

Increment/Decrement Instructions

Instruction	Mnemonic	Function code
INCREMENT BINARY	++	590
DOUBLE INCREMENT BINARY	++ L	591
DECREMENT BINARY	--	592
DOUBLE DECREMENT BINARY	-- L	593
INCREMENT BCD	++ B	594
DOUBLE INCREMENT BCD	++ BL	595
DECREMENT BCD	-- B	596
DOUBLE DECREMENT BCD	-- BL	597

Symbol Math Instructions

Instruction	Mnemonic	Function code
SIGNED BINARY ADD WITHOUT CARRY	+	400
DOUBLE SIGNED BINARY ADD WITHOUT CARRY	+ L	401
SIGNED BINARY ADD WITH CARRY	+ C	402
DOUBLE SIGNED BINARY ADD WITH CARRY	+ CL	403
BCD ADD WITHOUT CARRY	+ B	404
DOUBLE BCD ADD WITHOUT CARRY	+ BL	405
BCD ADD WITH CARRY	+ BC	406
DOUBLE BCD ADD WITH CARRY	+ BCL	407
SIGNED BINARY SUBTRACT WITHOUT CARRY	-	410
DOUBLE SIGNED BINARY SUBTRACT WITHOUT CARRY	- L	411
SIGNED BINARY SUBTRACT WITH CARRY	- C	412
DOUBLE SIGNED BINARY WITH CARRY	- CL	413
BCD SUBTRACT WITHOUT CARRY	- B	414
DOUBLE BCD SUBTRACT WITHOUT CARRY	- BL	415
BCD SUBTRACT WITH CARRY	- BC	416
BCD SUBTRACT WITH CARRY	- BCL	417
DOUBLE BCD SUBTRACT WITH CARRY	*	420
SIGNED BINARY MULTIPLY	* L	421
UNSIGNED BINARY MULTIPLY	* U	422
DOUBLE UNSIGNED BINARY MULTIPLY	* UL	423
BCD MULTIPLY	* B	424
DOUBLE BCD MULTIPLY	* BL	425
SIGNED BINARY DIVIDE	/	430
DOUBLE SIGNED BINARY DIVIDE	/L	431
UNSIGNED BINARY DIVIDE	/U	432
DOUBLE UNSIGNED BINARY DIVIDE	/UL	433
BCD DIVIDE	/B	434
DOUBLE BCD DIVIDE	/BL	435

Instructions

■ Data Conversion Instructions

Instruction	Mnemonic	Function code
BCD-TO-BINARY	BIN	023
DOUBLE BCD-TO-DOUBLE BINARY	BINL	058
BINARY-TO-BCD	BCD	024
DOUBLE BINARY-TO-DOUBLE BCD	BCDL	059
2'S COMPLEMENT	NEG	160
DOUBLE 2'S COMPLEMENT	NEGL	161
DOUBLE 2'S COMPLEMENT	SIGN	600
DATA DECODER	MLPX	076
DATA ENCODER	DMPX	077
ASCII CONVERT	ASC	086
ASCII TO HEX	HEX	162
COLUMN TO LINE	LINE	063
LINE TO COLUMN	COLM	064
SIGNED BCD-TO-BINARY	BINS	470
DOUBLE SIGNED BCD-TO-BINARY	BISL	472
SIGNED BINARY-TO-BCD	BCDS	471
DOUBLE SIGNED BINARY-TO-BCD	BDSL	473
CONVERT GRAY CODE	GRY	474

■ Special Math Instructions

Instruction	Mnemonic	Function code
BINARY ROOT	ROTB	620
BCD SQUARE ROOT	ROOT	072
ARITHMETIC PROCESS	APR	069
FLOATING POINT DIVIDE	FDIV	079
BIT COUNTER	BCNT	067

■ Logic Instructions

Instruction	Mnemonic	Function code
LOGICAL AND	ANDW	034
DOUBLE LOGICAL AND	ANDL	610
LOGICAL OR	ORW	035
DOUBLE LOGICAL OR	ORWL	611
EXCLUSIVE OR	XORW	036
DOUBLE EXCLUSIVE OR	XORL	612
EXCLUSIVE NOR	XNRW	037
DOUBLE EXCLUSIVE NOR	XNRL	613
COMPLEMENT	COM	029
DOUBLE COMPLEMENT	COML	614

■ Floating-point Math Instructions

Instruction	Mnemonic	Function code
FLOATING TO 16-BIT	FIX	450
FLOATING TO 32-BIT	FIXL	451
16-BIT TO FLOATING	FLT	452
32-BIT TO FLOATING	FLTL	453
FLOATING-POINT ADD	+F	454
FLOATING-POINT SUBTRACT	-F	455
FLOATING-POINT MULTIPLY	* F	456
FLOATING-POINT DIVIDE	/F	457
DEGREES TO RADIANS	RAD	458
RADIANS TO DEGREES	DEG	459
SINE	SIN	460
COSINE	COS	461
TANGENT	TAN	462
ARC SINE	ASIN	463
ARC COSINE	ACOS	464
ARC TANGENT	ATAN	465
SQUARE ROOT	SQRT	466

■ Floating-point Math Instructions

Instruction	Mnemonic	Function code
EXPONENT	EXP	467
LOGARITHM	LOG	468
EXPONENTIAL POWER	PWR	840
Floating Symbol Comparison	LD, AND, OR + = F, <> F, <F, <= F, >F, >= F	329 (= F) 330 (<>F) 331 (<F) 332 (<= F) 333 (>F) 334 (>= F)
FLOATING-POINT TO ASCII	FSTR	448
ASCII TO FLOATING-POINT	FVAL	449

■ Double-precision Floating-point Instructions

Instruction	Mnemonic	Function code
DOUBLE FLOATING TO 16-BIT BINARY	FIXD	841
DOUBLE FLOATING TO 32-BIT BINARY	FIXLD	842
16-BIT BINARY TO DOUBLE FLOATING	DBL	843
32-BIT BINARY TO DOUBLE FLOATING	DBLL	844
DOUBLE FLOATINGPOINT ADD	+D	845
DOUBLE FLOATINGPOINT SUBTRACT	-D	846
DOUBLE FLOATINGPOINT MULTIPLY	* D	847
DOUBLE FLOATINGPOINT DIVIDE	/D	848
DOUBLE DEGREES TO RADIANS	RADD	849

■ Double-precision Floating-point Instructions

Instruction	Mnemonic	Function code
DOUBLE RADIANS TO DEGREES	DEGD	850
DOUBLE SINE	SIND	851
DOUBLE COSINE	COSD	852
DOUBLE TANGENT	TAND	853
DOUBLE ARC SINE	ASIND	854
DOUBLE ARC COSINE	ACOSD	855
DOUBLE ARC TANGENT	ATAND	856
DOUBLE SQUARE ROOT	SQRTD	857
DOUBLE EXPONENT	EXPD	858
DOUBLE LOGARITHM	LOGD	859
DOUBLE EXPONENTIAL POWER	PWRD	860
DOUBLE SYMBOL COMPARISON	LD, AND, OR + = D, < > D, < D, <= D, > D, >= D	335 (=D) 336 (< >D) 337 (<D) 338 (<=D) 339 (>D) 340 (>=D)

■ Table Data Processing Instructions

Instruction	Mnemonic	Function code
SET STACK	SSET	630
PUSH ONTO STACK	PUSH	632
FIRST IN FIRST OUT	FIFO	633
LAST IN FIRST OUT	LIFO	634
DIMENSION RECORD TABLE	DIM	631
SET RECORD LOCATION	SETR	635
GET RECORD NUMBER	GETR	636
DATA SEARCH	SRCH	181
SWAP BYTES	SWAP	637
FIND MAXIMUM	MAX	182
FIND MINIMUM	MIN	183
SUM	SUM	184
FRAME CHECK SUM	FCS	180
STACK SIZE READ	SNUM	638
STACK DATA READ	SREAD	639
STACK DATA OVERWRITE	SWRIT	640
STACK DATA INSERT	SINS	641
STACK DATA DELETE	SDEL	642

■ Data Control Instructions

Instruction	Mnemonic	Function code
PID CONTROL	PID	190
PID CONTROL WITH AUTO TUNING	PIDAT	191
LIMIT CONTROL	LMT	680
DEAD BAND CONTROL	BAND	681
DEAD ZONE CONTROL	ZONE	682
TIME-PROPORTIONAL OUTPUT	TPO	685
SCALING	SCL	194
SCALING 2	SCL2	486
SCALING 3	SCL3	487
AVERAGE	AVG	195

■ Subroutine Instructions

Instruction	Mnemonic	Function code
SUBROUTINE CALL	SBS	091
SUBROUTINE ENTRY	SBN	092
SUBROUTINE RETURN	RET	093
MACRO	MCRO	099
GLOBAL SUBROUTINE CALL	GSBN	751
GLOBAL SUBROUTINE ENTRY	GRET	752
GLOBAL SUBROUTINE RETURN	GSBS	750

■ Interrupt Control Instructions

Instruction	Mnemonic	Function code
SET INTERRUPT MASK	MSKS	690
READ INTERRUPT MASK	MSKR	692
CLEAR INTERRUPT	CLI	691
DISABLE INTERRUPTS	DI	693
ENABLE INTERRUPTS	EI	694

■ High-speed Counter and Pulse Output Instructions

Instruction	Mnemonic	Function code
MODE CONTROL	INI	880
HIGH-SPEED COUNTER PV READ	PRV	881
COUNTER FREQUENCY CONVERT	PRV2	883
COMPARISON TABLE LOAD	CTBL	882
SPEED OUTPUT	SPED	885
SET PULSES	PULS	886
PULSE OUTPUT	PLS2	887
ACCELERATION CONTROL	ACC	888
ORIGIN SEARCH	ORG	889
PULSE WITH VARIABLE DUTY FACTOR	PWM	891

■ Step Instructions

Instruction	Mnemonic	Function code
STEP DEFINE	STEP	008
STEP START	SNXT	009

■ Basic I/O Unit Instructions

Instruction	Mnemonic	Function code
I/O REFRESH	IORF	097
7-SEGMENT DECODER	SDEC	078
DIGITAL SWITCH INPUT	DSW	210
TEN KEY INPUT	TKY	211
HEXADECIMAL KEY INPUT	HKY	212
MATRIX INPUT	MTR	213
7-SEGMENT DISPLAY OUTPUT	7SEG	214
INTELLIGENT I/O READ	IORD	222
INTELLIGENT I/O WRITE	IOWR	223
CPU BUS UNIT I/O REFRESH	DLNK	226

Serial Communications Instructions

Instruction	Mnemonic	Function code
PROTOCOL MACRO	PMCR	260
TRANSMIT	TXD	236
RECEIVE	RXD	235
TRANSMIT VIA SERIAL COMMUNICATIONS UNIT	TXDU	256
RECEIVE VIA SERIAL COMMUNICATIONS UNIT	RXDU	255
CHANGE SERIAL PORT SETUP	STUP	237

Network Instructions

Instruction	Mnemonic	Function code
NETWORK SEND	SEND	090
NETWORK RECEIVE	RECV	098
DELIVER COMMAND	CMND	490
EXPLICIT MESSAGE SEND	EXPLT	720
EXPLICIT GET ATTRIBUTE	EGATR	721
EXPLICIT SET ATTRIBUTE	ESATR	722
EXPLICIT WORD READ	ECHRD	723
EXPLICIT WORD WRITE	ECHWR	724

Display Instructions

Instruction	Mnemonic	Function code
DISPLAY MESSAGE	MSG	046
DISPLAY 7-SEGMENT DATA	SCH	047
CONTROL 7-SEGMENT	SCTRL	048

Clock Instructions

Instruction	Mnemonic	Function code
CALENDAR ADD	CADD	730
CALENDAR SUBTRACT	CSUB	731
HOURS TO SECONDS	SEC	065
SECONDS TO HOURS	HMS	066
CLOCK ADJUSTMENT	DATE	735

Debugging Instructions

Instruction	Mnemonic	Function code
TRACE MEMORY SAMPLING	TRSM	045

Failure Diagnosis Instructions

Instruction	Mnemonic	Function code
FAILURE ALARM	FAL	006
SEVERE FAILURE ALARM	FALS	007
FAILURE POINT DETECTION	FPD	269

Other Instructions

Instruction	Mnemonic	Function code
SET CARRY	STC	040
CLEAR CARRY	CLC	041
EXTEND MAXIMUM CYCLE TIME	WDT	094
SAVE CONDITION FLAGS	CCS	282
LOAD CONDITION FLAGS	CCL	283
CONVERT ADDRESS FROM CS	FRMCV	284
CONVERT ADDRESS TO CV	TOCV	285

Block Programming Instructions

Instruction	Mnemonic	Function code	
BLOCK PROGRAM BEGIN	BPRG	096	
BLOCK PROGRAM END	BEND	801	
BLOCK PROGRAM PAUSE	BPPS	811	
BLOCK PROGRAM RESTART	BPRS	812	
CONDITIONAL BLOCK EXIT	CCS	282	
CONDITIONAL BLOCK EXIT	CONDITION EXIT	806	
CONDITIONAL BLOCK EXIT	EXIT Bit operand	806	
CONDITIONAL BLOCK EXIT (NOT)	EXIT NOT Bit operand	806	
CONDITIONAL BLOCK BRANCHING	CONDITION IF	802	
CONDITIONAL BLOCK BRANCHING	IF Bit operand	802	
CONDITIONAL BLOCK BRANCHING (NOT)	IF NOT Bit operand	802	
CONDITIONAL BLOCK BRANCHING (ELSE)	ELSE	803	
CONDITIONAL BLOCK BRANCHING END	IEND	804	
ONE CYCLE AND WAIT	CONDITION WAIT	805	
ONE CYCLE AND WAIT	WAIT Bit operand	805	
ONE CYCLE AND WAIT (NOT)	WAIT NOT Bit operand	805	
TIMER WAIT	BCD	TIMW	813
	BIN	TIMWX	816
COUNTER WAIT	BCD	CNTW	814
	BIN	CNTWX	817
HIGH-SPEED TIMER WAIT	BCD	TMHW	815
	BIN	TMHWX	818
LOOP	LOOP	809	

Block Programming Instructions

Instruction	Mnemonic	Function code
LEND	CONDITION LEND	810
LEND	LEND Bit operand	810
LEND NOT	LEND NOT Bit operand	810

Text String Processing Instructions

Instruction	Mnemonic	Function code
MOV STRING	MOV \$	664
CONCATENATE STRING	+ \$	656
GET STRING LEFT	LEFT \$	652
GET STRING RIGHT	RGHT \$	653
GET STRING MIDDLE	MID \$	654
FIND IN STRING	FIND \$	660
STRING LENGTH	LEN \$	650
REPLACE IN STRING	RPLC \$	661
DELETE STRING	DEL \$	658
EXCHANGE STRING	XCHG \$	665
CLEAR STRING	CLR \$	666
INSERT INTO STRING	INS \$	657
String Comparison	LD, AND, OR + = \$, <> \$, < \$, <= \$, > \$, >= \$	670 (= \$) 671 (< > \$) 672 (< \$) 673 (< = \$) 674 (> \$) 675 (> = \$)

Task Control Instructions

Instruction	Mnemonic	Function code
TASK ON	TKON	820
TASK OFF	TKOF	821

Model Conversion Instructions

Instruction	Mnemonic	Function code
BLOCK TRANSFER	XFERC	565
SINGLE WORD DISTRIBUTE	DISTC	566
DATA COLLECT	COLLC	567
MOVE BIT	MOVBC	568
BIT COUNTER	BCNTC	621

Special Instructions for Function Blocks

Instruction	Mnemonic	Function code
GET VARIABLE ID	GETID	286

Ordering Information

International Standards

* The standards indicated in the "Standards" column are those current for UL, CSA, cULus, NK, and Lloyd standards and EC Directives as of the end of October 2006. The standards are abbreviated as follows: U: UL, U1: UL (Class I Division 2 Products for Hazardous Locations), C: CSA, UC: cULus, UC1: cULus (Class I Division 2 Products for Hazardous Locations), CU: cUL, N: NK, L: Lloyd, and CE: EC Directives

* Ask your OMRON representative for the conditions under which the standards were met.



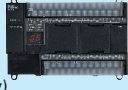
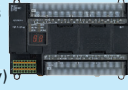
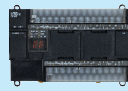





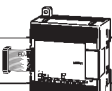

■ CPU Units

CPU Unit	Specifications				Model	Standards
	Power supply	Output method	Inputs	Outputs		
CP1H-X CPU Units Memory capacity: 20 Ksteps High-speed counters: 100 kHz, 4 axes Pulse outputs: 100 kHz, 4 axes (Models with transistor outputs only) 	AC power supply	Relay output (No pulse output)	24	16	CP1H-X40DR-A	CE, N, L, UC1
	DC power supply	Transistor output (sinking)			CP1H-X40DT-D	CE, N, L, UC1
		Transistor output (sourcing)			CP1H-X40DT1-D	CE, N, L, UC1
CP1H-XA CPU Units Memory capacity: 20 Ksteps High-speed counters: 100 kHz, 4 axes Pulse outputs: 100 kHz, 4 axes (Models with transistor outputs only) Analog inputs: 4 Analog outputs: 2 	AC power supply	Relay output	24	16	CP1H-XA40DR-A	CE, N, L, UC1
	DC power supply	Transistor output (sinking)			CP1H-XA40DT-D	CE, N, L, UC1
		Transistor output (sourcing)			CP1H-XA40DT1-D	CE, N, L, UC1
CP1H-Y CPU Units Memory capacity: 20 Ksteps High-speed counters: 1 MHz, 2 axes 100 kHz, 2 axes Pulse outputs: 1 MHz, 2 axes 100 kHz, 2 axes 	DC power supply	Transistor output (sinking)	12 + line-driver input, 2 axes	8 + line-driver input, 2 axes	CP1H-Y20DT-D	CE, N

■ Options (for CPU Units)

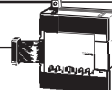
Name	Specifications	Model	Standards
RS-232C Option Board	For CPU Unit option port.	CP1W-CIF01	CE, N, L, UC1
RS-422A/485 Option Board	For CPU Unit option port.	CP1W-CIF11	CE, N, L, UC1
Memory Cassette	Can be used for backing up programs or auto-booting.	CP1W-ME05M	CE, N, L, UC1

■ Expansion Units

Name	Output method	Inputs	Outputs	Model	Standards	
Expansion I/O Units	Relay	24	16	CPM1A-40EDR	CE, N, L	
	Transistor (sinking)			CPM1A-40EDT	CE, N, L	
	Transistor output (sourcing)			CPM1A-40EDT1	CE, N, L	
		Relay	12	8	CPM1A-20EDR1	U, C, CE
		Transistor (sinking)			CPM1A-20EDT	U, C, N, CE
		Transistor output (sourcing)			CPM1A-20EDT1	U, C, N, CE
	—	8	8	—	CPM1A-8ED	U, C, N, CE
		Relay	—	8	CPM1A-8ER	U, C, N, CE
		Transistor (sinking)	—	8	CPM1A-8ET	U, C, N, CE
		Transistor output (sourcing)	—	8	CPM1A-8ET1	U, C, N, CE
Analog Input Unit	Analog (resolution: 1/6000)	4	—	CPM1A-AD041	U, C, N, CE	
Analog Output Unit	Analog (resolution: 1/6000)	—	4	CPM1A-DA041	UC1, CE	
Analog I/O Units	Analog (resolution: 1/256)	2	1		CPM1A-MAD01	UC1, CE
	Analog (resolution: 1/6000)	2	1		CPM1A-MAD11	U, C, N, CE
DeviceNet I/O Link Unit	—	32 (I/O link input bits)	32 (I/O link input bits)		CPM1A-DRT21	U, C, CE
CompoBus/S I/O Link Unit	—	8 (I/O link input bits)	8 (I/O link input bits)		CPM1A-SRT21	U, C, N, CE
Temperature Sensor Units	2 thermocouple inputs				CPM1A-TS001	U, C, N, CE
	4 thermocouple inputs				CPM1A-TS002	U, C, N, CE
	2 platinum resistance thermometer inputs				CPM1A-TS101	U, C, N, CE
	4 platinum resistance thermometer inputs				CPM1A-TS102	U, C, N, CE

■ I/O Connecting Cable

Name	Specifications	Model	Standards
I/O Connecting Cable	80 cm (for CPM1A Expansion Units)	CP1W-CN811	CE, N, UC1

Note: An I/O Connecting Cable (approx. 6 cm) for horizontal connection is provided with CPM1A Expansion Units.

■ Programming Devices

Name	Specifications	Model	Standards	
CX-One FA Integrated Tool Package Ver. 2.0	<p>CX-One is a package that integrates the Support Software for OMRON PLCs and components. CX-One runs on the following OS. OS: Windows 98SE, Me, NT 4.0 (Service Pack 6a), 2000 (Service Pack 3 or higher), or XP Note: CX-Thermo runs only on Windows 2000 (Service Pack 3 or higher) or XP. CX-One Ver. 2.0 includes CX-Programmer Ver. 7.□. For details, refer to the CX-One catalog (Cat. No. R134). Note 1. The software is provided on CDs for the CXONE-AL□□C-□EV2 and on a DVD for the CXONE-AL□□D-□EV2. 2. Site licenses are available for users who must run the CX-One on many computers. Ask your OMRON representative for details.</p>	1 license	CXONE-AL01C-EV2 CXONE-AL01D-EV2	—
		3 licenses	CXONE-AL03C-EV2 CXONE-AL03D-EV2	—
		10 licenses	CXONE-AL10C-EV2 CXONE-AL10D-EV2	—
		30 licenses	CXONE-AL30C-EV2 CXONE-AL30D-EV2	—
		50 licenses	CXONE-AL50C-EV2 CXONE-AL50D-EV2	—
CX-Programmer can still be ordered individually in the following model number.				
CX-Programmer Ver. 7.□ (See note 2.)	PLC Support Software OS: Windows 98SE, Me, NT 4.0 (Service Pack 6a), 2000 (Service Pack 3 or higher), or XP	1 license	WS02-CXPC1-E-V7□	—
		3 licenses	WS02-CXPC1-E03-V7□	—
		10 licenses	WS02-CXPC1-E10-V7□	—
Programming Device Connecting Cable for CP1W-CIF01 RS-232C Option Board (See note.)	Connects DOS computers, D-Sub 9-pin (Length: 2.0 m)	For anti-static connectors	XW2Z-200S-CV	—
	Connects DOS computers, D-Sub 9-pin (Length: 5.0 m)		XW2Z-500S-CV	—
	Connects DOS computers, D-Sub 9-pin (Length: 2.0 m)	XW2Z-200S-V	—	
	Connects DOS computers, D-Sub 9-pin (Length: 5.0 m)	XW2Z-500S-V	—	
USB-Serial Conversion Cable (See note.)	USB-RS-232C Conversion Cable (Length: 0.5 m) and PC driver (on a CD-ROM disc) are included. Complies with USB Specification 1.1 On personal computer side: USB (A plug connector, male) On PLC side: RS-232C (D-sub 9-pin, male) Driver: Supported by Windows 98, Me, 2000, and XP		CS1W-CIF31	—

Note 1: Cannot be used with a peripheral USB port.

To connect to a personal computer via a peripheral USB port, use commercially-available USB cable (A or B type, male).
 2: CP1H is supported by CX-Programmer version 6.2 or higher.

■ Optional Products, Maintenance Products and DIN Track Accessories

Name	Specifications	Model	Standards
Battery Set	For CP1H CPU Units (Use batteries within two years of manufacture.)	CJ1W-BAT01	CE
DIN Track	Length: 0.5 m; Height: 7.3 mm	PFP-50N	—
	Length: 1 m; Height: 7.3 mm	PFP-100N	
	Length: 1 m; Height: 16 mm	PFP-100N2	
End Plate	There are 2 stoppers provided with CPU Units and I/O Interface Units as standard accessories to secure the Units on the DIN Track.	PFP-M	

Ordering Information

■ CJ-series Special I/O Units and CPU Bus Units

Category	Name	Specifications	Model	Standards
CP1H CPU Unit options	CJ Unit Adapter	Adapter for connecting CJ-series Special I/O Units and CPU Bus Units (includes CJ-series End Cover)	CP1W-EXT01	
CJ-series Special I/O Units	Analog Input Units	8 inputs (1 to 5 V, 0 to 5 V, 0 to 10 V, -10 to 10 V, 4 to 20 mA) Resolution: 1/8,000; Conversion speed: 250 μs/input max. (Can be set to 1/4,000 resolution and 1 ms/input.)	CJ1W-AD081-V1	UC1, CE, N, L
		4 inputs (1 to 5 V, 0 to 5 V, 0 to 10 V, -10 to 10 V, 4 to 20 mA) Resolution: 1/8,000; Conversion speed: 250 μs/input max. (Can be set to 1/4,000 resolution and 1 ms/input.)	CJ1W-AD041-V1	
	Analog Output Units	8 outputs (1 to 5 V, 0 to 5 V, 0 to 10 V, -10 to 10 V) Resolution: 1/4,000; Conversion speed: 1 ms/output max. (Can be set to 1/8000, 250 μs/output)	CJ1W-DA08V	UC1, CE, N
		8 outputs (4 to 20 mA) Resolution: 1/4,000; Conversion speed: 1 ms/output max. (Can be set to 1/8,000, 250 μs/output)	CJ1W-DA08C	
		4 outputs (1 to 5 V, 0 to 5 V, 0 to 10 V, -10 to 10 V, 4 to 20 mA) Resolution: 1/4,000, Conversion speed: 1 ms/point max.	CJ1W-DA041	
	Analog I/O Unit	2 outputs (1 to 5 V, 0 to 5 V, 0 to 10 V, -10 to 10 V, 4 to 20 mA) Resolution: 1/4,000; Conversion speed: 1 ms/output max.	CJ1W-DA021	UC1, CE, N, L
		4 inputs, 2 outputs (1 to 5 V, 0 to 5 V, 0 to 10 V, -10 to 10 V, 4 to 20 mA) Resolution: 1/4000; Conversion speed: 1 ms/point max. (Can be set to 1/8,000, 250 μs/point)	CJ1W-MAD42	
	Process Input Units	4 inputs, B, J, K, L, R, S, T; Conversion speed: 250 ms/4 inputs	CJ1W-PTS51	UC1, CE
		4 inputs, Pt100 Ω (JIS, IEC), JPt100 Ω, Conversion speed: 250 ms/4 inputs	CJ1W-PTS52	
		2 inputs, B, E, J, K, L, N, R, S, T, U, W, Re5-26, PL ±100 mV, Resolution: 1/64,000; Conversion speed: 10 ms/2 inputs	CJ1W-PTS15	
		2 inputs, Pt100, JPt100, Pt50, Ni508.4; Resolution: 1/64,000; Conversion speed: 10 ms/2 inputs	CJ1W-PTS16	
	Temperature Control Units	2 inputs, 0 to 1.25 V, -1.25 to 1.25 V, 0 to 5 V, 1 to 5 V, -5 to 5 V, 0 to 10 V, -10 to 10V, ±10-V selectable range, 0 to 20 mA, 4 to 20 mA	CJ1W-PDC15	UC1, CE, N, L
		4 loops, thermocouple input, NPN output	CJ1W-TC001	
		4 loops, thermocouple input, PNP output	CJ1W-TC002	
		2 loops, thermocouple input, NPN output, heater burnout detection function	CJ1W-TC003	
		2 loops, thermocouple input, PNP output, heater burnout detection function	CJ1W-TC004	
		4 loops, platinum resistance thermometer input, NPN output	CJ1W-TC101	
		4 loops, platinum resistance thermometer input, PNP output	CJ1W-TC102	
	22 loops, platinum resistance thermometer input, NPN output, heater burnout detection function	CJ1W-TC103		
	2 loops, platinum resistance thermometer input, PNP output, heater burnout detection function	CJ1W-TC104		
	High-speed Counter Unit	2 inputs, max. input frequency: 500 kpps	CJ1W-CT021	UC1, CE, N
	Position Control Units	Pulse train, open collector output, 1 axis	CJ1W-NC113	UC1, CE
		Pulse train, open collector output, 2 axes	CJ1W-NC213	
Pulse train, open collector output, 4 axes (See note 1.)		CJ1W-NC413		
Pulse train, line driver output, 1 axis		CJ1W-NC133		
Pulse train, line driver output, 2 axes		CJ1W-NC233		
Pulse train, line driver output, 4 axes (See note 1.)		CJ1W-NC433		
Space Unit (See note 2.)	—	CJ1W-SP001		
ID Sensor Units	For V600 Series, 1 R/W Head	CJ1W-V600C11	—	
	For V600 Series, 2 R/W Heads	CJ1W-V600C12		
CompoBus/S Master Unit	CompoBus/S remote I/O, 256 points max.	CJ1W-SRM21		
CJ-series CPU Bus Units	Controller Link Units	Wired (Shielded twisted-pair cable)	CJ1W-CLK21-V1	UC1, CE, N, L
	Serial Communications Units	1 RS-232C port and 1 RS-422A/485 port	CJ1W-SCU41-V1	
		2 RS-232C ports	CJ1W-SCU21-V1	
	Ethernet Unit	100Base-TX	CJ1W-ETN21	
	DeviceNet Unit	Functions as master and/or slave; allows control of 32,000 points max. per master.	CJ1W-DRM21	
	Position Control Unit	MECHATROLINK-II Position Control Unit	CJ1W-NCF71	UC1, CE
	MECHATROLINK-II Motion Control Unit	Real axes: 30, Virtual axes: 2, Special motion control language	CJ1W-MCH71	
	FI-net Unit	100Base-TX	CJ1W-FLN22	
SYSMAC SPU	High-speed data collection unit	CJ1W-SPU01		

Note 1: For details on CJ-series Special I/O Units and CPU Bus Units, refer to the CJ1 catalog (Cat. No. P052).
Note 2: Use a CJ1W-SP001 Space Unit if the operating temperature is 0 to 55°C.

Read and Understand this Catalog

Please read and understand this catalog before purchasing the product. Please consult your OMRON representative if you have any questions or comments.

Warranty and Limitations of Liability

WARRANTY

OMRON's exclusive warranty is that the products are free from defects in materials and workmanship for a period of one year (or other period if specified) from date of sale by OMRON.

OMRON MAKES NO WARRANTY OR REPRESENTATION, EXPRESS OR IMPLIED, REGARDING NON-INFRINGEMENT, MERCHANTABILITY, OR FITNESS FOR PARTICULAR PURPOSE OF THE PRODUCTS. ANY BUYER OR USER ACKNOWLEDGES THAT THE BUYER OR USER ALONE HAS DETERMINED THAT THE PRODUCTS WILL SUITABLY MEET THE REQUIREMENTS OF THEIR INTENDED USE. OMRON DISCLAIMS ALL OTHER WARRANTIES, EXPRESS OR IMPLIED.

LIMITATIONS OF LIABILITY

OMRON SHALL NOT BE RESPONSIBLE FOR SPECIAL, INDIRECT, OR CONSEQUENTIAL DAMAGES, LOSS OF PROFITS OR COMMERCIAL LOSS IN ANY WAY CONNECTED WITH THE PRODUCTS, WHETHER SUCH CLAIM IS BASED ON CONTRACT, WARRANTY, NEGLIGENCE, OR STRICT LIABILITY.

In no event shall the responsibility of OMRON for any act exceed the individual price of the product on which liability is asserted.

IN NO EVENT SHALL OMRON BE RESPONSIBLE FOR WARRANTY, REPAIR, OR OTHER CLAIMS REGARDING THE PRODUCTS UNLESS OMRON'S ANALYSIS CONFIRMS THAT THE PRODUCTS WERE PROPERLY HANDLED, STORED, INSTALLED, AND MAINTAINED AND NOT SUBJECT TO CONTAMINATION, ABUSE, MISUSE, OR INAPPROPRIATE MODIFICATION OR REPAIR.

Application Considerations

SUITABILITY FOR USE

OMRON shall not be responsible for conformity with any standards, codes, or regulations that apply to the combination of the product in the customer's application or use of the product.

Take all necessary steps to determine the suitability of the product for the systems, machines, and equipment with which it will be used.

Know and observe all prohibitions of use applicable to this product.

NEVER USE THE PRODUCT FOR AN APPLICATION INVOLVING SERIOUS RISK TO LIFE OR PROPERTY WITHOUT ENSURING THAT THE SYSTEM AS A WHOLE HAS BEEN DESIGNED TO ADDRESS THE RISKS, AND THAT THE OMRON PRODUCT IS PROPERLY RATED AND INSTALLED FOR THE INTENDED USE WITHIN THE OVERALL EQUIPMENT OR SYSTEM.

PROGRAMMABLE PRODUCTS

OMRON shall not be responsible for the user's programming of a programmable product, or any consequence thereof.

Disclaimers

CHANGE IN SPECIFICATIONS

Product specifications and accessories may be changed at any time based on improvements and other reasons. Consult with your OMRON representative at any time to confirm actual specifications of purchased product.

DIMENSIONS AND WEIGHTS

Dimensions and weights are nominal and are not to be used for manufacturing purposes, even when tolerances are shown.

PERFORMANCE DATA

Performance data given in this catalog is provided as a guide for the user in determining suitability and does not constitute a warranty. It may represent the result of OMRON's test conditions, and the users must correlate it to actual application requirements. Actual performance is subject to the OMRON Warranty and Limitations of Liability.

MEMO.

A series of horizontal dashed blue lines spanning the width of the page, intended for writing a memo.

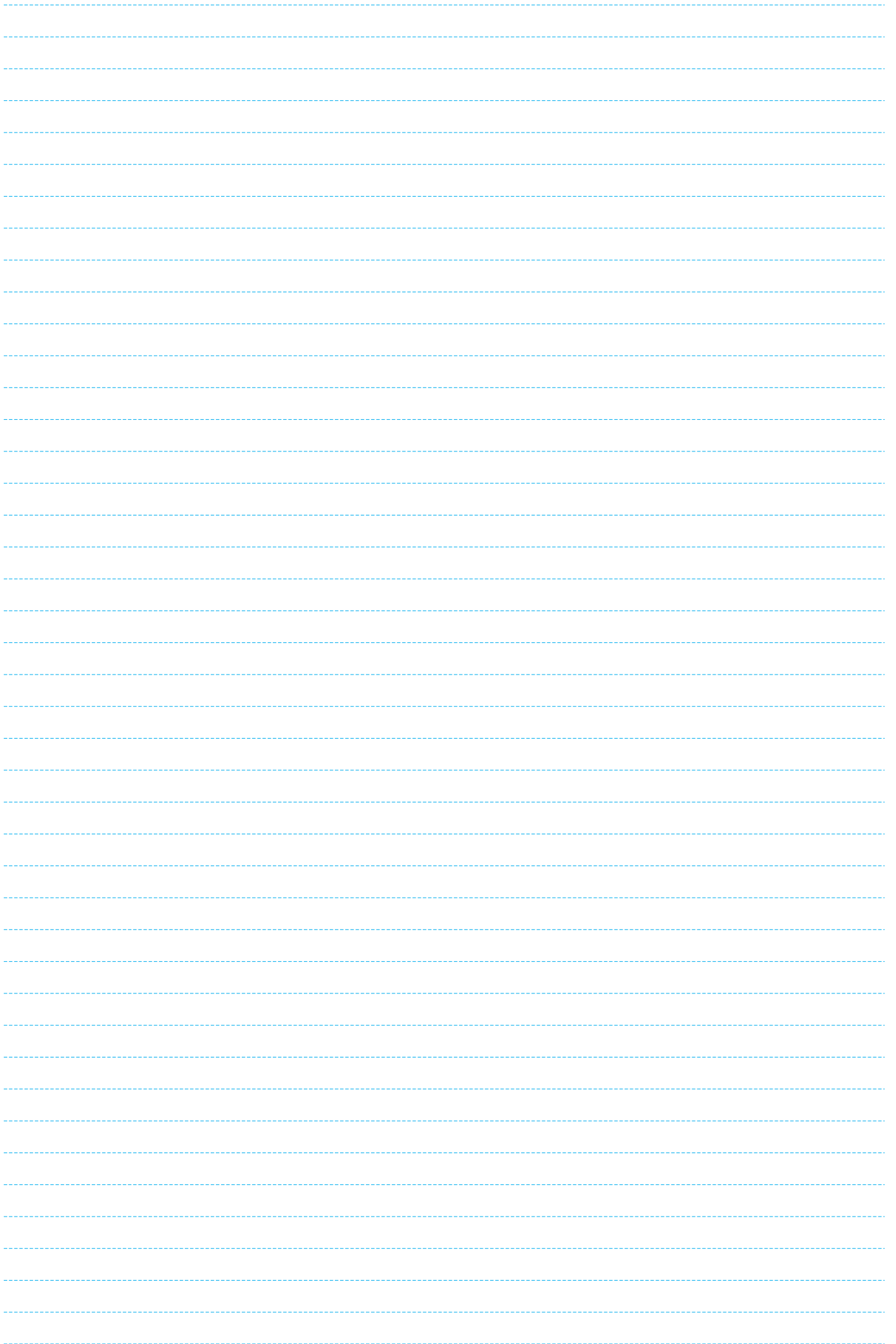

Note: Do not use this document to operate the Unit.

Printed on 100%
Recycled Paper



OMRON Corporation

**Industrial Automation Company
Control Devices Division H.Q.**
Shiokoji Horikawa, Shimogyo-ku,
Kyoto, 600-8530 Japan
Tel: (81)75-344-7109
Fax: (81)75-344-7149

Regional Headquarters

OMRON EUROPE B.V.

Wegalaan 67-69, NL-2132 JD Hoofddorp
The Netherlands
Tel: (31)2356-81-300
Fax: (31)2356-81-388

OMRON ELECTRONICS LLC

1 East Commerce Drive, Schaumburg,
IL 60173 U.S.A.
Tel: (1)847-843-7900/Fax: (1)847-843-8568

OMRON ASIA PACIFIC PTE. LTD.

83 Clemenceau Avenue,
#11-01, UE Square,
Singapore 239920
Tel: (65)6835-3011/Fax: (65)6835-2711

OMRON (CHINA) CO., LTD.

Room 2211, Bank of China Tower,
200 Yin Cheng Zhong Road,
PuDong New Area, Shanghai, 200120 China
Tel: (86)21-5037-2222/Fax: (86)21-5037-2200

Authorized Distributor:

Note: Specifications subject to change without notice.

Cat. No. P055-E1-02
Printed in Japan
1206-1M