

CJ1W-CT021

High-speed Counter Units

OPERATION MANUAL

OMRON



CJ1W-CT021
High-speed Counter Units
Operation Manual

Revised April 2013

Notice:

OMRON products are manufactured for use according to proper procedures by a qualified operator and only for the purposes described in this manual.

The following conventions are used to indicate and classify precautions in this manual. Always pay attention to the information provided with them. Failure to comply with the precautions can result in injury to people or damage to the product.

 DANGER	Indicates an imminently hazardous situation which, if not avoided, will result in death or serious injury.
 WARNING	Indicates a potentially hazardous situation which, if not avoided, could result in death or serious injury.
 Caution	Indicates an potentially hazardous situation which, if not avoided, may result in minor or moderate injury, or property damage.

OMRON Product References

All OMRON products are capitalised in this manual. The word “Unit” is also capitalised when it refers to an OMRON product, regardless of whether or not it appears in the proper name of the product.

The abbreviation “Ch,” which appears in some displays and on some OMRON products, often means “word” and is abbreviated “Wd” in documentation in this sense.

The abbreviation “PLC” means Programmable Logic Controller and is not used as an abbreviation for anything else.

Visual Aids

The following headings appear in the left column of the manual to help you locate different types of information.

Note	Indicates information of particular interest for efficient and convenient operation of the product.
1, 2, 3...	Indicates lists of one sort or another, such as procedures, checklists, etc.

©OMRON, 2001

All rights reserved. No part of this publication may be reproduced, stored in a retrieval system, or transmitted, in any form, or by any means, mechanical, electronic, photocopying, recording, or otherwise, without the prior written permission of OMRON.

No patent liability is assumed with respect to the use of the information contained herein. Moreover, because OMRON is constantly striving to improve its high-quality products, the information contained in this manual is subject to change without notice. Every precaution has been taken in the preparation of this manual. Nevertheless, OMRON assumes no responsibility for errors or omissions. Neither is any liability assumed for damages resulting from the use of the information contained in this publication.

Read and Understand this Manual

Please read and understand this manual before using the product. Please consult your OMRON representative if you have any questions or comments.

Warranty and Limitations of Liability

WARRANTY

OMRON's exclusive warranty is that the products are free from defects in materials and workmanship for a period of one year (or other period if specified) from date of sale by OMRON.

OMRON MAKES NO WARRANTY OR REPRESENTATION, EXPRESS OR IMPLIED, REGARDING NON-INFRINGEMENT, MERCHANTABILITY, OR FITNESS FOR PARTICULAR PURPOSE OF THE PRODUCTS. ANY BUYER OR USER ACKNOWLEDGES THAT THE BUYER OR USER ALONE HAS DETERMINED THAT THE PRODUCTS WILL SUITABLY MEET THE REQUIREMENTS OF THEIR INTENDED USE. OMRON DISCLAIMS ALL OTHER WARRANTIES, EXPRESS OR IMPLIED.

LIMITATIONS OF LIABILITY

OMRON SHALL NOT BE RESPONSIBLE FOR SPECIAL, INDIRECT, OR CONSEQUENTIAL DAMAGES, LOSS OF PROFITS OR COMMERCIAL LOSS IN ANY WAY CONNECTED WITH THE PRODUCTS, WHETHER SUCH CLAIM IS BASED ON CONTRACT, WARRANTY, NEGLIGENCE, OR STRICT LIABILITY.

In no event shall the responsibility of OMRON for any act exceed the individual price of the product on which liability is asserted.

IN NO EVENT SHALL OMRON BE RESPONSIBLE FOR WARRANTY, REPAIR, OR OTHER CLAIMS REGARDING THE PRODUCTS UNLESS OMRON'S ANALYSIS CONFIRMS THAT THE PRODUCTS WERE PROPERLY HANDLED, STORED, INSTALLED, AND MAINTAINED AND NOT SUBJECT TO CONTAMINATION, ABUSE, MISUSE, OR INAPPROPRIATE MODIFICATION OR REPAIR.

Application Considerations

SUITABILITY FOR USE

OMRON shall not be responsible for conformity with any standards, codes, or regulations that apply to the combination of products in the customer's application or use of the products.

At the customer's request, OMRON will provide applicable third party certification documents identifying ratings and limitations of use that apply to the products. This information by itself is not sufficient for a complete determination of the suitability of the products in combination with the end product, machine, system, or other application or use.

The following are some examples of applications for which particular attention must be given. This is not intended to be an exhaustive list of all possible uses of the products, nor is it intended to imply that the uses listed may be suitable for the products:

- Outdoor use, uses involving potential chemical contamination or electrical interference, or conditions or uses not described in this manual.
- Nuclear energy control systems, combustion systems, railroad systems, aviation systems, medical equipment, amusement machines, vehicles, safety equipment, and installations subject to separate industry or government regulations.
- Systems, machines, and equipment that could present a risk to life or property.

Please know and observe all prohibitions of use applicable to the products.

NEVER USE THE PRODUCTS FOR AN APPLICATION INVOLVING SERIOUS RISK TO LIFE OR PROPERTY WITHOUT ENSURING THAT THE SYSTEM AS A WHOLE HAS BEEN DESIGNED TO ADDRESS THE RISKS, AND THAT THE OMRON PRODUCTS ARE PROPERLY RATED AND INSTALLED FOR THE INTENDED USE WITHIN THE OVERALL EQUIPMENT OR SYSTEM.

PROGRAMMABLE PRODUCTS

OMRON shall not be responsible for the user's programming of a programmable product, or any consequence thereof.

Disclaimers

CHANGE IN SPECIFICATIONS

Product specifications and accessories may be changed at any time based on improvements and other reasons.

It is our practice to change model numbers when published ratings or features are changed, or when significant construction changes are made. However, some specifications of the products may be changed without any notice. When in doubt, special model numbers may be assigned to fix or establish key specifications for your application on your request. Please consult with your OMRON representative at any time to confirm actual specifications of purchased products.

DIMENSIONS AND WEIGHTS

Dimensions and weights are nominal and are not to be used for manufacturing purposes, even when tolerances are shown.

PERFORMANCE DATA

Performance data given in this manual is provided as a guide for the user in determining suitability and does not constitute a warranty. It may represent the result of OMRON's test conditions, and the users must correlate it to actual application requirements. Actual performance is subject to the OMRON Warranty and Limitations of Liability.

ERRORS AND OMISSIONS

The information in this manual has been carefully checked and is believed to be accurate; however, no responsibility is assumed for clerical, typographical, or proofreading errors, or omissions.

TABLE OF CONTENTS

PRECAUTIONS	xiii
1 Intended Audience	xiv
2 General Precautions	xiv
3 Safety Precautions.....	xiv
4 Operating Environment Precautions	xvi
5 Application Precautions	xvii
6 EC Directives	xix
SECTION 1	
Introduction	1
1-1 Features and Functions	2
1-2 Basic Configuration	5
1-3 Specifications and Characteristics.....	7
1-4 Quick Start Up Reference Guide	15
1-5 Operating Procedure Guidelines	21
1-6 Application Areas	24
SECTION 2	
Components, Installation and Wiring	25
2-1 Components and Switch Settings	26
2-2 Installation	30
2-3 Wiring	32
SECTION 3	
Operation and Configuration	45
3-1 Overview.....	46
3-2 Counter Types	47
3-3 Input Signal Types	56
3-4 Digital Input Functions	59
3-5 Output Control	65
3-6 Reset Signals	81
3-7 Extra Functions	83
SECTION 4	
Exchanging Data with CPU	93
4-1 Overview.....	94
4-2 Memory Allocation	97
4-3 IOWR-Instruction	116
4-4 IORD-Instruction	118
4-5 Supported IOWR/IORD-Instructions	120
4-6 Interrupts.....	128

TABLE OF CONTENTS

SECTION 5

Error Processing, Maintenance and Inspection 133

5-1	Error Indicators	134
5-2	Error codes	136
5-3	Maintenance and Inspection	142

SECTION 6

Application Examples 145

6-1	Flow Control	146
6-2	Length Measurement	149
6-3	Positioning	154
6-4	CAM-positioning	159
6-5	Speed Control	164

Appendices

A	Using Terminal Block Units with Screw-terminals	167
B	Assigning External Interrupt Tasks to Outputs	169
C	Description of the Response Time	171
D	Application Restrictions	173
E	IORF and IOWR/IORD-instruction Execution Times	175

Index 177

Revision History 183

About this Manual:

This manual describes the installation and operation of the CJ1W-CT021 High-speed Counter Unit and includes the sections described below. Please read this manual carefully and be sure you understand the information provided before attempting to install or operate the CJ1W-CT021 High-speed Counter Unit. **Be sure to read the precautions provided in the following sections.**

Section 1 introduces the CJ1W-CT021 High-speed Counter Unit and describes the features, functions, and specifications. It gives short instructions on how to operate the Units.

Section 2 provides information about components, wiring and installing the CJ1W-CT021 High-speed Counter Unit.

Section 3 provides information about the configuration and operation of the CJ1W-CT021 High-speed Counter Unit.

Section 4 provides information on the data-exchange and the communication interface between the CJ1W-CT021 High-speed Counter Unit and the CPU.

Section 5 provides details of the CJ1W-CT021 High-speed Counter Unit's errors, error -codes and indicators and guidelines for troubleshooting.

Section 6 provides sample programs, according to practical applications, that can be used with the CJ1W-CT021 High-speed Counter Unit.

The **Appendices** describe a comparison with C200H-CT021 High-speed Counter Unit, the numbering of Terminal Block Units, the numbering of External Interrupt Tasks to Outputs and a description of the Response Time.

All through this manual where a double word is defined as for instance "n+2, n+3" this must be interpreted as follows:

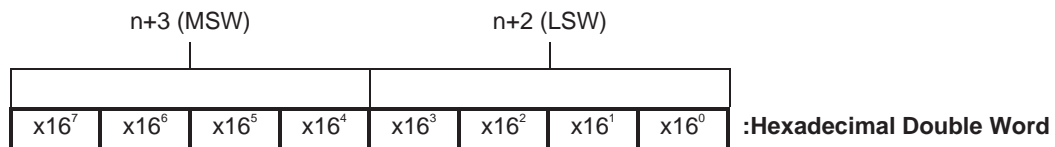
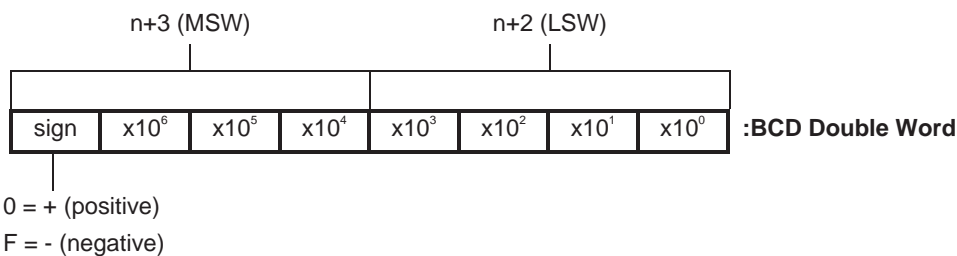

LSW = Least Significant Word
MSW = Most Significant word

 **WARNING**

Failure to read and understand the information provided in this manual may result in personal injury or death, damage to the product, or product failure. Please read each section in its entirety and be sure you understand the information provided in the section and related sections before attempting any of the procedures or operations given.

PRECAUTIONS

This section provides general precautions for using the Programmable Controller (PLC) and the High-speed Counter Unit.

The information contained in this section is important for the safe and reliable application of the High-speed Counter Unit. You must read this section and understand the information contained before attempting to set up or operate a High-speed Counter Unit and PLC system.

1	Intended Audience	xiv
2	General Precautions	xiv
3	Safety Precautions.....	xiv
4	Operating Environment Precautions.....	xvi
5	Application Precautions	xvii
6	EC Directives	xix

1 Intended Audience

This manual is intended for the following personnel, who must also have knowledge of electrical systems (an electrical engineer or the equivalent).

- Personnel in charge of installing FA systems.
- Personnel in charge of designing FA systems.
- Personnel in charge of managing FA systems and facilities.

2 General Precautions

The user must operate the product according to the performance specifications described in the operation manuals.

Before using the product under conditions which are not described in the manual or applying the product to nuclear control systems, railroad systems, aviation systems, vehicles, combustion systems, medical equipment, amusement machines, safety equipment, and other systems, machines, and equipment that may have a serious influence on lives and property if used improperly, consult your OMRON representative.

Make sure that the ratings and performance characteristics of the product are sufficient for the systems, machines, and equipment, and be sure to provide the systems, machines, and equipment with double safety mechanisms.

This manual provides information for installing and operating OMRON High-speed Counter Units. Be sure to read this manual before operation and keep this manual close at hand for reference during operation.

WARNING

It is extremely important that a PLC and all PLC Units be used for the specified purpose and under the specified conditions, especially in applications that can directly or indirectly affect human life. You must consult with your OMRON representative before applying a PLC system to the above mentioned applications.

3 Safety Precautions

WARNING

Never attempt to disassemble any Units while power is being supplied. Doing so may result in serious electronic shock.

WARNING

Never touch any of the terminals while power is being supplied. Doing so may result in serious electronic shock.

WARNING

Provide safety measures in external circuits (i.e., not in the Programmable Controller), including the following items, to ensure safety in the system if an abnormality occurs due to malfunction of the PLC unit. Not providing sufficient safety measures may result in serious accidents.

- Emergency stop circuits, interlock circuits, limit circuits, and similar safety measures must be provided in external control circuits.
- The PLC will turn OFF all outputs when its self-diagnosis function detects any error or when a severe failure alarm (FALS) instruction is executed. Unexpected operation, however, may still occur for errors in the I/O control section, errors in I/O memory, and other errors that cannot be detected by the self-diagnosis function. As a countermeasure for all such errors, external safety measures must be provided to ensure safety in the system.

- The PLC outputs may remain ON or OFF due to deposits on or burning of the output relays, or destruction of the output transistors. As a countermeasure for such problems, external safety measures must be provided to ensure safety in the system.
- When the 24-VDC output (service power supply to the PLC) is overloaded or short-circuited, the voltage may drop result in the outputs being turned OFF. As a countermeasure for such problems, external safety measures must be provided to ensure safety in the system.

⚠ WARNING

The CPU Unit refreshes I/O even when the program is stopped (i.e., even in PROGRAM mode). Confirm safety thoroughly in advance before changing the status of any part of memory allocated to I/O Units, Special I/O Units, or CPU Bus Units. Any changes to the data allocated to any Unit may result in unexpected operation of the loads connected to the Unit. Any of the following operation may result in changes to memory status.

- Transferring I/O memory data from a Programming Device to the CPU Unit.
- Changing present values in memory with a Programming Device.
- Force-setting/-resetting bits with a Programming Device.
- Transferring I/O memory files from a Memory Card or EM file memory to the CPU Unit.
- Transferring I/O memory from a host computer or from another PLC on a network.

⚠ WARNING

Do not attempt to take any Unit apart while the power is being supplied. Doing so may result in electric shock.

⚠ WARNING

Do not touch any of the terminals or terminal blocks while the power is being supplied. Doing so may result in electric shock.

⚠ WARNING

Do not attempt to disassemble, repair, or modify any Units. Any attempt to do so may result in malfunction, fire, or electric shock.

⚠ Caution

Execute online edit only after confirming that no adverse effects will be caused by extending the cycle time. Otherwise, the Input signals may not be readable.



⚠ Caution

Confirm safety at the destination node before transferring a program to another node or changing contents of the I/O memory area. Doing either of these without confirming safety may result in injury.

⚠ Caution

Tighten the screws on the terminal block of the AC Power Supply Unit to the torque specified in the operation manual. Loose screws may result in burning or malfunction.

4 Operating Environment Precautions

-  **Caution** Do not operate the control system in the following locations:
- Locations subject to direct sunlight.
 - Locations subject to temperatures or humidity outside the range specified in the specifications.
 - Locations subject to condensation as the result of severe changes in temperature.
 - Locations subject to corrosive or flammable gases.
 - Locations subject to dust (especially iron dust) or salts.
 - Locations subject to exposure to water, oil, or chemicals.
 - Locations subject to shock or vibration.
-  **Caution** Take appropriate and sufficient countermeasures when installing systems in the following locations:
- Locations subject to static electricity or other forms of noise.
 - Locations subject to strong electromagnetic fields.
 - Locations subject to possible exposure to radioactivity.
 - Locations close to power supplies.
-  **Caution** The operating environment of the PLC System can have a large effect on the longevity and reliability of the system. Improper operating environments can lead to malfunction, failure, and other unforeseeable problems with the PLC System. Be sure that the operating environment is within the specified conditions at installation and remains within the specified conditions during the life of the system.

5 Application Precautions

Observe the following precautions when using the High-speed Counter Unit or the PLC.



WARNING

Failure to comply with the following precautions could lead to serious or possibly fatal injury. Always follow these precautions.

- Always ground the system with 100 Ω or less when installing the system, to protect against electrical shock.
- Always turn OFF the power supply to the PLC before attempting any of the following. Performing any of the following with the power supply turned ON may lead to electrical shock:
 - Mounting or removing any Units (e.g., I/O Units, CPU Unit, etc.) or memory cassettes.
 - Assembling any devices or racks.
 - Connecting or disconnecting any connectors, cables or wiring.
 - Setting DIP switch or rotary switches.



Caution

Failure to comply with the following precautions could lead to faulty operation of the PLC or the system, or could damage the PLC or PLC Units. Always follow these precautions.

- Fail-safe measures must be taken by the customer to ensure safety in the event of incorrect, missing, or abnormal signals caused by broken signal lines, momentary power interruptions, or other causes.
- Interlock circuits, limit circuits, and similar safety measures in external circuits (i.e., not in the Programmable Controller) must be provided by the customer.
- If the IOM Hold Bit is turned ON, the outputs from the PLC will not be turned OFF and will maintain their previous status when the PLC is switched from RUN or MONITOR mode to PROGRAM mode. Make sure that the external loads will not produce dangerous conditions when this occurs. (When operation stops for a fatal error, including those produced with the FALS instruction, all outputs from Output Unit will be turned OFF and only the internal output status will be maintained.)
- Use the Units only with the power supplies and voltages specified in the operation manuals. Other power supplies and voltages may damage the Units.
- Take appropriate measures to ensure that the specified power with the rated voltage and frequency is supplied. Be particularly careful in places where the power supply is unstable. An incorrect power supply may result in malfunction.
- Install external breakers and take other safety measures against short-circuiting in external wiring. Insufficient safety measures against short-circuiting may result in burning.
- Do not apply voltages to Input sections in excess of the rated Input voltage. Excess voltages may result in burning.
- Do not apply voltages or connect loads in excess of the maximum switching capacity to output sections. Excess voltage or loads may result in burning.

 **Caution**

- Install the Units properly as specified in the operation manuals. Improper installation of the Units may result in malfunction.
- Be sure that all the mounting screws, terminal screws, and cable connector screws are tightened to the torque specified in the relevant manuals. Incorrect tightening torque may result in malfunction.
- Leave the label attached to the Unit when wiring. Removing the label may result in malfunction if foreign matter enters the Unit.
- Remove the label after the completion of wiring to ensure proper heat dissipation. Leaving the label attached may result in malfunction.
- Use crimp terminals for wiring. Do not connect bare stranded wires directly to terminals. Connection of bare stranded wires may result in burning.
- Double-check all the wiring and the connectors before turning ON the power supply. Incorrect wiring or bad connections may result in burning or malfunction.
- Be sure that the terminal blocks, Memory Units, expansion cables, and other items with locking devices are properly locked into place. Improper locking may result in malfunction.
- Check switch settings, the contents of the DM Area, and other preparations before starting operation. Starting operation without the proper settings or data may result in an unexpected operation.
- Check the user program for proper execution before actually running it on the Unit. Not checking the program may result in an unexpected operation.
- Confirm that no adverse effect will occur in the system before attempting any of the following. Not doing so may result in an unexpected operation.
 - Changing the operating mode of the PLC.
 - Force-setting/force-resetting any bit in memory.
 - Changing the present value of any word or any set value in memory.
- Do not pull on the cables or bend the cables beyond their natural limit. Doing either of these may break the cables.
- Do not place objects on top of the cables or other wiring lines. Doing so may break the cables.
- When replacing parts, be sure to confirm that the rating of a new part is correct. Not doing so may result in malfunction or burning.
- Before touching a Unit, be sure to first touch a grounded metallic object in order to discharge any static built-up. Not doing so may result in malfunction or damage.
- Do not touch circuit boards or the components mounted to them with your bare hands. There are sharp leads and other parts on the boards that may cause injury if handled improperly.
- Provide proper shielding when installing in the following locations:
 - Locations subject to static electricity or other sources of noise.
 - Locations subject to strong electromagnetic fields.
 - Locations subject to possible exposure to radiation.
 - Locations near power supply lines.
- Do not attempt to take any Units apart, to repair any Units, or to modify any Units in any way.
- After connecting Power Supply Units, CPU Units, I/O Units, Special I/O Units, or CPU Bus Units together, secure the Units by sliding the sliders at the top and bottom of the Units until they click into place. Correct operation may not be possible if the Units are not securely properly. Be sure to attach the end cover provided with the CPU Unit to the rightmost Unit. CJ-series PLCs will not operate properly if the end cover is not attached.

6 EC Directives

6-1 Applicable Directives

- EMC Directives
- Low Voltage Directive

6-2 Concepts

EMC Directives

OMRON devices that comply with EC Directives also conform to the related EMC standards so that they can be more easily built into other devices or the overall machine. The actual products have been checked for conformity to EMC standards (see the following note). Whether the products conform to the standards in the system used by the customer, however, must be checked by the customer.

EMC-related performance of the OMRON devices that comply with EC Directives will vary depending on the configuration, wiring, and other conditions of the equipment or control panel on which the OMRON devices are installed. The customer must, therefore, perform the final check to confirm that devices and the overall machine conform to EMC standards.

Note Applicable EMC (Electromagnetic Compatibility) standards are as follows:
EMS (Electromagnetic Susceptibility):EN61000-6-2
EMI (Electromagnetic Interference):EN50081-2
(Radiated emission: 10-m regulations)
Low Voltage Directive
Always ensure that devices operating at voltages of 50 to 1,000 VAC and 75 to 1,500 VDC meet the required safety standards for the PLC (EN61131-2).

6-3 Conformance to EC Directives

CJ-series Units conform to EC Directives. For the system to conform to EC Directives, however, the following precautions must be adhered to.

- 1, 2, 3...
1. CJ-series Units must be installed within control panels.
 2. Use reinforced insulation or double insulation for the DC power supplies used for the I/O power supplies.
 3. CJ-series Units that meet EC Directives also meet the Common Emission Standard (EN50081-2). The measure necessary to ensure that standards, such as the radiated emission standard (10-m), are met, however, will vary depending on the overall configuration of the control panel, the other devices connected to the control panel and wiring. You must therefore confirm that EC Directives are met for the overall machine or device.

SECTION 1

Introduction

This section gives specifications of the CJ1W-CT021 and a brief description of the functions and features of the Unit and the areas of application.

1-1	Features and Functions	2
1-2	Basic Configuration	5
1-3	Specifications and Characteristics	7
1-3-1	General Specifications	7
1-3-2	Functional Specifications	8
1-3-3	Input Specifications	11
1-3-4	Output Specifications	13
1-4	Quick Start Up Reference Guide	15
1-4-1	Configuring the High-speed Counter Unit	19
1-5	Operating Procedure Guidelines	21
1-6	Application Areas	24

1-1 Features and Functions

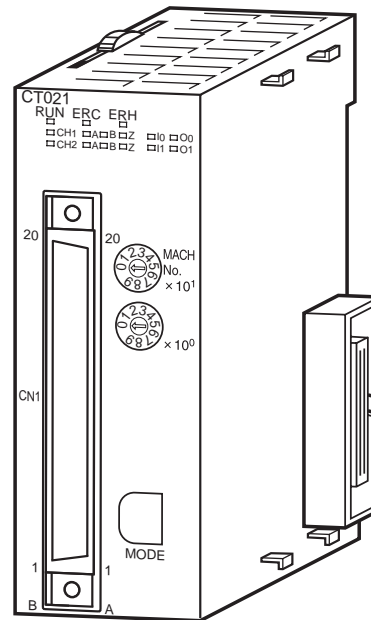

The CJ1W-CT021 High-speed Counter Unit is equipped with 2 Counters and counts over a maximum binary range of 32-bits. Accepting input pulse frequencies of up to 500 kHz allows precise control of fast motions. The Unit's bi-directional counting ability enables detecting movement in either direction. Each Counter of the Unit can be configured independently. The Unit is equipped with 2 Digital Inputs, 2 Digital Outputs and 30 Soft Outputs. A maximum response time of 0.5 ms guarantees high-speed closed loop control of applications.

Freely Configurable

The CJ1W-CT021, a Special I/O Unit for CJ-series PLC-systems, is a freely configurable High-speed Counter Unit. Depending on the requirements of your application, the specific behaviour of the Unit can be adjusted by changing the configuration settings.

Counter Type

Configuring the Unit starts with choosing one out of 3 Counter Types:

- Simple Counter (refer to 3-2-1 "*Simple Counter*")
- Circular Counter (refer to 3-2-2 "*Circular Counter*")
- Linear Counter (refer to 3-2-3 "*Linear Counter*")

By default all Counters are set to Simple Counter for which no configuration settings have to be made, enabling every Counter to count pulses directly after the Unit has been powered up. For all Counter Types the full counting range is available. Circular and Linear Counters can be fully (DM-) configured according to the application that is to be controlled.

Input Signal Type

Depending on the type of input signal that your application requires, for every Counter a choice can be made out of three input signal types:

- Phase Differential Inputs (multiplication by either 1, 2 or 4) (refer to 3-3-1 "*Phase Differential*")
- Up/Down Pulse Inputs (refer to 3-3-2 "*Up & Down*")
- Pulse & Direction Inputs (refer to 3-3-3 "*Pulse & Direction*")

Digital Input Function	<p>The Unit is equipped with 2 Digital Inputs (I0 and I1) that can be freely assigned to any Counter. To meet the requirements of your application every Digital Input can be configured according to one out of 17 available functions. The functions make it possible to use a Digital Input with Gate-, Preset-, Reset- or Capture Functionality (among other functions). Refer to 3-4 "Digital Input Functions".</p>
Digital Output Control	<p>To control the Outputs the Unit can be configured in one of the two following Output Control Modes:</p> <ul style="list-style-type: none">• Range Mode (refer to 3-5-1 "Range Mode")• Comparison Mode (refer to 3-5-2 "Comparison Mode") <p>In Range Mode, a configurable number of up to 32 Ranges can be applied to individual Counters. Every Range can control up to a maximum of 32 Outputs. An Output is turned ON when the Counter is in the corresponding Range. In Comparison Mode a configurable number of up to 32 Comparison Values can be applied to individual Counters. Depending on the direction of counting, an Output can be set or reset (configurable) on reaching the Comparison Value. Every Comparison Value can control up to maximum 32 Outputs.</p> <p>Furthermore Outputs can be controlled manually by setting/resetting PLC software bits (refer to 3-5-3 "Manual Output Control"). The Outputs can be configured to keep their last state or to have a predefined state, in case the PLC-state changes (RUN/MONITOR → PROGRAM), an I/O Bus error or an Overflow/Underflow error occurs. Additionally Outputs can be configured with an NPN- or PNP Output driver (refer to 3-5-4 "Output Control Configuration").</p>
Resetting Counter Value	<p>Resetting of the Counter Value can be freely configured depending on the application needs. The following sources can trigger a reset:</p> <ul style="list-style-type: none">• Software bit in the PLC• Z-Input• Digital Input (that is configured as a Reset Input) <p>To enable resetting a Counter Value, an external Digital Input can be configured as Enable Reset Input and/or the Software Enable Reset bit can be used (refer to 3-6 "Reset Signals").</p>
Programmable Output Pulses	<p>The timing characteristics of the Digital Outputs can be modified, depending on the requirements of the application as follows (refer to 3-7-1 "Programmable Output Pulses"):</p> <ul style="list-style-type: none">• Output Turn ON Delay [1 ms to 9999 ms], to delay turning ON an Output• Output Pulse Duration [1 ms to 9999 ms], to generate an Output pulse of the specified duration
Rate Measurement	<p>The ability, for every Counter, to measure the Rate of the incoming pulses within a predefined time-window [1ms to 9999 ms] enables measuring speeds and frequencies. Rate Measurement is executed as background calculation and can be enabled or disabled. For every Counter up to a maximum of 64 most recent Rate Values are available as a Rate History Log File (refer to 3-7-2 "Rate Measurement").</p>
Hysteresis	<p>For Counters in Range Mode a hysteresis can be configured [1 to 255 counts], to prevent Outputs from toggling due to unwanted oscillating of encoding equipment (e.g. rotary incremental encoder). Refer to 3-7-3 "Hysteresis".</p>

Noise Filtering	<p>For the purpose of suppressing noise on the signal lines A and B of every Counter and on the Digital Input lines noise filters can be used. A noise filter can be configured. The cut-off frequencies for the signal lines A and B can be set to:</p> <ul style="list-style-type: none">• 10 kHz• 50 kHz (default)• 500 kHz <p>For the Digital Inputs 10 kHz and 50 kHz (default) noise filters can be configured. Refer to 3-7-4 "Noise Filtering".</p>
Run-time Configurable	<p>Configuration settings of the Unit can be changed at Run-time by using the IOWR-instruction to be able to quickly adjust to changing application needs without the need of restarting the Unit or stopping the Counters. Care, however, must be taken when changing configuration settings. Refer to 3-5 "Output Control" for information.</p>
Interrupt Support	<p>All Outputs and Digital Inputs can be configured to generate interrupts to the PLC in order to have a minimal response time enabling fast control of applications. Generating interrupts is only possible when the High-speed Counter Unit is mounted on a CPU-backplane.</p>
Support Software	<p>The Unit can be configured by using CX-Programmer Support Software or a Programming Console.</p>
Quick Start Up Reference Guide	<p>For a quick overview of all the features and functions that the High-speed Counter Unit offers to you, refer to 1-4 "Quick Start Up Reference Guide". This section also contains references to the particular section(s) in the Manual where you can read more detailed information about specific features and functions of the High-speed Counter Unit.</p>

1-2 Basic Configuration

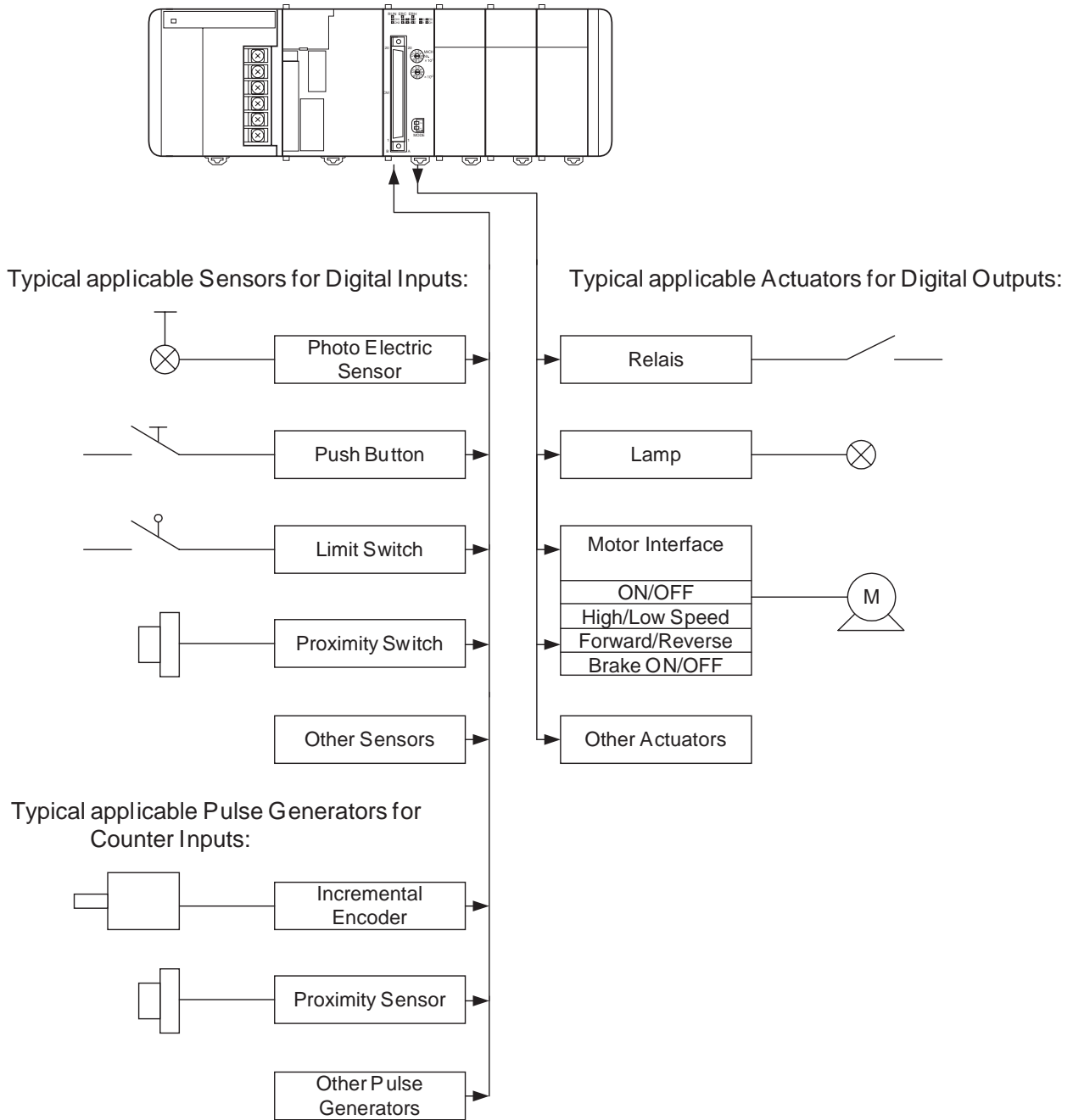

Mounting Restrictions

The CJ1W-CT021 High-speed Counter Unit is a Special I/O Unit belonging to the CJ Series.

A CJ1W-CT021 High-speed Counter Unit can be mounted to either a CJ CPU Rack or CJ Expansion Rack.

Note

If you want the CJ1W-CT021 High-speed Counter Unit to generate interrupts to activate external interrupt tasks in a CJ1-H CPU Unit, the Counter Unit must be in one of the five positions immediately to the right of the CJ1-H CPU Unit on the CPU Rack. If you want the High-speed Counter Unit to generate interrupts to activate external interrupt tasks in a CJ1M CPU Unit, the Counter Unit must be in one of the three positions immediately to the right of the CJ1M CPU Unit on the CPU

Rack.

No external interrupt tasks can be activated in CJ1-H or CJ1M CPU Units if the CJ1W-CT021 High-speed Counter Unit is in any other position (i.e., 6th Unit position or further away from the CJ1-H CPU Unit, or 4th Unit position or further away from the CJ1M CPU Unit), or if it is on a CJ-series Expansion Rack.

The maximum number of CJ1W-CT021 High-speed Counter Units that can be mounted to a CJ CPU Rack or CJ Expansion Rack is equal to the number of slots of the Rack. In a configuration with multiple Racks the maximum number of CJ1W-CT021 High-speed Counter Units is limited to 24 because the Unit is allocated 40 CIO-words and 400 DM-words in the Special I/O Unit Area.

Furthermore, the number of High-speed Counter Units that can be mounted to one Rack (i.e., a CPU Rack or Expansion Rack) depends on the maximum supply current from the Power Supply Unit that supplies the Rack and the current consumption of other Units on the Rack.

I/O Connection Methods

To connect the In- and Output signal wires to the Unit two methods are available:

1. Directly connecting the wires by soldering them to the external connector.
2. Indirectly connecting the wires by connecting them to screw terminals on a Terminal Block Unit. The Omron Terminal Block Unit (XW2B-40G4 or XW2B-40G5) is connected to the Unit via standard available Omron flat-cables (XW2Z-xxxB).

Refer to 2-3-2 "*Connector Wiring Methods*" for more details.

1-3 Specifications and Characteristics

1-3-1 General Specifications

Item	CJ1W-CT021
Unit type	CJ-series Special I/O Unit
General Specifications	Conform to general specifications for SYSMAC CJ-series
Ambient Operating Temperature	0 to 55 °C
Ambient Storage Temperature	-20 to 75 °C
Ambient Operating Humidity	10% to 90% without condensation
Internal Current Consumption	280 mA (at 5 V)
Dimensions (mm)	31 x 90 x 65 (W x H x D)
Weight	100 g
Mounting Position	CJ-series CPU Rack or CJ-series Expansion Rack (see notes 1 and 2.)
Maximum Number of CT021 Units per Rack	Equal to the number of slots of the Rack (see note 3)
Maximum Number of CT021 Units per basic CJ PLC	24
Data Exchange with CPU Unit	<ul style="list-style-type: none"> • I/O Refresh Data Area (CIO-bits 200000 to 255915, CIO-words 2000 to 2959): Note 4) • Special I/O Unit DM-Area (D-words 20000 to 29599): 400 DM-words per Unit are transmitted from the CPU to the Unit at Power Up or when the Unit is restarted (see note 5)

- Note**
1. The Unit must be in one of the five positions immediately to the right of the CJ1-H CPU Unit or in one of the three positions immediately to the right of the CJ1M CPU Unit to activate external interrupt tasks. No external interrupt tasks can be activated if the Unit is in any other position (i.e., 6th Unit position or further away from the CJ1-H CPU Unit, or 4th Unit position or further away from the CJ1M CPU Unit), or if it is on a CJ-series Expansion Rack.
 2. Use a Unit with lot number 030121 (unit version 1.06) or later to use the Unit with a CJ2 CPU Unit.
 3. The maximum number of Units per Rack is also depending on the maximum supply current of the Power Supply Unit and the current consumption of other Units on the Rack.
 4. The CJ1W-CT021 Special I/O Unit is allocated words for 40 words in the Special I/O Unit (CIO) Area (refer to 4-2-3 "*CIO-Memory Mapping*").
 5. The CJ1W-CT021 Special I/O Unit is allocated words for 4 Units in the Special I/O Unit DM Area. From the 400 DM words that are allocated, the first 113 words are used to make the DM-settings and the remaining 287 words can be used as work-words (refer to 4-2-4 "*DM-Memory Mapping*").

1-3-2 Functional Specifications

Item	CJ1W-CT021
Number of Counters	2
Counter Type	<ul style="list-style-type: none"> • Simple Counter (refer to 3-2-1 "Simple Counter") • Circular Counter (refer to 3-2-2 "Circular Counter") • Linear Counter (refer to 3-2-3 "Linear Counter") <p>The Counter Type can be chosen by DIP switch at the front of the Unit. By default the Counters are set to Simple Counter (refer to 2-1-3 "Counter Type Switch").</p>
Maximum Input Frequency	500 kHz, refer to 1-3-3 "Input Specifications" for details
Maximum Response Time	0.5 ms (refer to Appendix C "Description of the Response Time")
Signals per Counter	Phase A, B and Z
Digital I/O	<ul style="list-style-type: none"> • 2 Digital Inputs (I0 and I1): Every Digital Input can be assigned to a Counter. In this way one Counter can be controlled by a maximum of 2 Digital Inputs (refer to 3-4 "Digital Input Functions") • 2 Digital Outputs (O0 and O1): The Unit Output Pattern represents the 2 Digital Outputs and 30 Soft Outputs (refer to 3-5 "Output Control").
Input Signal Types	<ul style="list-style-type: none"> • Phase Differential (multiplication x1), (multiplication x2)^{*1} and (multiplication x4)^{*1} (refer to 3-3-1 "Phase Differential") • Up/Down^{*1} (refer to 3-3-2 "Up & Down") • Pulse & Direction^{*1} (refer to 3-3-3 "Pulse & Direction")
Counter Control using CIO- software bits	<ul style="list-style-type: none"> • Open Gate / Start Counter: Counter is enabled to count pulses • Close Gate / Stop Counter: Counter is disabled to count pulses • Preset Counter: Preset Value can be set in CIO • Reset Counter to zero • Capture Counter Value: Captured Counter Value can be read using IORD-instruction (refer to 4-5-3-1 "Captured Counter Value") <p>Refer to 3-4 "Digital Input Functions".</p>
Digital Input Functionality	<ul style="list-style-type: none"> • Gate^{*1} • Reset^{*1} • Preset^{*1} • Capture^{*1} • Stop/Capture-Continue^{*1} • Stop/Capture-Reset/Continue^{*1} • Capture/Reset^{*1} • Enable Reset^{*1} • Disable Reset^{*1} <p>For every Function the corresponding action can be triggered on a rising- or on a falling edge (refer to 3-4 "Digital Input Functions").</p>
Output Control Mode	<ul style="list-style-type: none"> • Automatic Output Control in: <ul style="list-style-type: none"> • Range Mode^{*1} (Refer to 3-5-1 "Range Mode") • Comparison Mode^{*1} (Refer to 3-5-2 "Comparison Mode") • Rate Range • Manual Output Control (Refer to 3-5-3 "Manual Output Control")

Item	CJ1W-CT021
Output State Control	<p>On changing the Operating Mode of the PLC from RUN/MONITOR → PROGRAM, an I/O Bus Error or an Overflow/Underflow Error, the Digital Outputs can be configured to:</p> <ul style="list-style-type: none"> • Continue automatic updating Output States • Freeze Output States*¹ • Predefine Output States*¹ <p>Refer to 3-5-4 "Output Control Configuration".</p>
Output Driver Configuration	<p>The Output Driver of every Digital Output can be configured as:</p> <ul style="list-style-type: none"> • NPN • PNP*¹ <p>Refer to 3-5-4 "Output Control Configuration".</p>
Reset Signals	<p>Every Counter can be reset to zero by (a combination of) the following sources:</p> <ul style="list-style-type: none"> • Software Counter Reset Bit • Digital Input*¹ • Z-Input*¹ <p>Refer to 3-6 "Reset Signals".</p>
Extra Functions	<ul style="list-style-type: none"> • Programmable Output Pulse*¹: To every Digital Output an ON-delay and/or a Pulse Duration [1, 9999 ms] can be applied (refer to 3-7-1 "Programmable Output Pulses") • Rate Measurement*: For every Counter the Pulse Rate can be measured by defining a Time-Window [1, 9999 ms]. Up to a maximum of 64 Rate Values are stored in the Rate History Log File. Rate Values from the Rate History Log File can be read using the IORD-instruction. Additionally for every Counter two Rate Ranges can be defined that control the Outputs according to the measured Rate Value. Refer to 3-7-2 "Rate Measurement". • Hysteresis*¹: To prevent Outputs from being switched On and Off by very small fluctuations in the Counter Value around Range Limits, for every Counter an Hysteresis-value [1, 255] can be defined (the Unit must in Range Mode). Refer to 3-7-3 "Hysteresis".
Noise Filtering Counter Inputs and Digital Inputs	<p>To suppress noise on the signal lines of the Counter Inputs (A and B) and the Digital Inputs (I0 and I1) a Noise Filter can be configured:</p> <ul style="list-style-type: none"> • 10 kHz*¹ • 50 kHz (default) • 500 kHz*¹ <p>For the Digital Inputs the 500 kHz filter can not be selected. The Z-Input Signals of every Counter are filtered with a fixed Noise Filter of 1 kHz. Refer to 3-7-4 "Noise Filtering".</p>
Initial Counter Value	<ul style="list-style-type: none"> • The Initial Counter Value*¹ is transferred to the Unit when the Unit is Powered Up or Restarted. The Initial Counter Value is very useful to overcome problems in case of power failure. Refer to 3-7-5 "Initial Counter Value".

Item	CJ1W-CT021
IORD- and IOWR-instructions	Run-time ^{*3} configuration and operation of the High-speed Counter Unit is possible by using IORD- and IOWR-instructions. The following data can be read or written: <ul style="list-style-type: none"> • DM-configuration data^{*1} (refer to 4-5-1 "DM-data") • Range- and Comparison Data^{*1} (refer to 4-5-2 "Range- and Comparison data") • Captured Counter Value (refer to 4-5-3-1 "Captured Counter Value") • Rate History Log File Data^{*1} (refer to 4-5-3-2 "Rate History Log File data") • Counter Value (refer to 4-5-3-3 "Counter Value") • (Re) Configure High-speed Counter Unit^{*1} (refer to 4-5-3-4 "(Re) Configure Unit") • Error Clear (refer to 4-5-3-5 "Error Clear Command")
Interrupts of Outputs	<ul style="list-style-type: none"> • The Digital Outputs and the Soft Outputs of the Unit Output Pattern can all be configured to generate interrupts to the CJ1-H/CJ1M CPU Unit^{*1}. Refer to 4-6-1 "Outputs Generating Interrupts".^{*2}
Interrupts of Digital Inputs	<ul style="list-style-type: none"> • The Digital Inputs can all be configured to generate interrupts to the CJ1-H/CJ1M CPU Unit^{*1}. Refer to 4-6-2 "Digital Inputs Generating Interrupts".^{*2}
Error History Log Function	<ul style="list-style-type: none"> • Stores up to 30 error log records (refer to 5-2 "Error codes")

^{*1} This specification item is only supported for Circular and Linear Counters (not for Simple Counters). For a complete overview of the differences between Simple and Circular/Linear Counters refer to 1-4 "Quick Start Up Reference Guide".

^{*2} To activate external interrupt tasks, a CJ1-H or CJ1M CPU Unit must be used. CJ1 CPU Units do not support external interrupt tasks. To activate external interrupt tasks in a CJ1-H CPU Unit, the CJ1W-CT021 High-speed Counter Unit must be in one of the five positions immediately to the right of the CJ1-H CPU Unit. For CJ1M CPU Units, the CJ1W-CT021 High-speed Counter Unit must be in one of the three positions immediately to the right of the CJ1M CPU Unit. No external interrupt tasks can be activated if the Unit is in any other position (i.e., 6th Unit position or further away from the CJ1-H CPU Unit, or 4th Unit position or further away from the CJ1M CPU Unit), or if it is on a CJ-series Expansion Rack.

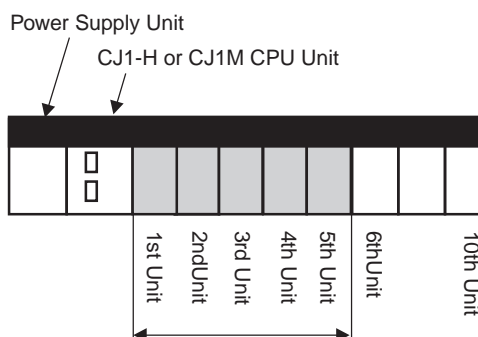

For CJ1-H CPU Units: External interrupt tasks can be activated only from these Units.

For CJ1M CPU Units: External interrupt tasks can be activated only from these Units.

*3 If an IOWR- or IORD-instruction is used during operation, comparison will stop during instruction execution. Care must be taken, therefore, with the timing of executing instructions. (Refer to 3-5 "Output Control" for details.)

1-3-3 Input Specifications

Item	Counter Inputs A and B				Digital Inputs (I0 and I1)
				Line Driver	
Input Voltage	24 VDC (19.6 to 26.4 V)	12 VDC (9.8 to 13.2 V)	5 VDC (4.5 to 5.5 V)	Line Driver	24 VDC (19.6 to 26.4 V)
Input Current (typical)	8 mA	8 mA	7 mA	11 mA	7.6 mA
ON Voltage (min.)	19.6 V	9.8 V	4.5 V	2.5 V	19.6 V
OFF Voltage (max.)	4 V	2.5 V	1.5 V	0.5 V	4 V

Item	Counter Input Z			
				Line Driver
Input Voltage	24 VDC (18.6 to 26.4 V)	12 VDC (9.8 to 13.2 V)	5 VDC (4.5 to 5.5 V)	Line Driver
Input Current (typical)	7.3 mA	6.6 mA	6 mA	11 mA
ON Voltage (min.)	18.6 V	9.8 V	4.5 V	2.5 V
OFF Voltage (max.)	4 V	2.5 V	1.5 V	0.5 V

- Note**
1. The Counter Inputs (A, B, Z) are insulated from each other and from the Digital Inputs. The Digital Inputs are also insulated from each other. All Counter Inputs and Digital Inputs are reverse polarity protected and insulated from the I/O-bus.
 2. A noise filter can be configured (10 kHz or 50 kHz (default)) for the Digital Inputs. Every Z-Input has a defined noise filter of 1 kHz.
 3. If the 50-kHz noise filter is configured for External Control Inputs, signals of 10 μ s or longer can be read.

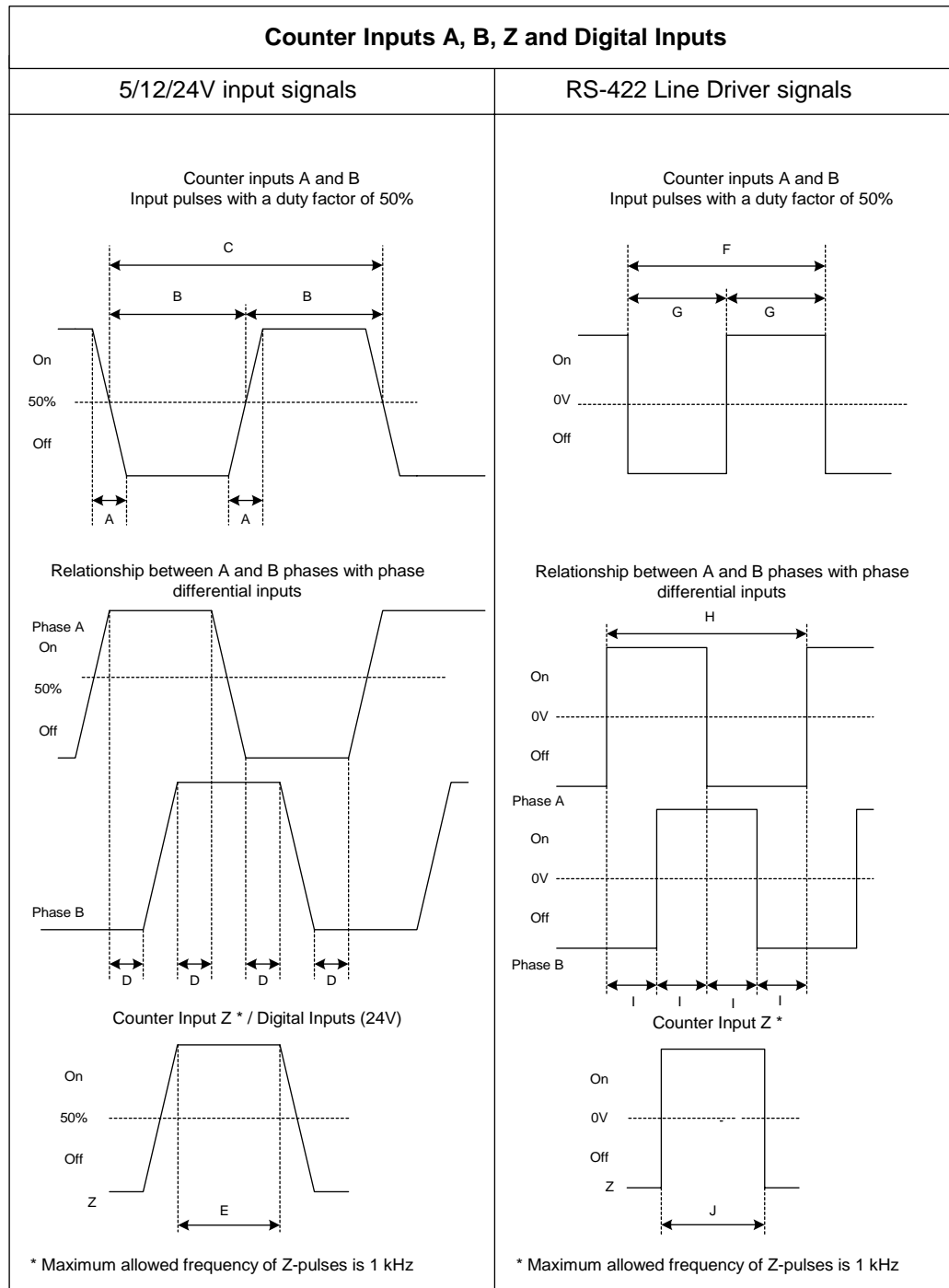

Filter Selection	Timing requirement [μs]									
	A	B	C	D	E	F	G	H	I	J
10 kHz	<3	>50	>100	>23	>10	>100	>50	>100	>23	>10
50 kHz	<3	>10	>20	>4.5	>10	>20	>10	>20	>4.5	>10
500 kHz	Do not use.				>10	>2	>1	>4	>1	>10

Note As a general guideline it can be stated that if you want the timing requirements for the Counter Inputs to satisfy the above mentioned specifications, you must pay attention to the type of output driver of the encoder being used, the length of the encoder cable and the frequency of the count pulses generated. For example, if

you use an Open Collector encoder (e.g. E6B2-CWZ6C) at 24 V with 10 m cable, you can typically generate count pulses up to 20 kHz. Therefore, if you want to generate count pulses with higher frequencies, you should use a different type of encoder (e.g. E6B2-CWZ1X with Line Driver output) or reduce the length of the encoder cable.

1-3-4 Output Specifications

Item	Specification
Driver Type	Open Collector (NPN/PNP selectable)
Operating Voltage Range	12-24 V (10.2 to 26.4 V) 30 mA max. at 26.4 VDC (for PNP output, without load current)
Maximum Switching Capacity	46 mA at 10.2 V to 100 mA at 26.4 V (200 mA maximum/common) (see picture below)
Minimum Switching Current	5 mA
Output ON-delay	100 μ s max.
Output OFF-delay	100 μ s max.
Leakage Current	0.1 mA max.
Residual Voltage	1.5 V max.
Short Circuit Protection	No

- Note**
1. Every Digital Output has 2 Output drivers available: NPN and PNP (available as separate pins on the front connectors). Every Output can be separately (DM-) configured for NPN or PNP. By default the Outputs are configured as NPN-output (refer to 3-5-4 "Output Control Configuration").
 2. The Digital Outputs are insulated from the I/O-bus but not from each other. They are not short circuit protected.
 3. The Output current must not exceed 200 mA per common (i.e. per 2 Digital Outputs) otherwise the unit will be damaged.
 4. The Outputs can be automatically or manually controlled (DM-setting) by using Force ON/OFF bits in CIO (refer to 3-5 "Output Control").
 5. The state control of the Outputs, in case the operating mode of the PLC-CPU is changed from RUN/MONITOR → PROGRAM, an I/O Bus error or an Overflow/Underflow error occurs, can be configured (refer to 3-5-4 "Output Control Configuration").

Maximum Switching Capacity

The maximum switching current depends upon the power supply voltage, as shown below.

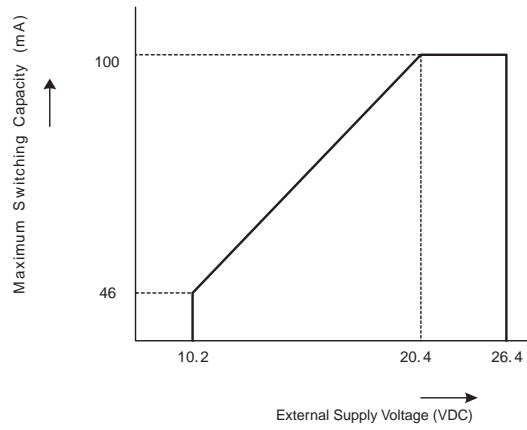

1-4 Quick Start Up Reference Guide

Operation and Configuration

Every Counter of the High-speed Counter Unit can be configured as Simple, Circular or Linear Counter (refer to the section 1-5 "Operating Procedure Guidelines" for quick start up information).

Counters configured as Circular/Linear Counter can use all the functions and features that the Unit offers to you, while Counters configured as Simple Counter only offer you a limited subset instead. The diagram below shows you all the functional blocks that the Unit has available to you to operate and configure the Unit (refer to SECTION 3 "Operation and Configuration"). The numbers in grey refer to the table on page 16 to indicate which functions are supported for Simple Counters and which functions for Circular/Linear Counters.

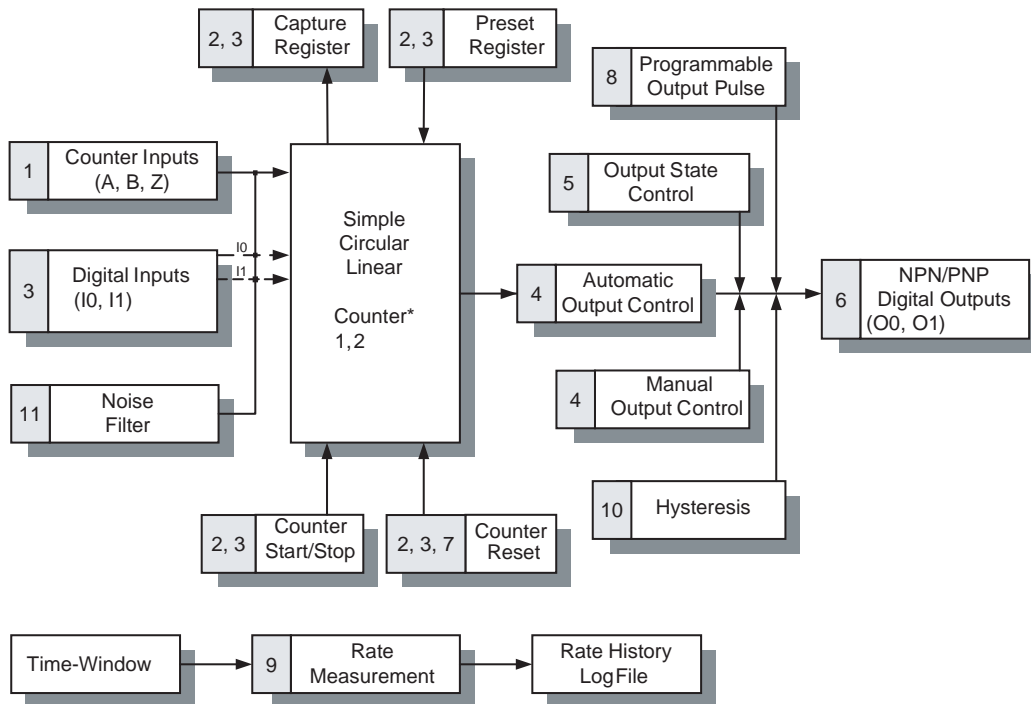

* Diagram is valid for Counter 1 and 2.

Exchanging data with CPU

The diagram below shows you all the functional blocks that the Unit has available to you to exchange data with the CPU (refer to SECTION 4 "Exchanging Data with CPU").

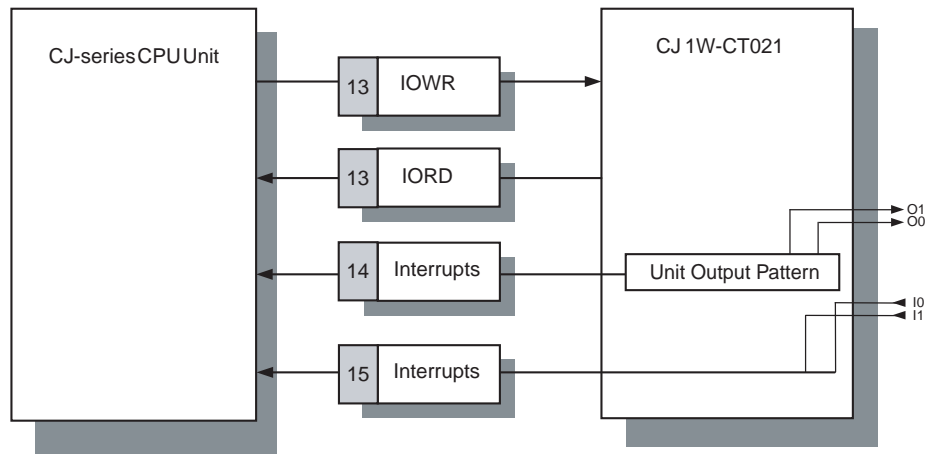

Simple Counter		Circular / Linear Counter	Reference section
1	Input Signal Types		3-3
	<ul style="list-style-type: none"> Phase Differential (x1) (=default) 	<ul style="list-style-type: none"> Phase Differential (x1, x2, x4) Up & Down Pulse & Direction 	3-3-1 3-3-2 3-3-3
2	Counter Control using CIO-software bits		3-4
	<ul style="list-style-type: none"> Open Gate / Start Counter Close Gate / Stop Counter Preset Counter Reset Counter Capture Counter Value 	<ul style="list-style-type: none"> Open Gate / Start Counter Close Gate / Stop Counter Preset Counter Reset Counter Capture Counter Value 	3-4
3	Digital Input Functions		3-4
	<ul style="list-style-type: none"> No Function (=default) 	<ul style="list-style-type: none"> No Function Gate Positive Gate Negative Preset Rising Edge Preset Falling Edge Reset Rising Edge Reset Falling Edge Capture Rising Edge Capture Falling Edge Stop, Capture and Continue Stop, Capture and Continue (inverted) Stop, Capture, Reset and Continue Stop, Capture, Reset and Continue (inverted) Capture-Reset Rising Edge Capture-Reset Falling Edge Enable Reset Disable Reset 	3-4
4	Output Control		3-5
		<ul style="list-style-type: none"> Automatic Output Control in: <ul style="list-style-type: none"> Range Mode Comparison Mode 	3-5-1 3-5-2
	<ul style="list-style-type: none"> Manual Output Control 	<ul style="list-style-type: none"> Manual Output Control 	3-5-3
5	Output State Control		3-5-4
	<ul style="list-style-type: none"> No (=default) 	<ul style="list-style-type: none"> Yes 	3-5-4
6	Output Driver Configuration		3-5-4
	<ul style="list-style-type: none"> NPN (=default) 	<ul style="list-style-type: none"> NPN PNP 	3-5-4

Simple Counter		Circular / Linear Counter	Reference section
7	Reset Signals		3-6
	<ul style="list-style-type: none"> • Software Reset Bit 	<ul style="list-style-type: none"> • Software Reset Bit • Digital Input • Z-signal 	3-6
8	Programmable Output Pulses		3-7-1
	<ul style="list-style-type: none"> • No (=default) 	<ul style="list-style-type: none"> • Yes 	3-7-1
9	Rate Measurement		3-7-2
	<ul style="list-style-type: none"> • No (=default) 	<ul style="list-style-type: none"> • Yes 	3-7-2
10	Hysteresis		3-7-3
	<ul style="list-style-type: none"> • No (=default) 	<ul style="list-style-type: none"> • Yes 	3-7-3
11	Noise Filtering Digital Inputs and Counter Inputs		3-7-4
	<ul style="list-style-type: none"> • 50 kHz (=default) 	<ul style="list-style-type: none"> • 10 kHz • 50 kHz • 500 kHz *¹ 	3-7-4
12	Initial Counter Value		3-7-5
	<ul style="list-style-type: none"> • No (=default) 	<ul style="list-style-type: none"> • Yes 	3-7-5
13	Supported IORD / IOWR-instructions to read / write		4-5
	<ul style="list-style-type: none"> • Captured Counter Value • Counter Value • Error Clear 	<ul style="list-style-type: none"> • DM-data 	4-5-1
		<ul style="list-style-type: none"> • Range- and Comparison Data 	4-5-2
		<ul style="list-style-type: none"> • Captured Counter Value 	4-5-3-1
		<ul style="list-style-type: none"> • Rate History Log File data 	4-5-3-2
		<ul style="list-style-type: none"> • Counter Value 	4-5-3-3
		<ul style="list-style-type: none"> • (Re) Configure Unit 	4-5-3-4
		<ul style="list-style-type: none"> • Error Clear 	4-5-3-5
14	Interrupts of Outputs		4-6-1
	<ul style="list-style-type: none"> • No*² (=default) 	<ul style="list-style-type: none"> • Yes 	4-6-1
15	Interrupts of Digital Inputs		4-6-2
	<ul style="list-style-type: none"> • No*³ (=default) 	<ul style="list-style-type: none"> • Yes 	4-6-2

*¹ The 500 kHz filter can only be configured for the Counter Inputs (not for the Digital Inputs).

*² If in a mixed configuration of Simple/Circular/Linear Counters one or more of the Digital Outputs have been configured to have Interrupt functionality, then this functionality is applied to the Outputs, both if they are controlled manually as well as automatically.

*³ If in a mixed configuration of Simple/Circular/Linear Counters one or more of the Digital Inputs have been configured to have Interrupt functionality, then this functionality is applied to the Inputs on a rising or falling edge depending on the Digital Input Function for which the Digital Inputs have been configured.

1-4-1 Configuring the High-speed Counter Unit

Configuration Configuring every Counter starts with choosing the Counter Type (Simple, Circular or Linear).

Simple Counter For Simple Counters you do not have to make any DM-configuration settings, since for Simple Counters all default (DM-) settings are used. You can choose to use Simple Counters if you intend to use the Counter only with basic counting functionality (refer to 3-2-1 "*Simple Counter*" for details and to 1-5 "*Operating Procedure Guidelines*" for a quick start up procedure)

Circular/Linear Counter If you want to use the full available functionality for a Counter, you must configure it for Circular or Linear Counter (refer to 3-2-2 "*Circular Counter*" and 3-2-3 "*Linear Counter*" for details and to 1-5 "*Operating Procedure Guidelines*" for a quick start up procedure).

Next the Input Signal Type (Phase Differential, Up/Down, or Pulse & Direction) for every Counter has to be defined. Depending on the requirements of the application one or more (maximum 2) Digital Inputs can be assigned to a Counter. To configure the Digital Input(s) a choice can be made out of 17 available modes (e.g. Gate, Enable Reset or Combination Modes, see 3-4 "*Digital Input Functions*"). During operation of the Counter, the Counter can be Started, Stopped, Reset, Captured or Preset by using the Digital Input(s) or the corresponding bits in CIO.

Controlling the Outputs is done by choosing the Output Control Mode (Range or Comparison Mode). Furthermore 4 additional control mechanisms are available to control the Outputs (Programmable Output Pulse, Output State Control, Manual Control and Hysteresis). Refer to 3-5 "*Output Control*".

In case the Counter Input Signals (A, B, Z) and the Digital Input Signals (I0 to I1) are exposed to electromagnetic noise, a noise filter can be configured (10 kHz, 50 kHz (=default) or 500 kHz) to suppress this noise. The 500 kHz noise filter is only available for the Counter Input Signals and not for the Digital Input Signals. Refer to 3-7-4 "*Noise Filtering*".

As background calculation, executed in parallel to operating the Counters, Rate Measurement can be configured by choosing the appropriate Time-Window [1 to 9999 ms]. The calculated Rate Values are stored in the corresponding Rate History Log File inside the Unit and can be retrieved by issuing an IORD-command from the PLC Ladder Program. Rate Measurement can be enabled/disabled for every Counter. Refer to 3-7-2 "*Rate Measurement*".

Indirect Addressing for Circular and Linear Counters

The CJ1W-CT021 High-speed Counter Unit is allocated 400 DM-words in the Special I/O Unit DM-Area and a block of 40 CIO-words in the Special I/O Unit Area of the PLC. The configuration of the Unit is done by making the appropriate DM-settings in the Special I/O Unit DM-Area that is allocated to the Unit.

The Special I/O Unit DM-Area is divided in an area of 30 words to make the General Unit Settings and 2 blocks of 45 DM-words each to make the Counter Specific Settings, which are unique for every Counter. The remaining 287 words of the 400 DM-words can be used as work-words in the PLC Ladder Program.

Depending on the Output Control Mode, Counter Range or Comparison Data can be set. Like this, for every Counter, up to a maximum of 32 Ranges or Comparison Values can be assigned. You can set the Range or Comparison Data in a part of DM or EM which is not being used. If you only intend to use a limited number of Ranges or Comparison Values then it is also possible to use the work-words of the Special I/O Unit DM-Area to store the Range or Comparison Data (287 work-words for the CT021 are available). Therefore, at the end of every block with Counter Specific Settings, you can specify an Indirect Address. This Indirect Address points to the actual memory location where the Range- or Comparison Settings of that specific Counter are stored.

For a detailed description about the CIO- and DM-Memory Allocation refer to 4-2 "*Memory Allocation*".

Note During operation of the Unit, for Circular and Linear Counters run-time configuration is possible by using the IOWR-instruction from the PLC Ladder Program (refer to 4-5 "*Supported IOWR/IORD-Instructions*"). Additionally, the Digital Inputs and Outputs can be configured to generate interrupts to the PLC by setting the appropriate Interrupt Masks in DM. (refer to 4-6 "*Interrupts*")

1-5 Operating Procedure Guidelines

The DIP switch at the front of the Unit can be used to operate every Counter as Simple Counter or as Circular/Linear Counter. Setting the DIP switch in the appropriate position defines the Counter Type.

The Operation Procedure Guidelines consists of 5 steps. In step 1 of the Operating Procedure Guidelines for every Counter the Type has to be set with the DIP switch into one of the following configurations:

Configuration 1	All Counters as Simple Counter
Configuration 2	All Counters as Circular/Linear Counter
Configuration 3	Mixed configuration of Simple/Circular/Linear Counters

Next you must execute step 2, 3, 4, and 5. Once the I/O table is created in step 5, the Unit must be configured if you have chosen for Configuration 2 or 3. If you have chosen for Configuration 1 the Unit is ready to operate. Consequently guidelines to be followed after step 5 will depend on the Configuration made in step 1.

Setting Counter Type

1, 2, 3...

1. Set the Counter Type for every Counter at the front of the Unit. Pins 1 and 2 correspond to Counters 1 and 2. Refer to 2-1-3 "Counter Type Switch" for further details.

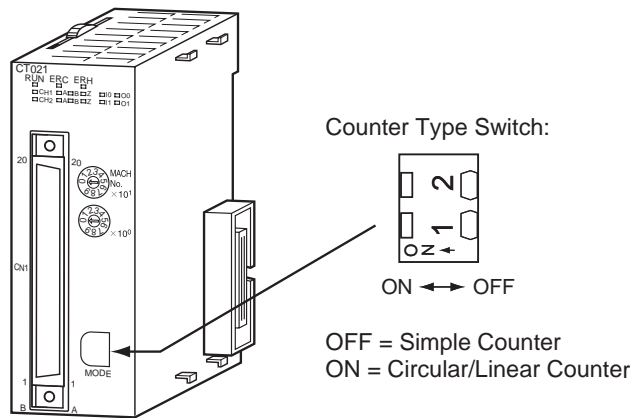

2. Set the Machine Number. Refer to 2-1-4 "Machine Number Switch" for further details.

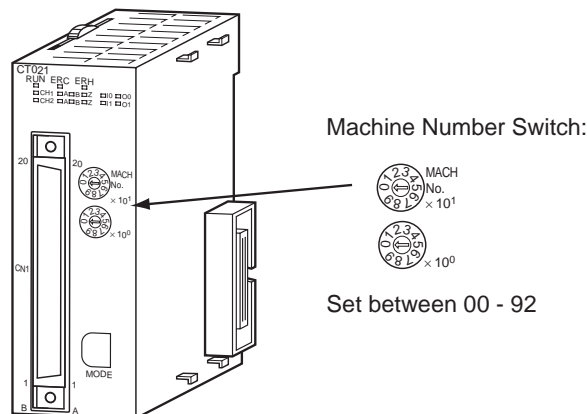

3. Install and wire the Unit. Refer to 2-2 "Installation" and 2-3 "Wiring" for further details.

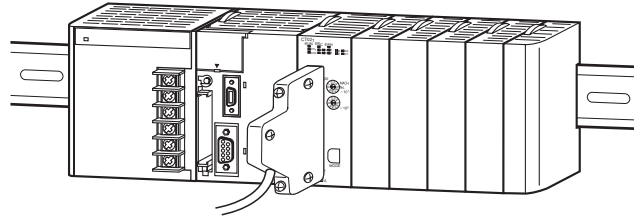

4. Turn ON the Power to the PLC.

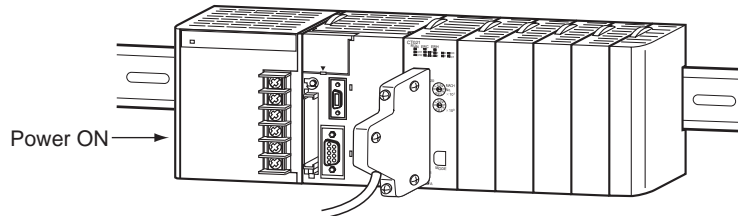

5. Create the I/O table. The I/O table can be created by using CX-Programmer Support Software or a Programming Console.

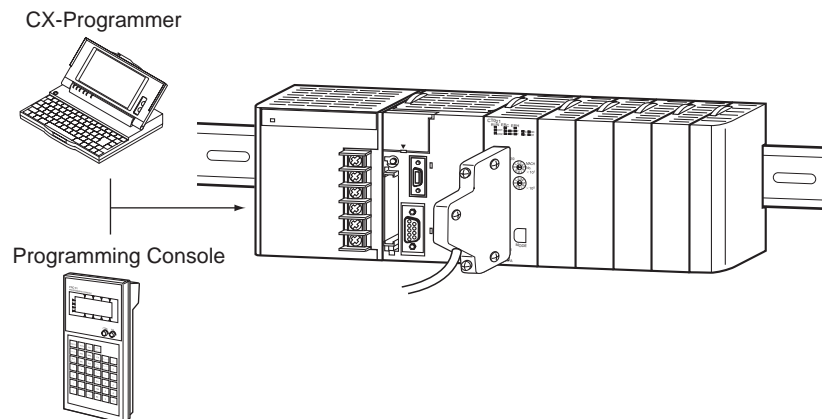

Unit Configuration

After the I/O table is created in step 5, you have to configure the Unit if you have chosen for Configuration 2 or 3 in step 1. Configuration is done by making the appropriate DM-settings. The Unit can be configured by using CX-Programmer Support Software or a Programming Console. Two Programming Consoles can be used with the CJ-series CPU Units: the C200H-PRO27-E and the CQM1-PRO01-E. CS1W-KS001 Key Sheet must be used for both.

Depending on the Configuration (1, 2 or 3) that you specified in step 1, you should continue with the corresponding step of the configuration-process:

Configuration 1

1, 2, 3...

All Counters as Simple Counters:

1. No (DM-) configuration settings can be made. The Unit is ready to count and will use all default DM-values. All data related to the Simple Counter is now being exchanged between the PLC and the Unit in CIO-memory and available for usage in the PLC Ladder Program.
2. Create and RUN a Ladder Program in the PLC. Refer to SECTION 4 "Exchanging Data with CPU" for details on the interface between the High-speed Counter Unit and the CPU. Section 6-1 "Flow Control" describes an application example using the Simple Counter.

Refer to 3-2-1 "Simple Counter" for more details about the Simple Counter.

Configuration 2**1, 2, 3...**

All Counters as Circular or Linear Counter:

1. Every Counter can now be separately (DM-) configured. For this purpose you can use a Programming Console or CX-Programmer Support Software. The configuration of the Counter Type (Linear or Circular Counter) is done by DM-setting. Refer to SECTION 3 "Operation and Configuration" for detailed information about configuring the Unit.
2. Power up the PLC again or turn the Special I/O Unit Restart Bit to ON (to transfer the DM-settings). All data related to Circular /Linear Counters is now being exchanged between the PLC and the Unit in CIO-memory and available for usage in the Ladder Program.
3. Create and RUN a Ladder Program in the PLC. Refer to SECTION 4 "Exchanging Data with CPU" for details on the interface between the CJ-series High-speed Counter Unit and the CPU. Refer to sections 6-2 to 6-5 for application examples using Circular and Linear Counters.

Refer to 3-2-2 "Circular Counter" and 3-2-3 "Linear Counter" for more details about both Counter Types. Refer to 4-1-2 "Special I/O Units Restart bits" for more information about restarting the Unit.

Configuration 3**1, 2, 3...**

Mixed Configuration Simple/Circular/Linear Counters:

1. Every Counter that has been set to Circular/Linear Counter can now be (DM-) configured. For this purpose you can use a Programming Console or CX-Programmer Support Software. The configuration of the Counter Type (Linear or Circular Counter) is done by DM-setting. Refer to SECTION 3 "Operation and Configuration" for detailed information about configuring the Unit. For the Counters that have been configured for Simple Counter no (DM-) configuration has to be done since the default (=0000) DM-settings are used for these Counters.
2. Power up the PLC again or turn the Special I/O Unit Restart Bit to ON (to transfer the DM-settings). All data related to Circular/Linear Counters is now being exchanged between the PLC and the Unit in CIO-memory and available for usage in the PLC Ladder Program.
3. Create and RUN a Ladder Program in the PLC. Refer to SECTION 4 "Exchanging Data with CPU" for details on the interface between the High-speed Counter Unit and the CPU. Refer to sections 6-2 to 6-5 for application examples using Circular and Linear Counters.

Refer to 3-2-1 "Simple Counter", 3-2-2 "Circular Counter" and 3-2-3 "Linear Counter" for more details about the Counter Types. Refer to 4-1-2 "Special I/O Units Restart bits" for more information about restarting the Unit.

Note

For using Simple Counters you do not have to clear the corresponding DM-settings to zero (=0000), since the Unit does not use this information and always uses the default (=0000) settings.

1-6 Application Areas

The main application areas of the High-speed Counter Unit is where signals with high frequencies are counted and high-speed responses have to be triggered at predefined Counter Values. Application areas include:

- Packaging and Sorting plants
- Dosing or proportioning plants
- Process Industry

Typical applications in which the CJ1W-CT021 can be used:

- (CAM)-Positioning (refer to 6-3 "Positioning" and 6-4 "CAM-positioning")
- Position Monitoring
- Length Measurement (refer to 6-2 "Length Measurement")
- Speed Control (refer to 6-5 "Speed Control")
- Flow Control (refer to 6-1 "Flow Control")
- Energy Measurement

SECTION 6 "Application Examples" describes typical application examples in which the High-speed Counter can be used, including sample ladder programs.

Section 6-2 "Length Measurement", for example, describes the following application:

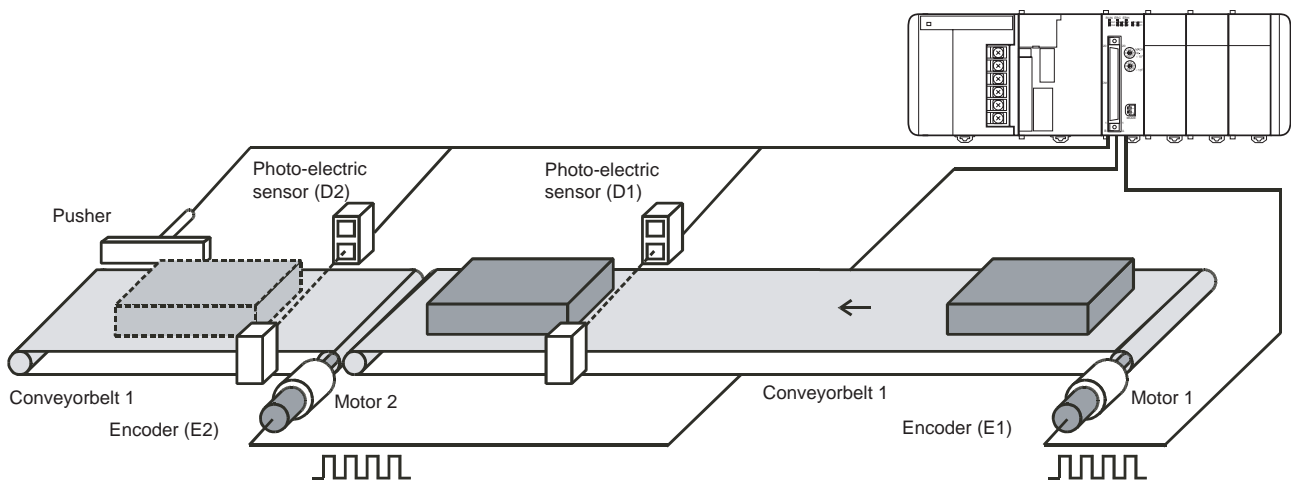

SECTION 2

Components, Installation and Wiring

This section provides details of the components, switch settings and other information required to install and operate CJ1W-CT021 High-speed Counter Units.

2-1	Components and Switch Settings	26
2-1-1	Components	26
2-1-2	Indicators	27
2-1-3	Counter Type Switch	28
2-1-4	Machine Number Switch	29
2-2	Installation	30
2-2-1	System Configuration Precautions	30
2-2-2	Installing Units	30
2-3	Wiring	32
2-3-1	Connector Pin-layout	32
2-3-2	Connector Wiring Methods	33
2-3-3	Important Wiring Considerations	36
2-3-4	Internal Circuitry	36
2-3-5	Digital I/O Circuit Configurations	39
2-3-6	Counter Input Configurations	41

2-1 Components and Switch Settings

2-1-1 Components

Front and Side View

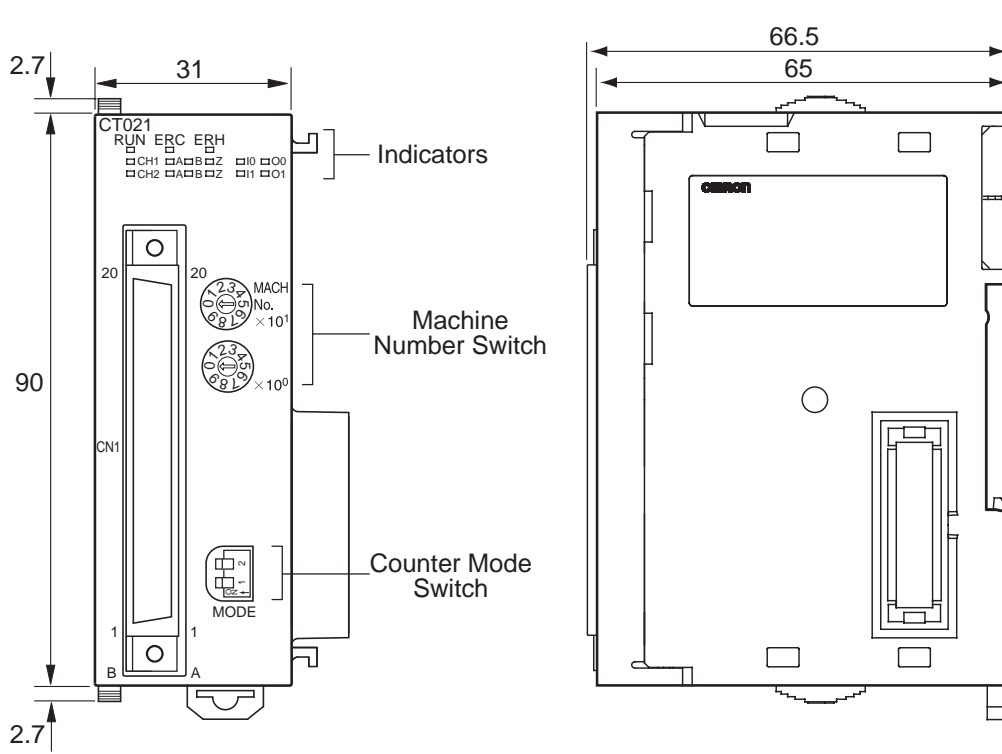

Dimensions with Connector

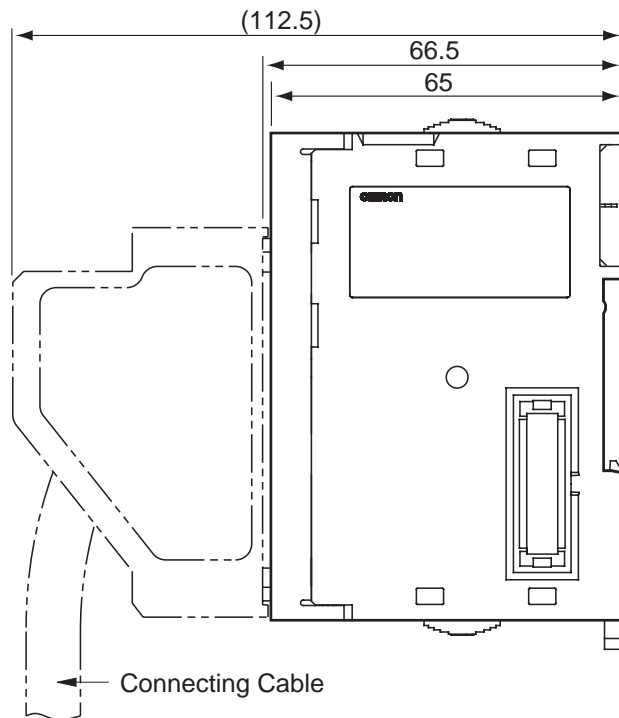

2-1-2 Indicators

CT021					
RUN	ERC	ERH			
CH1	A	B	Z	I0	O0
CH2	A	B	Z	I1	O1

The indicators on the LED-display show the operating status of the Unit. The following table shows the meaning of the indicators.

LED	Colour	State	Description
RUN	Green	ON	Unit is in operation (i.e. Unit has initialised normally after (re-) starting the Unit).
		OFF	Unit is not in operation (i.e. Unit was not able to initialise normally after (re-) starting the Unit or the power to the Unit is switched OFF).
ERC	Red	ON	Unit has operational failure due to a detected error. (For a list of all the errors that can cause an operational failure, see 5-2 "Error codes".)
		OFF	Unit has no operational failure.
ERH	Red	ON	CPU Unit has operational failure. (For a list of all the errors that can occur at the CPU Unit see 5-1 "Error Indicators")
		OFF	CPU Unit has no operational failure.
CH1/2	Green	ON	Channel 1/2 (i.e. Counter 1/2) is ready to count (the corresponding counting gate is open).
		OFF	Counter 1/2 is not ready to count (the corresponding counting gate is closed).
A/B/ Z	Yellow	ON	Physical Input A/B/Z has turned ON. (Every Counter is characterised by the signals A/B/Z.)
		OFF	Physical Input A/B/Z is turned OFF.
I0/I1	Yellow	ON	Digital Input (I0/I1) is turned ON.
		OFF	Digital Input (I0/I1) is turned OFF.
O0/O1	Yellow	ON	Digital Output (O0/O1) is turned ON.
		OFF	Digital Output (O0/O1) is turned OFF.

2-1-3 Counter Type Switch

The Counter Type Switch, at the front of the Unit, is used to set the Counter Type for every individual Counter separately. By default all Counters are set to Simple Counter.

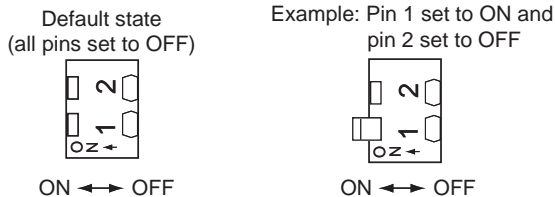

Note: Pins are set to ON when they are raised at an angle.

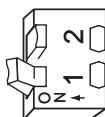

The following table shows how the Counters can be configured:

Pin	Counter	Position	Type
1	#1	ON	Circular/Linear Counter
		OFF	Simple Counter
2	#2	ON	Circular/Linear Counter
		OFF	Simple Counter

After having set the DIP switch of the Counter to ON, further selection between Circular and Linear Counter, is done by DM-setting. Counters that are configured for Circular/Linear Counter can make use of all the features that the High-speed Counter Unit offers. More information on Circular and Linear Counters can be found in 3-2-2 "Circular Counter" and 3-2-3 "Linear Counter" respectively.

The Simple Counter is an extra feature of the High-speed Counter Unit, that enables an easy and fast set-up of the Unit since no (DM-) configuration settings have to be made (all default (=0000) DM-settings are used). Consequently for Simple Counters only a reduced subset of all the features that the Unit offers are available. For further details about the Simple Counter and the features supported, see 3-2-1 "Simple Counter".

⚠ Caution

Since the Counter Type Switch is located at the back of the Unit, always turn OFF the power to the PLC before installing or removing the Unit.

2-1-4 Machine Number Switch

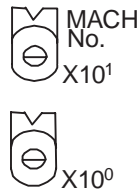

The CPU Unit and the High-speed Counter Unit exchange data via the Special I/O Unit Area (CIO) and the Special I/O Unit DM Area. The High-speed Counter Unit is allocated the words for 4 Units. This means that 40 words in the Special I/O Unit Area (CIO) and 400 words in the Special I/O Unit DM Area are allocated. The allocation of these words is done according to the Machine Number set. The Machine Number is set by using the two Machine Number rotary switches on the front panel of the Unit.

Always turn OFF the power before setting the Machine Number. Use a flat-blade screwdriver, being careful not to damage the switch. Be sure not to leave the switch midway between settings.

Note The Machine Number determines which words in the CPU Unit’s Special I/O Unit Area (CIO 2000 to CIO 2959 and DM 20000 to DM 29599) are allocated to the High-speed Counter Unit. Since the Unit is allocated 400 DM-words and 40 CIO-words, the Machine Number can only be set between 00 and 92. The Machine Numbers 93, 94 and 95 can not be set.

Switch Setting	Machine Number	I/O Refresh Data Area Addresses	Special I/O Unit DM Area Addresses
0	#0	CIO 2000 to CIO 2039	D20000 to D20399
1	#1	CIO 2010 to CIO 2049	D20100 to D20499
2	#2	CIO 2020 to CIO 2059	D20200 to D20599
3	#3	CIO 2030 to CIO 2069	D20300 to D20699
4	#4	CIO 2040 to CIO 2079	D20400 to D20799
5	#5	CIO 2050 to CIO 2089	D20500 to D20899
6	#6	CIO 2060 to CIO 2099	D20600 to D20999
7	#7	CIO 2070 to CIO 2109	D20700 to D21009
8	#8	CIO 2080 to CIO 2119	D20800 to D21199
9	#9	CIO 2090 to CIO 2129	D20900 to D21299
10	#10	CIO 2100 to CIO 2139	D21000 to D21399
...
n	#n	CIO 2000 + (n * 10) to CIO 2000 + (n * 10) + 39	D 20000 + (n * 100) to D 20000 + (n * 100) + 399
...
92	#92	CIO 2920 to CIO 2959	D29200 to D 29599
93	Cannot be set	Not Applicable	Not Applicable

Switch Setting	Machine Number	I/O Refresh Data Area Addresses	Special I/O Unit DM Area Addresses
94	Cannot be set	Not Applicable	Not Applicable
95	Cannot be set	Not Applicable	Not Applicable

- Note**
1. If two or more Special I/O Units are assigned the same Machine Number, a fatal error "Unit No. Duplication Error" (in the PLC-CPU) will be generated (A40113 will turn ON) and the PLC will not operate.
 2. The High-speed Counter Unit is allocated the words for 4 Units. If you use Special I/O Units that are allocated more than 100 DM-words and 10 CIO-words, like the CJ1W-CT021 High-speed Counter Unit, you should make sure that no memory overlapping occurs. If the Machine Number for the High-speed Counter Unit is set to 'n' the Machine Number of the Special I/O Unit should be set to 'n+4', in order to avoid memory overlapping. In case two or more Special I/O Units have set Machine Numbers that cause an overlapping of allocated memory a fatal error "Unit No. Duplication Error" (in the PLC-CPU) will be generated (A40113 will turn ON) and the PLC will not operate.
 3. Besides the memory that is allocated to the High-speed Counter Unit in the Special I/O Unit DM Area, for every Counter additional memory can be allocated in DM/EM. This extra allocated amount of memory is used to make the Counter Specific Settings related to Range or Comparison Mode. Memory is allocated by specifying an Indirect Address for every Counter in the Special I/O Unit DM Area. For details about Indirect Addressing refer to 4-2-2 "Indirect Addressing".

2-2 Installation

2-2-1 System Configuration Precautions

Up to 24 Units can be connected for each PLC (CPU Unit), including up to 10 on each Rack (CPU Rack and Expansion Racks).

- Note** The Unit must be mounted to one of the five positions immediately to the right of the CJ1-H CPU Unit (when facing the PLC) to generate interrupts to the CPU Unit to execute external interrupt tasks. Interrupts are not supported from any other location on the CPU Rack and are not supported at all from Expansion Rack. They are also not supported by CJ1 CPU Units.

2-2-2 Installing Units

 **Caution** Leave the protective label on top of the Unit as long as the Unit is not mounted and wired completely, in order to prevent wire clippings or other materials from getting inside the Unit. When the mounting and wiring has been completed, the label must be removed to allow air circulation and heat radiation.

 **Caution** Be sure to turn OFF the power supply to the PLC before installing or removing Units or connecting or disconnecting connectors.

Use the following procedure to install CJ1W-CT021 High-speed Counter Units. Connect the Units before mounting them to DIN-rail.

1, 2, 3...

1. Align the connectors and hooks accurately and press the Units together firmly when connecting them.

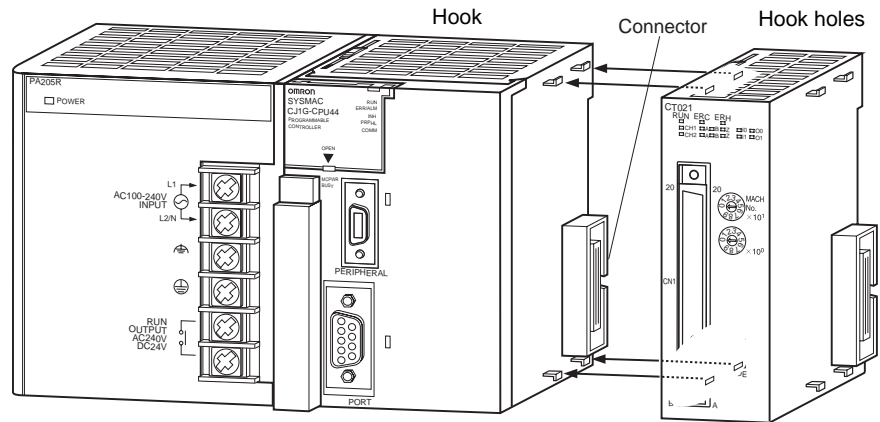

2. Slide the yellow sliders on the top and bottom of the Units until they click into place, firmly locking the Units together.

Slide the sliders toward the back until they click into place.

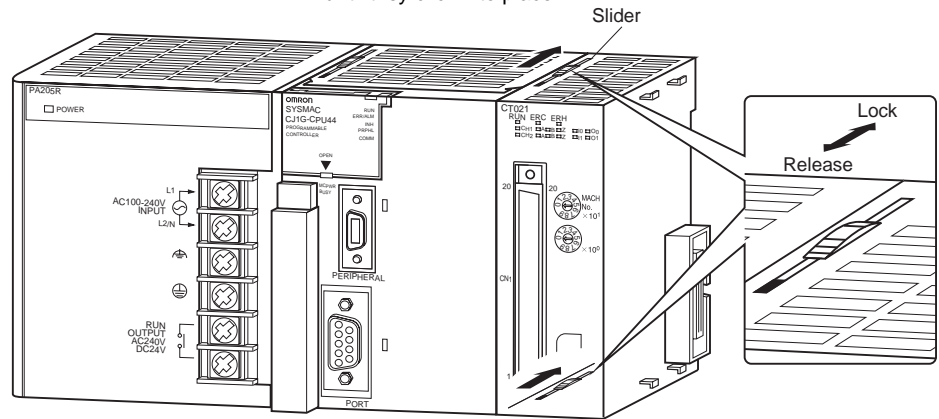

3. Attach an End Plate to the Unit on the right end of the Rack.

Note The Units may not function properly if the sliders are not locked into place. Always connect the End Plate to the rightmost Unit. The CJ-series PLC will not function properly without the End Plate connected. The End Plate is provided with the CPU Unit.

2-3 Wiring

2-3-1 Connector Pin-layout

The 40-pin connector (CN1) on the front of the Unit is divided in Row A and Row B, each row containing 20-pins as indicated on front of the Unit. The Digital Outputs, Digital Inputs and the Counter Inputs of the Unit are logically grouped together and allocated to the pins of connector 1. The following table lists the allocation of the external signals to the respective pins.

Item		Connector 1 (CN1)		Pin No.
		Row B	Row A	
Counter 2	Z	CH2: 24 V	CH2: 12 V	20
		CH2: LD+	CH2: LD- / 0 V	19
	B	CH2: 24 V	CH2: 12 V	18
		CH2: LD+	CH2: LD- / 0 V	17
	A	CH2: 24 V	CH2: 12 V	16
		CH2: LD+	CH2: LD- / 0 V	15
Spare				14
Counter 1	Z	CH1: 24 V	CH1: 5 V	13
		CH1: LD+	CH1: LD- / 0 V	12
	B	CH1: 24 V	CH1: 5 V	11
		CH1: LD+	CH1: LD- / 0 V	10
	A	CH1: 24 V	CH1: 5 V	9
		CH1: LD+	CH1: LD- / 0 V	8
Spare				7
Digital Inputs [0-1]		I1: 24 V	I1: 0 V	6
		I0: 24 V	I0: 0 V	5
Spare				4
Digital Outputs [0-1] (NPN/PNP)		O1: PNP	O1: NPN	3
		O0: PNP	O0: NPN	2
Power Supply (to feed the outputs)		+PS: 12 to 24 V	-PS: 0 V	1

Power Supply

External power has to be applied to the Power Supply pins in order to feed the Digital Outputs. Depending on what your application requires you can apply an external voltage between 12 to 24 VDC. In case the Digital Outputs are not used in your application, no external power has to be supplied.

Digital Outputs

Every Digital Output (O0 and O1) can be used in a NPN- or PNP-configuration depending on your application needs. This configuration is done by making the corresponding DM-setting (refer to 3-5-4 "Output Control Configuration" for more details). After you have configured the Digital Outputs for NPN or PNP you should make sure to use the corresponding physical NPN or PNP output pin.

Digital Inputs

The Digital Inputs should be supplied with 24 VDC signals. Every Digital Input (I0 and I1) is equipped with a separate Ground Signal (0V) and has its own electronic input circuitry. This gives you the opportunity to connect sensors either with a NPN- or PNP-output driver. By making the appropriate DM-setting it is possible to assign multiple Digital Inputs to single Counters (refer to 3-4 "Digital Input Functions" for more details).

Counter Inputs

To the Counter Inputs of the High-speed Counter Unit signals can be applied originating from one of the following driver types:

- RS-422 Line Driver
- 5, 12 and 24 VDC signals from NPN- or PNP Drivers

The Unit allows you to connect Line Driver signals and 24 VDC signals to any Counter. The following table gives an overview of which driver signals can be applied to which Counters:

	Line Driver	5 VDC	12 VDC	24 VDC
Counter 1	•	•		•
Counter 2	•		•	•

2-3-2 Connector Wiring Methods

 **Caution** Do not remove the label on top of the High-speed Counter Unit until the wiring has finished. Not doing could cause wire cuttings and other materials falling into the Unit or short circuit the internal circuitry, resulting in malfunctioning or burning. Be sure to remove the label after wiring the connectors to allow air circulation and heat radiation.

 **Caution** Be sure that all the connectors are wired correctly and properly connected to the High-speed Counter Unit, to prevent the Unit from malfunctioning.

To wire the CJ1W-CT021 in order to connect the external signals (Power Supply, the Digital I/O and the Counter Inputs) two methods are available:

1. Directly connecting the wires and cables to the external connector, which is standard delivered with the High-speed Counter Unit
2. Indirectly connecting the wires and cables to the screw terminals of a Terminal Block Unit. The Terminal Block Unit is connected to the Unit with a standard (flat-) cable. Both parts can be ordered separately.

External Connector

The connector has to be assembled from the separate parts that it exists of and that are supplied together with the Unit. Most important part is the connector jack (FCN-361J040) that contains 40 soldering terminals to which the wires have to be soldered.

Wiring the soldering terminals

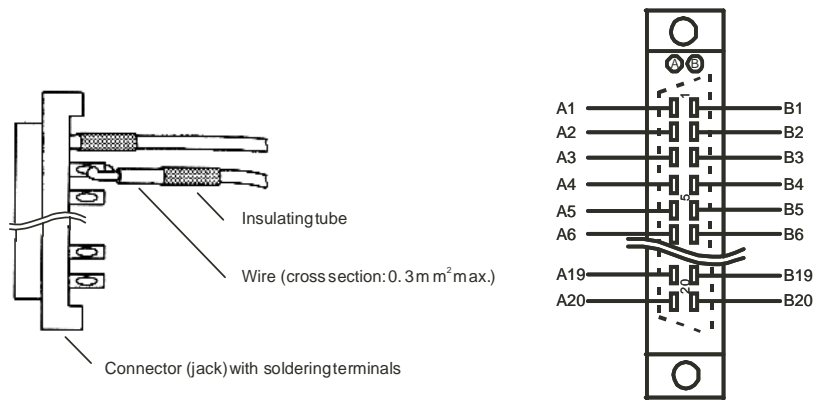

Numbering of the soldering terminals on connector (jack).
For an overview of the connector Pin-layout refer to 2-3-1 "Connector Pin-layout".

Cable separation

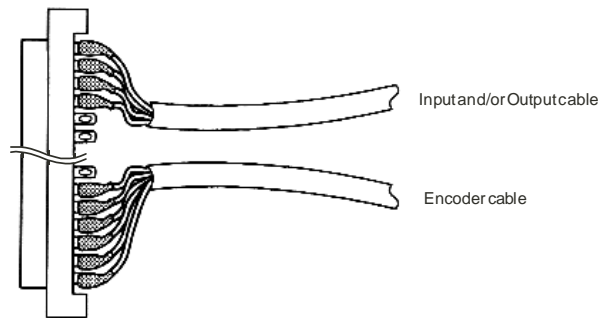

Assembling Connectors

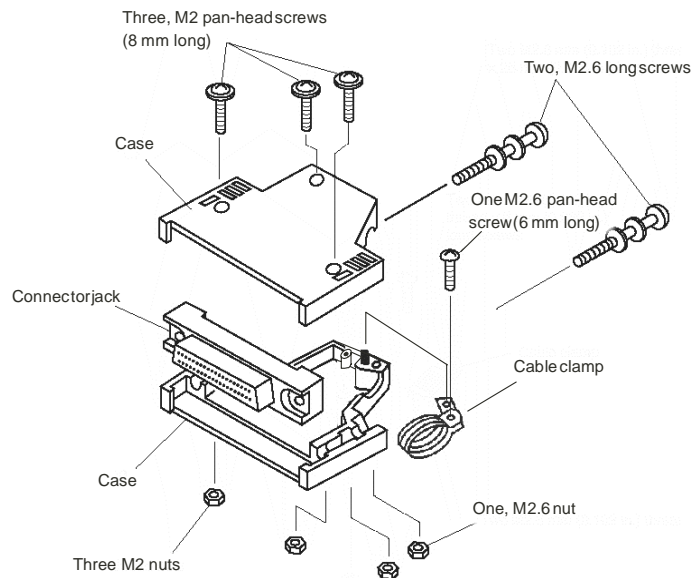

- Note**
1. The cross section of the signal wires that can be connected to each soldering terminal must be $\leq 0.3 \text{ mm}^2$
 2. Do not short circuit any terminals when soldering. Recommended is to cover every soldered wire with an insulated tube.

3. When using multi-conductor cables, separate the input- and output cables.

Terminal Block Unit

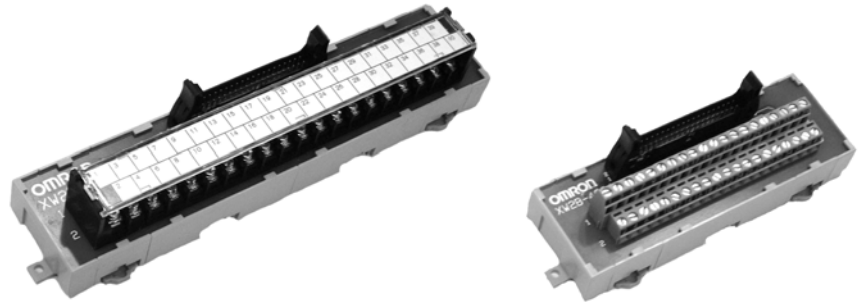

Besides direct connection as described above, it is also possible to make all the connections for the external signals to screw-terminals. This is easier and less time-consuming than soldering the wires to the external connector. For this purpose you should use a Terminal Block Unit. The following Terminal Block Units are recommended for using together with the CJ1W-CT021 High-speed Counter Unit:

- XW2B-40G4, which has 40 screw -terminals (M2.4) available
- XW2B-40G5, which has 40 screw -terminals (M3.5) available

These Terminal Block Units can be mounted to a DIN-rail or can be mounted using screws. The connector on front of the Unit should be connected to a Terminal Block Unit through a standard (40 wire) cable. For this purpose you can use the standard available cables with product-number XW2Z-xxxB. The length of the cable is indicated by 'xxx' in centimetres. The following cables are available:

- XW2Z-050B (0.5 m)
- XW2Z-100B (1 m)
- XW2Z-150B (1.5 m)
- XW2Z-200B (2 m)
- XW2Z-300B (3 m)
- XW2Z-500B (5 m)

The next figure shows how to use the Terminal Block Unit in a typical configuration together with the CJ1W-CT021 High-speed Counter:

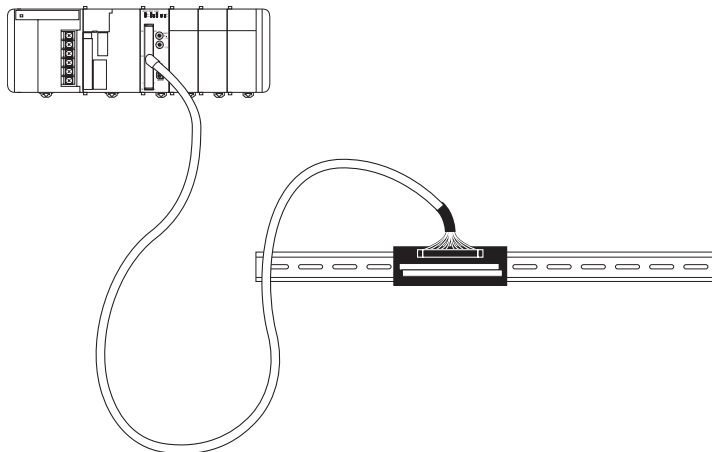

Refer to Appendix A "Using Terminal Block Units with Screw-terminals" for information on the numbering of the screw-terminals. You need this information in case you want to connect the external signals via Terminal Block Units to the High-speed Counter Unit.

2-3-3 Important Wiring Considerations

Use the following guidelines when planning the system wiring of the Unit:

- Disconnect the power to the PLC-system before wiring the Unit.
- Make sure the PLC-system is properly grounded.
- Use shielded, twisted pair cables and ground the shield when wiring the Counter Inputs (A, B, Z) and the Digital Inputs. When grounding the shield at the side of the Unit, use the same reference as the ground terminal of the PLC-Power Supply is connected to.
- Make the wiring for the Counter Inputs A, B and Z as short as possible and do not route the wires parallel to lines that produce a lot of noise, such as high-voltage power lines.
- Try to use a separate stabilised Power Supply for the High-speed Counter Unit and another Power Supply for other Units.

2-3-4 Internal Circuitry

Digital Input Circuitry

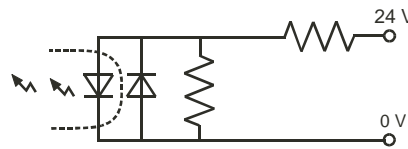

Digital Input I0:	Digital Input I1:
B5 (24 V)	B6 (24 V)
A5 (0 V)	A6 (0 V)

Counter Input Circuitry

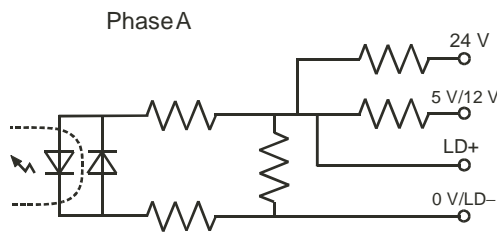

Counter 1:	Counter 2:
B9(24V)	B16(24V)
A9(5V)	A16(12V)
B8 (LD+)	B15 (LD+)
A8(0V/LD-)	A15(0V/LD-)

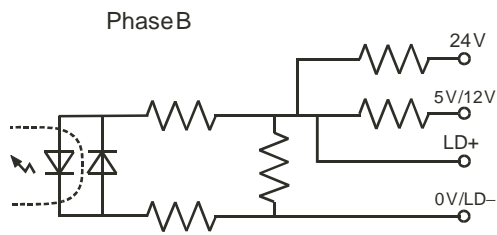

Counter 1:	Counter 2:
B11(24V)	B18(24V)
A11(5V)	A18(12V)
B10 (LD+)	B17 (LD+)
A10(0V/LD-)	A17(0V/LD-)

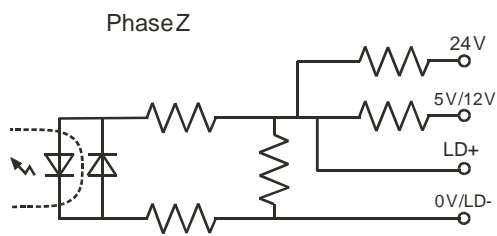

Counter 1:	Counter 2:
B13(24V)	B20(24V)
A13 (5 V)	A20 (12 V)
B12 (LD+)	B19 (LD+)
A12(0V/LD-)	A19(0V/LD-)

Digital Output Circuitry

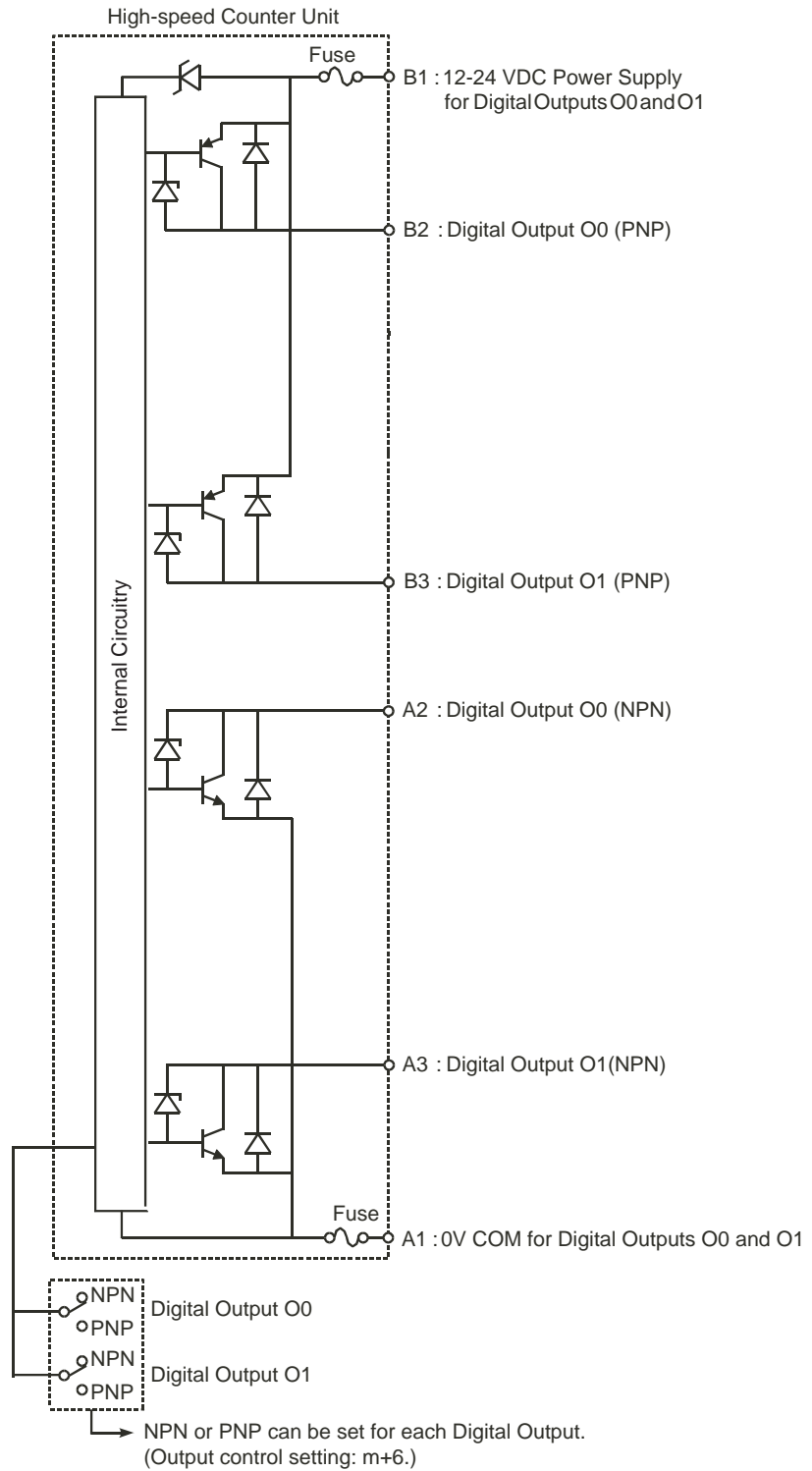

2-3-5 Digital I/O Circuit Configurations

The following examples make clear how to wire the Digital Inputs and the Digital Outputs.

24 VDC NPN Sensor

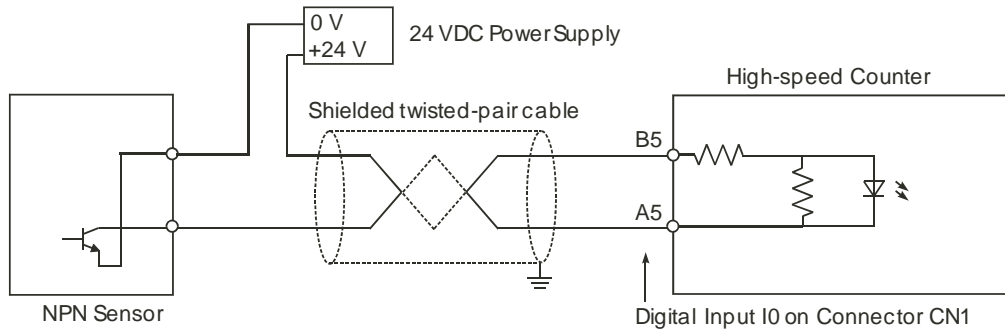

24 VDC PNP Sensor

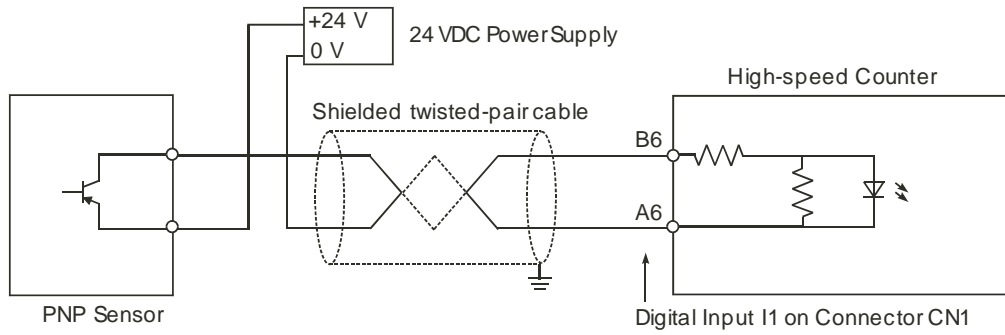

Wiring example NPN/PNP Digital Output

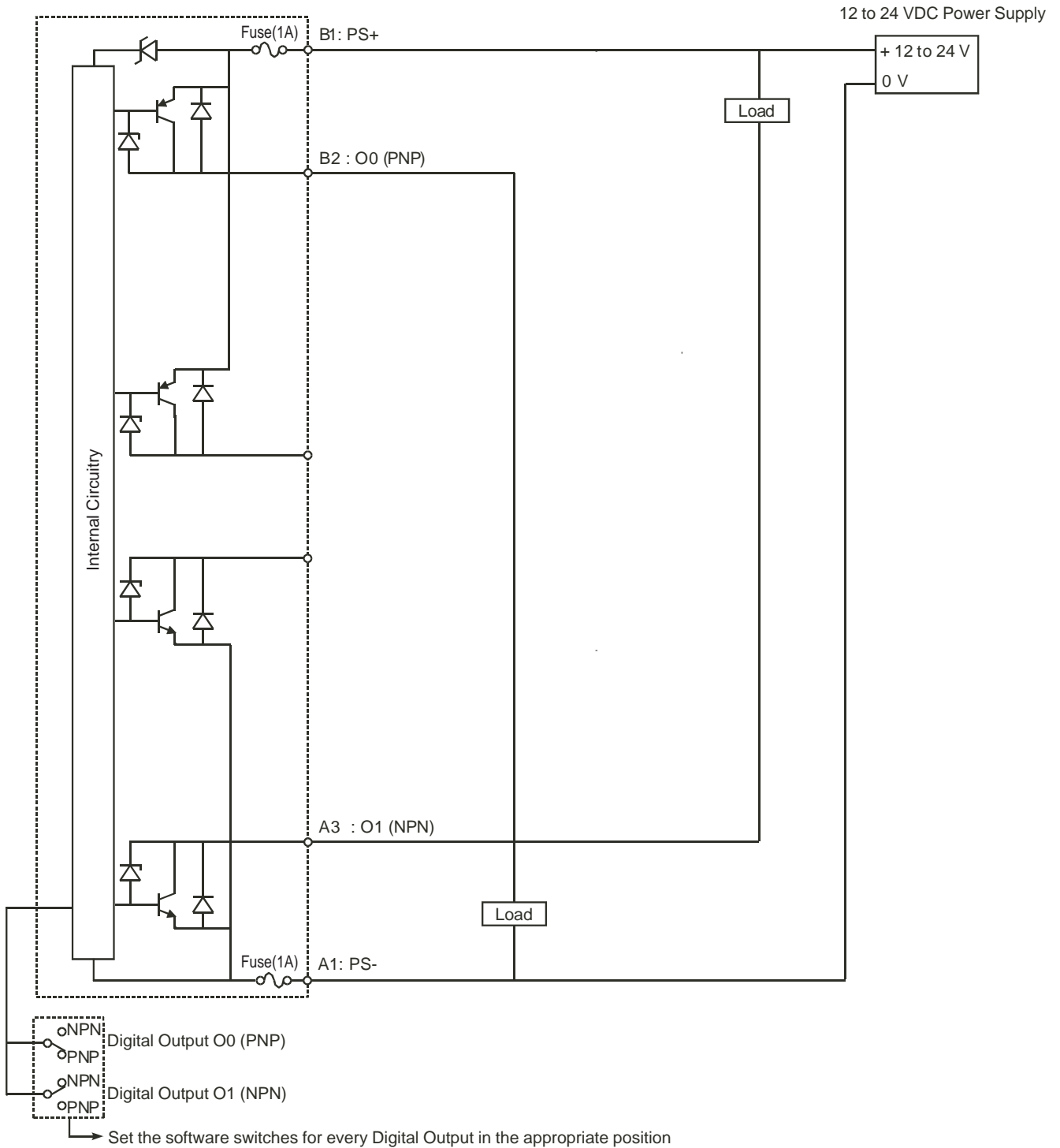

2-3-6 Counter Input Configurations

The following examples make clear how to wire the Counter Inputs in different configurations according to the output-driver of the encoder or proximity switch that you want to use. The configurations that are shown here, related to a specific output-driver, can also be referred to in case you want to use other pulse generating equipment with similar output-drivers.

5/12/24 VDC NPN Open Collector

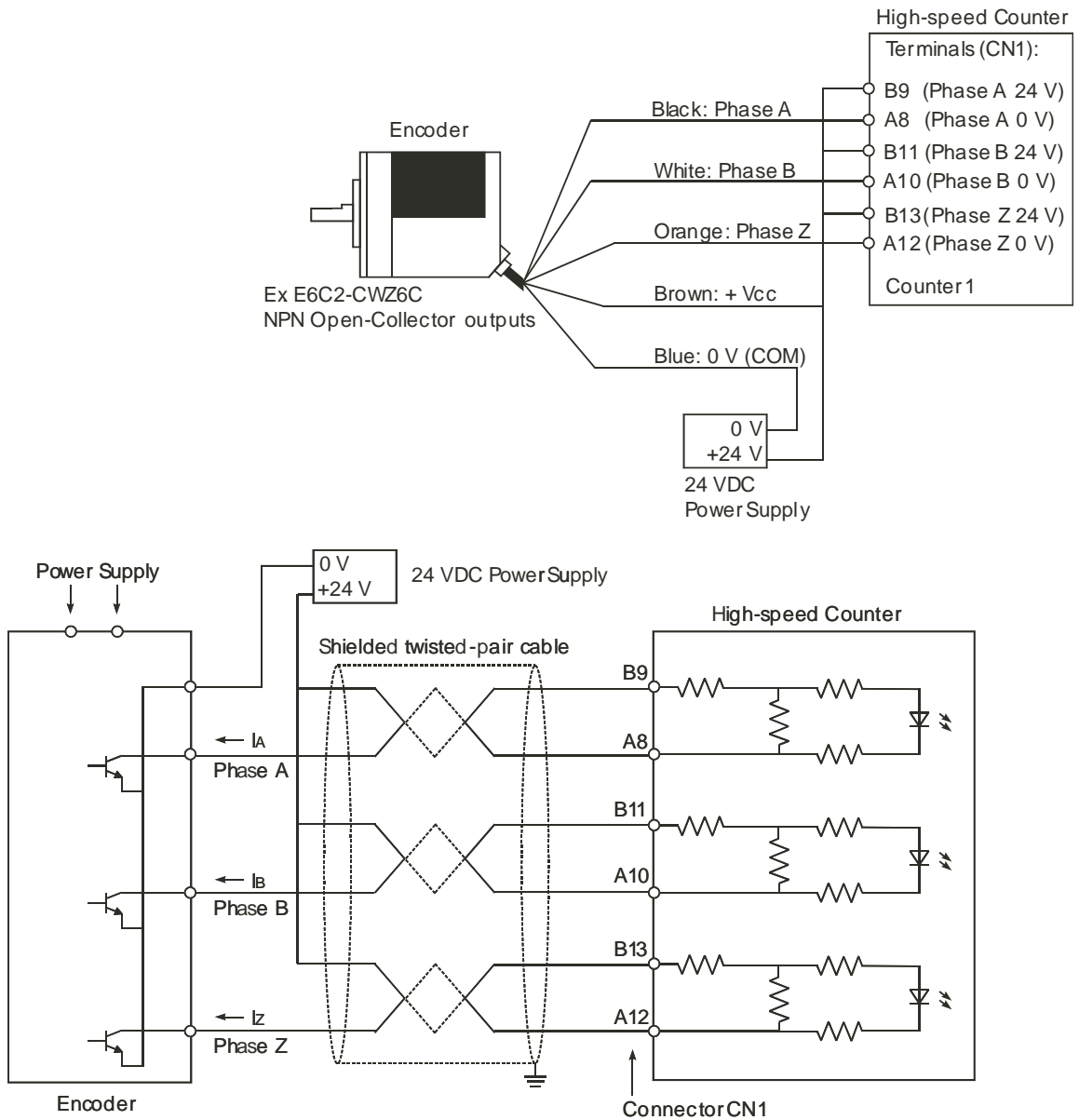

5/12/24 VDC PNP Open Collector

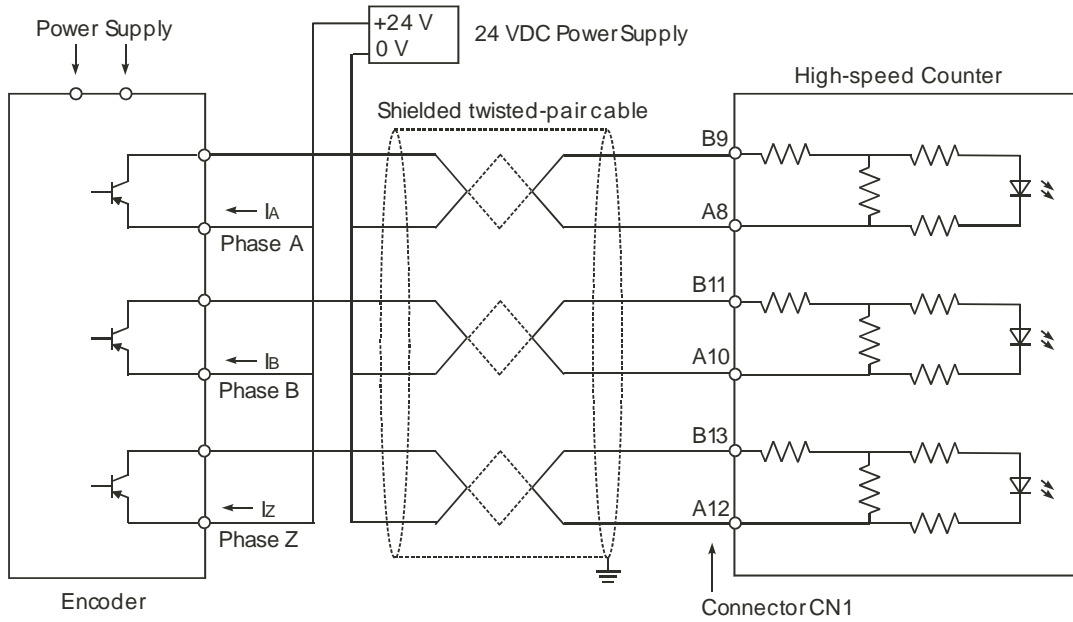
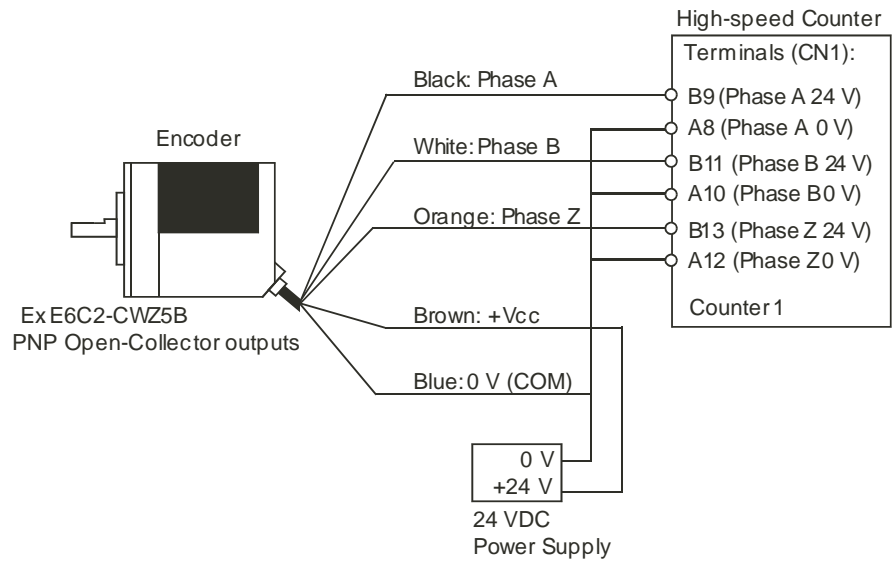

Line Driver (RS-422)

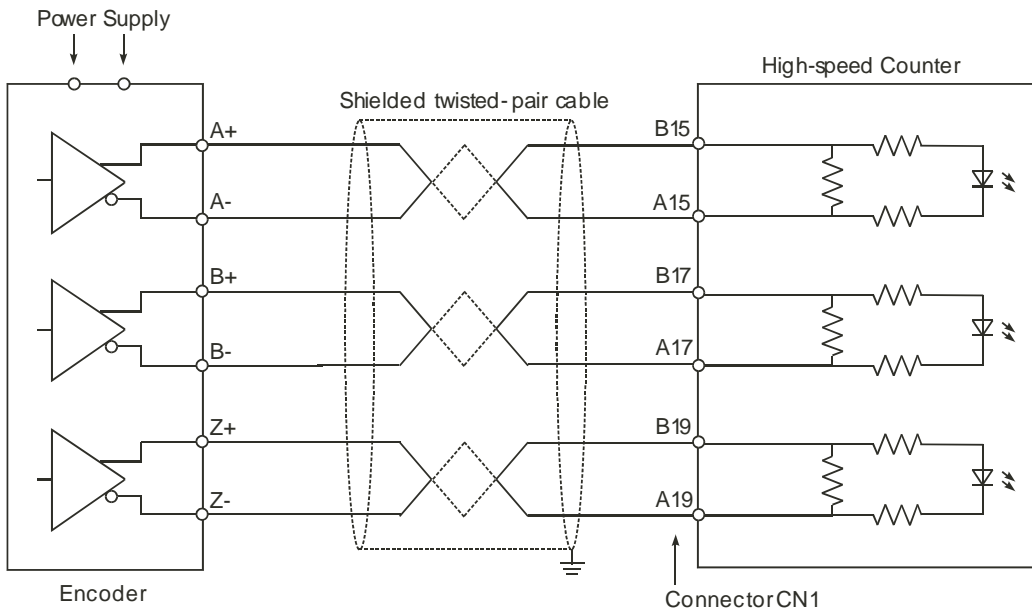
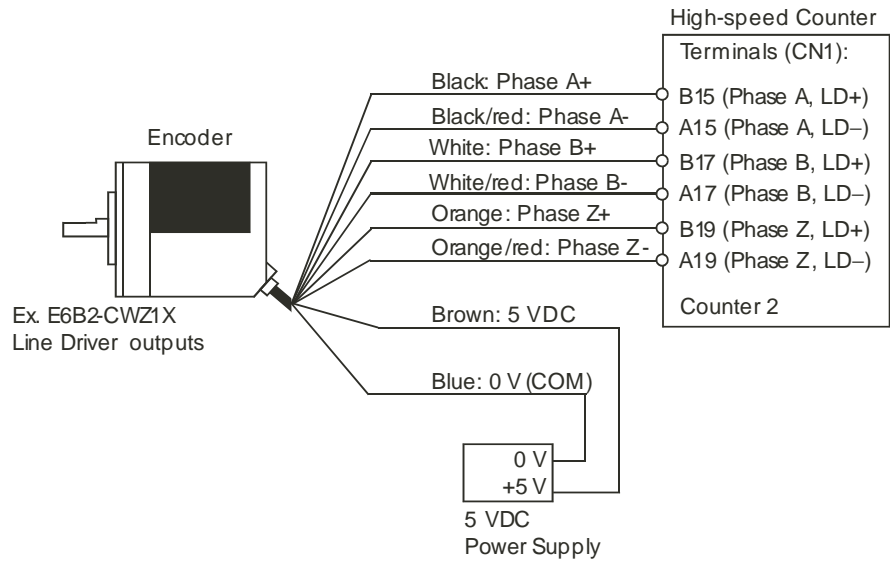

SECTION 3

Operation and Configuration

This section describes how to configure the CJ1W-CT021 High-speed Counter Unit and how to operate the Unit according to the specific requirements of your application.

3-1	Overview	46
3-2	Counter Types	47
3-2-1	Simple Counter	48
3-2-2	Circular Counter	53
3-2-3	Linear Counter	54
3-3	Input Signal Types	56
3-3-1	Phase Differential	56
3-3-2	Up & Down	57
3-3-3	Pulse & Direction	58
3-4	Digital Input Functions	59
3-5	Output Control	65
3-5-1	Range Mode	67
3-5-2	Comparison Mode	73
3-5-3	Manual Output Control	79
3-5-4	Output Control Configuration	80
3-6	Reset Signals	81
3-7	Extra Functions	83
3-7-1	Programmable Output Pulses	83
3-7-2	Rate Measurement	84
3-7-3	Hysteresis	90
3-7-4	Noise Filtering	91
3-7-5	Initial Counter Value	92

3-1 Overview

After you have installed and wired the CJ1W-CT021 High-speed Counter Unit as described in 2-2 "Installation" and 2-3 "Wiring", you have to configure the Unit by making DM-settings. Only Counters that have been configured for Circular/Linear Counter (corresponding DIP switch on the front of the Unit in the ON-position) can be DM-configured. For Simple Counters the default DM-settings are used and no DM-settings can be made.

In this section you will learn how to configure the CJ1W-CT021 High-speed Counter Unit in order to adjust the behaviour of the Unit according to the specific requirements of your application (refer to 1-4 "Quick Start Up Reference Guide" for an overview of the configuration items for every Counter). Also throughout this section, the CIO-words that are relevant to operate the Unit from the PLC ladder program are mentioned (refer to 4-2-3 "CIO-Memory Mapping" for an overview). For an overview of all the DM-settings that can be made refer to 4-2-4 "DM-Memory Mapping".

All the features and functions that the High-speed Counter Unit offers are (DM-) configurable (except the configuration of the Simple Counter which is done by DIP switch). In the Special I/O Unit DM-area that is allocated to the High-speed Counter after the Unit has been properly installed (see 1-5 "Operating Procedure Guidelines"), all the available features and functions of the Unit are represented by their corresponding DM-words. You are free to choose the sequence in which you configure the different functions. However, you are recommended to follow the sequence of configuring the features and functions in the order as described in this section.

- Note**
1. Throughout this section for the DM- and CIO- addresses an offset is defined with respect to the physical address of the first word of the block that is allocated to the High-speed Counter Unit (N = Machine Number):
 - $m = DM20000 + (N \times 100)$, address of the first word of the block of 400 DM-words that are allocated to the Unit
 - $n = CIO2000 + (N \times 10)$, address of the first word of the block of 40 CIO-words that are allocated to the UnitExample: $m+2$ indicates the DM-word located at $DM20000 + (N \times 100) + 2$.
 2. Double words are indicated as for example "n+22, n+23" (double word in CIO) or "m+57, m+58" (double word in DM). How to distinguish between the least and most significant words (LSW and MSW) within double words, you should refer to the section called "About this Manual" at the beginning of this Manual.

3-2 Counter Types

Every single Counter of the High-speed Counter Unit can be set independently to one of the following Counter Types (for an overview of the differences between Simple and Circular/Linear Counters refer to 1-4 "Quick Start Up Reference Guide"):

- Simple Counter (refer to section 3-2-1 "Simple Counter")
- Circular Counter (refer to section 3-2-2 "Circular Counter")
- Linear Counter (refer to section 3-2-3 "Linear Counter")

The configuration starts by setting each Counter's DIP switch on the front of the Unit in the appropriate position. By default this switch is in the OFF position which selects the Simple Counter. To select a Circular or Linear Counter set the switch in the ON position. After you have set the DIP switch in the ON position you can configure every Counter as Circular or Linear Counter by giving the corresponding word in DM the appropriate setting:

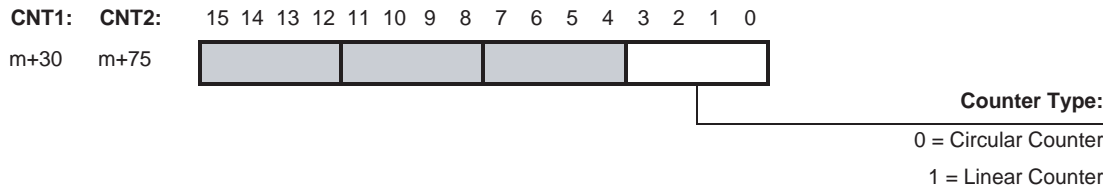

For Circular and Linear Counters all the functions and features of the High-speed Counter Unit are available and configurable. For Simple Counters only the default functions and features are supported since the Unit ignores the DM-settings for Simple Counters.

Counter Value

For all Counter Types the 32-bit Counter Value is reflected in CIO.

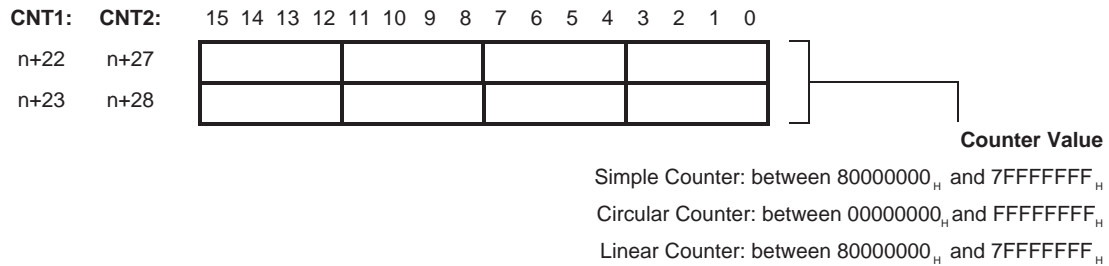

3-2-1 Simple Counter

The advantage of using a Counter as a Simple Counter is that you do not have to make any DM-configuration settings. Instead, all default DM-settings are used. As a consequence Simple Counters can only be used in a default configuration. If you intend to use the High-speed Counter Unit only with Simple Counters the information as described in this section "Simple Counter", covers all the default features and functions that are important and available to you.

If you want to use all the available features and functions of the High-speed Counter Unit you must configure a Counter not as Simple Counter but as Circular or Linear Counter. For detailed information on Circular and Linear Counters refer to 3-2-2 "Circular Counter" and 3-2-3 "Linear Counter".

Simple Counter Function Outline

Function	Specifications
Counter operation	Linear
Counting range	80000000 to 7FFFFFFF _H
Counter mode	Phase difference, multiplication x1
Counting speed	50 kHz
Gate open/close	Internal bits
External outputs	Forced ON/OFF only
Output form	NPN
Reset	Internal bits
IORD/IOWR	Reading capture value Reading/writing count value Clearing errors

Simple Counter Configuration

The following features and functions are supported for Simple Counters in a default configuration:

- A Simple Counter can count up and down over the full (32-bits) counting range (comparable to a Linear Counter, refer to 3-2-3 "Linear Counter").
- By using CIO-bits the Counter Value of a Simple Counter can be Preset, Reset or Captured and the Gate can be Opened or Closed to allow counting pulses or not.
- Only Phase Differential (multiplication x1) Signals can be connected to a Simple Counter. The Z-signal cannot be used to trigger a Reset, only its status is reported in CIO (and can be used to trigger a reset indirectly via the PLC ladder-program).
- The Noise Filters for the Simple Counter and the Digital Inputs are fixed at 50 kHz. This means that the maximum frequency of the count pulses up to 50 kHz is guaranteed.
- The Digital Outputs of the High-speed Counter Unit can only be controlled manually using the corresponding bits in CIO.
- The Digital Inputs and Outputs can generate Interrupts if Interrupts have been enabled (in a mixed configuration with Simple/Circular/Linear Counters).
- The two Digital Outputs use an NPN-Output Driver.

- The Digital Inputs cannot be assigned to individual Counters and the Function of the Digital Inputs cannot be configured. Only the status of the Digital Inputs is reported in CIO. For information on assigning Functions to Digital Inputs for Circular and Linear Counters refer to 3-4 "Digital Input Functions".
- Three IORD/IOWR-commands are supported: read Captured Counter Value (refer to 4-5-3-1 "Captured Counter Value"), read/write Counter Value (refer to 4-5-3-3 "Counter Value") and write Error Clear Command (refer to 4-5-3-5 "Error Clear Command").
- Errors are normally reported in CIO (refer to 5-2 "Error codes").

The following features and functions are *not* supported for Simple Counters:

- IORD and IOWR-instructions to change DM-settings cannot be addressed to Simple Counters and will generate an error (refer to 5-2-2 "IOWR/IORD-instruction errors"). Only the three above mentioned IORD/IOWR-instructions are supported for Simple Counters.
- Rate Measurement.

- Note**
1. The CPU exchanges data with the Simple Counter via the I/O Refresh Data Area (CIO).
 2. If a Counter is configured for Simple Counter, it is indicated in CIO.
 3. All the DM-words that are allocated to a Simple Counter to make the Counter Specific Settings, can be used as work-words.

Controlling Simple Counters via CIO

Simple Counters can be controlled from CIO. For an overview of all control bits and words refer to 4-2-3 "CIO-Memory Mapping".

The following gives a detailed description of all the features and functions for Simple Counters that are available in CIO:

32 Bits Counting Range

A Simple Counter has the full counting range (=32 bits) available to count up- or downwards over the positive and negative counting range between the Lower Count Limit (-2,147,483,648) and the Upper Count Limit (+2,147,483,647).

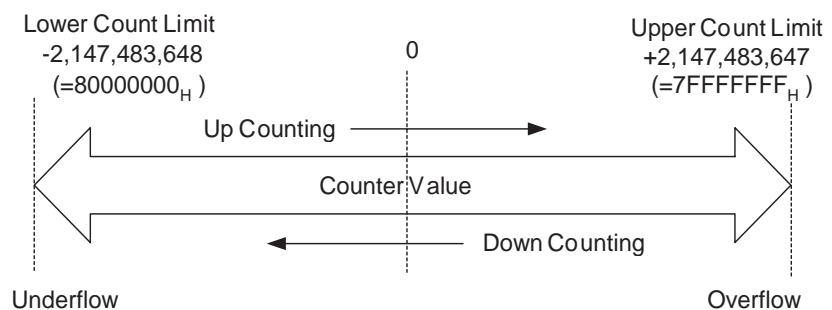

Reporting Overflow and Underflow and indicating Simple Counter

If the Counter Value goes above the Upper Count Limit or below the Lower Count Limit an Overflow or Underflow will be generated respectively. These are reported in CIO for every Counter in the corresponding bits. At Over- and Underflow the Counter Value will be frozen at the Upper- and Lower Count Limit respectively and

received count pulses will have no effect. The Over- and Underflow flags can be cleared by forcing a Preset or a Reset.

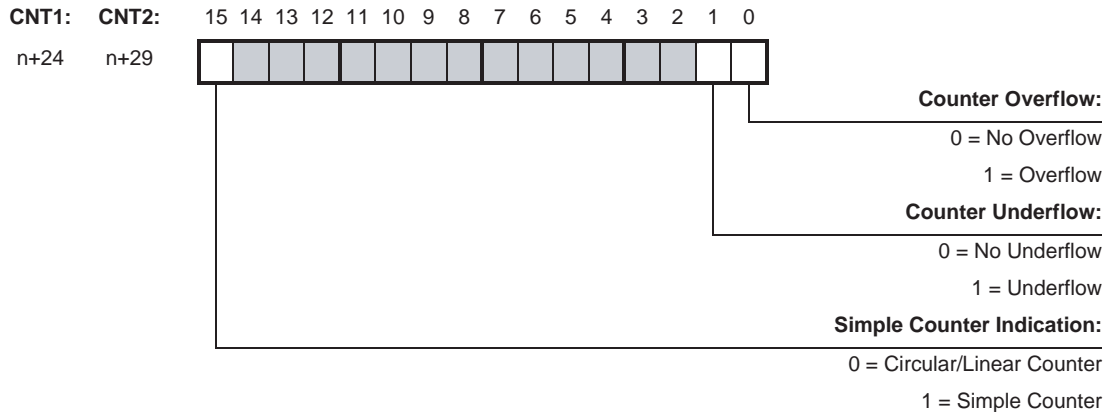

Gating of a Simple Counter

The Gate of a Simple Counter can be opened and closed using the “Open Gate Bit” and “Close Gate Bit” in CIO. If the Gate of the Simple Counter is Open the Counter is ready to count pulses. If the Gate of the Simple Counter is Closed the Counter will not count pulses. A rising edge of the Open- or Close Gate Bit triggers the corresponding action in the next I/O Refresh Cycle.

Initially, after the High-speed Counter Unit has been powered up or restarted, the Gate of the Simple Counter is closed and must be opened first (by setting the Open Gate bit to ‘1’) to enable counting.

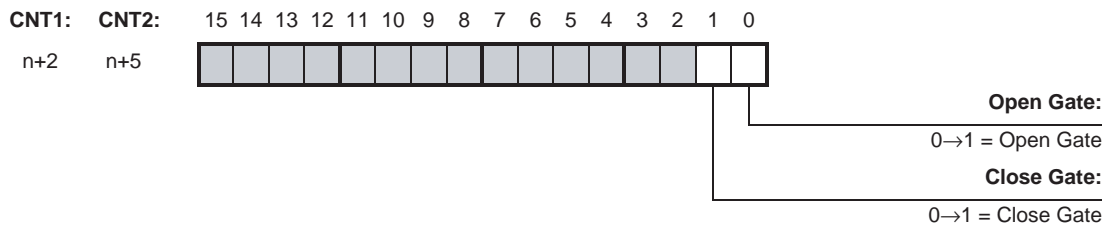

A rising edge of the "Open Gate Bit" opens the Gate regardless of the state of the "Close Gate Bit". A rising edge of the "Close Gate Bit" closes the Gate regardless of the state of the "Open Gate Bit". At a simultaneous rising edge of both bits, the state of the Gate is unchanged.

Presetting a Simple Counter

The Unit is equipped with a Preset Register that contains the Preset Value for every (Simple) Counter. To change the Preset Value you can change the Preset Value in CIO of the corresponding Counter. The Counter Value is overwritten with the Preset Value at a rising edge of the Preset Counter Bit of the corresponding

Counter. A rising edge of the Preset Counter Bit triggers a preset in the next I/O Refresh Cycle.

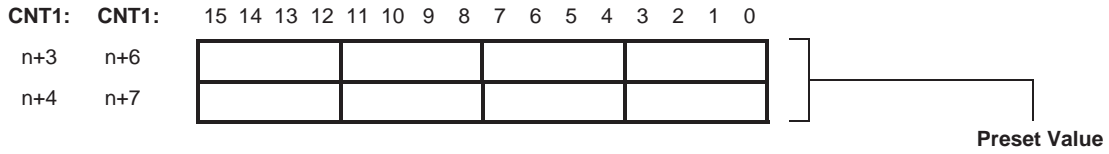
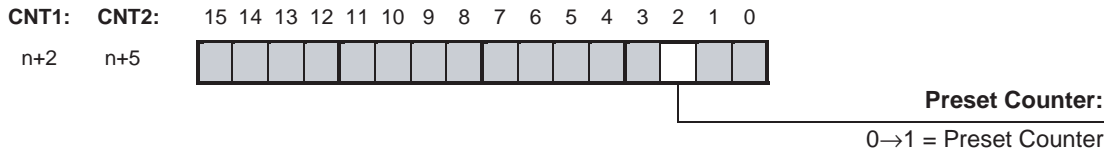

Set Preset Value for Simple Counter between 8000000_H and 7FFFFFFF_H.

Resetting a Simple Counter For every Simple Counter the Software Reset Bit can be used to trigger a Reset. A rising edge of the Software Reset Bit triggers a Reset in the next I/O Refresh Cycle.

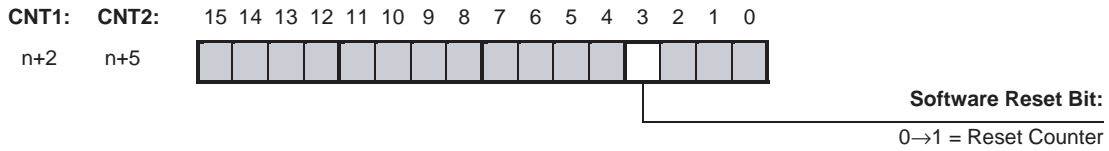

Capturing a Simple Counter Each Simple Counter has a capture register. A rising edge of the Counter Capture Bit reads the current counter value and stores it in the register. Only the most current value is maintained.

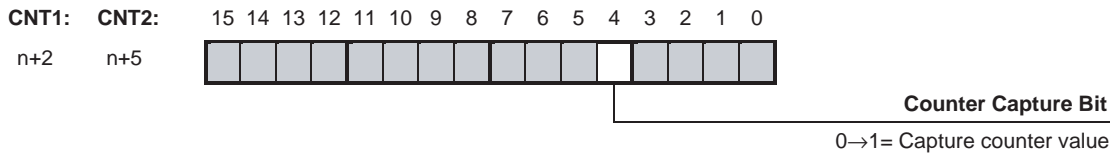

To use the captured counter value in the ladder program, read the value with the IORD-instruction. Refer to 4-4 "IORD-Instruction" for details.

Status Digital Inputs of Simple Counter The status of the two Digital Inputs is reflected by their corresponding bits in CIO. You can use these bits as event flags in the Ladder Program.

Bits 0 and 1 correspond to the Physical Digital Inputs I0 and I1.

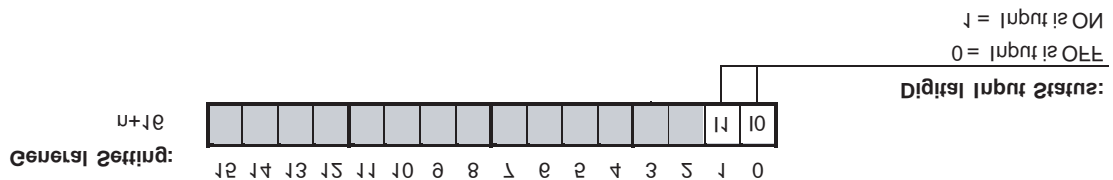

Forcing ON/OFF Digital Outputs

After you have set the Automatic/Manual Selection bit to Manual Output Control (=1), the two Digital Outputs can be forced ON and OFF using the corresponding bits in CIO.

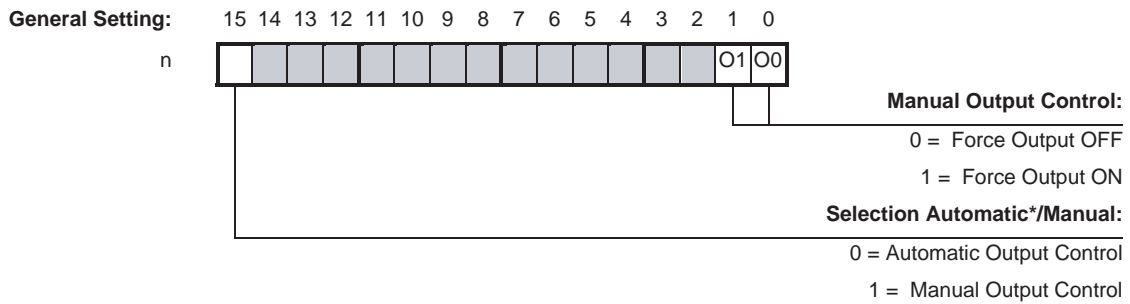

Bits 0 and 1 correspond to the Physical Digital Outputs O0 and O1.

* Automatic Output Control is available for Circular- and Linear Counters in Range- or Comparison Mode (refer to 3-5 "Output Control" for more details).

Status Digital Outputs of Simple Counter

The current status of the two Digital Outputs is reported in CIO.

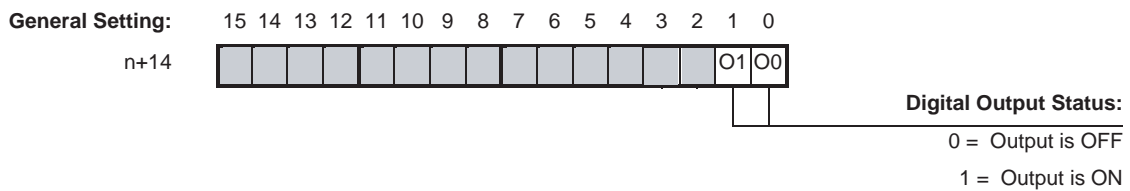

Bits 0 and 1 correspond to the Physical Digital Outputs O0 and O1.

3-2-2 Circular Counter

Note All of the functions listed in 1-3-2 "Functional Specifications" can be used if a Circular Counter is set.

Configuring Circular Counters

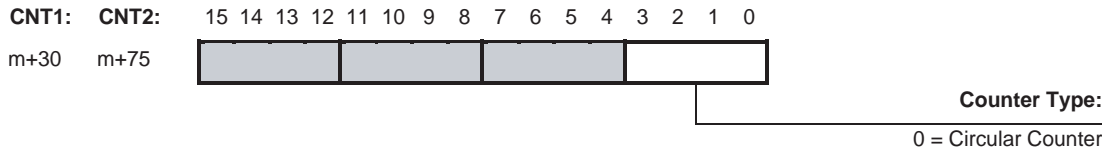

A Circular Counter has 32-bits (the full counting range) available to count up- or downwards over the positive counting range between 0 and the Upper Count Limit.

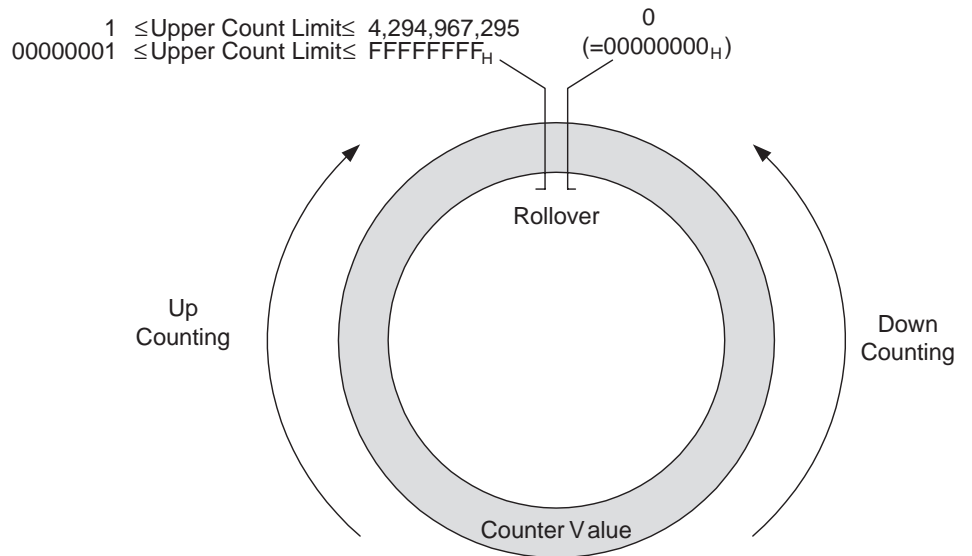

Configuring Upper Count Limit

The Upper Count Limit can be configured between 1 and 4,294,967,295 (=FFFFFFFF_H). By default the Upper Count Limit is equal to the maximum possible count limit of FFFFFFFF_H. For Circular Counters the Counter automatically rolls over to 0 if the Counter Value exceeds the Upper Count Value and continues counting. If the Counter Value goes below 0 the Counter rolls over to the Upper Count Value and continues counting.

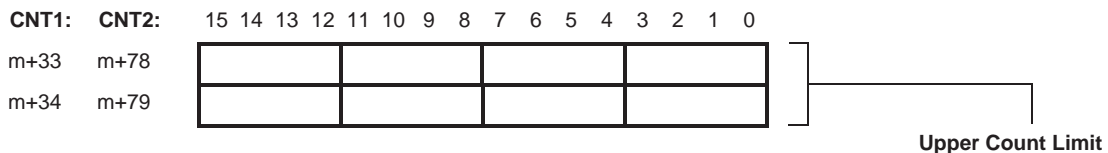

Set Upper Count Limit for Circular Counters between 00000001_H and FFFFFFFF_H.
 Per default (=00000000_H) the Upper Count Limit is equal to FFFFFFFF_H.

3-2-3 Linear Counter

Note All of the functions listed in 1-3-2 "Functional Specifications" can be used if a Linear Counter is set.

Configuring Linear Counters

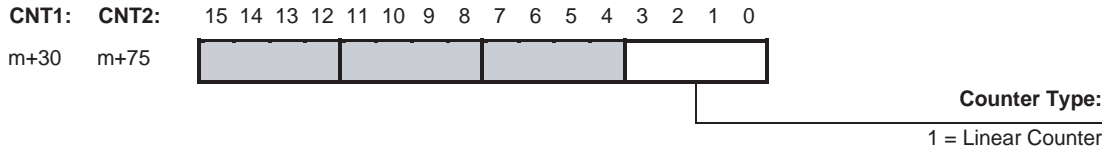

A Linear Counter has the full counting range (=32 bits) available to count up- or downwards over the positive and negative counting range between the Minimum Count Limit and the Maximum Count Limit. By default the Minimum and Maximum Count Limits are set to the maximum counting limits (i.e. -2,147,483,648 and +2,147,483,647 respectively).

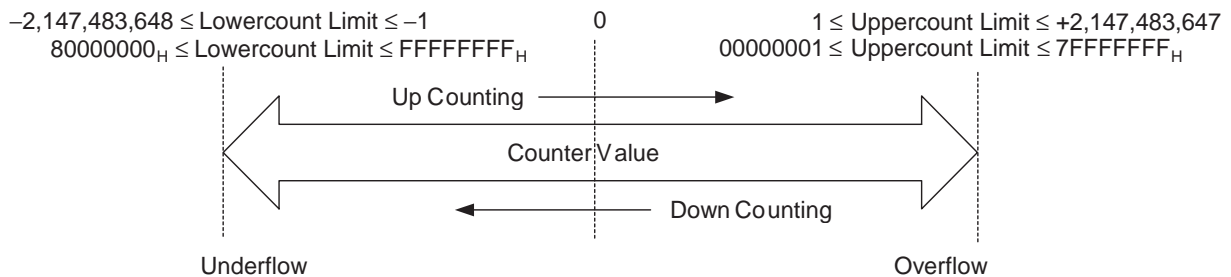

If the Counter Value goes above the Upper Count Limit or below the Lower Count Limit an Overflow- and Underflow flag will be set respectively. These are reported in CIO for the corresponding Counter.

On occurrence of an Overflow or Underflow, every Counter can be configured to report a corresponding error-code. You can use Overflow/Underflow Error-Code Generation to store Overflow and underflow errors in the EEPROM inside the Unit (refer to 5-2-3 "Overflow/Underflow errors"). Another reason to use Overflow/Underflow Error-Code Generation is that you are now able to predefine the status of the Outputs at the occurrence of an Overflow or Underflow. For this purpose you should use the Output State Control function (refer to 3-5-4 "Output Control Configuration" for more information).

Configuring Upper and Lower Count Limits

The Upper Count Limit must be positive and the Lower Count Limit must be negative (zero is not allowed as Count Limit). To set the Maximum and Minimum Count Limits refer to the following:

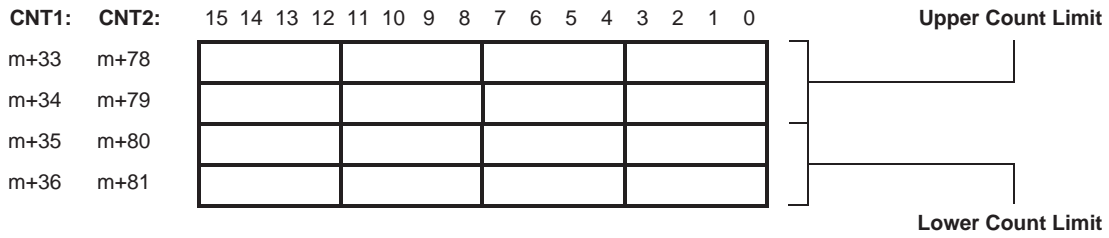

Set Upper Count Limit for Linear Counters between 00000001_H and $7FFFFFFF_H$. By default ($=00000000_H$) the Upper Count Limit is equal to $7FFFFFFF_H$. Set Lower Count Limit for Linear Counters between 80000000_H and $FFFFFFFF_H$. By default ($=00000000$) the Lower Count Limit is equal to 80000000_H .

Configuring Error-Code Generation

To configure Overflow/Underflow Error Code Generation for a Linear Counter refer to the following:

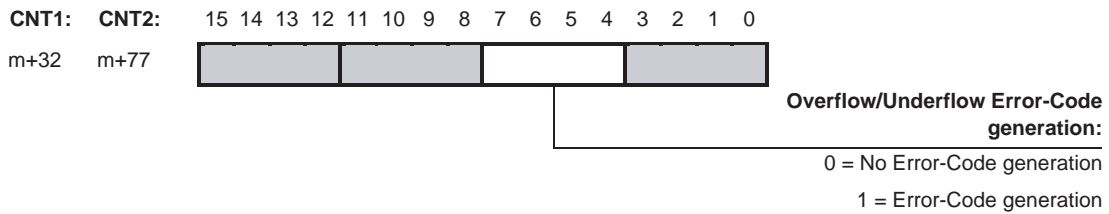

Reporting Overflow and Underflow

An Overflow or Underflow of a Linear Counter is reported in the corresponding bits in CIO.

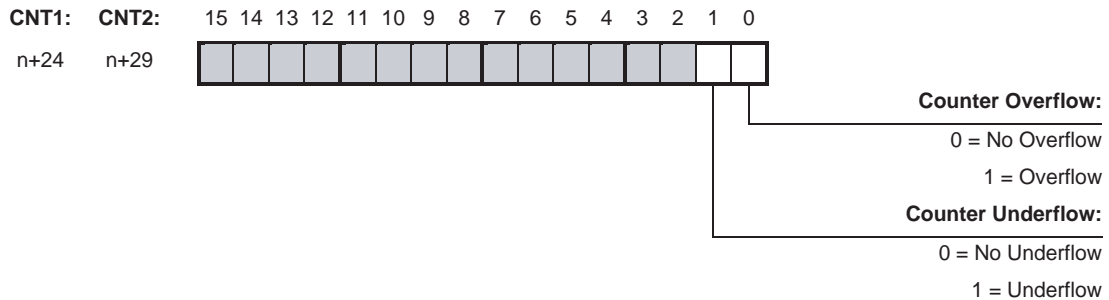

3-3 Input Signal Types

The type of input you require for your application is selected by means of four bits in the Signal Type Word in DM. For every Counter the Signal Type can be selected individually.

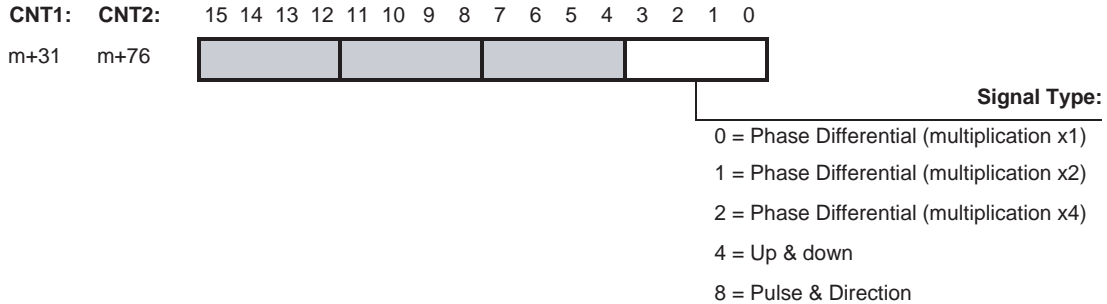

3-3-1 Phase Differential

Phase Differential Signals are connected to the inputs A, B and Z of every Counter. The count direction is determined by the phase angle between input A and input B. If signal A leads to B, the counter increments. If signal B leads to A, the counter decrements.

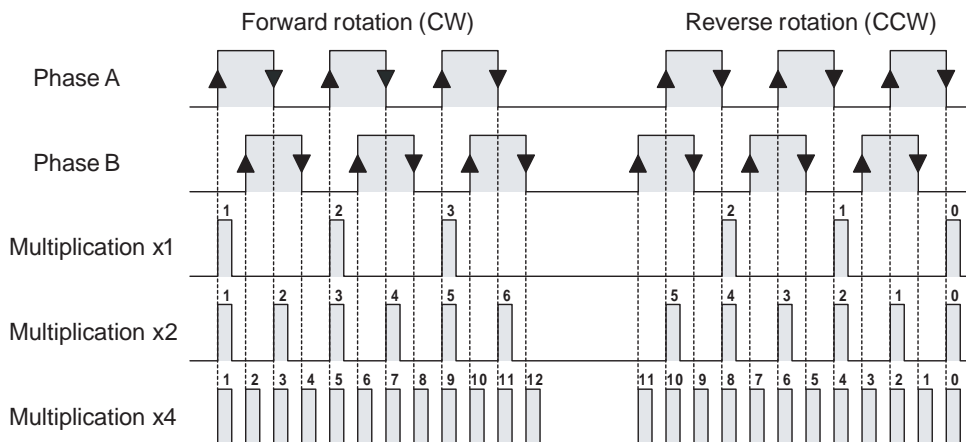
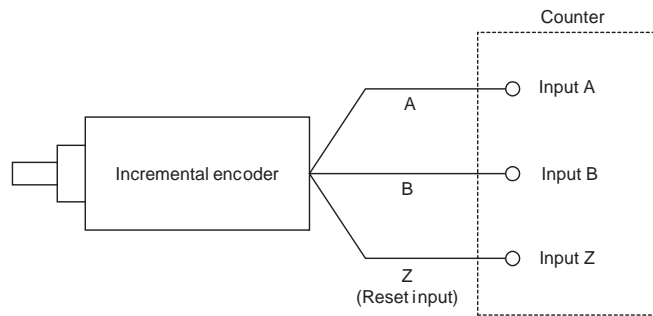

Multiplication x1

By default the Counter is configured for Multiplication by 1. If the counter is up-counting (signal A leads to signal B) pulses are taken into account by the Counter on the rising edges of signal A. If the Counter is down-counting pulses are taken into account on the falling edges of input A.

Multiplication x2

To increase the resolution of the incremental encoder the Counter can be configured for Multiplication by 2. If the Counter is up-counting (signal A leads to signal B) pulses are taken into account by the Counter on the rising- and falling edges of signal A. If the Counter is down-counting pulses are also taken into account on the rising- and falling edges of signal A.

Multiplication x4

To further increase the resolution of the incremental encoder Multiplication *4 should be selected. If the Counter is up-counting (signal A leads to signal B) pulses are taken into account by the Counter on the rising- and falling edges of signal A and signal B. If the counter is down-counting pulses are also taken into account on the rising- and falling edges of signal A and B.

Note For Counter Reset options (Z-input included) refer to 3-6 "*Reset Signals*".

3-3-2 Up & Down

With this Signal Type the Counter increments on the rising edge of pulses applied to input A and decrements on the rising edge of pulses applied to input B.

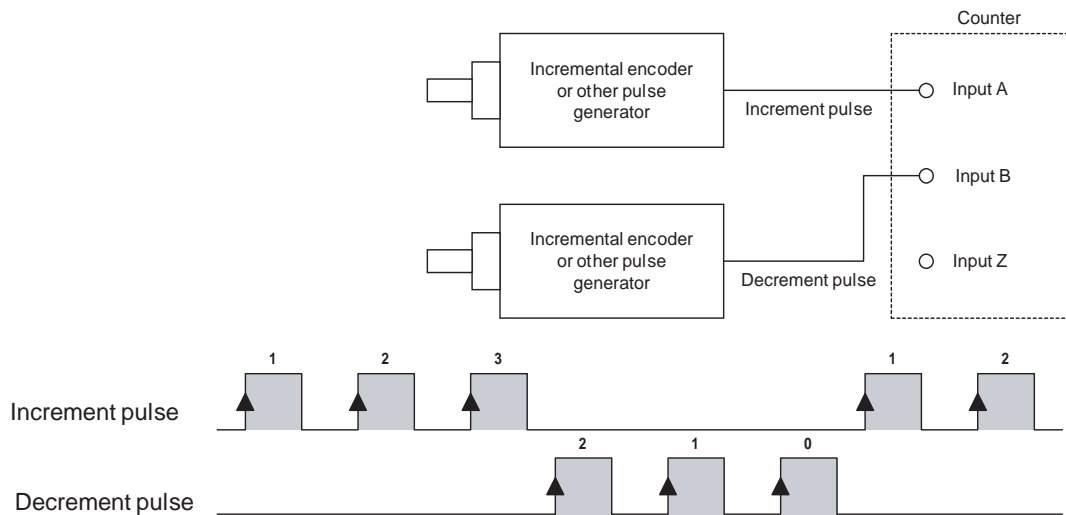

Note For Counter Reset options refer to 3-6 "*Reset Signals*".

3-3-3 Pulse & Direction

In this configuration, count pulses are applied to input A. The direction of counting is controlled by the level of the signal applied to input B. If input B is high, the Counter increments on the rising edges of input A. If input B is low, the Counter decrements on the rising edges of input A.

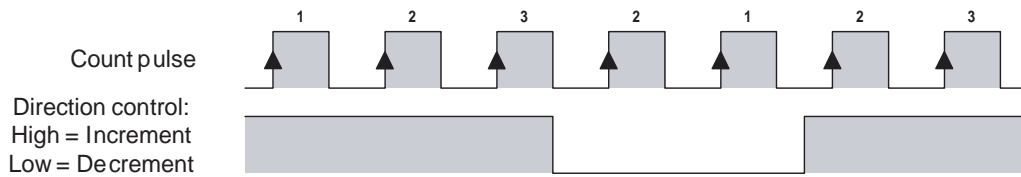
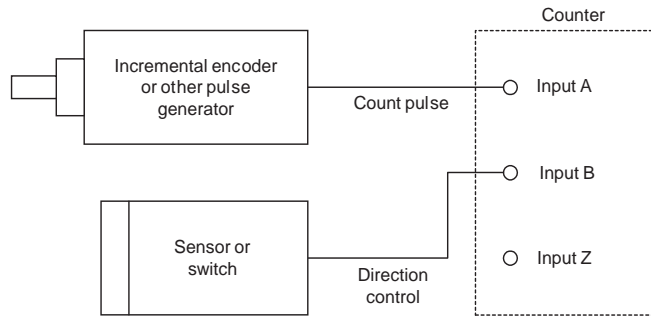

Note For Counter Reset options refer to 3-6 "Reset Signals".

3-4 Digital Input Functions

Assigning multiple Digital Inputs to single Counters

The High-speed Counter Unit is equipped with two Digital Inputs allowing every Counter to be controlled by a Digital Input. For applications that require a Counter to be controlled by more than one Digital Input, multiple Digital Inputs (i) can be assigned to a Counter (i ≤ 2). Digital Inputs can only be assigned to single Counters. Consequently, if all Digital Inputs are assigned to one Counter, they are not available any more for the other Counters.

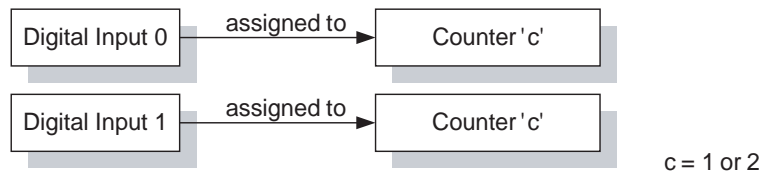

Note Every Digital Input can be configured to generate an Interrupt to the CPU. For details refer to 4-6-2 "Digital Inputs Generating Interrupts".

Digital Input Functions

Furthermore, the function of every Digital Input can be selected from one out of 17 available functions. Every function performs its unique action on the Counter to which it is assigned. The action can be performed on the rising or on the falling edge of the Digital Input signal. Depending on the requirements of your application you must select the corresponding Function. By default no function is assigned to the Digital Inputs and no action is performed on a rising or falling edge of the Digital Input signal (only the status of the Digital Input is reported in CIO).

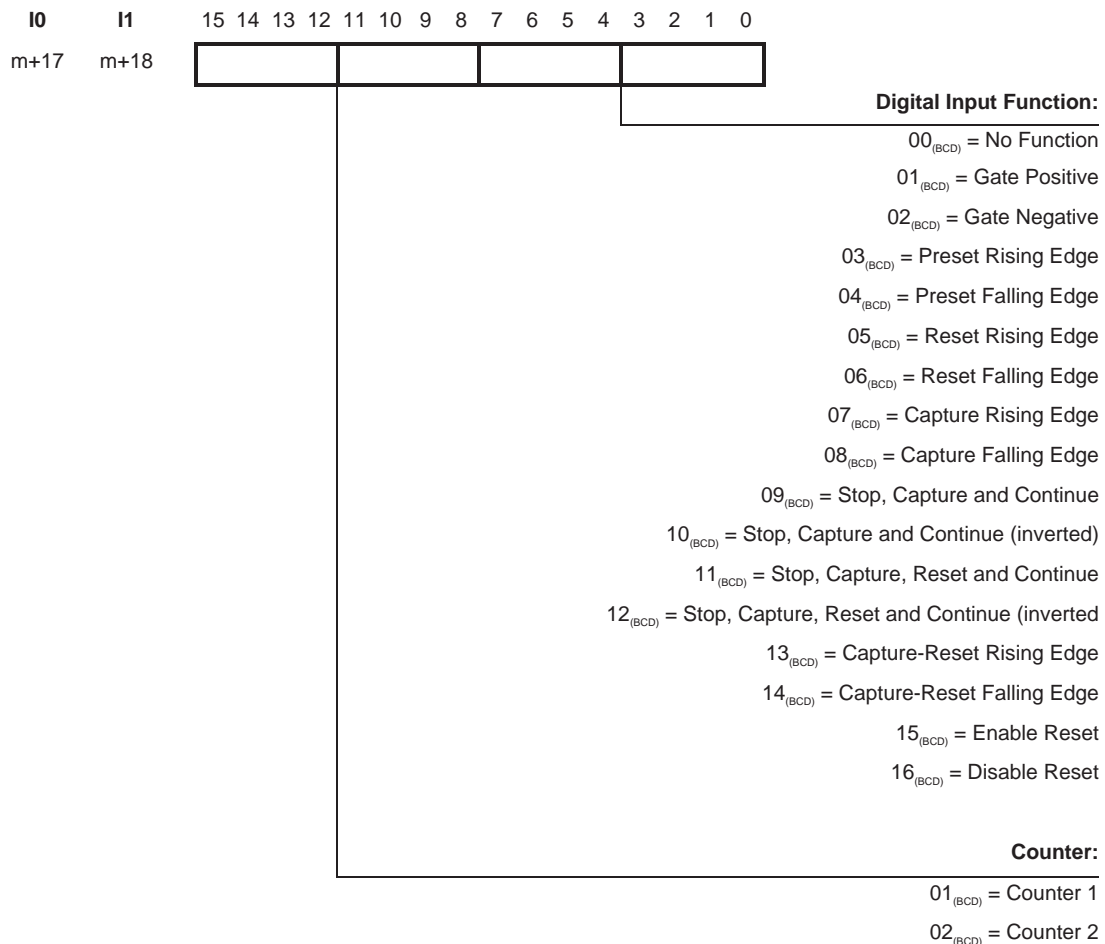

Note Every Digital Input can be configured to generate an Interrupt to the CPU. For details refer to 4-6-2 "Digital Inputs Generating Interrupts".

Gate Function

The Gate Function should be assigned to a Digital Input in case you want to use that Digital Input as a Gate. When the Gate is open, the Counter is able to count pulses. When the Gate is closed, the Counter will not count pulses. The Positive Gate Function (01) results in an open Gate when the level of the signal applied to the Digital Input is high and a closed Gate when the level of the signal applied to the Digital Input is low. For the Negative Gate Function (02) the same functionality is applied to the Counter for inverted signals.

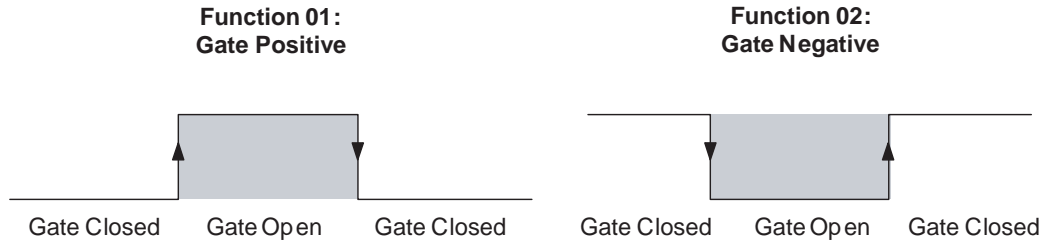

The Gate of a Counter can also be opened and closed by using the "Open Gate Bit" and "Close Gate Bit" in CIO.

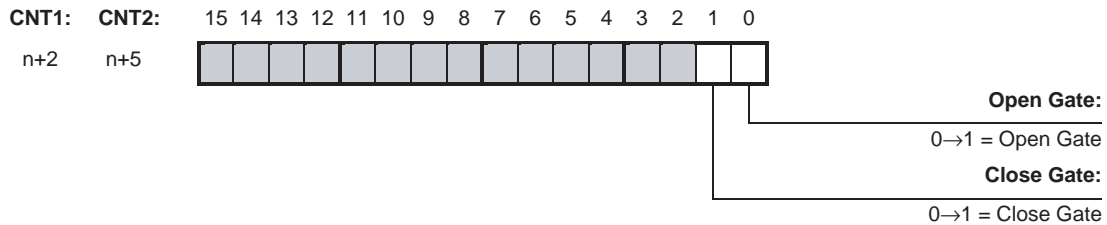

A rising edge of the "Open Gate Bit" opens the Gate regardless of the state of the "Close Gate Bit". A rising edge of the "Close Gate Bit" closes the Gate regardless of the state of the "Open Gate Bit". At a simultaneous rising edge of both bits, the state of the Gate is unchanged.

Note Initially, at power up or restart of the Unit, for all counter types (i.e. Simple-, Circular-, and Linear Counters) the Gate is closed and counting is disabled. In order to enable counting you must open the Gate first.

Preset Function

A Digital Input configured to have Preset functionality will preset the Counter with the Preset Value on a rising edge (Preset Rising Edge, Function 03) or falling edge (Preset Falling Edge, Function 04) of the Digital Input signal. This will cause the Counter Value to be overwritten with the Preset Value.



The Unit is equipped with a Preset Register for every Counter that contains the Preset Value. To change the Preset Value you can change the (32-bits) Preset Value in CIO of the corresponding Counter. The Counter Value is overwritten with

the Preset Value at a rising edge of the Preset Counter Bit of the corresponding Counter.

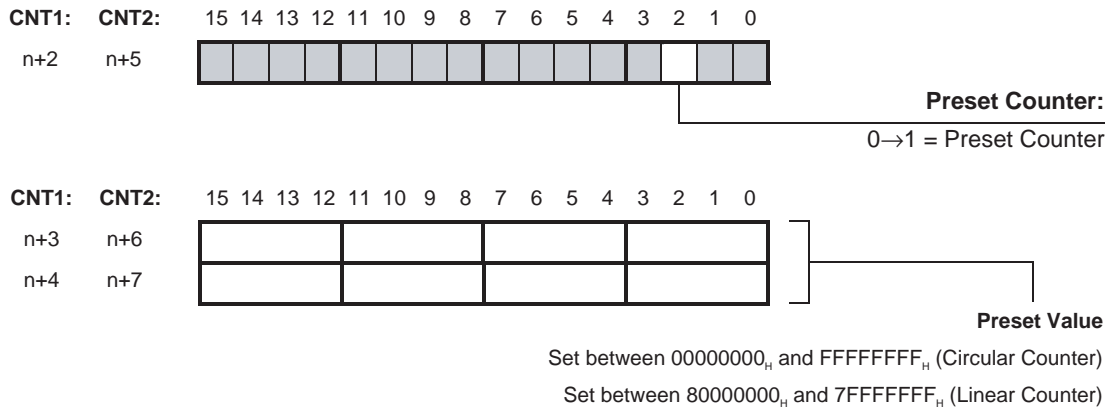

Reset Function

A Digital Input configured to have Reset functionality will reset the Counter to zero on a rising edge (Reset Rising Edge, Function 05) or falling edge (Reset Falling Edge, Function 06) of the Digital Input signal.



To reset a Counter with Function 05 or 06, the Software Enable Reset Bit must be set to 1. A Counter can also be reset by using the "Software Reset Bit" in CIO. Setting this bit to '1' causes a forced reset of the corresponding Counter.

Refer to 3-6 "Reset Signals" for detailed information about resetting Counters.

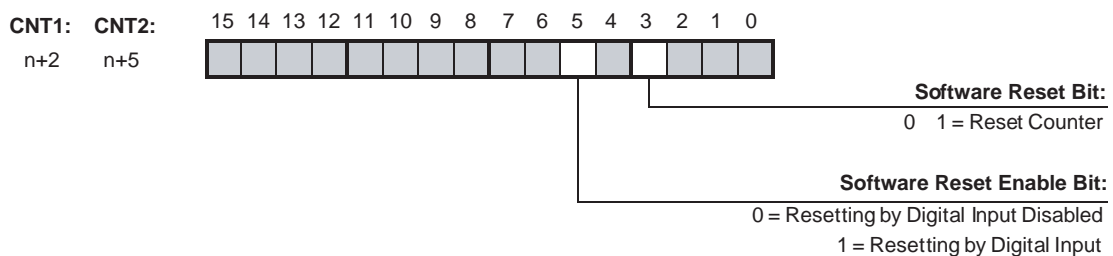

Note Resets from an External Control Input signal will be executed within 300 μs.

Capture Function

A Digital Input configured to have Capture functionality will capture the current Counter Value into the Capture Register on a rising edge (Capture Rising Edge, Function 07) or falling edge (Capture Falling Edge, Function 08) of the Digital Input signal. The Unit is equipped with a Capture Register for every Counter. Every time that a Counter Value is captured the contents of the Capture Register are overwritten with the new Captured Value and the old Captured Value is lost.



The Counter Value can also be captured by using the "Capture Counter Value Bit" in CIO.

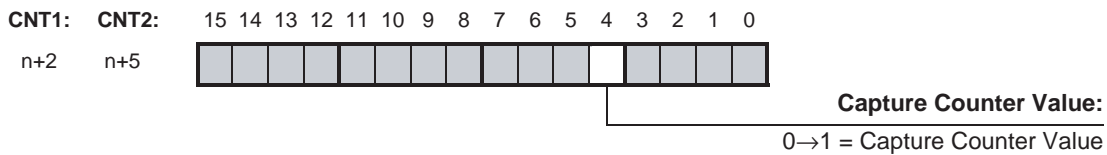

If you want to use the Captured Value in your Ladder Program, you must use the IORD-instruction. This instruction reads the Captured Value from the Unit into a specified location in the memory of the PLC. For more details on using the IORD-instruction and reading the Captured Value refer to 4-4 "IORD-Instruction".

Stop, Capture and Continue

A Digital Input configured to have Stop, Capture and Continue functionality will Stop the Counter (= close the Gate) and Capture the current Counter Value into the Capture Register on a rising edge of the signal applied to the Digital Input (Stop, Capture and Continue, Function 09). On the next falling edge the Counter will continue counting (= open the Gate). For the Stop, Capture and Continue (Inverted) Function (10) the same functionality is applied to the Counter for inverted signals.

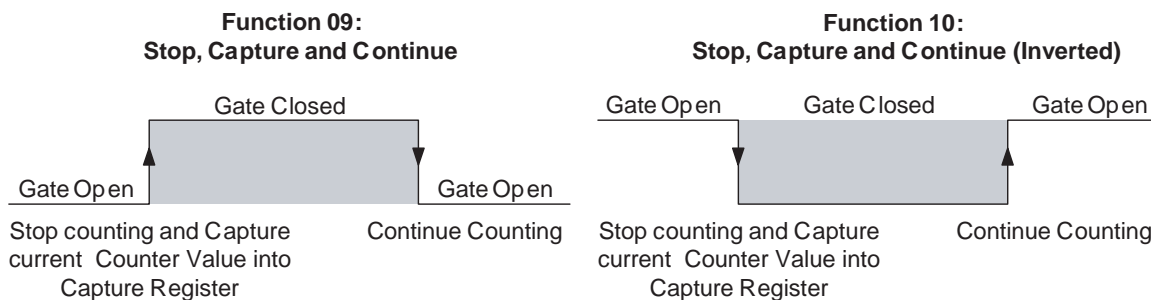

Note The Open Gate Bit, Close Gate Bit, Preset Counter Bit, Reset Bit, or the Counter Capture Bit in CIO may not be executed if turned ON for only one PLC cycle. Always keep these bits turned ON until the execution status changes for the corresponding flags in n+24 or n+29.

Stop, Capture, Reset and Continue

A Digital Input configured to have Stop, Capture, Reset and Continue functionality will Stop the Counter (= close the Gate) and Capture the Counter Value into the Capture Register on a rising edge of the signal applied to the Digital Input (Stop, Capture, Reset and Continue, Function 11). On the next falling edge the Counter Value will be Reset to zero and continue counting (= open the Gate). For the Stop, Capture, Reset and Continue (Inverted) Function (12) the same functionality is applied to the Counter for inverted signals.

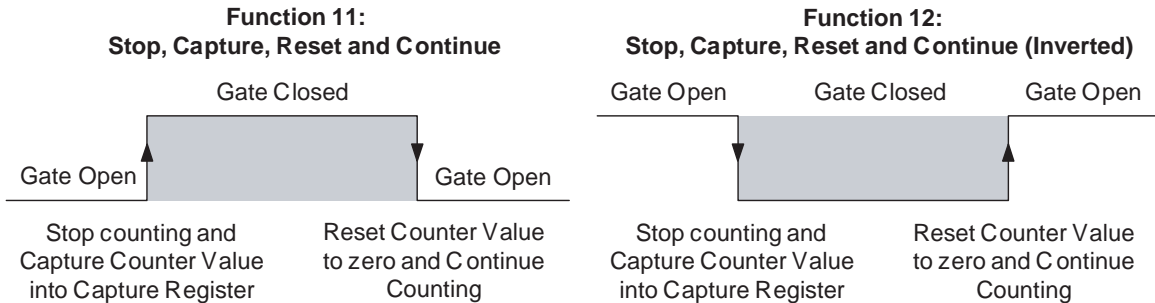

To reset a Counter with Function 11 or 12, the Software Enable Reset Bit must be set to 1. Refer to 3-6 "Reset Signals" for detailed information about resetting Counters.

Capture and Reset

A Digital Input configured to have Capture and Reset functionality will capture the current Counter Value into the Capture Register and Reset the Counter to zero on a rising edge (Capture-reset Rising Edge, Function 13) or falling edge (Capture-Reset Falling Edge, Function 14) of the signal applied to the Digital Input.

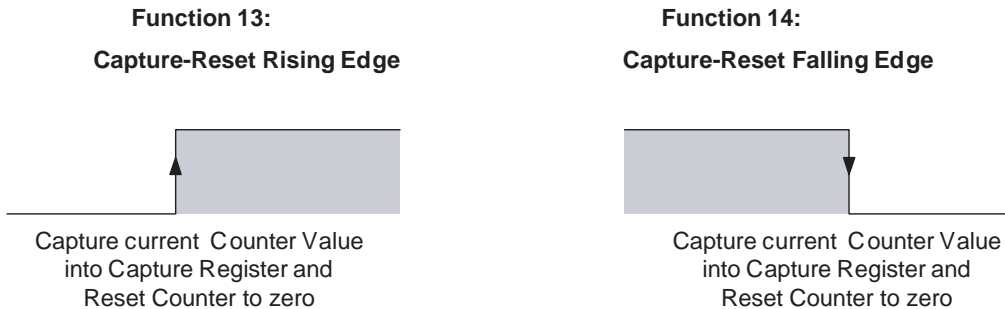

To reset a Counter with Function 13 or 14, the Software Enable Reset Bit must be set to 1. Refer to 3-6 "Reset Signals" for detailed information about resetting Counters.

Enable, Disable Reset

A Digital Input configured to have Enable Reset Functionality (Function 15) or Disable Reset Functionality (Function 16) can be used to Enable/Disable resetting a Counter by an external reset signal. The external reset signal can originate from another Digital Input that is configured to have reset functionality (Function 5, 6, 11, 12, 13 or 14) or from the Z-input.

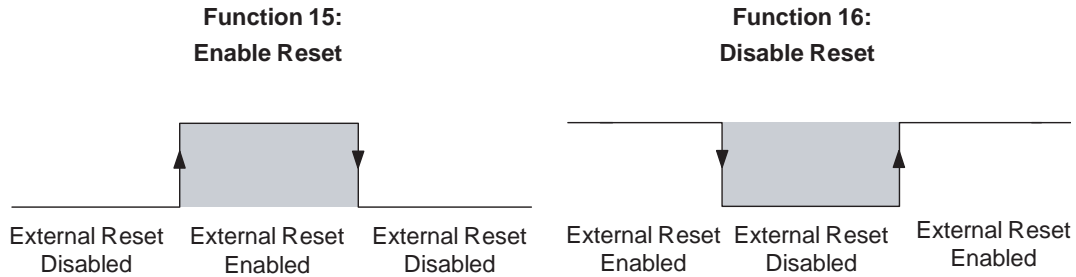

In order to be able to reset a Counter with Function 5, 6, 11, 12, 13 or 14, resetting must be Enabled by setting the Software Enable Reset Bit. Refer to 3-6 "Reset Signals" for detailed information about resetting Counters.

Digital Input Status

The status of the two Digital Inputs is reflected by their corresponding bits in CIO. You can use these bits as event flags in the Ladder Program.

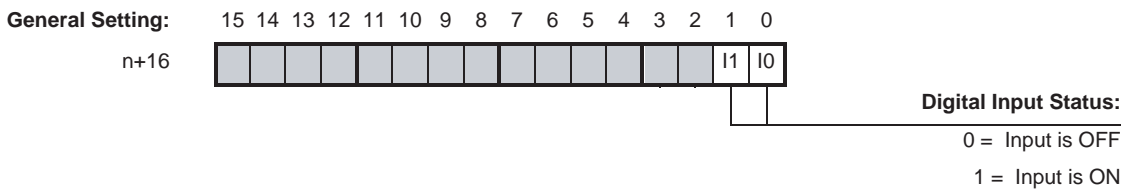

Bits 0 and 1 correspond to the Physical Digital Inputs I0 and I1.

The above-mentioned Digital Input Status Word reflects the status of all Digital Inputs. However, very short pulses on the Digital Inputs (shorter than the PLC-cycle or shorter than the time the Data Transfer Busy bit is ON for IOWR-instruction execution), may not be seen in the Digital Status Word.

Action Status

The Preset, Reset and Capture actions can be detected via CIO. Each action has a corresponding bit which is ON for exactly one PLC-cycle-time after the occurrence of that action. You can use these bits in the Ladder Program to take the appropriate action.

Z-Input Status

For each counter the Z-input status is reflected in CIO. The bit is ON for exactly one PLC-cycle-time after the Z-input has been activated.

Counting Direction

For every Counter the (up or down) counting direction is indicated and can be used in the Ladder Program.

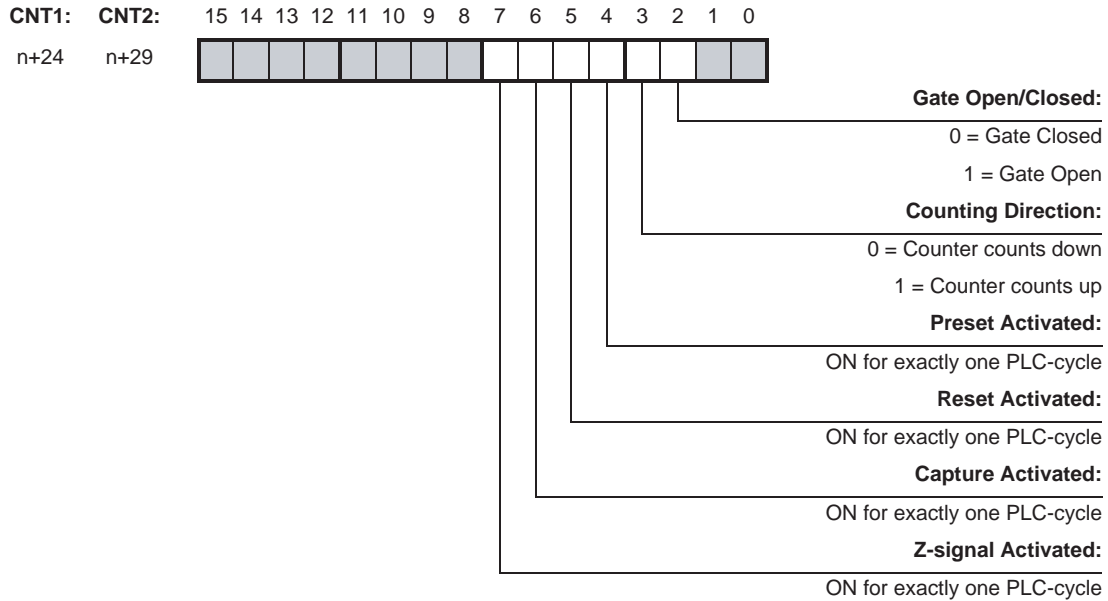

The Reset, Preset, Capture and Z-signal Activated Bits are ON for exactly one PLC-cycle after the occurrence of a (short) pulse which was detected since the previous I/O Refresh.

3-5 Output Control

Output Control Mode

The 32 Outputs (2 external and 30 internal) of the High-speed Counter Unit can be controlled automatically in two ways:

- Range Mode. In Range Mode you can define up to a maximum of 32 Ranges per Counter. The Outputs are controlled according to the Counter Value being within Range Limits. For a detailed description about Range Mode refer to 3-5-1 "Range Mode".
- Comparison Mode. In Comparison Mode you can define up to a maximum of 32 Comparison Values per Counter. The Outputs are controlled according to the direction in which the Counter Value crosses the Comparison Value. For a detailed description about Comparison Mode refer to 3-5-2 "Comparison Mode".

If the Unit is configured for Range Mode all two Counters will operate in Range Mode. If the Unit is configured for Comparison Mode all two Counters will operate in Comparison Mode.

Besides automatically, the Digital Outputs can also be controlled manually (refer to 3-5-3 "Manual Output Control").

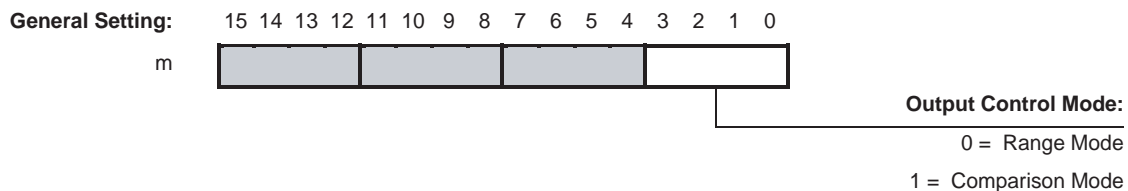

Unit Output Pattern

Both in Range and Comparison Mode the 32 Outputs of the Unit are represented by the Unit Output Pattern. The Unit uses the Unit Output Pattern internally to control the Outputs. The Unit Output Pattern consists of 30 Soft (internal) Outputs and 2 Digital Outputs. The two Digital Outputs represent the Physical Outputs O0 and O1 of the Unit.

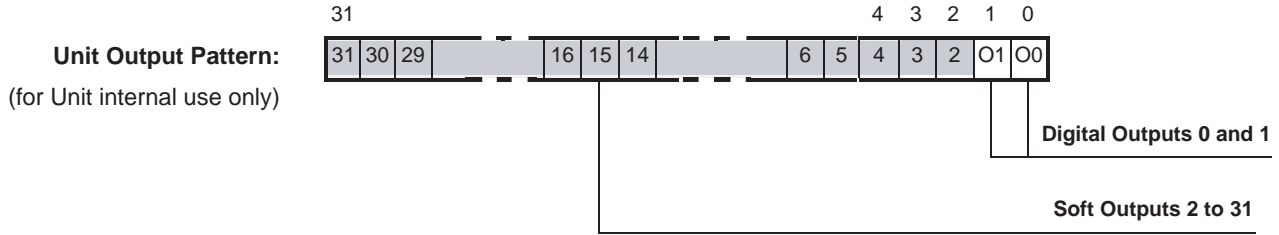

Digital Outputs 0 and 1 correspond with the Physical Digital Outputs O0 and O1.

Output Status

The status of the Digital Outputs is reflected by their corresponding bits in CIO and can be used as event flags in the Ladder Program. The Soft Outputs for instance can be used in the Ladder Program to control outputs of an external Digital Output Unit.

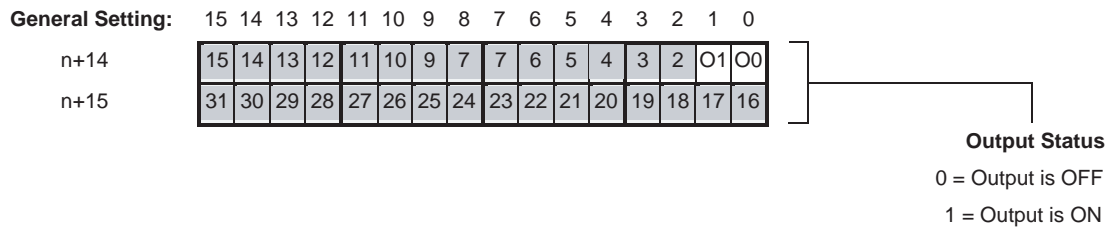

- = Digital Output
(corresponding with Digital Outputs O0 and O1)
- = Soft Output
(corresponding with Soft Outputs 2-31)

Note Every Soft and Digital Output can be configured to generate an Interrupt to the CPU. For details refer to 4-6-1 "Outputs Generating Interrupts".

3-5-1 Range Mode

If the Unit is configured to control the Outputs in Range Mode, this Mode can be applied to Circular Counters or Linear Counters (refer to 3-2-2 "Circular Counter" and 3-2-3 "Linear Counter" for more information).

Example Range Mode with Linear Counter

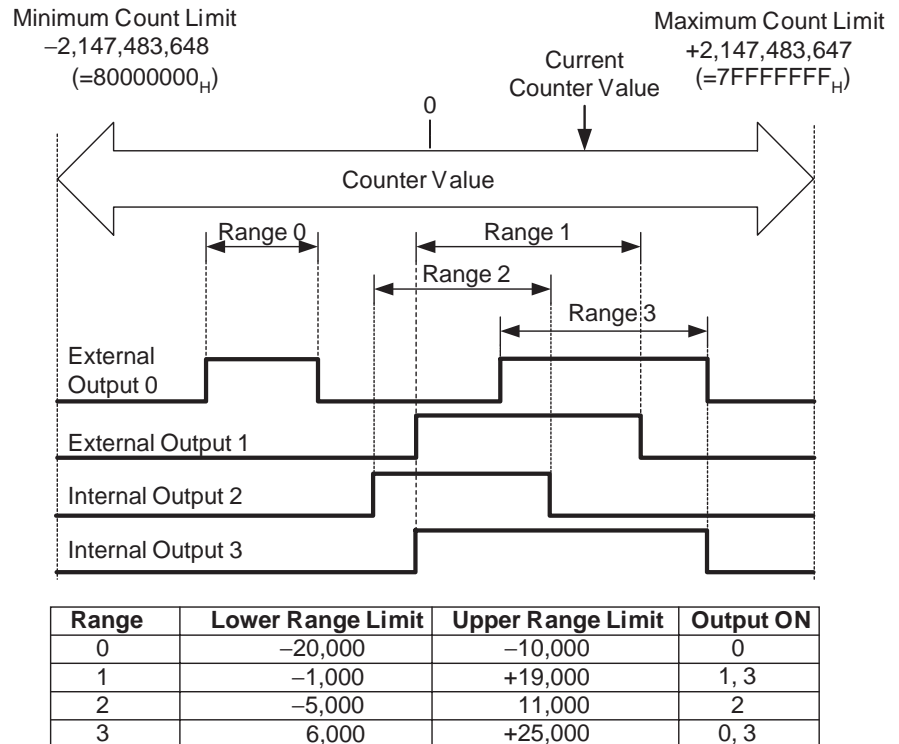

In this example four Ranges are specified. The configuration data of the Counter shows that:

- Output 0 must be ON for Counter Values within Range 0.
- Output 1 and 3 must be ON for Counter Values within Range 1.
- Output 2 must be ON for Counter Values within Range 2.
- Both of the Outputs 0 and 3 must be ON for Counter Values within Range 3.

In the above example the Counter Value is within Range 1 and 3 and consequently the Outputs 0, 1 and 3 are turned ON.

Example Range Mode with Circular Counter

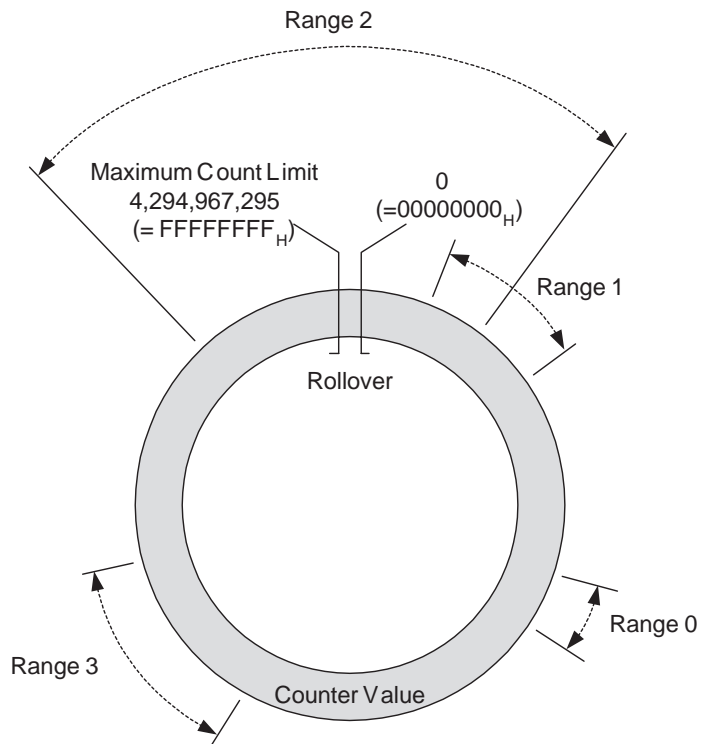

Range	Lower Range Limit	Upper Range Limit	Output ON
0	60,000	80,500	0
1	500	45000	1, 3
2	37,000,000	6000	2
3	99,000	150,000	0, 3

This example shows the Range Mode applied to a Circular Counter.

3-5-1-1 Range Mode Overview

The following figure gives an overview on configuring Counters in Range Mode.

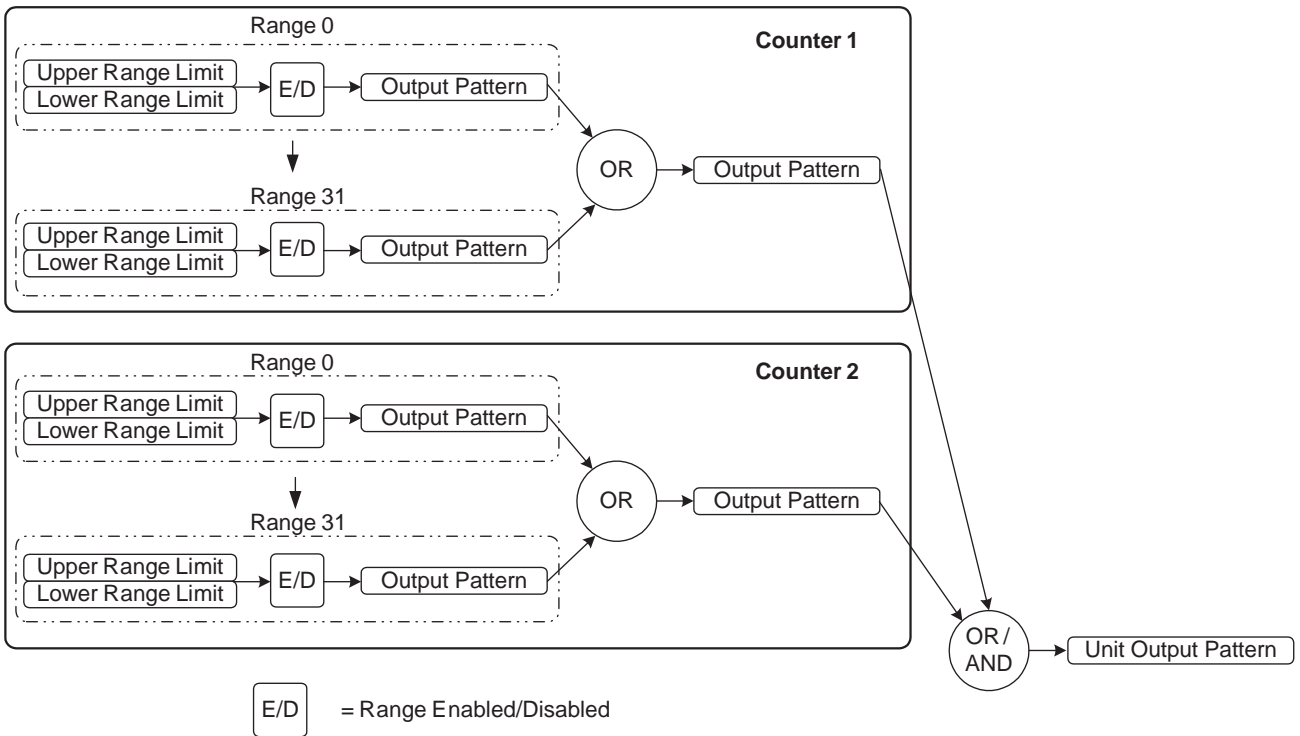

How to configure Counters in Range Mode is described on the next pages.

3-5-1-2 Configuration and operation in Range Mode

Specifying Range-Data

In Range Mode every Counter can be assigned up to a maximum of 32 Ranges. The Data of every Range is contained by 3 double words:

- Lower Range Limit, specifying the Lower Limit of the Range
- Upper Range Limit, specifying the Upper Limit of the Range
- Output Pattern, specifying which Outputs have to be activated when that Range is active

The Counter Type (Circular or Linear) determines the range in which the Upper and Lower Limits can be set. For Circular Counters this range is 00000000_H-FFFFFFFF_H and for Linear Counters this range is 80000000_H-7FFFFFFF_H. For Linear Counters the Upper Range Limit must be greater than the Lower Range Limit. The Unit will generate an error if the Upper Range Limit ≤ Lower Range Limit (refer to 5-2 "Error codes" for more details). For Circular Counters, the Upper Range Limit can be set lower than the Lower Range Limit.

To configure a Counter in Range Mode for every Range that you want to use the Range-Data must be set. Each data-item is specified by two words (=32 bits). For the exact memory location to set the Range-Data refer to 4-2-1 "Memory Mapping".

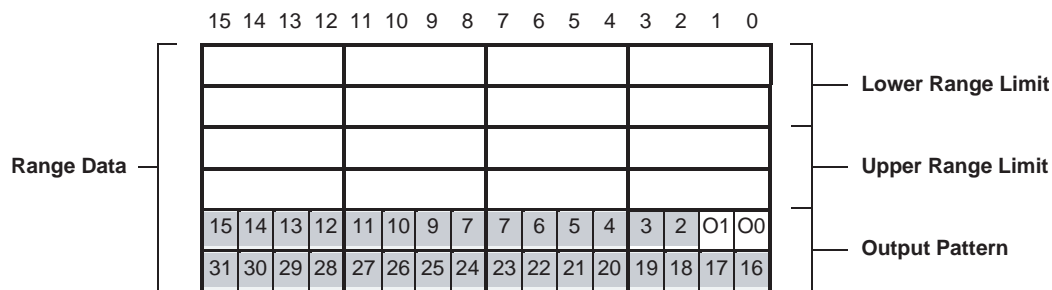

In the Output Pattern the Outputs are represented by:

- = Digital Outputs 0-1
(corresponding with Physical Digital Outputs O0 and O1)
- = Soft Outputs 2-31

In the Output Pattern of the Range every single Output can be configured to turn ON when that Range is active. To configure an Output to turn ON you must set the corresponding bit to 1. If multiple Ranges of a Counter are active at the same time, the Output Patterns of those Ranges are logically OR'ed to become the Output Pattern of that Counter.

- Note**
1. The Counter Range-Data can also be changed during actual operation using the IOWR-instruction. Refer to 4-3 "IOWR-Instruction" for more details.
 2. In Range Mode it is possible to apply Hysteresis to Ranges in order to prevent Digital Outputs from toggling due to unwanted oscillating of an encoder. Refer to 3-7-3 "Hysteresis" for detailed information.
 3. Precautions When Setting Range Data
 - Comparison Stoppage during Comparison of Ranges
The comparison operation stops for 1.5 ms from when the High-speed Counter Value falls within the Upper Range Limit or Lower Range Limit for

the Range Data. However, the comparison does not stop for other Counters.

Set the Range Data considering the time when the comparison is stopped. For example, for the Range table shown in the following diagram, approximately 4.8 counts occur during 1.5 ms when a 3.2 kHz pulse is input. This means that comparison does not occur for Counter Values 101, 102, 103, and 104. During this period, the Output set under the Output Pattern does not turn ON even if the Counter Value is within the Range Data range. Comparison starts again after this 1.5 ms has elapsed.

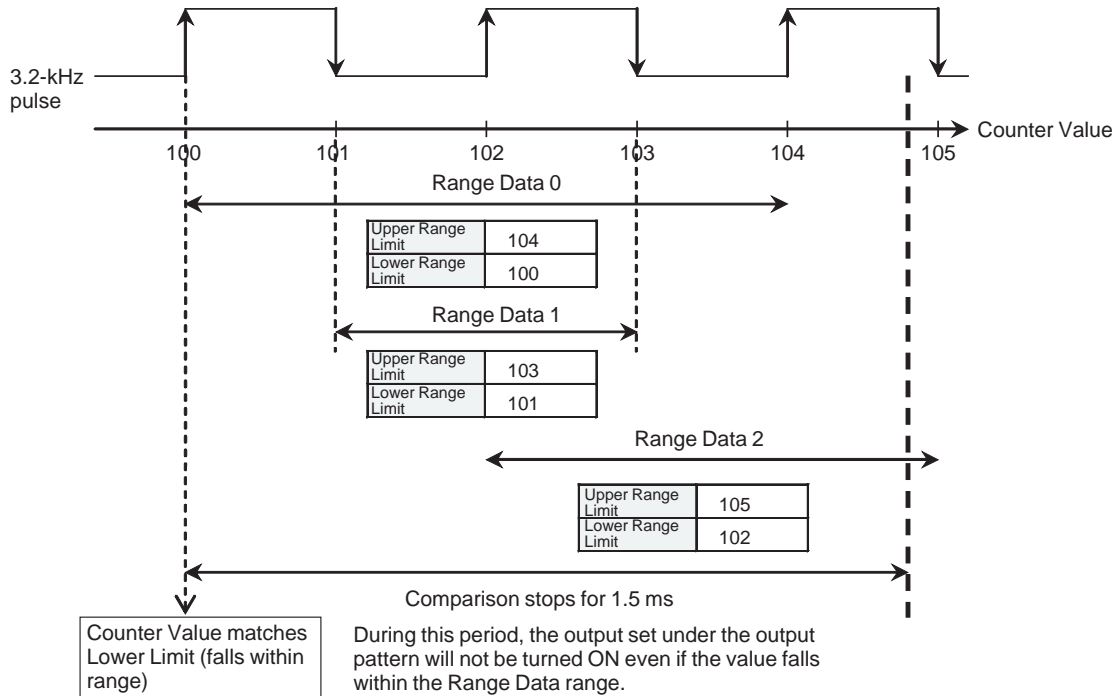

- Comparison Stoppage When IOWR and IORD-instructions Executed**

Comparison is stopped during the execution of IOWR/IORD-instructions and remains stopped until the processing of the instruction has been completed. The Data Transfer Busy bit is ON during this time. This stopping of comparison during the execution of IOWR/IORD-instructions affects Counter comparisons for all counters. Set the Range Data considering that comparisons are stopped by execution of IOWR/IORD-instructions. Refer to Appendix E "IORF and IOWR/IORD-instruction Execution Times" for information on execution times for IOWR/IORD-instructions.

Reflecting Active / Not Active Ranges

A Range becomes active if: Lower Range Limit ≤ Counter Value ≤ Upper Range Limit. Whether or not a Range is active is reflected in CIO for each Counter.

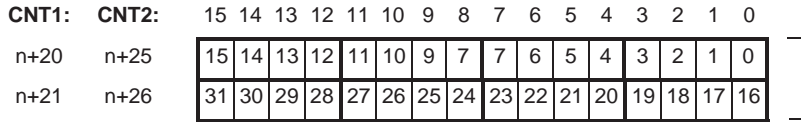

= Range 0-31

Active Ranges:
 0 = Range Active
 1 = Range not Active

Range Active: Lower Range Limit ≤ Counter Value ≤ Upper Range Limit
 Range not Active: Counter Value < Lower Range Limit
 Counter Value > Upper Range Limit

Note Lower Range Limit = Upper Range Limit can be set under the Range conditions.

Enabling and Disabling of Ranges

Every single Range can be enabled or disabled. If a Range is disabled (by default) its Output Pattern will be ignored in the Unit Output Pattern calculation. If a Range is enabled the Output Pattern of that Range will be applied to the Output Pattern of the corresponding Counter when that Range becomes active. To Enable/Disable Ranges of Counters refer to the following:

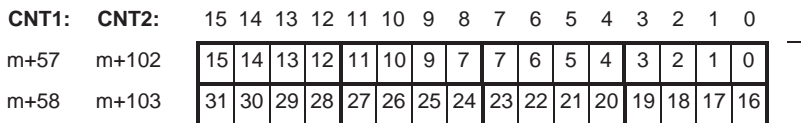

= Range 0-31

Range Enable Data:
 0 = Range Disabled
 1 = Range Enabled

Note Enabling/Disabling of Ranges can also be done on the fly by using IOWR-instructions. Refer to 4-3 "IOWR-Instruction" for more details.

Logically AND/OR Counter Output Patterns

If the Unit is in Range mode, the Output Patterns of the two Counters are (by default) logically OR'd and consecutively applied to the Unit Output Pattern. Depending on the requirements of your application you can also choose to AND the Counter Output Patterns before they are applied to the Unit Output Pattern.

If multiple Counters are used together to control an application, you have the option to logically AND or OR the Counter Output Patterns to become the Unit Output Pattern. In this way it is possible to turn Outputs ON or OFF depending on Ranges being active of multiple Counters. For instance, it is possible to turn an Output ON when both a Range of Counter 1 and a Range of Counter 2 are active. To configure the Unit to AND the Counter Output Patterns refer to the following.

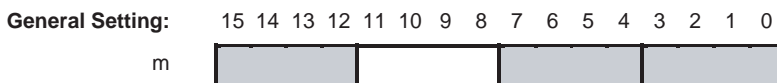

AND/OR Counter Output Patterns:
 0 = Logically OR Counter Output Patterns
 1 = Logically AND Counter Output Patterns

Note The Counter Output Patterns of Counters which are configured to use no (i.e. zero) Ranges, are ignored in the AND-calculation of the Unit Output Pattern. Like this, Counters that you do not want to use, do not influence the AND-calculation of the Unit Output Pattern. If both the Counters are configured to use no Ranges, the output patterns for both outputs will be all OFF.

3-5-2 Comparison Mode

If the Unit is configured to control the Outputs in Comparison Mode, this Mode can be applied to Circular Counters or Linear Counters (refer to 3-2-2 "Circular Counter" and 3-2-3 "Linear Counter" for more information).

Example Comparison Mode with Linear Counter

Minimum Count Limit
-2,147,483,648
(=80000000_H)

Maximum Count Limit
+2,147,483,647
(=7FFFFFFF_H)

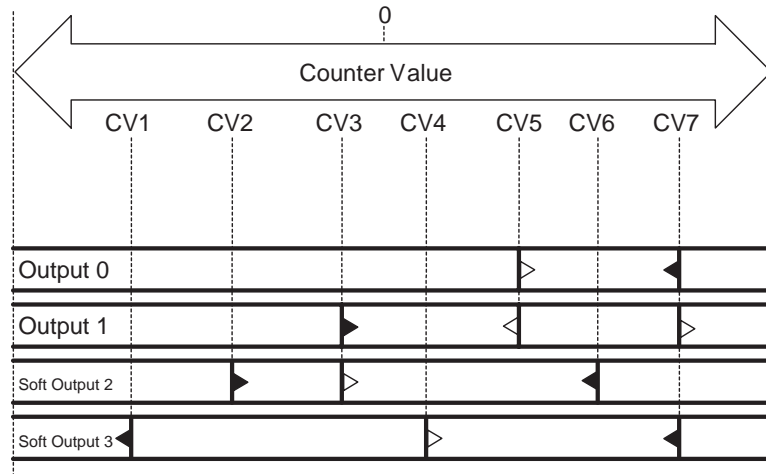

= Set in positive (+) direction = Reset in positive (+) direction
 = Set in negative (-) direction = Reset in negative (-) direction

CV	Value	CV Crossing	Out0	Out1	Soft2	Soft3
1	-87,000	+CV crossing				
		-CV crossing				R
2	-56,000	+CV crossing			R	
		-CV crossing				
3	-15,000	+CV crossing		R	S	
		-CV crossing				
4	+18,000	+CV crossing				S
		-CV crossing				
5	+46,000	+CV crossing	S			
		-CV crossing		S		
6	+70,000	+CV crossing			R	
		-CV crossing				
7	+108,000	+CV crossing				
		-CV crossing	R	S		R

In this example 7 Comparison Values are specified. On reaching a Comparison Value an Output can be Set or Reset depending on the crossing direction. If the CV is crossed in the positive counting direction (+CV crossing) or negative count-

ing direction (-CV crossing), one or multiple Outputs can be Set (S) or Reset (R). For example Output 0 is Set on crossing CV5 in the positive counting direction and Reset on crossing CV7 in the negative counting direction. The crossing of CV3 in the positive counting direction results in the Setting of Output 2 and the Resetting of Output 1.

Example Comparison Mode with Circular Counter

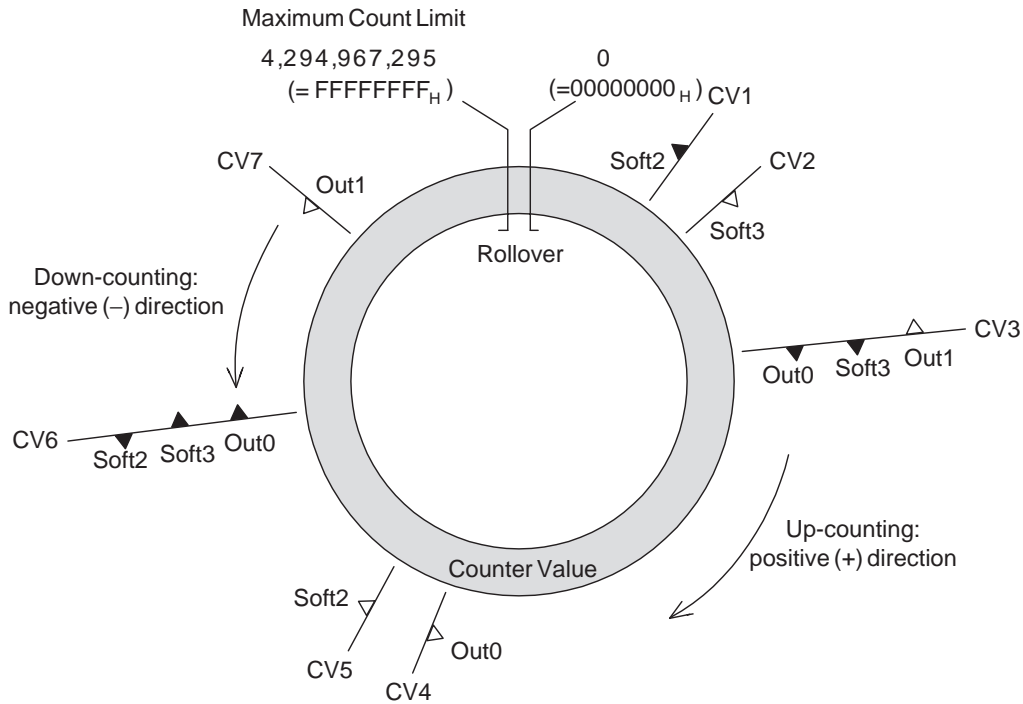

- ▶ = Set in positive (+) direction
- ◀ = Set in negative (-) direction
- ▷ = Reset in positive (+) direction
- ◁ = Reset in negative (-) direction

CV	Value	CV Crossing	Out0	Out1	Soft2	Soft3
1	750	+CV crossing				
		-CV crossing			R	
2	1,800	+CV crossing				S
		-CV crossing				
3	59,000	+CV crossing	R			R
		-CV crossing		S		
4	85,000	+CV crossing				
		-CV crossing	S			
5	90,000	+CV crossing			S	
		-CV crossing				
6	108,000	+CV crossing	R			R
		-CV crossing			R	
7	125,000	+CV crossing				
		-CV crossing		S		

This example shows the Comparison Mode applied to a Circular Counter.

3-5-2-1 Comparison Mode Overview

The following figure gives an overview on configuring Counters in Comparison Mode.

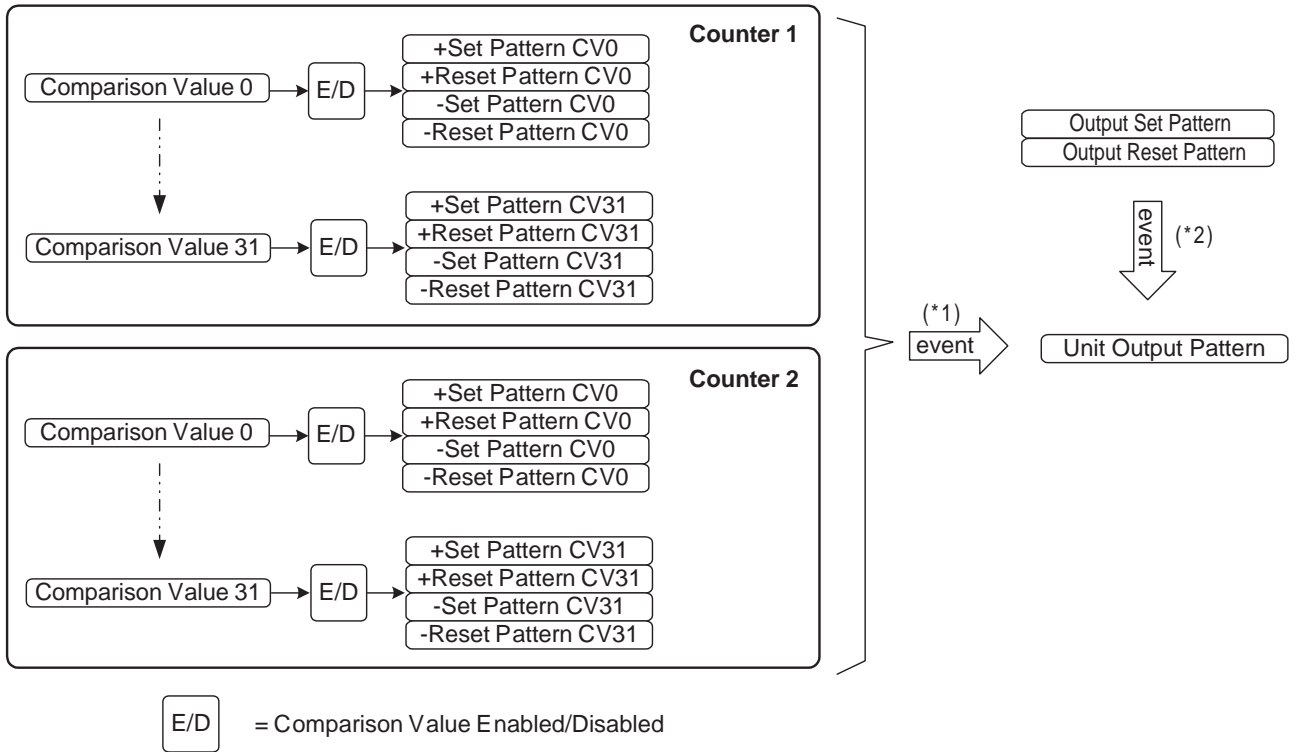

(*1) Event = Crossing of Comparison Value

(*2) Event = Preset or Reset Action

How to configure Counters in Comparison Mode is described on the next pages.

3-5-2-2 Configuration and operation in Comparison Mode

Specifying Comparison-Data

In Comparison Mode every Counter can be assigned up to a maximum of 32 Comparison Values. The Data of every Comparison Value (CV-Data) is contained by 5 double words:

- Comparison Value (can be set between 80000000_H – 7FFFFFFF_H for a Linear Counter and between 00000000_H – FFFFFFFF_H for a Circular Counter)
- Output Set Pattern for the positive counting direction (+Set Pattern CV'n'), specifying which Outputs must be Set on reaching that CV in the positive counting direction (0 = No Change, 1 = Set Output)
- Output Reset Pattern for the positive counting direction (+Reset Pattern CV'n'), specifying which Outputs must be Reset on reaching that CV in the positive counting direction (0 = No Change, 1 = Reset Output)
- Output Set Pattern for the negative counting direction (-Set Pattern CV'n'), specifying which Outputs must be Set on reaching that CV in the negative counting direction (0 = No Change, 1 = Set Output)
- Output Reset Pattern for the negative counting direction (-Reset Pattern CV'n'), specifying which Outputs must be Reset on reaching that CV in the negative counting direction (0 = No Change, 1 = Reset Output)

To configure a Counter in Comparison Mode for every Comparison Value that you want to use the CV-Data must be set. Each data-item is specified by two words (=32 bits). For the exact memory location of the CV-Data, refer to 4-2-1 "Memory Mapping".

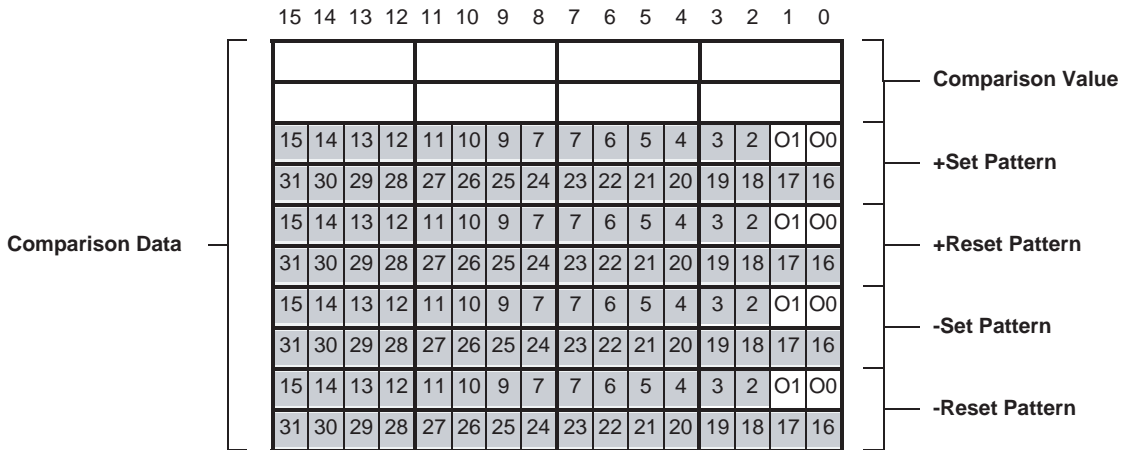

In the +/- Set and Reset Patterns the Outputs are represented by:

- = Digital Outputs 0-1 (corresponding with Physical Digital Outputs O0 and O1)
- = Soft Outputs 2-31

On reaching the Comparison Value:

- | | |
|------------------------------|--------------------------------|
| + and – Set Patterns: | + and – Reset Patterns: |
| 0 = No Change | 0 = No Change |
| 1 = Set Output | 1 = Reset Output |

Note Precautions When Setting Comparison Data

- Comparison Stoppage When Comparison Target Reached

When the High-speed Counter Value reaches the target value for Comparison Data, comparison stops for 1.5 ms. However, comparison for other counters does not stop.

Set the Comparison Data considering the time when the comparison is stopped.

For example, for the Comparison table shown in the following diagram, approximately 4.8 counts occur during 1.5 ms when a 3.2 kHz pulse is input. This means that comparison does not occur for Counter Values 101, 102, 103, and 104. During this period, the Output set under the Output Pattern does not turn ON.

Comparison starts again after this 1.5 ms has elapsed.

At this time, the processing returns to the stoppage period and Comparison Data 1 and 2 are executed at the same time.

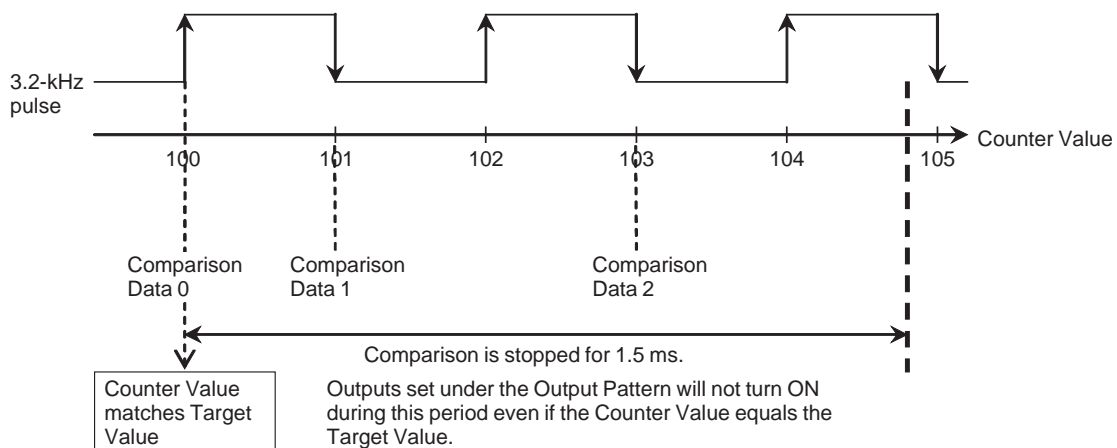

- Comparison Stoppage for IOWR- and IORD-instruction Execution

Comparison is stopped during the execution of IOWR/IORD-instructions and remains stopped until the processing of the instruction has been completed. The Data Transfer Busy bit is ON during this time.

This stopping of comparison during the execution of IOWR/IORD-instructions affects Counter comparisons for all counters.

In contrast to Range Data, comparison occurs once during the stoppage period after the Data Transfer Busy bit turns OFF.

However, when Comparison Data is rewritten using an IOWR-instruction, the Comparison Result is refreshed using the new Comparison Data and the current Counter Value, which means the result of the comparison during the stoppage is not reflected.

Refer to Appendix E "IOWR and IORD-instruction Execution Times" for information on execution times for IOWR/IORD-instructions.

- Note**
1. Multiple Comparison Values of a specific Counter may not have the same value. The Unit will generate an error if multiple CV's have the same value (refer to 5-2 "Error codes" for more details).
 2. CV-Data can also be changed on the fly. Refer to 4-3 "IOWR-Instruction" for more details.
 3. The Digital Outputs are Set/Reset in the chronological order of reaching the CV's. After reaching a (new) CV the (old) Unit Output Pattern is updated.

4. In case for a CV both a Set and a Reset in one and the same counting direction for a specific Output are defined, the Reset has priority.
5. The output can be set to Set, Reset, or *No Change* when a target value is reached both for incrementing and decrementing. Each time, the output pattern for both counters will change in the order targets are reached.
6. Do not change the counting direction quickly near a target value. If the direction is changed near a CV, the direction in which the target was reached (incrementing or decrementing) may be incorrectly detected.

Reflecting Active / Not Active Comparison Values

A Comparison Value becomes active if the Counter Value is greater than or equal to that Comparison Value. Whether or not a CV is active is reflected in CIO for each Counter.

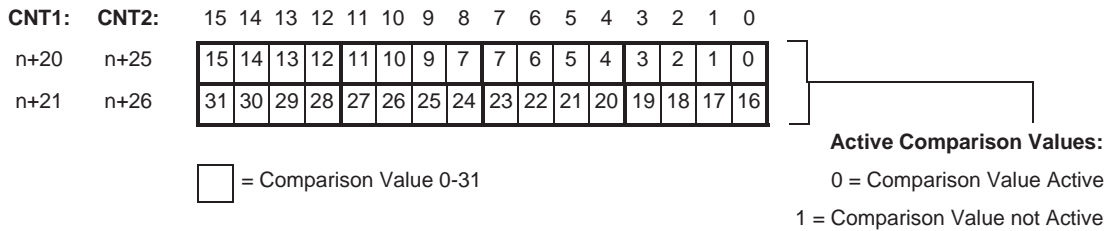

Comparison Value Active: Counter Value ≥ Comparison Value

Comparison Value not Active: Counter Value < Comparison Value

Note Each time a CV is crossed (in positive or negative counting direction) an Output can be Set, Reset or remain Unchanged. In this way, every Counter is able to change the Unit Output Pattern. Therefore, the Unit Output Pattern is updated by all four Counters in the chronological order of crossing the CV's.

Enable / Disable Comparison Values

Every single CV can be enabled or disabled. If a CV is disabled (by default) no action will be taken on reaching that CV. If a CV is enabled, depending on the direction of counting, the Set/Reset Output Patterns will be applied to the Unit Output Pattern on reaching that CV. To Enable/Disable CV's of Counters refer to the following:

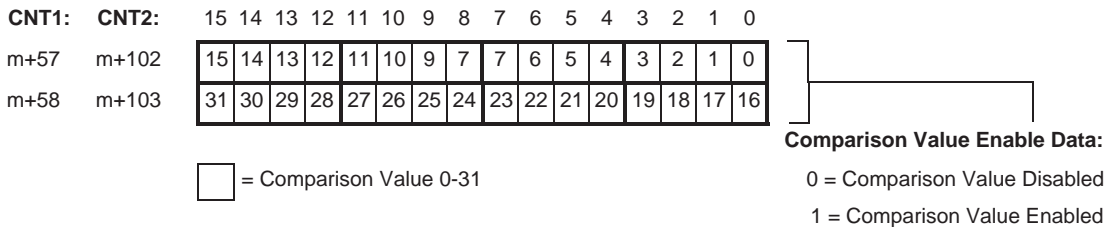

Note Enabling/Disabling of CV's can also be done on the fly by using IOWR-instructions. Refer to 4-3 "IOWR-Instruction" for more details.

Updating Unit Output Pattern with Preset or Reset Action

Besides by crossing CV's the Unit Output Pattern can also be updated by a Preset or a Reset action. To trigger a Preset or Reset action refer to 3-4 "Digital Input Functions" and 3-6 "Reset Signals". Every Preset or Reset Action will then update the Unit Output Pattern according to the predefined Output Set and Output Reset Patterns. You can define an Output to be Set, Reset or remain Unchanged (similar as on reaching a Comparison Value).

CNT1:	CNT2:	15	14	13	12	11	10	9	8	7	6	5	4	3	2	1	0
m+59	m+104	15	14	13	12	11	10	9	7	7	6	5	4	3	2	O1	O0
m+60	m+105	31	30	29	28	27	26	25	24	23	22	21	20	19	18	17	16
m+61	m+106	15	14	13	12	11	10	9	7	7	6	5	4	3	2	O1	O0
m+62	m+107	31	30	29	28	27	26	25	24	23	22	21	20	19	18	17	16

Output Set Pattern
Output Reset Pattern

= Digital Outputs 0-1
(corresponding with Physical Digital Outputs O0 and O1)
 = Soft Outputs 2-31

On triggering a Preset or Reset action:

Output Set Pattern: **Output Reset Pattern:**
0 = No Change 0 = No Change
1 = Set Output 1 = Reset Output

Note In case for a Preset or Reset action for a specific Output both a Set and a Reset is defined the Reset has priority.

3-5-3 Manual Output Control

Manual or Automatic Control

The Digital Outputs of the High-speed Counter Unit can be controlled automatically or manually. Automatic control of the Digital Outputs results in the automatic update of the Unit Output Pattern. The Unit Output Pattern will then be updated according to the Mode for which the Unit is configured (Range Mode or Comparison Mode). By default (=0) the Unit is configured for Automatic Output Control.

To control the Physical Outputs (0-1) manually, Manual Output Control must be selected by setting the Automatic/Manual Output Control Bit to 1. Now it is possible to force ON and OFF the Physical Digital Outputs by setting and resetting the corresponding bits respectively. Manual Output Control can be used for test purposes (wiring) when the Unit is being installed.

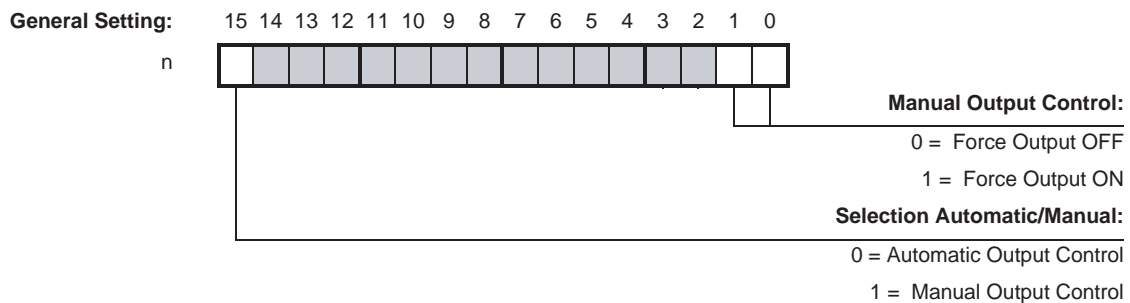

Bits 0 and 1 correspond to the Physical Digital Outputs O0 and O1

3-5-4 Output Control Configuration

NPN or PNP Output Driver

Every single Digital Output (0-1) can be used in a NPN- or PNP-configuration depending on your application needs. By setting the corresponding bit in DM a selection can be made between a NPN- or PNP Output Driver. By default the NPN Output Driver is selected.

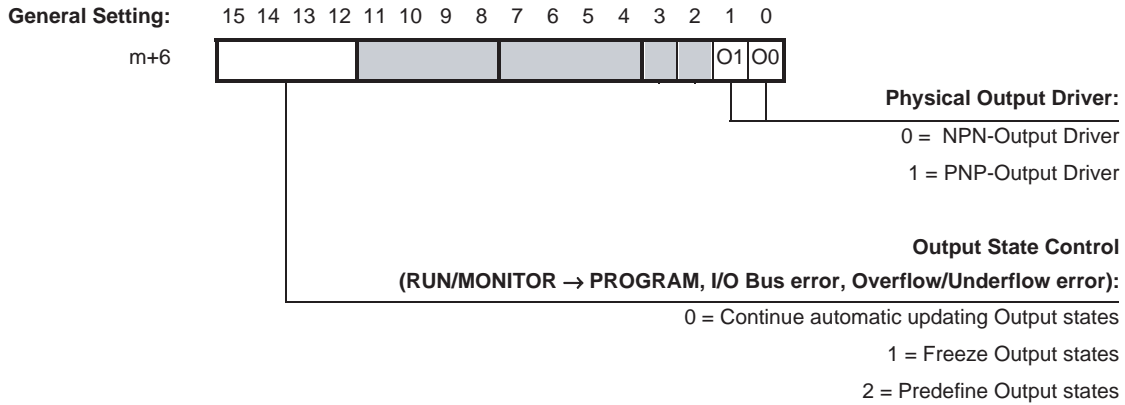

Bits 0 and 1 correspond to the Physical Digital Outputs O0 and O1.

Output State Control

The state control of the 32 Outputs, in case the operating mode of the PLC-CPU is changed from RUN/MONITOR → PROGRAM, an I/O Bus error or an Overflow/Underflow error occurs, can be configured. By default (=0) the Unit will continue to update the state of the Outputs automatically according to the mode in which the Unit is (Range Mode or Comparison Mode). You can also choose to freeze the state of the Outputs (=1) in which case the last state of the Outputs, as they were just before the operating mode is changed or just before an I/O Bus- or Overflow/Underflow error occurs, is applied to the Outputs. If you choose to predefine the state of the Outputs (=2), an Output pattern can be (pre-) defined that will be applied to the Outputs when the operating mode is changed or when an I/O Bus- or Overflow/Underflow error occurs.

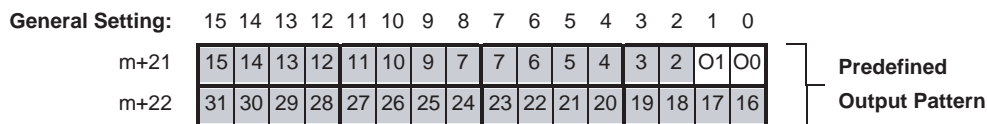

- = Digital Outputs 0-1
(corresponding with Physical Digital Outputs O0 and O1)
- = Soft Outputs 2-31

After changing the operating mode from RUN/MONITOR → PROGRAM and after an I/O Bus- or Overflow/Underflow error has occurred :

- 0 = Output is turned OFF
- 1 = Output is turned ON

3-6 Reset Signals

For every Counter a reset of the Counter Value to zero can be triggered by the following Sources:

- Software Reset Bit
- Digital Input
- Z-signal

In order for a Digital Input or the Z-Signal to trigger a Reset this must be enabled by the Software Reset Enable Bit. Additionally a Digital Input can be assigned the function of Reset Enable (Function 15, refer to 3-4 "Digital Input Functions").

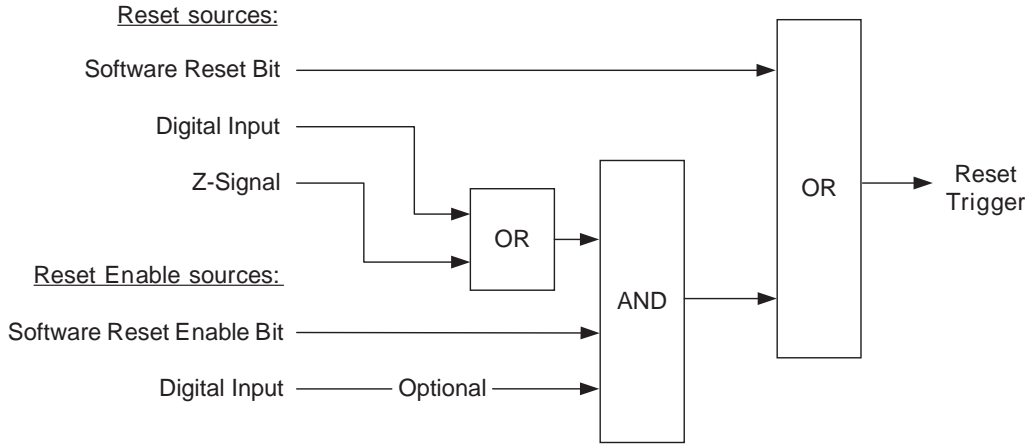

Software Reset Bit as Reset Source

For every Counter the Software Reset Bit can be used to trigger a Reset. The Software Reset Bit has priority over all other Reset Sources. Setting the Software Reset Bit triggers a Reset in the next I/O Refresh Cycle.

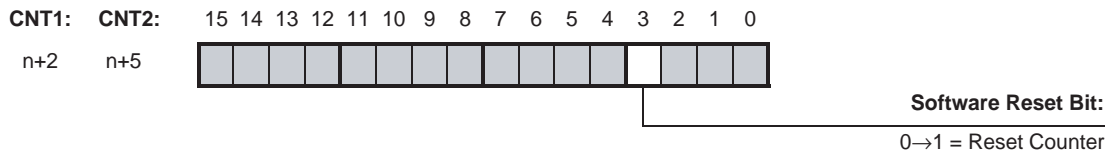

Digital Input as Reset Source

In order to use a Digital Input as Reset Source you must assign Function 5, 6, 11, 12, 13 or 14 to the corresponding Digital Input. Refer to 3-4 "Digital Input Functions" for more information.

Z-Input Signal as Reset Source

If you want to use the Z-Signal of an incremental encoder as a Reset Source this must first be enabled in DM. Using the Z-Signal can be enabled for every Counter.

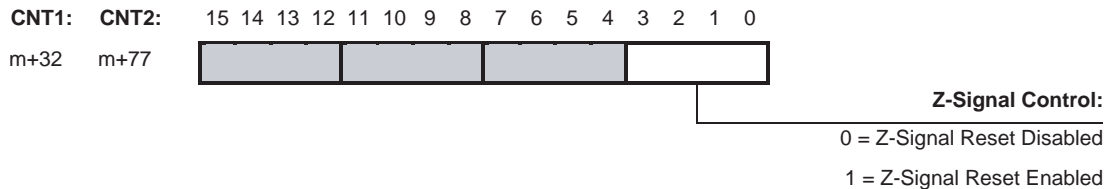

Software Reset Enable Bit as Reset Enable Source

Resetting the Counter Value to zero by Digital Input or Z-Signal must be enabled. Enabling can be done by setting the Software Reset Enable Bit in CIO for the corresponding Counter to 1.

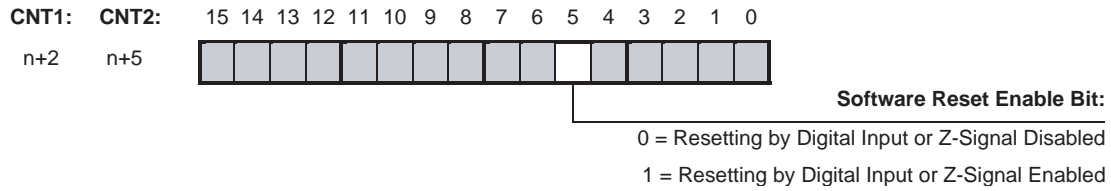

Digital Input as Reset Enable Source

In order to use a Digital Input as Reset Enable Source you must assign Function 15 or 16 (= Enable/Disable Reset) to the corresponding Digital Input. Refer to 3-4 "Digital Input Functions" for more information.

3-7 Extra Functions

3-7-1 Programmable Output Pulses

Depending on the requirements of your application, the timing characteristics of the two Digital Outputs of the High-speed Counter Unit can be modified. The Unit can be either in Range Mode or in Comparison Mode. The following functionality can be assigned to the Digital Outputs:

- Normal Functionality (= default)
- Output Turn ON Delay [1 ms to 9999 ms], to delay turning ON an Output
- Output Pulse Duration [1 ms to 9999 ms], to generate an Output pulse of a specified duration
- Combination of Output Turn ON Delay + Output Pulse Duration

The corresponding action is triggered by a rising edge of the Output (0-1) of the Unit Output Pattern and consequently applied to the corresponding Digital Output.

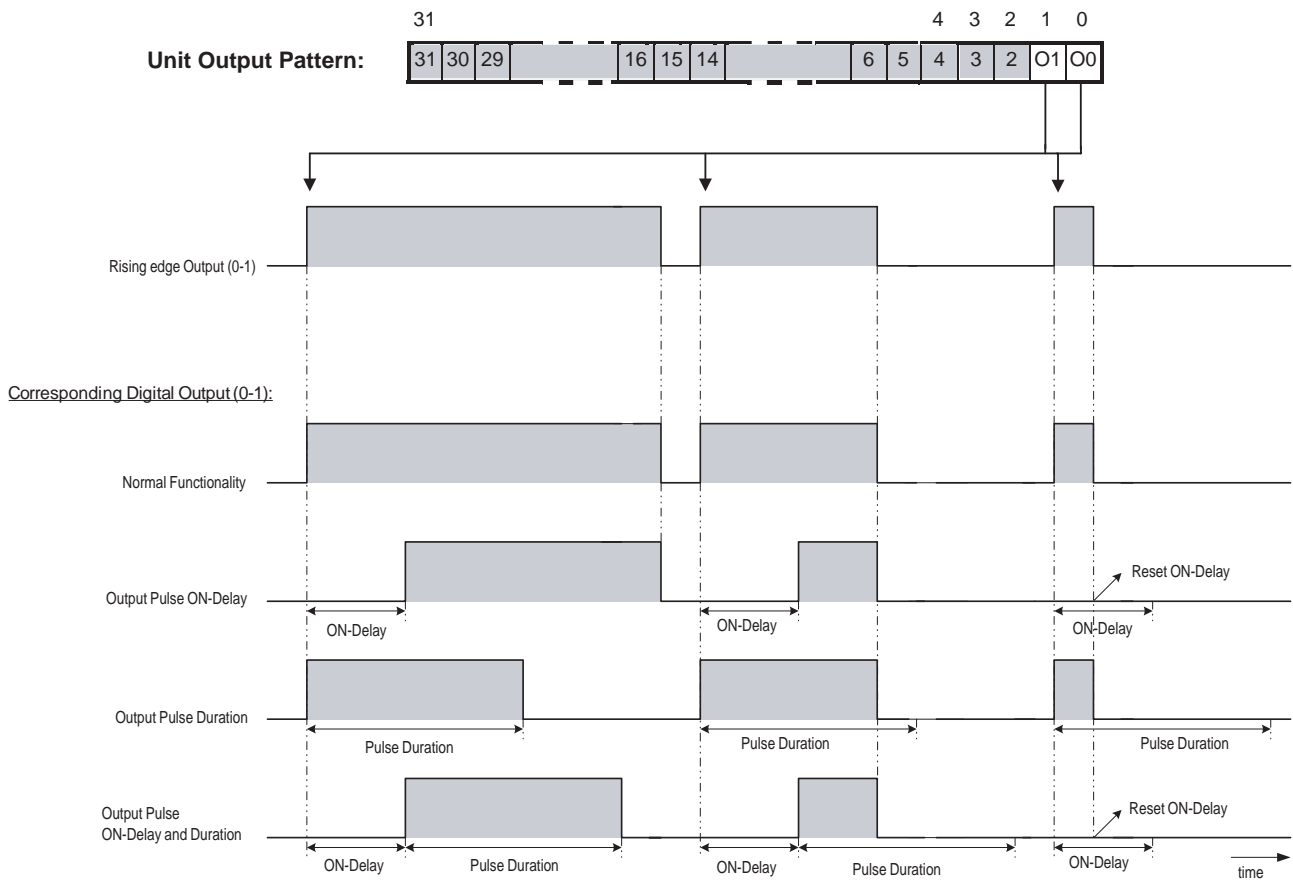

Normal Functionality

A Digital Output that is configured to have Normal Functionality will turn ON immediately after the corresponding bit of the Unit Output Pattern turns ON.

Output Pulse ON-Delay

A Digital Output that is configured to have an Output Pulse ON-Delay will turn ON after the ON-Delay has elapsed.

Output Pulse Duration

A Digital Output that is configured to have an Output Pulse Duration turns ON immediately and will stay ON for the specified Pulse Duration. After the Pulse Duration has elapsed the Digital Output turns OFF.

Note The status of the Outputs is reflected in CIO (words n+14, n+15). If a Digital Output is configured to have Programmable Output Pulse functionality, the actual physical status of the Output (Turn ON Delay and/or Pulse Duration included) is reflected in the corresponding bit in CIO.

Configuring Programmable Output Pulses

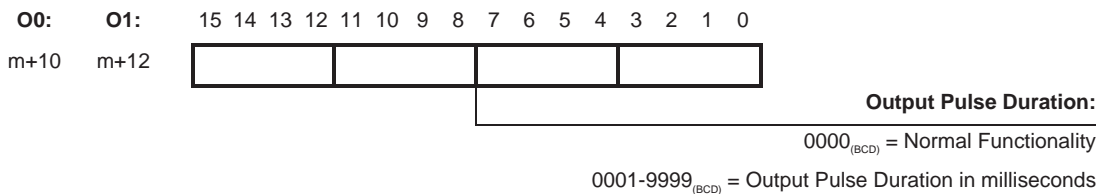
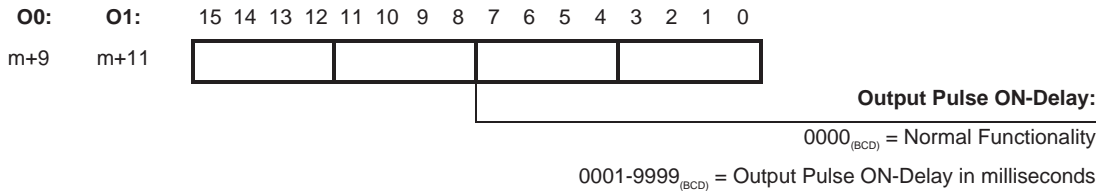

- Note**
1. A Digital Output to which an Output ON-Delay or Output Pulse is applied will turn OFF immediately after the corresponding Output (0-1) of the Output Pattern has turned OFF. An Output Pulse ON-Delay or Output Pulse Duration in progress will be reset immediately and the Digital Output is turned OFF or stays OFF.
 2. If an Output is switched ON manually (refer to 3-5-3 "Manual Output Control") and Programmable Output Pulse functionality has been assigned to that Output, then this functionality will not be applied to the Output. Instead, the Output is switched ON immediately.
 3. When applying an Output Pulse to a turn OFF a Digital Output, the output will appear to be OFF, but internally it will be treated as ON until it is reset when the range conditions are met or target is matched. If an attempt is made to set the output, the system will assume that it is already ON and it will remain OFF. Particularly with target values, configure reset conditions for output carefully.

3-7-2 Rate Measurement

For every Counter the Rate of the incoming pulses can be measured, for Units either in Range Mode or Comparison Mode. The measured Rate Values can be used in the Ladder Program for Frequency or Rotational Speed calculations or for monitoring purposes. Additionally, for every Counter two Rate Ranges can be configured, both consisting of a Lower- and Upper Rate Range Limit. For every Rate Range an Output Set & Reset Pattern can be defined to control all 32 outputs accordingly. Set/Reset actions as defined in this Output Set & Reset Pattern to control the Outputs, overrule the Unit Output Pattern for the corresponding Outputs. This allows you to detect too high or too low frequencies (and speeds) and enables you to control the Outputs accordingly.

Rate Value Calculation

If you want to use Rate Measurement for a Counter you must start by defining the Time Window. You can set the Time Window between 1 ms and 9999 ms, in steps of 1 ms (BCD). The number of pulses which are received during the Time Window are automatically calculated by subtracting the Counter Value at the beginning of the Time Window from the Counter Value at the end of the Time Window.

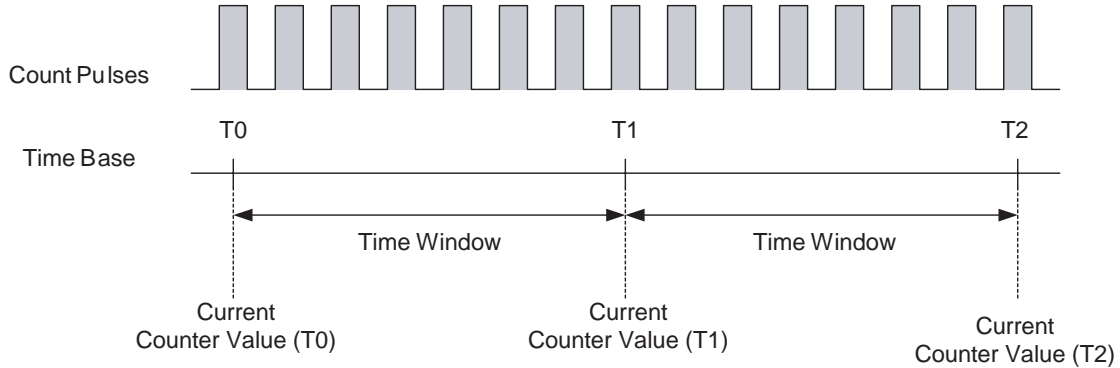

$$\begin{aligned} \text{Rate Value 1} &= \text{CCV} (T1) - \text{CCV} (T0) \\ \text{Rate Value 2} &= \text{CCV} (T2) - \text{CCV} (T1) \\ \dots \\ \text{Rate Value n} &= \text{CCV} (Tn) - \text{CCV} (T(n-1)) \end{aligned}$$

CCV = Current Counter Value
 Time Window = [1, 9999 ms]

Rate Measurement can be done for all Input Signal Types (refer to 3-3 "Input Signal Types"). Calculating the Rate Value in this way implies that a change of the counting direction during the Time-Window is reflected in the Rate Value. For illustration refer to the next example:

The Counter Value (T0) at the beginning of the Time-Window is +5. During the Time-Window 5 up counts and 15 down counts are received. The Counter Value (T1) at the end of the Time-Window will then be -5. The Rate Value is -10.

- Note**
1. For Phase Differential Signals (multiplication x2 and x4) pulses are counted on both edges of A or both edges of A and B respectively. If you want to calculate the pulse Rate Value for these signals, you must divide the measured Rate Values by 2 and 4 respectively.
 2. The pulse rate after presetting or resetting a counter will be the pulse rate calculated just prior to presetting or resetting.
 3. Calculations will be correct when a Ring Counter rolls over (goes from maximum value to 0 or from 0 to maximum value).
 4. The measurement interval normally varies by 125 μs and can vary by a maximum of 1 ms. If this variation becomes a problem, it is recommended that the pulse rate value be averaged in the ladder program.

Rate History Log File

The Rate Values, which are calculated during consecutive Time Windows, are stored in the Rate History Log File inside the Unit. The Rate History Log File can contain a maximum number of 64 most recent Rate Values.

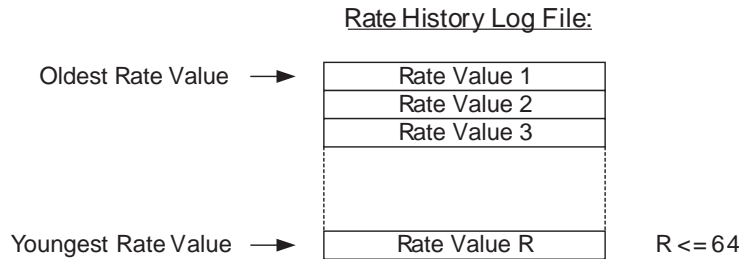

(The Rate Values occupy 2 words each)

The Rate Values can be read into your Ladder Program for further usage, by issuing an IORD-instruction. Like this, one or multiple Rate Values (with a maximum of 64) can be read. If you specify to read only one Rate Value the youngest Rate Value will be returned. If the Rate History Log File is full a new (youngest) Rate Value will overwrite the oldest Rate Value. Refer to 4-5-3-2 "Rate History Log File data" for detailed information.

Frequency Measurement

After the Rate Value is read into the Ladder Program this value can be used to calculate the Frequency [Hz] of the applied signals. The Frequency of the incoming pulses can be calculated by using the following formula:

$$\text{Frequency [Hz]} = \frac{\text{Rate Value}}{\text{Time-Window [s]}}$$

If for example the Time-Window is set to 2 seconds (= 2000 ms) and during the Time-Window 20,000 up counts are received (i.e. Rate Value = 20,000) the corresponding Frequency is 10,000 Hz.

Rotational Speed Measurement

After the Rate Value is read into the Ladder Program this value can also be used to calculate the Rotational Speed [rpm]. The Rotational Speed can indicate the speed of a motor in rotations per minute [rpm]. The Rotational Speed can be calculated by using the following formula:

$$\text{Rotational Speed [rpm]} = \frac{\text{Rate Value}}{\text{Encoder Resolution [P/R]}} \times \frac{60}{\text{Time-Window [s]}}$$

If you want to calculate the Rotational Speed you need to know the number of Pulses per motor or encoder revolution [P/R]. If for example the Time-Window is set to 1 second (= 1000 ms), the Encoder Resolution is 2,000 P/R and during the Time-Window 50,000 up counts are received (i.e. Rate Value = 50,000) the corresponding Rotational Speed is 1,500 rpm.

Configuring Rate Measurement

Rate Measurement can be configured by setting the Time-Window between 1 ms and 9999 ms (BCD). By default (=0) the Counters are configured to have no Rate Measurement.

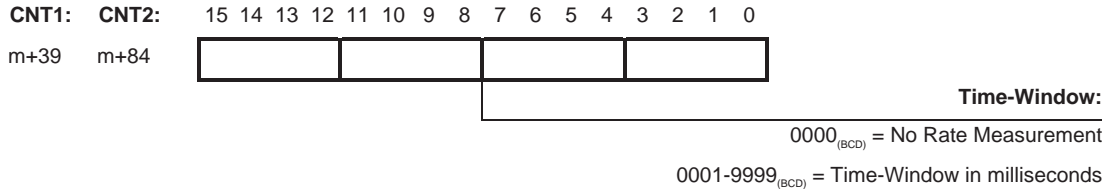

Rate Ranges

Besides the capability to measure (positive and negative) Rate Values for every Counter two Rate Ranges (Rate Range 0 and 1) can be configured. The Rate Ranges offer you the opportunity to undertake specific action (i.e. control the Unit Output Pattern) when the measured Rate Values have entered a Rate Range. Rate Ranges can represent Frequency Ranges or Rotational Speed Ranges, making it possible to undertake action at (too high or too low Alarm) Frequencies or Rotational Speeds.

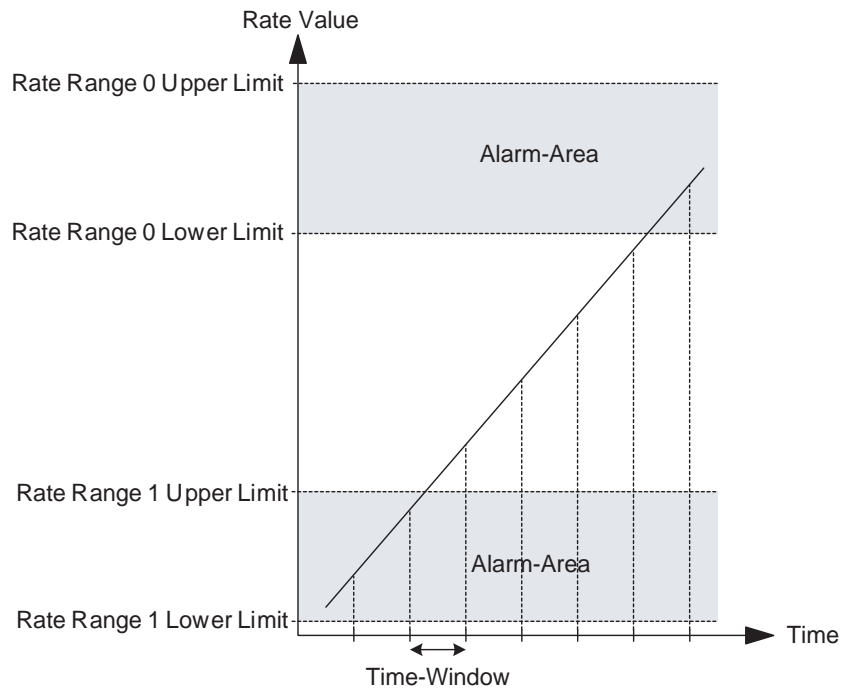

- The Data of every Rate Range is contained by 4 double words:
- Lower Rate Range Limit, specifying the Lower Rate Limit of the Rate Range
 - Upper Rate Range Limit, specifying the Upper Rate Limit of the Rate Range
 - Output Set Pattern, specifying which Outputs must be Set if the measured Rate Value is within the Lower- and Upper Rate Range Limits
 - Output Reset Pattern, specifying which Outputs must be Reset if the measured Rate Value is within the Lower- and Upper Rate Range Limits

The Upper Rate Range Limit must be greater than the Lower Rate Range Limit. The Unit will generate an error if the Upper Rate Range Limit \leq Lower Rate Range Limit (refer to 5-2 "Error codes" for more details). Every Rate Range can be enabled or disabled. If a Rate Range is disabled (by default) no action will be taken when the Rate Range becomes active. If a Rate Range is enabled the Set & Reset

Output Pattern of that Rate Range will be applied to the Unit Output Pattern when that Rate Range becomes active.

Reflecting Active / Not Active Rate Ranges

A Rate Range becomes active if: Lower Rate Range Limit ≤ Rate Value ≤ Upper Rate Range Limit. Whether or not a Rate Range is active is reflected in CIO for each Counter.

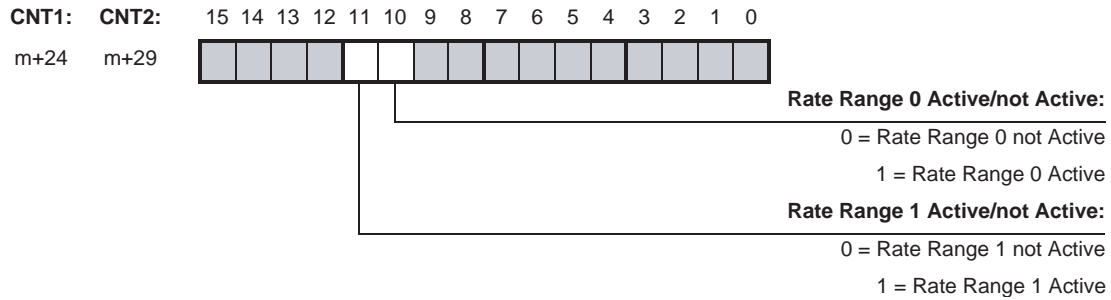

Note Rate Ranges may not overlap. If Rate Ranges overlap the Unit will generate an error (refer to 5-2 "Error codes" for more details).

Configuring Lower and Upper Rate Range Limits

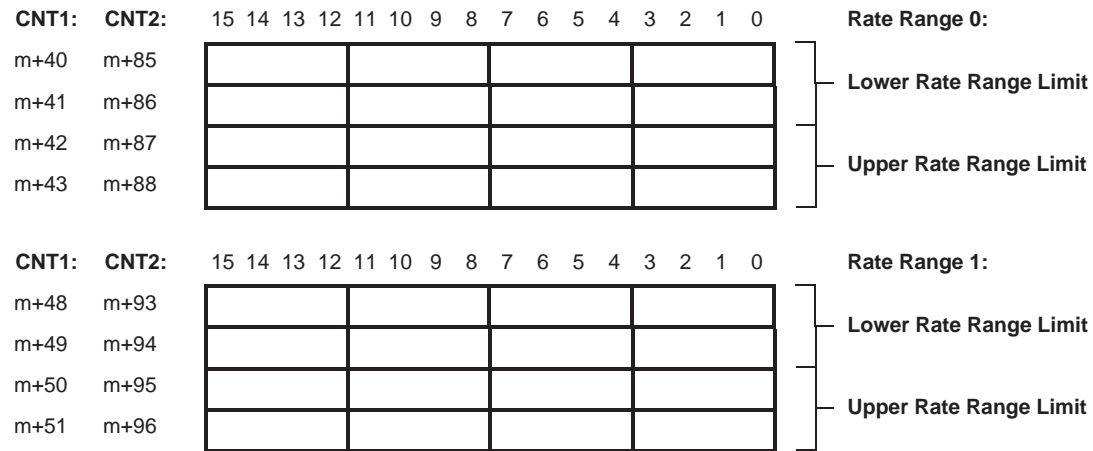

Set Lower- and Upper Range Rate Limits as a signed hexadecimal number between 8000000_H and 7FFFFFFF_H (i.e. -2,147,483,648 and +2,147,483,647 respectively). Make sure that the Upper Rate Range Limit > Lower Rate Range Limit.

Configuring Set & Reset Output Patterns

CNT1:	CNT2:	15	14	13	12	11	10	9	8	7	6	5	4	3	2	1	0	
m+44	m+89	15	14	13	12	11	10	9	7	7	6	5	4	3	2	O1	O0	Rate Range 0: Output Set Pattern Rate Range 0 Output Reset Pattern Rate Range 0
m+45	m+90	31	30	29	28	27	26	25	24	23	22	21	20	19	18	17	16	
m+46	m+91	15	14	13	12	11	10	9	7	7	6	5	4	3	2	O1	O0	
m+47	m+92	31	30	29	28	27	26	25	24	23	22	21	20	19	18	17	16	
CNT1:	CNT2:	15	14	13	12	11	10	9	8	7	6	5	4	3	2	1	0	
m+52	m+97	15	14	13	12	11	10	9	7	7	6	5	4	3	2	O1	O0	Rate Range 1: Output Set Pattern Rate Range 1 Output Reset Pattern Rate Range 1
m+53	m+98	31	30	29	28	27	26	25	24	23	22	21	20	19	18	17	16	
m+54	m+99	15	14	13	12	11	10	9	7	7	6	5	4	3	2	O1	O0	
m+55	m+100	31	30	29	28	27	26	25	24	23	22	21	20	19	18	17	16	

In the Set and Reset Patterns the Outputs are represented by:

- = Digital Outputs 0-1
(corresponding with Physical Digital Outputs O0 and O1)
- = Soft Outputs 2-31

If the Rate Value is within the Rate Range Limits:
(Lower Rate Range Limit ≤ Rate Value ≤ Upper Rate Range Limit)

Output Set Pattern:	Output Reset Pattern:
0 = No Change	0 = No Change
1 = Set Output	1 = Reset Output

Set/Reset actions as defined in the Output Set & Reset Pattern to control the Outputs, overrule the Unit Output Pattern for the corresponding Outputs.

Enabling/Disabling Rate Ranges

After you have configured Rate Ranges, as described above, every Rate Range can be enabled or disabled. If a Rate Range is disabled (by default) no action will be taken when the Rate Range becomes active. If a Rate Range is enabled the corresponding Output Set & Reset Patterns are applied to the Unit Output Pattern when that Range becomes active. To Enable/Disable Rate Ranges of Counters refer to the following.

CNT1:	CNT2:	15	14	13	12	11	10	9	8	7	6	5	4	3	2	1	0	
m+56	m+101																	Rate Range 0 Enable Data: 0 = Rate Range 0 Disabled 1 = Rate Range 0 Enabled Rate Range 1 Enable Data: 0 = Rate Range 1 Disabled 1 = Rate Range 1 Enabled

3-7-3 Hysteresis

An encoder can come to rest at a particular position and then “oscillate” around this position. This state means that the Counter Value fluctuates around a particular value. If, for example, a Range Limit is in this area of fluctuation, the corresponding Range would become active and inactive in the rhythm of these fluctuations. To prevent outputs from being switched ON and OFF by very small fluctuations, the High-speed Counter Unit offers the Hysteresis Function that can be configured for every Counter separately. You can assign Hysteresis in a range from 1 to 255 counts (= 0001_H – 00FF_H) from which the Counter treats the fluctuation in the Counter Input Signal as a real change and outputs can be controlled accordingly.

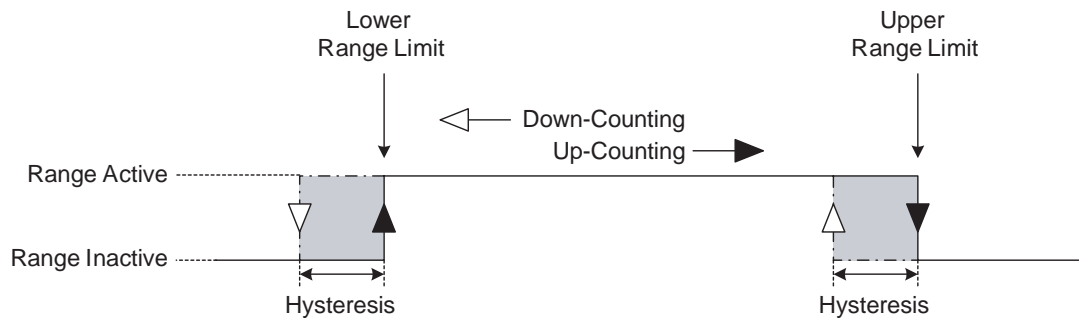

Configuring Hysteresis

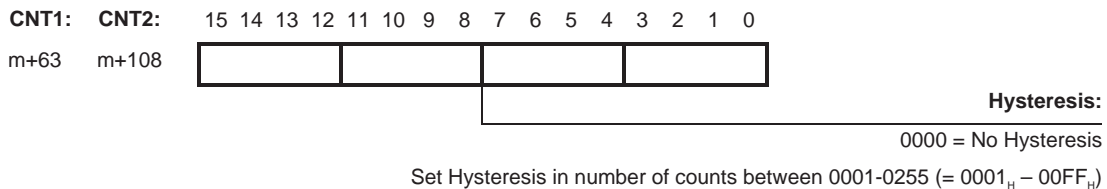

- Note**
1. The Hysteresis can only be applied to Units in Range Mode. If the Unit is in Comparison Mode you are able to configure Hysteresis yourself using Comparison Values.
 2. Do not set the origin (i.e., a present value of 0) within the Hysteresis-Area.
 3. If the Counter is Preset, turn OFF the Hysteresis. If the Counter is Preset in the Hysteresis-Area, the Outputs will not be controlled correctly.

3-7-4 Noise Filtering

Configuring Noise Filter Counter Inputs

For the purpose of suppressing noise on the signal lines A and B of every Counter a Noise Filter is available. A Noise Filter can be configured for Counter 1 & 2.

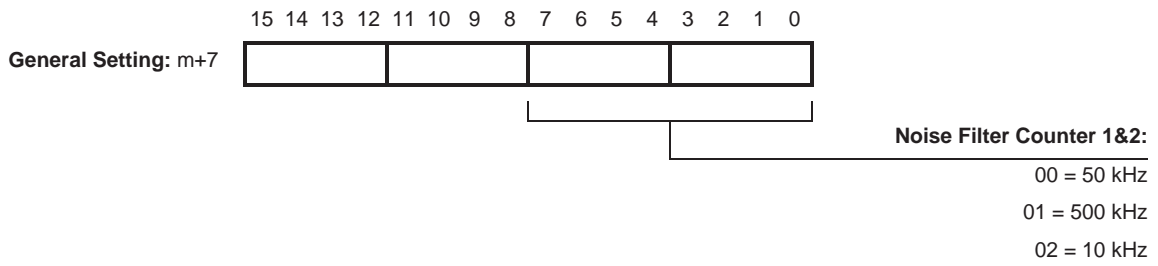

Configuring Noise Filter Digital Inputs

For the purpose of suppressing noise on the control lines of the Digital Inputs also a Noise Filter is available. A Noise Filter can be configured for Digital Input 0 & 1.

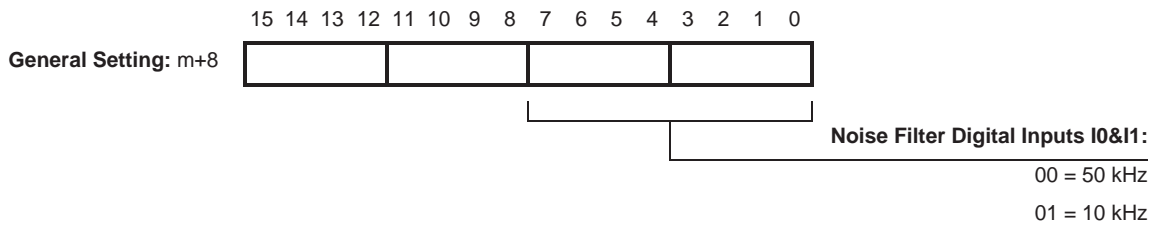

3-7-5 Initial Counter Value

Every Counter is equipped with the Initial Counter Value (double word) in DM. At a transfer of the DM-settings from the CPU to the Unit (triggered by a Power Up or Restart of the Unit) the Initial Counter Value is also transferred. The Initial Counter Value overwrites the Counter Value and becomes the new Counter Value.

The Initial Counter Value is very useful in case the Power of the PLC-system fails. If the Power of the PLC-system fails, the application that is controlled by the High-speed Counter Unit will come to rest, and the Counter Values will be reset to zero. After the system has been Powered Up again, the application has to be reset, since it has lost the position data with the resetting of the Counter Values.

To overcome this trouble, the Power OFF Interrupt Task of the PLC can be used to detect the failing system Power. You can use this Power OFF Interrupt Task to program a transfer of the Counter Values of every Counter (in CIO) to the corresponding Initial Counter Value of that Counter in DM. The data in DM is retained when the Power is OFF. Therefore, Powering Up the system again, results in a transfer of the DM-settings from the CPU to the Unit and the Counter Value is overwritten by the Initial Counter Value, allowing your application to continue from where it was at the moment of failing Power.

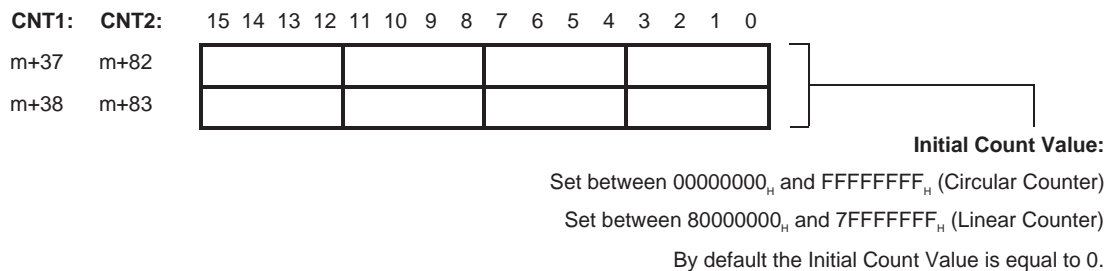

- Note**
1. The Power OFF Interrupt Task that takes care of saving the Counter Values to the Initial Counter Values can also be used to detect a Power OFF that has been done on purpose.
 2. The Initial Counter Value can also be set, independent of a Power Failure, to load the Counter Value with an Initial Value instead of zero.
 3. The Present Value stored by the interrupt task must be used considering the possibility of a power interrupt to the Encoder and interrupt processing execution timing.

SECTION 4

Exchanging Data with CPU

This section provides information on exchanging data between CJ1W-CT021 High Speed Counter Units and CJ-series CPU Units.

4-1	Overview	94
4-1-1	Basic Setup	94
4-1-2	Special I/O Units Restart bits	96
4-2	Memory Allocation	97
4-2-1	Memory Mapping	97
4-2-2	Indirect Addressing	98
4-2-3	CIO-Memory Mapping	101
4-2-4	DM-Memory Mapping	105
4-2-5	Range Memory Mapping	112
4-2-6	Comparison Memory Mapping	114
4-3	IOWR-Instruction	116
4-4	IORD-Instruction	118
4-5	Supported IOWR/IORD-Instructions	120
4-5-1	DM-data	120
4-5-2	Range- and Comparison data	122
4-5-3	Special data	125
4-6	Interrupts	128
4-6-1	Outputs Generating Interrupts	129
4-6-2	Digital Inputs Generating Interrupts	131

4-1 Overview

4-1-1 Basic Setup

The status information of the High-speed Counter Unit is exchanged with the CPU every cyclic I/O Refresh via the Special I/O Unit Area (CIO). The Unit configuration data is exchanged at Power ON or after the Unit has been restarted or after issuing the IOWR-instruction "(Re) Configure Unit" (refer to 4-5-3-4 "(Re) Configure Unit"). The Unit configuration data consists of the configuration data in the Special I/O Unit DM Area and the Range/Comparison Data.

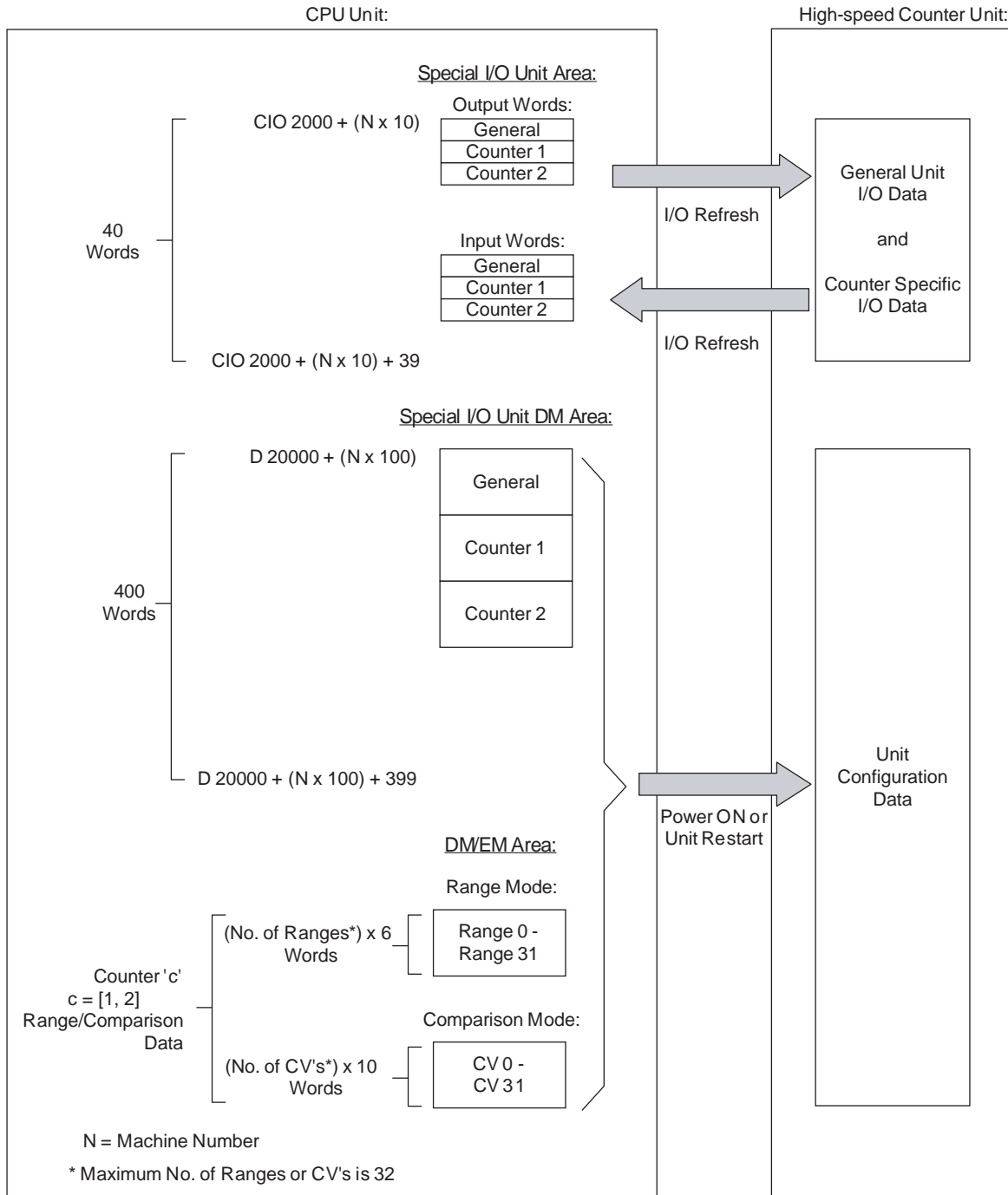

Special I/O Unit Area and Special I/O Unit DM Area

The Special I/O Unit Area and the Special I/O Unit DM Area are allocated to the Unit according to the Machine Number (=N) set. For the Special I/O Unit Area 40 CIO words are allocated and for the Special I/O Unit DM Area 400 DM words are allocated. For more information on the exact memory location of the Special I/O Unit and Special I/O Unit DM Areas and the Machine Numbers that can be set, refer to 2-1-4 "*Machine Number Switch*".

Unit Status Data

The Special I/O Unit Area contains the status information of the High-speed Counter Unit in CIO and is divided in an area with output words and an area with input words. Both areas are divided in three parts: a general part and two Counter specific parts, and these are updated cyclically every I/O refresh.

Unit Configuration Data

The Unit configuration data is located in the Special I/O Unit DM Area, which is allocated to the High-speed Counter Unit, and the Range/Comparison Data. The Mode for which the Unit is configured determines if you have to set Range or Comparison Data (refer to 3-5-1 "*Range Mode*" and 3-5-2 "*Comparison Mode*" for more information). The location of the Range/Comparison Data is indicated by an Indirect Address that you have to specify for every Counter (refer to 4-2-2 "*Indirect Addressing*" for detailed information).

The Special I/O Unit DM Area contains the configuration settings of the High-speed Counter Unit. It is divided in three parts: a general part and two Counter specific parts. The general part contains the settings that are relevant for the whole Unit and the Counter specific parts contain the settings that are relevant to the specific Counters.

The Unit Configuration Data is transferred to the High-speed Counter Unit at Power Up or after the Unit has been restarted (refer to 4-1-2 "*Special I/O Units Restart bits*").

- Note**
- The Unit configuration data can also be transferred during actual operation of the Unit, by issuing an IOWR-instruction (refer to 4-5-3-4 "*(Re) Configure Unit*").
 - I/O Refresh will not occur while the Data Transfer Busy bit (CIO n+19, bit 02) is ON. For example, the Counter Value will not be refreshed while the bit is ON.

4-1-2 Special I/O Units Restart bits

By turning the Unit Restart Bit from OFF to ON the Unit can be restarted. Restarting the Unit can be used to transfer the Unit configuration settings (e.g. after correction of an error) from the CPU to the Unit.

Bit	Function	
A50200	Unit No. 0 Restart Bit	Restarts the Unit when turned from OFF to ON.
A50201	Unit No. 1 Restart Bit	
~	~	
A50215	Unit No. 15 Restart Bit	
A50300	Unit No. 16 Restart Bit	
~	~	
A50715	Unit No. 95 Restart Bit	

The Unit can also be restarted by turning the Power from OFF to ON.

4-2 Memory Allocation

4-2-1 Memory Mapping

The following figure shows how the 40 words in the Special I/O Unit Area (CIO) and the 400 words in the Special I/O unit DM Area (DM) are mapped in the memory of the CPU-Unit.

An Indirect Address at the end of every Counter specific block in DM specifies where the Range or Comparison Data of the corresponding Counter is allocated.

CIO Memory Mapping Output Words
(Refer to 4-2-3 for details):

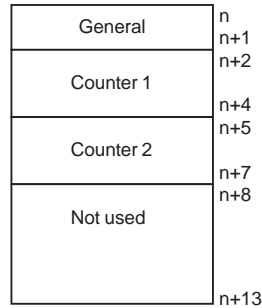

CIO Memory Mapping Input Words
(Refer to 4-2-3 for details):

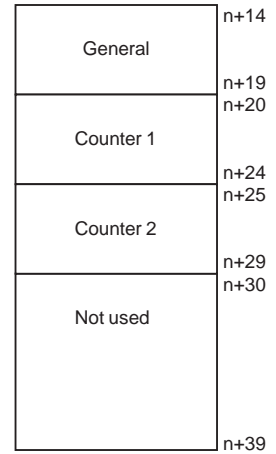

$n = \text{CIO } 2000 + (N \times 10)$
 $N = \text{Machine Number}$

Range Memory Mapping (Refer to 4-2-5 for details):
 Comparison Memory Mapping (Refer to 4-2-6 for details):

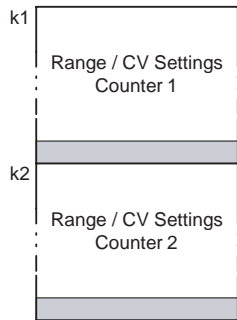

DM-Memory Mapping
(Refer to 4-2-4 for details):

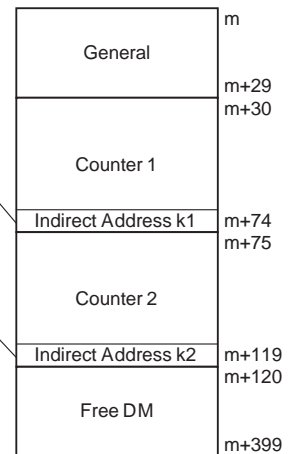

$m = D \ 20,000 + (N \times 100)$
 $N = \text{Machine Number}$
 $k1, k2 = \text{Any available address in DM/EM}$

(Refer to 4-2-2 for more details about Indirect Addressing)

Note The Range/Comparison Data blocks that are allocated to the Counters do not necessarily have to be consecutive and can be in any area of DM/EM. In case they overlap the Unit reports this in CIO as a warning, but does not generate an error. This makes it possible to define only one block with Range/Comparison

data and to use this data for all two Counters by using two identical indirect addresses ($k_1=k_2$).

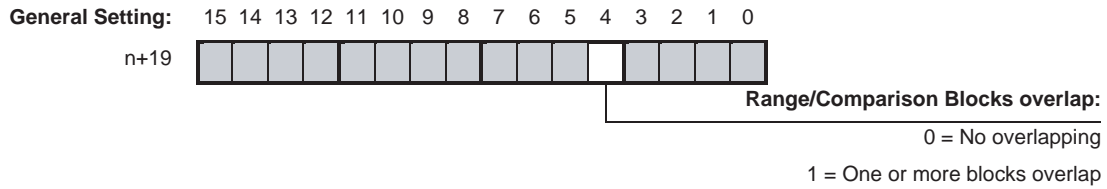

4-2-2 Indirect Addressing

The High-speed Counter Unit can be in Range Mode or Comparison Mode (refer to 3-5-1 "Range Mode" and 3-5-2 "Comparison Mode" for more information). The Range or Comparison Data is allocated in the Extended Memory Area (EM) or in the Data Memory Area (DM). An Indirect Address, that you can set for every Counter in the Special I/O Unit DM Area, points to the actual memory location in DM or EM where the Range or Comparison Data of that Counter is stored.

Note It is also possible to use the free DM, in the Special I/O Unit DM Area that is allocated to the High-speed Counter Unit, to store the Range/Comparison Data. There are 287 free DM-words (=399-113), so you can store data of up to 47 Ranges or 28 Comparison Values.

Unit in Range Mode

In Range Mode Indirect Addressing can be used to define the Ranges per Counter that you want to use. The number of Ranges (M) defines the size of the Range Data block (size = M x 6 words). If you want to use multiple Ranges you are recommended to use consecutive Ranges starting from Range 0 (i.e. Range 0, 1, 2, 3 → M - 1) in order to save memory occupation.

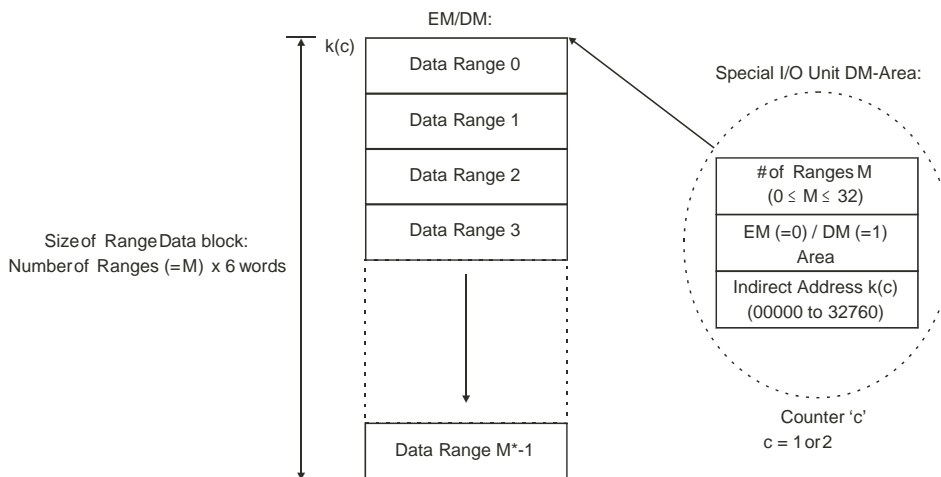

* Assumed that $M \neq 0$. By default $M=0$ which means that no Ranges will be used.

Note If you do not want the Ranges to be consecutive and only intend to use two Ranges (e.g. Range 0 and Range 15) then you still have to define the number of Ranges (M) to be 16. In order to prevent configuration errors from happening you should make sure that the data of Ranges 1 to 14 is also valid, although you do not intend to use Range 1 to 14.

Unit in Comparison Mode

In Comparison Mode Indirect Addressing can be used to define the Comparison Values per Counter that you want to use. The number of CV's (M) defines the size of the CV Data block (size = M x 10 words). If you want to use multiple CV's you are recommended to use consecutive CV's starting from CV 0 (i.e. CV 0, 1, 2, 3 → M - 1) in order to save memory occupation.

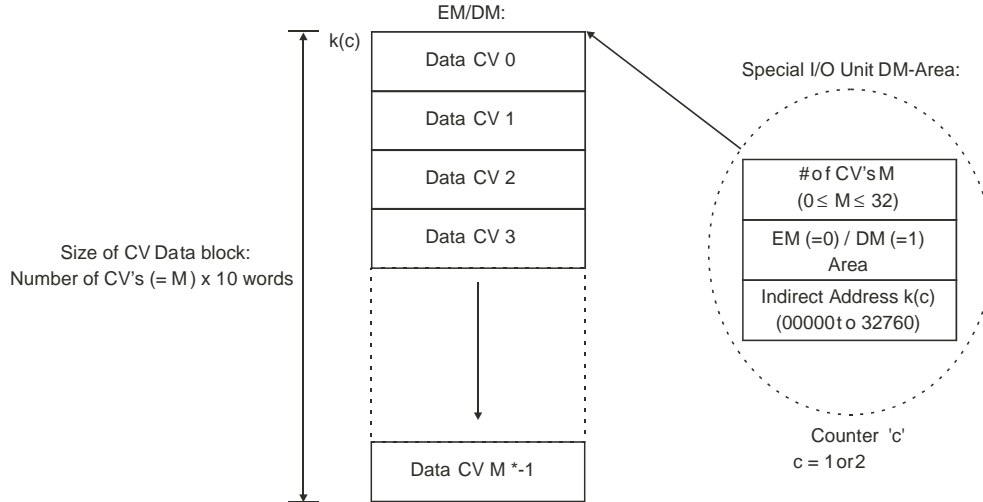

* Assumed that M ≠ 0. By default M=0 which means that no CV's will be used.

Note If you do not want the Comparison Values to be consecutive and only intend to use two CV's (e.g. CV 0 and CV 15) then you still have to define the number of CV's (M) to be 16. In order to prevent configuration errors from happening you should make sure that the data of CV's 1 to 14 is also valid, although you do not intend to use CV 1 to 14.

Configuring Indirect Addressing

Indirect Addressing with the Unit in Range or Comparison Mode is specified in the Special I/O Unit DM Area for every Counter. You must specify the memory area (EM/DM) and the address (00000 to 32760) of the first word where the Range/CV data is to be stored. Like this you are able to specify any address that is available in EM or DM. By specifying the number of Ranges or Comparison Values per Counter you determine the number of words with Range/CV data that are allocated for every Counter. For every Range 6 words and for every Comparison Value 10 words are allocated.

The Range/Comparison Data, as part of the Unit configuration data, is transferred to the Unit at Power Up or after the Unit has been restarted.

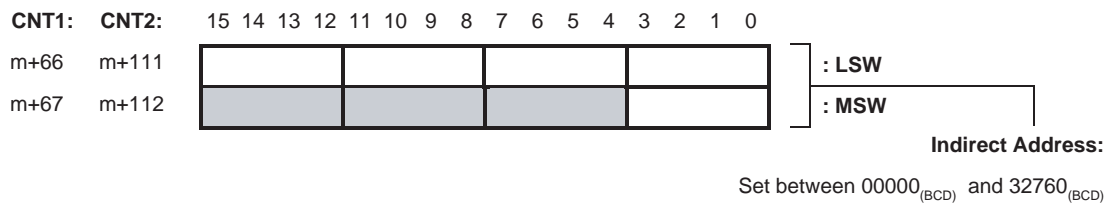
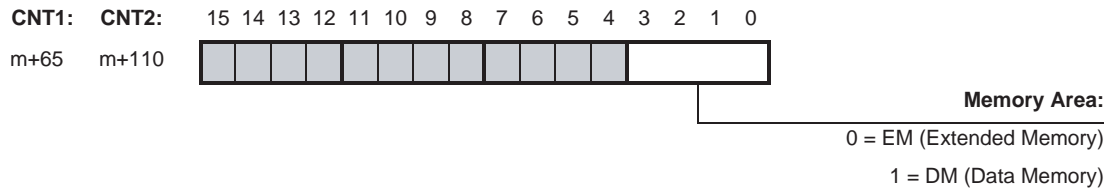
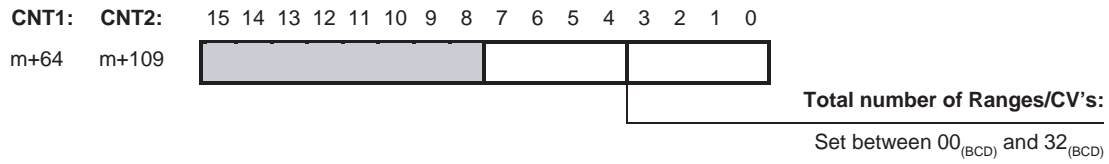

The least significant word (LSW) of the Indirect Address contains the four least significant digits and the most significant word (MSW) contains the most significant digit of the Indirect Address (refer to the examples on the following pages).

Example Range Mode

Unit is in Range Mode. You want to use 12 Ranges (Range 0 to Range 11) for Counter 1 and want to allocate them in Data Memory starting from D1850.

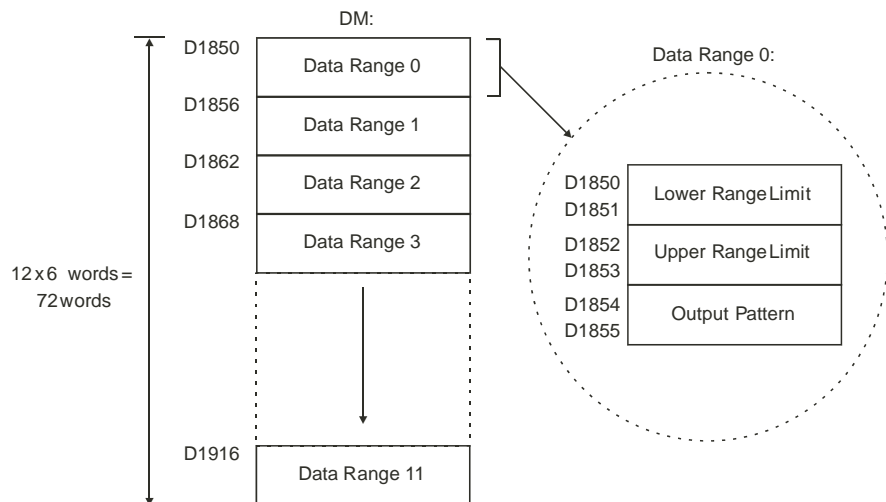
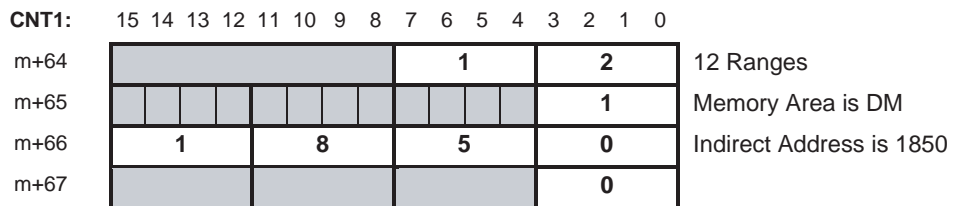

For an overview all addresses related to Range Data refer to 4-2-5 "Range Memory Mapping".

Example Comparison Mode

Unit is in Comparison Mode. You want to use 5 Comparison Values (CV 0 to Range 4) for Counter 1 and want to allocate them in Extended Memory starting from EM520.

CNT1:	15	14	13	12	11	10	9	8	7	6	5	4	3	2	1	0
m+64												0	5	5 Comparison Values Memory Area is EM Indirect Address is 520		
m+65												0				
m+66	0				5				2		0					
m+67												0				

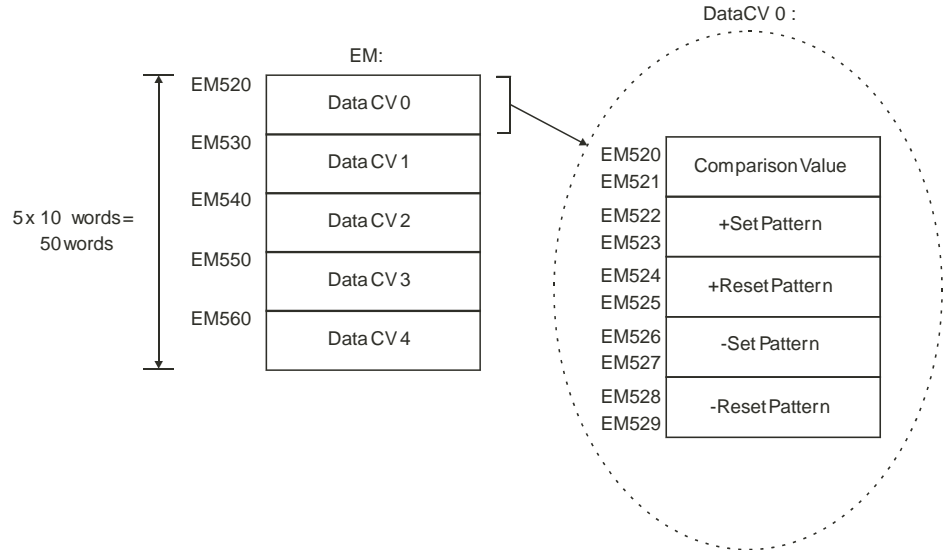

For an overview of all addresses related to Comparison Data refer to 4-2-6 "Comparison Memory Mapping".

4-2-3 CIO-Memory Mapping

The High-speed Counter Unit is allocated 40 Words in CIO. These 40 Words are divided in 14 Output Words (n to n+13) and 26 Input Words (n+14 to n+39).

Note Double words in CIO are indicated as for example "n+3, n+4". How to distinguish between the least- and most significant words (LSW and MSW) within double words, you should refer to the section called "About this Manual" at the beginning of this Manual.

CIO Output Words

The 14 Output Words (n to n+13) are divided in 3 groups: General, Counter 1, and Counter 2.

Word (output)	Bit	Item	Function
General			
n	00, 01	Manual Output Control	Force ON (=1) / OFF (=0) Digital Outputs [0-1] Bits 00 and 01 correspond to Digital Outputs O0 and O1.
	02-14	---	Not used
	15	Automatic/Manual	Automatic (=0) Digital Output Control / Manual (=1) Digital Output Control
n+1	00	Read Next Error	Read next error at the rising edge (from the error list in the High-speed Counter Unit). The error code can be read from CIO-words n+17 and n+18.
	01 – 15	---	Not used
Counter 1			
n+2	00	Open Gate*, ***	Open Gate (0→1)
	01	Close Gate*, ***	Close Gate (0→1)
	02	Preset***	Load Preset Value (0→1)
	03	Reset***	Reset Counter (Forced Reset) to zero (0→1)
	04	Capture***	Capture Counter Value (0→1)
	05	Reset Enable**	Enable Resetting for Z-signal / Digital Input (=1)
	06-15	---	Not used
n+3, n+4	00-15	Preset Value	Preset Value
Counter 2			
n+5	00	Open Gate*, ***	Open Gate (0→1)
	01	Close Gate*, ***	Close Gate (0→1)
	02	Preset***	Load Preset Value (0→1)
	03	Reset***	Reset Counter (Forced Reset) to zero (0→1)
	04	Capture***	Capture Counter Value (0→1)
	05	Reset Enable**	Enable Resetting for Z-signal / Digital Input (=1)
	06-15	---	Not used
n+6, n+7	00-15	Preset Value	Preset Value
n+8 to n+13	00-15	---	Not used

* Initially, after power-up or restart of the Unit, the Gate is closed. To enable counting pulses, first open the Gate by setting the “Open Gate” bit of the corresponding counter to ‘1’.

**Bit(s) have no function for Simple Counters.

***These bits may not be executed if they are ON for only one PLC cycle. Always keep these bits turned ON until the execution status changes in the corresponding flags in n+24 or n+29.

CIO Input Words

The 26 Input Words (n+14 to n+39) are divided in 3 groups: General, Counter 1, and Counter 2.

Word (input)	Bit	Item	Function
General			
n+14, n+15	00-15	Output Status	Current status of Digital and Soft Outputs n+14, bits 00 and 01: Digital Outputs O0 and O1 n+14, bits 02 and 15: Soft Outputs 2 to 15 n+15, bits 00 and 15: Soft Outputs 16 to 31
n+16	00-01	Input Status	Current status of Digital Inputs
	02-15	---	Not used
n+17, n+18	00-15	Error Code	The type of error is represented as follows: n+17 = error code 1 n+18 = error code 2 Refer to 5-2 "Error codes" for more information
n+19	00	Global Error	Indication that one or more errors have occurred and that their error code(s) are included in the error list of the Unit
	01	Interrupts Pending*	Interrupts Pending (=1); m 1 interrupt(s) in FIFO-queue
	02	Data Transfer Busy	Data Transfer Busy (=1), Unit is busy completing the IORD/IOWR-instruction or is being initialized****
	03	Data Transfer Completed	Toggled every time Data Transfer is completed
	04	IA Blocks overlap**	Indication that IA blocks overlap in PLC memory
	05-15	---	Not used
Counter 1			
n+20, n+21	00-15	Ranges / Comparison Values active*	Ranges Active (=1) / Inactive (=0) / Comparison Values Active (=1) / Inactive (=0)
n+22, n+23	00-15	Counter Value	Counter Value
n+24	00	Counter Overflow	Counter Overflow (=1), Upper Count Limit of Linear Counter is reached
	01	Counter Underflow	Counter Underflow (=1), Lower Count Limit of Linear Counter is reached
	02	Counter Running / Gate Open	Counter Running/Gate Open (=1), Counter Stopped/Gate Closed (=0)
	03	Counting Direction	Counting Direction, Down (=0) / Up (=1)
	04	Preset Activated **	Preset Activated (=1)
	05	Reset Activated **	Reset Activated (=1)
	06	Capture Activated **, ***	Capture Activated (=1)
	07	Z-signal Activated **	Z-signal Activated (=1)
	08-09	---	Not used
	10	Rate Range 0*	Rate Range 0 Active (=1)
	11	Rate Range 1*	Rate Range 1 Active (=1)
12-14	---	Not used	
15	Simple Counter	Simple Counter (=1) / Circular/Linear Counter (=0)	

Word (input)	Bit	Item	Function
Counter 2			
n+25, n+26	00-15	Ranges / Comparison Values active*	Ranges Active (=1) / Inactive (=0) / Comparison Values Active (=1) / Inactive (=0)
n+27, n+28	00-15	Counter Value	Counter Value
n+29	00	Counter Overflow	Counter Overflow (=1), Upper Count Limit of Linear Counter is reached
	01	Counter Underflow	Counter Underflow (=1), Lower Count Limit of Linear Counter is reached
	02	Counter Running / Gate Open	Counter Running/Gate Open (=1), Counter Stopped/Gate Closed (=0)
	03	Counting Direction	Counting Direction, Down (=0) / Up (=1)
	04	Preset Activated**	Preset Activated (=1)
	05	Reset Activated**	Reset Activated (=1)
	06	Capture Activated**, ***	Capture Activated (=1)
	07	Z-signal Activated**	Z-signal Activated (=1)
	08-09	---	Not used
	10	Rate Range 0*	Rate Range 0 Active (=1)
	11	Rate Range 1*	Rate Range 1 Active (=1)
	12-14	---	Not used
	15	Simple Counter	Simple Counter (=1) / Circular/Linear Counter (=0)
n+30 to n+39	00-15	---	Not used

* These bits have no function for Simple Counters.

** The Reset, Preset, Capture, and Z-signal Activated Bits turn ON for at least one CPU Unit-cycle after the occurrence of a pulse that was detected since the previous I/O Refresh.

*** The Capture Bit turns ON once automatically after the power is turned ON and after restart.

**** During initialization, the Data Transfer Busy bit turns ON for approximately 120 ms.

4-2-4 DM-Memory Mapping

The High-speed Counter Unit is allocated 400 Words in DM. These 400 Words are divided in 30 General DM-words (m to m+29) and 45 Counter Specific words for every Counter (Counter 1 = m+30 to m+74, Counter 2 = m+75 to m+119).

Note Double words in DM are indicated as for example “m+2, m+3”. How to distinguish between the least- and most significant words (LSW and MSW) within double words, you should refer to the section called “*About this Manual*” at the beginning of this Manual.

Word	Bit	Item	Function
General			
m	00-07	Output Control Mode	Output Control Mode: 00 = Range Mode (=default) 01 = Comparison Mode
	08-15	AND/OR Counter Output Patterns	In case of Range Mode, define if the output patterns of the Counters should be logically AND-ed (01) or OR-ed (00)
m+1	00-15	Interrupt Task Offset (Outputs)*	Define Offset [0, 192 _(BCD)] to execute External Interrupt Tasks [0, 255] corresponding to Outputs [0-31]
m+2, m+3	00-15	Interrupt Enable Data Outputs*	Enable (=1) or Disable (=0) Interrupts in the Unit corresponding to Outputs [0, 31]
m+4	00-15	Interrupt Task Offset (Inputs)*	Define Offset [0, 252 _(BCD)] to execute External Interrupt Tasks [0, 255] corresponding to Digital Inputs [0-1]: (Having interrupts on rising or falling edge is fixed by the Function of the Digital Input, refer to 3-4 “ <i>Digital Input Functions</i> ”).
m+5	00-15	Interrupt Enable Data Inputs*	Enable (=1) or Disable (=0) Interrupts in the Unit corresponding to Digital Inputs [0, 1]
m+6	00, 01	Output Driver NPN/PNP	Define Output Driver NPN (=0) or PNP (=1) for every Digital Output [0-1]
	02-11	---	Not used
	12-15	Output State Control	Define state control of the Outputs in case the operating mode of CJ-series CPU Unit is changed from RUN/MONITOR → PROGRAM or an I/O Bus- or Overflow/Underflow error occurs: 0 = Continue automatic updating Output States 1 = Freeze Output States 2 = Predefine Output States

* Refer to 4-6 “*Interrupts*” for information about Outputs and Inputs generating Interrupts.

Word	Bit	Item	Function
m+7	00-07	Input Noise Filter Counters	Select Noise Filter for Counters 1 and 2: 00 = 50 kHz (default) 01 = 500 kHz 02 = 10 kHz
	08-15	---	Not used
m+8	00-07	Input Noise Filter Digital Inputs	Select Noise Filter for Digital Inputs 0 and 1: 00 = 50 kHz (default) 01 = 10 kHz
	08-15	---	Not used
m+9	00-15	Output Pulse Turn ON-Delay Time Digital Output 0	Define Output Pulse Turn ON-Delay time: [0, 9999 _(BCD) ms]
m+10	00-15	Output Pulse Duration Digital Output 0	Define Output Pulse Duration: [0, 9999 _(BCD) ms] 0 = infinite duration (i.e. Output Pulse Duration function is disabled)
m+11	00-15	Output Pulse Turn ON-Delay Time Digital Output 1	Define Output Pulse Turn ON-Delay time: [0, 9999 _(BCD) ms]
m+12	00-15	Output Pulse Duration Digital Output 1	Define Output Pulse Duration: [0, 9999 _(BCD) ms] 0 = infinite duration (i.e. Output Pulse Duration function is disabled)
m+13 to m+16	00-15	Reserved.	Cannot be used. (Set to 0000.)

Word	Bit	Item	Function
m+17	00-07	Digital Input 0 Function	Function Digital Input 0 (all in BCD): 00 = No function 01 = Gate Positive 02 = Gate Negative 03 = Preset Rising Edge 04 = Preset Falling Edge 05 = Reset Rising Edge 06 = Reset Falling Edge 07 = Capture Rising Edge 08 = Capture Falling Edge 09 = Stop, Capture and Continue 10 = Stop, Capture and Continue (inverted) 11 = Stop, Capture, Reset and Continue 12 = Stop, Capture, Reset and Continue (inverted) 13 = Capture-Reset Rising Edge 14 = Capture-Reset Falling Edge 15 = Enable Reset 16 = Disable Reset (refer to 3-4 "Digital Input Functions" for details)
	08-15	Counter Number	Counter Number (1-4) to which Digital Input 0 is connected
m+18	00-07	Digital Input 1 Function	Function Digital Input 1: (for a list refer to Digital Input 0) (refer to 3-4 "Digital Input Functions" for details)
	08-15	Counter Number	Counter Number (1-4) to which Digital Input 1 is connected
m+19, m+20	00-15	Reserved.	Cannot be used. (Set to 0000.)
m+21, m+22	00-15	Predefined Output Pattern	Predefined Output Pattern that is applied to the Outputs if configured in m+6, Predefine Output States
m+23 to m+29	00-15	---	Not used

Word	Bit	Item	Function
Counter 1			
m+30	00-15	Counter Type	Counter Type: 0 = Circular (=default) 1 = Linear
m+31	00-03	Signal Type	Signal Type: 0 = Phase Differential (x1) (=default) 1 = Phase Differential (x2) 2 = Phase Differential (x4) 4 = Up & Down Pulse 8 = Pulse & Direction
	04-15	---	Not used
m+32	00-03	Z-reset Mode	Functionality of Z input signal: 0 = No function (=default, only mapped in CIO) 1 = Reset (Counter at rising edge)
	04-07	Overflow/Underflow error-code generation	Generate error-code at Overflow/Underflow: 0 = No error-code generation (only report with Overflow/Underflow-bits and outputs keep last state) 1 = Error-code generation (report error-code and turn OFF all outputs)
	08-15	---	Not used
m+33, m+34	00-15	Upper Count Limit Circular/Linear	Circular/Linear Counter: Upper Count Limit
m+35, m+36	00-15	Lower Count Limit Linear	Linear Counter: Lower Count Limit
m+37, m+38	00-15	Initial Count Value	Initial Counter Value after transfer of Unit configuration data
m+39	00-15	Time-window (Rate Measurement)	Set time-window Counter 1 between 1 and 9999 _(BCD) ms to configure Rate Measurement (0 means that NO rate measurement is required)
m+40, m+41	00-15	Rate-Range 0 Lower Limit	Rate-Range 0 Lower Limit
m+42, m+43	00-15	Rate-Range 0 Upper Limit	Rate-Range 0 Upper Limit
m+44, m+45	00-15	Set Pattern Rate-Range 0	Output Set Pattern Rate-Range 0
m+46, m+47	00-15	Reset Pattern Rate-Range 0	Output Reset Pattern Rate-Range 0

Word	Bit	Item	Function
m+48, m+49	00-15	Rate-Range 1 Lower Limit	Rate-Range 1 Lower Limit
m+50, m+51	00-15	Rate-Range 1 Upper Limit	Rate-Range 1 Upper Limit
m+52, m+53	00-15	Set Pattern Rate-Range 1	Output Set Pattern Rate-Range 1
m+54, m+55	00-15	Reset Pattern Rate-Range 1	Output Reset Pattern Rate-Range 1
m+56	00	Rate-Range 0 Enable	Enable (=1) / Disable (=0) Rate-Range 0
	01	Rate-Range 1 Enable	Enable (=1) / Disable (=0) Rate-Range 1
	02-15	---	Not used
m+57, m+58	00-15	Range / Comparison Enable Data	Enable Ranges / Comparison Values (1=Enabled, 0=Disabled) (depending on Unit in Range / Comparison Mode). Bits set for non-existing ranges or CV's will be ignored
m+59, m+60	00-15	Output Set Pattern	Output [0-31] Set Pattern for Comparison Mode 1= set, 0 = no change
m+61, m+62	00-15	Output Reset Pattern	Output [0-31] Reset Pattern for Comparison Mode 1= reset, 0 = no change
m+63	00-15	Hysteresis	Define required Hysteresis (0000 to 00FF Hex) ($0 \leq \text{Hysteresis} \leq 255$ counts). Hysteresis (=0) means Hysteresis is OFF.*
m+64	00-07	# Ranges / Comparison Values	Set number of Ranges/ Comparison Values [0, 32 _(BCD)]
	08-15	---	Not used
m+65**	00-03	Memory Area	Memory Area where Range / Comparison Data is stored: 0 = EM (=default) 1 = DM
	04-15	---	Not used
m+66, m+67**	00-15	Memory Address	Beginning Address (in EM/DM) where first Range / Comparison Data is stored [00000, 32760 _(BCD)]
m+68 to m+74	00-15	---	Not used

* Set to "0" and turn OFF Hysteresis to use the Preset function.

** Sets the beginning (k1) of the Range Data or Comparison Data.

Word	Bit	Item	Function
Counter 2			
m+75	00-15	Counter Type	Counter Type: 0 = Circular (=default) 1 = Linear
m+76	00-03	Signal Type	Signal Type: 0 = Phase Differential (x1) (=default) 1 = Phase Differential (x2) 2 = Phase Differential (x4) 4 = Up & Down Pulse 8 = Pulse & Direction
	04-15	---	Not used
m+77	00-03	Z-reset Mode	Functionality of Z input signal: 0 = No function (=default, only mapped in CIO) 1 = Reset (Counter at rising edge)
	04-07	Overflow/Underflow error-code generation	Generate error-code at Overflow/Underflow: 0 = No error-code generation (only report with Overflow/Underflow-bits and outputs keep last state) 1 = Error-code generation (report error-code and turn OFF all outputs)
	08-15	---	Not used
m+78, m+79	00-15	Upper Count Limit Circular/Linear	Circular/Linear Counter: Upper Count Limit
m+80, m+81	00-15	Lower Count Limit Linear	Linear Counter: Lower Count Limit
m+82, m+83	00-15	Initial Count Value	Initial Counter Value after transfer of Unit configuration data
m+84	00-15	Time-window (Rate Measurement)	Set time-window Counter 2 between 1 and 9999 _(BCD) ms to configure Rate Measurement (0 means that NO rate measurement is required)
m+85, m+86	00-15	Rate-Range 0 Lower Limit	Rate-Range 0 Lower Limit
m+87, m+88	00-15	Rate-Range 0 Upper Limit	Rate-Range 0 Upper Limit
m+89, m+90	00-15	Set Pattern Rate-Range 0	Output Set Pattern Rate-Range 0
m+91, m+92	00-15	Reset Pattern Rate-Range 0	Output Reset Pattern Rate-Range 0

Word	Bit	Item	Function
m+93, m+94	00-15	Rate-Range 1 Lower Limit	Rate-Range 1 Lower Limit
m+95, m+96	00-15	Rate-Range 1 Upper Limit	Rate-Range 1 Upper Limit
m+97, m+98	00-15	Set Pattern Rate-Range 1	Output Set Pattern Rate-Range 1
m+99, m+100	00-15	Reset Pattern Rate-Range 1	Output Reset Pattern Rate-Range 1
m+101	00	Rate-Range 0 Enable	Enable (=1) / Disable (=0) Rate-Range 0
	01	Rate-Range 1 Enable	Enable (=1) / Disable (=0) Rate-Range 1
	02-15	---	Not used
m+102, m+103	00-15	Range / Comparison Enable Data	Enable Ranges / Comparison Values (1=Enabled, 0=Disabled) (depending on Unit in Range / Comparison Mode). Bits set for non-existing ranges or CV's will be ignored
m+104, m+105	00-15	Output Set Pattern	Output [0-31] Set Pattern for Comparison Mode 1= set, 0 = no change
m+106, m+107	00-15	Output Reset Pattern	Output [0-31] Reset Pattern for Comparison Mode 1= reset, 0 = no change
m+108	00-15	Hysteresis	Define required Hysteresis (0000 to 00FF Hex) ($0 \leq \text{Hysteresis} \leq 255$ counts). Hysteresis (=0) means Hysteresis is OFF.*
m+109	00-07	# Ranges / Comparison Values	Set number of Ranges/ Comparison Values [0, 32 _(BCD)]
	08-15	---	Not used
m+110**	00-03	Memory Area	Memory Area where Range / Comparison Data is stored: 0 = EM (=default) 1 = DM
	04-15	---	Not used
m+111, m+112**	00-15	Memory Address	Beginning Address (in EM/DM) where first Range / Comparison Data is stored [00000, 32760 _(BCD)]
m+113 to m+399	00-15	---	Not used

* Set to "0" and turn OFF Hysteresis to use the Preset function.

** Sets the beginning (k2) of the Range Data or Comparison Data.

4-2-5 Range Memory Mapping

Word	Bit	Item	Function
Counter 1			
k1, k1+1	00-15	Lower Limit Range 0	Lower Limit Range 0
k1+2, k1+3	00-15	Upper Limit Range 0	Upper Limit Range 0
k1+4, k1+5	00-15	Output Pattern Range 0	Output Pattern Range 0
k1+6 to k1+11	00-15	Range Data Range 1	Lower/Upper Limit and Output Pattern Range 1
k1+12 to k1+17	00-15	Range Data Range 2	Lower/Upper Limit and Output Pattern Range 2
k1+18 to k1+23	00-15	Range Data Range 3	Lower/Upper Limit and Output Pattern Range 3
k1+24 to k1+29	00-15	Range Data Range 4	Lower/Upper Limit and Output Pattern Range 4
k1+30 to k1+35	00-15	Range Data Range 5	Lower/Upper Limit and Output Pattern Range 5
k1+36 to k1+41	00-15	Range Data Range 6	Lower/Upper Limit and Output Pattern Range 6
k1+42 to k1+47	00-15	Range Data Range 7	Lower/Upper Limit and Output Pattern Range 7
k1+48 to k1+53	00-15	Range Data Range 8	Lower/Upper Limit and Output Pattern Range 8
k1+54 to k1+59	00-15	Range Data Range 9	Lower/Upper Limit and Output Pattern Range 9
k1+60 to k1+65	00-15	Range Data Range 10	Lower/Upper Limit and Output Pattern Range 10
k1+66 to k1+71	00-15	Range Data Range 11	Lower/Upper Limit and Output Pattern Range 11
k1+72 to k1+77	00-15	Range Data Range 12	Lower/Upper Limit and Output Pattern Range 12
k1+78 to k1+83	00-15	Range Data Range 13	Lower/Upper Limit and Output Pattern Range 13
k1+84 to k1+89	00-15	Range Data Range 14	Lower/Upper Limit and Output Pattern Range 14
k1+90 to k1+95	00-15	Range Data Range 15	Lower/Upper Limit and Output Pattern Range 15
k1+96 to k1+101	00-15	Range Data Range 16	Lower/Upper Limit and Output Pattern Range 16
k1+102 to k1+107	00-15	Range Data Range 17	Lower/Upper Limit and Output Pattern Range 17
k1+108 to k1+113	00-15	Range Data Range 18	Lower/Upper Limit and Output Pattern Range 18
k1+114 to k1+119	00-15	Range Data Range 19	Lower/Upper Limit and Output Pattern Range 19
k1+120 to k1+125	00-15	Range Data Range 20	Lower/Upper Limit and Output Pattern Range 20
k1+126 to k1+131	00-15	Range Data Range 21	Lower/Upper Limit and Output Pattern Range 21
k1+132 to k1+137	00-15	Range Data Range 22	Lower/Upper Limit and Output Pattern Range 22
k1+138 to k1+143	00-15	Range Data Range 23	Lower/Upper Limit and Output Pattern Range 23
k1+144 to k1+149	00-15	Range Data Range 24	Lower/Upper Limit and Output Pattern Range 24
k1+150 to k1+155	00-15	Range Data Range 25	Lower/Upper Limit and Output Pattern Range 25
k1+156 to k1+161	00-15	Range Data Range 26	Lower/Upper Limit and Output Pattern Range 26
k1+162 to k1+167	00-15	Range Data Range 27	Lower/Upper Limit and Output Pattern Range 27
k1+168 to k1+173	00-15	Range Data Range 28	Lower/Upper Limit and Output Pattern Range 28
k1+174 to k1+179	00-15	Range Data Range 29	Lower/Upper Limit and Output Pattern Range 29
k1+180 to k1+185	00-15	Range Data Range 30	Lower/Upper Limit and Output Pattern Range 30
k1+186 to k1+191	00-15	Range Data Range 31	Lower/Upper Limit and Output Pattern Range 31

Word	Bit	Item	Function
Counter 2			
k2, k2+1	00-15	Lower Limit Range 0	Lower Limit Range 0
k2+2, k2+3	00-15	Upper Limit Range 0	Upper Limit Range 0
k2+4, k2+5	00-15	Output Pattern Range 0	Output Pattern Range 0
k2+6 to k2+11	00-15	Range Data Range 1	Lower/Upper Limit and Output Pattern Range 1
k2+12 to k2+17	00-15	Range Data Range 2	Lower/Upper Limit and Output Pattern Range 2
k2+18 to k2+23	00-15	Range Data Range 3	Lower/Upper Limit and Output Pattern Range 3
k2+24 to k2+29	00-15	Range Data Range 4	Lower/Upper Limit and Output Pattern Range 4
k2+30 to k2+35	00-15	Range Data Range 5	Lower/Upper Limit and Output Pattern Range 5
k2+36 to k2+41	00-15	Range Data Range 6	Lower/Upper Limit and Output Pattern Range 6
k2+42 to k2+47	00-15	Range Data Range 7	Lower/Upper Limit and Output Pattern Range 7
k2+48 to k2+53	00-15	Range Data Range 8	Lower/Upper Limit and Output Pattern Range 8
k2+54 to k2+59	00-15	Range Data Range 9	Lower/Upper Limit and Output Pattern Range 9
k2+60 to k2+65	00-15	Range Data Range 10	Lower/Upper Limit and Output Pattern Range 10
k2+66 to k2+71	00-15	Range Data Range 11	Lower/Upper Limit and Output Pattern Range 11
k2+72 to k2+77	00-15	Range Data Range 12	Lower/Upper Limit and Output Pattern Range 12
k2+78 to k2+83	00-15	Range Data Range 13	Lower/Upper Limit and Output Pattern Range 13
k2+84 to k2+89	00-15	Range Data Range 14	Lower/Upper Limit and Output Pattern Range 14
k2+90 to k2+95	00-15	Range Data Range 15	Lower/Upper Limit and Output Pattern Range 15
k2+96 to k2+101	00-15	Range Data Range 16	Lower/Upper Limit and Output Pattern Range 16
k2+102 to k2+107	00-15	Range Data Range 17	Lower/Upper Limit and Output Pattern Range 17
k2+108 to k2+113	00-15	Range Data Range 18	Lower/Upper Limit and Output Pattern Range 18
k2+114 to k2+119	00-15	Range Data Range 19	Lower/Upper Limit and Output Pattern Range 19
k2+120 to k2+125	00-15	Range Data Range 20	Lower/Upper Limit and Output Pattern Range 20
k2+126 to k2+131	00-15	Range Data Range 21	Lower/Upper Limit and Output Pattern Range 21
k2+132 to k2+137	00-15	Range Data Range 22	Lower/Upper Limit and Output Pattern Range 22
k2+138 to k2+143	00-15	Range Data Range 23	Lower/Upper Limit and Output Pattern Range 23
k2+144 to k2+149	00-15	Range Data Range 24	Lower/Upper Limit and Output Pattern Range 24
k2+150 to k2+155	00-15	Range Data Range 25	Lower/Upper Limit and Output Pattern Range 25
k2+156 to k2+161	00-15	Range Data Range 26	Lower/Upper Limit and Output Pattern Range 26
k2+162 to k2+167	00-15	Range Data Range 27	Lower/Upper Limit and Output Pattern Range 27
k2+168 to k2+173	00-15	Range Data Range 28	Lower/Upper Limit and Output Pattern Range 28
k2+174 to k2+179	00-15	Range Data Range 29	Lower/Upper Limit and Output Pattern Range 29
k2+180 to k2+185	00-15	Range Data Range 30	Lower/Upper Limit and Output Pattern Range 30
k2+186 to k2+191	00-15	Range Data Range 31	Lower/Upper Limit and Output Pattern Range 31

4-2-6 Comparison Memory Mapping

Word	Bit	Item	Function
Counter 1			
k1, k1+1	00-15	Comparison Value 0	Comparison Value 0
k1+2, k1+3	00-15	+Set Pattern	Output Set Pattern crossing CV0 in + direction
k1+4, k1+5	00-15	+Reset Pattern	Output Reset Pattern crossing CV0 in + direction
k1+6, k1+7	00-15	-Set Pattern	Output Set Pattern crossing CV0 in - direction
k1+8, k1+9	00-15	-Reset Pattern	Output Reset Pattern crossing CV0 in - direction
k1+10 to k1+19	00-15	CV Data CV1	CV1 and Output Set/Reset patterns +/- direction
k1+20 to k1+29	00-15	CV Data CV2	CV2 and Output Set/Reset patterns +/- direction
k1+30 to k1+39	00-15	CV Data CV3	CV3 and Output Set/Reset patterns +/- direction
k1+40 to k1+49	00-15	CV Data CV4	CV4 and Output Set/Reset patterns +/- direction
k1+50 to k1+59	00-15	CV Data CV5	CV5 and Output Set/Reset patterns +/- direction
k1+60 to k1+69	00-15	CV Data CV6	CV6 and Output Set/Reset patterns +/- direction
k1+70 to k1+79	00-15	CV Data CV7	CV7 and Output Set/Reset patterns +/- direction
k1+80 to k1+89	00-15	CV Data CV8	CV8 and Output Set/Reset patterns +/- direction
k1+90 to k1+99	00-15	CV Data CV9	CV9 and Output Set/Reset patterns +/- direction
k1+100 to k1+109	00-15	CV Data CV10	CV10 and Output Set/Reset patterns +/- direction
k1+110 to k1+119	00-15	CV Data CV11	CV11 and Output Set/Reset patterns +/- direction
k1+120 to k1+129	00-15	CV Data CV12	CV12 and Output Set/Reset patterns +/- direction
k1+130 to k1+139	00-15	CV Data CV13	CV13 and Output Set/Reset patterns +/- direction
k1+140 to k1+149	00-15	CV Data CV14	CV14 and Output Set/Reset patterns +/- direction
k1+150 to k1+159	00-15	CV Data CV15	CV15 and Output Set/Reset patterns +/- direction
k1+160 to k1+169	00-15	CV Data CV16	CV16 and Output Set/Reset patterns +/- direction
k1+170 to k1+179	00-15	CV Data CV17	CV17 and Output Set/Reset patterns +/- direction
k1+180 to k1+189	00-15	CV Data CV18	CV18 and Output Set/Reset patterns +/- direction
k1+190 to k1+199	00-15	CV Data CV19	CV19 and Output Set/Reset patterns +/- direction
k1+200 to k1+209	00-15	CV Data CV20	CV20 and Output Set/Reset patterns +/- direction
k1+210 to k1+219	00-15	CV Data CV21	CV21 and Output Set/Reset patterns +/- direction
k1+220 to k1+229	00-15	CV Data CV22	CV22 and Output Set/Reset patterns +/- direction
k1+230 to k1+239	00-15	CV Data CV23	CV23 and Output Set/Reset patterns +/- direction
k1+240 to k1+249	00-15	CV Data CV24	CV24 and Output Set/Reset patterns +/- direction
k1+250 to k1+259	00-15	CV Data CV25	CV25 and Output Set/Reset patterns +/- direction
k1+260 to k1+269	00-15	CV Data CV26	CV26 and Output Set/Reset patterns +/- direction
k1+270 to k1+279	00-15	CV Data CV27	CV27 and Output Set/Reset patterns +/- direction
k1+280 to k1+289	00-15	CV Data CV28	CV28 and Output Set/Reset patterns +/- direction
k1+290 to k1+299	00-15	CV Data CV29	CV29 and Output Set/Reset patterns +/- direction
k1+300 to k1+309	00-15	CV Data CV30	CV30 and Output Set/Reset patterns +/- direction
k1+310 to k1+319	00-15	CV Data CV31	CV31 and Output Set/Reset patterns +/- direction

Word	Bit	Item	Function
Counter 2			
k2, k2+1	00-15	Comparison Value 0	Comparison Value 0
k2+2, k2+3	00-15	+Set Pattern	Output Set Pattern crossing CV0 in + direction
k2+4, k2+5	00-15	+Reset Pattern	Output Reset Pattern crossing CV0 in + direction
k2+6, k2+7	00-15	-Set Pattern	Output Set Pattern crossing CV0 in - direction
k2+8, k2+9	00-15	-Reset Pattern	Output Reset Pattern crossing CV0 in - direction
k2+10 to k2+19	00-15	CV Data CV1	CV1 and Output Set/Reset patterns +/- direction
k2+20 to k2+29	00-15	CV Data CV2	CV2 and Output Set/Reset patterns +/- direction
k2+30 to k2+39	00-15	CV Data CV3	CV3 and Output Set/Reset patterns +/- direction
k2+40 to k2+49	00-15	CV Data CV4	CV4 and Output Set/Reset patterns +/- direction
k2+50 to k2+59	00-15	CV Data CV5	CV5 and Output Set/Reset patterns +/- direction
k2+60 to k2+69	00-15	CV Data CV6	CV6 and Output Set/Reset patterns +/- direction
k2+70 to k2+79	00-15	CV Data CV7	CV7 and Output Set/Reset patterns +/- direction
k2+80 to k2+89	00-15	CV Data CV8	CV8 and Output Set/Reset patterns +/- direction
k2+90 to k2+99	00-15	CV Data CV9	CV9 and Output Set/Reset patterns +/- direction
k2+100 to k2+109	00-15	CV Data CV10	CV10 and Output Set/Reset patterns +/- direction
k2+110 to k2+119	00-15	CV Data CV11	CV11 and Output Set/Reset patterns +/- direction
k2+120 to k2+129	00-15	CV Data CV12	CV12 and Output Set/Reset patterns +/- direction
k2+130 to k2+139	00-15	CV Data CV13	CV13 and Output Set/Reset patterns +/- direction
k2+140 to k2+149	00-15	CV Data CV14	CV14 and Output Set/Reset patterns +/- direction
k2+150 to k2+159	00-15	CV Data CV15	CV15 and Output Set/Reset patterns +/- direction
k2+160 to k2+169	00-15	CV Data CV16	CV16 and Output Set/Reset patterns +/- direction
k2+170 to k2+179	00-15	CV Data CV17	CV17 and Output Set/Reset patterns +/- direction
k2+180 to k2+189	00-15	CV Data CV18	CV18 and Output Set/Reset patterns +/- direction
k2+190 to k2+199	00-15	CV Data CV19	CV19 and Output Set/Reset patterns +/- direction
k2+200 to k2+209	00-15	CV Data CV20	CV20 and Output Set/Reset patterns +/- direction
k2+210 to k2+219	00-15	CV Data CV21	CV21 and Output Set/Reset patterns +/- direction
k2+220 to k2+229	00-15	CV Data CV22	CV22 and Output Set/Reset patterns +/- direction
k2+230 to k2+239	00-15	CV Data CV23	CV23 and Output Set/Reset patterns +/- direction
k2+240 to k2+249	00-15	CV Data CV24	CV24 and Output Set/Reset patterns +/- direction
k2+250 to k2+259	00-15	CV Data CV25	CV25 and Output Set/Reset patterns +/- direction
k2+260 to k2+269	00-15	CV Data CV26	CV26 and Output Set/Reset patterns +/- direction
k2+270 to k2+279	00-15	CV Data CV27	CV27 and Output Set/Reset patterns +/- direction
k2+280 to k2+289	00-15	CV Data CV28	CV28 and Output Set/Reset patterns +/- direction
k2+290 to k2+299	00-15	CV Data CV29	CV29 and Output Set/Reset patterns +/- direction
k2+300 to k2+309	00-15	CV Data CV30	CV30 and Output Set/Reset patterns +/- direction
k2+310 to k2+319	00-15	CV Data CV31	CV31 and Output Set/Reset patterns +/- direction

4-3 IOWR-Instruction

IOWR(223)
C
S
D

@IOWR(223)
C
S
D

C Control Code.

The IOWR-instruction enables you to send messages to the High-speed Counter Unit. The high-byte (=CC1) and the low-byte (=CC2) of the Control Code specify the type of message that is to be send.

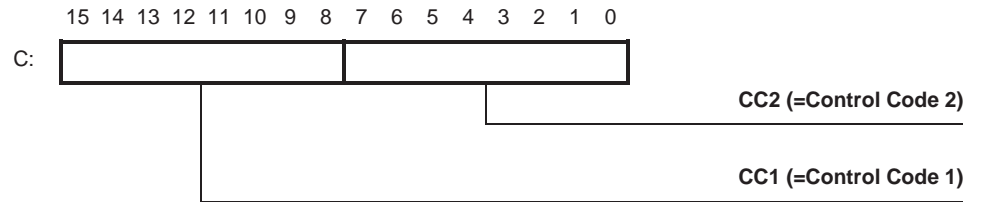

S First Source Word.

The PLC memory address of the first word to be transferred.

D Destination Machine Number (D) and number of words (D+1) to be transferred.

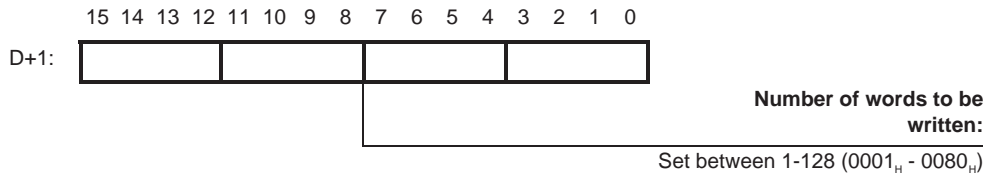
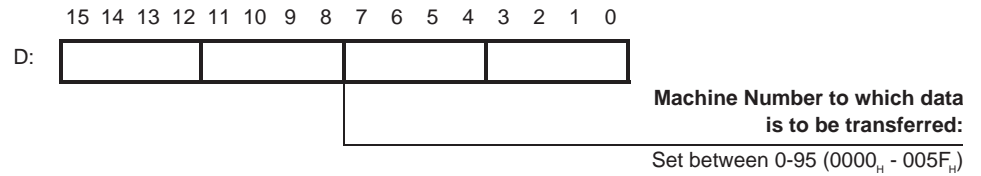

Example ladder program

Refer to the following structure for the ladder program if you want to use the IOWR-instruction. For an overview of the supported IOWR-instructions and how to set the C-, S- and D-operands, refer to 4-5 "Supported IOWR/IORD-Instructions".

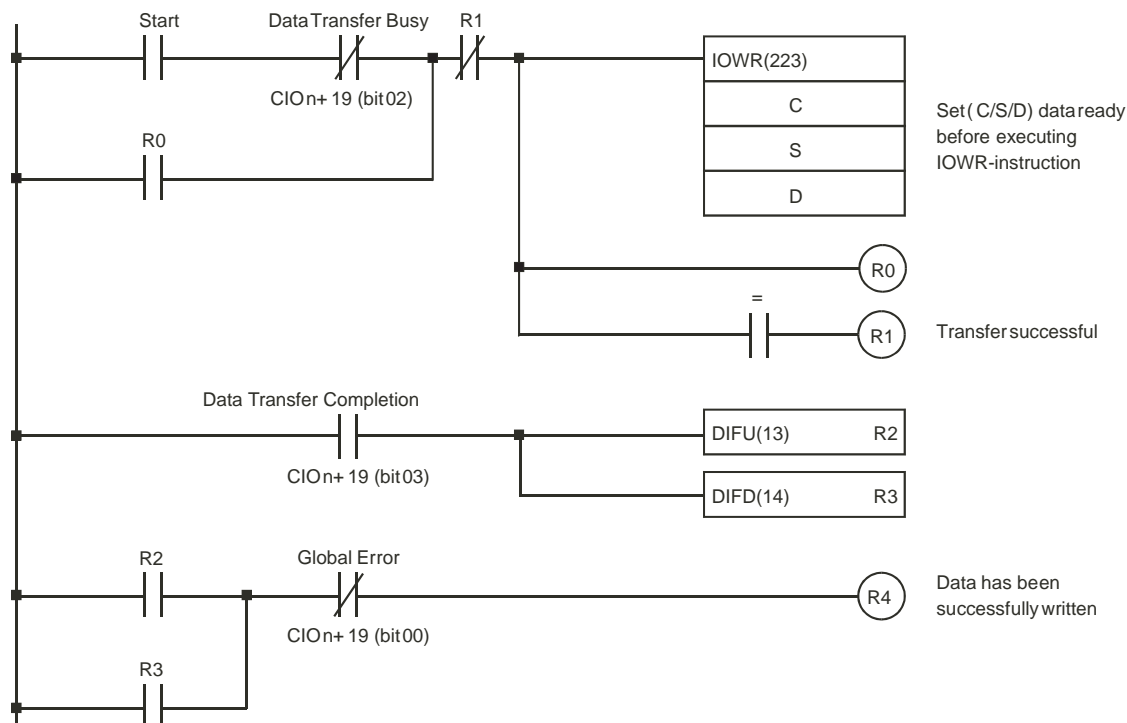

The Data Transfer Busy bit (CIO n+19, bit 02) is ON when the Unit is busy completing an IOWR/IORD-instruction or being initialised. When this bit is OFF the Unit is ready to execute the IOWR-instruction. If an error occurs during the execution of the IOWR-instruction the ER-flag turns ON. The Data Transfer Completion bit (CIO n+19, bit 03) is toggled every time that data transfer is completed. The Global Error bit (CIO n+19, bit 00) turns ON when the Unit detects any error that causes this bit to be set (refer to 5-2 "Error codes").

Note If you omit to include the Data Transfer Busy bit (CIO n+19, bit 02) in the ladder instruction and you start issuing an IOWR-instruction while another IOWR/IORD-instruction is in progress the ER-flag turns ON. Therefore, to guarantee correct execution of IOWR-instructions, you should always use the ladder diagram structure as shown above.

The response time for bits allocated to outputs (e.g., Open Gate Bit) will be delayed while the Data Transfer Busy bit (CIO n+19, bit 02) is ON (e.g., when time is required to process IOWR or when a Unit is reset). In any case, the bit allocated to the output will be processed as soon as the Data Transfer Busy bit turns OFF. Comparison stops while the Data Transfer Busy bit (CIO n+19, bit 02) is ON. Refer to 3-5-1-2 "Configuration and operation in Range Mode" and 3-5-2-2 "Configuration and operation in Comparison Mode" for details.

4-4 IORD-Instruction

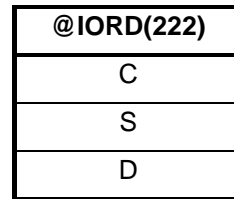
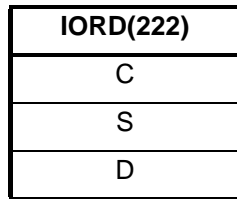

C Control Code.

The IORD-instruction enables you to read data from the High-speed Counter Unit. The high-byte (=CC1) and the low-byte (=CC2) of the Control Code specify the type of data that is to be read.

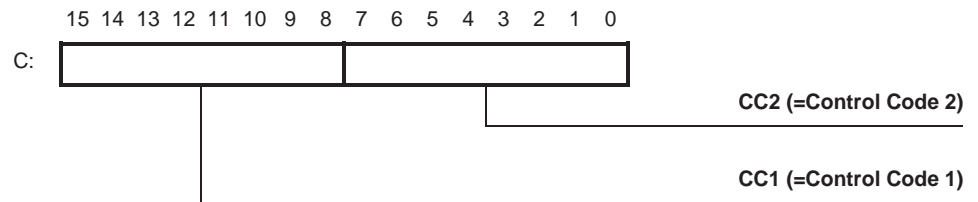

S First Source Word.

Source Machine Number (S) and the number of words (S+1) to be read.

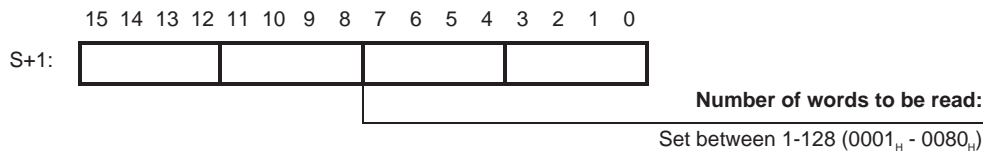
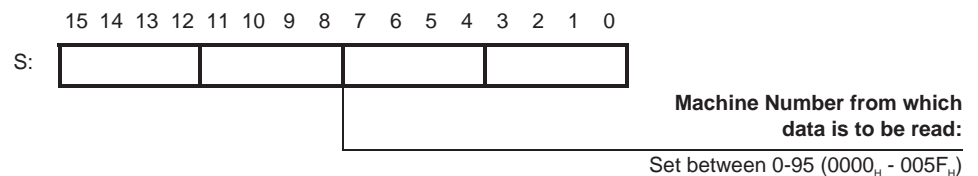

D First Destination Word.

The PLC memory address of the first word where the read data is to be written.

Example ladder program

Refer to the following structure for the ladder program if you want to use the IORD-instruction. For an overview of the supported IORD-instructions and how to set the C-, S- and D-operands, refer to 4-5 "Supported IOWR/IORD-Instructions".

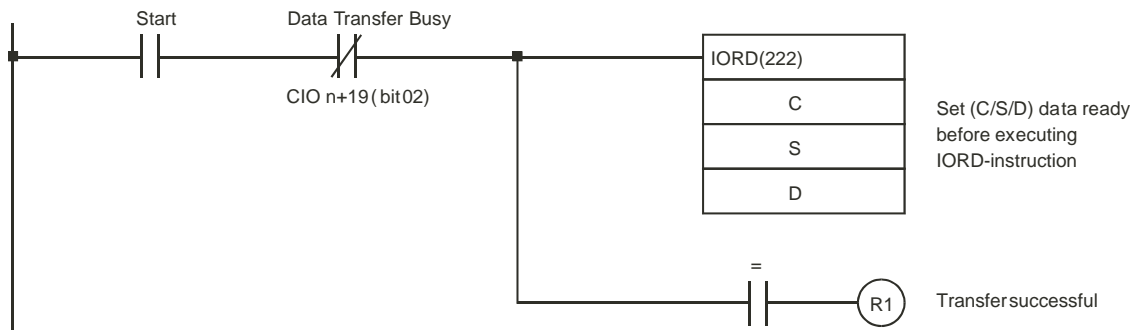

The Data Transfer Busy bit (CIO n+19, bit 02) is ON when the Unit is busy completing an IOWR/IORD-instruction or being initialised. When this bit is OFF the

Unit is ready to execute the IORD-instruction. If an error occurs during the execution of the IORD-instruction the ER-flag turns ON.

Note If you omit to include the Data Transfer Busy bit (CIO n+19, bit 02) in the ladder instruction and you start issuing an IORD-instruction while another IOWR/IORD-instruction is in progress the ER-flag turns ON. Therefore, to guarantee correct execution of IORD-instructions, you should always use the ladder diagram structure as shown above.

The response time for bits allocated to outputs (e.g., Open Gate Bit) will be delayed while the Data Transfer Busy bit (CIO n+19, bit 02) is ON (e.g., when time is required to process IORD or when a Unit is reset). In any case, the bit allocated to the output will be processed as soon as the Data Transfer Busy bit turns OFF. Comparison stops while the Data Transfer Busy bit (CIO n+19, bit 02) is ON. Refer to 3-5-1-2 "*Configuration and operation in Range Mode*" and 3-5-2-2 "*Configuration and operation in Comparison Mode*" for details.

4-5 Supported IOWR/IORD-Instructions

4-5-1 DM-data

4-5-1-1 DM-words Used for IOWR/IORD

Memory Location	Item	IOWR	IORD	Control Code		No. of Words
				CC1	CC2	
General						
m	Output Control Mode	N	N	---	---	---
	AND/OR Counter Output Patterns	N	N	---	---	---
m+1	Interrupt Task Offset (outputs)	N	N	---	---	---
m+2, m+3	Interrupt Mask Outputs	Y	Y	0B	01	2
m+4	Interrupt Task Offset (inputs)	N	N	---	---	---
m+5	Interrupt Mask Digital Inputs	Y	Y	0B	02	1
m+6	Physical Output NPN/PNP	N	N	---	---	---
	Output State Control	N	N	---	---	---
m+7	Input Noise Filter Counters	N	N	---	---	---
m+8	Input Noise Filter Digital Inputs	N	N	---	---	---
m+9 to m+16	Output Pulse ON-delay and Pulse Duration	N	N	---	---	---
m+17 to m+20	Digital Input Functionality	N	N	---	---	---
m+21, m+22	Predefined Output Pattern	N	N	---	---	---
m+23 to m+29	Not used	---	---	---	---	---
Counter 1						
m+30	Counter Type	N	N	---	---	---
m+31	Signal Type	N	N	---	---	---
m+32	Z-reset Mode	Y	Y	1E	01	1
	Overflow/Underflow error-code generation	N	N	---	---	---
m+33, m+34	Max. Count Value Circular/Linear	Y	Y	1C	03	2
m+35, m+36	Min. Count Value Linear	Y	Y	1C	04	2
m+37, m+38	Power On Preset Value	N	N	---	---	---
m+39	Time-Window (Rate Measurement)	N	N	---	---	---
m+40 to m+47	Rate-Range 0 Data	Y	Y	1F	02	8
m+48 to m+55	Rate-Range 1 Data	Y	Y	1F	03	8
m+56	Rate-Range 0 and 1 Enable Data	Y	Y	1B	04	1
m+57, m+58	Range / Comparison Enable Data	Y	Y	1B	03	2
m+59, m+60	Output (P)reset Set Pattern	N	N	---	---	---
m+61, m+62	Output (P)reset Reset Pattern	N	N	---	---	---
m+63	Hysteresis	N	N	---	---	---
m+64	# Ranges / # Comparison Values	N	N	---	---	---
m+65	Memory Area	N	N	---	---	---
m+66, m+67	Memory Address	N	N	---	---	---

Memory Location	Item	IOWR	IORD	Control Code		No. of Words
				CC1	CC2	
m+68 to m+74	Not used	---	---	---	---	---
Counter 2						
m+75	Counter Type	N	N	---	---	---
m+76	Signal Type	N	N	---	---	---
m+77	Z-reset Mode	Y	Y	2E	01	1
	Overflow/Underflow error-code generation	N	N	---	---	---
m+78, m+79	Max. Count Value Circular/Linear	Y	Y	2C	03	2
m+80, m+81	Min. Count Value Linear	Y	Y	2C	04	2
m+82, m+83	Power On Preset Value	N	N	---	---	---
m+84	Time-Window (Rate Measurement)	N	N	---	---	---
m+85 to m+92	Rate-Range 0 Data	Y	Y	2F	02	8
m+93 to m+100	Rate-Range 1 Data	Y	Y	2F	03	8
m+101	Rate-Range 0 and 1 Enable Data	Y	Y	2B	04	1
m+102, m+103	Range / Comparison Enable Data	Y	Y	2B	03	2
m+104, m+105	Output (P)reset Set Pattern	N	N	---	---	---
m+106, m+107	Output (P)reset Reset Pattern	N	N	---	---	---
m+108	Hysteresis	N	N	---	---	---
m+109	# Ranges / # Comparison Values	N	N	---	---	---
m+110	Memory Area	N	N	---	---	---
m+111, m+112	Memory Address	N	N	---	---	---
m+113 to m+399	Not used	---	---	---	---	---

4-5-1-2 Data Used for IOWR/IORD

Item	IOWR	IORD	Control Code		No. of Words
			CC1	CC2	
Data Range 00 – Data Range 31	Y	Y	cA	00-31	6 x M ^{*1}
Data Comparison Value 00 – Data Comparison Value 31	Y	Y	cA	00-31	10 x M ^{*2}
Captured Count Value	N	Y	cC	02	2
Rate History Log File Data	N	Y	cF	01	2 x R ^{*3}
Counter Value	Y	Y	cC	01	2
(Re) Configure Unit	Y	N	0D	01	1
Clear Error(s)	Y	N	EC	00	1

c = Counter Number (1 or 2)

*1 M = Number of Ranges, 1 ≤ M ≤ 21

*2 M = Number of Comparison Values, 1 ≤ M ≤ 12

*3 R = Pulse Rate value, 1 ≤ R ≤ 64

Note Data written with the IOWR instruction is valid only until the Unit is restarted or the power supply is turned OFF. The settings in the DM and EM Area in the CPU Unit will be used after the next time the Unit is restarted or power is turned ON. If the settings made with IOWR instruction need to be used after the Unit is restarted or power is cycled, write the same settings to the DM and EM Area in the CPU Unit.

Example:

The High-speed Counter Unit is assigned Machine Number 6. You want to change the Maximum Count Value of Circular Counter 2. The new Maximum Count Limit consists of 2 words, is located in Data-Memory at address D0050 and D0051 and is equal to 2710_H (=10,000 decimal).

IOWR(223)	
#2C03	CC1= 2C (= Counter 2), CC2= 03
D0050	S= D0050 (first word with new Maximum Count Value)
#00020006	D= #0006 (Machine Number) and D+1= #0002 (# words)

Example:

The High-speed Counter Unit is in Range Mode and is assigned Machine Number 3. You want to read the Range Enable Data of Counter 2 and write it to D1800 in the PLC memory.

IORD(222)	
#2B03	CC1= 2B (= Counter 2), CC2= 03
#00020003	S= #0003 (Machine Number) and S+1= #0002 (# words)
D1800	D= D1800 (write Range Enable Data to D1800 and D1801)

4-5-2 Range- and Comparison data

The Unit can be in Range or Comparison Mode (refer to 3-5-1 "Range Mode" and 3-5-2 "Comparison Mode"). IOWR- and IORD-instructions can be used respectively to change Range/Comparison Data inside the Unit or to read Range/Comparison Data from the Unit, during actual operation. Depending on the mode of the Unit (Range or Comparison mode) the Control Code is interpreted accordingly by the High-speed Counter Unit.

Item	IOWR	IORD	Control Code		No. of Words
			CC1	CC2	
Data Range 00 – Data Range 31	Y	Y	cA	00-31	6 x M ^{*1}
Data Comparison Value 00 – Data Comparison Value 31	Y	Y	cA	00-31	10 x M ^{*2}

c = Counter Number (1 or 2)

*1 M = Number of Ranges, 1 ≤ M ≤ 21

*2 M = Number of Comparison Values, 1 ≤ M ≤ 12

Note When transferring new Comparison Values to the Unit, be sure that the same Comparison Value is not used more than once in the same Counter. If the same Comparison Value exists more than once in the same Counter, an error will occur when the IOWR-instruction is executed. Refer to 3-5-2-2 "Configuration and operation in Comparison Mode" and 5-2-2 "IOWR/IORD-instruction errors" for details.

Range Data

If the Unit is in Range Mode for each Counter the Range Data of one or multiple Ranges can be read from the Unit or written to the Unit. For every Range the Range Data is contained in 6 words. Every IORD- and IOWR-instruction can transfer up to a maximum of 128 words. Thus per IORD- or IOWR-instruction you can read or write Range Data of up to a maximum of 21 Ranges.

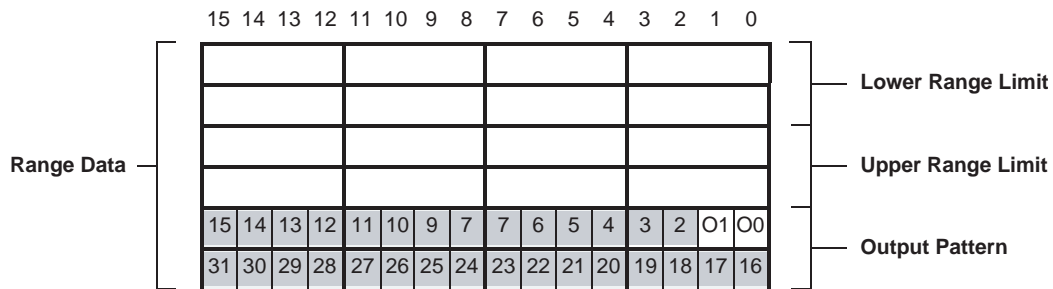

In the Output Pattern the Outputs are represented by:

- = Digital Outputs 0-1
(corresponding with Physical Digital Outputs O0 and O1)
- = Soft Outputs 2-31

In the Control Code, CC1 specifies the Counter number (c = 1 or 2) from which the Range Data is to be read or written. CC2 specifies the first Range number (00-31). Depending on the number of Ranges that you want to read the Range Data from or overwrite with new Range Data, you have to specify the number of words to be transferred. This number of words is equal to the number of Ranges x 6.

Example:

The High-speed Counter Unit, with Machine Number 1, operates in Range Mode and Counter 2 uses 5 Ranges (Range 00 to Range 04). You want to change the Range Data of Ranges 03 and 04. The new Range Data, consisting of 12 words (= 6 words x 2 Ranges), is located in Data-Memory starting from D0100.

IOWR(223)	
#2A03	CC1= 2A (= Counter 2), CC2= 03 (= first Range Number)
D0100	S= D0100 (first word with new Range Data)
#000C0001	D= #0001 (Machine Number) and D+1= #000C (# words)

Comparison Data

If the Unit is in Comparison Mode for every Counter the Comparison Data of one or multiple Comparison Values can be read or written. For every Comparison Value the CV Data is contained in 10 words. Every IORD- and IOWR-instruction can transfer up to a maximum of 128 words. Thus per IORD- or IOWR-instruction you can read or write CV Data of up to a maximum of 12 Comparison Values.

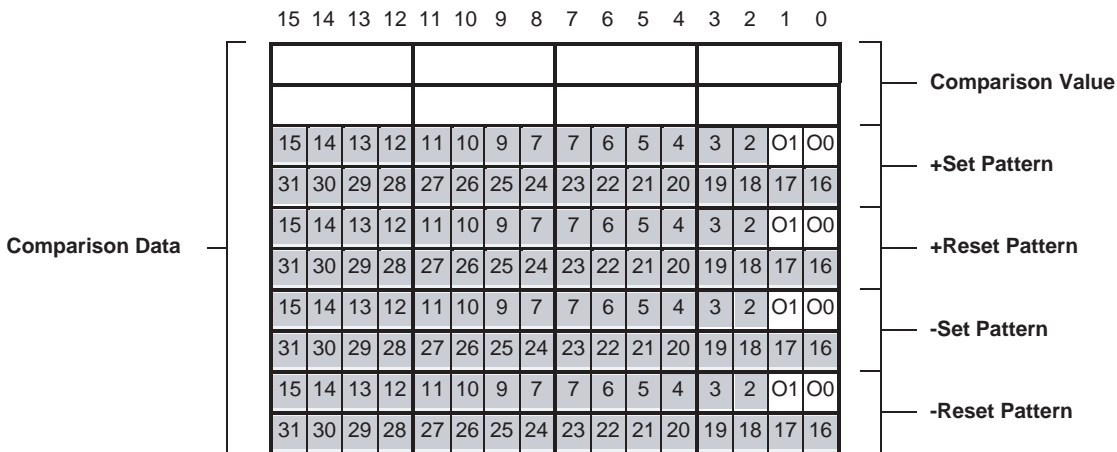

In the +/- Set and Reset Patterns the Outputs are represented by:

- = Digital Outputs 0-1
(corresponding with Physical Digital Outputs O0, and O1)
- = Soft Outputs 2-31

On reaching the Comparison Value:

+ and – Set Patterns: **+ and – Reset Patterns:**
 0 = No Change 0 = No Change

In the Control Code, CC1 specifies the Counter number (1 or 2) from which the CV Data is to be read or written. CC2 specifies the first CV number (00-31). Depending on the number of CV's that you want to read the CV Data from or overwrite with new CV Data, you have to specify the number of words to be transferred. This number of words is equal to the number of CV's x 10.

Example:

The High-speed Counter Unit, with Machine Number 3, operates in Comparison Mode and Counter 1 uses 4 Comparison Values (CV 00 to CV 03). You want to change the Comparison Data of CV 00. The new Comparison Data, consisting of 10 words (= 10 words x 1 CV), is located in Data-Memory starting from D0200.

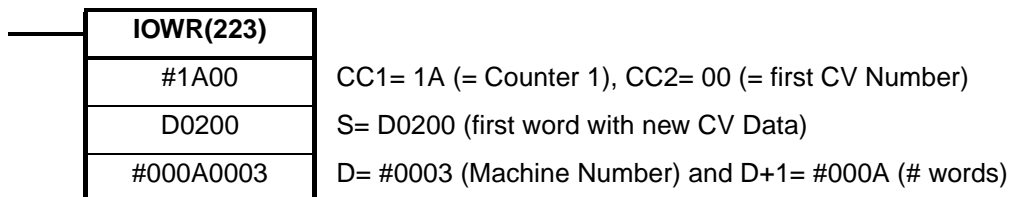

4-5-3 Special data

4-5-3-1 Captured Counter Value

The Counter Value can be captured into the Capture Register by using a Digital Input (Function 07 or 08) or by using the "Capture Counter Value bit" in CIO (refer to 3-4 "Digital Input Functions" for more information). For this purpose every Counter is equipped with a Capture Register inside the High-speed Counter Unit. If you want to use the captured Counter Value in the PLC ladder program you have to use the IORD-instruction that reads the value from the Capture Register of the specific Counter.

Item	IOWR	IORD	Control Code		No. of Words
			CC1	CC2	
Captured Counter Value	N	Y	cC	02	2

c = Counter Number (1 or 2)

Example:

The High-speed Counter Unit is assigned Machine Number 8. You want to read the Captured Counter Value of Counter 1 and write it to D0300 in the PLC memory.

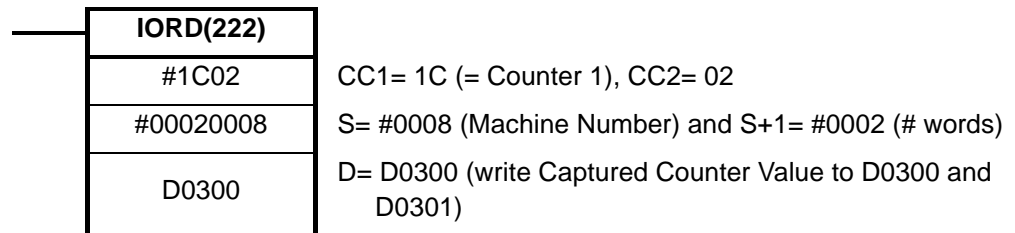

Note Reading the Captured Counter Value with IORD is also supported for Simple Counters (refer to 3-2-1 "Simple Counter").

4-5-3-2 Rate History Log File data

The Rate History Log File, inside the Unit, contains up to a maximum of 64 most recent Rate Values. If you want to use one or multiple Rate Values from the Rate History Log File in the PLC ladder program, you have to use an IORD-instruction. The IORD-instruction returns the specified number of Rate Values starting from the youngest Rate Value.

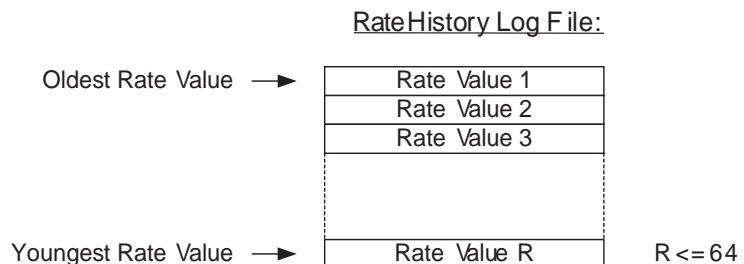

(The Rate Values occupy 2 words each)

Item	IOWR	IORD	Control Code		No. of Words
			CC1	CC2	
Rate History Log File data	N	Y	cF	01	2 x R*

c = Counter Number (1 or 2)

* R = Number of Rate Values, $1 \leq R \leq 64$

Example:

The High-speed Counter Unit is assigned Machine Number 7. You want to read the youngest Rate Value from the Rate History Log File of Counter 1 and write it to D0500 in the PLC memory.

IORD(222)	
#1F01	CC1= 1F (= Counter 1), CC2= 01
#00020007	S= #0007 (Machine Number) and S+1= #0002 (# words)
D0500	D= D0500 (write youngest Rate Value to D0500 and D0501)

4-5-3-3 Counter Value

The Counter Value of every Counter can be overwritten and read by using the IOWR- and IORD-instructions, during actual operation of the Unit.

Item	IOWR	IORD	Control Code		No. of Words
			CC1	CC2	
Counter Value	Y	Y	cC	01	2

c = Counter Number (1 or 2)

Example:

The High-speed Counter Unit is assigned Machine Number 5. You want to overwrite the Counter Value of Counter 2 with 500 (= 01F4 (hex)).

IOWR(223)	
#2C01	CC1= 2C (= Counter 2), CC2= 01
D0100	S= D0100 (= new Counter Value = #000001F4)
#00020005	D= #0005 (Machine Number) and D+1 = #0002 (# words)

Note Reading/writing the Counter Value with IORD/IOWR is also supported for Simple Counters (refer to 3-2-1 "Simple Counter").

4-5-3-4 (Re) Configure Unit

During operation of the Unit (PLC is in RUN/MONITOR-mode), the Unit can be configured by using the IOWR-instruction from the PLC ladder program. Issuing the IOWR-instruction from the PLC ladder program results in transferring all the Unit configuration data to the Unit. The Unit configuration data consists of the data in the Special I/O Unit DM Area and the Range/Comparison Data.

Item	IOWR	IORD	Control Code		No. of Words
			CC1	CC2	
(Re) Configure Unit	Y	N	0D	01	1

Example:

The High-speed Counter Unit is assigned Machine Number 2. You want to (re) configure the Unit by transferring all the configuration settings to the Unit (the PLC is in RUN/MONITOR-mode).

IOWR(223)	
#0D01	CC1= 0D, CC2= 01
-	S=Not relevant (fill in valid constant, e.g. D0300 containing #0000)
#00010002	D= #0002 (Machine Number) and D+1= #0001 (# words)

1. The configuration settings can also be transferred to the Unit by Powering Up the CJ-series PLC system or by restarting the Unit.
2. The Counter Values remain unchanged after the "(Re) Configure Unit" instruction has been sent to the Unit.

⚠ Caution Before you make your ladder program operational, make sure that the IOWR-instruction "(Re) Configure Unit" uses valid configuration data. If the Unit configuration data contains invalid settings the Unit will *stop* operating and report the error(s).

4-5-3-5 Error Clear Command

The error-codes of errors occurring at the High-speed Counter Unit are stored in the Unit and are available to you as a Error History Log File (refer to 5-2 "Error codes" for more details about the error categories that can be distinguished and filing errors).

The error-codes generated by IORD/IOWR-instruction errors can be cleared by issuing the Error Clear command ("EC") with the IOWR-instruction. After the errors have been cleared, they are still available to you from the Error History Log File. To troubleshoot errors from other categories refer to 5-2 "Error codes" for the applicable remedy.

Item	IOWR	IORD	Control Code		No. of Words
			CC1	CC2	
Clear Error(s)	Y	N	EC	00	1

Example:

The High-speed Counter Unit is assigned Machine Number 2. You want to clear all IOWR/IORD-instruction errors by issuing the IOWR-instruction with the Error Clear command.

IOWR(223)	
#EC00	CC1= EC, CC2= 00
-	S=Not relevant (fill in valid constant, e.g. D0400 containing #0000)
#00010002	D= #0002 (Machine Number) and D+1= #0001 (# words)

Note Writing the Error Clear Command with IOWR is also supported for Simple Counters (refer to 3-2-1 "Simple Counter"). This enables you to clear IORD/IOWR-instruction errors that occurred after you have issued the IORD-instruction "Captured Counter Value" or the IORD/IOWR-instruction "Counter Value" to a Simple Counter.

4-6 Interrupts

The status information of the 2 Digital Inputs and the 32 Outputs is exchanged with the CJ-series CPU Unit every I/O refresh via the Special I/O Unit Area. The I/O refresh is executed cyclically at the end of the Ladder Program or can be forced by I/O refresh instruction. In both cases the CJ-series CPU Unit takes the initiative for a data-exchange. In order for the High-speed Counter Unit to be able to report the status information of the 2 Digital Inputs and 32 Outputs to the CJ-series CPU Unit, independent from the I/O Refresh, all Digital Inputs and Outputs can be configured to generate interrupts. Important events, indicated by a status change of the Digital Inputs and the Outputs, can thus be reported as quickly as possible to the CJ-series CPU Unit.

Note External interrupts are supported only by CJ1-H and CJ1M CPU Units. They are not supported by CJ1 CPU Units. If you want the High-speed Counter Unit to generate interrupts to activate external interrupt tasks in a CJ1-H CPU Unit, the Counter Unit must be in one of the five positions immediately to the right of the CJ1-H CPU Unit on the CPU Rack. If you want the High-speed Counter Unit to generate interrupts to activate external interrupt tasks in a CJ1M CPU Unit, the Unit must be in one of the three positions immediately to the right of the CJ1M CPU Unit on the CPU Rack.

No external interrupt tasks can be activated for CJ1-H or CJ1M CPU Units if the CJ1W-CT021 High-speed Counter Unit is in any other position (i.e., 6th Unit position or further away from the CJ1-H CPU Unit, or 4th Unit position or further away from the CJ1M CPU Unit), or if it is on a CJ-series Expansion Rack. All external interrupt tasks will be disabled in these cases.

4-6-1 Outputs Generating Interrupts

Enabling / Disabling Interrupts

The 32 Outputs, divided in 2 Digital Outputs and 30 Soft Outputs, can all be configured to generate interrupts to the CJ-series CPU Unit. If an Output is configured to generate interrupts, an interrupt is issued to the CJ-series CPU Unit at a rising and at a falling edge of the corresponding bit in the Unit Output Pattern. For this purpose two external interrupt tasks in the CJ-series CPU Unit are assigned to every Output. In the external interrupt task you should write an appropriate (ladder) program that takes the required action on the occurrence of an interrupt.

You can configure an Output to generate interrupts by setting the corresponding bit in the Interrupt Enable Data of the Outputs. The Interrupt Enable Data of the Outputs consists of 32 bits representing the 32 Outputs. By default Outputs are disabled to generate interrupts.



= Digital Outputs 0-1
(corresponding to Physical Digital Outputs O0 and O1)

= Soft Outputs 2-31

0 = Interrupts Disabled

1 = Interrupts Enabled

External Interrupt Task Offset

Every Output that is enabled to generate interrupts is assigned two External Interrupt Tasks in the CJ-series CPU Unit. For this purpose all 32 Outputs are assigned in sequential order to consecutive External Interrupt Tasks starting from Output 0. By defining an Offset you determine the External Interrupt Task numbers of the (first two) External Interrupt Tasks that are assigned to Output 0. The remaining 31 Outputs are assigned to the respective External Interrupt Task numbers in increasing order starting from "Offset + 2".

Output	Assigned External Interrupt Task Number	Interrupt executed at rising/falling edge*
0 (=O0)	Offset	Rising
	Offset + 1	Falling
1 (=O1)	Offset + 2	Rising
	Offset + 3	Falling
2	Offset + 4	Rising
	Offset + 5	Falling
3	Offset + 6	Rising
	Offset + 7	Falling
4	Offset + 8	Rising
	Offset + 9	Falling
~	~	~

Output	Assigned External Interrupt Task Number	Interrupt executed at rising/falling edge*
31	Offset + 62	Rising
	Offset + 63	Falling

* The assigned External Interrupt Task number is executed at a rising/falling edge of the corresponding Output bit in the Unit Output Pattern.

For every Output the assigned External Interrupt Task number can be calculated with the following formula ('O' = Output):

Assigned External Interrupt Task Number to the

- rising edge of the Output bit is equal to: Offset + 2xO
- falling edge of the Output bit is equal to: Offset + 2xO+1

For a complete overview of all External Interrupt Task numbers to be assigned to the Outputs, refer to Appendix B "Assigning External Interrupt Tasks to Outputs".

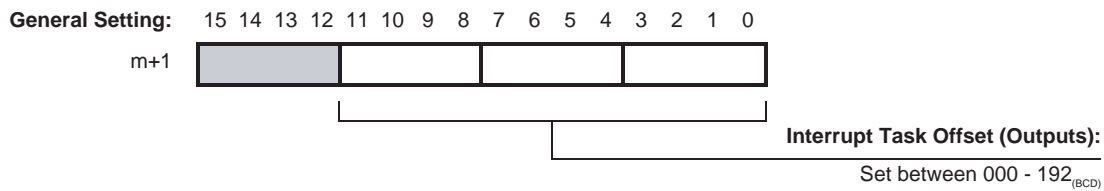

Since there are 256 External Interrupt Tasks available (numbered 0 to 255) the Offset can be maximum 192. With an Offset of 192 the last Output (31) will be assigned the last available External Interrupt Task 255 (=192+2x31+1).

Example 1

If you only want Soft Input 3 to generate interrupts and you only want to execute an External Interrupt Task on the rising edge of Digital Output 3, than you must enable Output 3 to generate interrupts ($m+2 = 0008_H$ and $m+3 = 0000_H$). If you decide to use an Offset of 5 ($m+1 = 0005_{(BCD)}$) than External Interrupt Tasks 11 and 12 will be assigned to Output 3. In External Interrupt Task 11 you should write an appropriate (ladder) program which is to be executed at a rising edge of the corresponding bit of Output 3 in the Unit Output Pattern. External Interrupt Task 12 must also be programmed but will remain empty since no action is required on a falling edge of Output 3.

Example 2

An Offset of 10 ($m+1 = 0010_{(BCD)}$), with all 32 Outputs enabled to generate interrupts ($m+2$ and $m+3 = FFFF_H$), means that the rising edge of the corresponding bit of Output 0 in the Unit Output Pattern is assigned to External Interrupt Task Number 10 and the falling edge to External Interrupt Task 11. The rising edge of Output 1 to External Interrupt Task Number 12 and the falling edge to External Interrupt Task Number 13 and so on. For Output 31 the two External Interrupt Tasks 72 and 73 are assigned. Now you have External Interrupt Tasks 10 to 73 available. In every Task you should write an appropriate (ladder) program which is to be executed at the Outputs' corresponding rising or falling edge.

The application example in section 6-4 "CAM-positioning" shows you how to use outputs generating interrupts.

4-6-2 Digital Inputs Generating Interrupts

Enabling / Disabling Interrupts

The 2 Digital Inputs can all be configured to generate interrupts to the CJ-series CPU Unit. If a Digital Input is configured to generate interrupts, an interrupt is issued to the CJ-series CPU Unit at a rising- or falling edge of the signal applied to the Digital Input. The Function that is assigned to the Digital Input determines if the interrupt is generated at a rising- or falling edge (refer to 3-4 "Digital Input Functions").

Number	Function	Interrupt on
00	No Function	Rising Edge
01	Gate Positive	Rising Edge
02	Gate Negative	Falling Edge
03	Preset Rising Edge	Rising Edge
04	Preset Falling Edge	Falling Edge
05	Reset Rising Edge	Rising Edge
06	Reset Falling Edge	Falling Edge
07	Capture Rising Edge	Rising Edge
08	Capture Falling Edge	Falling Edge
09	Stop, Capture and Continue	Rising Edge
10	Stop, Capture and Continue (Inv)	Falling Edge
11	Stop, Capture, Reset and Continue	Rising Edge
12	Stop, Capture, Reset and Continue (Inv)	Falling Edge
13	Capture-Reset Rising Edge	Rising Edge
14	Capture-Reset Falling Edge	Falling Edge
15	Enable Reset	Rising Edge
16	Disable Reset	Rising Edge

You can (DM-) configure a Digital Input to generate interrupts by setting the corresponding bit in the Interrupt Enable Data of the Digital Inputs. The Interrupt Enable Data of the Digital Inputs consists of 2 bits representing the 2 Digital Inputs. By default the Inputs are disabled to generate interrupts.

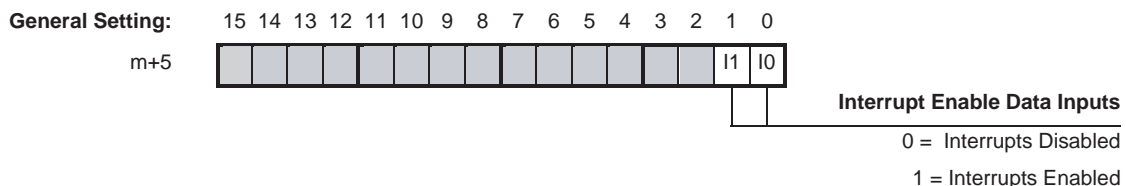

Bits 0 and 1 correspond with the Physical Digital Inputs I0 and I1.

External Interrupt Task Offset

Every Digital Input that is enabled to generate interrupts is assigned to an external interrupt task in the CJ-series CPU Unit. In the External Interrupt Task you should write an appropriate (ladder) program that takes the required action on the occurrence of an interrupt.

All 2 Digital Inputs are assigned in sequential order to consecutive External Interrupt Tasks starting from Digital Input 0. By defining an Offset you determine the External Interrupt Task number of the (first) External Interrupt Task that is assigned to Digital Input 0. The remaining Digital Input is assigned to the respective external interrupt task numbers in increasing order starting from "Offset + 1".

Input	External Interrupt Task Number
0 (=I0)	Offset
1 (=I1)	Offset + 1

For example, an Offset of 30 means that Digital Input 0 is assigned to External Interrupt Task Number 30 and Digital Input 1 to External Interrupt Task Number 31.

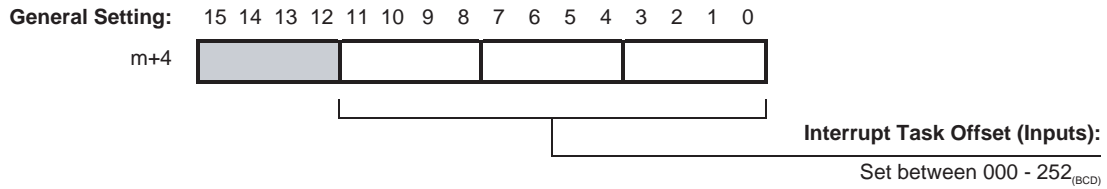

Since there are 256 External Interrupt Tasks available (numbered 0 to 255), the Offset can be maximum 252.

- Note**
- Multiple interrupts generated at the same time will be queued in FIFO-order inside the High-speed Counter Unit. If the FIFO-buffer is full the Unit will generate an error (refer to 5-2-5 "Interrupt FIFO full error" for more information).
 - If the ranges of external interrupt task numbers that are assigned to the Outputs and the Digital Inputs overlap, the Unit does not generate an error.

SECTION 5

Error Processing, Maintenance and Inspection

This section provides details of the CJ1W-CT021 High-speed Counter Unit's error indicators and error codes and guidelines for maintenance and inspection of the Unit.

5-1	Error Indicators	134
5-1-1	Errors during initial processing	134
5-1-2	Errors during normal operation	135
5-2	Error codes	136
5-2-1	DM-configuration errors	137
5-2-2	IOWR/IORD-instruction errors	138
5-2-3	Overflow/Underflow errors	139
5-2-4	Preset error	140
5-2-5	Interrupt FIFO full error	140
5-2-6	System Errors	141
5-3	Maintenance and Inspection	142
5-3-1	Cleaning	142
5-3-2	Routine Inspections	142

5-1 Error Indicators

CT021						
RUN	ERC	ERH				
CH1	A	B	Z	I0	O0	
CH2	A	B	Z	I1	O1	

The RUN-, ERC-, and ERH-LEDs, at the front panel of the High-speed Counter Unit, display the following errors.

5-1-1 Errors during initial processing

RUN	ERC	ERH	Error	Probable cause	Remedy
OFF	OFF	ON	Setup error	Incorrect Unit number Cyclic initial error	Set correct Unit number and turn ON the power again
OFF	ON	OFF	DM-configuration error	Invalid DM-setting(s)	Check the Error Code(s) in CIO (words n+17, n+18), correct the invalid DM-setting(s) and turn ON the power again. Refer to 5-2 "Error codes" for more information on error codes and how to clear them.
			Unit error	An error occurred in the Unit's EEPROM, RAM or CPU or a system software error occurred	Turn OFF and then ON the power again. If errors reoccurs, then replace the High-speed Counter Unit
OFF	ON	ON	Unit classification error	The Unit classification was set incorrectly	Replace the High-speed Counter Unit
OFF	OFF	OFF	Watch Dog Timer time-out error	The Unit's Watch Dog Timer has timed out	Turn OFF and then ON the power again. If errors reoccurs, then replace the High-speed Counter Unit

5-1-2 Errors during normal operation

RUN	ERC	ERH	Error	Probable cause	Remedy
ON	ON	OFF	Unit error	Invalid operands specified in IOWR-instruction Overflow or underflow of Simple or Linear Counter Preset error Unit interrupt FIFO is full	Check the Error Code(s) in CIO (words n+17, n+18). Apply appropriate remedy according to the cause of the error. Refer to 5-2 "Error codes" for more information on error codes and how to clear them.
ON	OFF	ON	System error	PLC Watch Dog Timer error Fatal error Non-fatal error Cyclic Monitor error I/O Bus error	If cyclic refreshing is disabled, program the PLC so that a refresh using the IORF-instruction is executed every 11 or fewer seconds or remove the cause of the fatal or non-fatal error. If the error reoccurs, then replace the CJ-series CPU Unit. Refer to 5-2-6 "System Errors" for more information.

5-2 Error codes

Reporting errors

The errors that can occur at the Unit are divided in 6 categories: DM-configuration errors, IOWR-instruction errors, overflow/underflow errors, Preset error, Interrupt-FIFO full error and System errors. Every error is assigned a unique error code. The *error code* consists of two words (error code 1 and error code 2). At the occurrence of an error:

- the corresponding *error code* is transferred to words n+17 (=error code 1) and n+18 (=error code 2) of the Special I/O Unit Area in CIO-memory
- the corresponding *error code* is stored inside the High-speed Counter Unit
- the Global Error bit in CIO is set (n+19 / bit 00)
- the ERC-LED is turned ON

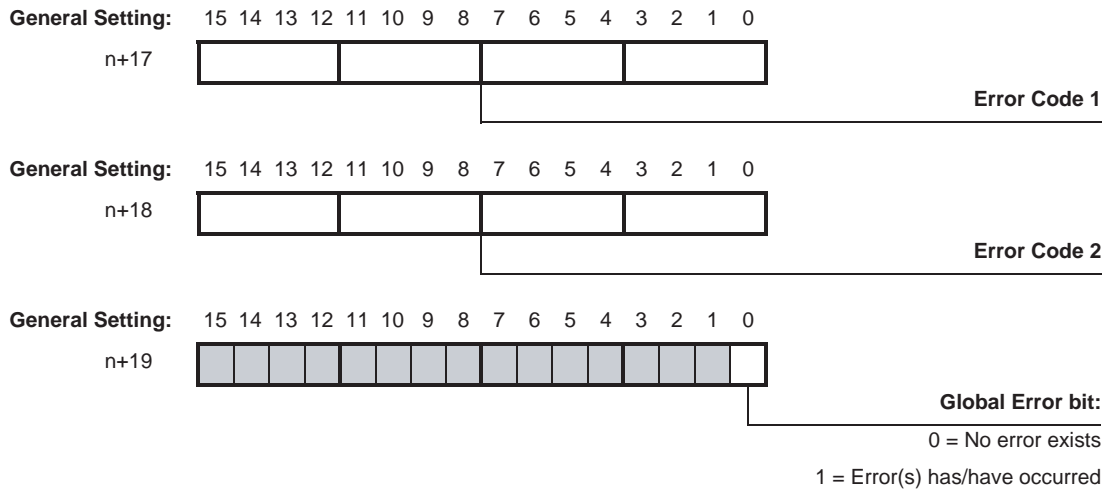

After you have cleared the error:

- words n+17 (=error code 1) and n+18 (=error code 2) are reset
- the Global Error bit in CIO is reset (n+19 / bit 00)
- the ERC-LED is turned OFF

Every error category requires its own unique action to clear them (refer to the next sections for information on clearing errors of different categories).

Error History Log File

Up to a maximum of 30 errors can be logged in chronological order inside the High-speed Counter Unit, constituting the Error History Log File. If multiple errors are active at the same time every error (-code) can be read sequentially into CIO (n+17, n+18) by using the Read Next Error bit. Every next error is read from the Error History Log File at the rising edge of the Read Next Error bit. If you attempt to read an error after the last error in the list has been read, the value of zero will be returned. Now you can scroll through the same error list again from the next rising edge of the Read Next Error bit.

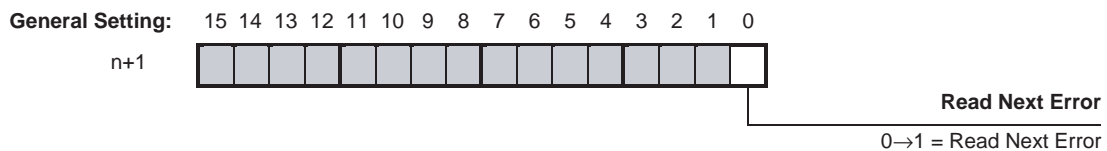

5-2-1 DM-configuration errors

DM-configuration errors are detected during initialisation after the Unit has been powered up or restarted. DM-configuration errors can also be detected after the IOWR-instruction "(Re) Configure Unit" has been issued (refer to 4-5-3-4 "(Re) Configure Unit"). In case a DM-configuration error is detected the Unit will report the error and stop operating. The error(s) can be read in CIO using the "Read Next Error" bit.

Error Code 1	Error Code 2		Error	Description
0300	Offset (BCD)		Out of Range	The DM-setting located at $D20000 + (Nx100) + \text{Offset}$ is Out of Range (N = Machine Number).
0310	Offset (BCD)		Invalid BCD-code	The DM-setting located at $D20000 + (Nx100) + \text{Offset}$ is an invalid BCD-code (N = Machine Number). (The range of a valid BCD-code for a digit is 0-9. If one or more digits is within range A-F an invalid BCD-code is specified).
0311	Offset (BCD)		Invalid Initial Counter Value	The Initial Counter Value located at $D20000 + (Nx100) + \text{Offset}$ is outside the counting range that is set for that Counter (N = Machine Number).
0320	Offset (BCD)		Invalid Rate Range Limits	Upper Rate Range Limit \leq Lower Rate Range Limit of the Rate Range located at $D20000 + (Nx100) + \text{Offset}$ (N = Machine Number).
0320	Counter No.	Range No. (BCD)	Invalid Range Limits	Upper Range Limit < Lower Range Limit. <u>Counter No.</u> indicates the Linear Counter number and <u>Range No.</u> indicates the Range number.
0330	Counter No.	Range No. (BCD) / CV No. (BCD)	Invalid Range Limit(s) / Comparison Value	If the Unit is in Range Mode: Lower and/or Upper Range Limit is/are outside Counting Range. <u>Counter No.</u> indicates the Counter number and <u>Range No.</u> indicates the Range number. If the Unit is in Comparison Mode: Comparison value is outside Counting Range. <u>Counter No.</u> indicates the Counter number and <u>CV No.</u> indicates the Comparison Value number. (The counting range of Circular and Linear Counters can be specified, refer to 3-2-2 "Circular Counter" and 3-2-3 "Linear Counter" for more information).
0331	Counter No.	CV No. (BCD)	Comparison Values are equal	For the Counter, with the <u>Counter Number</u> as reported in Error Code 2, one or more Comparison Values are equal. <u>CV No.</u> indicates the Comparison Value number.
0335	Offset (BCD)		Rate Ranges overlap	The Rate Ranges located at $D20000 + (Nx100) + \text{Offset}$ overlap (N=Machine Number)

Clearing DM-configuration errors

DM-configuration errors can be cleared by correcting the faulty settings in Data Memory and consecutively transferring the new configuration data again to the Unit. To transfer the configuration data you can choose from one out of two possibilities:

- Turn the power of the CJ-series PLC system ON.
- Restart the High-speed Counter Unit (refer to 4-1-2 "Special I/O Units Restart bits").

5-2-2 IOWR/IORD-instruction errors

IOWR/IORD-instruction errors are detected by the Unit after they have been issued from the ladder program to the High-speed Counter Unit. IOWR-instructions are used to change Counter settings of the Unit. In case you specify faulty operands in the IOWR-instruction the Unit reports this as an error. IORD-instructions only generate an error in case an invalid Control Code or an invalid number of words is specified.

Error Code 1	Error Code 2		Error	Description
0350	Invalid Control Code		Invalid Control Code	The Control Code that is specified in the IOWR/IORD-instruction is not supported by the High-speed Counter Unit. The <u>Invalid Control Code</u> is reported in Error Code 2.
0360	Control Code		Invalid number of words	The number of words that is specified in the IOWR/IORD-instruction is faulty. The <u>Control Code</u> of the instruction for which the invalid number of words is specified is reported in Error Code 2.
0400	Counter No.	000	Z-Reset Mode Out of Range	Two problems can cause this error. The Z-Reset Mode that you specified is not in the valid range (0-1). It is also possible that you issued an IOWR-instruction to change the Maximum or Minimum Count Value of a Circular or Linear Counter, causing one or more of the already defined Range Limits or Comparison Values to be outside the new Counting Range. <u>Counter No.</u> indicates the number of the Counter.
0412	Counter No.	000	Invalid Counting Range	The Lower Count Limit of the Linear Counter is not a negative value and/or the Upper Count Limit is not a positive value.
0413	Counter No.	000	Invalid Current Counter Value	The Counter Value issued with the IOWR-instruction is outside the counting range of the Counter. <u>Counter No.</u> indicates the number of the Counter.
0420	Counter No.	000	Invalid Rate Range Limits	Upper Rate Range Limit \leq Lower Rate Range Limit. <u>Counter No.</u> indicates the Counter number.

Error Code 1	Error Code 2		Error	Description
0420	Counter No.	Range No.	Invalid Range Limits	Upper Range Limit < Lower Range Limit. <u>Counter No.</u> indicates the Linear Counter number and <u>Range No.</u> indicates the Range number.
0430	Counter No.	Range No. (BCD) / CV No. (BCD)	Invalid Range Limit(s) / Comparison Value	If the Unit is in Range Mode: Lower and/or Upper Range Limit is/are outside Counting Range. <u>Counter No.</u> indicates the Counter number and <u>Range No.</u> indicates the Range number. If the Unit is in Comparison Mode: Comparison value is outside Counting Range. <u>Counter No.</u> indicates the Counter number and <u>CV No.</u> indicates the Comparison Value number. (The counting range of Circular and Linear Counters can be specified, refer to 3-2-2 "Circular Counter" and 3-2-3 "Linear Counter" for more information).
0431	Counter No.	CV No. (BCD)	Comparison Values are equal	For the Counter with the <u>Counter Number</u> as reported in Error Code 2 one or more Comparison Values are equal. <u>CV No.</u> indicates the Comparison Value number.
0435	Counter No.	000	Rate Ranges overlap	For the Counter with the <u>Counter Number</u> as reported in Error Code 2 the Rate Ranges 0 and 1 overlap each other.

Clearing IOWR-instruction errors

IOWR-instruction errors can be cleared by issuing the IOWR-instruction with the Error Clear ("EC") command (refer to 4-5-3-5 "Error Clear Command" for more information).

5-2-3 Overflow/Underflow errors

Over- and underflow errors are reported only for Linear Counters assuming that they have been configured to generate error codes (refer to 3-2-3 "Linear Counter").

Error Code 1	Error Code 2	Error	Description
0450	Counter No.	Overflow	The Linear Counter with the <u>Counter No.</u> as reported in Error Code 2 generated overflow.
0460	Counter No.	Underflow	The Linear Counter with the <u>Counter No.</u> as reported in Error Code 2 generated underflow.

Clearing overflow/underflow errors

Overflow- and underflow errors can be cleared by resetting or presetting the Counter that generated over- or underflow. To reset a Counter refer to 3-6 "Reset Signals". To preset a Counter refer 3-4 "Digital Input Functions".

Note At overflow- and underflow errors it is possible to configure Output State Control (refer to 3-5-4 "Output Control Configuration").

5-2-4 Preset error

A Preset error is generated if a Circular or Linear Counter is preset with an invalid Preset Value (refer to 3-4 "Digital Input Functions" for more information about pre-setting). The Preset Value is invalid if it is outside the counting range of the Circular or Linear Counter.

Error Code 1	Error Code 2	Error	Description
0470	Counter No.	Invalid Preset Value	The Linear Counter with the <i>Counter No.</i> as reported in Error Code 2 is preset with an invalid Preset Value.

Clearing Preset error

A Preset error can be cleared by resetting or by presetting the Counter that generated a Preset error, with a valid Preset Value. To reset a Counter refer to 3-6 "Reset Signals". To preset a Counter refer to 3-4 "Digital Input Functions".

5-2-5 Interrupt FIFO full error

Every interrupt that you want to use is assigned to an external interrupt task number (0-255). This number corresponds with the external interrupt task in the CJ-series CPU Unit that is to be executed when the assigned interrupt is activated (refer to 4-6 "Interrupts").

Multiple interrupts, generated by the Digital Inputs and/or the Outputs, will be queued in FIFO-order inside the High-speed Counter Unit, for as long as the current active interrupt is not executed. The FIFO-buffer stores up to 30 interrupt requests. If the FIFO-buffer is full the Unit will report an error to the CJ-series CPU Unit. All interrupts generated by the Unit, after the "Interrupt FIFO full" error has occurred will be ignored and will not generate additional errors. Error Code 2 contains the external interrupt task number of the corresponding interrupt that was excluded from the full FIFO-queue.

Error Code 1	Error Code 2	Error	Description
0480	External Interrupt Task No. (BCD)	Interrupt-FIFO full	The interrupt-FIFO inside the High-speed Counter Unit is full and the interrupt assigned to <i>External Interrupt Task</i> could not be executed.

Clearing Interrupt FIFO error

If the speed with which the High-speed Counter Unit generates interrupts is higher than the speed with which the CJ-series CPU Unit executes the interrupts, the FIFO-buffer inside the Unit runs full and the "Interrupt FIFO full" error is generated. If this error occurs, it will no longer be possible to execute external interrupt tasks. Either cycle the power supply to the Programmable Controller or restart the Unit. To prevent this error from occurring, you must correct the execution conditions for interrupt tasks in your system.

The error indicates that the load of interrupts on the CJ-series CPU Unit is too high. Clearing the error as mentioned before most probably needs additional measures to be taken in order to prevent this error from happening in the future:

- Mask one or more interrupts of the Unit, which caused the error.
- Mask one or more interrupts of other Units in the system, which are generating interrupts as well.
- Reduce the execution time of the assigned External Interrupt Tasks.

External interrupt requests from the High-speed Counter Unit will not reach the CPU Unit if the CPU Unit is not a CJ1-H or CJ1M CPU Unit (CJ1 CPU Units do not support external interrupts), or the Unit is mounted at an incorrect position.

Be sure the High-speed Counter Unit is installed in the correct position. It must be installed in one of the five positions immediately to the right of the CPU Unit (when facing the PLC) if a CJ1-H CPU Unit is used, or in one of the three positions immediately to the right of the CPU Unit if a CJ1M CPU Unit is used.

5-2-6 System Errors

When errors occur in the CJ-series CPU Unit or on the I/O Bus the ERH-LED is turned ON. At the occurrence of an I/O Bus error an error code (see n+17, n+18) is generated as well.

Error Code 1	Error Code 2	Error	Description
000E	0000	I/O Bus error	An error has occurred on the I/O Bus causing the High-speed Counter Unit to be in an undefined state. On occurrence of an I/O Bus error you can configure the Outputs to keep their last state or to have a predefined state (refer to 3-5-4 "Output Control Configuration").
0002	Time-Out in milliseconds	Time-Out error	A cyclic refresh time-out error was generated caused by a PLC system error or you have chosen to disable the Cyclic Refresh of the High-speed Counter Unit in the CJ-series PLC settings. This error will be cleared as soon as Cyclic Refresh will take place again. The IORF ladder instruction has no influence on this behaviour.

Clearing System errors

Turn ON the power supply again or restart the system. If the error persists, then replace the CJ-series CPU Unit.

5-3 Maintenance and Inspection

This section describes the routine cleaning and inspection recommended as regular maintenance.

5-3-1 Cleaning

Clean the High-speed Counter Unit regularly as described below in order to keep it in its optimal operating condition.

- Wipe the Unit with a dry, soft cloth for regular cleaning.
- When a spot cannot be removed with a dry cloth, dampen the cloth with a neutral cleanser, wring out the cloth, and wipe the Unit.
- A smudge may retain on the Unit from gum, vinyl, or tape that was left on for a long time. Remove the smudge when cleaning.

 **Caution** Never use volatile solvents such as paint thinner or benzene or chemical wipes. These substances could damage the surface of the Unit.

5-3-2 Routine Inspections

In order for your High-speed Counter Unit to continue operating at optimum condition, periodic inspections are necessary. Be sure to inspect the system periodically to keep it in its optimal operating condition. In general, inspect the system once every 6 to 12 months, but inspect more frequently if the system is used with high temperature or humidity or under dirty / dusty conditions.

Inspection Equipment

Prepare the following equipment before inspecting the system.

Required Equipment:

Have a standard and Phillips-head screwdriver, multimeter, alcohol, and a clean cloth.

Equipment that could be needed:

Depending on the system conditions, a synchroscope, oscilloscope, thermometer, gas sensor or hygrometer (to measure humidity) might be needed.

Inspection Procedure

Check the items in the following table and correct any items that are not according to the criteria.

Item		Criteria	Equipment
Environmental conditions	Ambient temperature	0°C to 55°C	Thermometer
	Ambient humidity	10% to 90%	Hygrometer
	Dust/dirt accumulation	None	---
	Is the Unit exposed to any spray of water, oil, or chemicals?	None	---
	Is the Unit exposed to corrosive or flammable gases?	None	Gas sensor
	Is the Unit exposed to shock or vibration?	None	
Installation	Is the Unit installed securely?	No looseness	---
	Are the external connectors securely mounted?	No looseness	---
	Is all external wiring securely connected?	No looseness	---
	Are the external connectors fully inserted?	No looseness	---
	Are the connecting cables undamaged?	No damage	---

SECTION 6

Application Examples

This section gives information about the configuration of the CJ1W-CT021 High-speed Counter Unit and program samples, which can be used to operate the Unit according to five common application examples. At the beginning of each section that describes an application example, all configuration items that are covered in that section are mentioned.

6-1	Flow Control	146
6-2	Length Measurement	149
6-3	Positioning	154
6-4	CAM-positioning	159
6-5	Speed Control	164

6-1 Flow Control

Covered configuration items in this example:

- Simple Counter (for a Simple Counter *no* DM-configurations have to be made).

Application Description

In the following example a tank has to be filled with a fixed amount of liquid. Pressing the push button resets the Simple Counter, opens the Gate of the Simple Counter and opens the valve. The liquid passes through the flow meter into the tank. The pulse output of the flow meter measures the liquid flow that is proportional to the number of pulses generated (5,000 pulses is equivalent to 1 litre). After the tank has been filled with exactly 100 litres of liquid the valve and the Gate of the Simple Counter are closed automatically.

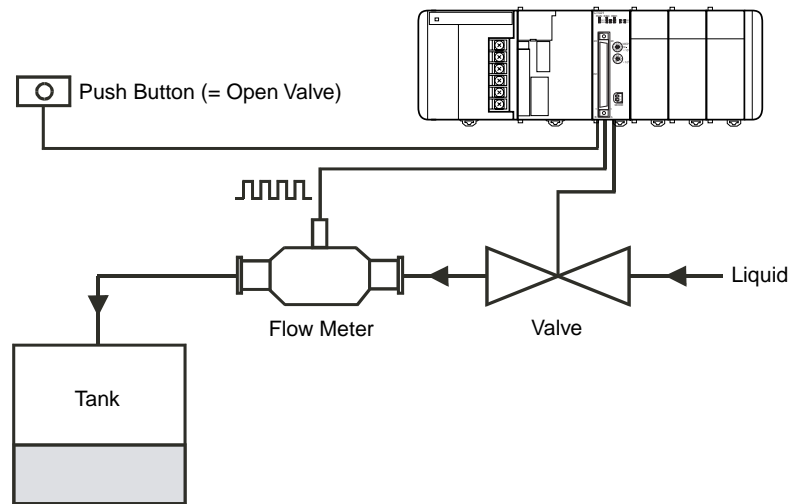

The push button is connected to Digital Input I0 and the valve is connected to Digital Output O0 of the High-speed Counter Unit. The pulses of the flow meter are counted by Counter 1 which is configured as Simple Counter (corresponding DIP switch at the front of the Unit is in the OFF-position).

The Machine Number of the High-speed Counter Unit is 0. The High-speed Counter is allocated 40 CIO-words starting from CIO 2000 ($n = \text{CIO } 2000 + 0 \times 10$).

A short ladder program for the PLC must be written to control this application. The ladder program interfaces with the High-speed Counter Unit via the Special I/O Unit Area in CIO.

Relevant CIO-words

The following CIO-words are relevant to control the application and must be used in the ladder program.

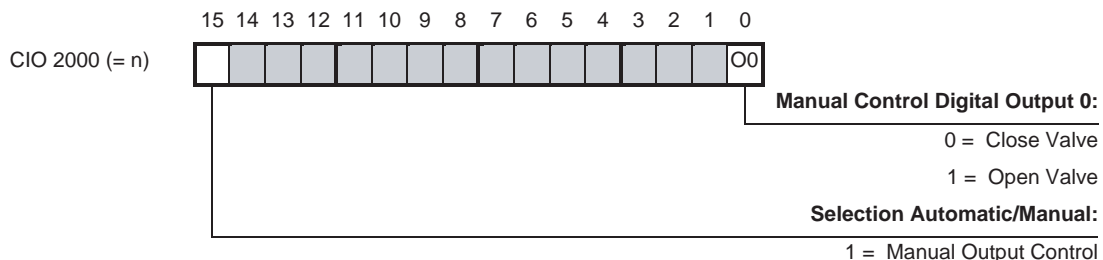

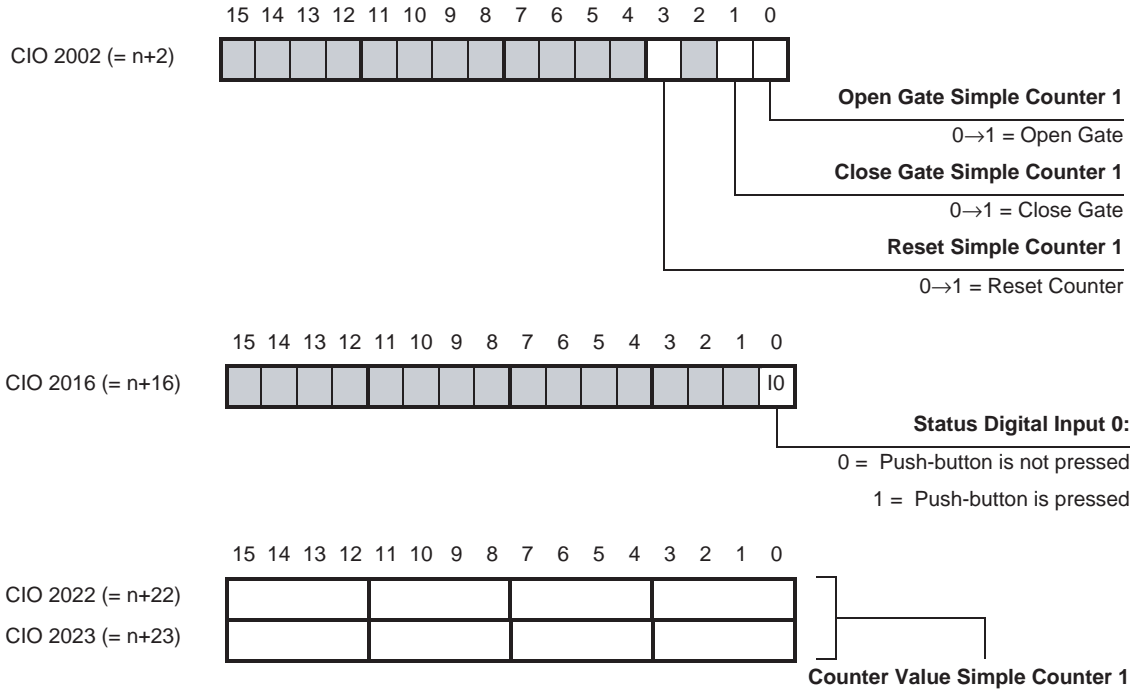

Ladder Program

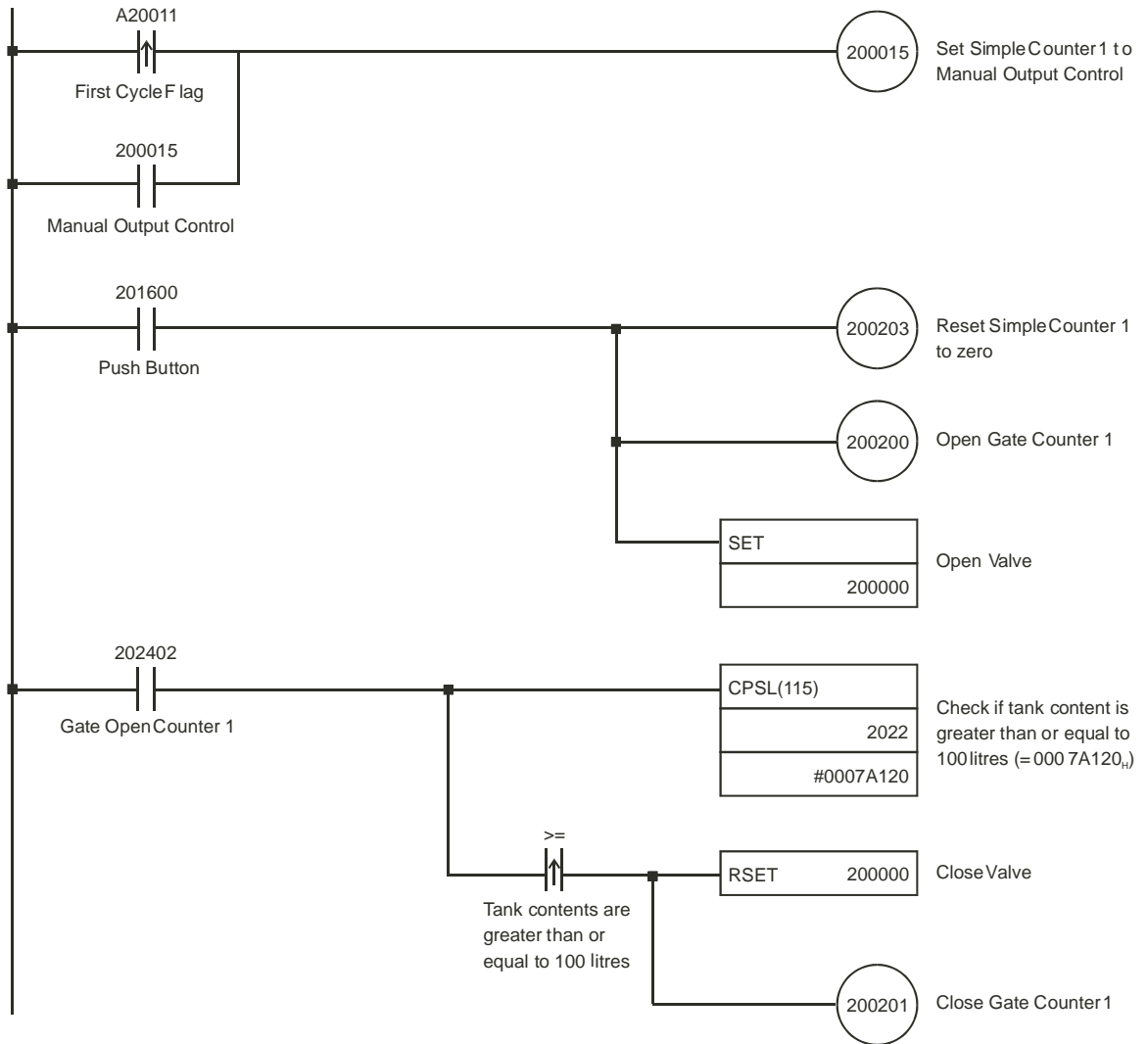

6-2 Length Measurement

Covered configuration items in this example:

- Circular Counter
- Range Mode, setting Range Data
- Programmable Output Pulses (Output Pulse Duration)
- Digital Input Function (Functions 5 and 11)
- Capturing and reading Captured Values
- Logically AND-ing Output Patterns

Application Description

In this example the length of objects is measured. Improper sized objects are removed from the line by activating the pusher for one second. The measured length of improper sized objects is stored in EM of the PLC as a 32-bits Counter Value. The High-speed Counter Unit is DM-configured and works stand-alone except for storing the size of improper sized objects in EM; a short ladder program is written to read and store the length of improper sized objects into the CJ-series CPU Unit. The Unit is in Range Mode.

Two incremental encoders are used. Encoder 1 is connected to Counter 1 and encoder 2 is connected to Counter 2. By using two encoders the system also takes into account alterations in the speed of conveyor belt 1 and 2.

Encoder 1 is connected to the shaft of motor 1. The length of an object on conveyor belt 1 is proportional to the number of pulses that encoder 1 generates. As an object passes photo-electric sensor D1, Counter 1 starts counting pulses. If the number of pulses counted is within one of the predefined invalid ranges (i.e. the length of the object is too small or too big), the object has to be removed from the line by the pusher.

In order to activate the pusher at the right moment (i.e. the object with incorrect length is in front of the pusher) encoder 2 and photo-electric sensor D2 are used. When the end of the object leaves the beam of photo-electric sensor D2, Counter 2 is reset and continues counting. The pusher will be activated for one second as soon as the object is in the predefined range of Counter 2.

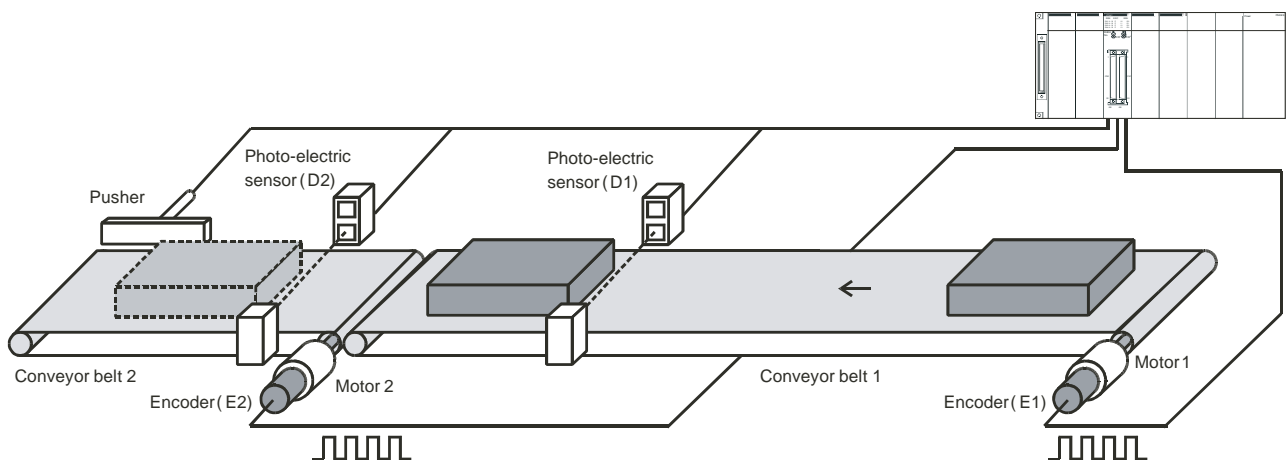

To measure the length of objects the pulses of encoder E1 are counted by Linear/Circular Counter 1 (corresponding DIP switch on the front of the Unit is in the ON-position). Photo-electric sensor D1 is connected to Digital Input I0. Digital Input I0 controls Counter 1 and is assigned Digital Input Function 11 (Reset, Stop, Capture and Continue).

Digital Input Function 11

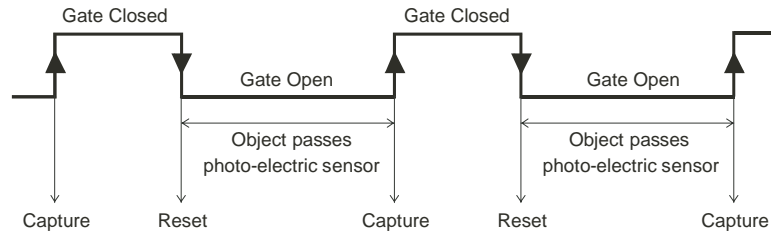

At the falling edge of Digital Input I0, when an object enters the beam of the photo-electric sensor, the Counter Value is reset, the gate is opened and Counter 1 starts counting pulses from zero. At the rising edge of Digital Input I0, when the object leaves the beam of the photo-electric sensor, the Counter Value of Counter 1 is captured and the gate is closed.

Reading Captured Value

By issuing an IORD-instruction from the PLC ladder program the captured Counter Value is read. The length of improper sized objects is stored in Extended Memory of the PLC (refer to the ladder program example on the next pages).

Measuring length

The length is measured by Counter 1 and should be ideally 5000. The valid range for the length of an object is 4900 – 5100. If the length of an object is in Range 0 (4000 – 4900) or Range 1 (5100 – 6000) the object is improperly sized and must be removed. Digital Output O0, in the Output Pattern of Counter 1, is turned ON when the Counter Value is within Range 0 or 1.

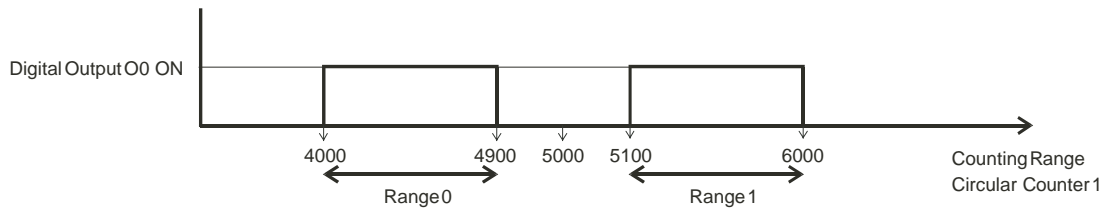

Removing objects

Timing the correct moment to remove an object for the pusher is done by the combination of encoder 2 and photo-electric sensor D2. Objects are removed by the pusher which is located at conveyor belt 2. Photo-electric sensor D2 is connected to Digital Input I1. Digital Input I1 controls Counter 2 and is assigned Digital Input Function 5 (Reset Rising Edge).

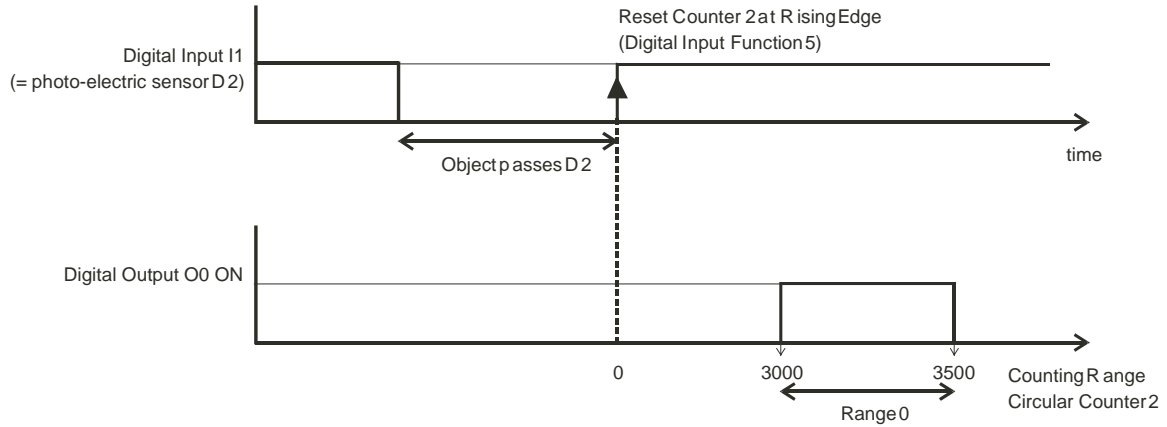

Digital Input I1

At the rising edge of Digital Input I1, when an object leaves the beam of the photo-electric sensor, Counter 2 is reset but continues counting. When the Counter Value enters Range 0 Digital Output O0 is turned ON.

Logically AND Output Patterns Counter 1 and 2

The pusher (i.e. Digital Output O0) is controlled by logically AND-ing the output patterns of Counter 1 and 2. This means that the pusher is activated when *both* output patterns of Counter 1 and 2 have turned ON bit 0 (= Digital Output O0).

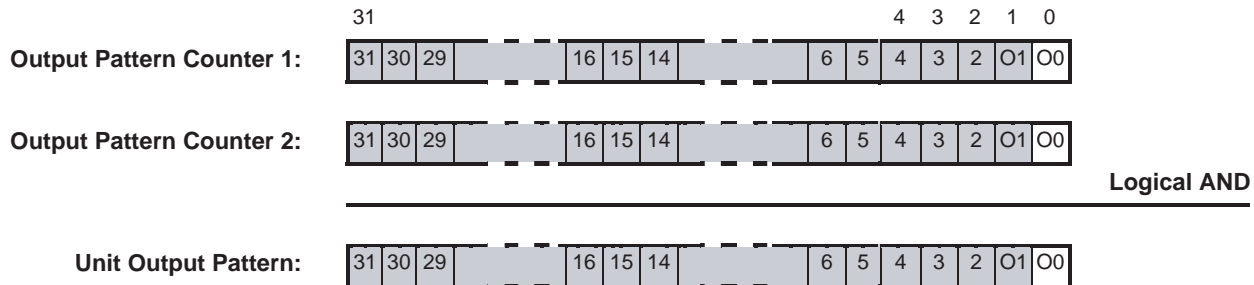

Consequently the pusher is activated for 1 second when Counter 1 has measured an invalid sized object AND when Counter 2 has determined that the object is in front of the pusher.

DM-configuration

The Machine Number of the High-speed Counter Unit is 0. The High-speed Counter is allocated 40 CIO-words starting from CIO 2000 ($n = \text{CIO } 2000 + 0 \times 10$) and 400 DM-words starting from D 20000 ($m = \text{D } 20000 + 0 \times 100$). The Range Data of Counter 1 is stored in DM starting from D500 and the Range Data of Counter 2

is also stored in DM starting from D600. To configure the Unit the following DM-settings must be made

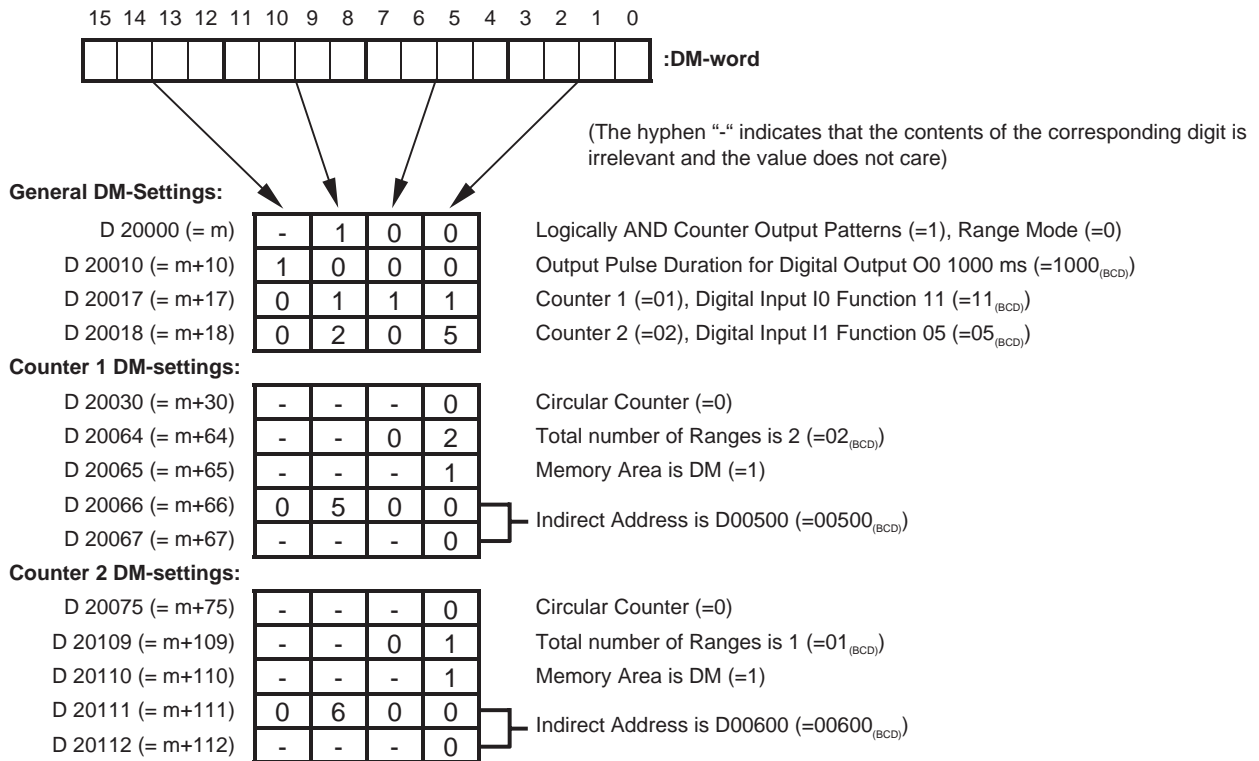

Range Data Counters 1 and 2

Range 0 settings of Counter 1 (in DM):

D 00500	0	F	A	0	Lower Range Limit is 4000 (=00000FA0 _H)
D 00501	0	0	0	0	
D 00502	1	3	2	4	Upper Range Limit is 4900 (=00001324 _H)
D 00503	0	0	0	0	
D 00504	0	0	0	1	Output Pattern: Digital Output O0 is ON (=00000001 _H)
D 00505	0	0	0	0	

Range 1 settings of Counter 1 (in DM):

D 00506	1	3	E	C	Lower Range Limit is 5100 (=000013EC _H)
D 00507	0	0	0	0	
D 00508	1	7	7	0	Upper Range Limit is 6000 (=00001770 _H)
D 00509	0	0	0	0	
D 00510	0	0	0	1	Output Pattern: Digital Output O0 is ON (=00000001 _H)
D 00511	0	0	0	0	

Range 0 settings of Counter 2:

D 00600	0	B	B	8	Lower Range Limit is 3000 (=00000BB8 _H)
D 00601	0	0	0	0	
D 00602	0	D	A	C	Upper Range Limit is 3500 (=00000DAC _H)
D 00603	0	0	0	0	
D 00604	0	0	0	1	Output Pattern: Digital Output O0 is ON (=00000001 _H)
D 00605	0	0	0	0	

Transfer the DM-settings to the High-speed Counter Unit by restarting the Unit.

Ladder Program

A short ladder program for the PLC is written to read and store the measured length of improperly sized objects in EM starting from EM100 of the CJ-series CPU Unit.

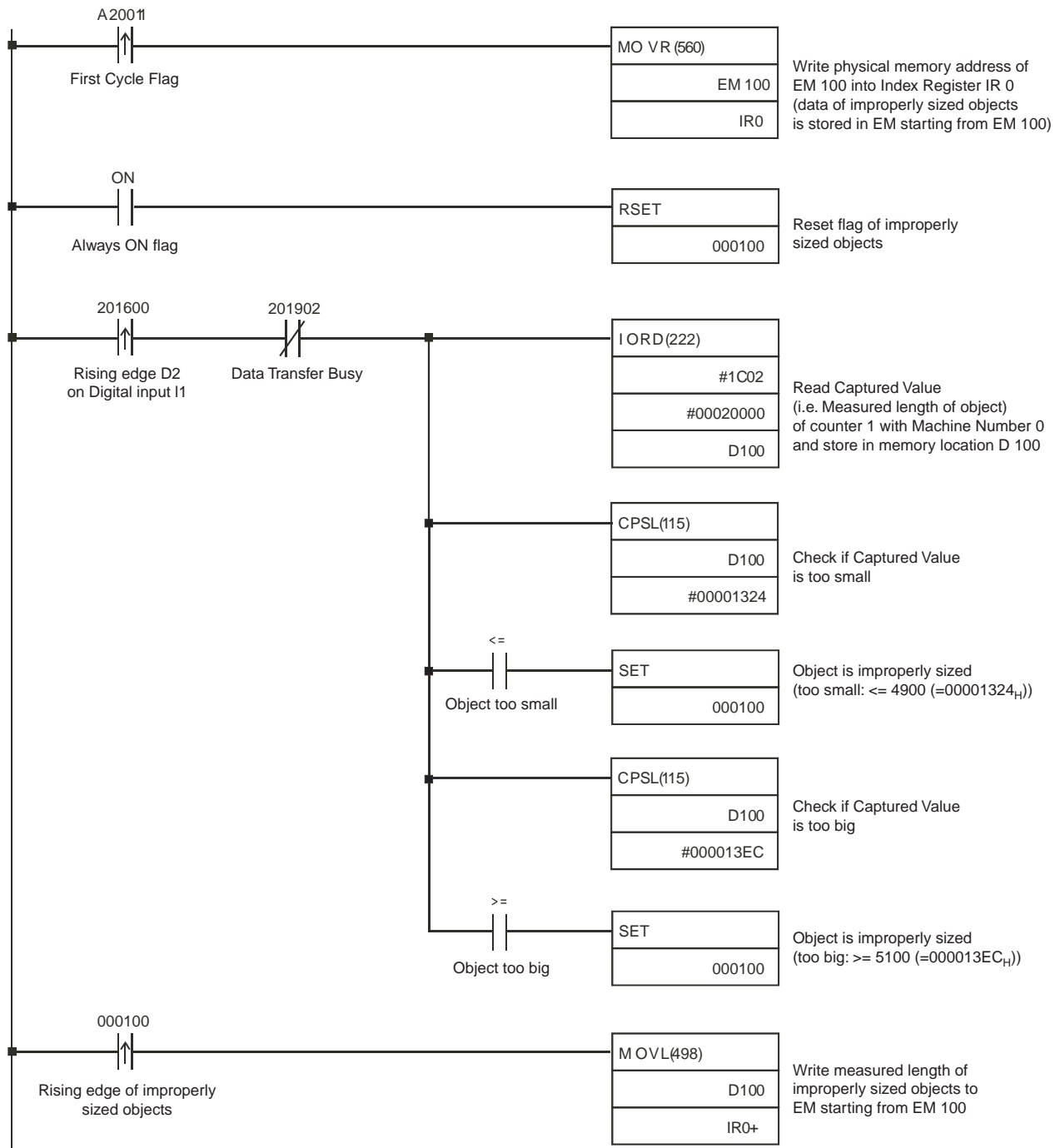

6-3 Positioning

Covered configuration items in this example:

- Linear Counter
- Comparison Mode, setting Comparison Data
- Digital Input Function (Function 05)
- Using IOWR-instruction to change Comparison Data

Application Description

In this example a hole is drilled into an object. The drill bit is spun by a single speed, single direction motor (motor 2) which can only be turned ON or OFF. The feed motor has two speeds (fast/slow) and can travel in two directions (forward/reverse). The High-speed Counter Unit controls the speed and direction of the feed-motor and turns ON/OFF the drill-motor. Turning ON and OFF the feed-motor is done by the PLC ladder program via a Digital Input- and Output Unit (e.g. CJ1W-ID231/OD231). A proximity switch is also connected to the Digital Input- and Output Unit and reports to the CPU via the ladder program that an object is ready to be treated. Consequently via the ladder program the feed-motor is turned ON.

An incremental encoder is connected to the shaft of the feed-motor. The encoder is connected to Linear Counter 1. The Unit is in Comparison Mode and four Comparison Values are defined to control the speed and direction of the feed-motor and to turn ON and OFF the drill-motor. The limit switch is used to reference the home position of the drill-motor by resetting the Counter Value to zero.

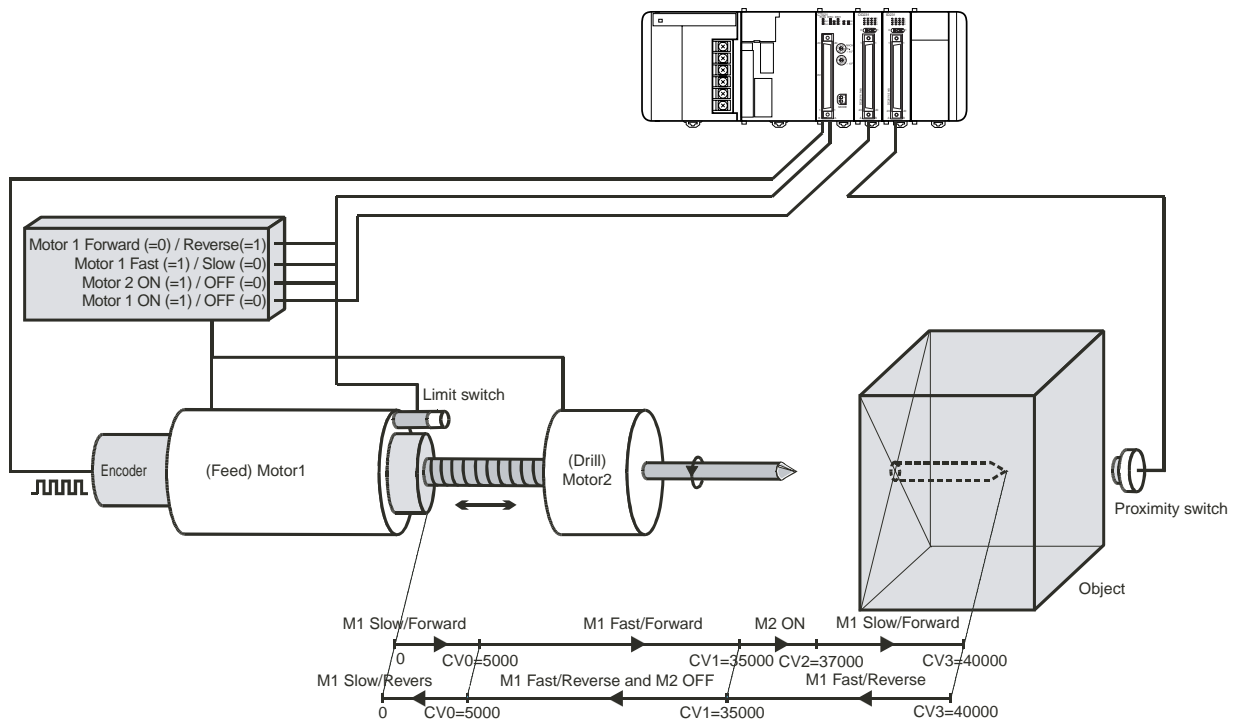

After an object has been detected the feed-motor (M1) is turned ON (slow/forward). When CV0 is passed M1 is switched to move fast. Reaching CV1 causes the drill-motor (M2) to turn ON. At CV2 the feed-motor is switched to move slow. Reaching CV3, when the hole has been completed causes the feed-motor to reverse direction and to move back with fast speed (Counter 1 now counts down). Other machinery (that is not visible) now automatically removes the object and the proximity switch becomes inactive. At CV1 the drill-motor turns OFF and at CV0

the feed-motor is switched to move slowly until it reaches the limit switch and is switched OFF (via the ladder program). At this moment a new object is placed in position again. At this moment the feed-motor stays switched OFF for as long as the proximity switch has detected a new object, initiating the whole cycle again.

The limit switch is connected to Digital Input I0 which is assigned function 05 (i.e. Reset Rising Edge). Activation of the limit switch when the drill-motor is in the home position causes Counter 1 to be reset and the feed-motor to be switched to its initial state (slow/forward). An Output Reset Pattern (m+61, m+62) has been defined to switch the feed-motor to its initial state.

DM-configuration

The Machine Number of the High-speed Counter Unit is 0. The High-speed Counter is allocated 40 CIO-words starting from CIO 2000 ($n = \text{CIO } 2000 + 0 \times 10$) and 400 DM-words starting from D 20000 ($m = \text{D } 20000 + 0 \times 100$). The Comparison Data of Counter 1 is stored in EM starting from EM 1500. To configure the Unit the following DM-settings must be made.

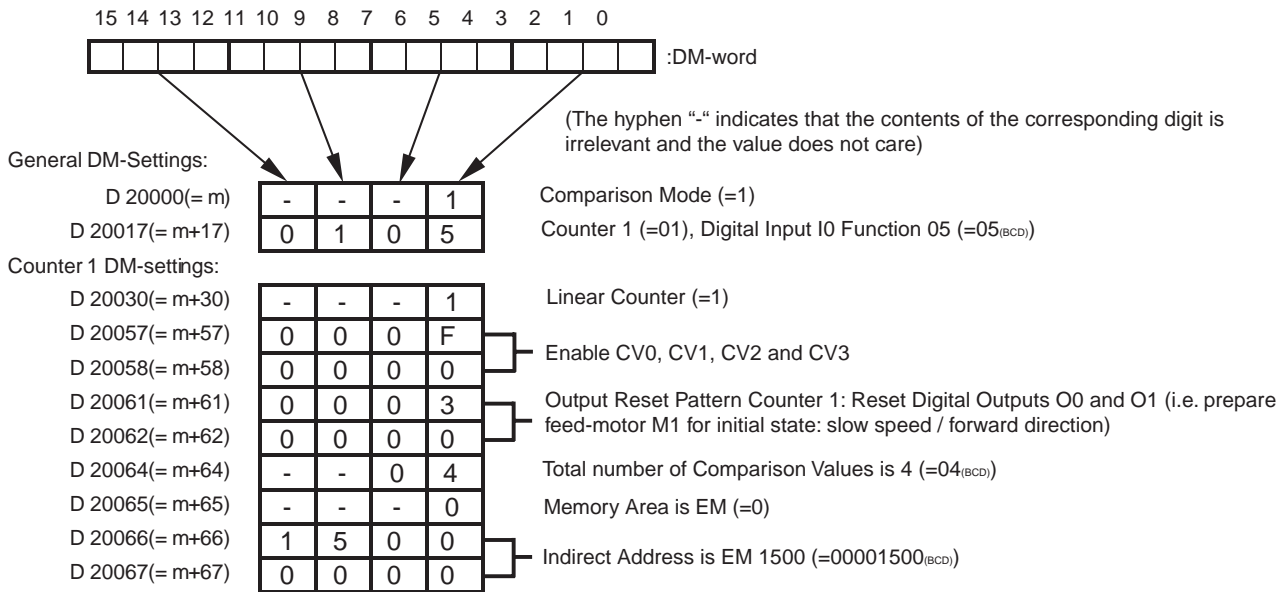

Comparison Data Counter 1

Comparison Data Counter 1

CV 0 settings of Counter 1 (in EM):

EM 01500	1	3	8	8	Comparison Value 0 is 5000 (=00001388 ₍₊₎)
EM 01501	0	0	0	0	
EM 01502	0	0	0	1	+Set Pattern: Set Digital Output O0 (i.e. change speed of feed-motor M1 from slow (=0) to fast (=1)) in the positive (=+) counting direction
EM 01503	0	0	0	0	
EM 01504	0	0	0	0	+Reset Pattern: no outputs are reset at the crossing of CV0 in the positive counting direction
EM 01505	0	0	0	0	
EM 01506	0	0	0	0	-Set Pattern: no outputs are set at the crossing of CV0 in the negative counting direction
EM 01507	0	0	0	0	
EM 01508	0	0	0	1	-Reset Pattern: Reset Digital Output O0 (i.e. change speed of feed-motor M1 from fast (=1) to slow (=0)) in the negative (=) counting direction
EM 01509	0	0	0	0	

CV 1 settings of Counter 1 (in EM):

EM 01510	8	8	B	8	Comparison Value 1 is 35000 (=000088B8 _H)
EM 01511	0	0	0	0	
EM 01512	0	0	0	4	+Set Pattern: Set Soft Output 2 (i.e. startdrill-motor) in the positive (=+) counting direction
EM 01513	0	0	0	0	
EM 01514	0	0	0	0	+Reset Pattern: no outputs are reset at the crossing of CV0 in the positive counting direction
EM 01515	0	0	0	0	
EM 01516	0	0	0	0	-Set Pattern: no outputs are set at the crossing of CV0 in the negative counting direction
EM 01517	0	0	0	0	
EM 01518	0	0	0	4	-Reset Pattern: Reset Soft Output 2 (i.e. stop drill-motor) in the negative (=−) counting direction
EM 01519	0	0	0	0	

CV 2 settings of Counter 1 (in EM):

EM 01520	9	0	8	8	Comparison Value 2 is 37000 (=00009088 _H)
EM 01521	0	0	0	0	
EM 01522	0	0	0	0	+Set Pattern: no outputs are set at the crossing of CV2 in the positive counting direction
EM 01523	0	0	0	0	
EM 01524	0	0	0	1	+Reset Pattern: Reset Digital Output O0 (i.e. change speed of feed-motor M1 from fast (=1) to slow (=0)) in the positive (=+) counting direction
EM 01525	0	0	0	0	
EM 01526	0	0	0	0	-Set Pattern: no outputs are set at the crossing of CV2 in the negative counting direction
EM 01527	0	0	0	0	
EM 01528	0	0	0	0	-Reset Pattern: no outputs are set at the crossing of CV2 in the negative counting direction
EM 01529	0	0	0	0	

CV 3 settings of Counter 1 (in EM):

EM 01530	9	C	4	0	Comparison Value 3 is 40000 (=00009C40 _H)
EM 01531	0	0	0	0	
EM 01532	0	0	0	3	+Set Pattern: Set Digital Outputs O0 and O1 (i.e. change speed/direction of feed-motor M1 from slow (=0)/forward (=0) to fast (=1)/reverse (=1)
EM 01533	0	0	0	0	
EM 01534	0	0	0	0	+Reset Pattern: no outputs are reset at the crossing of CV3 in the positive counting direction
EM 01535	0	0	0	0	
EM 01536	0	0	0	0	-Set Pattern: no outputs are set at the crossing of CV3 in the negative counting direction
EM 01537	0	0	0	0	
EM 01538	0	0	0	0	-Reset Pattern: no outputs are set at the crossing of CV3 in the negative counting direction
EM 01539	0	0	0	0	

Transfer the DM-settings to the High-speed Counter Unit by restarting the Unit.

Ladder Program

A short ladder program for the PLC is written to start and stop the feed-motor. The feed-motor is connected to the Digital Output Unit and mapped on CIO 000000. The proximity switch is mapped on CIO 000200.

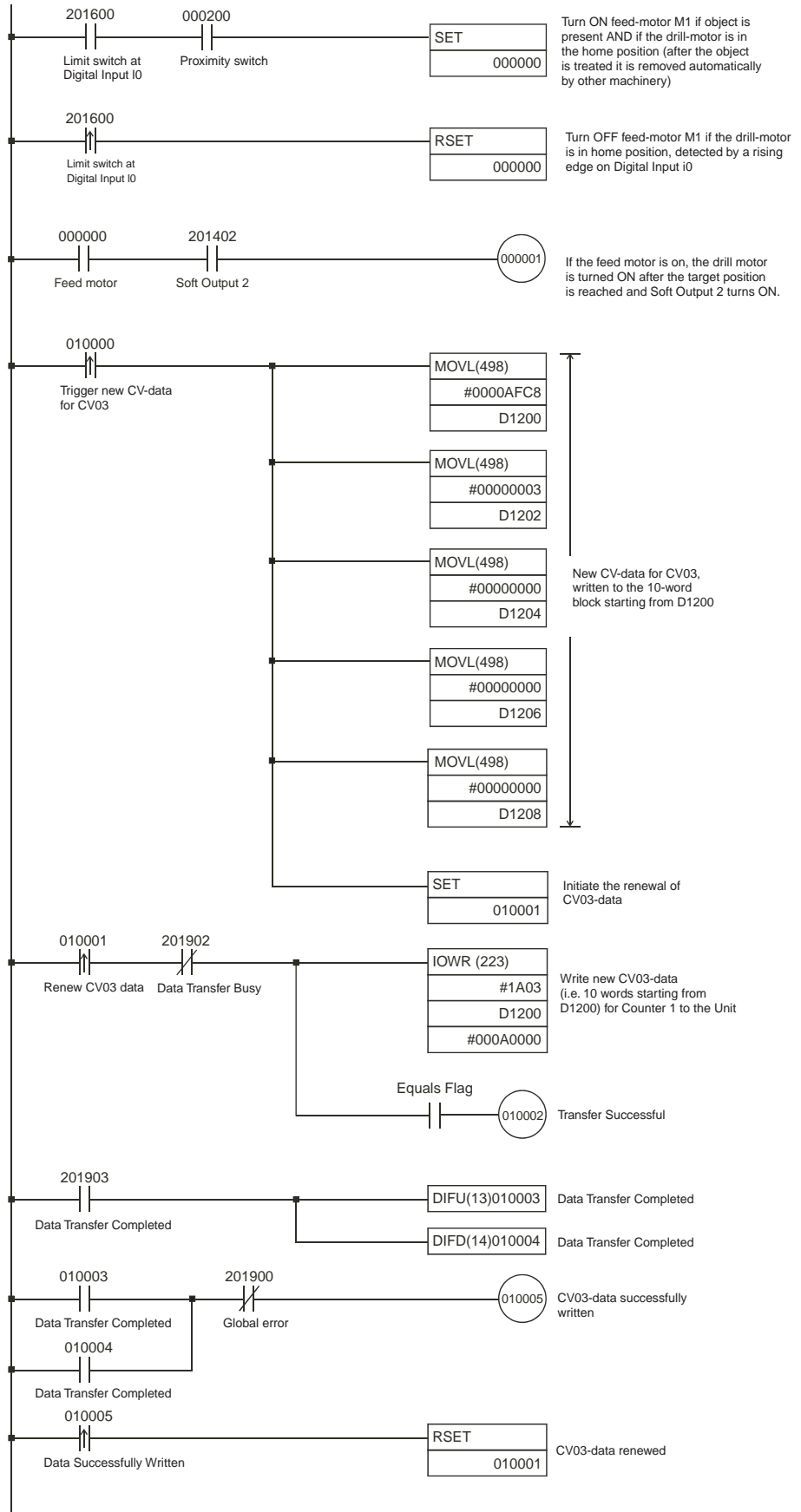

6-4 CAM-positioning

Covered configuration items in this example:

- Circular Counter
- Range Mode, setting Range Data
- Interrupts (Outputs generating interrupts)
- Hysteresis
- Input Signal Type, Phase Differential, multiplication x4
- Resetting a Counter with the Z-input combined with the Software Reset Enable bit

Application Description

In this example 15 outputs of a machine are controlled according to the position angle of the “electronic CAM-shaft” that is driven by a motor. The position angle is measured by counting the pulses of an incremental encoder that is connected to the CAM-shaft.

In order to increase the resolution of the encoder the Input Signal Type for Counter 1 is set to “multiplication x4”. The Z-phase of the encoder is used to reset the Counter together with the Software Reset Enable bit (make sure that CIO n+2, bit 05 is set).

The 15 outputs are controlled by the PLC ladder program via an additional Output Unit (e.g. CJ1W-OD231). In order to reduce the On/Off-response time for the outputs all 15 outputs are enabled to generate interrupts to the CJ1-H CPU Unit.

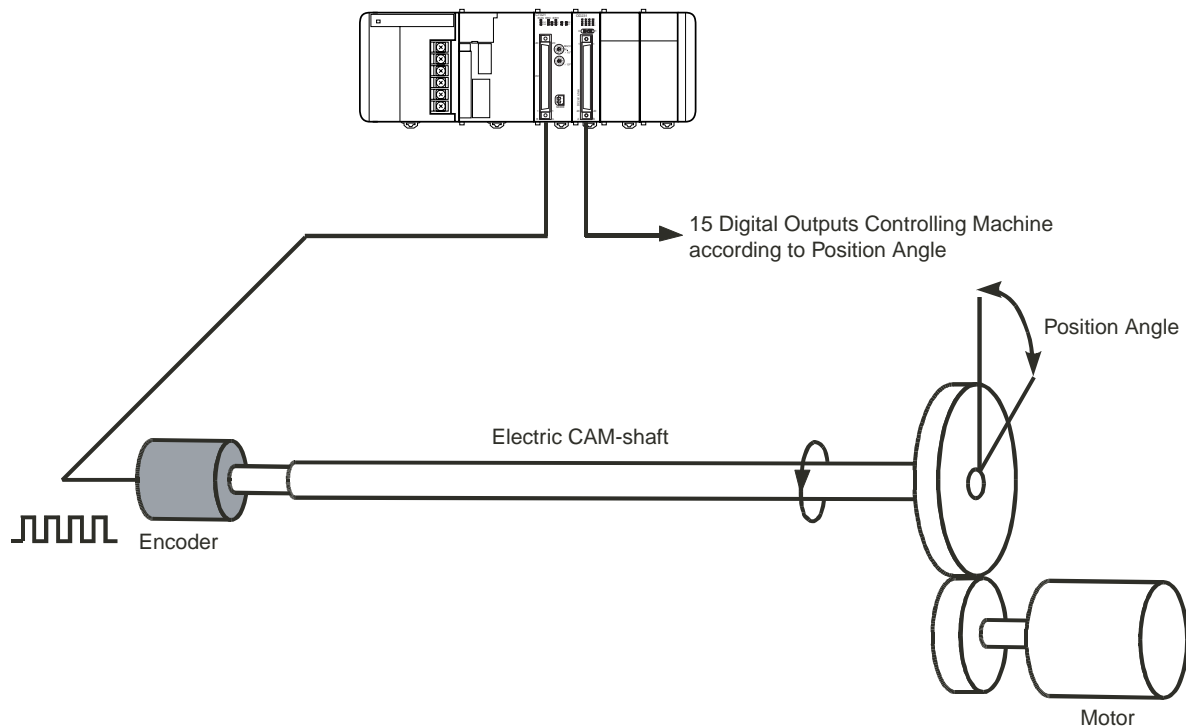

The encoder is connected to Circular Counter 1. The 15 outputs are controlled by 5 Ranges (Range 0 to 4). An Hysteresis of 20 counts is defined and will be applied to the Range Limits. The outputs are assigned to the Interrupt Tasks 10 to 39 respectively in the PLC ladder program (i.e. offset is 10). As a result the rising edge of (Digital) Output O0 is assigned to External Interrupt Task 10, the falling edge to External Interrupt Task 11 and so on.

Range Data

Range	Lower Range Limit	Upper Range Limit	Outputs ON
0	500	800	0, 1, 5, 12
1	700	1500	5, 6, 8, 13, 14
2	2500	6000	5, 7, 9
3	5000	7000	2, 3
4	12000	18000	7, 9, 10, 11

DM-configuration

The Machine Number of the High-speed Counter Unit is 0. The High-speed Counter is allocated 40 CIO-words starting from CIO 2000 ($n = \text{CIO } 2000 + 0 \times 10$) and 400 DM-words starting from D 20000 ($m = \text{D } 20000 + 0 \times 100$). The Range Data of Counter 1 is stored in EM starting from EM100. To configure the Unit the following DM-settings must be made.

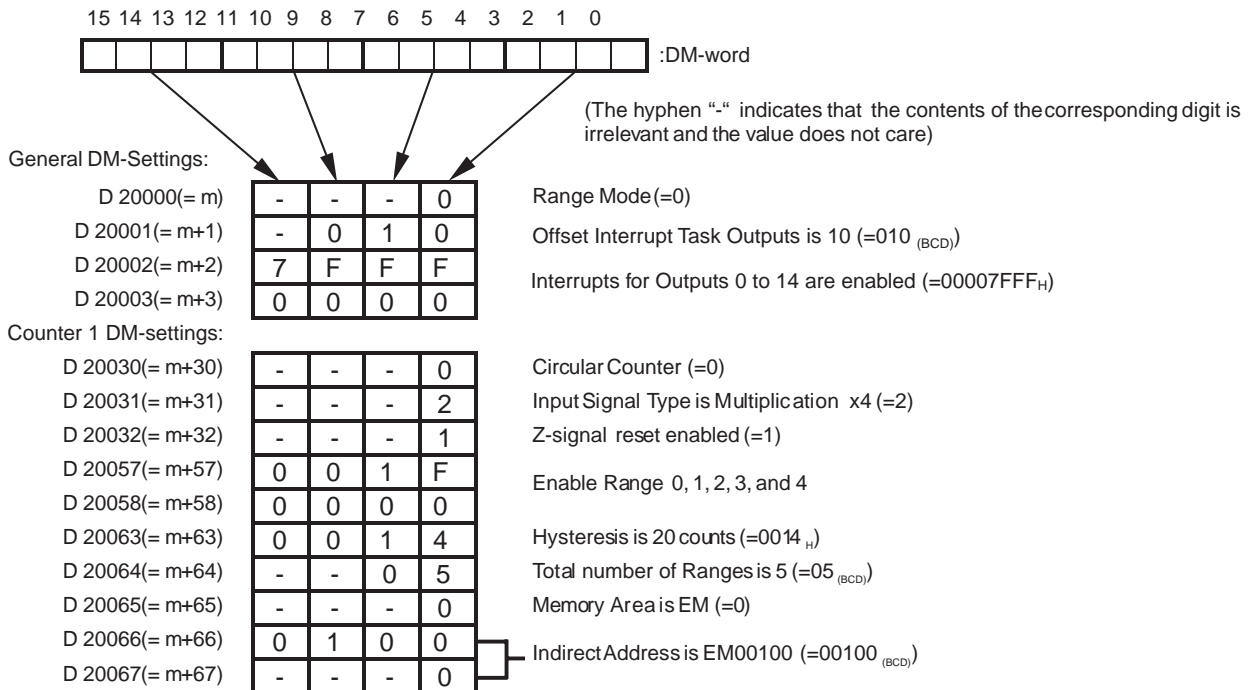

Range Data Counter 1

Range Data Counter 1

Range 0 settings of Counter 1 (in EM):

EM 00100	0	1	F	4	Lower Range Limit is 500 (=000001F4 _H)
EM 00101	0	0	0	0	
EM 00102	0	3	2	0	Upper Range Limit is 800(=00000320 _H)
EM 00103	0	0	0	0	
EM 00104	1	0	2	3	Output Pattern: 0, 1, 5 and 12 are ON (=00001023 _H)
EM 00105	0	0	0	0	

Range 1 settings of Counter 1 (in EM):

EM 00106	0	2	B	C	Lower Range Limit is 700 (=000002BC _H)
EM 00107	0	0	0	0	
EM 00108	0	5	D	C	Upper Range Limit is 1500 (=000005DC _H)
EM 00109	0	0	0	0	
EM 00110	6	1	6	0	Output Pattern: 5, 6, 8, 13 and 14 are ON (=00006160 _H)
EM 00111	0	0	0	0	

Range 2 settings of Counter 1 (in EM):

EM 00112	0	9	C	4	Lower Range Limit is 2500 (=000009C4 _H)
EM 00113	0	0	0	0	
EM 00114	1	7	7	0	Upper Range Limit is 6000 (=00001770 _H)
EM 00115	0	0	0	0	
EM 00116	0	2	A	0	Output Pattern: 5, 7 and 9 are ON (=000002A0 _H)
EM 00117	0	0	0	0	

Range 3 settings of Counter 1 (in EM):

EM 00118	1	3	8	8	Lower Range Limit is 5000 (=00001388 _H)
EM 00119	0	0	0	0	
EM 00120	1	B	5	8	Upper Range Limit is 7000 (=00001B58 _H)
EM 00121	0	0	0	0	
EM 00122	0	0	0	C	Output Pattern: 2 and 3 are ON (=0000000C _H)
EM 00123	0	0	0	0	

Range 4 settings of Counter 1 (in EM):

EM 00124	2	E	E	0	Lower Range Limit is 12000 (=00002EE0 _H)
EM 00125	0	0	0	0	
EM 00126	4	6	5	0	Upper Range Limit is 18000(=00004650 _H)
EM 00127	0	0	0	0	
EM 00128	0	E	8	0	Output Pattern: 7, 9, 10 and 11 are ON (=00000E80 _H)
EM 00129	0	0	0	0	

Transfer the DM-settings to the High-speed Counter Unit by restarting the Unit.

Ladder Program

A short ladder program (consisting of 30 External Interrupt Tasks) for the PLC is written to control the outputs via the additional output module. All outputs are configured to generate interrupts. The Digital Output Unit is mapped in CIO starting from CIO 000000. The Software Reset Enable bit must be set to "1" in CIO (= CIO 200205) to enable resetting Counter 1 by a rising edge of the Z-signal.

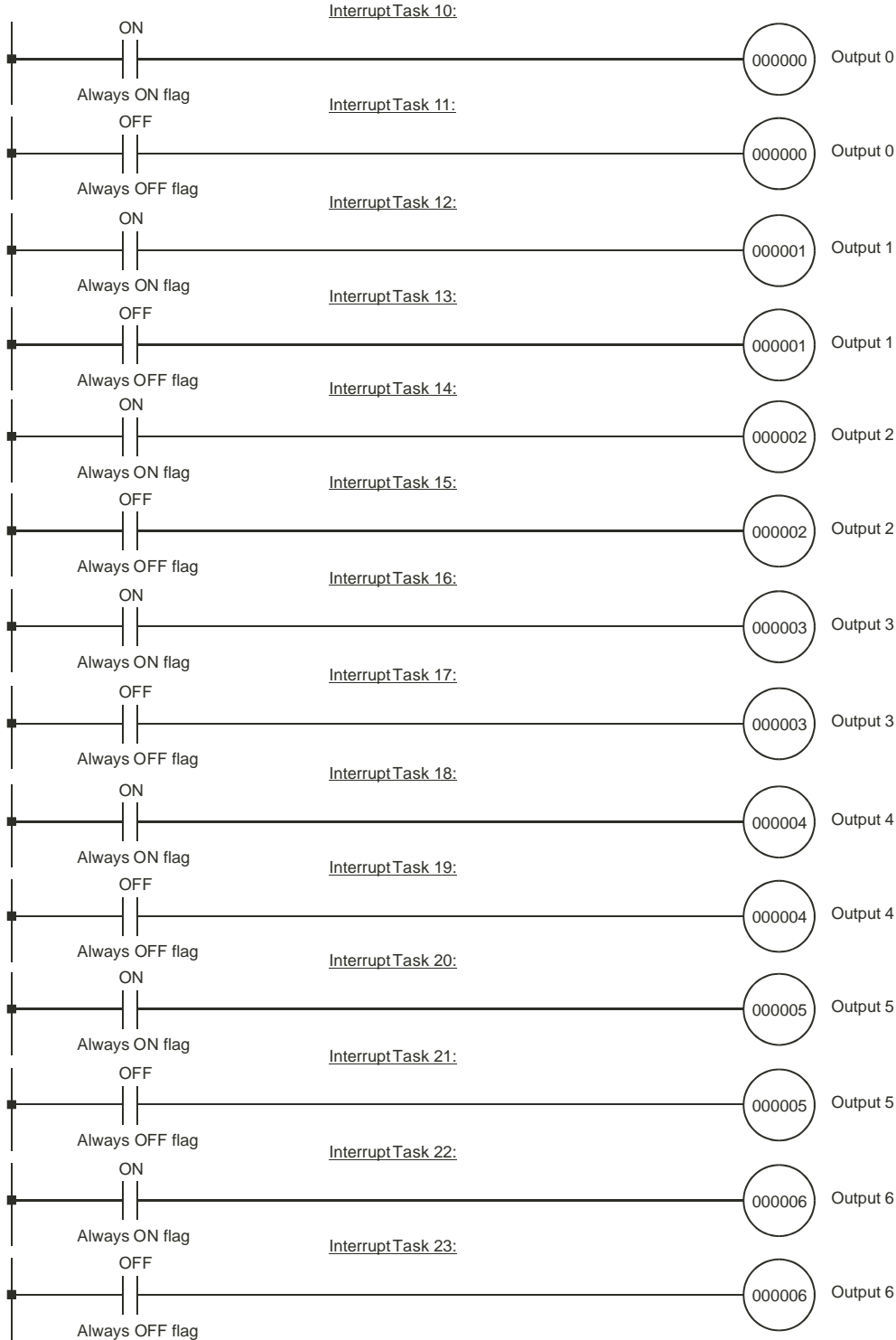

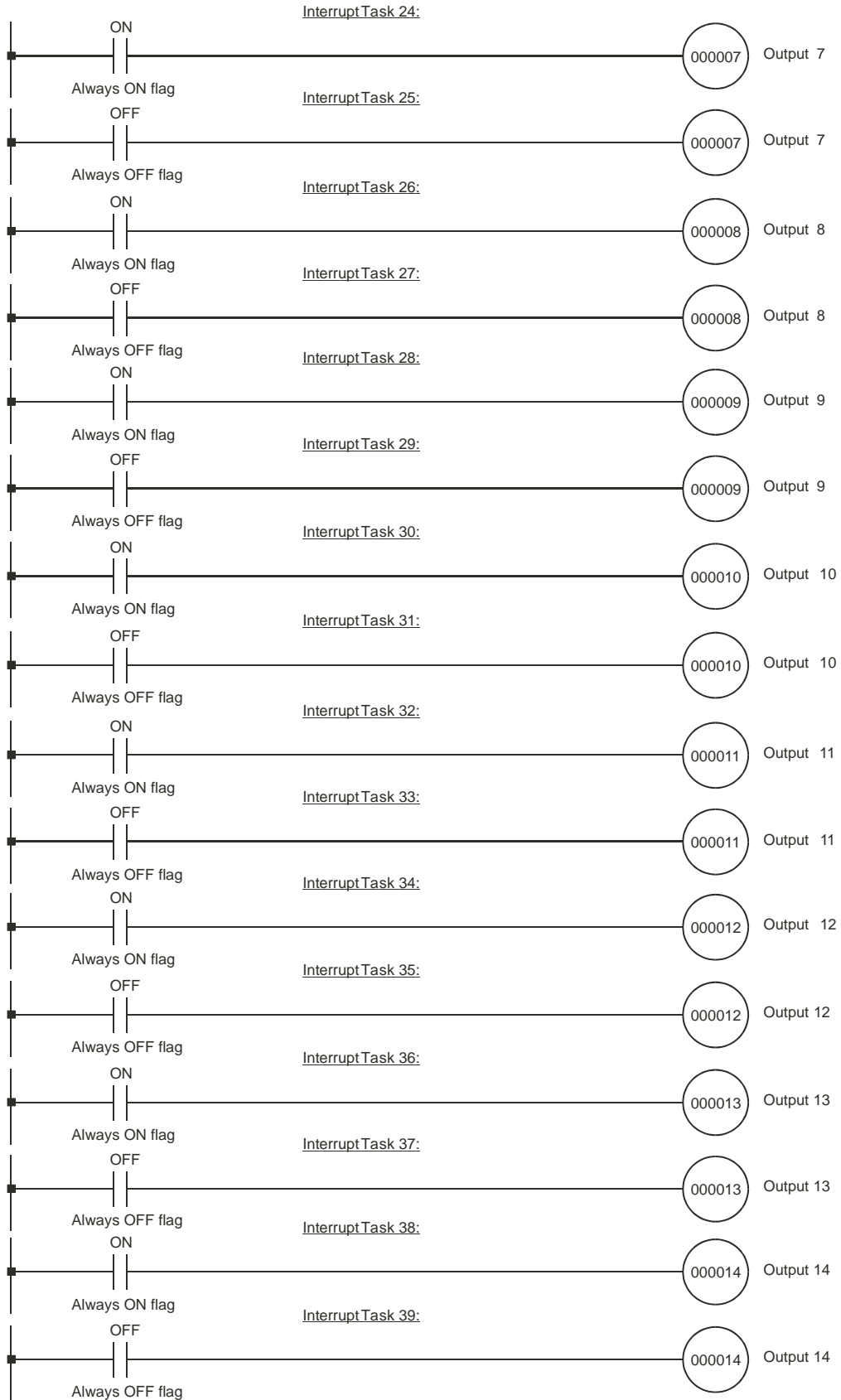

6-5 Speed Control

Covered configuration items in this example:

- Circular Counter
- Rate Ranges, setting Rate Range Data

Application Description

In this example logs are fed into a saw blade. A conveyor that has two speeds (fast/slow) transports the logs. Via the control panel the conveyor and the saw blade can be started and stopped. A speed sensor detects the speed of the saw blade. The pulses of the speed sensor are counted by Counter 1 and are proportional to the speed of the saw blade.

Logs are fed into the saw blade at fast speed. When the saw blade encounters an irregularity in the log, the speed of the saw blade slows down. Now the conveyor is switched from fast to slow speed (slow speed indicator turns ON). Once the saw blade clears the irregularity and returns to its normal speed, the conveyor is switched from slow to fast speed again (slow speed indicator turns OFF).

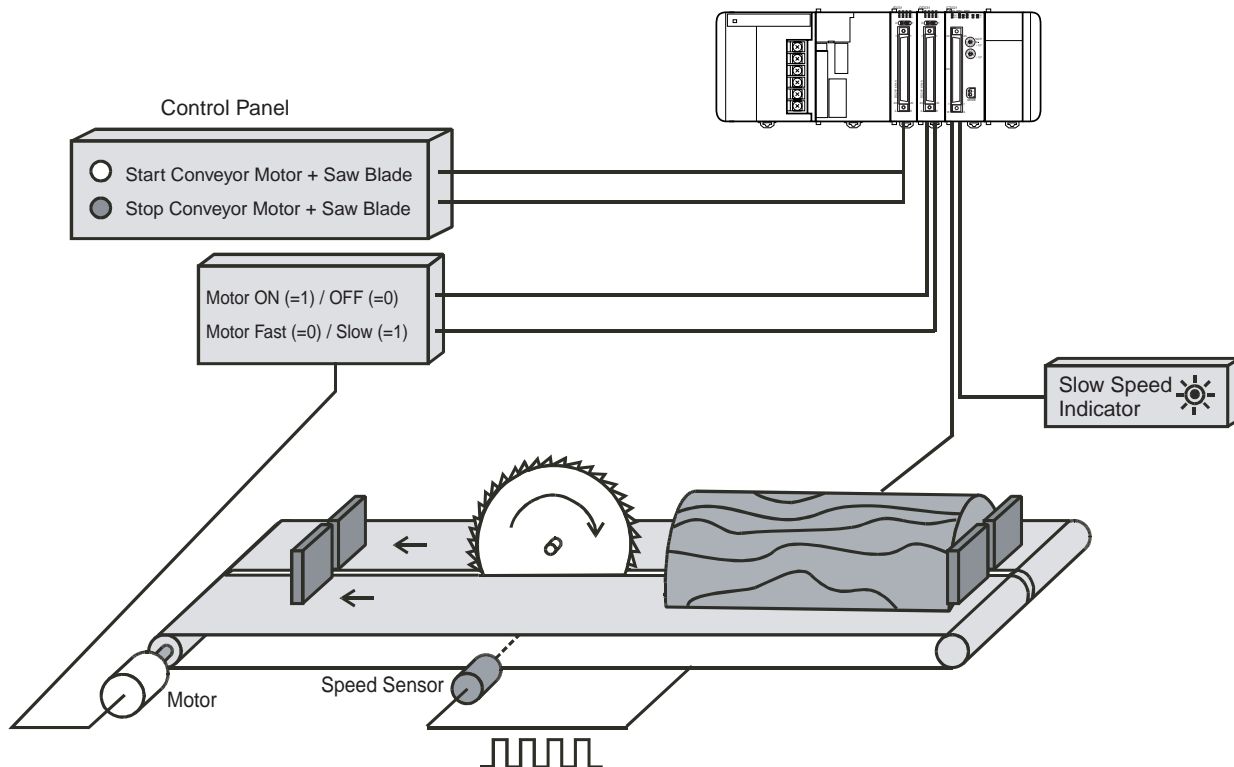

The speed sensor is connected to Circular Counter 1. The two Rate Ranges (Range 0 and 1) of Counter 1 are used to detect the speed of the saw blade. Turning the conveyor motor and the saw blade ON/OFF, using the control panel, is controlled via the PLC ladder program and a Digital Input- and Output Unit (e.g. CJ1W-OD231/ID231). The speed of the conveyor motor is controlled by Digital

Output O0 and the slow speed indicator is controlled by Digital Output O1 of the High-speed Counter Unit.

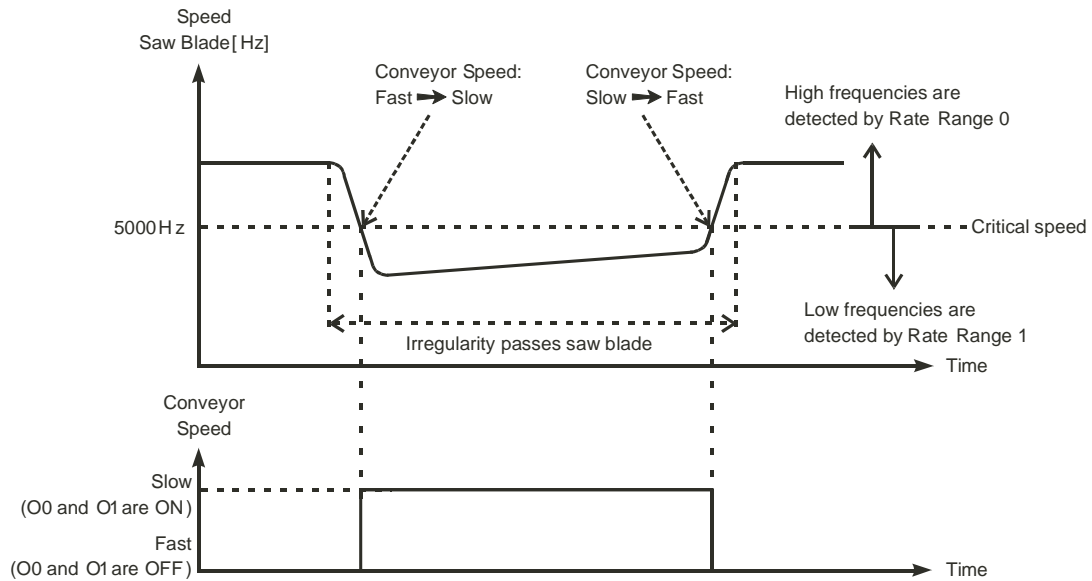

In order to use Counter 1 for Rate Measurement its Time-Window has been set to 1 second (=1000 ms). Rate Range 0 is used to detect frequencies that are above the critical speed and Rate Range 1 used to detect frequencies that are below the critical speed:

Rate Range Data

Rate Range	Lower Rate Range Limit	Upper Rate Range Limit	Outputs ON
0	5000	2,147,483,647	0, 1 (OFF)
1	0	4999	0, 1 (ON)

DM-configuration

The Machine Number of the High-speed Counter Unit is 0. The High-speed Counter is allocated 40 CIO-words starting from CIO 2000 ($n = \text{CIO } 2000 + 0 \times 10$) and 400 DM-words starting from D 20000 ($m = \text{D } 20000 + 0 \times 100$). To configure the Unit the following DM-settings must be made.

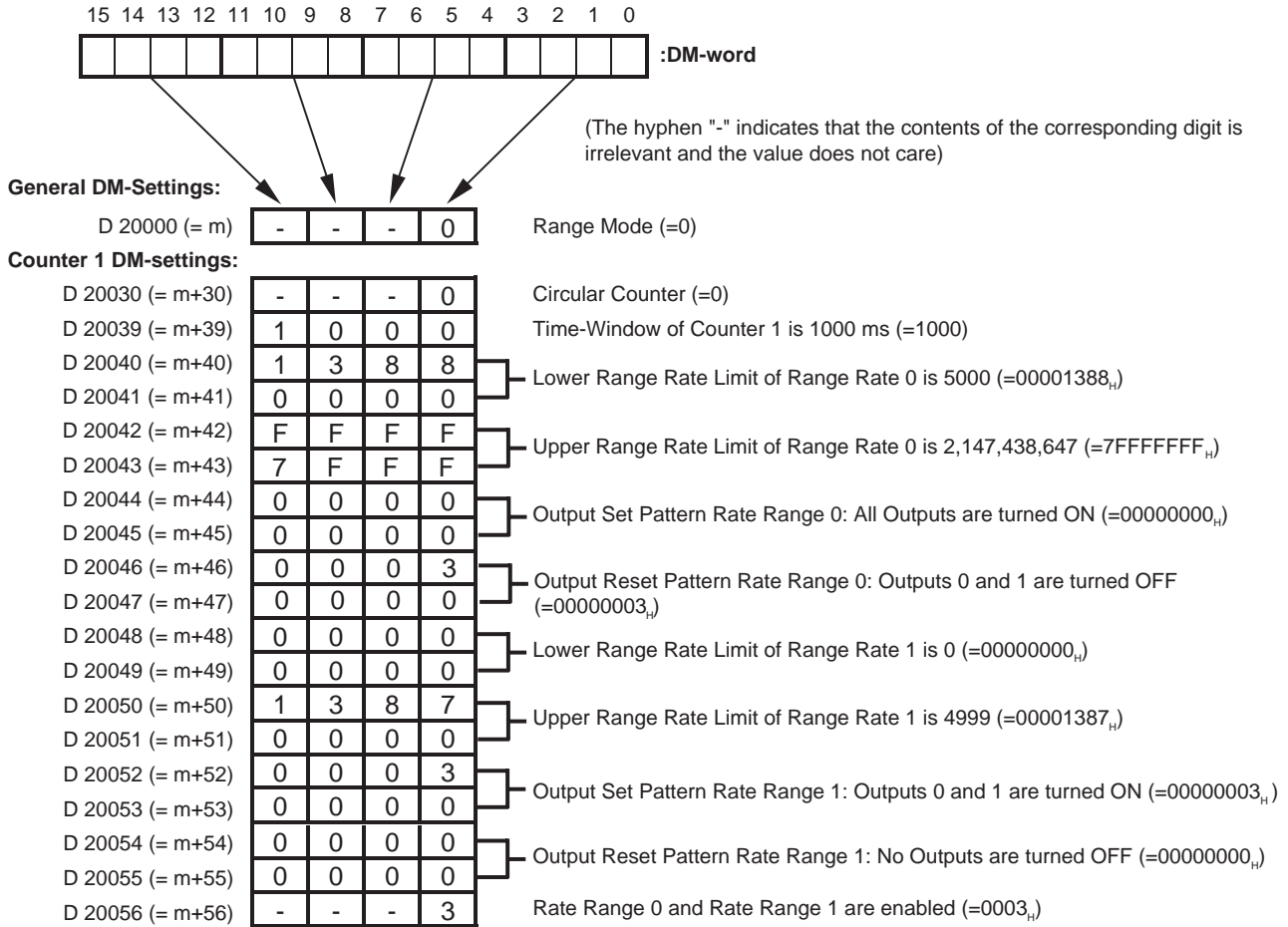

Transfer the DM-settings to the High-speed Counter Unit by restarting the Unit.

Ladder Program

A short ladder program for the PLC is written to control the conveyor motor and the saw blade via the control panel. The Digital Output Unit is mapped in CIO starting from CIO 000000. The start-pushbutton is mapped on CIO 000200 and the stop-pushbutton on CIO 000201. The conveyor motor is mapped on CIO 000000 and the saw blade motor on CIO 000001.

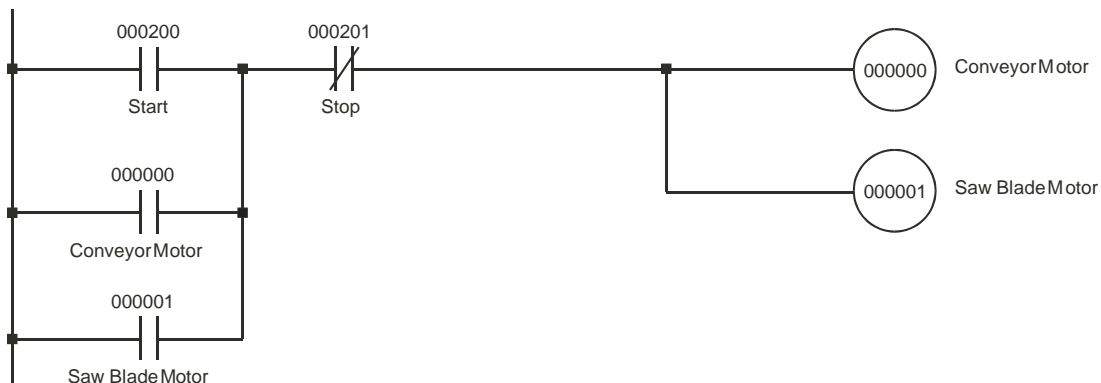

Appendix A

Using Terminal Block Units with Screw-terminals

The following table shows the numbering of the Screw-terminals when you use Terminal Block Units (XW2B-40G4 or XW2B-40G5) to connect the external signals (Power Supply, Digital I/O and Counter Input Signals) to the CJ1W-CT021 High-speed Counter Unit.

Item		Connector 1 (CN1)			
		Terminal Block Unit 1:Screw-terminal Number			
Power Supply (to feed the outputs)		-PS: 0 V	1	+PS:12 to 24 V	2
Digital Outputs [0-1] (NPN/PNP)		O0: NPN	3	O0: PNP	4
		O1: NPN	5	O1: PNP	6
Spare			7		8
Digital Inputs [0-1]		I0: 0 V	9	I0: 24 V	10
		I1: 0 V	11	I1: 24 V	12
Spare			13		14
Counter 1	A	CH1: LD- / 0 V	15	CH1: LD+	16
		CH1: 5 V	17	CH1: 24 V	18
	B	CH1: LD- / 0 V	19	CH1: LD+	20
		CH1: 5 V	21	CH1: 24 V	22
	Z	CH1: LD- / 0 V	23	CH1: LD+	24
		CH1: 5 V	25	CH1: 24 V	26
Spare			27		28
Counter 2	A	CH2: LD- / 0 V	29	CH2: LD+	30
		CH2: 12 V	31	CH2: 24 V	32
	B	CH2: LD- / 0 V	33	CH2: LD+	34
		CH2: 12 V	35	CH2: 24 V	36
	Z	CH2: LD- / 0 V	37	CH2: LD+	38
		CH2: 12 V	39	CH2: 24 V	40

Connections

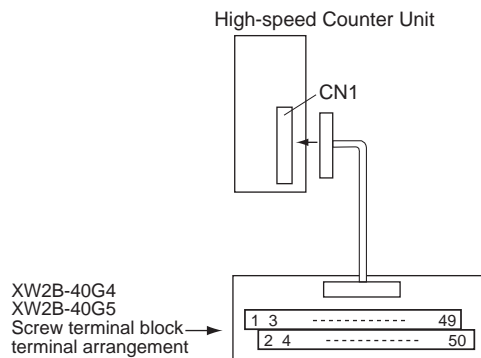

Note The top row of the Terminal Block Unit (numbered 1 to 39) corresponds to the pins numbered A1 to A20 of the associated connector (CN1) on the High-speed Counter Unit. The bottom row of the Terminal Block Unit (numbered 2 to 40) corre-

sponds to the pins numbered B1 to B20 of the associated connector (CN1) on the Unit.

Appendix B

Assigning External Interrupt Tasks to Outputs

The following table shows which External Interrupt Task Numbers are assigned to rising- and falling edges of the corresponding Output bits in the Unit Output Pattern. Two External Interrupt Tasks are assigned to every Output if that Output has been enabled to generate interrupts. An output can be enabled to generate interrupts by setting the corresponding bit in the Output Interrupt Enable Data (refer to 4-6-1 "Outputs Generating Interrupts").

Output	Assigned External Interrupt Task Number	Interrupt executed at rising/falling edge*
0 (=O0)	Offset	Rising
	Offset + 1	Falling
1 (=O1)	Offset + 2	Rising
	Offset + 3	Falling
2	Offset + 4	Rising
	Offset + 5	Falling
3	Offset + 6	Rising
	Offset + 7	Falling
4	Offset + 8	Rising
	Offset + 9	Falling
5	Offset + 10	Rising
	Offset + 11	Falling
6	Offset + 12	Rising
	Offset + 13	Falling
7	Offset + 14	Rising
	Offset + 15	Falling
8	Offset + 16	Rising
	Offset + 17	Falling
9	Offset + 18	Rising
	Offset + 19	Falling
10	Offset + 20	Rising
	Offset + 21	Falling
11	Offset + 22	Rising
	Offset + 23	Falling
12	Offset + 24	Rising
	Offset + 25	Falling
13	Offset + 26	Rising
	Offset + 27	Falling
14	Offset + 28	Rising
	Offset + 29	Falling
15	Offset + 30	Rising
	Offset + 31	Falling

* The assigned External Interrupt Task number is executed at a rising/falling edge of the corresponding Output bit in the Unit Output Pattern.

Output	Assigned External Interrupt Task Number	Interrupt executed at rising/falling edge*
16	Offset + 32	Rising
	Offset + 33	Falling
17	Offset + 34	Rising
	Offset + 35	Falling
18	Offset + 36	Rising
	Offset + 37	Falling
19	Offset + 38	Rising
	Offset + 39	Falling
20	Offset + 40	Rising
	Offset + 41	Falling
21	Offset + 42	Rising
	Offset + 43	Falling
22	Offset + 44	Rising
	Offset + 45	Falling
23	Offset + 46	Rising
	Offset + 47	Falling
24	Offset + 48	Rising
	Offset + 49	Falling
25	Offset + 50	Rising
	Offset + 51	Falling
26	Offset + 52	Rising
	Offset + 53	Falling
27	Offset + 54	Rising
	Offset + 55	Falling
28	Offset + 56	Rising
	Offset + 57	Falling
29	Offset + 58	Rising
	Offset + 59	Falling
30	Offset + 60	Rising
	Offset + 61	Falling
31	Offset + 62	Rising
	Offset + 63	Falling

* The assigned External Interrupt Task number is executed at a rising/falling edge of the corresponding Output bit in the Unit Output Pattern.

Appendix C

Description of the Response Time

The Response Time of the CJ1W-CT021 High-speed Counter Unit is the time between the Unit receiving a count pulse (on one of the Counter inputs A or B) and the switching (ON or OFF) of a corresponding Digital Output.

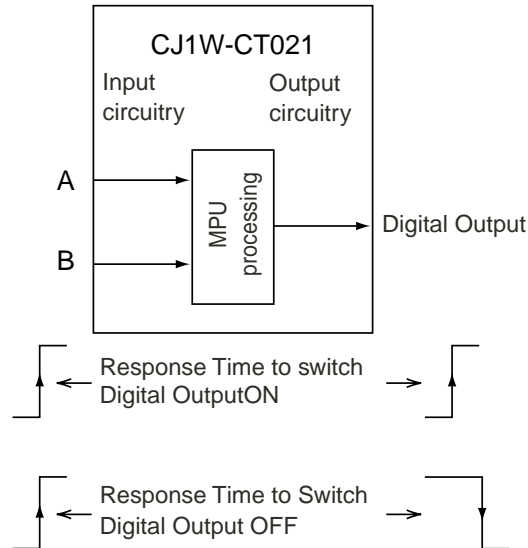

The Response Time can vary between 0.1 and 0.5 milliseconds, but is guaranteed to be less than 0.5 milliseconds. The following factor causes the Response Time to fluctuate:

- the number of Counters simultaneously crossing a Range Limit or Comparison Value

The maximum Response Time of 0.5 milliseconds can no longer be guaranteed and will temporarily become longer than 0.5 milliseconds in case you make use of:

- IOWR/IORD-instructions
- IORF-instructions
- Programmable Output Pulses
- Rate Measurement for one or more Counters
- Digital Inputs or Z-inputs
- Outputs- and or Digital Inputs generating Interrupts to the CJ1-H PLC

Note

- When using one of the above functions, the approximate response time will be as follows:
Response time = 0.5 ms + function execution time.
- Refer to Appendix E "*IORF and IOWR/IORD-instruction Execution Times*" for information on execution times for IORF and IOWR/IORD-instructions.
- External Control Inputs and Z-signal Inputs require approximately 300 μs, and external interrupt tasks require 10 μs per interrupt.

Appendix D

Application Restrictions

The following restrictions apply when using CJ1W-CT021 High-speed Counter Units.

Restriction	Reference
When a 50-kHz noise filter is configured, External Control Inputs cannot read signals shorter than 10 μ s.	1-3-3 " <i>Input Specifications</i> "
The time from signal input to resetting for External Control Inputs is 300 μ s max.	3-4 " <i>Digital Input Functions</i> "
The Open Gate Bit, Close Gate Bit, Preset Counter Bit, Reset Bit, or the Counter Capture Bit in CIO may not be executed if turned ON for only one PLC-cycle. Always keep these bits turned ON until the execution status changes in the corresponding flag in n+24 or n+29.	3-4 " <i>Digital Input Functions</i> " 4-2 " <i>Memory Allocation</i> "
External Control Inputs may not be reflected in the status of External Inputs (n+2, n+5) if the pulse width is extremely short. The following are the main reasons for this: <ul style="list-style-type: none"> • The signal is shorter than the CPU Unit cycle time. • The signal is shorter than the time the Data Transfer Busy bit is ON (e.g., during execution of an IOWR-instruction.) 	3-4 " <i>Digital Input Functions</i> "
The comparison operation stops for 1.5 ms from when the High-speed Counter Value falls within the Upper Range Limit or Lower Range Limit for the Range Data. However, the comparison does not stop for other counters. Consider the time that the comparison is stopped when making settings for Range Data.	3-5-1-2 " <i>Configuration and operation in Range Mode</i> "
When the High-speed Counter Value reaches the target value for Comparison Data, comparison stops for 1.5 ms. However, comparison for other counters does not stop. Consider the time the comparison stops when setting Comparison Data.	3-5-2-2 " <i>Configuration and operation in Comparison Mode</i> "
Comparison is stopped during the execution of IOWR/IORD-instructions and remains stopped until the processing of the instruction has been completed. The Data Transfer Busy bit is ON during this time. This stopping of comparison during the execution of IOWR/IORD-instructions affects counter comparisons for all counters. Set Range Data and Comparison Data considering that comparisons are stopped by execution of IOWR/IORD-instructions.	3-5-1-2 " <i>Configuration and operation in Range Mode</i> " 3-5-2-2 " <i>Configuration and operation in Comparison Mode</i> "
The measurement interval for the Pulse Rate Measurement Function normally varies by 125 μ s and can vary by a maximum of 1 ms. If the pulse rate value is averaged in the ladder program, a value with a low (averaged) variation can be obtained.	3-7-2 " <i>Rate Measurement</i> "
The I/O Refresh will not occur while the Data Transfer Busy bit (CIO n+19, bit 02) is ON, and the Counter Value will not be refreshed while this bit is ON.	4-1-1 " <i>Basic Setup</i> "
The Unit's Data Transfer Busy bit (n+19, bit 02) will turn ON for approximately 120 ms at restart and when the power is turned ON.	4-2-3 " <i>CIO-Memory Mapping</i> "
When using the IOWR-instruction to write Comparison Data to the Unit, check that the target value being written will not be duplicated in the same Counter. If a target value already set to the Unit is transferred, set the Comparison Data so that the same value will be overwritten for the existing target value.	4-5 " <i>Supported IOWR/IORD-Instructions</i> "
A CJ1-H or CJ1M CPU Unit is required to use external interrupt tasks. CJ1 CPU Units do not support external interrupt tasks. There are also restrictions on the position of the Unit on the Rack. Refer to the section given in the right column for information on the restrictions.	4-6 " <i>Interrupts</i> "

Restriction	Reference
The External Interrupt Task buffer stores up to 30 requests.	5-2-5 " <i>Interrupt FIFO full error</i> "
For functions that cannot guarantee a response time of 0.5 ms or shorter, the approximate response time will be as follows: Response time = 0.5 ms + function execution time. External Control Inputs and Z-signal Inputs take approximately 300 μ s, and external interrupt tasks take 10 μ s per interrupt. Refer to Appendix E " <i>IORF and IOWR/IORD-instruction Execution Times</i> " for information on execution times for IORF and IOWR/IORD-instructions.	Appendix C " <i>Description of the Response Time</i> "

Appendix E

IORF and IOWR/IORD-instruction Execution Times

Instruction	Control data	Execution conditions	Execution time	
IORF	---	---	1.0 ms	
IOWR	0D01	---	10 s	
	0B01	---	0.8 ms	
	1A00 (See note.)		Range comparison conditions are not set in the Unit and the following command is executed.	
			Rewriting 21 ranges	5 ms
	1A00 (See note.)		Comparison conditions for 32 ranges are set in the Unit and the following command is executed.	
			Rewriting 1 range	50 ms
			Rewriting 21 ranges	55 ms
	1A00 (See note.)		Comparison conditions for 16 ranges are set in the Unit and the following command is executed.	
			Rewriting 1 range	29 ms
			Rewriting 21 ranges	33 ms
	1A00 (See note.)		Comparisons for 32 target conditions are set in the Unit and the following command is executed.	
			Rewriting 1 comparison value	10 ms
			Rewriting 12 comparison values	13 ms
	1A00 (See note.)		Comparisons for 16 target conditions are set in the Unit and the following command is executed.	
			Rewriting 1 comparison value	8 ms
			Rewriting 12 comparison values	10 ms
	1B03		When Range Mode is used	
			Disabling all comparison ranges	5 ms
			Enabling 16 comparison ranges	29 ms
			Enabling all comparison ranges	50 ms
1B03		When Comparison Mode is used		
		Disabling all comparison values	5 ms	
		Enabling 16 comparison values	8 ms	
		Enabling all comparison values	11 ms	
IORD	0B01	---	0.3 ms	
	0B02	---	0.3 ms	
	1E01	---	0.3 ms	
	1C03	---	0.3 ms	
	1C04	---	0.3 ms	
	1F02	---	0.3 ms	
	1B03	---	0.3 ms	
	1B04	---	0.3 ms	
	1A00	---	0.8 ms	
	1C02	---	0.3 ms	
	1F01	---	0.7 ms	
	1C01	---	0.3 ms	

Note The time required to rewrite a Comparison Table depends more on the number of values already set in the table in the Unit than on the amount of transfer data.

Index

A

- A-indicator 27
- Allocating Memory 97
- Application Areas 24
- Application Examples
 - CAM-positioning 159
 - Flow Control 146
 - Length Measurement 149
 - Positioning 154
 - Speed Control 164
- Assembling Connectors 34
- Automatic Output Control 65, 79

B

- Basic Configuration 5
- B-indicator 27

C

- CAM-positioning Example 159
- Captured Counter Value, reading with IORD 125, 150
- Capturing 62
- CIO-Memory Mapping, Input Words 103
 - Counter 1 103
 - Counter 2 104
 - General 103
- CIO-Memory Mapping, Output Words 102
 - Counter 1 102
 - Counter 2 102
 - General 102
- Circular Counter 17, 19, 53
 - Examples 149, 159
- Comparison Memory Mapping 114
- Comparison Mode 73
 - Configuration and operation 76
 - Example with Circular Counter 74
 - Example with Linear Counter 73
 - Overview 75
- Comparison Value 76
- Comparison-Data
 - Allocation 99, 114
 - Changing at run-time, using IORD/IOWR 154
 - Configuration 76
 - Examples 101, 154
- Components 26
- Configuring High-speed Counter Unit 19, 46

- Counter Types 47
 - Circular Counter 53
 - Linear Counter 54
 - Simple Counter 48
- Digital Input Functionality 59
- Hysteresis 90
- Initial Counter Value 92
- Input Signal Types 56
 - Phase Differential Signals (x1, x2, x4) 56
 - Pulse & Direction Signals 58
 - Up & Down Signals 57
- Noise Filtering 91
- Output Control 65
 - Comparison Mode 73
 - Manual Output Control 79
 - Output Driver Type 80
 - Output State Control 80
 - Range Mode 67
- Programmable Output Pulses 83
- Rate Measurement 84
- Resetting 81
- Connector 32
 - Pin-layout 32
 - Wiring Methods 33
 - External Connector 33
 - Terminal Block Unit 35
- Counter Input Circuitry 37
 - Example Line Driver (RS-422) 43
- Counter Inputs 41
 - Configuring Driver Type 33
 - 12VDC Open Collector 33
 - 24VDC Open Collector 33
 - 5VDC Open Collector 33
 - Example 5/12/24VDC NPN Open Collector 41
 - Example 5/12/24VDC PNP Open Collector 42
 - Example Line Driver (RS-422) 43
 - Specifications 11
- Counter Type Switch 28
- Counter Types 47
 - Circular Counter 53
 - Linear Counter 54
 - Simple Counter 48
- Counter Value 47
- Counting Direction 65
- Counting Range
 - Circular Counter 53
 - Linear Counter 54
 - Simple Counter 49

D

- Data Exchange, between CPU and CS1W-CT021/CT041 94
- Delay, turning ON an Output 83
- Digital Input Functionality 59
 - Capture and Reset Function 63
 - Capture Function 62
 - Disable Reset Function 64
 - Enable Reset Function 64
 - Examples 149, 154
 - Multiple Digital Inputs controlling one Counter 59
 - Preset Function 60
 - Reset Function 61
 - Stop, Capture and Continue Function 62
 - Stop, Capture, Reset and Continue Function 63
- Digital Inputs
 - Functionality 59
 - Internal Circuitry 36
 - Specifications 11
 - Status Information 64
 - Wiring 33, 36
 - Example 24 VDC NPN Sensor 39
 - Example 24 VDC PNP Sensor 39
- Digital Inputs Generating Interrupts 131
- Digital Outputs
 - Internal Circuitry 38
 - NPN/PNP Output driver 80
 - Power Supply 32
 - Specifications 13
 - Status Information 66
 - Wiring 32, 38
 - Example NPN/PNP Digital Output 40
- Dimensions 26
- Direction of Counting 65
- DM-configuration 46
- DM-configuration errors 137
- DM-data, changing at run-time using IOWR/IORD 120
- DM-Memory Mapping 105
 - Counter 1 108
 - Counter 2 110
 - General 105
- Driver Types
 - Counter Inputs 33
 - 5/12/14 VDC Open Collector 33
 - Line Driver 33
 - Digital Outputs 80
 - NPN Driver 80
 - PNP-Driver 80

E

- Enable Reset 81
- ERC-indicator 27, 134
- ERH-indicator 27, 134
- Error Categories
 - DM-configuration errors 137
 - Interrupt FIFO full error 140
 - IOWR/IORD-instruction errors 138
 - Overflow/Underflow errors 139
 - Preset errors 140
- Error Clear Command 127
- Error codes 136
- Error History Log File 136
- Error Indicators
 - During Initial processing 134
 - During Normal processing 134
- Error Processing 137
- Errors, clearing
 - DM-configuration errors 137
 - Interrupt FIFO full error 140
 - IOWR/IORD-instruction errors 138
 - Overflow/Underflow errors 139
- Example, Comparison Mode
 - Comparison Mode with Circular Counter 74
 - Comparison Mode with Linear Counter 73
- Example, configuring Comparison-Data 99
- Example, configuring Range-Data 98
- Example, Range Mode
 - Range Mode with Circular Counter 68
 - Range Mode with Linear Counter 67
- Examples, application
 - CAM-positioning 159
 - Flow Control 146
 - Length Measurement 149
 - Positioning 154
 - Speed Control 164
- Extra Functions
 - Hysteresis 90
 - Initial Counter Value 92
 - Noise Filtering 91
 - Programmable Output Pulses 83
 - Rate Measurement 84

F

- Features and Functions 2
- Flow Control Example 146
- Forcing Outputs ON/OFF 79

Frequency Measurement 86
Functional Specifications 8

G

Gating 50, 60, 62
General specifications 7

H

Hysteresis 90
 Example 159

I

Indicators 27
 A, B, Z 27
 ERC 27
 ERH 27
 LED 27
 RUN 27, 134
Indirect Addressing 98
Initial Counter Value 92
Input Drivers 33
Input Signal Types 56
 Phase Differential Signals (x1, x2, x4) 56
 Pulse & Direction Signals 58
 Up & Down Signals 57
Input specifications 11
Inspection 142
Installing High-speed Counter Unit
 Components 26
 Indicators 27
 Installation 30
 Switch settings 29
 Counter Type Switch 28
 Machine Number Switch 29
Interrupt Task 129, 131, 162
Interrupts
 Inputs Generating Interrupts 131
 Outputs Generating Interrupts 129
 Example 159
IORD-Instruction 118
IOWR/IORD-Instructions 120
 (Re) Configure Unit 127
 Captured Counter Value 125
 Counter Value 126
 DM-data 120

Error Clear Command 127
Range- and Comparison data 122
Rate History Log File data 125
IOWR-Instruction 116

L

LED-indicators 27
Length Measurement Example 149
Linear Counter 21, 54
 Example 154
Logically AND/OR Counter Output Patterns 70, 149

M

Machine Number Switch 29
Maintenance 142
Manual Output Control 79
Memory Allocation 97
 CIO-Memory Mapping 101
 Comparison Memory Mapping 114
 DM-Memory Mapping 105
 Indirect Addressing 98
 Memory Mapping 97
 Range Memory Mapping 112
Memory Mapping 97
Mounting the Unit 31
Multiple Digital Inputs controlling one Counter 59

N

Noise Filtering 91
 Counter Inputs 91
 Digital Inputs 91
NPN-Output Driver 80

O

Offset 129, 131
Operating High-speed Counter Unit 15, 21
Operating Mode, change of 80
Output Control 65
 Comparison Mode 73
 Manual Output Control 79
 Output Driver Type 80
 Output State Control 80
 Range Mode 67
 Rate Ranges 87

- Output Drivers
 - NPN 80
 - PNP 80
- Output Pattern
 - Logically AND/OR Counter Output Patterns 72, 151
 - Predefined Output Pattern 80
 - Unit Output Pattern 66
- Output Pulse Duration 83
- Output Specifications 13
- Output State Control 80
- Output Status 66
- Output Turn ON Delay 83
- Outputs Generating Interrupts 129
- Overflow 55
- Overflow Error-Code Generation 55
- Overlapping, of Range/Comparison Data 97, 98

P

- Phase Differential Signals (x1, x2, x4) 56
- Physical Outputs 66
- Pin-layout Connector 32
- PNP-Output Driver 80
- Positioning Example 154
- Power OFF detection 92
- Power Supply 32
- Presetting 50, 60
- Programmable Output Pulses 83
 - Output Pulse Duration 83
 - Output Turn On-Delay 83
- Pulse & Direction Signals 58
- Pulse Duration, applied to Outputs 83, 149

Q

- Quick Start Up Information 15

R

- Range 67
- Range Memory Mapping 112
- Range Mode 67
 - Configuration and Operation 70
 - Example with Circular Counter 68
 - Example with Linear Counter 67
 - Logically AND/OR Counter Output Patterns 72
 - Overview 69

- Range-Data
 - Allocation 100, 112
 - Changing at run-time, using IORD/IOWR 122
 - Configuration 70
 - Examples 100, 152, 160
- Rate History Log File 86, 125
- Rate Measurement 84, 125
- Rate Ranges 87
 - Example 164
- Rate Value 85, 125
- Re-configure Unit, using IOWR 127
- Reset Signals
 - Digital Input 81
 - Reset Enable 82
 - Software Reset Bit 81
 - Z-Signal 81
- Resetting 51, 61, 63, 64, 81
- Restarting the Unit 96
- Rotational Speed Measurement 86
- RUN-indicator 27, 134

S

- Screw terminals 35, 167
- Simple Counter 48
 - Configuration 19, 48
 - Example 150
 - Operation 50
- Soft Outputs 66
- Software Reset Bit 81
- Special I/O Unit CIO Area 95
- Special I/O Unit DM Area 95
- Special I/O Unit Restart bits 96
- Specifications 7
 - Functional 8
 - General 7
 - Input 11
 - Output 13
- Speed Control Example 164
- Starting Up
 - Quick Start Up Reference Guide 15
- Status Digital Inputs 51, 64
- Status Digital Outputs 52, 66
- Switches 28, 29
 - Counter Type Switch 28
 - Machine Number Switch 29

T

Terminal Block Unit 35, 167

Time Window 85

Troubleshooting 136

U

Underflow 55

Underflow Error-Code Generation 55

Unit Output Pattern 66

Up & Down Signals 57

W

Wiring 32

 Connector Pin-layout 32

 Connector Wiring Methods 33

 External connector 33

 Terminal Block Unit 35

 Counter Input Circuitry

 Example 5/12/24 VDC NPN Open Collector 41

 Example 5/12/24 VDC PNP Open Collector 42

 Line Driver (RS-422) 43

 Digital Input Circuitry 36

 Example 24 VDC NPN Sensor 39

 Example 24 VDC PNP Sensor 39

 Digital Output Circuitry 38

 Example NPN/PNP Digital Output 40

 Important Wiring Considerations 36

Z

Z-indicator 27

Z-signal, resetting by 81, 159

Revision History

A manual revision code appears as a suffix to the catalog number on the front cover of the manual.

Cat. No. W401-E1-05

 Revision code

The following table outlines the changes made to the manual during each revision. Page numbers refer to the previous version.

Revision code	Date	Revised content
01	October 2001	Original production
02	August 2003	Minor revisions made throughout the manual, such as changing “PC” to “PLC,” and the following other changes were also made: Page 4: Information on run-time added. Pages 5 and 7: Note changed. Page 10: Note changed, and new note added. Page 11: Note added. Page 13: Removed “E6B2-type” from first sentence. Pages 53, 54, 61, and 62: Note added. Page 64: Information on digital input status added. Page 67: “Output” changed to “External output” and “Soft Output” changed to “Internal output” in diagram. Page 70: Information on specifying range-data added, including note on precautions. Pages 71, 75, 83, 93, and 99: Note added. Page 101: Two notes added. Page 106: Note added. Page 108: Two notes added. Pages 114 and 116: Information added to note. Page 125: Note on interrupts changed. Page 132: Information on remedy for system error changed. Page 137: Information on Interrupt FIFO full error added. Page 138: Information on clearing Interrupt FIFO full errors changed. Page 163: “0-3” changed to “0-1” for digital outputs and digital inputs in table, and terminal arrangement in diagram changed. Page 167: Note added at end of page. Page 168: Added two new appendices (<i>Appendix D</i> and <i>Appendix E</i>) including information on operating restrictions and execution times for IORF, IOWR, and IORD instructions.
03	April 2008	Page vi: Added warranty and liability information. Pages 43, 177, and 181: Changed “RS422” to “RS-422.”
04	April 2011	Page xiv: Several precautions added. Page 7: Specification names for temperature modified and storage temperature range changed. Page 8: “Rate Range” added to the last row. Page 12: Timing requirements for 500 kHz in the bottom table changed.

Revision code	Date	Revised content
05	April 2013	<p>Page 7: Added note and changed references to notes.</p> <p>Page 11: Changed entries in line driver columns.</p> <p>Page 12: Deleted text toward end of first paragraph.</p> <p>Page 127: Deleted "and Interrupt FIFO Full error" toward bottom of page.</p> <p>Page 140: Changed last sentence on page.</p> <p>Page 171: Deleted second of top two bullets and changed last sentence in paragraph above it.</p> <p>Page 175: Changed first value in execution time column.</p>

OMRON Corporation Industrial Automation Company
Tokyo, JAPAN

Contact: www.ia.omron.com

Regional Headquarters

OMRON EUROPE B.V.

Wegalaan 67-69-2132 JD Hoofddorp
The Netherlands
Tel: (31)2356-81-300/Fax: (31)2356-81-388

OMRON ELECTRONICS LLC

One Commerce Drive Schaumburg,
IL 60173-5302 U.S.A.
Tel: (1) 847-843-7900/Fax: (1) 847-843-7787

OMRON ASIA PACIFIC PTE. LTD.

No. 438A Alexandra Road # 05-05/08 (Lobby 2),
Alexandra Technopark,
Singapore 119967
Tel: (65) 6835-3011/Fax: (65) 6835-2711

OMRON (CHINA) CO., LTD.

Room 2211, Bank of China Tower,
200 Yin Cheng Zhong Road,
PuDong New Area, Shanghai, 200120, China
Tel: (86) 21-5037-2222/Fax: (86) 21-5037-2200

Authorized Distributor:

© OMRON Corporation 2001 All Rights Reserved.
In the interest of product improvement,
specifications are subject to change without notice.

Cat. No. W401-E1-05

0413