

Multi Vender Network for Sensors & Actuators

CompoNet

Fast and Intelligent



New Products

- Support for Machine Automation Controller NJ-Series!



NEW

Multi-function Compact Inverter MX2-Series CompoNet Communication Unit

Support for open network

- The MX2 series* can be connected to CompoNet by mounting the Communications Unit.
- * Supported for the MX2 series Ver.1.1 or higher.

8 types of remote I/O higher functions

- 8 types of remote I/O functions that exchange I/O data automatically without program are provided.
- All of the following functions of the inverter can also be used.
- Simple positioning control
 - Torque control
 - Setting of acceleration/deceleration time etc.

Parameter Edit via CompoNet

- Parameters of the inverter can be edited via CompoNet communication by using CX-Drive, support tool of inverter/servo drive.
- No tool switching required.
- * Supported for CX-Drive Ver.2.6 or higher.



CompoNet Communication Unit
3G3AX-MX2-CRT-E

Multi-function Compact
Inverter MX2-Series

Multi-function Compact Inverter MX2-Series

3G3MX2-A □□□□
3G3AX-MX2-CRT-E

NEW

CompoNet Slave Sensor Communication Unit



CompoNet Slave Sensor
Communication Unit
E3X-CRT

Reliable and high-speed communication

- Present value can be checked as needed.
- Setting can be changed and tuning can be performed via the network.
- Wiring is reduced by supplying power from the communications power supply.

Various sensors can be connected

- Fiber amplifier, laser amplifier, and proximity amplifier can be connected.
- Connection by sliding the special sensor without wiring.



CompoNet Gateway Unit for CC-Link

CC-Link links with CompoNet to expand system "easily" and "flexibly"



CompoNet Gateway Unit
for CC-Link
GQ-CRM21

"CC-Link" is a registered trademark of Mitsubishi Electric Corporation.

Reliable connection

- Error can be checked with the digital display of GQ-CRM21 on the site.
- Connect/communications error flags are transmitted. Error can be processed with the host program.



Improvement of wiring

- Easy & flexible branch
 - Easy installation with one-touch IDC
 - Branching even in fast mode by using repeater
- Selectable communication cables
 - Reduction of cost with round (VCTF) cables
 - Reduction of installation work with flat cables

Distributed installation
with the optimal I/O numbers

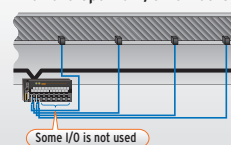

Simple expansion with the necessary
numbers for future extension

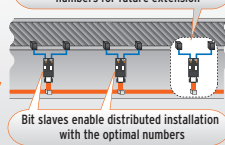



Manufacturing Site Moving into the Global Open Netwo

Information layer
Controller layer

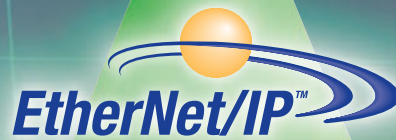

Device layer



Sensor & Actuator layer



CompoNet

Network Era

The drastic changes to the environment faced by today's manufacturing industry has led a wide range of issues such as the standardization of system infrastructure and the shift to more advanced functions. In order to solve these issues, it is necessary to share on-site data, such as for product quality and how to respond to changes in the environment, to vertically start up devices utilizing this data and execute preventive maintenance universally and quickly. That is why attention is focusing on utilizing globally standardized "open networks" in the plant management layer, the control layer, and the device layer.

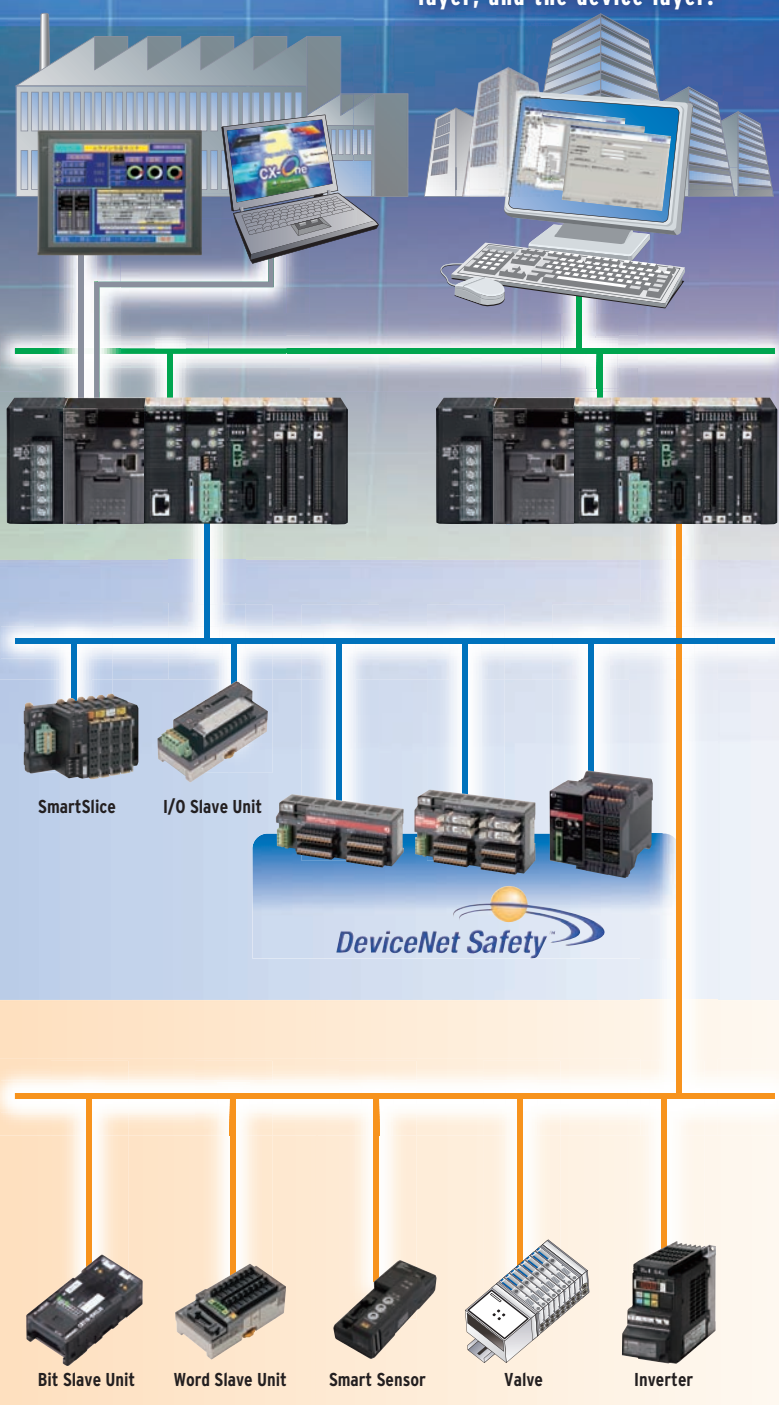

"CompoNet" globally standardized open network in the sensor & actuator layer —「CompoNet」—

Global standards

- IEC 62026-7 ed1.0 published
- Chinese National Standards GB Scheduled to published 2012
- Japanese Industrial Standards JIS Scheduled to published in 2012

CompoNet is the latest sensor & actuator layer open network. It was introduced and its specifications given by ODVA *1 in 2006.

This open network fuses CIP network technology *2 and high-level communications technology that consolidates the know-how for reducing the amount of wiring developed over many years at actual manufacturing sites. It was established and released as the International Standard IEC 62026-7 ed1.0 in December 2010.

CompoNet attains the industry's fastest class of communications, 1000 I/O signals per 1 ms between connected devices and the controller and provides a high-performance network environment never seen before.

The open network means reduced device costs, improved functions, the quality of procurement on a global level, and standardization turns design know-how into assets.

With the rapid expansion of family devices by many control equipment makers in Japan and overseas, CompoNet is establishing a multi-vendor environment that is a truly global open network.

*1 The abbreviation for Open DeviceNet Vendor Association, a non-profit organization in the United States. ODVA supports networks based on CIP technology and is run by the main vendors inside and outside Japan. It has active bases in America, Europe, China, South Korea, and Japan.

*2 CIP is the abbreviation for Common Industrial Protocol. This is a protocol that enables communications between open networks of equipment from multiple vendors. Control of each piece of equipment, programming, data collection, etc. can be standardized free of any restrictions due to the network type of differences among equipment.

Note: CompoNet, DeviceNet, and EtherNet/IP are registered trademarks of ODVA. ODVA Website:<http://www.odva.org/>

The conventional fast communication networks exceeding 10 Mbps must use special cables, which place restrictions on wiring. For example, they do not allow the connecting of branches.

In order to be able to use regular cables with their easier wiring, the only choice is a low baud rate network. With conventional field networks, achieving a "high-speed" while maintaining "ease of wiring", "informatization", and "low cost" is difficult. CompoNet achieves these competing conflicting objectives thanks to the latest technology for raising the efficiency of communication lines. CompoNet makes it possible to construct the manufacturing systems of the near future.

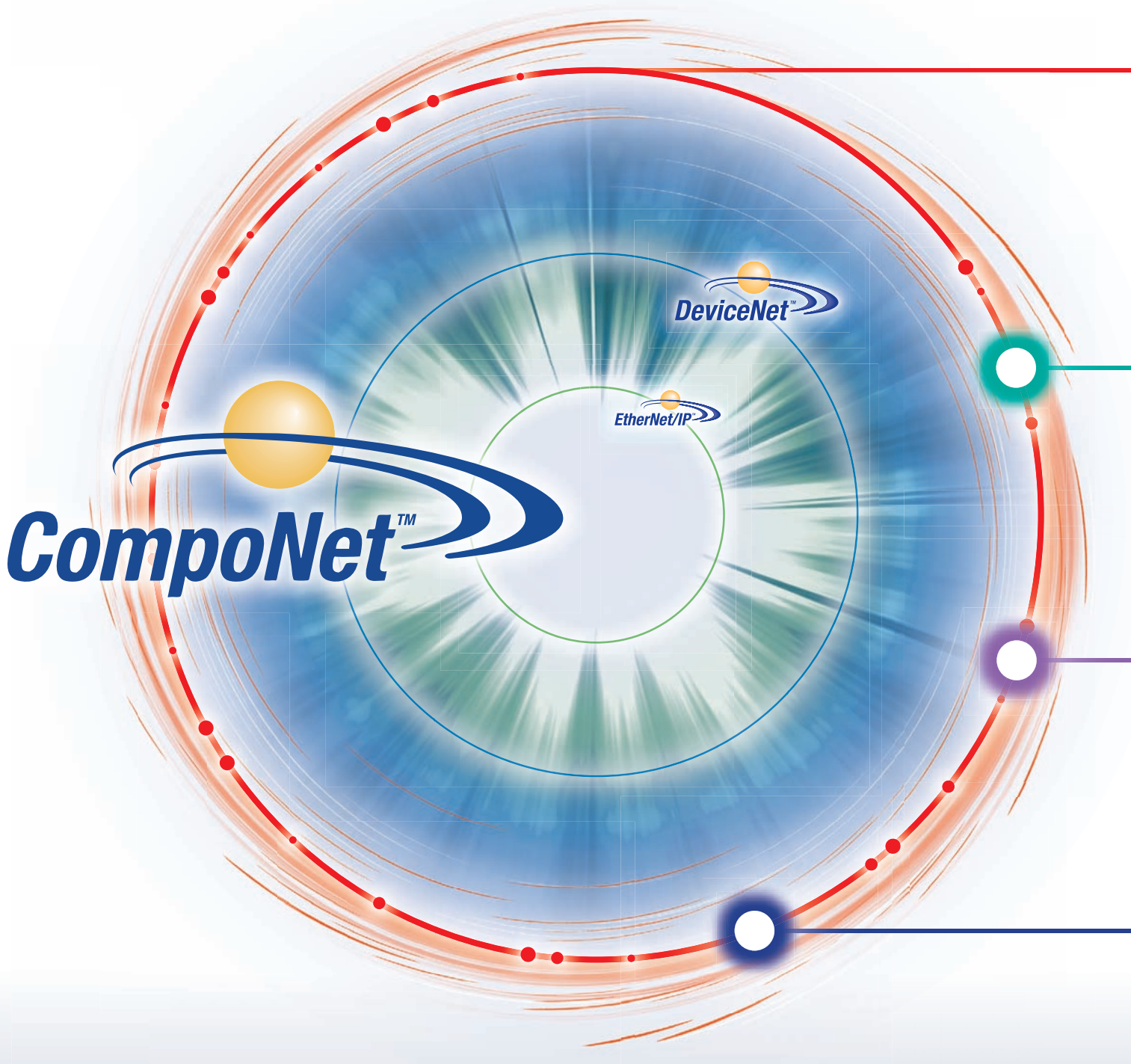

Fast Communication

1024 points in 1 ms: fastest class in the industry

CompoNet

solves the problems of conventional field networks!

Wiring

Superior branching

Informatization

Machine preventive maintenance

Simple and Low-Cost

Simple installation and regular cables mean lower cost

Fast Communication Fast multipoint communication reduces takt times

Fastest class Communication Speeds in the Industry

Provides the fastest communication speeds in the industry for a sensor-actuator level network.

It is possible to send data consisting a large number of control points on multiple nodes. There is no response time delay, even with repeater units.

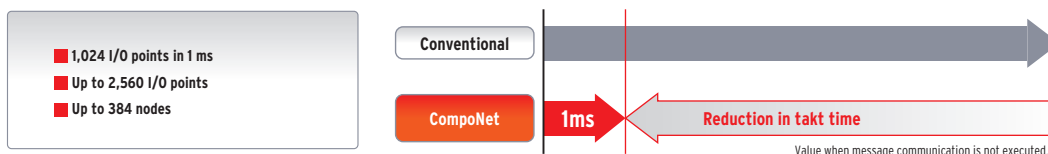

Fast Communication Technology even at Low Baud Rate of 4 Mbps

Provides excellent performance in applications with large numbers of control points and also in expansion work.

Efficient multicast transmission enables stable and fast communication even when the number of slaves increases.

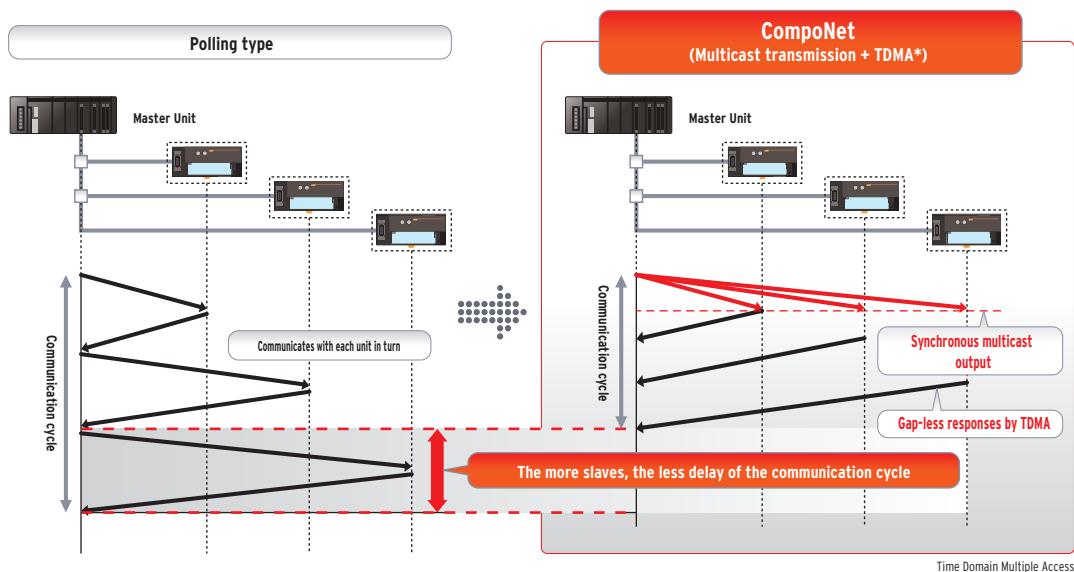

Advantage of high-speed CompoNet technology

1 Fast communication is maintained even with an increased number of control points.

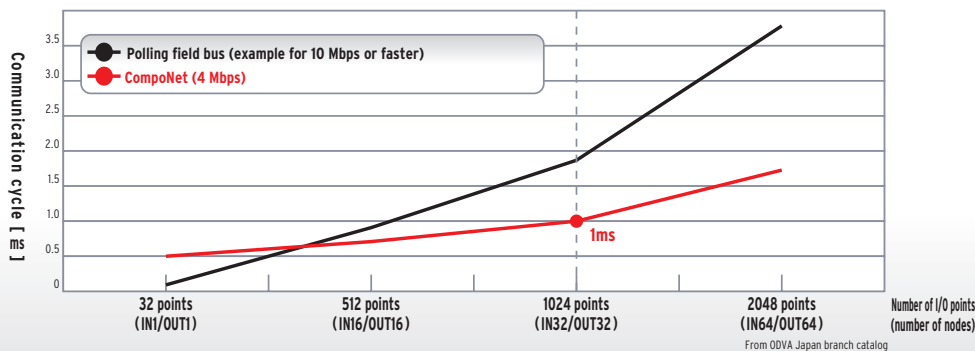

- 2 Easier wiring (branching is possible even in fast mode)
- 3 Low-cost Round cables can be used.
- 4 High resistance to noise.

Wiring

Superior branching adaptability reduces wiring work

Flexible Installation

Select the best branching method for your application.

CompoNet provides both fast communication and easy wiring. Branch wiring is a powerful tool for installing large numbers of slaves in a variety of locations. You can optimize your cable layout to match the layout of your equipment.

Distance can easily be extended.

A maximum distance of 1500 m is possible (when baud rate is 93.75 kbps).

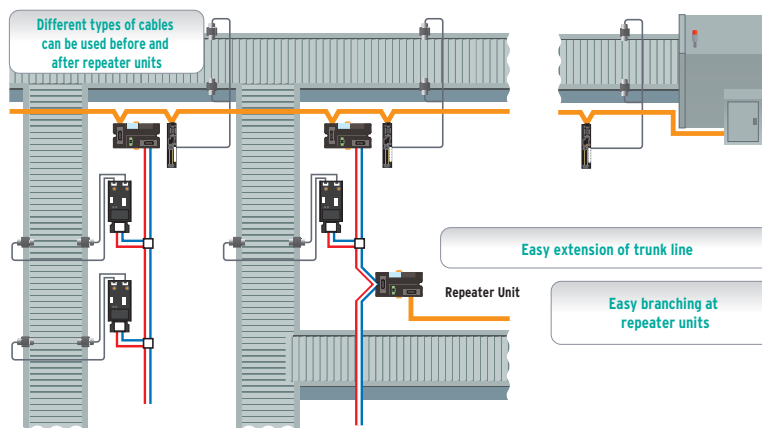

Select the best branching method for your application



Flat Connector Socket + Fat Connector Plug



Multidrop Type



Repeater Unit

Different types of cables can be mixed.

Long distance: Eliminating need for special cables reduces cost
Inside devices: Use of flat cable facilitates wiring

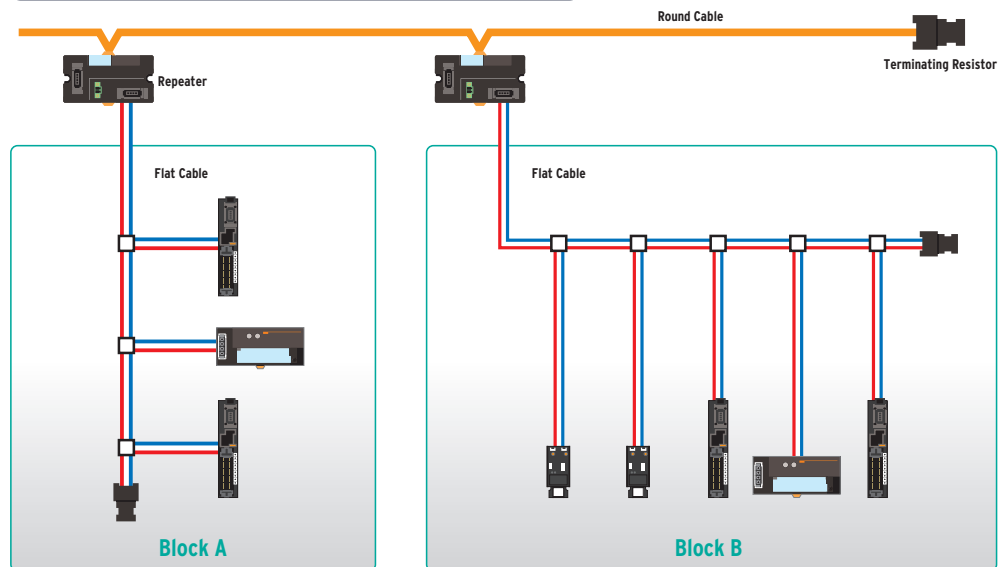

Informatization Reducing the start-up time and maintenance work with informatization

CX-Integrator Makes Start-Up and Recovery Work More Efficient

CX-Integrator software lets you set the PLC network/serial communication system configuration from a computer. CX-Integrator makes it easy to handle CompoNet assignment, parameter setting, connection state monitoring, comment setting, network diagnosis, etc. from a computer.

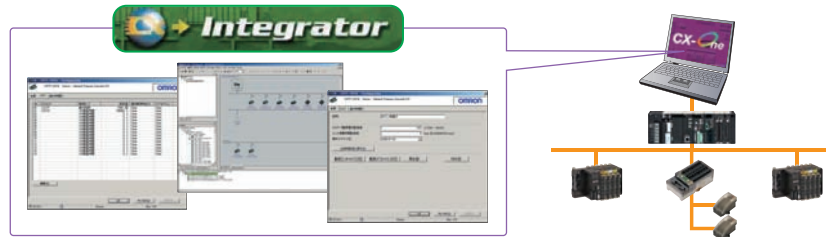

Quick discovery of error locations

You can easily check the connection states of all the slaves and quickly specify error contents. You can check errors not only with tools but also with the master LED (7-segment display). This helps make on-site recovery work more efficient.

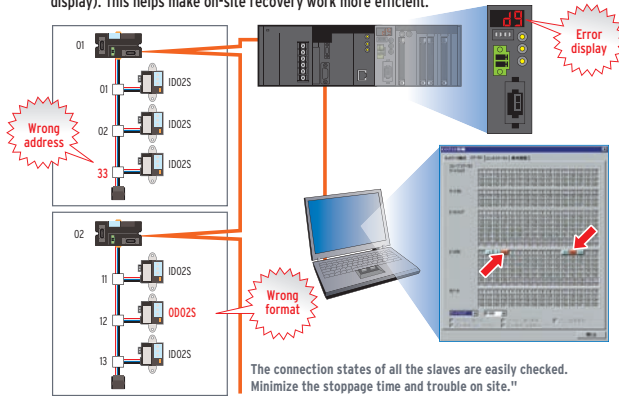

Separate an error at a branch destination

When you use a repeater unit, you can display the slaves in each segment and can separate any error beyond the repeater.

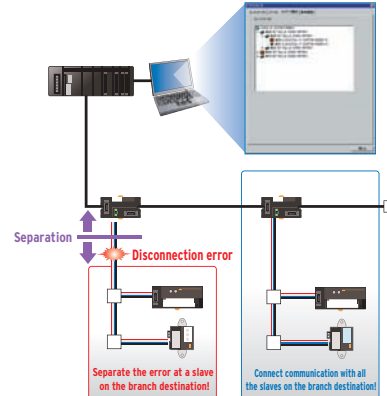

Informatization of the all Equipment

Smart features are features of the slave main units that collect a variety information used for from start-up to maintenance. Monitor network power supply voltage with tools and display units. Slaves collect a variety of information helpful for preventive maintenance and detect errors in connected equipment before problems occur. No need to write a program for monitoring.

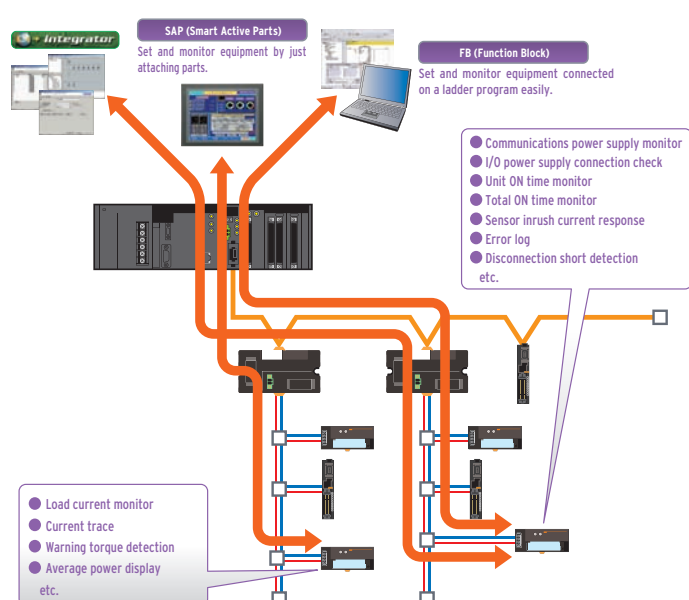

Example: Operation time monitor

Slave units collect data on the machine operation time and operation change amount, so you can monitor without increasing the load between controllers.

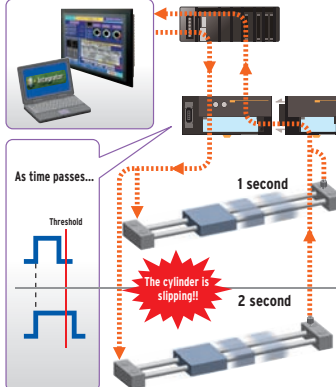





The slave unit counts the machine's ON/OFF repetitions and total operation time to let you know when it is time for maintenance. (Contact operation monitor)

Simple and Low-Cost Slashes start-up workload and equipment cost!

Flat Cable for Easy One-Touch Installation



Flat cable shortens installation time.
It also prevents connector installation mistakes.

- Shield cable for field networks**
- 1  Peel away the cable coating.
 - 2  Take out the shield wire.
 - 3  Peel away the lead coating.
 - 4  Attach the 5 crimp terminals.
 - 5  Insert the cable and fasten with 5 screws.



Flat cable

Slashes installation work to 1/30 of the required time!

- 1 Insert the cable into the connector. 
- 2 Snap fit with tool. **Snap** 

Smooth Start-Up with Simple Setup

Just set the master baud rate and the slave node addresses and the system is ready for start-up.
The slave baud rate is automatically set to match the master unit baud rate.
The allocation areas are automatically set by the node addresses.

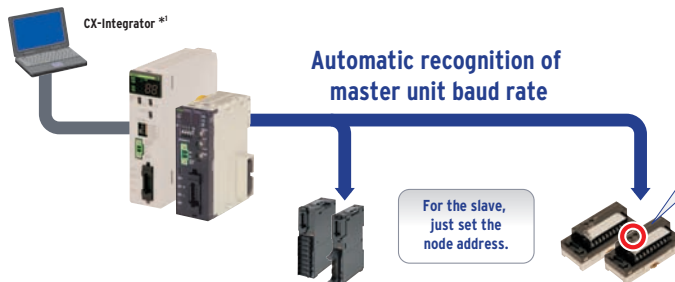

*1. Using CX-Integrator makes detailed settings and monitoring possible.

Rotary switch used
Easy-to-understand decimal switch

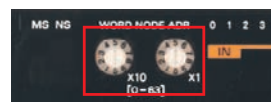

Reduces setting mistakes.



DIP Switch (hexadecimal)

Can Use Regular Round Cables for Fast Communication

Regular round cables can be used as the communication cables.

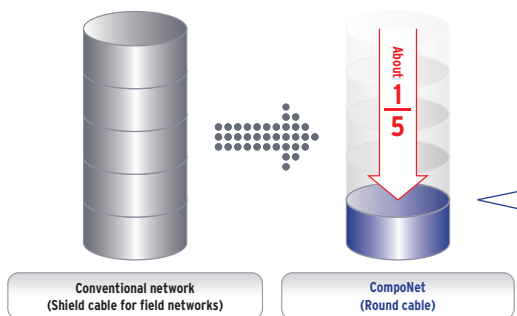

- Round Cable**
- Can use regular cables that are inexpensive and easy to find.
 - Uses round cables (4-wire) to supply power to the slave units.
 - Can also use regular highly flexible cables and oil-resistant cables.
 - When communication power is supplied to the slaves, round cables (2-wire) can also be used.

* Use round cables that comply with ODVA specifications.

Bit-level distribution for effective I/O installation

Bit slaves enable optimum I/O configuration and wiring becomes more efficient.

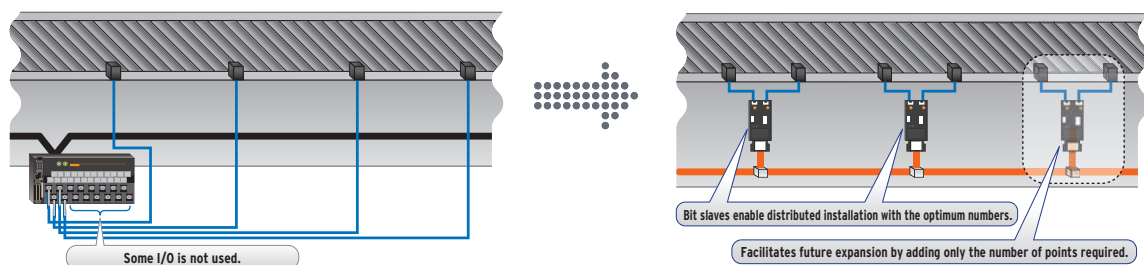

Network Specifications



CompoNet is made up of segments divided by repeater unit.

There are four CompoNet baud rates, from 4 Mbps ultra-fast mode to 93.75 kbps long-distance mode. The wiring specifications depend on the baud rate. Select the one that best matches your application.

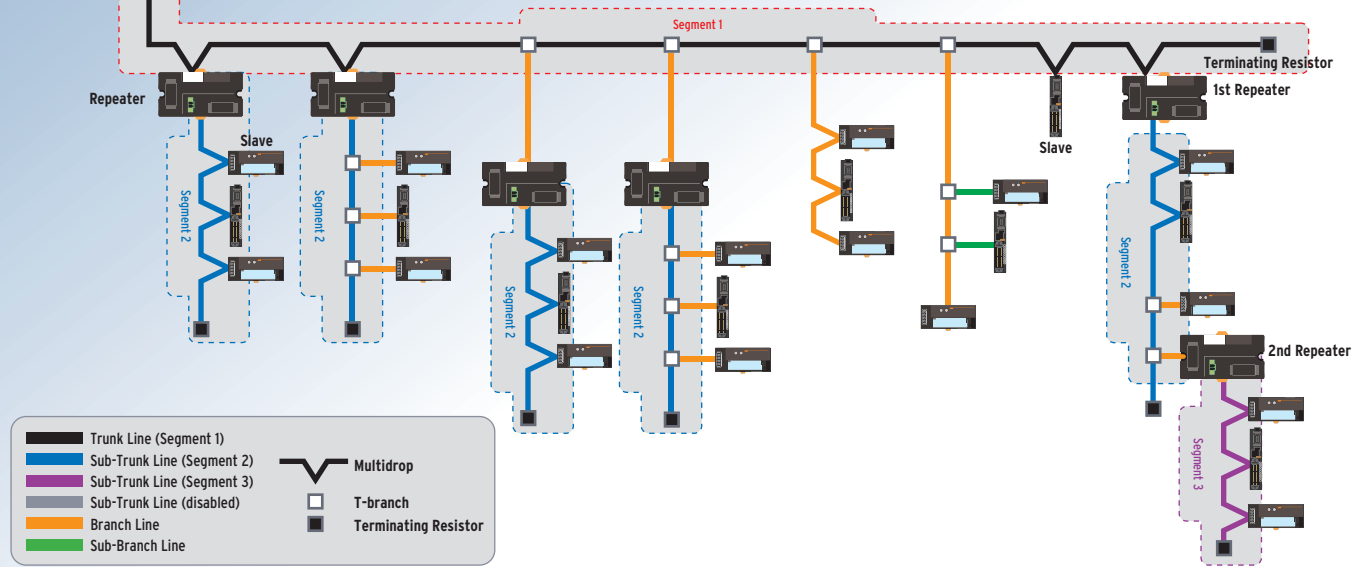

Baud rate	Cable type	Trunk line and sub-trunk line length (When 2 repeaters are used.)	Number of slaves per segment (Including number of repeaters)	Branch line length	Total branch line length per segment	Branch location restrictions	Number of slaves per branch line	Sub-branch line length	Total sub-branch line length per segment
4Mbps	Round cable I, II Flat cable I	30m (90m)	32	—	—	—	—	—	—
3Mbps	Round cable I, II Flat cable I	30m (90m)	32	0.5m	8m	3/meter	1	—	—
1.5Mbps	Round cable I	Without branches	100m (300m)	—	—	—	—	—	—
		With branches	30m (90m)	32	2.5m	25m	3/meter	3	—
93.75kbps	Round cable II	30m (90m)	32	2.5m	25m	3/meter	3	0.1m	2m
	Flat cable I	500m (1500m)	32	6m	120m	3/meter	1	—	—
		200m (600m)	32	200 meter free wiring total wire length per segment					

Relation between Baud Rate and Communications Cable

The Cable that can be used and the required baud rates are automatically determined by whether a trunk line-branch line formation or an unrestricted wiring formation is used.

Cable type	Baud rate			
	4Mbps	3Mbps	1.5Mbps	93.75kbps
Round cable I	Trunk line-branch line wiring formation (See note 1.)	Trunk line-branch line wiring formation	Trunk line-branch line wiring formation	Trunk line-branch line wiring formation
Round cable II				Unrestricted wiring formation
Flat cable I				Unrestricted wiring formation

Note: (1) If a baud rate of 4 Mbps is used, branching is not possible from the trunk line. (Only multidrop connections are possible.)

The following table shows the conditions and restrictions for each formation.

Item	Wiring formation	
	Trunk line-branch line formation	Unrestricted wiring formation
Master Unit location	End of network	Anywhere in network (not necessarily at the end)
Maximum number of Slave Units connected to any one branch line	1 or 3 depending on the cable type and baud rate	No restrictions
Terminating Resistor location	On the opposite ends of the trunk line and all sub-trunk lines from the Master Unit and each Repeater Unit	On the most remote ends from the Master Unit and each Repeater Unit

Example of wiring for 4Mbps (Application: Ultra-fast communications)

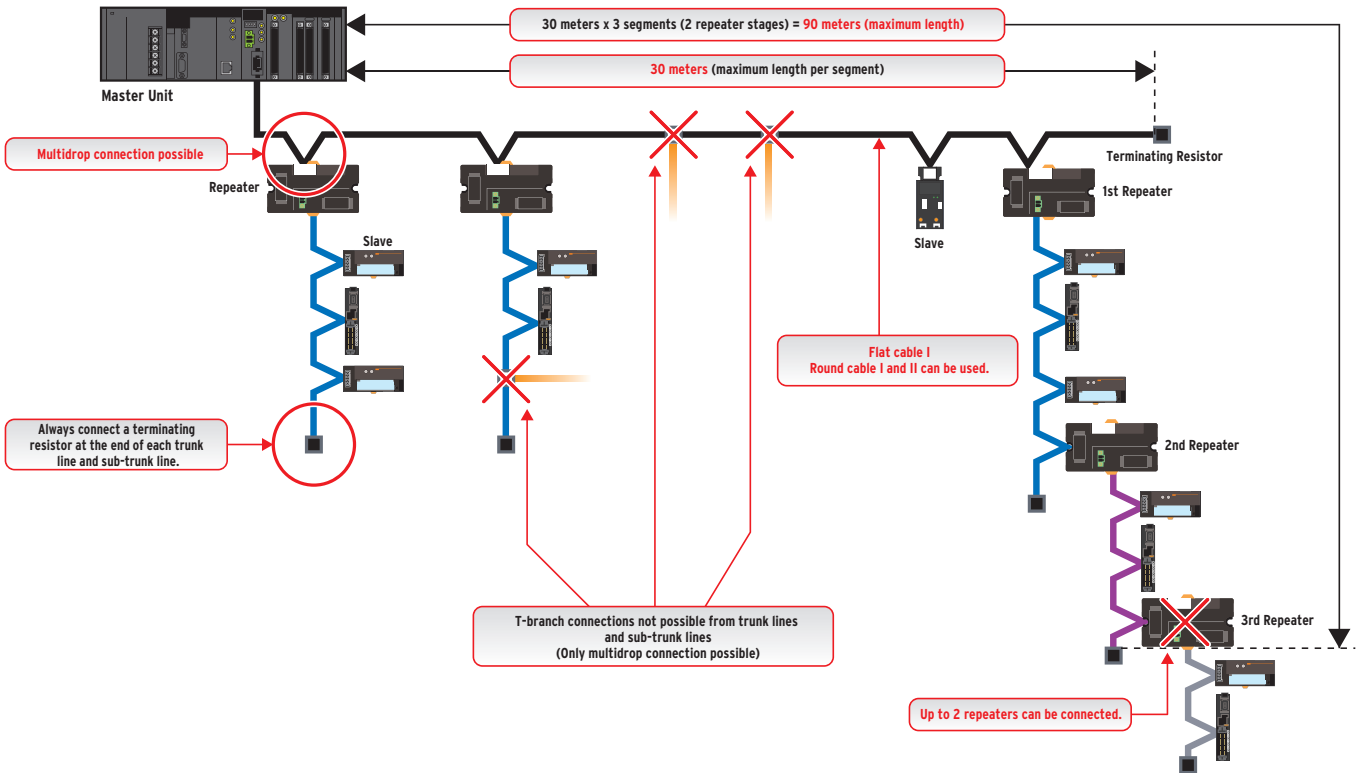

Example of wiring for 3Mbps (Application: Fast communications with branching)

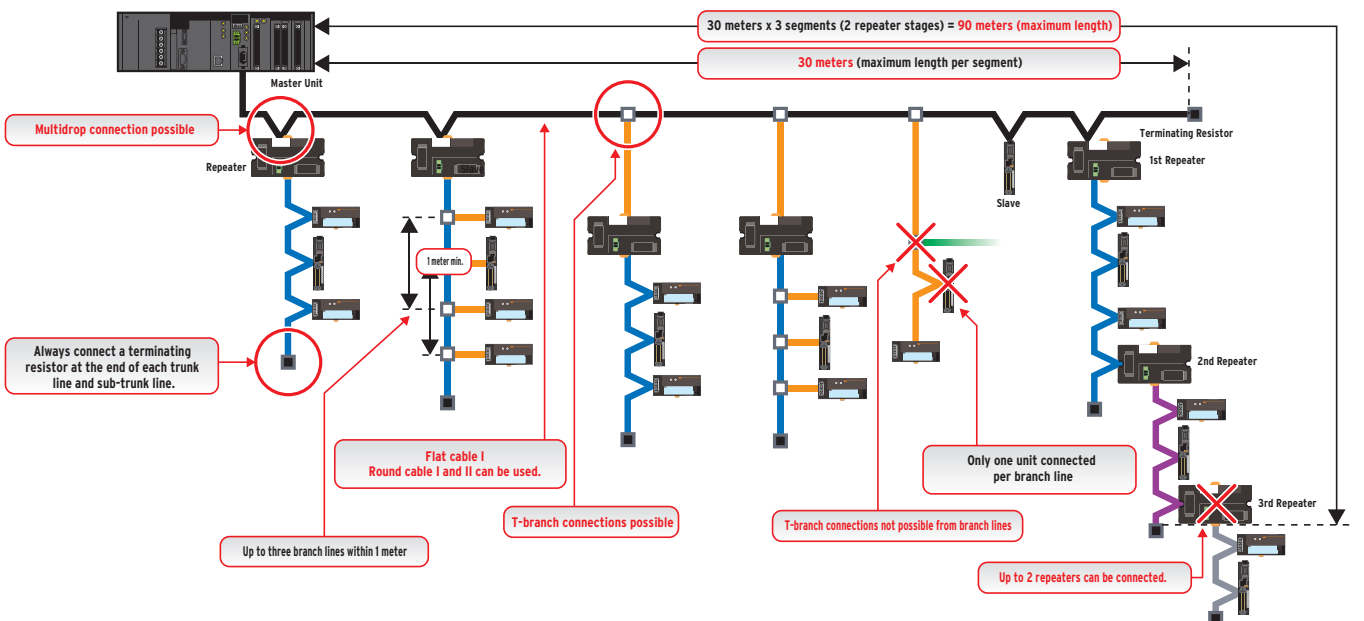

Network Specifications

Example of wiring for 1.5 Mbps (Application: Balance of fast communications and branching)

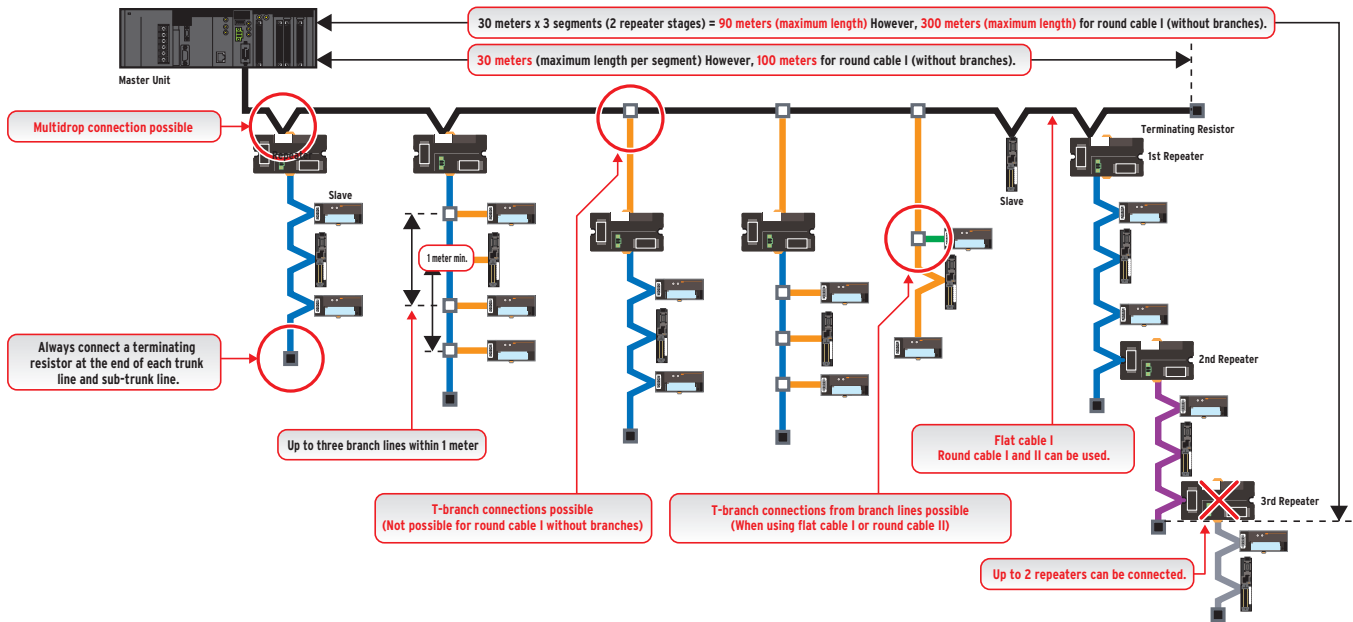

Example of wiring for 93.75 kbps (Application: Long-distance wiring and free wiring)

Example using round cable I

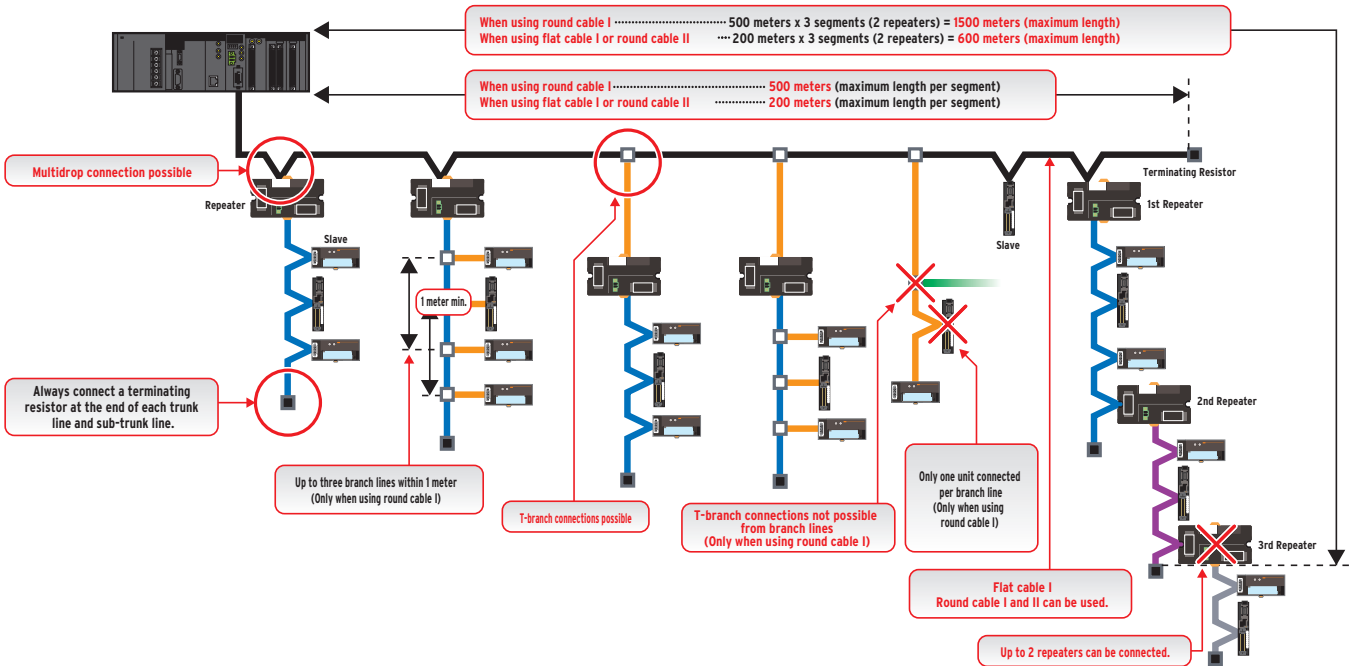

Free wiring when using flat cable I or round cable II

With this wiring formation, there is no distinction between the trunk line and branch lines. There are no wiring restrictions as long as the total cable length does not exceed 200 m. There is also no limit in the number of branches.

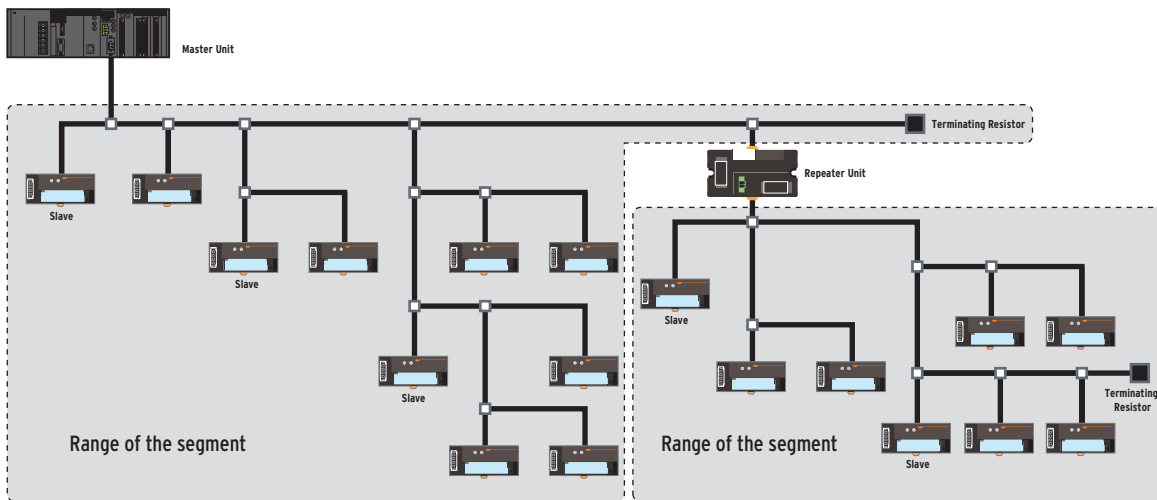

Configuration Examples and Peripheral Devices

Example with round cable I (2-wire)

Required peripheral equipment

Specification	Model	Number of units	Remarks
Open connector (for unit connection)	DCN4-TB4	3	
Open connector (for unit connection) (Honda Tsushin Kogyo Co.,Ltd.) *1	HCN-TB4LMZG+	1	For connecting Bit Slave unit with compact connectors
Compact connector*3		2	
Terminating resistor	DRS1-T	1	
Round cable I (2-wire)		1	Commercially available
Communications power supply		1	24 VDC
I/O power supply		1	24 VDC

For a bit slave, the current consumed by external I/O (sensors and actuators) is supplied (via flat cable I (without sheath)) from the communications power supply, the same as the current consumed for the communication power supply.

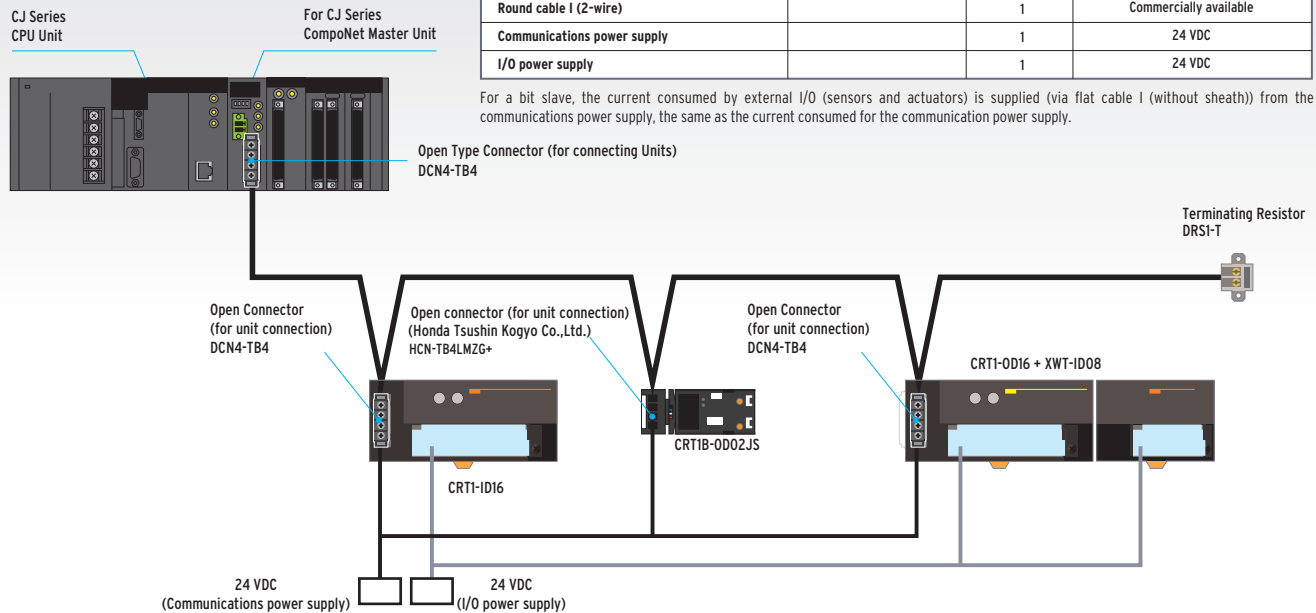

Example with round cable II (4-wire)

Required peripheral equipment

Specification	Model	Number of units	Remarks
Open connector (for unit connection)	DCN4-TB4	3	
Open connector (for unit connection) (Honda Tsushin Kogyo Co.,Ltd.) *1	HCN-TB4LMZG+	1	For connecting Bit Slave unit with compact connectors
Fiat connector socket	DCN4-TR4	1	For terminating resistor connection
Compact connector*3		2	
Terminating resistor	DCN4-TM4	1	
Round cable (4-wire)		1	Commercially available
Special tool	DWT-A01	1	
Communications power supply		1	24 VDC
I/O power supply		1	24 VDC

For a bit slave, the current consumed by external I/O (sensors and actuators) is supplied (via Round cable II) from the communications power supply connected to the master unit or repeater unit, the same as the current consumed for the communication power supply.

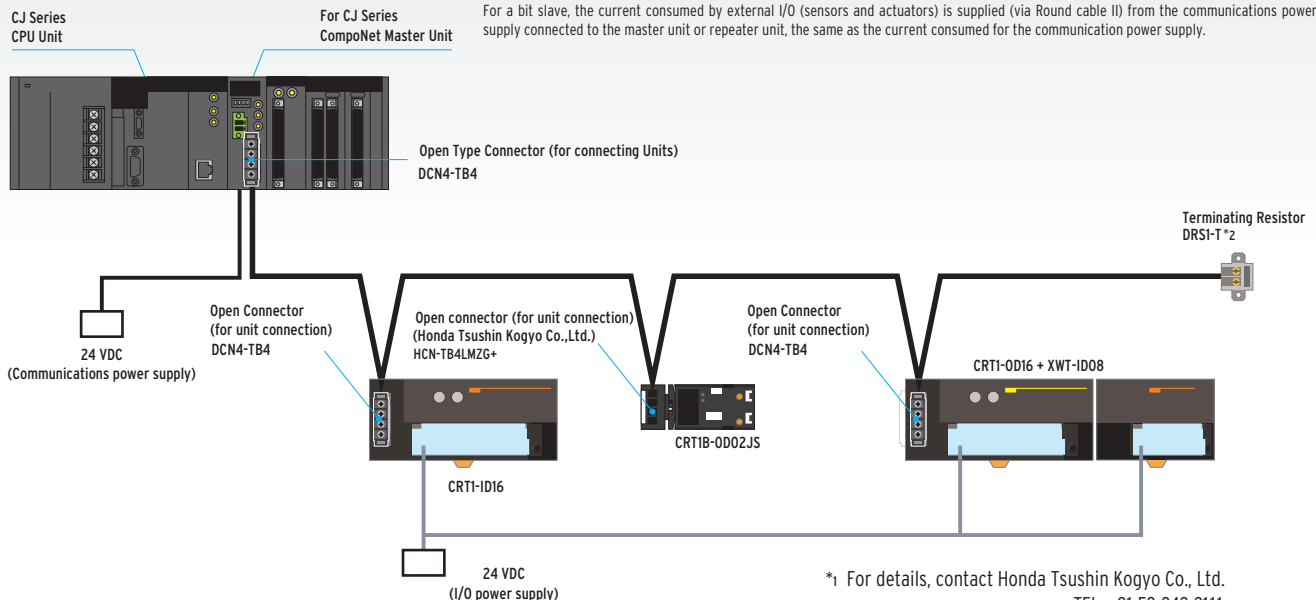

*1 For details, contact Honda Tsushin Kogyo Co., Ltd.
TEL: +81-52-242-2111

*2 Wire the two signal lines with the terminating resistor. Insulate the power lines using tape or other insulating materials.

Example with flat cable I (without sheath)

Required peripheral equipment

Specification	Model	Number of units	Remarks
Flat connector socket	DCN4-TR4	5	
Flat connector plug	DCN4-BR4	10	
Multidrop connector	DCN4-MD4	1	For connecting repeater units
Multidrop connector plug	DCN4-MR4	1	For connecting Bit Slave unit with compact connectors
Compact connector*3		4	
Terminating resistor	DCN4-TM4	2	
Flat cable I (without sheath)	DCA4-4F10	1	Units of 100 meters
Special tool	DWT-A01	1	
Communications power supply		2	24 VDC
I/O power supply		1	24 VDC

For a bit slave, the current consumed by external I/O (sensors and actuators) is supplied (via flat cable I (without sheath)) from the communications power supply connected to the master unit or repeater unit, the same as the current consumed for the communication power supply.

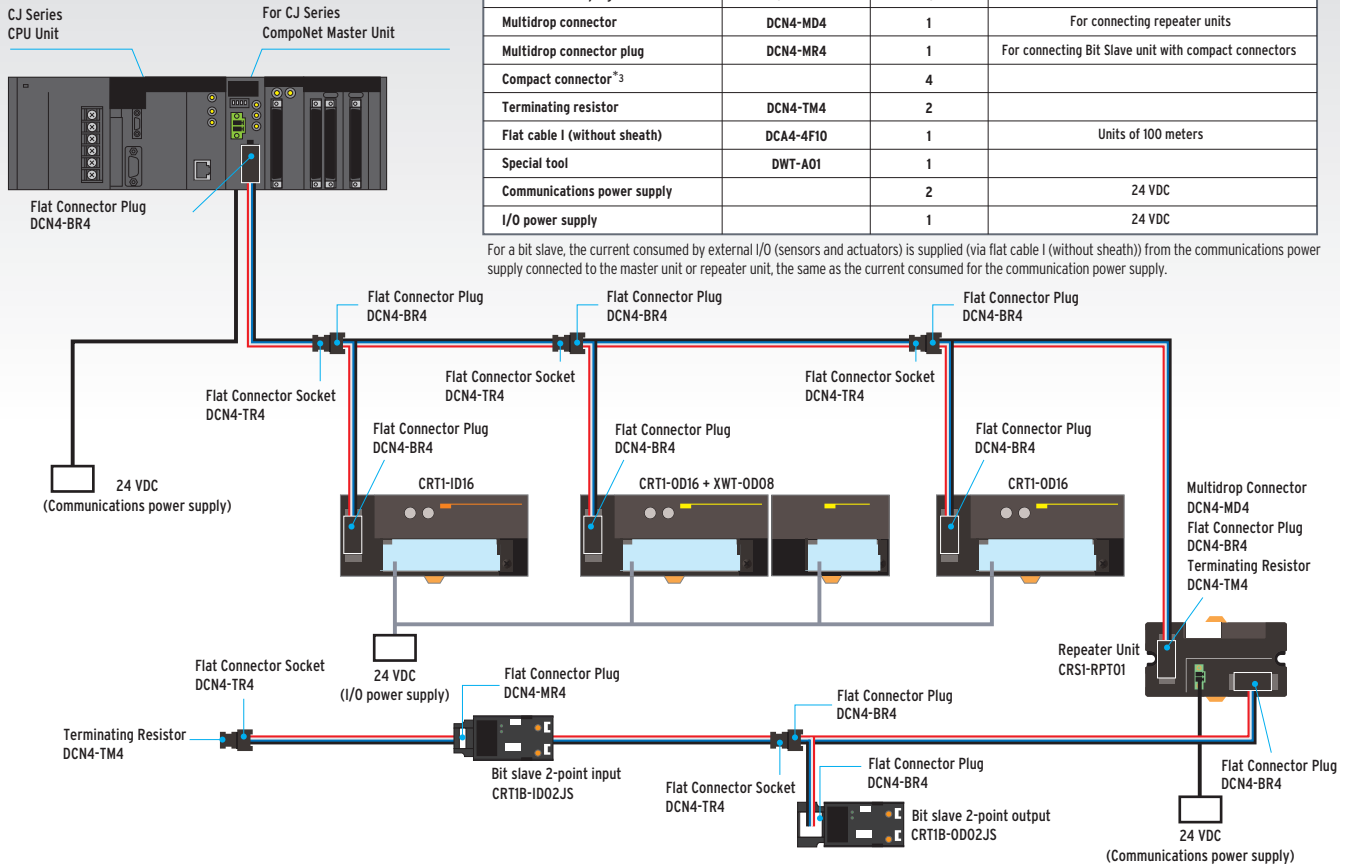

*3 Compact Connectors

The compact connectors use XA-series Connectors from JST Mfg. Co., Ltd. Special cable connectors must be attached for cables connecting to external devices if a Slave Unit with Compact Connectors is used.

Name	Applicable cable range			Model	Crimping Tool	
	mm ²	AWG#	Wire sheath external diameter			
Contacts	Loose terminal	0.08 to 0.33	28 to 22	1.2 to 1.9	BXA-001T-P0.6	YC-692R
	Chain terminal				SXA-001T-P0.6	YRS-692
	Loose terminal	0.22 to 0.5	24 to 20	1.5 to 1.9	BXA-01T-P0.6	YC-701R
	Chain terminal				SXA-01T-P0.6	YRS-701
Housing	—			XAP-03V-1	—	

Note (1) Automated Crimp Tools are also available. For details, contact the manufacturer.
 (2) For information on the processing procedure, refer to the instruction manual included with the tool or contact the manufacturer (JST Mfg. Co., Ltd.).

CompoNet Applications for Every Type of Manufacturing Site

These applications offer high-performance communication and superior installability that aid in reducing takt times and cutting down the work of start-up and maintenance. Customers use CompoNet in a wide variety of applications.

Transfer lines

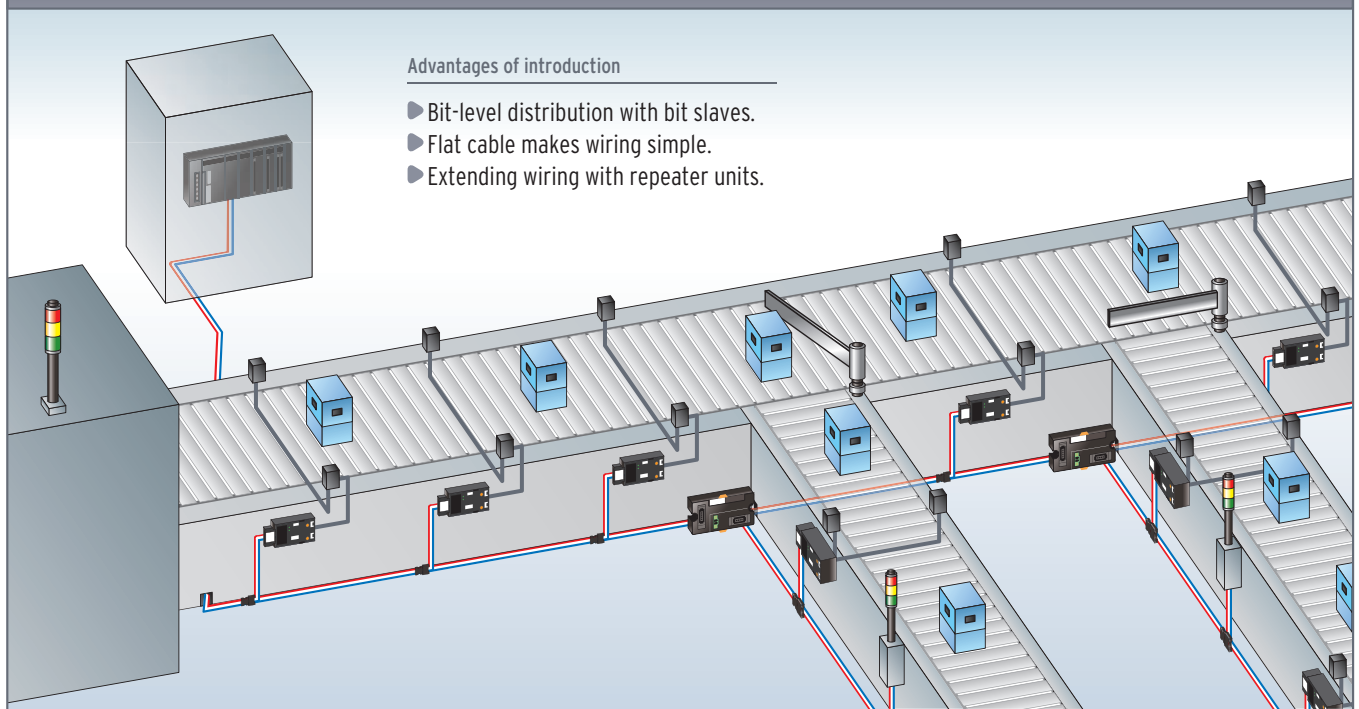

Electronic parts manufacturing machine

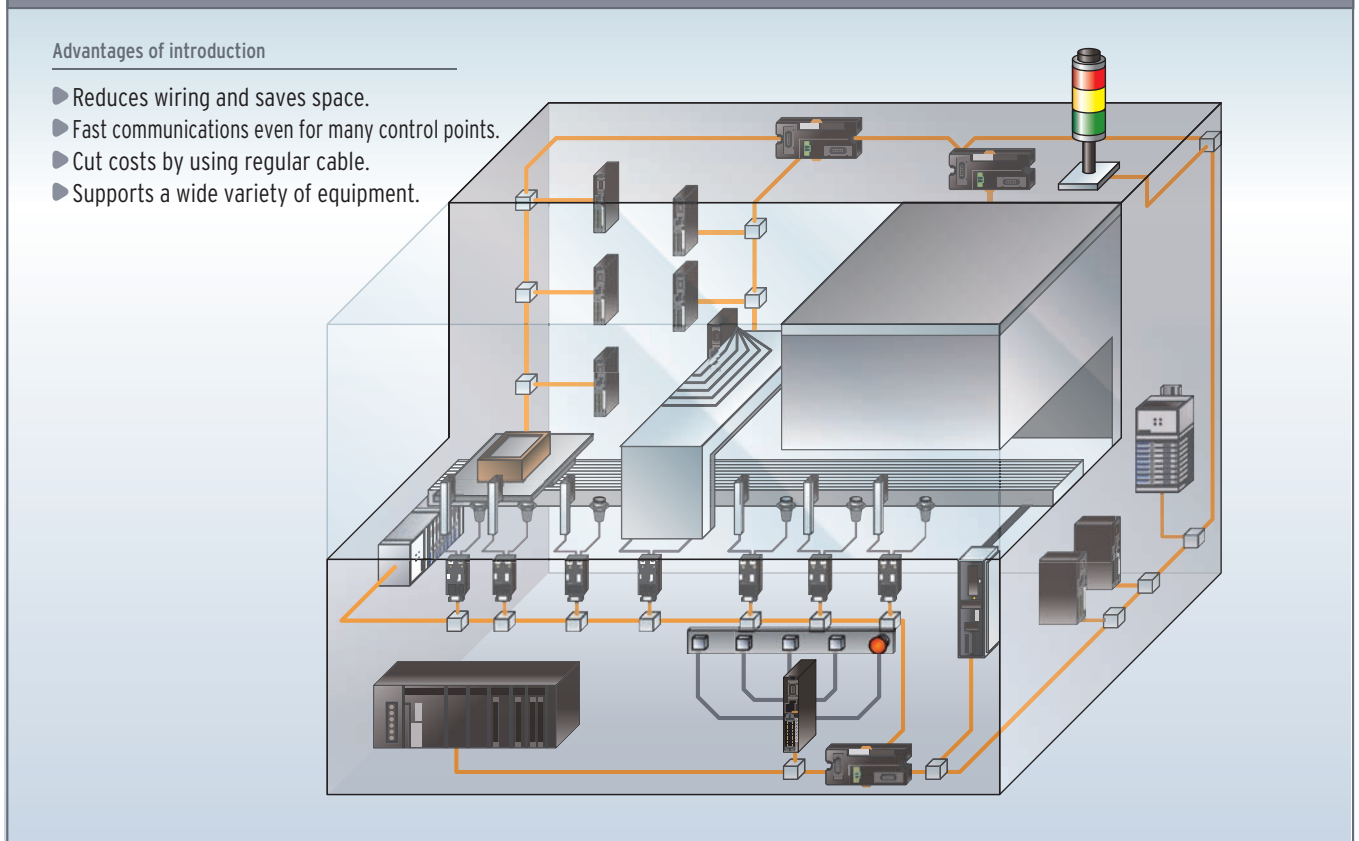

Building automation

Advantages of introduction

- ▶ Wiring distance up to 1500 meters.
- ▶ Round cables can be used.
- ▶ Plenty of connection capacity even for distributed installation.
- ▶ High resistance to noise.

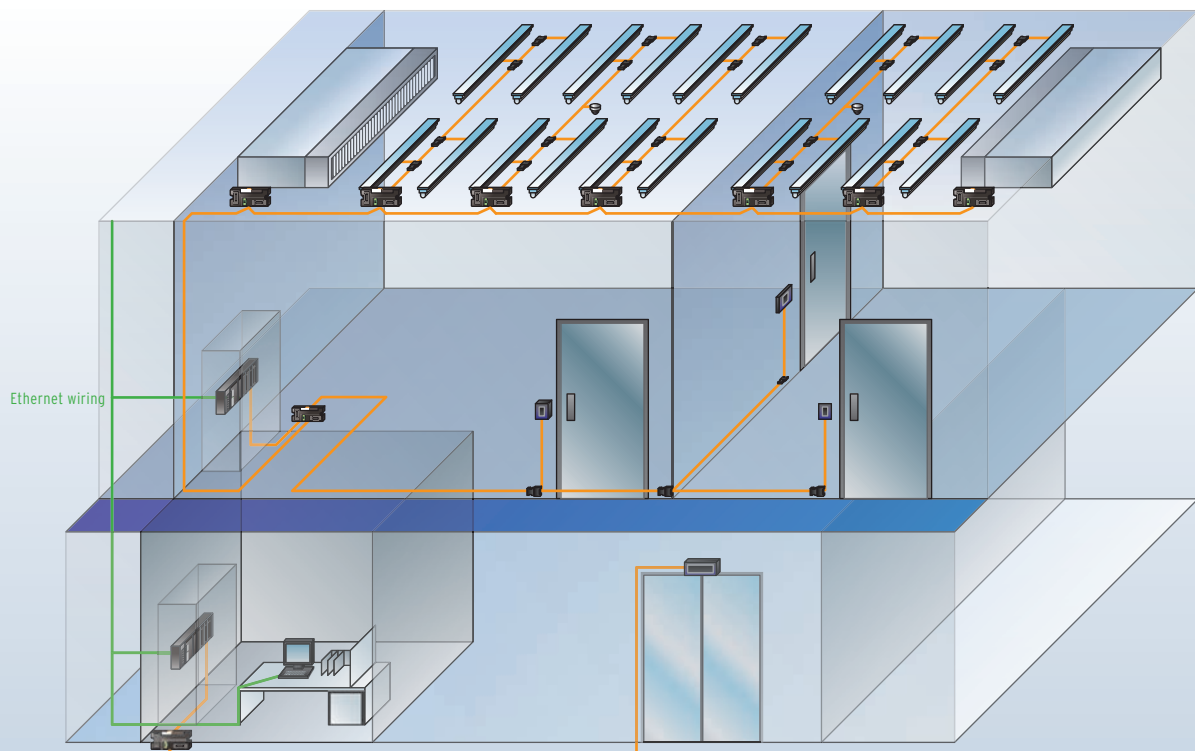

CompoNet allows high speed communications and bit-level distribution. It is usable by various applications.

Preprocess machines for semi-conductors

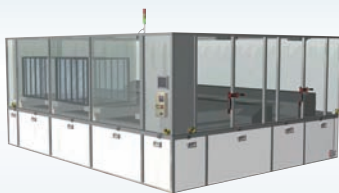

Post-process machines for semi-conductors

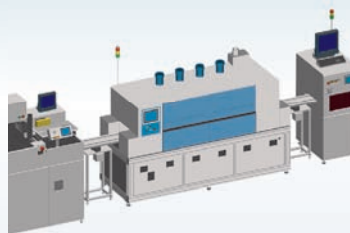

Food processing machines

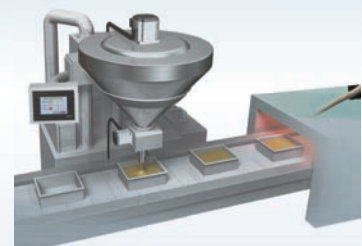

Automatic warehouse



Robots

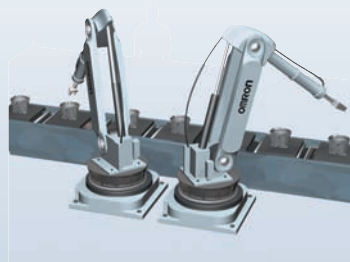

Packaging machines



Master Units

Master Units



■ CJ Series
CJ1W-CRM21



■ CS Series
CS1W-CRM21



■ Master Board
3G8F7-CRM21
3G8F8-CRM21

Gateway Unit

Gateway Unit



GQ-CRM21

Word Slaves

Digital I/O Slaves

Two-tire Screw Terminal Block



■ Input Unit
CRTI-ID08(-1)
CRTI-ID16(-1)
■ Output Unit
CRTI-OD08(-1)
CRTI-OD16(-1)
■ Input/Output Unit
CRTI-MD16(-1)

Screw-Type Terminal Block, Relay Output/SSR Output



■ Relay Outputs
CRTI-ROS08
CRTI-ROS16
■ SSR Outputs
CRTI-ROF08
CRTI-ROF16

Three-tire Screw Terminal Block

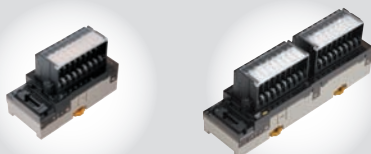

■ Input Units
CRTI-ID08TA(-1)
CRTI-ID08TAH(-1)
CRTI-ID16TA(-1)
CRTI-ID16TAH(-1)

■ Output Units
CRTI-OD08TA(-1)
CRTI-OD08TAH(-1)
CRTI-OD16TA(-1)
CRTI-OD16TAH(-1)

■ I/O Unit
CRTI-MD16TA(-1)
CRTI-MD16TAH(-1)

E-CON Connectors



■ Input Units
CRTI-ID16S(-1)
CRTI-ID16SH(-1)
CRTI-ID32S(-1)
CRTI-ID32SH(-1)
■ Output Units
CRTI-OD16S(-1)
CRTI-OD16SH(-1)
CRTI-OD32S(-1)
CRTI-OD32SH(-1)

■ I/O Unit
CRTI-MD16S(-1)
CRTI-MD16SH(-1)
CRTI-MD32S(-1)
CRTI-MD32SH(-1)

Vertical Slaves with e-CON Connectors



CRTI-VID08S(-1)
CRTI-VOD08S(-1)

Vertical Slaves with MIL Connectors



CRTI-VID16ML(-1)
CRTI-VOD16ML(-1)



CRTI-VID32ML(-1)
CRTI-VOD32ML(-1)
CRTI-VMD32ML(-1)

Horizontal Slaves with Clamp Terminals

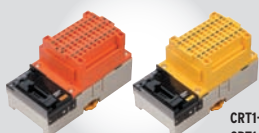

CRTI-ID08SL(-1)
CRTI-OD08SL(-1)

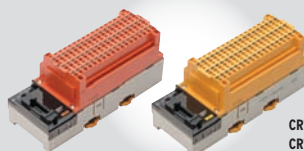

CRTI-ID16SL(-1)
CRTI-OD16SL(-1)

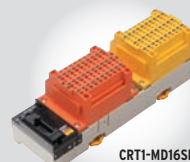

CRTI-MD16SL(-1)

Analog I/O Slaves

Screw Terminal Block

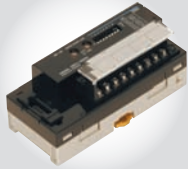

- Analog Input Unit
CRTI-AD04
- Analog Output Unit
CRTI-DA02

Vertical Slaves with e-CON Connectors



CRTI-VAD04S
CRTI-VDA02S

Numerical Indicator Type
CRTI-VAD02SD
CRTI-VDA02SD



Vertical Slaves with MIL Connectors



CRTI-VAD04ML
CRTI-VDA02ML

Numerical Indicator Type
CRTI-VAD02MLD
CRTI-VDA02MLD



Word Slaves

Temperature Input Slaves



- Input Units
CRTI-TS04T
CRTI-TS04P

Expansion Units



- Input Units XWT-ID08(-1)
XWT-ID16(-1)
- Output Units XWT-OD08(-1)
XWT-OD16(-1)



- Output Units XWT-VDD08S(-1)
XWT-VDD16ML(-1)
- Input/Output Units XWT-VMD08S(-1)
XWT-VMD16ML(-1)

SmartSlice GRT1 Series

CompoNet Communications Unit



GRTI-CRT

SmartSlice I/O Units



GRTI-ID4(-1)
GRTI-OD4(-1)
GRTI-ID8(-1)
GRTI-OD8(-1)
GRTI-ROS2
GRTI-IA4-1
GRTI-IA4-2
GRTI-AD2
GRTI-DA2C
GRTI-DA2V
GRTI-TS2P
GRTI-TS2PK
GRTI-TS2T
GRTI-CTI(-1)

Bit Slaves

Compact Connector Type

Compact Connector Type



- Input Unit
CRTIB-ID02JS(-1)
- Output Unit
CRTIB-OD02JS(-1)
- Input/Output Unit
CRTIB-MD02JS(-1)



- Input Unit
CRTIB-ID04JS(-1)
- Output Unit
CRTIB-OD04JS(-1)
- Input/Output Unit
CRTIB-MD04JS(-1)

e-CON Connector Type

e-CON Connector Type



- Input Unit (IP20 compliant)
CRTIB-ID02S(-1)
- Output Unit (IP20 compliant)
CRTIB-OD02S(-1)

Repeater Unit

Repeater Unit



CRS1-RPT01

Sensor Communications Unit

Sensor Communications Unit



ZS-CRT



E3X-CRT

Multi-function Compact Inverter MX2-Series CompoNet Communication Unit



NEW
3G3AX-MX2-CRT-E

The CompoNet network lets you connect to units and branch and extend cables by just mounting connectors on communications cables and units. The cable connection and branching methods depend on the cable type and branching form.

■ Four types of cable can be used on CompoNet networks.

- Round cable I (2-wire), commercially available
- Round cable II (4-wire), commercially available
- Flat cable I (without sheath) DCA4-4F10

■ The terminating resistors, connectors, and special tools depend on the cable type.

Cable type	Unit connection and branching connector		Terminating resistor	Tool
Round Cable I (2-wire) <p>Commercially available</p>	<p>■ Open Type Connector (For connecting Units) DCN4-TB4*1</p>	<p>■ Open Type Connector (For connecting Units) HCN4-TBLMZG+ (Honda Tsushin Kogyo Co.,Ltd.)</p>	<p>■ Terminating Resistor DRS1-T</p>	
Round Cable II (4-wire) <p>Commercially available</p>	<p>■ Open Type Connector (For connecting Units) DCN4-TB4*1</p>	<p>■ Open Type Connector (For connecting Units) HCN4-TBLMZG+ (Honda Tsushin Kogyo Co.,Ltd.)</p>	<p>■ Terminating Resistor DRS1-T</p> <p>■ Terminating Resistor DCN4-TM4</p> <p>■ Flat Connector Socket DCN4-TR4</p> <p>Mount the terminating resistor (DCN4-TM4) in the flat connector socket (DCN4-TR4) already mounted on the cable.</p>	<p>■ Special Tool For flat cable I (without sheath) DWT-A01</p>
Flat Cable I (without sheath) <p>DCA4-4F10</p>	<p>■ Flat Connector Socket DCN4-TR4</p> <p>■ Multidrop Connector DCN4-MD4*2</p>	<p>■ Flat Connector Plug DCN4-BR4</p> <p>■ Multidrop Connector Plug DCN4-MR4*2</p>	<p>■ Terminating Resistor DCN4-TM4</p>	<p>■ Special Tool For flat cable I (without sheath) DWT-A01</p>

*1 Open Type Connectors (DCN4-TB4) are not connectable with Bit Slave Units whose connectors are small. Use connectors made by Honda Tsushin Kogyo instead.

*2 Multidrop Connectors (DCN4-MD4) are not connectable with Bit Slave Units with Compact Connectors. Use Multidrop Connector Plugs (DCN4-MR4) instead.

Compact Connectors

The compact connectors use XA-series Connectors from JST Mfg. Co., Ltd. Special cable connectors must be attached for cables connecting to external devices if a Slave Unit with Compact Connectors is used.



Name	Applicable cable range			Model	Crimping Tool	
	mm ²	AWG#	Wire sheath external diameter			
Contacts	Loose terminal	0.08 to 0.33	28 to 22	1.2 to 1.9	BXA-001T-P0.6	YC-692R
	Chain terminal				SXA-001T-P0.6	YRS-692
	Loose terminal	0.22 to 0.5	24 to 20	1.5 to 1.9	BXA-01T-P0.6	YC-701R
	Chain terminal				SXA-01T-P0.6	YRS-701
Housing	—	—	—	XAP-03V-1	—	

Note (1) Automated Crimp Tools are also available. For details, contact the manufacturer.
(2) For information on the processing procedure, refer to the instruction manual included with the tool or contact the manufacturer (JST Mfg. Co., Ltd.).

Comparison of Specifications with DeviceNet

Reference data

This table compares CompoNet and DeviceNet specifications.
Select the one that matches your applications and uses.

		
Features	Bit-level distribution High speed, multiple nodes, superior branching, low cost	High-capacity I/O data communication for multiple points and multiple channels
Maximum baud rate	4 Mbps (1024 points/1 ms)	500 kbps (1024 points/12.6 ms *)
Communication medium	<ul style="list-style-type: none"> ■ Round cable I (2-wire 0.75 mm²) ■ Round cable II (4-wire 0.75 mm²) ■ Special flat cable I (4-wire, without sheath) 	<ul style="list-style-type: none"> ■ Special thick cable (5-wire) ■ Special thin cable (5-wire) ■ Special flat cable (4-wire)
Maximum communication distance	1500 m (for 93.75 kbps with repeaters and round cable I)	500 m (for 125 kbps with special thick 5-wire cable)
Maximum number of nodes connected	<ul style="list-style-type: none"> ■ Word slave unit: 64 input units/64 output units ■ Bit slave unit: 128 input units/128 output units ■ Repeater unit: 64 units 	64 units (including master, slaves and configurator)
Maximum number of I/O points	<ul style="list-style-type: none"> ■ Word slave unit: 1024 inputs and 1024 outputs (2048 I/O points total) ■ Bit slave unit: 256 inputs and 256 outputs (512 I/O points total) 	32000 points (When using CS1W-DRM21-V1/CJ1W-DRM21)
Safety support	None	Yes (DeviceNet Safety)

* This chart reflects the theoretical values for the CJ1 series master unit so refer to them as approximated values.

Master	<p>YASKAWA ELECTRIC CORPORATION</p> <p>+81-4-2962-5823 www.e-mechatronics.com</p>		<p>265IF-01(CompoNet Master Communication Module) [JAPMC-CM2390-E]</p>	<p>Features</p> <ol style="list-style-type: none"> 265IF-01 can be connected to the abundant slave group as a CompoNet master. 265IF-01 is attached to the optional slot of the MP2000 series controller.
	Slave	<p>Hilscher GmbH</p> <p>Europe Hilscher GmbH (Germany) Tel: +49-(0)-6190-9907-0 North America Hilscher North America, Inc. (USA) Tel: +1-630-505-5301 Asia-Pacific Hilscher GmbH (Germany) Tel: +49-(0)-6190-9907-0 China Hilscher GmbH (Shanghai Rep. Office) Tel: +86-(0)-21-6355-5161 India Tel: +91-(0)-11-4051-5640</p> <p>info@hilscher.com Overseas sales areas: Europe, North America, Asia-Pacific, China, Other</p>		<p>CompoNet Slave PCI card [C1FX 50-CP5]</p>
Inverter		<p>YASKAWA ELECTRIC CORPORATION</p> <p>+81-930-25-2548 www.e-mechatronics.com</p> <p>Overseas sales areas: Europe YASKAWA ELECTRIC EUROPE GmbH Tel:+49-6196-569-300 North America YASKAWA ELECTRIC AMERICA, INC. Tel:+1-847-887-7000 Asia-Pacific YASKAWA ELECTRIC KOREA CORPORATION Tel:+82-2-784-7844 YASKAWA ELECTRIC (SINGAPORE) PTE.LTD. Tel:+65-6282-3003 China YASKAWA ELECTRIC (SHANGHAI) CO.,LTD. +86-21-5385-2200</p>		<p>YASKAWA AC Drive V1000 [CIMR-Vxxxxxxx]</p>
	Solenoid Valves	<p>SMC CORPORATION</p> <p>+81-3-5207-8249 www.smcworld.com</p> <p>Overseas sales areas: Europe, North America, Asia-Pacific, China</p>		<p>Fieldbus System Compatible with CompoNet™ [EXI20/I21/I22 Series]</p>
<p>CKD CORPORATION</p> <p>Europe TEL:+81-(0)568-74-1303 North America TEL:+81-(0)568-74-1303 Asia-Pacific TEL:+81-(0)568-74-1303 China TEL:+81-(0)568-74-1303 www.ckd.co.jp/english</p> <p>Overseas sales areas: Europe, North America, Asia-Pacific, China, Other</p>			<p>Pilot type 3-5 ports pilot valve [46 series]</p>	<p>Features</p> <ol style="list-style-type: none"> Very long life: more than 60 million times due to elastic seal with few air leakage. Enhanced safety function: Manual override button with protective cover and integrated check valve preventing back pressure.
Koganei Corporation	<p>+81-42-383-7271 www.koganei.co.jp</p> <p>Overseas sales areas: Europe, North America, Asia-Pacific</p>		<p>CompoNet-compatible Solenoid Valves [JA Series]</p> <p>Features</p> <ol style="list-style-type: none"> Thin and Compact: Valve width of only 10 mm with effective area of 3.5 mm. Lower power consumption. Standard: 0.5 W Low current type: 0.25 W Two 3-port valves in one body. 	<p>CompoNet-compatible Solenoid Valves [F Series]</p> <p>Features</p> <ol style="list-style-type: none"> Single/double dual-valves. Three of valve widths: 10, 15 and 18 mm Uses dual-use fittings for different tube sizes.
	IAI Corporation	<p>www.intelligentactuator.com/</p> <p>Overseas sales areas: Europe, North America, Asia-Pacific, China</p>		<p>Controller for RCA/RCA2 Series ROBO CYLINDER [ACON-C/CG]</p> <p>Features</p> <ol style="list-style-type: none"> Designed for 24 VDC servomotors. Multipoint positioning: up to 512 points. High speed: Up to 800 mm/s.
<p>PATLITE Corporation</p> <p>+81-6-6763-8220 www.patlite.com</p> <p>Overseas sales areas: Europe, North America, Asia-Pacific, China</p>			<p>CompoNet Supported Signal Tower [LE-K3(B)/W-RYG]</p> <p>Features</p> <ol style="list-style-type: none"> Use of ultra-bright LED enhanced for illumination. Two selectable sound patterns with adjustable volume. 	<p>CompoNet Supported Wall-Mount Signal Tower [WEP-K3(B)-RYG]</p> <p>Features</p> <ol style="list-style-type: none"> A 37.5 mm-thin design that significantly enhances integration with equipment as a built-in signal system. Clear vertical cut lens enhanced for illumination over a wide perspective. Built-in audible alarm.

JSK CO., LTD.
 +81-72-661-4071
www.nihon-seigyo.co.jp



CompoNet-RS422/485 Converter [DWPC-001]

- Features**
1. Connects conventional RS422/485 control devices to CompoNet.
 2. Programmable RS422/485 interface realizes easy software implementation.
 3. DeviceNet, CC-Link, other protocols are coming soon.

Under development

AIOI-SYSTEMS CO.,LTD.
 +81-3-3764-0228
www.hello-aioi.com/en
info@hello-aioi.com
Overseas sales areas:
 Europe, North America, Asia-Pacific, China Other



Gateway Controller for CompoNet [TW2118]

- Features**
1. AI-NET-Componet Gateway Controller.
 2. Maximum coDrop Light Modules Number is 64.

Coming soon

Honda Tsushin Kogyo Co., Ltd.
 +81-52-242-2111
www.honda-connectors.co.jp
Overseas sales areas:
 Europe, North America, China, Asia-Pacific, Southeast Asia



Connector [HCN- (S)4(X)JFDG +] [HCN-TB 4LMZG +]

- Features**
1. PCB SIDE
 - Smaller than conventional product
 - Mating area of SLIM TYPE is 8mm, compared with 10mm of conventional product.
 2. CABLE SIDE
 - INSIDE HOOK(LOCK SYSTEM INSIDE CASE)
 - Possible to lead cables to 2 directions out.

Tayco Electronics AMP K.K.
 +81-44-844-8080
www.tycoelectronics.com



RITS Connector (e-CON) [X-1473562-4]

- Features**
1. New Chisel Press Contacts for sensor cables.
 2. No special crimping tool required for easy termination.
 3. Two contact points for good connection and more security.

3M Company
www.3M.com/interconnects



Mini-Clamp Connector: [3710x-xxxx-000 FL]

- Features**
1. IDC technology reduces process/cost of wire termination.
 2. Crimped using standard pliers to reduce tool costs.
 3. Design offers multiple gauges and wire size diameters.

HARTING K.K.
 +81-45-476-3456
www.harting.co.jp/
jp@HARTING.com
Overseas sales areas:
 Europe, North America, China, Asia-Pacific



HARAX M12-L [2103 212 1305] [2103 212 2305]

- Features**
1. No special tool required
 2. terminate up to 0.75mm²wire
 3. IP67 degree of protection(DIN EN60 529,IEC 60 529)

SWCC SHOWA CABLE SYSTEMS CO., LTD.
 +81-3-3597-7117
www.swcc.co.jp

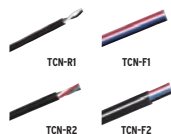

CompoNet Cable

- Features**
- TCN-R1 Round Cable 19AWGx2C(CL3,CM,cUL-CM,75°C)
 - TCN-R2 Round Cable 19AWGx4C(CL3,CM,cUL-CM,75°C)
 - TCN-F1 Flat Cable 21AWGx2C+19AWGx2C
 - TCN-F2 Flat Cable 21AWGx2C+19AWGx2C

KURAMO ELECTRIC CO.,LTD.
 +81-778-22-1500
www.kuramo.co.jp

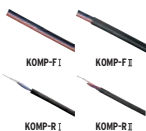

**CompoNet Flat Cable Cable I, II
 CompoNet Round Cable I, II**

- Features**
1. CompoNet Flat Cable KOMP-F I
 Heat resistance:90 Flame resistance:FT4
 UL certification:UL13 CL2 CSA certification:CSA C22.2 No.210
 2. CompoNet Flat Cable KOMP-F II
 Oil resistance-Heat resistance:90
 Flame resistance:UL FLAME EXPOSURE UL certification:UL13 PLTC,UL444 CM
 CSA certification:CSA C22.2 No.214
 3. CompoNet Round Cable KOMP-R I
 CompoNet Round Cable KOMP-R II
 Oil resistance Heat resistance:90
 Flame resistance:FT4 UL certification:UL13 PLTC,UL444 CMG

NICHIGOH COMMUNICATION ELECTRIC WIRE CO.,LTD
 +81-72-923-5104
www.nichigoh.co.jp



UNICOMPO series
 •CompoNet Flat type cable (Sheath less):UNICOMPO FC I-T
 •CompoNet Flat type cable (With Sheath):UNICOMPO FC II-T
 •CompoNet Round type cable (2c):UNICOMPO RC I-T
 •CompoNet Round type cable (4c):UNICOMPO RC II-T

- Features**
1. Conformity to UL/cUL standard(CM,CL2)
 2. Conformity to NFPA79,NFPA70(NEC)
 3. The RC type acquires CE, and is acquiring the FC type

Kanetsu Co.,Ltd
 +81-75-662-0996
www.kanetuu.co.jp/
info_kanetsu@kanetuu.co.jp
Overseas sales areas:
 Europe, North America, China, Asia-Pacific, Taiwan, Vietnam

CompoNet Flat Cable I and II



- Daiko. E.W. [KCNF]**
► Features
1. Enables using unique isolation-displacement connectors for CompoNet.
 2. Easy one-step IDC connection without insulation stripping.
 3. UL AWM, CSA compliant.



- Taiyo Electric Wire & Cable Co., Ltd. [KCNF-J]**
► Features
1. Enables using unique isolation-displacement connectors for CompoNet.
 2. PVC jackets with polarity guide line for IP54 system.
 3. Easy one-step IDC connection without insulation stripping.
 4. UL AWM, CSA compliant

Oil-resistant and Highly Flexible Round Cable II for CompoNet



- Hanshin Electric Wire & Cable Co., Ltd. [MRC-4]**
► Features
1. The cable can be used for mobile and oil-resistant wiring.
 2. Round cable for low cost installation.
 3. UL AWM, CSA compliant.

CompoNet Round Cable I and II

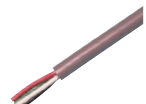

- Onamba Co., Ltd [VCTF-2c VCTF-4c]**
► Features
- Round cable for low cost installation.

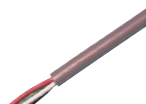

- Kawai Cable, Ltd. [VCTF-2c VCTF-4c]**
► Features
- Round cable for low cost installation.

OMRON Corporation

✉ open_integration@omron.co.jp

MPU for CompoNet Slave, MPU for CompoNet Master

► Features

Slave: Omron offers the development approach of three types by the function of the slave.

1. Few-Point Slave
 - I/O Size: Digital I/O in MAX 32 points
 - Application interface: Via I/O port
2. Multi-Points Slave
 - I/O size: Outputs: 0 to 256 points (32 bytes)
 - Inputs: 0 to 256 points (32 bytes)
 - Application interface: DPRAM
3. Protocol stack
 - No restriction in MPU and OS

Master: Omron offers two kinds of development approaches.

1. DP-RAM/F MPU
 - Development is unnecessary of the communication protocol.
 - The communication protocol including RAS is mounted on MPU.
2. Library
 - System Call I/F of ITRON

OMRON Corporation

🌐 www.omron.com/

Overseas sales areas:
Asia-Pacific



On board Connector [XW7D-PB4-S][XW7D-PB4-R][XW7D-PB4-L]

► Features

1. 3 type models are ready to correspond with some applications.
2. Enable to mate DCN4-MD4/DCN4-TB4 with lock lever.
3. UL approved.

HMS INDUSTRIAL NETWORKS Co.,Ltd

🌐 Europe
Tel: +46-35-172900
North America
Tel: +1-312-829-0601
China
Tel: +86-10-8532-3183

✉ Europe
info@hms.se
USA
us-sales@hms-networks.com
CHINA
cn-sales@hms-networks.com

Overseas sales areas:
Europe, North America, Asia-Pacific, China



Anybus CompactCom Component [ABCC-CPN]

► Features

1. Embedded solutions of CompoNet slave for device vendors.
2. Can release the device for CompoNet with short term.
3. Common interface with DeviceNet and EtherNet/IP.

Coming soon

Hilscher GmbH

🌐 Europe
Hilscher GmbH (Germany)
Tel: +49-(0)-6190-9907-0
North America
Hilscher North America, Inc. (USA)
Tel: +1-630-505-5301
Asia-Pacific
Hilscher GmbH (Germany)
Tel: +49-(0)-6190-9907-0
China
Hilscher GmbH (Shanghai Rep. Office)
Tel: +86-(0)-21-6355-5161
India
Tel: +91-(0)-11-4051-5640

✉ info@hilscher.com

Overseas sales areas:
Europe, North America, Asia-Pacific, China, Other



CompoNet Communication Controller [netX 50/netX 100/netX 500]

► Features

1. CompoNet, DeviceNet, EtherNet/IP and various Fieldbus / Real Time Ethernet on one chip
2. Control by external CPU via DPM or Application can be implemented on the internal ARM (200MHz)
3. UART/USB/SPI/I2C/GPIO/LCD controller/ADC/PWM/DMA/CCD (depends on chip type)

NSD Co., Ltd.

📞 +81-3-3342-1413
🌐 www.nsd.co.jp/english/
✉ ia-info@nsd.co.jp

Overseas sales areas:
North America

CompoNet Master Stack Tool Kit (C-MTK) [CMK-100]

► Features

1. A developers' tool kit to implement communication function for CompoNet master modules
2. CompoNet master protocol stack firmware example source codes and various kinds of technical items are included
3. Software development and its technical services can be provided, if a industrial device vendor would like to develop CompoNet devices.

CompoNet Slave Stack Tool Kit (C-SSC) [CSS-200]

► Features

1. A developers' tool kit to implement communication function for CompoNet slave modules.
2. CompoNet slave protocol stack firmware example source codes and various kinds of technical items are included.
3. Software development and its technical services can be provided, if a industrial device vendor would like to develop CompoNet devices.

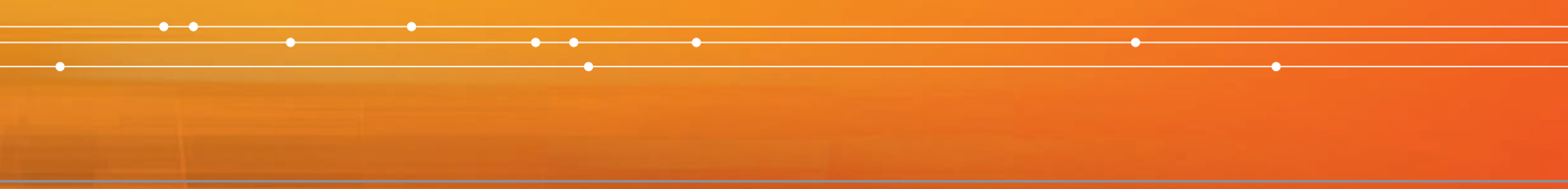

For details, refer to the CompoNet Series Data Sheet (Cat. No. P056).

- The application examples provided in this catalog are for reference only. Check functions and safety of the equipment before use.
- Never use the products for any application requiring special safety requirements, such as nuclear energy control systems, railroad systems, aviation systems, medical equipment, amusement machines, vehicles, safety equipment, or other application involving serious risk to life or property, without ensuring that the system as a whole has been designed to address the risks, and that the OMRON products are properly rated and installed for the intended use within the overall equipment or system.

Warranty and Limitations of Liability

WARRANTY

OMRON's exclusive warranty is that the products are free from defects in materials and workmanship for a period of one year (or other period if specified) from date of sale by OMRON.

OMRON MAKES NO WARRANTY OR REPRESENTATION, EXPRESS OR IMPLIED, REGARDING NON-INFRINGEMENT, MERCHANTABILITY, OR FITNESS FOR PARTICULAR PURPOSE OF THE PRODUCTS. ANY BUYER OR USER ACKNOWLEDGES THAT THE BUYER OR USER ALONE HAS DETERMINED THAT THE PRODUCTS WILL SUITABLY MEET THE REQUIREMENTS OF THEIR INTENDED USE. OMRON DISCLAIMS ALL OTHER WARRANTIES, EXPRESS OR IMPLIED.

LIMITATIONS OF LIABILITY

OMRON SHALL NOT BE RESPONSIBLE FOR SPECIAL, INDIRECT, OR CONSEQUENTIAL DAMAGES, LOSS OF PROFITS, OR COMMERCIAL LOSS IN ANY WAY CONNECTED WITH THE PRODUCTS, WHETHER SUCH CLAIM IS BASED ON CONTRACT, WARRANTY, NEGLIGENCE, OR STRICT LIABILITY.

In no event shall the responsibility of OMRON for any act exceed the individual price of the product on which liability is asserted.

IN NO EVENT SHALL OMRON BE RESPONSIBLE FOR WARRANTY, REPAIR, OR OTHER CLAIMS REGARDING THE PRODUCTS UNLESS OMRON'S ANALYSIS CONFIRMS THAT THE PRODUCTS WERE PROPERLY HANDLED, STORED, INSTALLED, AND MAINTAINED AND NOT SUBJECT TO CONTAMINATION, ABUSE, MISUSE, OR INAPPROPRIATE MODIFICATION OR REPAIR.

Note: Do not use this document to operate the Unit.

OMRON Corporation Industrial Automation Company
Tokyo, JAPAN

Contact: www.ia.omron.com

Regional Headquarters

OMRON EUROPE B.V.

Wegalaan 67-69-2132 JD Hoofddorp
The Netherlands
Tel: (31)2356-81-300/Fax: (31)2356-81-388

OMRON ELECTRONICS LLC

One Commerce Drive Schaumburg,
IL 60173-5302 U.S.A.
Tel: (1) 847-843-7900/Fax: (1) 847-843-7787

OMRON ASIA PACIFIC PTE. LTD.

No. 438A Alexandra Road # 05-05/08 (Lobby 2),
Alexandra Technopark,
Singapore 119967
Tel: (65) 6835-3011/Fax: (65) 6835-2711

OMRON (CHINA) CO., LTD.

Room 2211, Bank of China Tower,
200 Yin Cheng Zhong Road,
PuDong New Area, Shanghai, 200120, China
Tel: (86) 21-5037-2222/Fax: (86) 21-5037-2200

Authorized Distributor:

© OMRON Corporation 2009 All Rights Reserved.
In the interest of product improvement,
specifications are subject to change without notice.

Cat. No. R140-E1-08

Printed in Japan
0512(1106)(IT)