

**WD30-ME/-SE/-ME01/-SE01**

**DeviceNet Wireless Units**

**OPERATION MANUAL**

**OMRON**

#### **Notice**

- (1) This manual may not be copied, reproduced, or reprinted, in whole or in part, without permission.
- (2) The specifications listed within this manual may be revised without prior notice.
- (3) The information in this manual was compiled with the utmost care. However, if you should find any errors or inconsistencies, please contact the OMRON business office. Be sure to tell us the revision number of the manual in which you found the error.

#### **Copyrights and Trademarks**

DeviceNet is a registered trademark of the OpenDeviceNet Vendor Association (ODVA).

S-S Technologies, Inc. holds the copyrights for DeviceNet master unit and all software included with the DeviceNet wireless slave station.

# 1 Introduction

Thank you for purchasing this DeviceNet wireless unit.

This DeviceNet wireless unit was developed based on OMRON's advanced control technology and experience.

Carefully read and understand the functions and performance of this device before using the DeviceNet master and DeviceNet slave together as a structured system.

## Personnel to whom this manual is directed

This User's Manual was designed for use by the following personnel.

Persons with a knowledge of electronics (electricians or those with similar training) and who:

- are in charge of introducing FA equipment
- design FA system
- install and connect FA equipment
- manage FA sites

## Precautions for use

- This equipment should be used as indicated in the general specifications.
- If this equipment is used under conditions or in an environment such as those listed below, the user should contact the OMRON business office for assistance. All uses and safety measures should be considered carefully according to the ratings and functions of the equipment.
  1. Using the equipment under conditions or in environments not indicated in this manual
  2. Using the equipment to control nuclear power, for railway facilities, for airline facilities, for automobiles, for combustion facilities, for medical equipment, for entertainment equipment, or for safety equipment.
  3. Using the equipment in a manner that is expected to have an effect on human life or property, and particularly for applications that require safety measures
- The information contained in this manual is required for the correct use of the DeviceNet wireless unit. Be sure to carefully read and understand this User's Manual, the DeviceNet User's Manual, and the DeviceNet Slave Manual before using this equipment. After reading this User's Manual, store it in a safe location where it can be referred to at any time as necessary. The frequency band used for this equipment is also used for the manufacture of products such as microwave ovens, in scientific applications, and in medical equipment.

## Countries where this product can be used

This product has been approved for wireless standards in the countries listed below. Consult your OMRON representative before using this product in other countries.

WD30-ME/-SE: Austria, Belgium, Canada, Denmark, Finland, France, Germany, Greece, Iceland, Ireland, Italy, Japan, Luxembourg, Netherlands, Norway, Portugal, Spain, Sweden, Switzerland, UK, USA

WD30-ME01/-SE01: Japan, USA

## FCC Notice:

This device complies with part 15 of the FCC Rules. Operation is subject to the following two conditions: (1) This device may not cause harmful interference, and (2) this device must accept any interference received, including interference that may cause undesired operation.

## IC Notice:

To prevent radio interference to the licensed service, this device is intended to be operated indoors and away from windows to provide maximum shielding. Equipment (or its transmit antenna) that is installed outdoors is subject to licensing.

 **Caution** To ensure that the WLAN transmitter complies with current FCC regulations limiting both maximum RF output power and human exposure to radio frequency radiation, a separation distance of at least 20cm must be maintained between the unit's antenna and the body of the user and any nearby persons at all times and in all applications and uses.

## CE Notice

English	Hereby, Omron Corporation, declares that this WD30-ME/-SE is in compliance with the essential requirements and other relevant provisions of Directive 1999/5/EC.
Finnish	Omron Corporation vakuuttaa täten että WD30-ME/-SE tyyppinen laite on direktiivin 1999/5/EY oleellisten vaatimusten ja sitä koskevien direktiivin muiden ehtojen mukainen.
Dutch	Bij deze verklaart Omron Corporation dat deze WD30-ME/-SE voldoet aan de essentiële eisen en aan de overige relevante bepalingen van Richtlijn 1999/5/EC.
Swedish	Härmed intygar Omron Corporation att denna WD30-ME/-SE står i överensstämmelse med de väsentliga egenskapskrav och övriga relevanta bestämmelser som framgår av direktiv 1999/5/EG.
Danish	Undertegnede Omron Corporation erklærer herved, at følgende udstyr WD30-ME/-SE overholder de væsentlige krav og øvrige relevante krav i direktiv 1999/5/EF
German	Hiermit erklärt Omron Corporation die Übereinstimmung des Gerätes WD30-ME/-SE mit den grundlegenden Anforderungen und den anderen relevanten Festlegungen der Richtlinie 1999/5/EG.
Italian	Con la presente Omron Corporation dichiara che questo WD30-ME/-SE è conforme ai requisiti essenziali ed alle altre disposizioni pertinenti stabilite dalla direttiva 1999/5/CE.
Spanish	Por medio de la presente Omron Corporation declara que el WD30-ME/-SE cumple con los requisitos esenciales y cualesquiera otras disposiciones aplicables o exigibles de la Directiva 1999/5/CE
Portuguese	Omron Corporation declara que este WD30-ME/-SE está conforme com os requisitos essenciais e outras disposições da Directiva 1999/5/CE.
Norwegian	Omron Corporation erklærer herved, at følgende utstyr WD30-ME/-SE overholder de vesentlige krav og øvrige relevante bestemmelser i direktiv 1999/5/EF
French	Par la Présente Omron Corporation déclare que l'appareil WD30-ME/-SE est conforme aux exigences essentielles et aux autres dispositions pertinentes de la directive 1999/5/CE.  La France étant le seul pays ayant une directive locale qui différé légèrement de la directive Européenne, ce produit ne peut être utilisé en France.
Greek	ΜΕ ΤΗΝ ΠΑΡΟΥΣΑ Omron Corporation ΔΗΛΩΝΕΙ ΟΤΙ WD30-ME/-SE ΣΥΜΜΟΡΦΩΝΕΤΑΙ ΠΡΟΣ ΤΙΣ ΟΥΣΙΩΔΕΙΣ ΑΠΑΙΤΗΣΕΙΣ ΚΑΙ ΤΙΣ ΛΟΙΠΕΣ ΣΧΕΤΙΚΕΣ ΔΙΑΤΑΞΕΙΣ ΤΗΣ ΟΔΗΓΙΑΣ 1999/5/ΕΚ

## 2 Safety Precautions

Observe the following points to ensure safe operation of this equipment.

- Do not use this equipment for real-time control (I/O control that requires a response rate the same as that of DeviceNet).
- Do not apply excess vibrations or shock to this equipment. Do not drop this equipment.
- Do not use this equipment in any of the following environments:
  - Areas with corrosive or combustible gasses
  - Areas with large amounts of dust or dirt
  - Areas containing water, oils, or chemical agents
  - Areas with severe fluctuations in humidity that results in condensation
  - Areas with static electricity or excessive noise
- Do not place the communications cables nearby other cables with high voltage or strong currents.
- Do not attach connectors to the communications cables while they are supplied by the power supply.
- Use the cables specified in this manual for connections with the communications cables.
- Prevent objects such as chips from getting inside the equipment while the cover is open.
- Do not install this equipment in areas where it will be subject to excess external force, or in walkways.
- Tighten installation screws at the rated torque specified in this User's Manual.
- Do not use this equipment near other devices that may malfunction due to the electronic waves emitted by the DeviceNet wireless unit.

### **3 Proper Use of This Equipment**

1. Turn the power source OFF before performing any wiring work.
2. When adjusting the installation position, use double-sided tape or rope to fix the equipment and prevent it from falling.
3. Do not use this equipment in areas exposed to direct sunlight, in areas of very high humidity, near televisions or radios, near motors or drills that emit sparks, near strong magnets, or near fluorescent lights.
4. Do not turn or bend the antennas. Do not wrap electric wires around the antennas.
5. Install the equipment so that the antennas are not near any electric wires or metal plates. Install the equipment as far away as possible from electric wires and metal plates.
6. Communications performance will vary according to environment. Other wireless devices that operate within the same frequency band may interfere with this equipment. Be sure to perform the tests provided for this equipment (such as the installation test) before operating it.

## 4 DeviceNet Manuals

The following manuals are available for information relating to DeviceNet. Be sure to thoroughly read and understand the applicable manuals before installing or operating DeviceNet devices and make sure that you are using the most recent version of the manual.

### **DeviceNet Operation Manual (W267)**

Describes the functions and applications of DeviceNet including available Master Units, their specifications, functions, operating procedures, and applications. Always read this manual thoroughly before installing or operating DeviceNet devices.

### **DeviceNet Slaves Operation Manual (W347)**

Describes available Slave Units, their specifications, functions, operating procedures, and applications. This manual has been separately produced in response to the increase in Slave Unit models since the production of the *DeviceNet Operation Manual (W267)*. Use this manual in conjunction with the *DeviceNet Operation Manual (W267)*.

### **DeviceNet Configurator Operation Manual (W328)**

Describes the operating procedures of the DeviceNet Configurator, which is used to freely allocate remote I/O areas, and allows multiple Master Units to be mounted to one PLC or connected to one DeviceNet Network to perform independent remote I/O communications. Refer to this manual when operating a DeviceNet Network with a DeviceNet Configurator.

### **MULTIPLE I/O TERMINAL Operation Manual (W348)**

Describes available MULTIPLE I/O TERMINALS, their specifications, functions, operating procedures, and applications. This manual has been separately produced in response to the increase in MULTIPLE I/O TERMINAL models since the production of the *DeviceNet Operation Manual (W267)*. Use this manual in conjunction with the *DeviceNet Operation Manual (W267)*.

## **5 Manual Outline**

### **5-1 Outline of This Manual**

---

#### **Section 1 DeviceNet Wireless Unit**

This section explains the features of the DeviceNet Wireless Unit, including system structure, types of units, basic functions, and configurator outline.

---

#### **Section 2 Hardware Settings and Checking of Operations**

This section gives specific explanations of the operations and procedures necessary for you to use the DeviceNet wireless unit. Follow the explanations in this section to perform operation check procedures.

---

#### **Section 3 Sample Program**

This section contains an example program for monitoring the status of the DeviceNet wireless unit.

---

#### **Section 4 DeviceNet Wireless Unit Station Specifications**

This section explains the settings and installation procedures for the parts and switches of the DeviceNet wireless unit.

---

#### **Section 5 Test**

This section explains the procedures for the system tests required for using the DeviceNet wireless unit.

---

#### **Section 6 Relay Function**

This section gives detailed explanations of the relay function of the wireless slave stations used to enlarge the communications area.

---

#### **Section 7 Message Communication Function**

This section gives detailed explanations of the basic format and commands for the Explicit messages used in the Message Communications Function performed by setting and reading the status of the DeviceNet wireless master station.

---

#### **Section 8 Using the Configurator**

This section explains how to monitor the conditions and make the various settings of the wireless network used for the configurator.

---

#### **Section 9 Communications Timing**

This section explains the remote I/O communications response time and the delay time between wireless networks when the DeviceNet wireless unit is connected.

---

#### **Section 10 Troubleshooting**

This section contains information regarding troubleshooting and inspection methods to be performed by daily inspectors when errors occur.

---

#### **Appendices**

The appendices include DeviceNet wireless unit profiles and lists of connecting devices that are required when connecting with a DeviceNet master manufactured by a different company.



## 5-2 Instruction Markings:

Instruction markings are used throughout this manual to indicate additional information. These markings are described below.



This mark indicates information/instructions that should be followed precisely.



This mark indicates additional information that the user would find constructive.



# TABLE OF CONTENTS

1	Introduction . . . . .	i
2	Safety Precautions . . . . .	iii
3	Proper Use of This Equipment . . . . .	iv
4	DeviceNet Manuals . . . . .	v
5	Manual Outline . . . . .	vi

## SECTION 1

<b>DeviceNet Wireless Unit. . . . .</b>	<b>1</b>
1-1 DeviceNet Wireless Unit . . . . .	2
1-2 Basic Functions of the DeviceNet Wireless Unit . . . . .	4
1-3 Configurator Outline . . . . .	12
1-4 Application Limitations . . . . .	14
1-5 Points for Consideration with Wireless Systems . . . . .	16

## SECTION 2

<b>Hardware Settings and Checking of Operations. . . . .</b>	<b>19</b>
2-1 Basic Operation Procedure . . . . .	20
2-2 Pre-work Preparations . . . . .	22
2-3 Hardware Settings and Wiring . . . . .	24
2-4 System Initial Setting and Starting Communications . . . . .	26
2-5 Operation Confirmation . . . . .	31
2-6 Other Operations . . . . .	32
2-7 Deciding the Antenna Installation Position . . . . .	38

## SECTION 3

<b>Sample Program . . . . .</b>	<b>43</b>
3-1 Status Monitoring Program Example . . . . .	44
3-2 Example of Using an Explicit Message . . . . .	49

## SECTION 4

<b>DeviceNet Wireless Unit Station Specifications. . . . .</b>	<b>55</b>
4-1 DeviceNet Wireless Master Station Specifications . . . . .	56
4-2 DeviceNet Wireless Slave Station Specifications . . . . .	63
4-3 Common Specifications to All DeviceNet Wireless Units . . . . .	69

## SECTION 5

<b>Test. . . . .</b>	<b>71</b>
5-1 Test . . . . .	72
5-2 Installation Test . . . . .	73
5-3 Confirmation Test . . . . .	75
5-4 Wireless Channel Monitor . . . . .	77

# TABLE OF CONTENTS

## SECTION 6

<b>Relay Function</b> .....	<b>79</b>
6-1 Relay Function .....	80
6-2 Actual Example .....	81

## SECTION 7

<b>Message Communication Function</b> .....	<b>85</b>
7-1 Explicit Messages Addressed to the DeviceNet Wireless Master Station .....	86
7-2 List of Explicit Messages Addressed to DeviceNet Wireless Master Station .....	88
7-3 Explicit Messages Addressed to DeviceNet Slave Connected before DeviceNet Wireless Slave Station .....	101

## SECTION 8

<b>Using the Configurator</b> .....	<b>107</b>
8-1 Additional Functions .....	108
8-2 Wireless Network Configuration Display .....	108
8-3 Wireless Network Parameter Editing .....	112
8-4 Wireless Channel Monitor .....	116
8-5 Running Test .....	121

## SECTION 9

<b>Communications Timing</b> .....	<b>125</b>
9-1 Remote I/O Communications Performances .....	126
9-2 Message Communication Performance .....	134

## SECTION 10

<b>Troubleshooting</b> .....	<b>141</b>
10-1 Normal Indication .....	142
10-2 Troubleshooting .....	144
10-3 Maintenance .....	152

## Appendices

A Connection-related Devices Model List .....	161
B Current Consumption List .....	163
C Optional Products List .....	165

<b>Index</b> .....	<b>167</b>
--------------------	------------

<b>Revision History</b> .....	<b>171</b>
-------------------------------	------------

# SECTION 1

## DeviceNet Wireless Unit

This section explains the features of the DeviceNet Wireless Unit, including system structure, types of units, basic functions, and configurator outline.

- 1-1 DeviceNet Wireless Unit . . . . . 2
  - 1-1-1 System configuration . . . . . 2
  - 1-1-2 Features . . . . . 2
  - 1-1-3 Types of units . . . . . 3
  - 1-1-4 Model list . . . . . 4
- 1-2 Basic Functions of the DeviceNet Wireless Unit . . . . . 4
  - 1-2-1 Replacing data . . . . . 4
  - 1-2-2 I/O allocation . . . . . 6
  - 1-2-3 DeviceNet wireless unit status . . . . . 8
  - 1-2-4 Slave error flag . . . . . 8
  - 1-2-5 Disconnect/Connect Switch . . . . . 9
  - 1-2-6 DeviceNet node addresses . . . . . 10
  - 1-2-7 DeviceNet wireless unit default setting values . . . . . 11
  - 1-2-8 Serial Number Check . . . . . 11
- 1-3 Configurator Outline . . . . . 12
  - 1-3-1 Configuration . . . . . 12
  - 1-3-2 Operating environment . . . . . 12
  - 1-3-3 Outline of functions . . . . . 13
- 1-4 Application Limitations . . . . . 14
- 1-5 Points for Consideration with Wireless Systems . . . . . 16
  - 1-5-1 Construction of multiple wireless systems . . . . . 16

# 1-1 DeviceNet Wireless Unit

The DeviceNet wireless unit, consisting of a DeviceNet wireless master station and a DeviceNet wireless slave station, allows wireless communication with the DeviceNet slave.

Basically, the wireless master station is connected to the DeviceNet network and acts as either a virtual DeviceNet slave or wireless network master station for the DeviceNet master unit. The wireless slave station acts as either a wireless network slave station or a virtual DeviceNet master with the DeviceNet slave unit.

This unit conforms to the following radio wave standards.

WD30-ME/-SE	Japan: ARIB STD-T66 USA: FCC part 15.247 Canada: IC RSS 210 Europe: ETS 300 440
WD30-ME01/-SE01	Japan: ARIB STD-T66 USA: FCC part 15.247

Conformance with these standards means that the antenna can be installed separately. The unit can be purchased as a set with a pencil antenna (WD30-ME/-SE) or with a magnet-base antenna (WD30-ME01/-SE01). (The diagrams in this manual are for the WD30-ME/-SE.)

## 1-1-1 System configuration

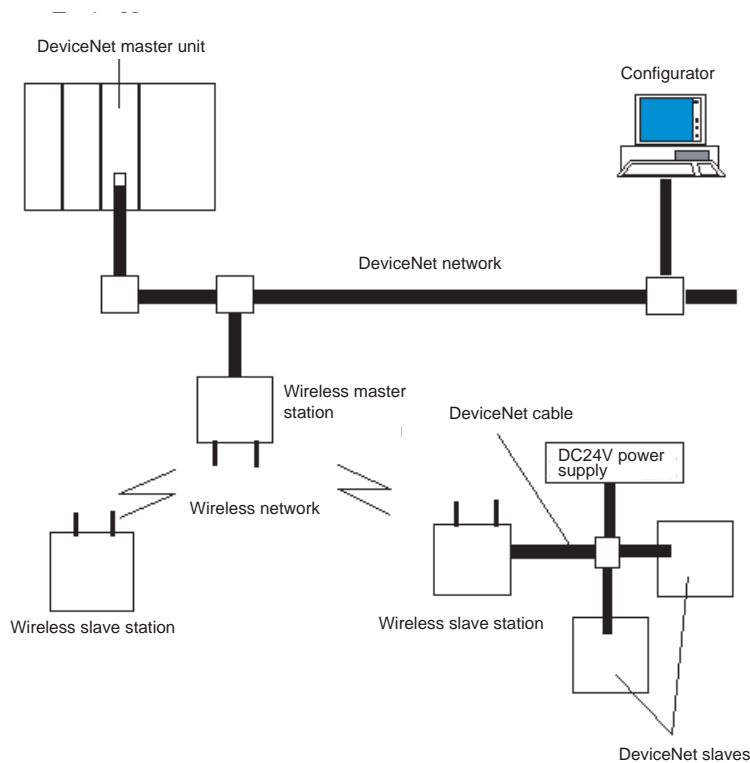

## 1-1-2 Features

**DeviceNet slaves can be made wireless**

Wireless DeviceNet slaves allows for a variety of field level applications.

	We recommend that this function be used for applications that are not required to operate in real time (such as displays for indicators and manufacturing instruction data transmissions).
<b>Errors can be monitored</b>	DeviceNet slave error information (including errors in wireless slave stations) can be assigned to two or four status words and monitored from the PLC.
<b>Abundant number of wireless channels allows the construction of multiple systems in the same area</b>	<p>Since the wireless region is divided into 34 frequencies from 2,400 to 2,483.5MHz, you can select an unused frequency for building multiple systems.</p> <p>Using a spectral spread method (DS: direct spread) as a modulation method achieves high-quality communications even in areas of excess noise.</p>
<b>Relay functions make possible an extension in communications distances</b>	<p>Although communications distances vary according to the installation environment, the goal indoors is 60m in line of sight.</p> <p>The relay functions allow an increase in the communications area (to a maximum of 3 stages).</p> <p>DeviceNet slaves may also be connected to the relay station.</p> <p>However, relay station system settings can only be performed from the configurator.</p>
<b>Diversity functions</b>	<p>Multi-pass phasing is improved with a diversity system (which requires 2 antennas).</p> <p>The effects of this function are observed when used in areas where variations in radio waves (such as reflections) occur.</p>
<b>Maximum number of I/O per wireless master station increased</b>	Depending on the switch settings of the wireless master station, the maximum number of I/O per wireless master station can be increased to 100 words/100 words (IN/OUT). The maximum number of wireless slave stations that can be connected has increased to 64.
<b>Magnet-base antenna added to lineup</b>	Using the magnet-base antenna, the station itself can be installed inside a control panel with the antenna installed outside. Also, because it is mounted with a magnet, the position of the antenna can be adjusted easily when, for example, the control panel is moved. Attenuation in the antenna cable (2m), however, limits the maximum communications distance to approximately 50m indoors.

### 1-1-3 Types of units

#### DeviceNet wireless master station (Wireless master station)

- Connects to the DeviceNet network and acts as a virtual DeviceNet slave.
- Maximum number of I/O as DeviceNet slave: IN/OUT = 32 words (512 points)/32 words (512 points) or 100 words (1,600 points)/100 words (1,600 points) depending on the DIP switch setting. However, if Status is selected, IN/OUT = 30 words (480 points)/32 words (512 points) or 96 words (1,536 points)/100 words (1,600 points) depending on the DIP switch setting.
- As the wireless network master station, it controls a maximum of 64 wireless slave stations and sends remote I/O transmissions.
- The wireless master station was tested at the test laboratories of a third part organization authorized by the ODVA. It is authorized as being in conformance to ODVA conformance software.



#### Multi-pass phasing

Multi-pass phasing is the phenomenon of a radio wave being transmitted from a single point, passing through multiple propagation paths, and then arriving at a single point.

**DeviceNet wireless slave station (Wireless slave station)**

- As a slave station for the wireless network, it exchanges remote I/O communications with the wireless master station via the wireless line.
- Acts as a virtual DeviceNet master with DeviceNet slaves.
- Connects with a maximum of 63 DeviceNet slaves and performs a maximum of 64 words (1,024 points) I/O control. (Even if multiple wireless slave stations are used, the maximum number of nodes for DeviceNet slaves is 63.)

**1-1-4 Model list**

Type	No. of inputs/ outputs	No. of words in PLC I/O memory		I/O connection	Unit voltage	Installation	Model
		IN	OUT				
DeviceNet wireless master station	None	Status: 2 or 4 words (See note.)	0 words	None	Supplied by power for external communications	Screws	Model WD30-ME
							Model WD30-ME01
DeviceNet wireless slave station	None	0 words	0 words	None			Model WD30-SE
							Model WD30-SE01

**Note** When set to “status”

**Accessories**

The following accessories are included with purchase of both wireless master station and slave station:

- 2 antennas (ME/-SE: pencil antenna; ME01/-SE01: magnet-base antenna)
- User’s manual
- Sticker (Attach in a visible location.)
- 2 installation screws (with nuts)
- Declaration of Conformity (CE) (Provided with ME/-SE models only.)

**Applicable connectors**

Use DeviceNet micro-connectors for communications connectors. A list of recommended connectors in the appendix.

**1-2 Basic Functions of the DeviceNet Wireless Unit**

**1-2-1 Replacing data**

**Initializing the wireless master station**

When the power supply is turned on, the wireless master station adds each registered wireless slave station. When wireless communication begins with an slave station, if the number of I/O points on the DeviceNet slave connected to the slave station and the I/O points registered for the wireless master station are identical, it is added. If they are not identical, an I/O configuration error will occur.



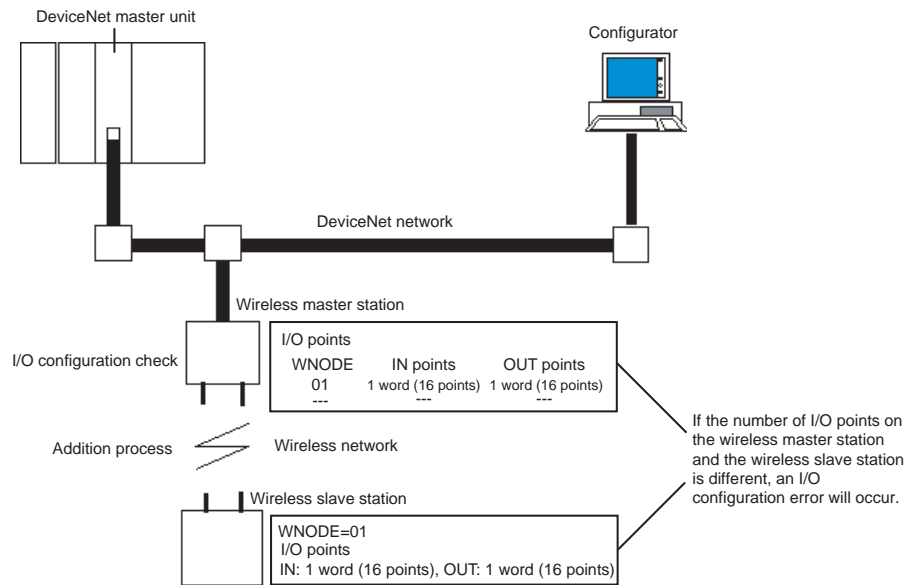

**Processing when an error occurs**

Even if an error occurs in the DeviceNet network below a wireless slave station after initialization is complete, the wireless network polling communication will continue as normal. The user should monitor the status at his device (PLC, computer) when an error occurs, and apply the appropriate error processing program for the type of error and the area in which it occurred.

1-2-2 I/O allocation

I/O for DeviceNet slaves is allocated in the wireless slave stations by ascending order of DeviceNet node address without leaving any unused areas, and then in the wireless master station by ascending order of slave station wireless node address (WNODE) without leaving any unused areas.

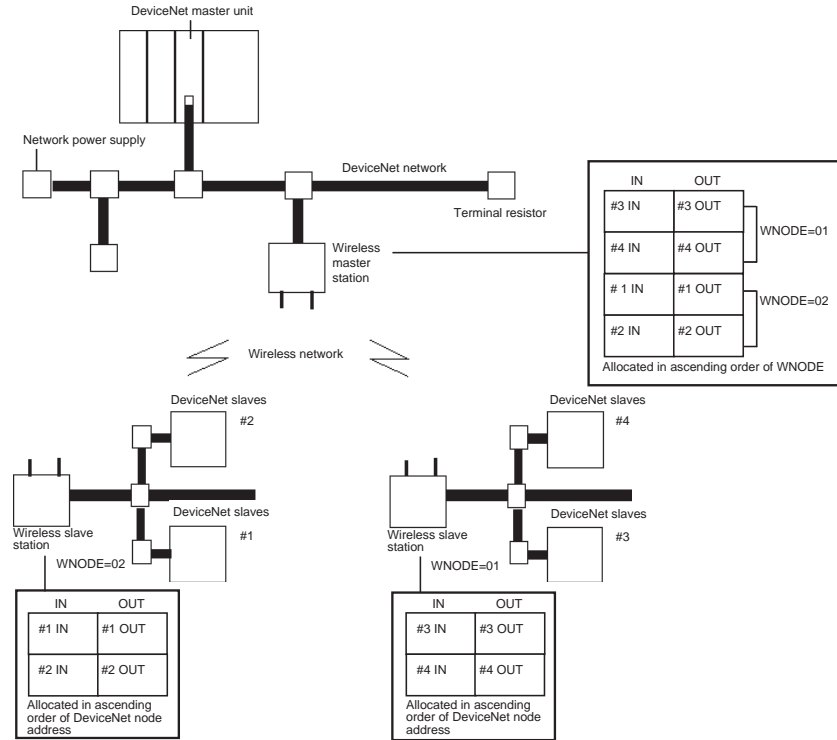

- The IN and OUT areas are allocated in units of 16 points (1 word). In the case of 8-point units, the lower byte (bits 0 to 7) is allocated and the upper byte (bits 8 to 15) is set to 00 Hex.
- The following four types of I/O allocations can be set using the DIP switch.

- 1,2,3... 1. Status 2 words (32 points), I/O IN/OUT = 30 words (480 points)/32 words (512 points)

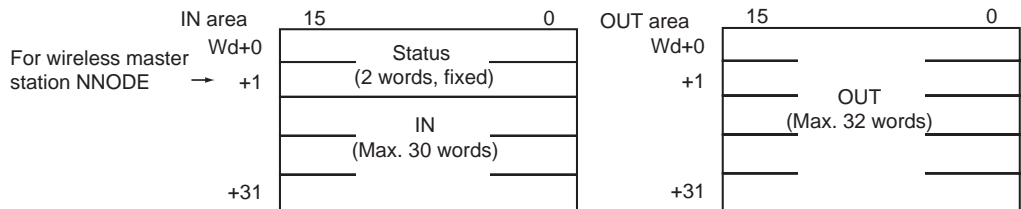

2. I/O IN/OUT = 32 words (512 points)/32 words (512 points)

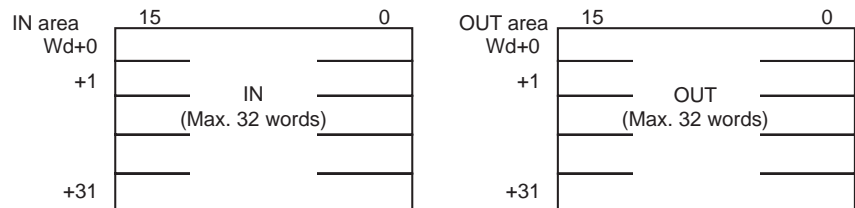

3. Status 4 words (64 points), I/O IN/OUT = 96 words (1,536 points)/100 words (1,600 points)

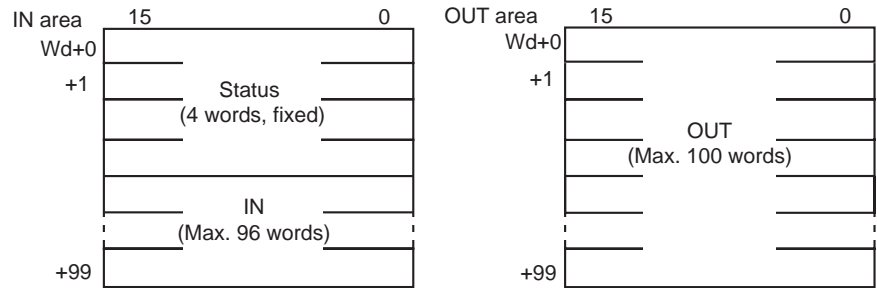

4. I/O IN/OUT = 100 words (1,600 points)/100 words (1,600 points)

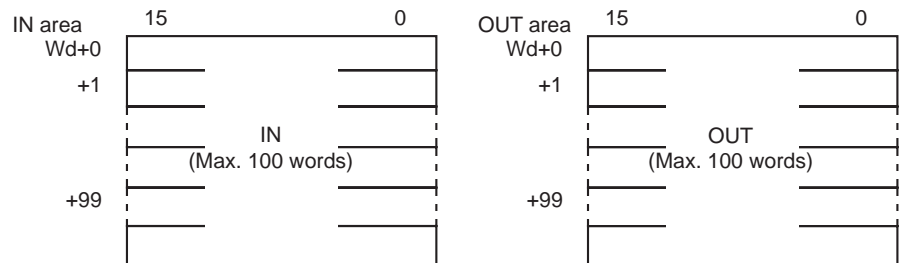

The default settings are "(2) I/O IN/OUT = 32 words (512 points)/32 words (512 points)".

### 1-2-3 DeviceNet wireless unit status

The format for the IN area status area is shown below.

Confirm this status at the CPU unit, and prepare an error processing program for sending commands to (Explicit messages) and obtaining detailed status reports (wireless network status, DeviceNet master status) from wireless master stations showing error flags. (Refer to SECTION 3 Sample Program.)

1. When maximum number of I/O = 32 words/32 words:

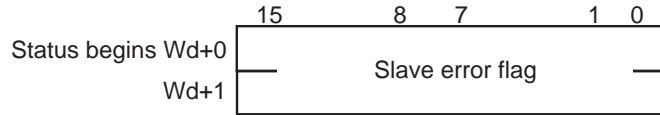

2. When maximum number of I/O = 100 words/100 words:

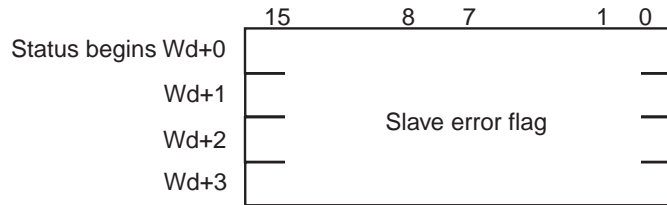

### 1-2-4 Slave error flag

1. When maximum number of I/O = 32 words/32 words:

15	14	13	12	11	10	9	8	7	6	5	4	3	2	1	0
16	15	14	13	12	11	10	9	8	7	6	5	4	3	2	1
32	31	30	29	28	27	26	25	24	23	22	21	20	19	18	17

2. When maximum number of I/O = 100 words/100 words:

15	14	13	12	11	10	9	8	7	6	5	4	3	2	1	0
16	15	14	13	12	11	10	9	8	7	6	5	4	3	2	1
32	31	30	29	28	27	26	25	24	23	22	21	20	19	18	17
48	47	46	45	44	43	42	41	40	39	38	37	36	35	34	33
64	63	62	61	60	59	58	57	56	55	54	53	52	51	50	49

Each of the following for the DeviceNet master status of added wireless slave stations is set to an OR value.

- Incorrect switch setting/EEPROM error (bit address 00)
- Repetitive node address/Busoff detection (bit address 01)
- Configuration error (bit address 03)
- Structural error (bit address 04)
- Send error (bit address 05)
- Communication error (bit address 06)
- Verify error (bit address 07)

Also, if a wireless slave station has been registered but not added, the bit will be 1. For example, if a wireless slave station error occurs for WNODE = 16, the uppermost bit for "status begin word +0" (16) becomes 1.



#### Master unit I/O point limitations

Each wireless master station can control a maximum of 512 (or 1,600) I/O points. However, there are limits to the number of I/O points per node for each master unit. Therefore, systems should be designed without exceeding the limitations for the number of I/O points per node for each master unit.

Refer to the "DeviceNet User's Manual" for details concerning DeviceNet master status errors.

### **1-2-5 Disconnect/Connect Switch**

The Disconnect/Connect Switch function that was introduced with CS/CJ-series DeviceNet master units can be used for wireless slave stations. A bit is allocated to each wireless slave station's WNODE, and if this bit is turned ON (1), wireless I/O communications and message communications with the corresponding wireless slave station will stop (i.e., the wireless slave station is disconnected from the network). This function is mainly used to reserve space for wireless slave stations to be added in the future (i.e., I/O points have been registered in the wireless master station but no wireless slave station has been connected yet).

Wireless slave stations that have been disconnected from the network do not need to be considered when calculating the wireless communications cycle time.

In the DeviceNet master unit's I/O area, 0 is set in the IN area allocated to wireless slave stations that have been set to leave the network.

### 1-2-6 DeviceNet node addresses

DeviceNet node addresses (NNODEs) are included in wireless master stations. The master unit controls the assignment of DeviceNet slave I/O data registered with wireless slave stations to areas corresponding to these node addresses.

Wireless node addresses (WNODEs) are included in wireless slave stations. These node addresses are used for control by wireless master stations. Therefore, there is no purpose in assigning the wireless slave station DeviceNet node addresses (NNODEs) to I/O. Normally, a 7 segment LED is used to display the DeviceNet node address on wireless slave stations.

Since DeviceNet node addresses are controlled by wireless slave stations, be sure to set the DeviceNet slaves so that there is no redundancy.

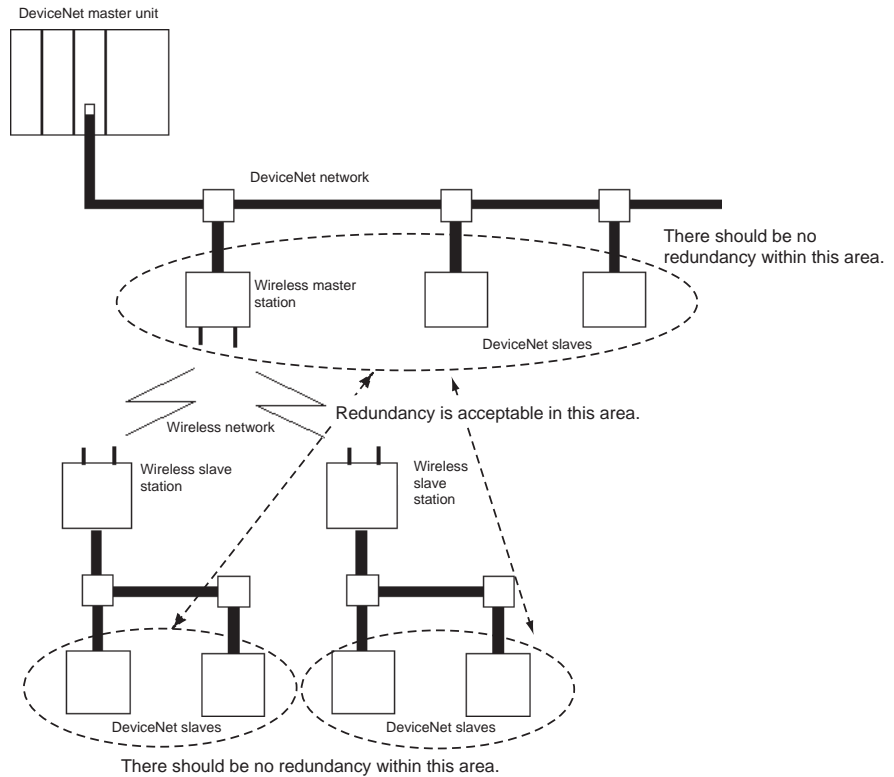

### 1-2-7 DeviceNet wireless unit default setting values

Wireless unit network default settings are on a 1:1:2 structure of wireless master station: wireless slave station: DeviceNet slave with IN/OUT = 16 points/16 points, as shown in the figure below.

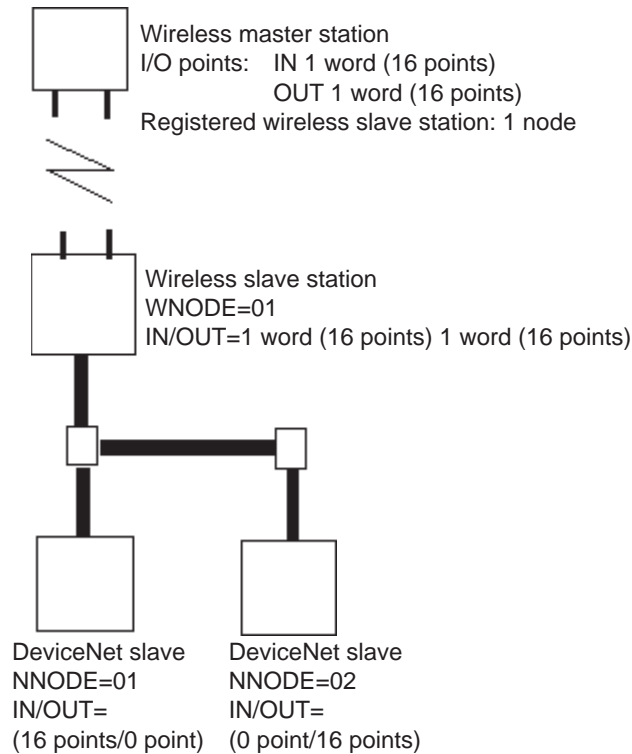

The default settings can be returned to on both wireless master stations and slave stations using the DIP switches in SET mode. Refer to *2-4 System Initial Setting and Starting Communications* for detailed setting information.

### 1-2-8 Serial Number Check

With the release of the WD30-ME with Identity Object Revision value 3.02, it has become possible to register the serial number (the wireless slave station's own unique ID) of wireless slave stations to non-volatile memory in the wireless master station.

If a wireless slave station is registered to a wireless master station using switch operations at the wireless master station, or if serial number check is enabled for the wireless slave station by editing the device parameters using the configurator, and the serial number is written, the wireless slave station's serial number is registered to the wireless master station's non-volatile memory.

This function is for preventing incorrect WNODE settings for wireless slave stations, and communications errors resulting from the effects of intermodulation.

If serial number check is enabled for all the wireless slave stations registered to a wireless master station, the dot on the right-hand side of the wireless master station's 7-segment LED lights.



Also, if serial number check is enabled for all the wireless slave stations registered to a wireless master station, and all of the wireless slave stations' serial numbers are registered to the wireless master station, the dot on the left-hand side of the wireless master station's 7-segment LED lights.

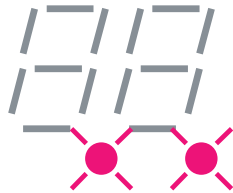

### 1-3 Configurator Outline

This is the Windows application that runs the DeviceNet computer master station.

Master and slave unit settings can be referenced (slave entry, I/O allocations, wireless network protocol parameters, commands issued), conditions monitored, used frequency bands (channels) monitored, and running tests performed from the DeviceNet configurator (Ver. 2.0 or later).

#### 1-3-1 Configuration

The computer running the Configurator is connected to the DeviceNet network by installing an OMRON DeviceNet Board in the computer or by connecting the computer to a serial communications port (peripheral port) of the CS1W-DRM21 DeviceNet Unit on a CS1-series PLC.

**Note** In both cases, the same online functions are supported.

#### 1-3-2 Operating environment

This is the operating environment for the DeviceNet configurator.

Product	Model	Contents	Method of connecting personal computer to network	Personal computer	OS
Configurator (Ver. 2.□)	WS02-CFDC1-E	Installation disk (CD-ROM)	Either one of the following methods <ul style="list-style-type: none"> <li>• Serial connection</li> <li>• Dedicated PCMCIA Card</li> <li>• Dedicated ISA Board (see table below)</li> </ul>	IBM PC/AT or compatible	Windows 95, 98, 2000 or NT4.0

**Note** Use the following dedicated Boards and Card

Model	Contents	Personal computer	OS
3G8F5-DRM21	Dedicated ISA Board and Configurator (Ver. 2.□) installation disk	IBM PC/AT or compatible	Windows 95, 98 or NT4.0
3G8E2-DRM21	Dedicated PCMCIA Card and Configurator (Ver. 2.□) installation disk		Windows 95 or 98



### **1-3-3 Outline of functions**

- Monitor the network condition of the wireless unit
- Set and reference parameters of the wireless unit (setting/referencing wireless slave entry, number of I/O points, and wireless slave station routing information)
- Monitor channels (monitor the transmission levels of used frequency bands, and keep logs)
- Running test (perform running tests according to user configurations without grouping PC and PLC applications, and leave a test log with time information)
- Wireless communication cycle time calculation

Refer to *SECTION 8 Using the Configurator* for a detailed explanation of these functions.

## 1-4 Application Limitations

The wireless unit is not designed to be compatible with every type of application that uses DeviceNet. Do not use the unit with the following applications.

1,2,3...

1. Applications that require real-time control

Do not use the unit with applications that require real-time control. In particular, it cannot be used under conditions that require responsiveness greater than that outlined in "Section 9 Communications Timing".

Applications that do not require real-time control, such as indicators, equipment error monitors, and parts picking operation, are recommended.

2. Applications that use FINS message communications

Wireless units do not support FINS message communications. For example, although CX-Programmer Ver. 2.1 and later versions support online connection (i.e., remote programming and monitoring) to PLCs on DeviceNet networks (e.g., PLCs with CS/CJ-series DeviceNet Units or programmable slaves), this functionality is not available via wireless units.

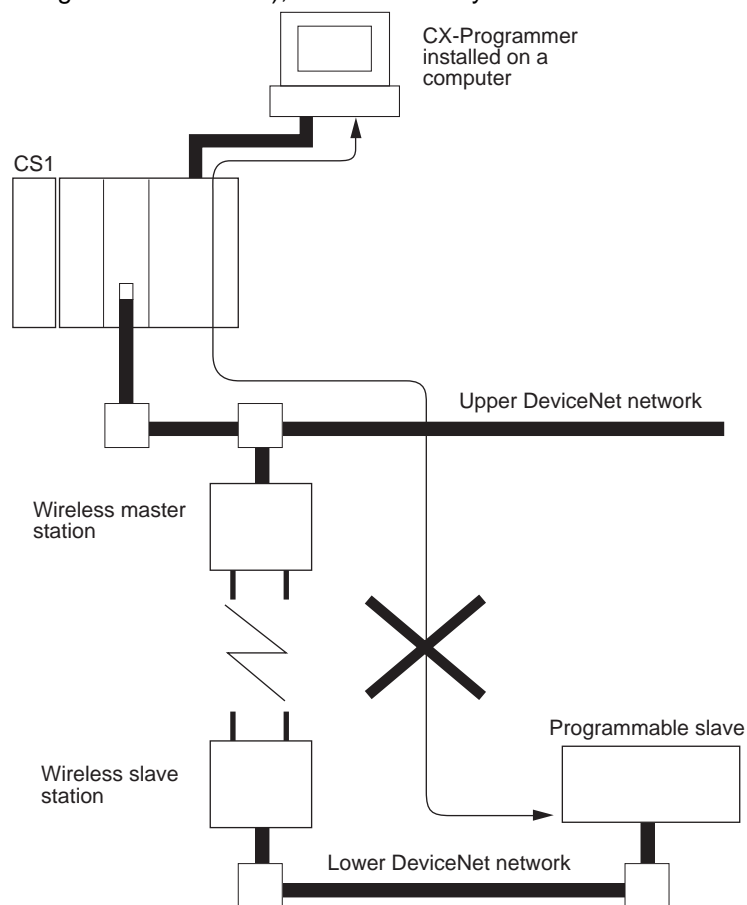

- 3. Applications that use Peer to Peer communications between the upper DeviceNet network DeviceNet master and the lower DeviceNet network DeviceNet master.

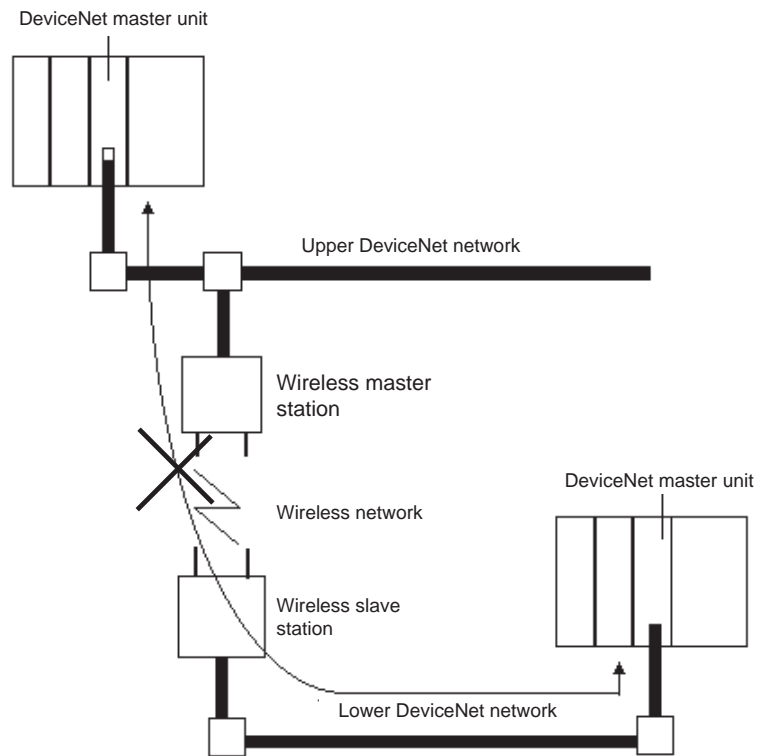

4. Applications that require setting the DeviceNet slave "Communication Error Output" to "Standby"

When a wireless slave station is reset from some error, it is possible that the DeviceNet slave output will be momentarily cleared. Therefore, applications that set the output to "Standby" during communication errors can not be used.

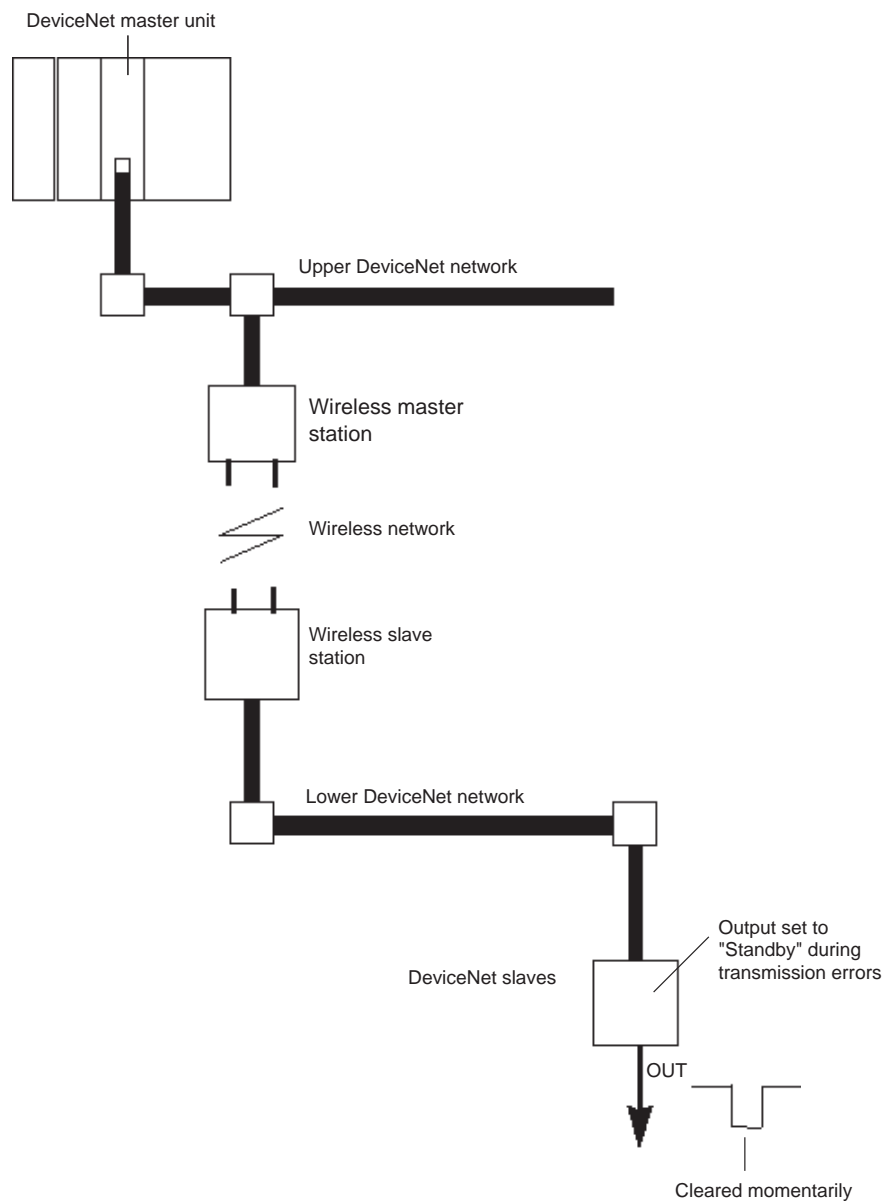

5. Applications where software reset (Explicit messages) must be performed for the slave station from the upper DeviceNet network

## 1-5 Points for Consideration with Wireless Systems

### 1-5-1 Construction of multiple wireless systems

When constructing a system for using multiple wireless master stations, the following points must be considered. Consult your OMRON representative.

**Setting wireless channels**

It is necessary to select frequencies for the wireless channels that are not interfered with by radio waves. (Radio interference can be handled by retry processes between the wireless networks, but will lengthen the system response time.)

With this unit, 34 wireless channels can be selected from. Taking the following points into consideration, however, the maximum number of wireless systems usable in a single area without radio interference is, as a rough guide, 10.

1. It is possible that, for example, there is a wireless LAN on site that uses the same frequency as this unit. Select an unused wireless channel using the Configurator's wireless channel monitor function.
2. Do not select neighboring wireless channels as they have a large amount of interference.
3. Due to the fundamental nature of radio waves, if 2 or more waves with different frequencies are output at exactly the same time, mutual interference will occur between the different frequencies, and new waves will be generated with frequencies at intervals equal to the intervals between the output frequencies. (This phenomenon is called "intermodulation.")

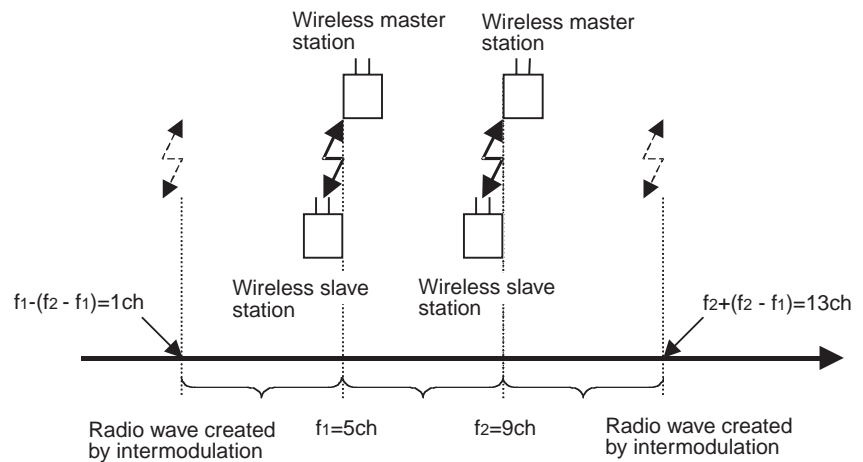

Do not select the frequencies of waves created by intermodulation.

**Antenna separation distance**

The distance between wireless units has a large influence on the amount of interference received. In particular, there may often be cases where wireless master stations are installed relatively closely to each other. Separate the antennas for different wireless master stations by at least 1 m (at least 2 m, if possible).

**Test confirmation**

Perform a test to see whether or not the wireless units are receiving interference. Using the Configurator's running test function, obtain the packet error rate, and, based on this, determine whether or not the communications quality is sufficient for the application. (As a rough guide, the packet rate should be less than 0.01.)

**Intermodulation**

Due to the fundamental nature of radio waves, if 2 or more waves with different frequencies are output at exactly the same time, mutual interference will occur between the different frequencies, and new waves will be generated with frequencies at intervals equal to the intervals between the output frequencies.

 **Caution Communications errors caused by intermodulation**

Communications errors and retry processing may occur due to intermodulation and consequently cause transmission delays. In order to eliminate the influence of intermodulation, do not set the wireless channels for wireless units in every system to frequencies at regular intervals.

Before starting operation of the wireless system using a WD30-ME with Identity Object Revision value 3.02, either register wireless slave stations to the wireless master station using switch operations at the wireless master station, or enable serial number check for the wireless slave stations using the configurator, and then register the serial numbers of the wireless slave stations to the wireless master station by writing the serial numbers.

# SECTION 2

## Hardware Settings and Checking of Operations

This section gives specific explanations of the operations and procedures necessary for you to use the DeviceNet wireless unit. Follow the explanations in this section to perform operation check procedures.

2-1	Basic Operation Procedure . . . . .	20
2-1-1	Basic operation procedures flowchart. . . . .	20
2-2	Pre-work Preparations . . . . .	22
2-2-1	Determination of system configuration . . . . .	22
2-2-2	Confirmation of specifications . . . . .	22
2-2-3	Temporary installation and installation test . . . . .	23
2-3	Hardware Settings and Wiring . . . . .	24
2-3-1	DeviceNet wireless master station settings and installation . . . . .	24
2-3-2	DeviceNet wireless slave station settings and installation . . . . .	24
2-3-3	Installation of connection equipment . . . . .	25
2-3-4	Cable connections. . . . .	25
2-4	System Initial Setting and Starting Communications . . . . .	26
2-4-1	System start. . . . .	26
2-4-2	DeviceNet slave entry. . . . .	27
2-4-3	DeviceNet wireless slave station entry . . . . .	29
2-4-4	Scan list valid settings. . . . .	31
2-5	Operation Confirmation . . . . .	31
2-5-1	Unit LED confirmation. . . . .	31
2-5-2	Status confirmation. . . . .	31
2-5-3	Confirmation by reading/writing data . . . . .	32
2-6	Other Operations. . . . .	32
2-6-1	DeviceNet wireless slave station deletion. . . . .	32
2-6-2	DeviceNet wireless master station initialization. . . . .	35
2-6-3	DeviceNet wireless slave stations initialization . . . . .	36
2-7	Deciding the Antenna Installation Position . . . . .	38
2-7-1	Example of installation inside a control panel . . . . .	41

## 2-1 Basic Operation Procedure

Specific examples illustrating the basic operation procedure of the DeviceNet wireless unit are given in this section.

### 2-1-1 Basic operation procedures flowchart

The basic operation procedure is shown below. Refer to the "DeviceNet User's Manual" and the "DeviceNet Slave Manual" for details concerning settings and connections.

#### Pre-work confirmation

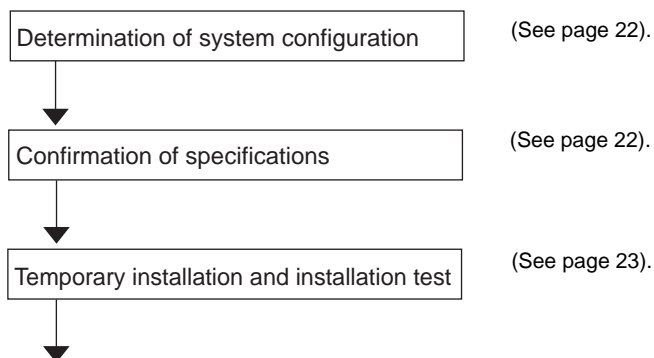

#### Hardware settings and wiring

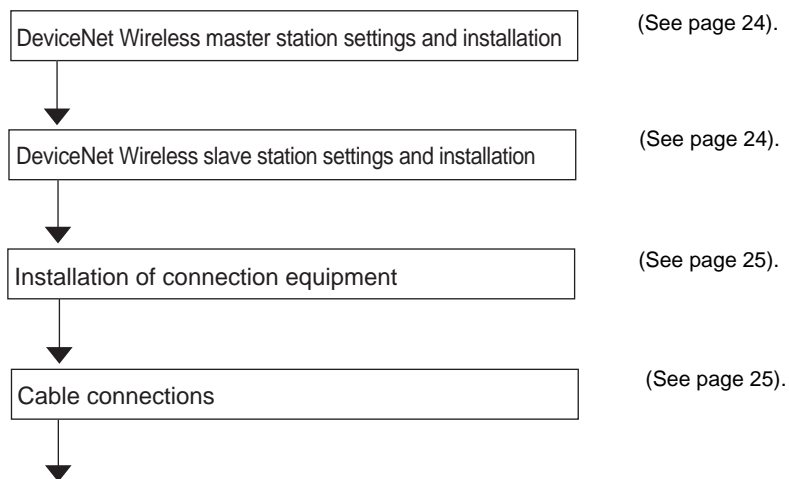

#### System initialization and starting communication

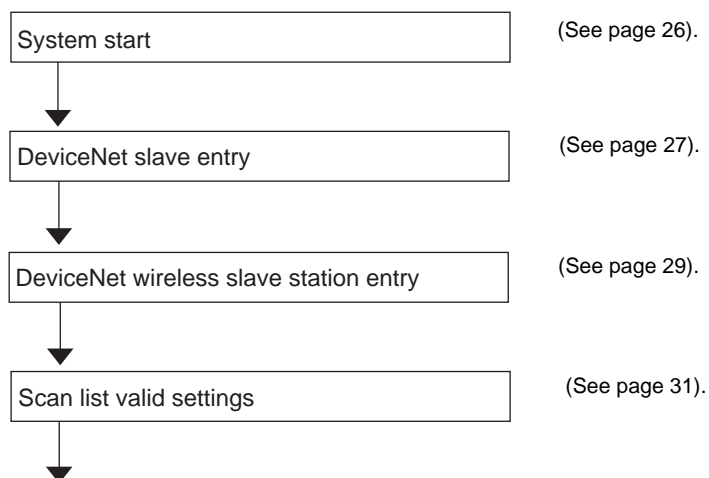



**Operation confirmation**

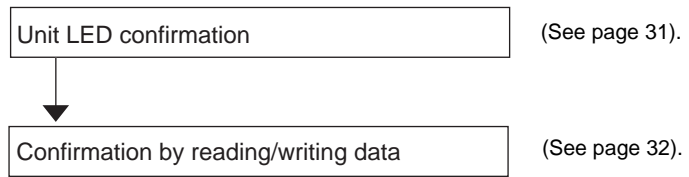

## 2-2 Pre-work Preparations

Items to be checked before performing installation work are explained here.

### 2-2-1 Determination of system configuration

A single wireless master station is limited to a maximum of 1,024 or 3,200 points, 512 (32 words) or 1,600 (100 words) points each for both IN and OUT. In addition, the maximum configuration in a wireless network of master stations to slave stations is 1 to 32 or 1 to 64, and the maximum number of IN/OUT points for the entire system is limited by the DeviceNet master unit. This should be considered carefully when determining system configuration.

#### System configuration example

In this section, the operation procedure is explained using the following system configuration as an example.

A communications power supply (Model S82K) has been purposely left out

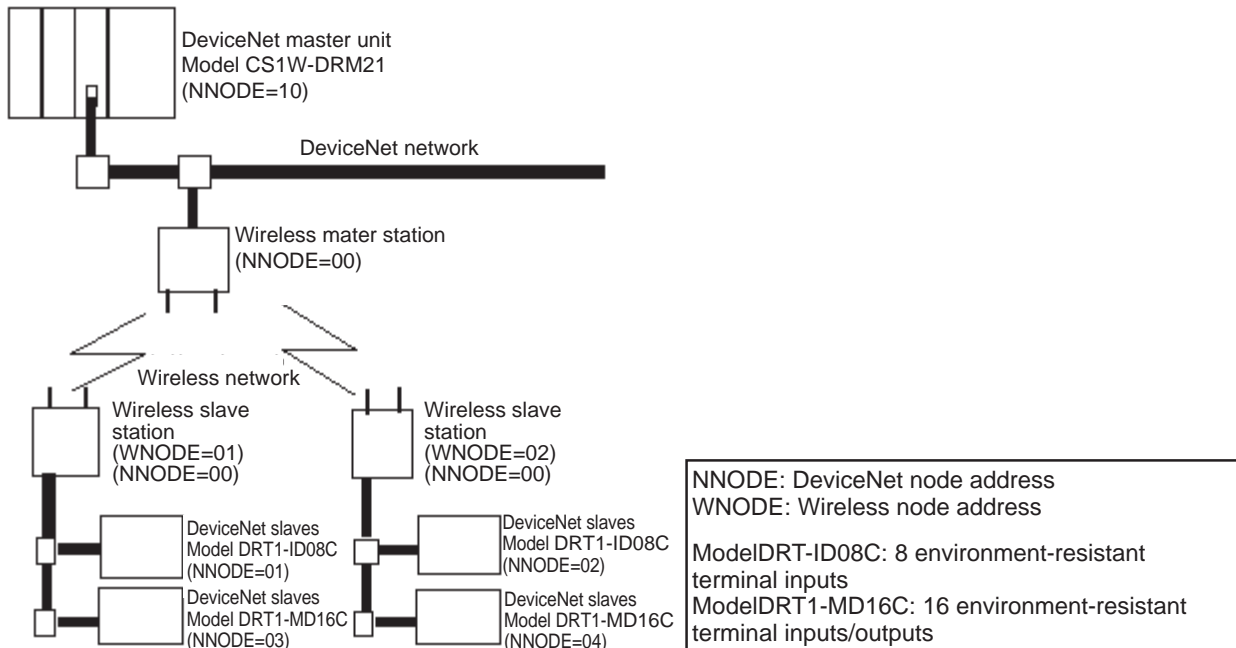

of the diagram above. It should be connected and supply power to the DeviceNet network (both upper and lower) and should be connected with terminating resistor. In addition, an external power supply should be connected to the environment-resistant terminal of the DeviceNet slave.

### 2-2-2 Confirmation of specifications

#### Confirmation of number of IN/OUT points

Confirm that the number of IN/OUT points for each wireless master station is no more than 512 or 1,600 (32 or 100 words).

In the example, the number of IN points is  $8 \times 4 = 32$ , and the number of OUT points is  $8 \times 2 = 16$ .



#### Master unit I/O limitations

A single wireless master station can control up to 512 points (or 1,600 points) for both input and output, but the number of I/O points per node is limited by the master unit. Be careful not to exceed the limit for I/O points per master unit node when constructing your system.

**Confirmation of wiring**

A special communications cable is required to connect to the DeviceNet micro-connector on the wireless unit.

In addition, if multiple DeviceNet slaves are connected, branch taps should be used as necessary. Terminators for the wireless slave station DeviceNet network should also be prepared. Refer to the "DeviceNet User's Manual" for details.

**Confirmation of communications power supply**

Since power is supplied to the wireless unit from an external communications power supply, a communications power connection must be made.

Taking the maximum current at startup into consideration, use a power supply of at least 350mA. If using an OMRON S82K or S82J switching power supply, use a model with a capacity of at least 30W (S82K) or 25W (S82J).

**2-2-3 Temporary installation and installation test**

**Temporary installation of wireless master station**

Set the switches as shown below, and temporarily fix the master station in the determined location.

Master station

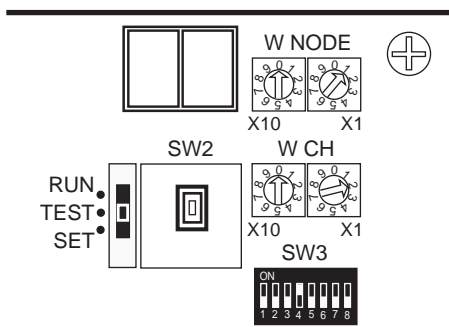

- SW3=bit4 ON (positioning test)
- Mode select switch = TEST
- WNODE = test subject's wireless slave station WNODE (This example starts at WNODE = 01.)
- WCH = 02

Connect a DeviceNet cable prepared for a micro-connector, and connect the DC24V communications power supply.

**Temporary installation of wireless slave station**

Set the switches as shown below, and temporarily fix the master station in the determined location.

Slave station

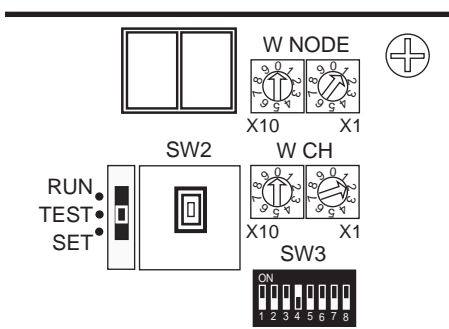

- SW3=bit4 ON (installation test)
- Mode select switch = TEST
- WNODE = WNODE for each wireless slave station (WNODE = 01 to 02 for this example.)

Connect a DeviceNet cable prepared for a micro-connector, and connect the DC24V communications power supply.

**Performing the installation test**

Perform the positioning test. (Refer to 5-2 *Installation Test* for details concerning the procedure.) Once you have confirmed that wireless communications are stable, ensure that they remain stable by securing the wireless unit in position. (Refer to 2-7 *Deciding the Antenna Installation Position* for details.) In this example, an installation test is performed between the wireless master

station and slave station 1, and the wireless master station and slave station 2.

## 2-3 Hardware Settings and Wiring

Settings and wiring to be performed before turning on the power supply to the system are explained in this section.

### 2-3-1 DeviceNet wireless master station settings and installation

**Settings**

An example setting for a wireless master station is shown below. Refer to 4-1 *DeviceNet Wireless Master Station Specifications* for details concerning setting procedures. In this example, Status is selected and IN/OUT = 512/512 points (32 words/32 words).

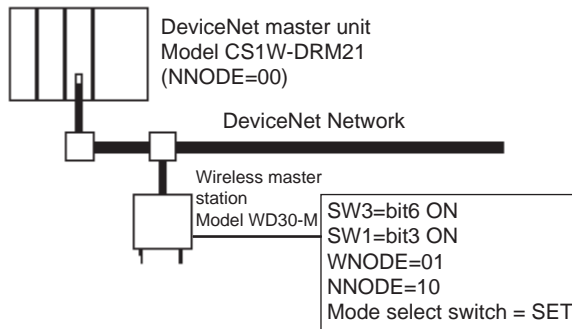

**Installation**

Use screws to firmly fix the wireless master station that has already been temporarily installed. Refer to 4-1 *DeviceNet Wireless Master Station Specifications* for details.

### 2-3-2 DeviceNet wireless slave station settings and installation

**Settings**

Settings example for each wireless slave station are shown below. Refer to 4-2 *DeviceNet Wireless Slave Station Specifications* for details concerning the setting procedure.

In this example, the default settings should be used for all DeviceNet settings apart from the node address. Refer to the "DeviceNet Slave Manual" for details concerning the settings for each DeviceNet slave.



**Terminating resistor installation**

Terminating resistors are required not only for the wireless master station, but also on both ends of the wireless slave stations' DeviceNet network.

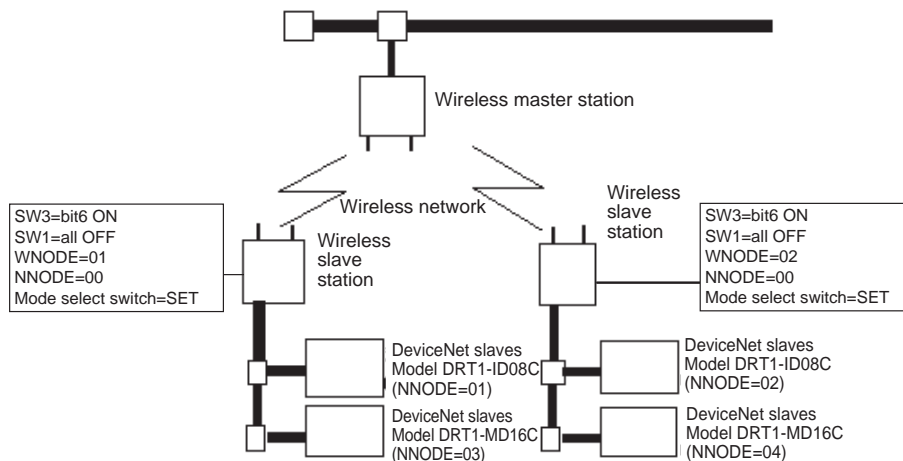

**Installation**

Use screws to firmly fix the wireless slave stations that have already been temporarily installed. Refer to *4-2 DeviceNet Wireless Slave Station Specifications* for details.

**2-3-3 Installation of connection equipment**

Connection equipment that requires installation is listed below.

- Shielded T-type branch connector
- Shielded terminating resistor
- Communications power supply (DC24V)

**2-3-4 Cable connections**

Connect a DeviceNet cable prepared for micro-connectors to the wireless master and slave stations.

Connect the cables to the DeviceNet master (C200HW-DRM21-V1) and the DeviceNet slave (environment-resistant terminal) to create the complete physical system network.

Example 1:

Connecting the cable on the side and installing a terminating resistor

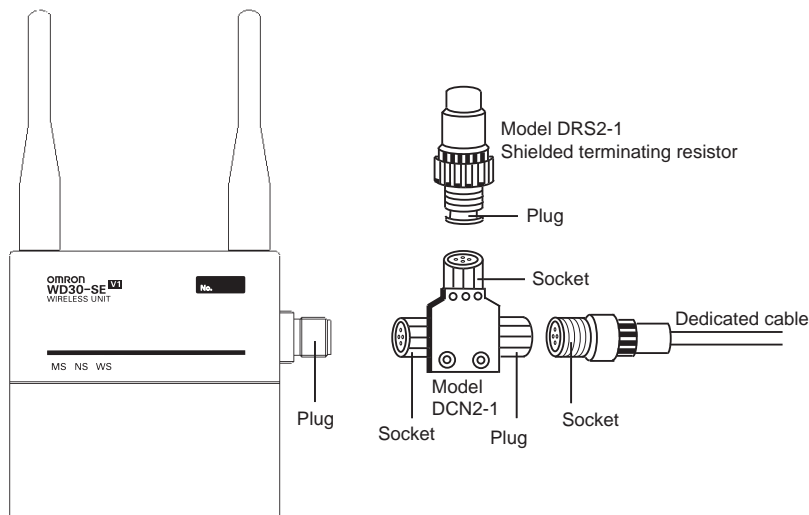

Example 2:

Connecting the cable to the top, and installing a terminating resistor

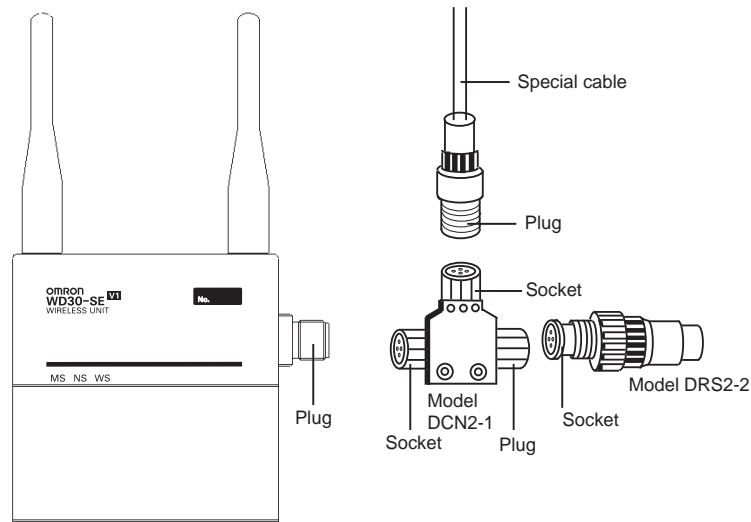

Example 3:

Connecting the cable to the bottom, and installing a terminating resistor

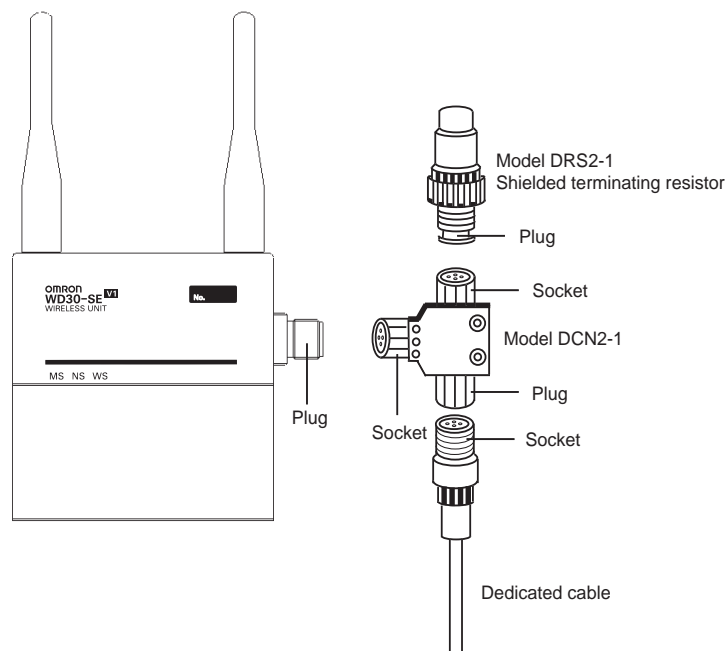

## 2-4 System Initial Setting and Starting Communications

The required entries, and deletion and initialization procedures following system start are explained in this section.

### 2-4-1 System start

Turn on the communications power source and the node power supply in the following order.

- 1,2,3...**
1. DeviceNet slave (environment-resistant terminal) external power supply
  2. DeviceNet master (C200HW-DRM21-V1) power supply

It is also OK to turn all power supplies on simultaneously.

### 2-4-2 DeviceNet slave entry

Register the number of DeviceNet slave I/O points in the wireless slave station.

If the same system configuration as for the network default settings (Refer to 1-2 Basic Functions of the DeviceNet Wireless Unit.) is used, there is no need to do this registration.

The specifics of this example are explained below.

First, begin with the WNODE = 1 wireless slave station.

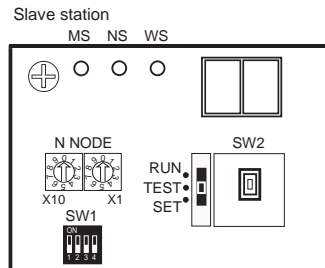

1. Confirm that the slave station node address (NNODE) is not doubled with the DeviceNet slave. In this example, NNODE-00 is OK.

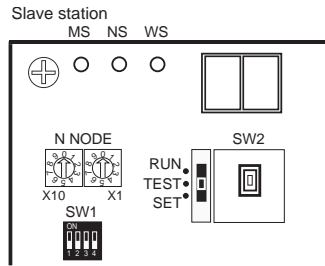

2. Check if the communications rate for the slave station and the DeviceNet slave is the same. In this example, since default settings (125kbps) are used, all of the bits for SW1 should be OFF.

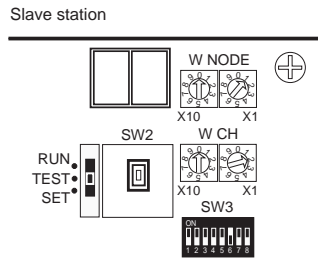

3. Since the DeviceNet slave is registered, set SW3 to "bit 6 = ON".

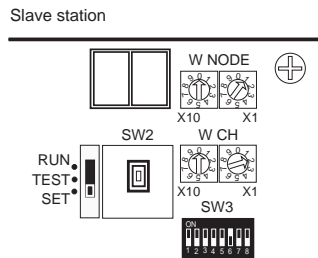

4. Set the mode select switch to "SET".

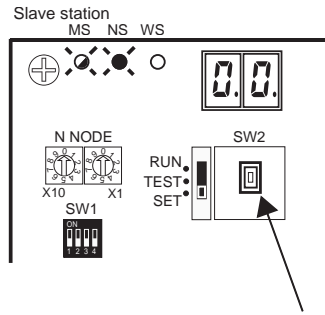

5. Turn ON the wireless slave station communications power supply. After confirming that the LED display shows a decimal point display (scan list invalid mode) and the NS LED lights green, push SW2.

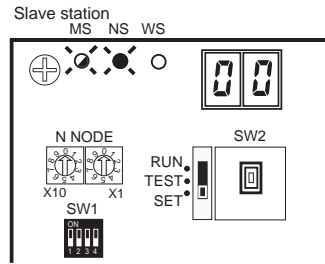

6. Once the decimal point display has disappeared from the LED display, DeviceNet slave entry is complete. (scan list valid mode)

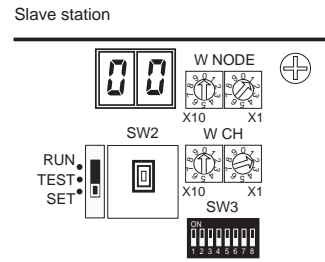

7. Set SW3 to "bit 6 = OFF".

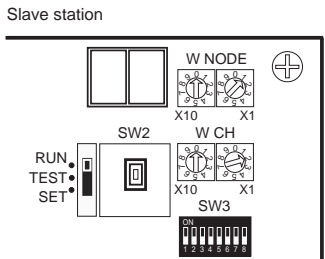

8. Set the mode select switch to "RUN".

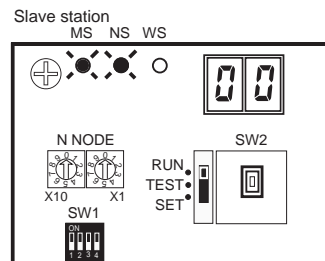

9. If the NS LED lights green and the LED display shows the node address, the system is in RUN operation status.

The operation for the WNODE = 2 wireless slave station is the same as steps (1) through (9) above.



### 2-4-3 DeviceNet wireless slave station entry

Enter the wireless slave station in the wireless master station.

If the same system configuration as for the network default settings (Refer to 1-2 Basic Functions of the DeviceNet Wireless Unit.) is used, there is no need to do this registration. In addition, when not using the WNODE = 1 wireless slave station (entry is complete with default settings when sent from the factory), it must be deleted before proceeding with entry.

The specifics of this example are explained below.

First, begin with the WNODE = 1 wireless slave station.

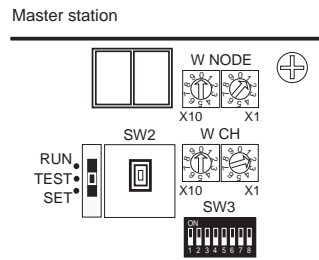

1. Use the wireless master station WNODE = 1.

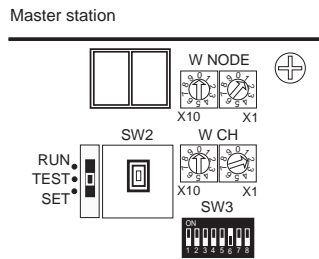

2. To enter the wireless slave station, set SW3 to "bit 6 = ON".

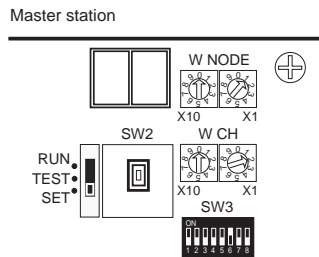

3. Set the wireless master station mode select switch to "SET".

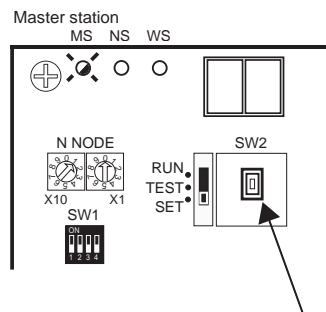

4. Turn ON the wireless master station communications power supply. Once the MS LED flashes green and SW2 is pressed, the addition of the wireless slave station begins.

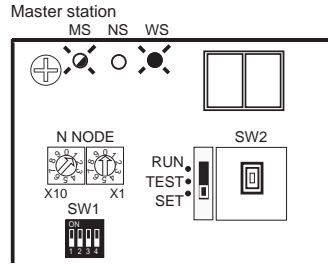

5. Once communication has begun with the wireless slave station, the WS LED lights green, the number of IN/OUT points are acquired, and a check is performed on the total number of points. If the check is OK, entry is performed automatically.

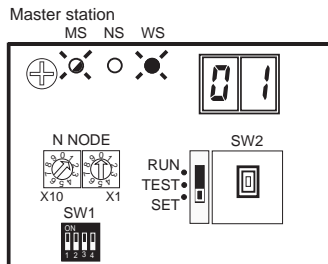

6. If entry is completed correctly, the registered WNODE (01 for this example) is shown in the LED display.

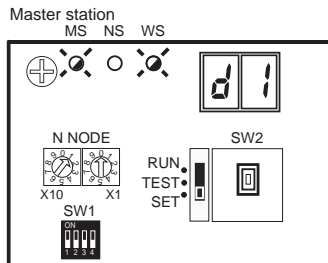

7. If entry fails, the WS LED flashed red, and the error condition is shown in the LED display.

8. The registration for the WNODE = 2 wireless slave station is the same as steps (1) through (7) above. This procedure completes the registration of all wireless slave stations.

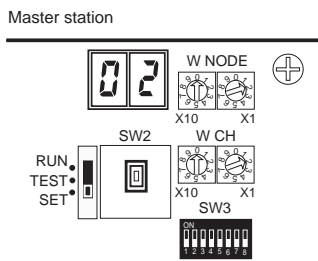

9. Set SW3 to "bit 6 = OFF".

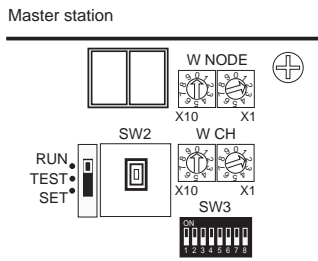

10. Set the mode select switch to "RUN".

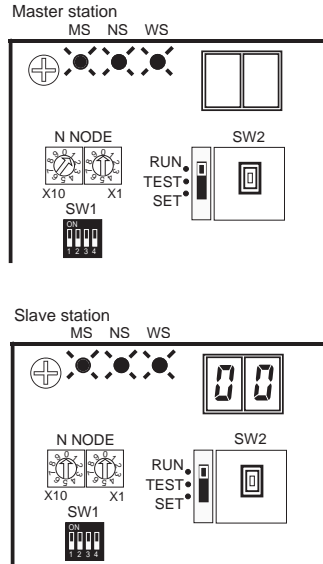

11. If the MS, NS, and WS LEDs all light green and nothing is shown in the LED display, the system is in RUN operation status.

12. At this point, the MS, NS, and WS LEDs on each wireless slave station light green, too, and the node addresses (NNODE = 0) are shown in the LED displays.

### 2-4-4 Scan list valid settings

Scan list creation and entry and the scan list valid mode are performed from the DeviceNet master (C200HW-DRM21-V1). Refer to the "DeviceNet User's Manual" for details.

## 2-5 Operation Confirmation

The confirmation procedure for whether or not remote I/O communications are performed correctly is explained in this section.

### 2-5-1 Unit LED confirmation

If the MS and NS LEDs on all DeviceNet slaves (environment-resistant terminals) light green, the node address is shown on the DeviceNet master (C200HW-DRM21-V1) LED display (the decimal display disappears), and the MS and NS LEDs light green, wireless remote I/O communications are operating correctly in scan list enable mode.

### 2-5-2 Status confirmation

If the STATUS setting is made, status information is automatically assigned to the 2 words at the top of the IN area. (The position is fixed.)

The IN/OUT data for DeviceNet slaves (environment-resistant terminals) is first assigned to the IN areas and OUT areas by the wireless slave stations in ascending order of WNODE and is then assigned by the wireless master stations in ascending order of NNODE (1 to 4 in this example).

The IN and OUT areas are allocated in units of 16 points (1 word). Because the slaves are 8-point units, the lower bytes (bits 0 to 7) are allocated and the upper bytes (bits 8 to 15) are set to 00 Hex.



### Replacing wireless slave stations

When a wireless slave station has been replaced, with reference to 2-4-2 *DeviceNet slave entry*, register the new wireless slave station to the wireless master station using switch operations at the wireless master station, or, with reference to *SECTION 8 Using the Configurator*, update the serial number for the wireless slave station held at the wireless master station by writing the serial number. If the DeviceNet wireless slave station is not registered, or the serial number is not written, because the wireless master station will use the previous wireless slave station's serial number, communications will not be possible with the new wireless slave station.

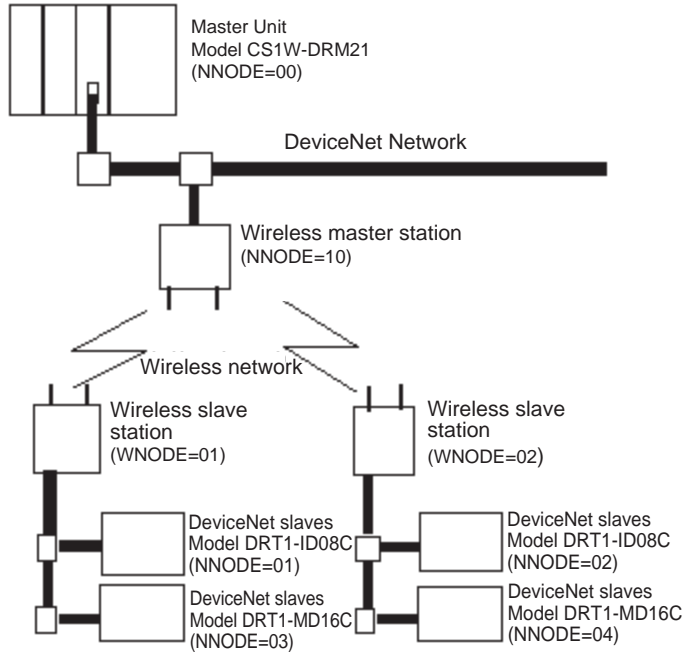
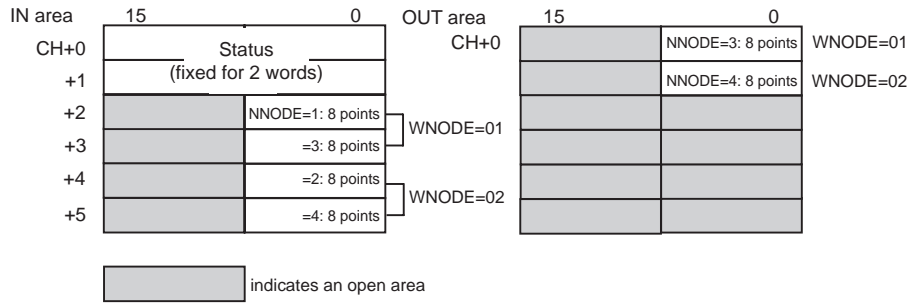

### 2-5-3 Confirmation by reading/writing data

Connect the computer's peripheral tools to the master, read and write from and to the OUT and IN areas of the DeviceNet master unit (C200HW-DRM21-V1), and confirm that this is reflected correctly on the DeviceNet slave (environment-resistant terminal).

## 2-6 Other Operations

### 2-6-1 DeviceNet wireless slave station deletion

Wireless slave stations you want to remove from the system can be deleted. When creating a system that does not use a WNODE = 1 wireless slave station, the WNODE = 1 slave station (registered as the default before being shipped from the factory) should be deleted before performing the entry procedure.

Deletion example

Delete the WNODE = 1 wireless slave station from the system shown below.

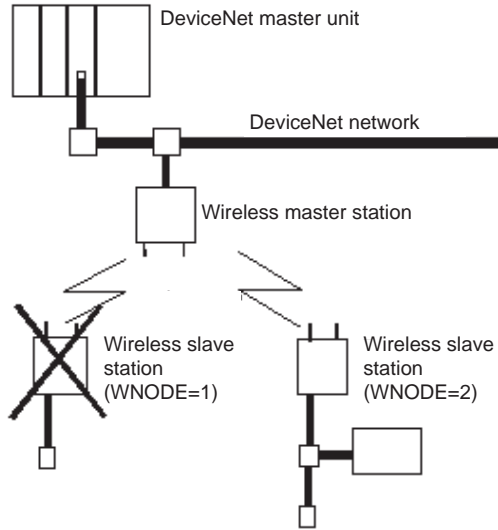

Procedure

Master station

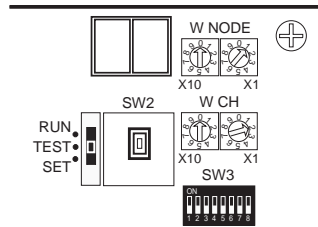

1. Align with the wireless slave station WNODE = 1 that will delete the wireless master station WNODE.

Master station

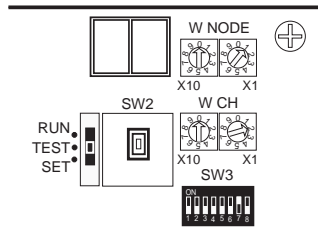

2. To delete the wireless slave station, set SW3 to "bit 7 = ON".

Master station  
MS NS WS

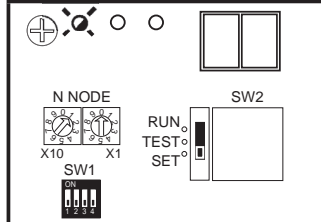

3. Set the wireless master station mode select switch to "SET". The NS LED goes off, and the MS LED flashes green.

Master station  
MS NS WS

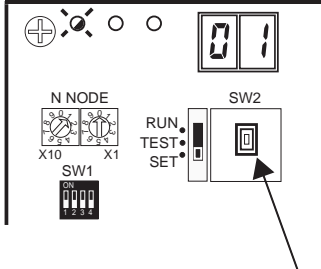

4. "01", the item to be deleted, will be shown in the LED display.

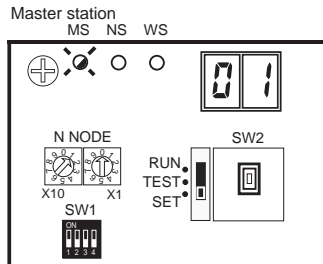

5. Push SW2 to delete the item.

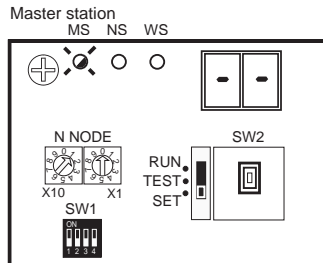

6. Once deletion is complete, "--" is shown in the LED display.

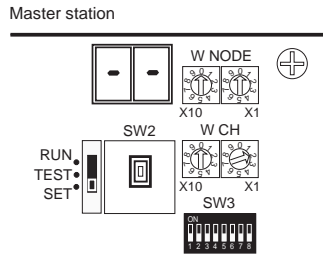

7. Set SW3 to "bit 7 = OFF".

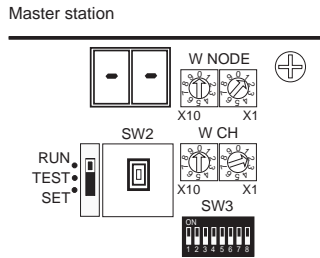

8. Set the mode select switch to "RUN".

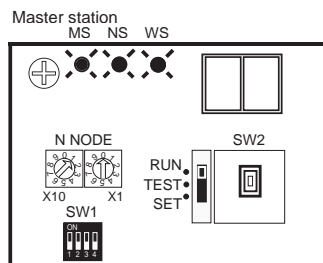

9. If all MS, NS, and WS LEDs light green and the LED display goes off, the system is in RUN operation status.

## 2-6-2 DeviceNet wireless master station initialization

Initialize all registered IN/OUT points to their default settings.

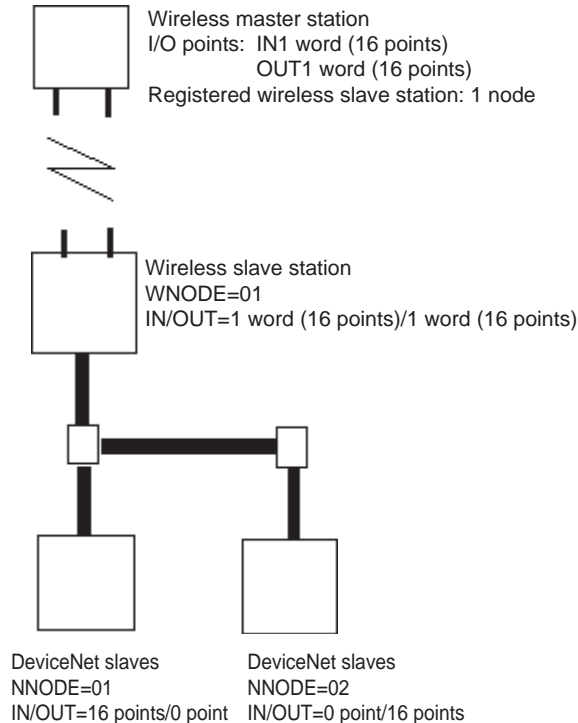

### Procedure

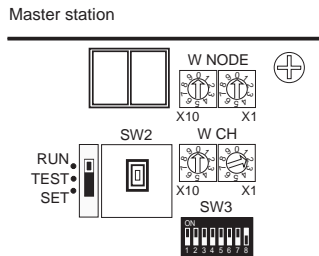

1. Set SW3 to "bit 8 = ON".

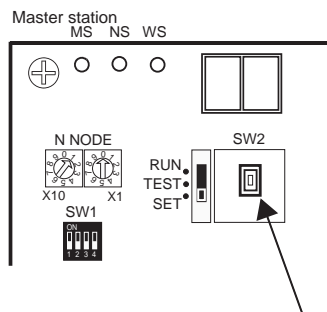

2. While holding down SW2, set the mode select switch to "SET".

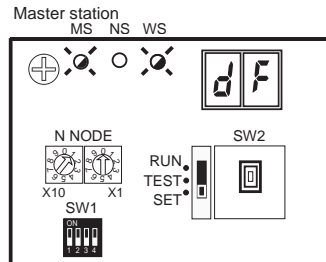

- Once initialization is complete, "dF" is shown in the LED display, the MS and WS LEDs flash green, and the NS LED goes off.

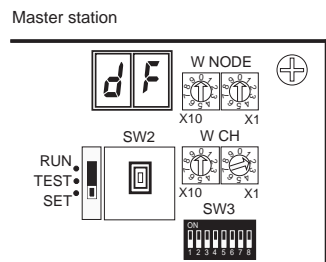

- Set SW3 to "bit 8 = OFF".

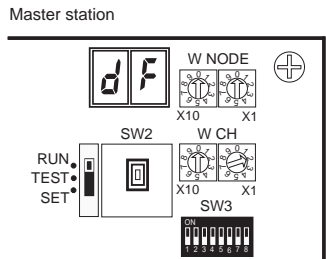

- Set the mode select switch to "RUN".

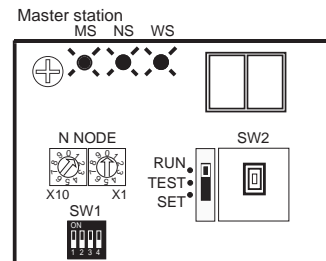

- If all MS and NS LEDs light green and the LED display goes off, the system is in RUN operation status. However, while the WS LED lights green, "E2" is shown in the LED display.

### 2-6-3 DeviceNet wireless slave stations initialization

Initialize all registered IN/OUT points to their default settings.



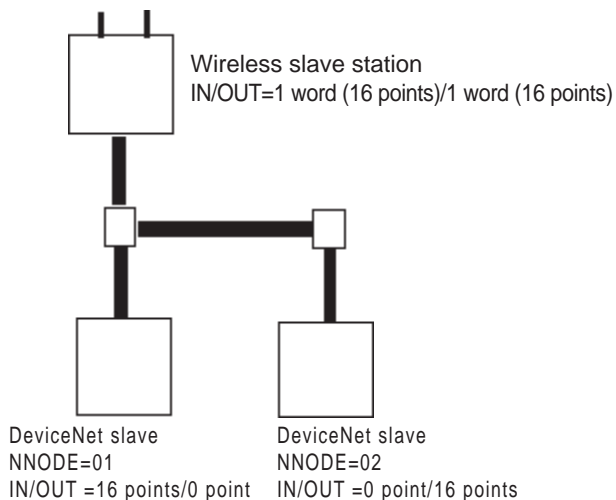

**Procedure**

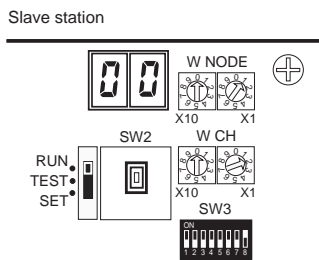

1. Set SW3 to "bit 8 = ON".

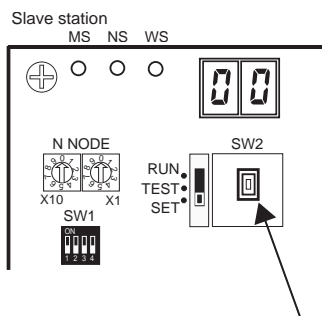

2. While holding down SW2, set the mode select switch to "SET".

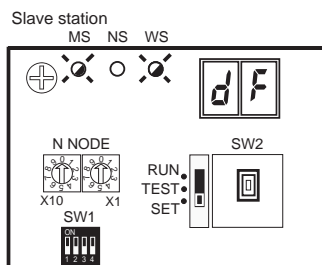

3. Once initialization is complete, "dF" is shown in the LED display, the MS and WS LEDs flash green, and the NS LED goes off.

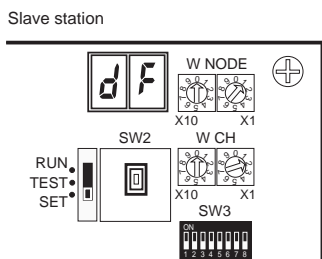

4. Set SW3 to "bit 8 = OFF".

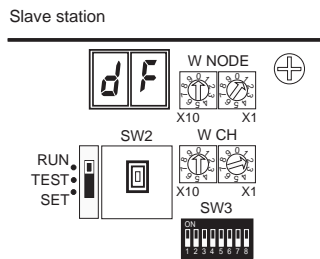

5. Set the mode select switch to "RUN".

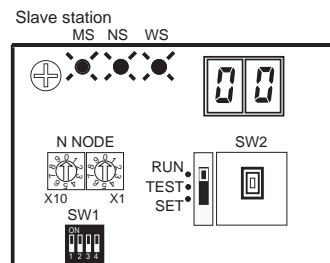

6. If all MS and NS LEDs light green and the node address is shown in the LED display, the system is in RUN operation status.

## 2-7 Deciding the Antenna Installation Position

This unit uses radio waves of frequency 2.4GHz, which is very high. High-frequency waves exhibit strong rectilinear propagation and are reflected easily. For this reason, careful consideration of the antenna installation position is required to achieve sufficient wireless performance.

1. If possible, install antennas so that there is a direct line of sight between them.

High-frequency waves, which exhibit strong rectilinear propagation, are used and so it is difficult for the waves to reach areas that are not in a direct line of sight, as shown in the following diagram. This is a particularly important point for communications at long distances (e.g., exceeding 50m or 60m.)

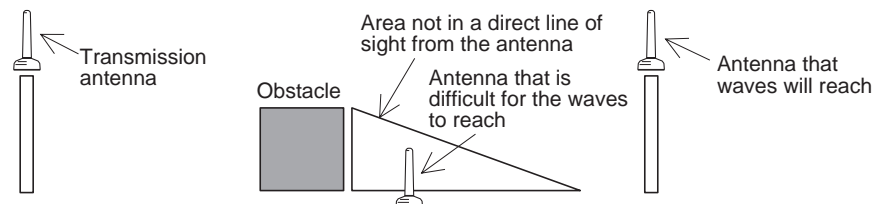

If the antennas are installed in locations with relatively high ceilings and a lot of open space, even if there is no direct line of sight between the antennas, if one of the antennas is installed in a high location, communications may still be possible via radio waves that are reflected off the ceiling.

2. Install in as high a location as possible.

As mentioned in the preceding paragraph, if the antennas are installed in high locations, because the space surrounding the antennas will be more open, there will be less influence from obstacles, and the radio waves will

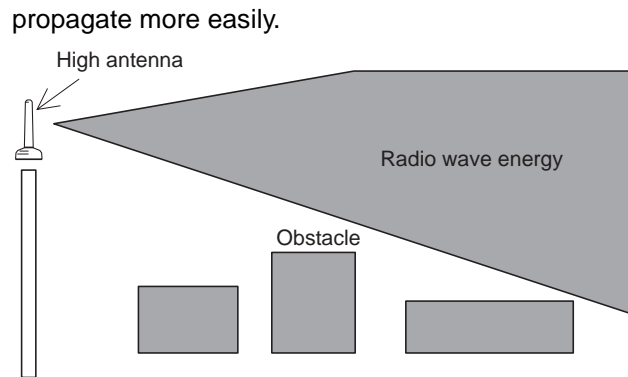

3. Do not place obstacles (especially metal objects) near the antennas.  
If there are obstacles near the antennas (in particular, in the direction of radio wave propagation), the radio waves may not be propagated due to the influence of the objects. Metal objects have the largest influence as they reflect radio waves, whereas glass and plastic objects allow the waves to pass through and so have the smallest influence. Ensure a distance of at least 30cm between obstacles and antennas.
4. Cable loss in magnet-base antennas  
With magnet-base antennas (WD30-ME01/-SE01), there is loss in the 2m antenna cable. This means that the maximum communications distance is shorter than with the pencil antennas. As a rough guide, the maximum communications distance is approximately 50m indoors.
5. Cable bending radius for magnet-base antennas  
The minimum bending radius for magnet-base antennas (WD30-ME01/-SE01) is 38mm. Also, do not bend the cable at points less than 40mm from the end connected to the station or at points less than 20mm from the end connected to the antenna.
6. Separate different sets of antennas as much as possible.  
If different sets of antennas are close to each other, they will influence each other and thereby influence wireless communications, causing an increase in the number of retries and a reduction in the possible communications distance. Separate different sets of antennas by at least 1m (at least 2m if possible).
7. Do not install the 2 magnet-base antennas close to each other.  
If the 2 antennas are close to each other, the diversity effect will not be utilized. Separate the antennas by at least 62mm (as with pencil antennas). Magnet-mounting allows the positions to be adjusted easily. If possible, separate the antennas by a greater distance than this.
8. Install the antennas with the same orientation.  
Install antennas that are performing communications with the same orientation, as shown in the following diagram. If they are installed at an angle of 90° to each other, the possible communications distance will be shortened. (In this case, the waves are said to be “polarized.”)



9. Separate the antennas from ID tags by at least 3m.

The OMRON V690 microwave RF-ID system uses frequencies within the range used by the wireless unit and so if they are used on the same floor, observe the following points when installing.

- Separate the antennas and ID tags by at least 3m.
- Set frequencies outside the range 12CH to 30CH.

10. Direction of waves emitted from the antennas

Antennas emit waves in certain directions, and there are certain directions in which waves are received easily. These directions are known as the “directional characteristics.” The directional characteristics for pencil antennas and magnet-base antennas when they are installed vertically are donut-shaped, spreading outwards horizontally. Radio waves are emitted in every horizontal direction but are not emitted upwards or downwards.

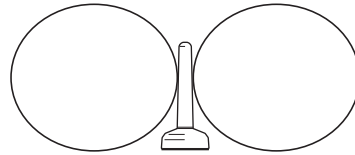

11. Other points about magnet-base antennas

- The magnet on the magnet-base antenna is very strong. Do not remove the antenna by pulling on the cover or cable. Doing so may damage the antenna. Be sure to hold the base when handling the antenna.
- Twist the cable as little as possible.
- Before mounting the antenna to the wireless unit, check that the plug and jack are properly connected and then tighten them by twisting the ring nut. When mounting, twist only the ring nut; do not twist the cable.
- Design the hole for passing the cable through so that the cable is protected.

2-7-1 Example of installation inside a control panel

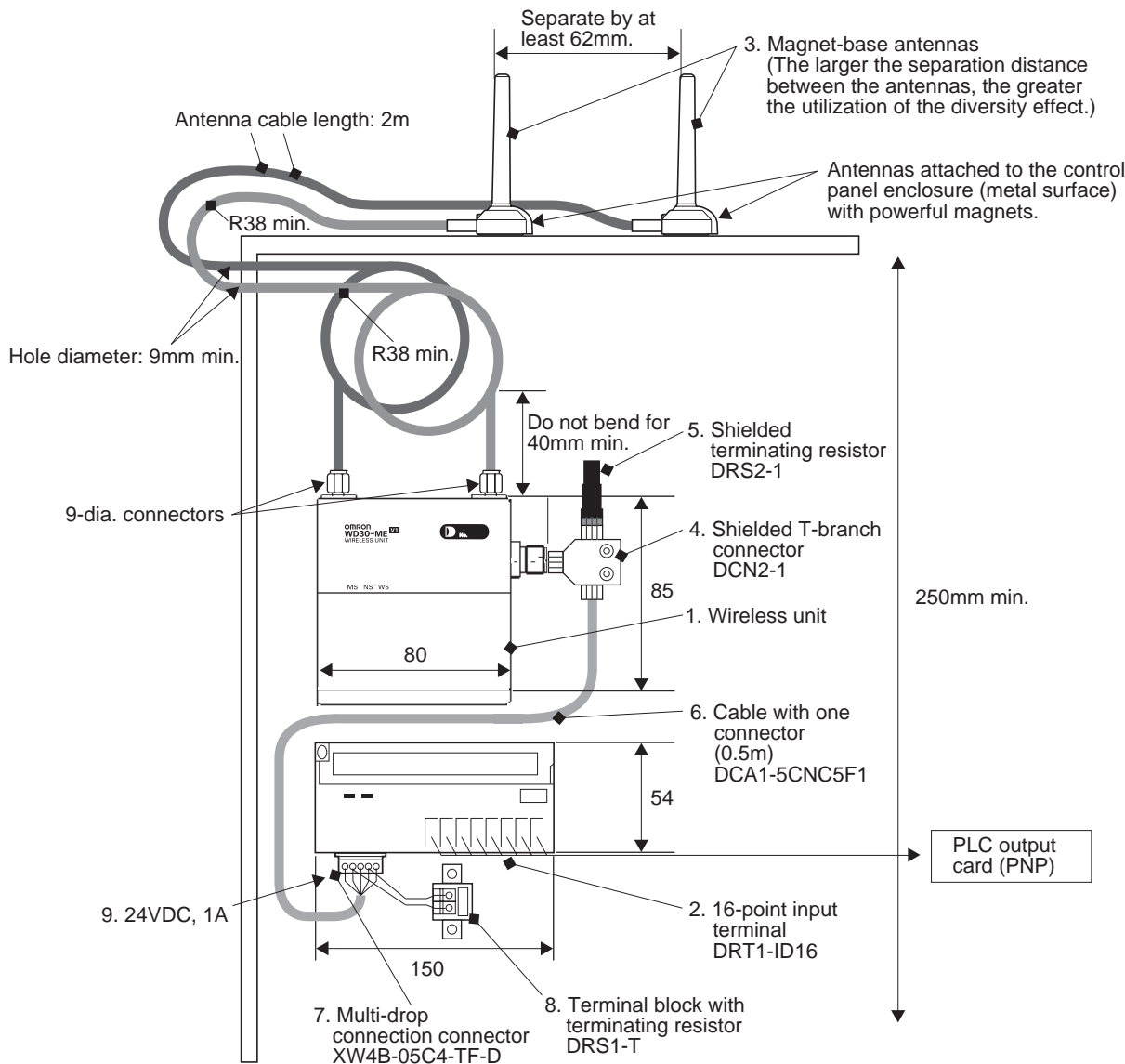

1. The wireless unit (1) is installed in the control panel using the two M4 screws provided.
2. The 16-point input terminal (2) is installed in the control panel using DIN track or two M4 screws.
3. The antennas are attached to the control panel with magnets and the antenna cables are fed into the control panel where they are connected to the wireless unit (1) with connectors.
4. A shielded T-branch connector (4) is connected to the wireless unit (1), and a shielded terminating resistor (5) and a cable with one connector (6) are connected to it.
5. Wire the DeviceNet cable (of 6), the terminal block with a terminating resistor (8), and the DC24V, 1A power supply (for the wireless unit (1) and the 16-point input terminal (2)) to the multi-drop connection connector (7).
6. Wire the contact signals of the 16-point input terminal (2) to the PLC's output card (PNP). Use a separate power supply for I/O.



# SECTION 3

## Sample Program

This section contains an example program for monitoring the status of the DeviceNet wireless unit.

3-1	Status Monitoring Program Example . . . . .	44
3-1-1	Reading the DeviceNet master status of the lower network . . . . .	44
3-2	Example of Using an Explicit Message . . . . .	49
3-2-1	Reading reception data from port 1 of the DRT1-232C . . . . .	50

### 3-1 Status Monitoring Program Example

An example of a status monitoring program for the DeviceNet wireless unit is given below.

In this example, the status of the DeviceNet wireless unit is checked at the PLC CPU unit. If an error flag has occurred, an Explicit message command to read the DeviceNet master status in the lower network where the wireless slave station is connected will be issued.

In order to assign a status to the IN area, bit 3 of SW1 on the wireless master station should be turned ON beforehand.

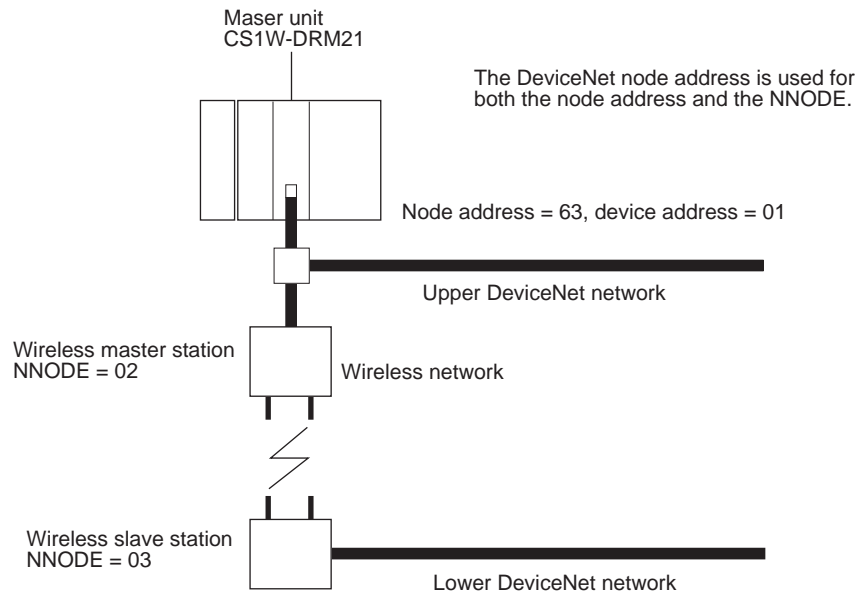

The IN area allocation for the wireless master station at the CS1 is shown below.

	15	14	13	12	11	10	9	8	7	6	5	4	3	2	1	0	Bit
Wd 3300	16	15	14	13	12	11	10	9	8	7	6	5	4	3	2	1	Status
Wd 3301	32	31	30	29	28	27	26	25	24	23	22	21	20	19	18	17	Status
Wd 3302	48	47	46	45	44	43	42	41	40	39	38	37	36	35	34	33	Status
Wd 3303	64	63	62	61	60	59	58	57	56	55	54	53	52	51	50	49	Status

#### 3-1-1 Reading the DeviceNet master status of the lower network

The status assigned to the IN area of the master is monitored. Since the bit for WNODE = 3 is 1, Instance ID is set to "03" and an Explicit message (DeviceNet master status read) command is issued to the wireless slave station.



**Ladder program**

000000

```

-----:-----
Data work area name:           Data memory
Data work area beginning address: D00000
CMND command control data:     D00000
CMND command transmission buffer: D00006
CMND command reception buffer:  D00011
-----:-----

Bit work area name:           I/O bits
Bit work area beginning address: 0000.00
Startup request bit:           0001.00
Processing completion bit:       0001.03
Normal completion bit:          0003.00
Error completion bit:           0003.01
Processing forced completion bit: 0000.00
-----:-----

Channels allocated to the data work area: D00000 to D00019
Channels allocated to the bit work area:  0000.00 to 0003.15
-----:-----

Read data beginning address:  D00015
Number of read data bytes:    10
-----:-----

Explicit message command format:
2801 02 0E 00AA 0003 67

Explicit message response format:
2801 0000 0004 02 8E xxxx
    
```

000001  
(000000)

Interlock condition

a02 a10 a17 a20  
a26 a30 a45 a51  
a54 a57

000002  
(000002)

CMND command control data settings

- 1) Number of command bytes (0x0009)
- 2) Number of response bytes (0x000A)
- 3) DNA (0x0000)
- 4) DA1 (0x000), DA2 (0x11)
- 5) Port number (0x07); number of retries (0x00)
- 6) Response monitoring time (0x0032)

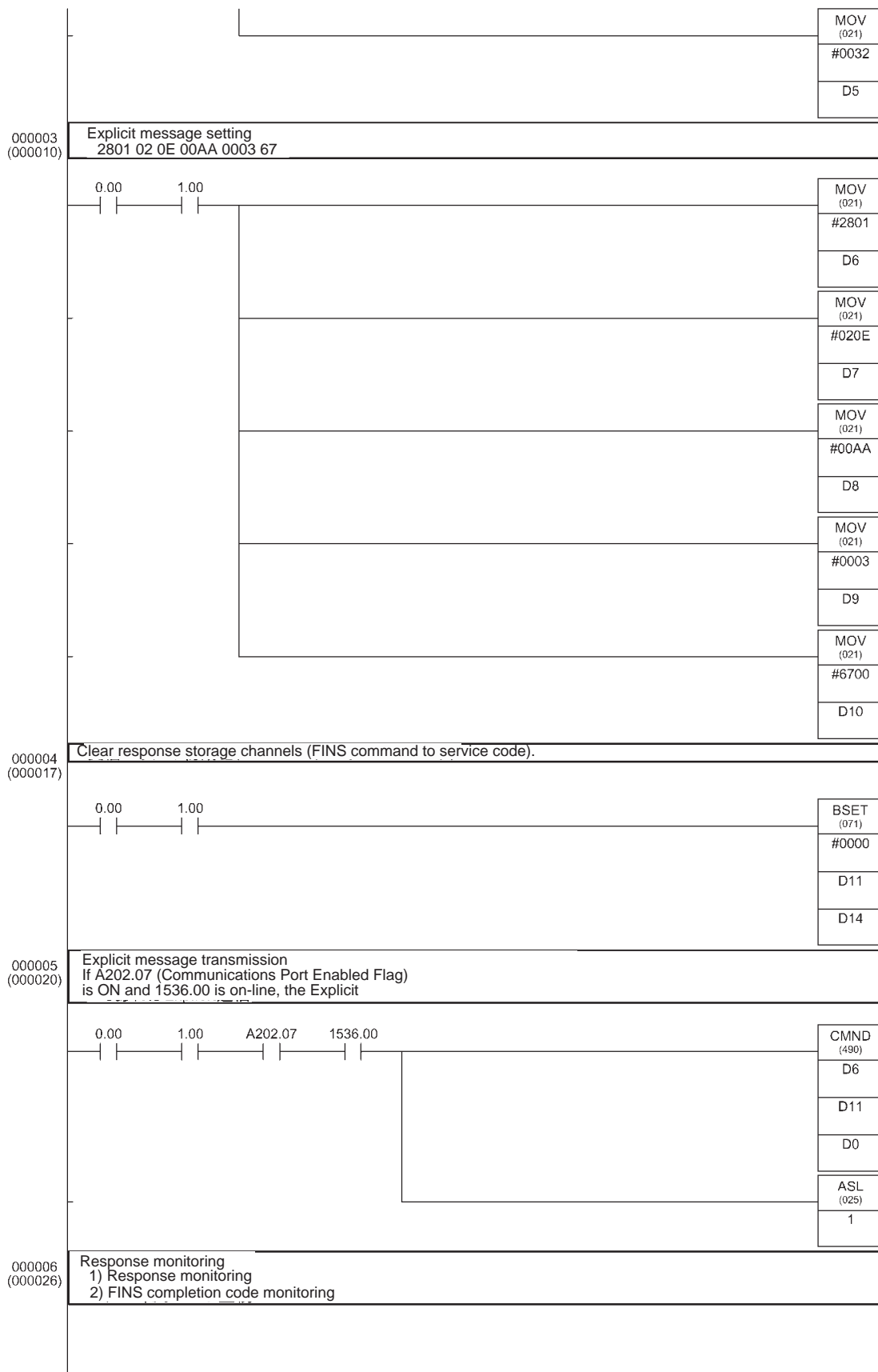

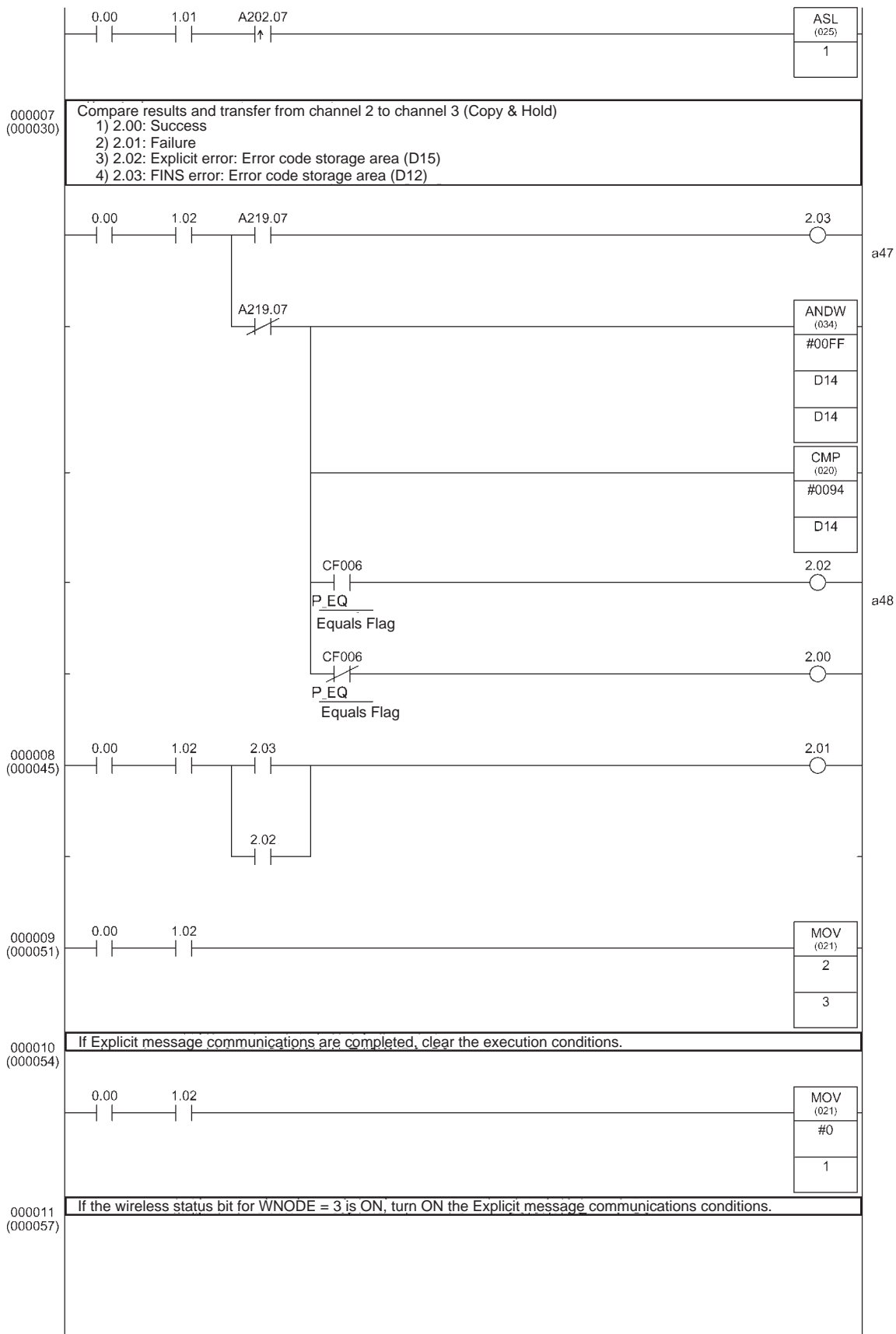



**Responses**

If reading is performed without error, the following responses are stored.

Word	Contents (Hex)	Definition
DM00011	28 01	Explicit message command code = 28 01 Hex
DM00012	00 00	End code (0000 Hex: normal end)
DM00013	00 04	Number of bytes received (data length after DM00014) = 4 bytes
DM00014	00 8E	Transmission source node address 00, ServiceCode = 8E Hex
DM00015	XX XX	Status of read DeviceNet master

### 3-2 Example of Using an Explicit Message

An example of a program that transmits an Explicit message via the DeviceNet wireless unit is given below.

In this example, an Explicit message is sent to the DRT1-232C to read data received by the DRT1-232C in the system configuration shown below.

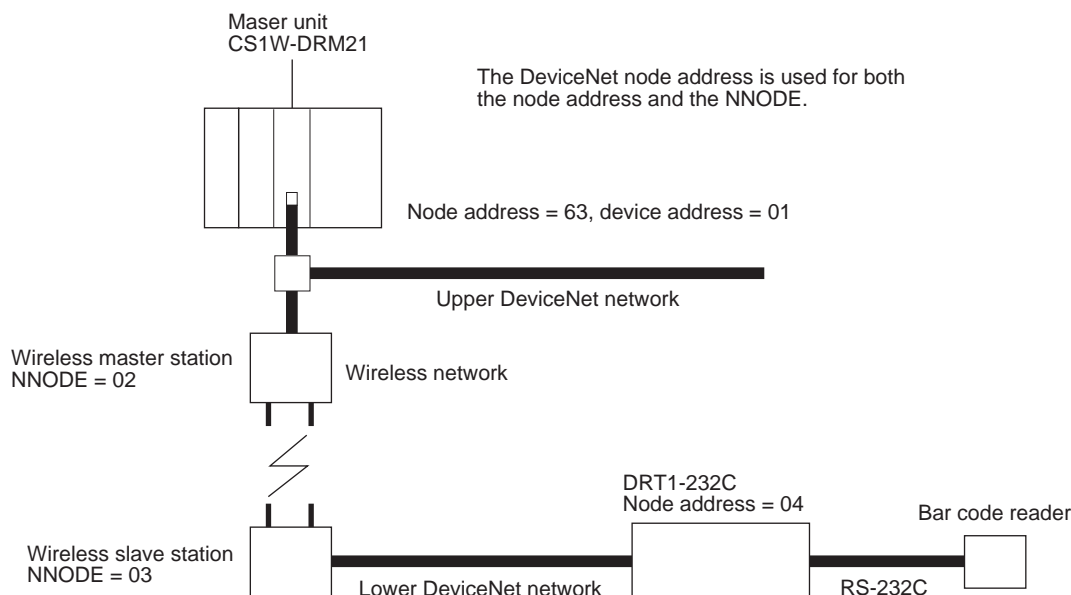

The IN area allocation for the DRT1-232C at the CS1 is shown below.

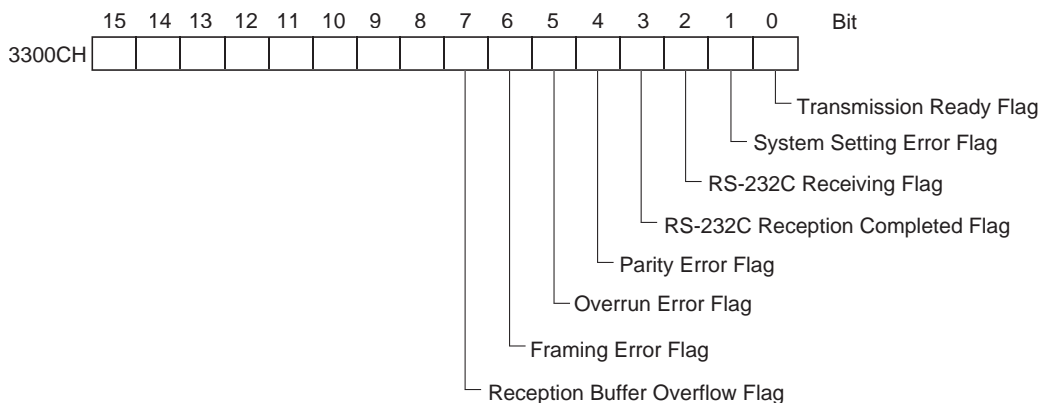

### 3-2-1 Reading reception data from port 1 of the DRT1-232C

Data received at port 1 of the DRT1-232C and stored in the reception buffer is read to the DM Area. Data is read as soon as it is stored in the reception buffer. Response data for Explicit messages is stored after DM15.

#### Ladder program

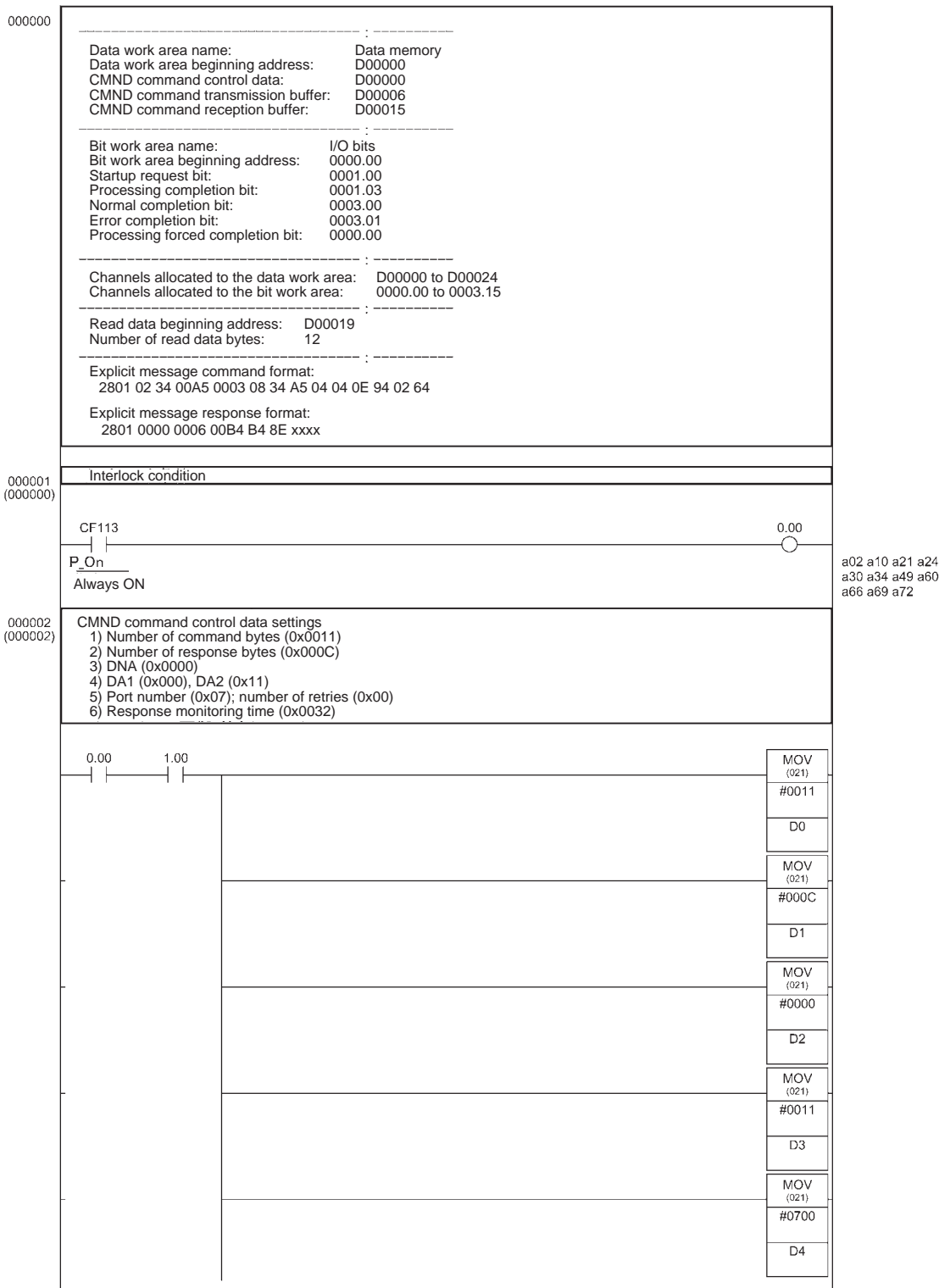

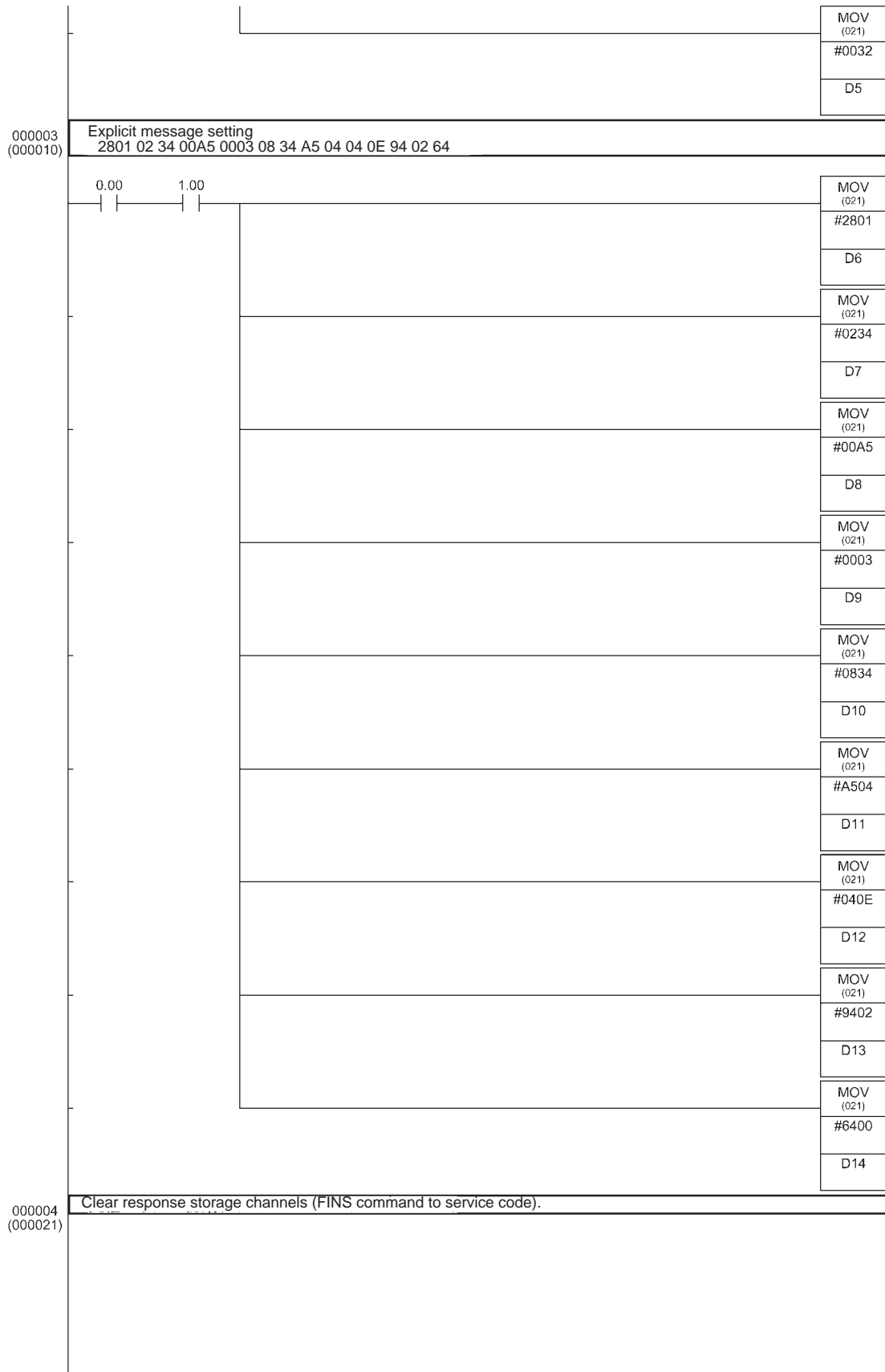

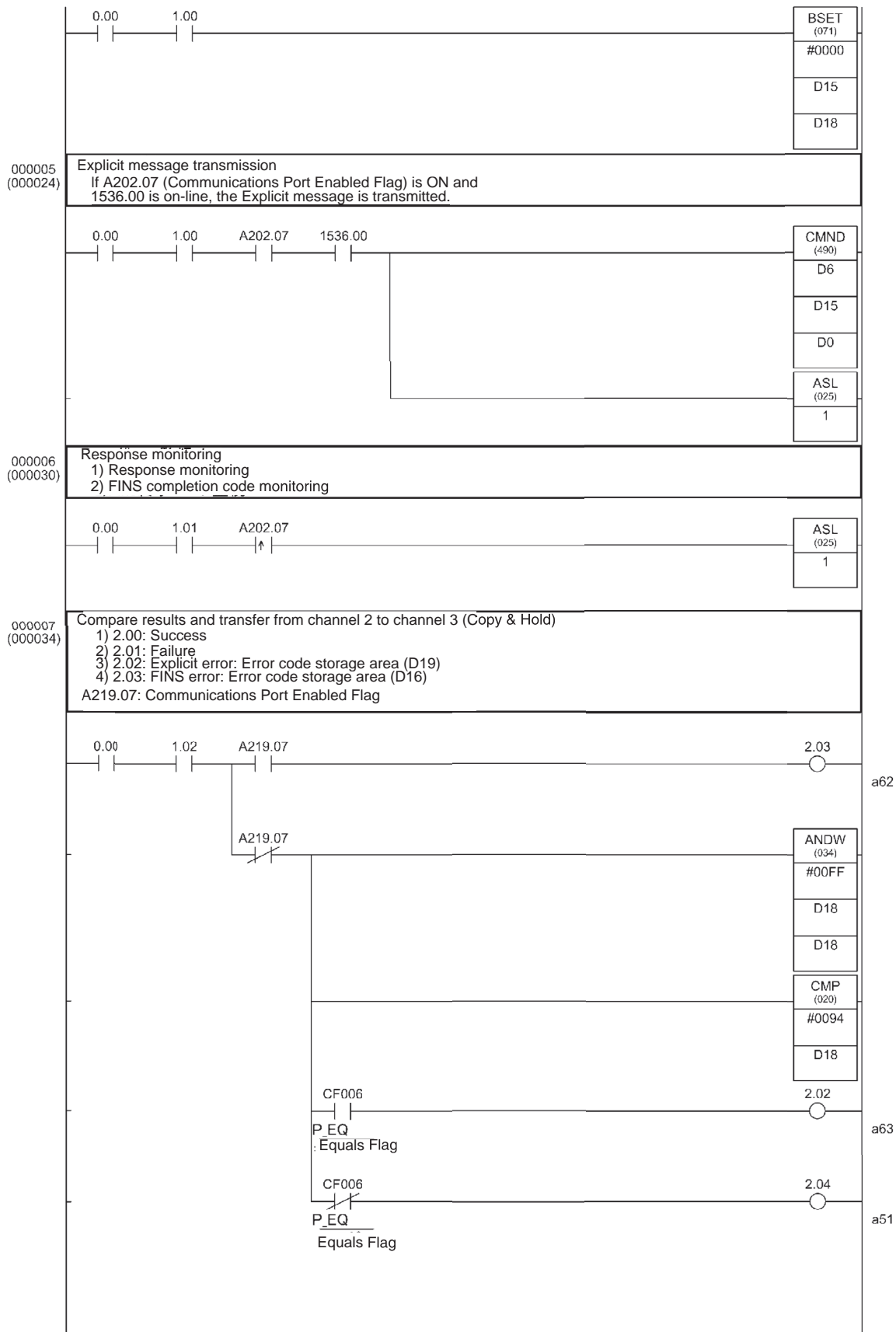



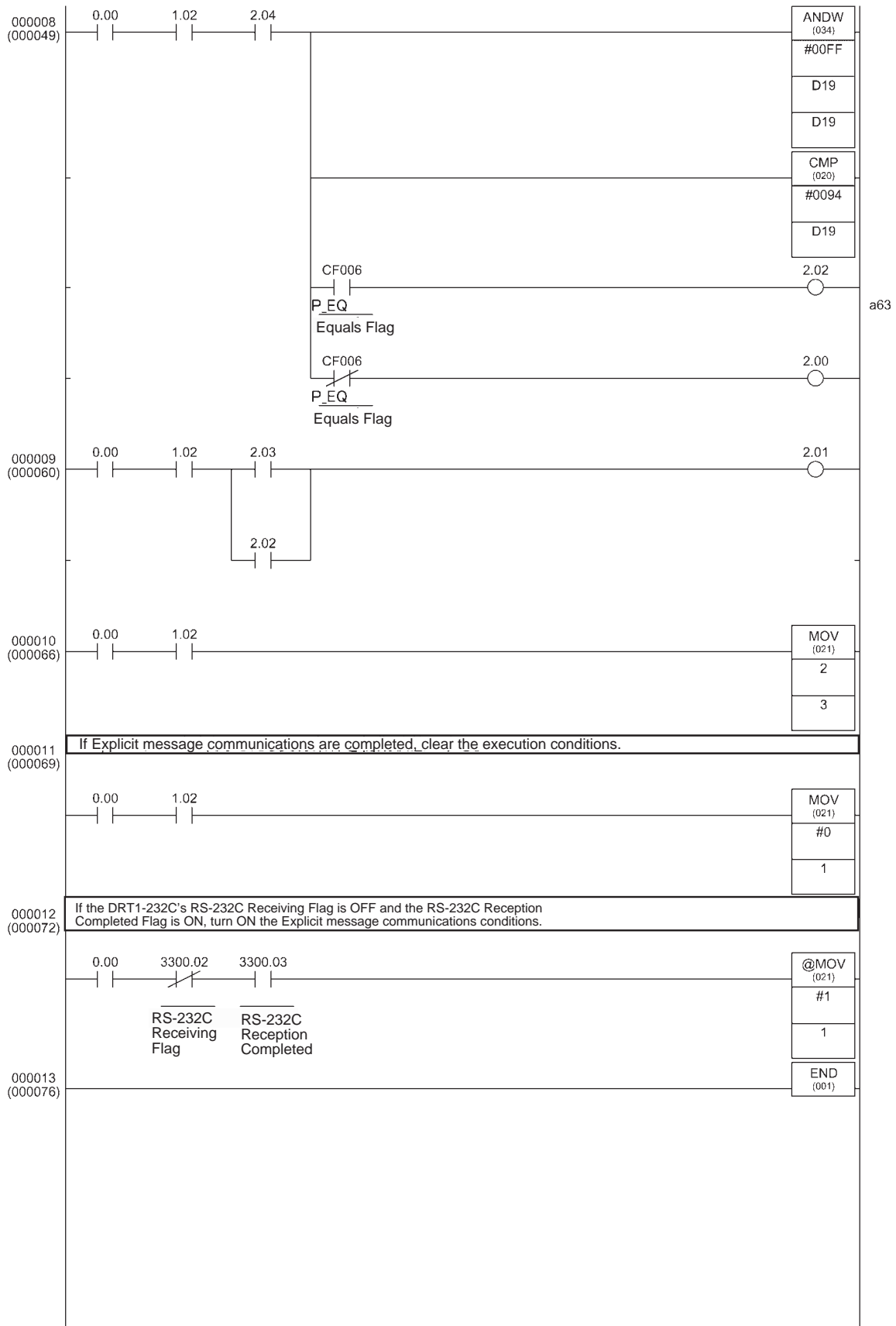

**Responses**

If reading proceeds correctly, the response is stored as follows.

<b>Word</b>	<b>Contents (Hex)</b>	<b>Definition</b>
DM00015	28 01	Explicit message transmission command code= 28 01 Hex
DM00016	00 00	End code (0000 Hex: normal end)
DM00017	XX XX	Number of bytes received (data length after DM00018)
DM00018	00 B4	Transmit service 2 byte = 00B4 Hex,
DM00019	B4 8E	Transmit service 1 byte = B4 Hex "Receiving data reading" response service code = 8E Hex
DM00015	XX XX	The data received at port 1 of the DRT1-232C is stored in the order upper byte, lower byte.
---	---	

# SECTION 4

## DeviceNet Wireless Unit Station Specifications

This section explains the settings and installation procedures for the parts and switches of the DeviceNet wireless unit.

4-1	DeviceNet Wireless Master Station Specifications . . . . .	56
4-1-1	Part identifications and functions . . . . .	56
4-1-2	Settings . . . . .	56
4-1-3	Displays . . . . .	59
4-1-4	External terminals/connectors . . . . .	60
4-1-5	Installation . . . . .	61
4-1-6	Wiring . . . . .	62
4-2	DeviceNet Wireless Slave Station Specifications . . . . .	63
4-2-1	Part identification and functions . . . . .	63
4-2-2	Settings . . . . .	64
4-2-3	Display . . . . .	66
4-2-4	External terminals/connectors . . . . .	67
4-2-5	Installation . . . . .	67
4-2-6	Wiring . . . . .	68
4-3	Common Specifications to All DeviceNet Wireless Units . . . . .	69

# 4-1 DeviceNet Wireless Master Station Specifications

## 4-1-1 Part identifications and functions

### External

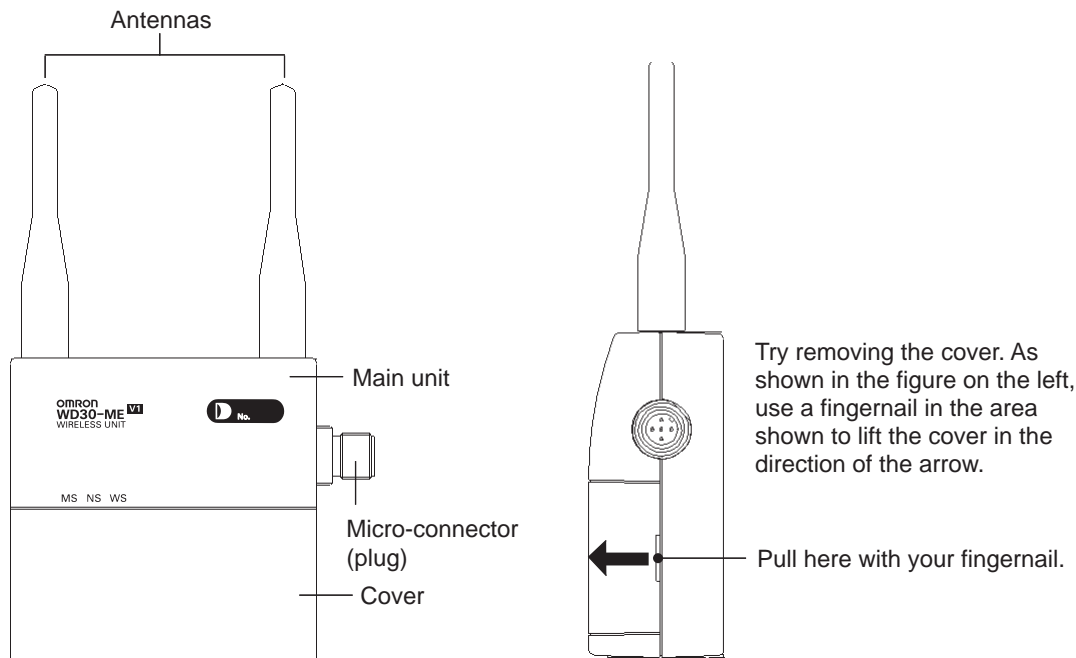

### Internal (with cover removed)

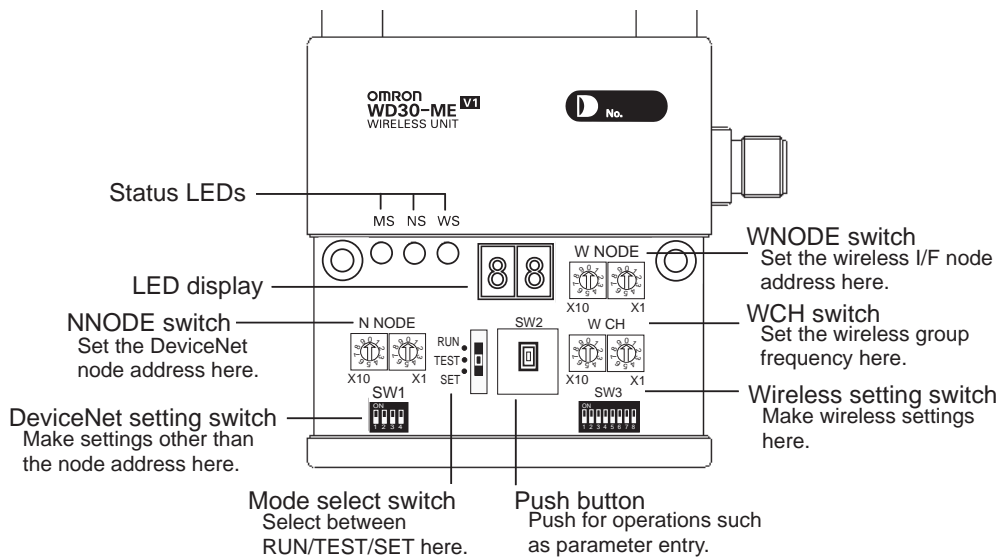

## 4-1-2 Settings

### NNODE switch (DeviceNet node address setting switch)

Set the DeviceNet interface node address here. Set the switches before turning on the power supply. Only the setting values detected immediately after the power supply has been turned on are enabled. Changes to switch settings after the power supply has been turned on are ignored.

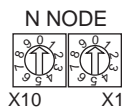

**DeviceNet setting switch (SW1)**

Set the communication speed and status of the DeviceNet interface here. Set the switches before turning on the power supply. Only the setting values detected immediately after the power supply has been turned on are enabled. Changes to switch settings after the power supply has been turned on are ignored.

SW1



No.	Contents	
1	Communication speed selection	(MODE1)
2		(MODE2)
3	Status/No status	
4	Maximum number of I/O points	

- DeviceNet communication speed settings

Communication speed (bps)	DIP switch status		Remarks
	1	2	
	MODE1	MODE2	
125k	OFF	OFF	Length of main line: 500m
250k	ON	OFF	Length of main line: 250m
500k	OFF	ON	Length of main line: 100m
-	ON	ON	Settings prohibited, no communication

No.	Contents	ON	OFF
3	Status/No status	Status	No status
4	Maximum number of I/O points	1,600/1,600 points (100 words/100 words)	512/512 points (32 words/32 words)

**Wireless setting switch (SW3)**

Perform the various settings for TEST and SET modes. Set the switches before turning on the power supply. Only the setting values detected immediately after the power supply has been turned on are enabled. Changes to switch settings after the power supply has been turned on are ignored.

SW3



No.	Contents	ON	OFF
1	(Usually OFF)	-	-
2	(Usually OFF)	-	-
3	Wireless channel monitor	Performed	Not performed
4	Installation test	Performed	Not performed
5	Confirmation test	Performed	Not performed
6	Wireless slave station entry	Entries	Does not entry
7	Wireless slave station deletion	Deletes	Does not delete
8	Default configuration	Default settings used	Default settings not used

**WCH switch**

Set the frequencies for the wireless interface group addresses. The settings should be made in decimals in a range from 01 to 34 will result in a switch setting error. For normal operation modes, settings outside of the valid range will

result in switch setting errors. Set the switches before turning on the power supply. Only the setting values detected immediately after the power supply has been turned on are enabled. Changes to switch settings after the power supply has been turned on are ignored.

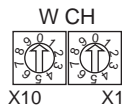

SW status		Group address	Frequency	Remarks (center frequency: MHz)
10 s position	1 s position			
0	1	1	1	2401.0
0	2	2	2	2403.4
0	3	3	3	2405.8
0	4	4	4	2408.2
0	5	5	5	2410.6
0	6	6	6	2413.0
0	7	7	7	2415.4
0	8	8	8	2417.8
0	9	9	9	2420.2
0	0	10	10	2422.6
1	1	11	11	2425.0
1	2	12	12	2427.4
1	3	13	13	2429.8
1	4	14	14	2432.2
1	5	15	15	2434.6
1	6	16	16	2437.0
1	7	17	17	2439.4
1	8	18	18	2441.8
1	9	19	19	2444.2
2	0	20	20	2446.6
2	1	21	21	2449.0
2	2	22	22	2451.4
2	3	23	23	2453.8
2	4	24	24	2456.2
2	5	25	25	2458.6
2	6	26	26	2461.0
2	7	27	27	2463.4
2	8	28	28	2465.8
2	9	29	29	2468.2
3	0	30	30	2470.6
3	1	31	31	2473.0
3	2	32	32	2475.4
3	3	33	33	2477.8
3	4	34	34	2480.2

**WNODE switch**

Set the wireless interface node address. During normal operation, the setting for this switch is ignored by the wireless master station and a node address of 00 is used for operation.

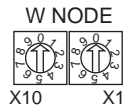

**Mode select switch**

Set the wireless master station operation mode (3 positions).



Operation mode	SW status
Normal mode	RUN
Test mode	TEST
Setting mode	SET

**Push button "SW2"**

Used as a trigger for making various settings while in Setting mode.

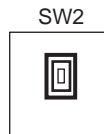

**4-1-3 Displays**

**Status LED**

LED	Color	Status		Meaning (primary error)
MS (Module Status)	Green	On	Normal conditions	Communication is normal.
		Flashing	Test/Setting mode	Test mode or Setting mode has been activated.
	Red	On	Critical malfunction	A critical error has occurred that can not be recovered. The unit must be replaced.
		Flashing	Minor malfunction	An error has occurred that can be recovered by resetting the system.
-	Off	No power supply	Power is not being supplied, or the system is resetting.	
NS (Network Status)	Green	On	Online/communication connection complete	Remote I/O communications are established while online. Or, message communications are established.
		Flashing	Online/communication connection not complete	Although the system is online, remote I/O communications and message communications are not established.
	Red	On	Critical communication error	Communication is not possible.
		Flashing	Minor communication error	Communication timeout
	-	Off	Offline, power turned off	The system is not online.



**Tips for using the mode select switch**

The software is reset (switch settings are reread) when the mode select switch is changed. It should be used when you want to enable the switch changes on the main unit.

LED	Color	Status		Meaning (primary error)
WS (Wireless Status)	Green	On	Wireless communication connection complete	Transmissions have been established between the wireless systems.
		Flashing	Wireless communication connection not complete	Wireless systems are communicating when the system is started, or there are no wireless slave stations.
	Red	On	Critical wireless communication error	A critical error has occurred that can not be recovered.
		Flashing	Minor wireless communication error	An error has occurred that can be recovered.
	-	Off	Current not sent	No current has been sent.

Refer to 10-2 *Troubleshooting* for troubleshooting details.

**LED display**

Normally, this display is off. When an error occurs, error codes are shown in the order of "error code +node where error occurred" and in the order that they occurred. In addition, the level of reception is shown in the display during tests.

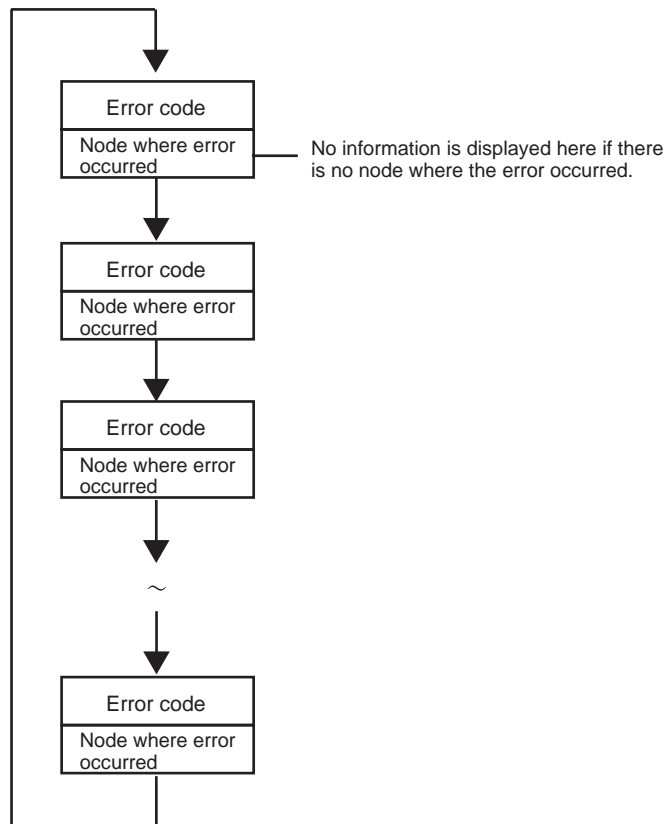

**Note** The MS LED, NS LED, WS LED, and LED display together show data concerning errors. Refer to 10-2 *Troubleshooting* for details concerning the specific meanings of these displays.

**4-1-4 External terminals/connectors**

**Antenna connector**

RP-SMA connector. Included with the 2 antennas.

**Communication connector**

DeviceNet transmission connector (plug) and DeviceNet micro-connector accessory.



### 4-1-5 Installation

**Installation location**

- Do not install this device in locations such as the following:
- Areas exposed to direct sunlight
- Areas with extremely high humidity
- Near devices that use electric waves, such as televisions and radios
- Near devices that emit sparks, such as motors and drills
- Near strong magnets
- Near fluorescent lights

**Installation conditions**

When tightening screws, be careful not to apply a torque of greater than 0.3N·m.

**External dimensions**

WD30-ME/-SE (unit itself)

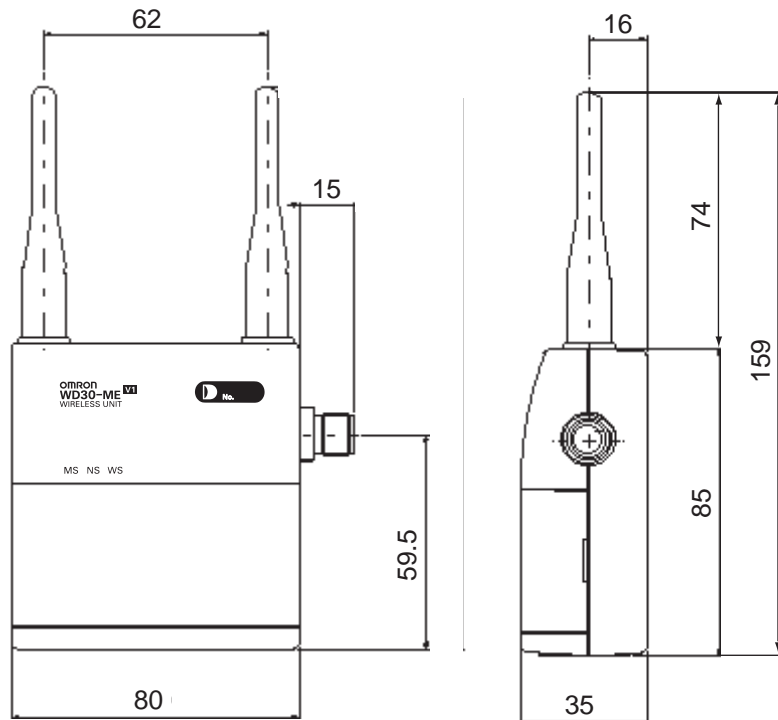

WD30-AT001 magnet-base antenna provided with WD30-ME01/-SE01C

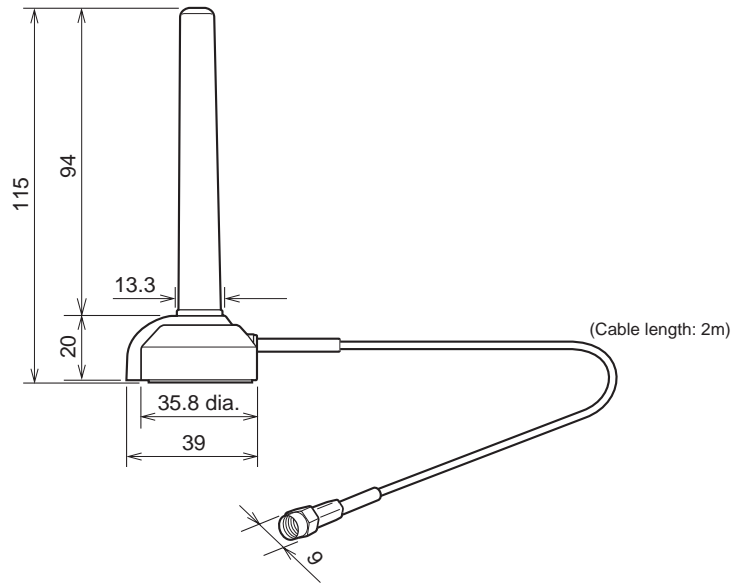

**Installation method**

Use the screws provided to fix the device in the 2 locations shown in the figure below.

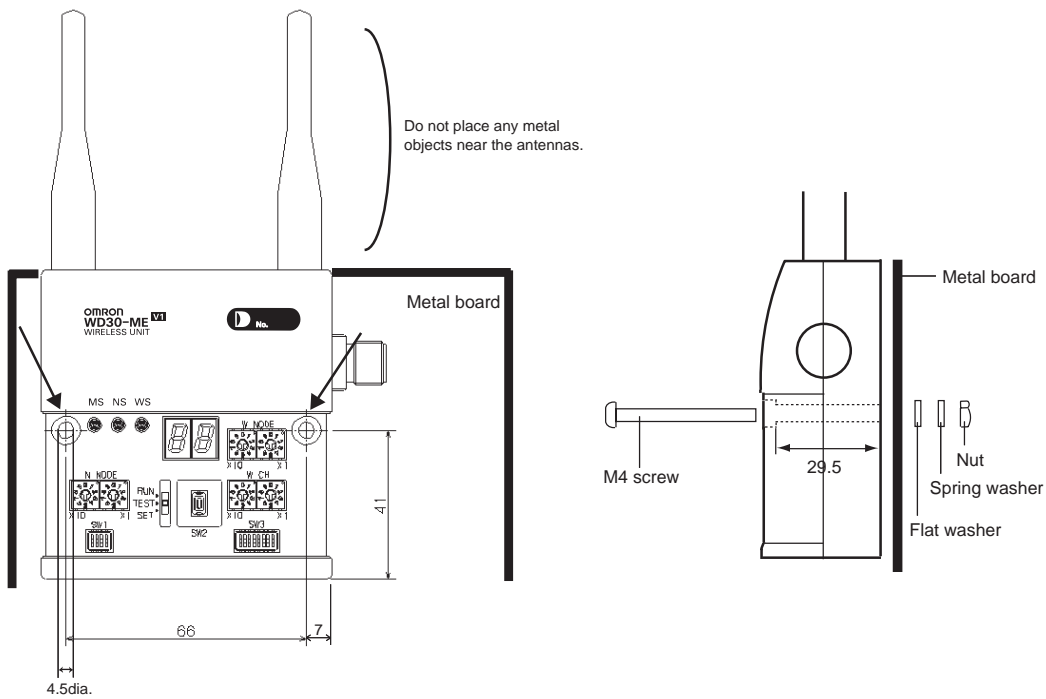

**4-1-6 Wiring**

**DeviceNet communication cable**

Use a special DeviceNet cable (with socket on one end). Refer to the appendix for models.

**Antennas**

Use the 2 antennas included. Both should be installed. If both are not installed, diversity effects will not be attained.

## 4-2 DeviceNet Wireless Slave Station Specifications

### 4-2-1 Part identification and functions

#### External

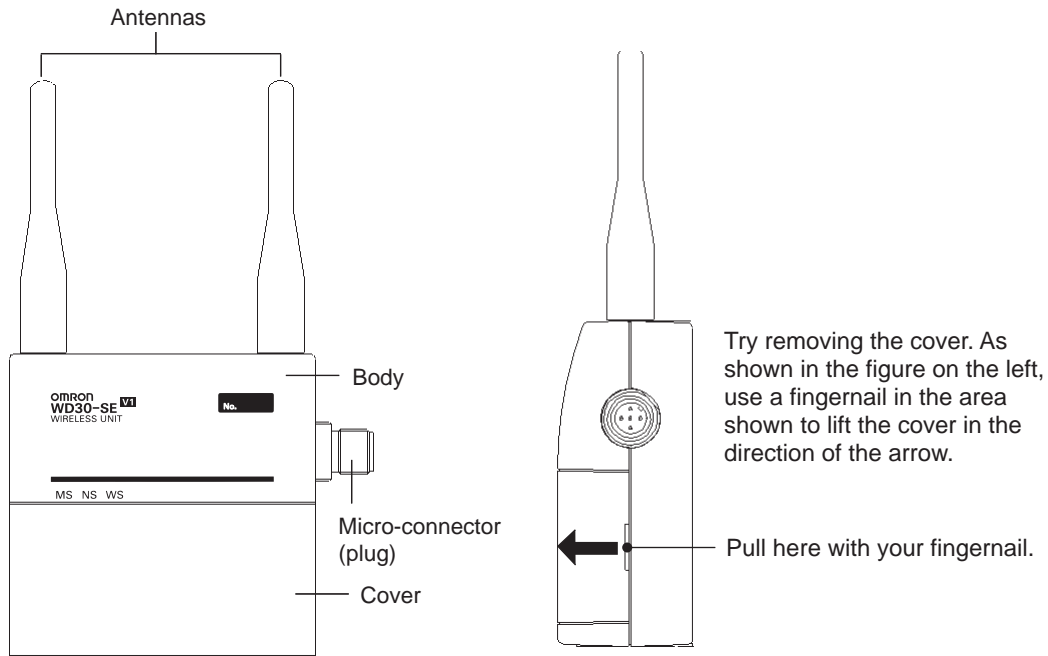

#### Internal (with cover removed)

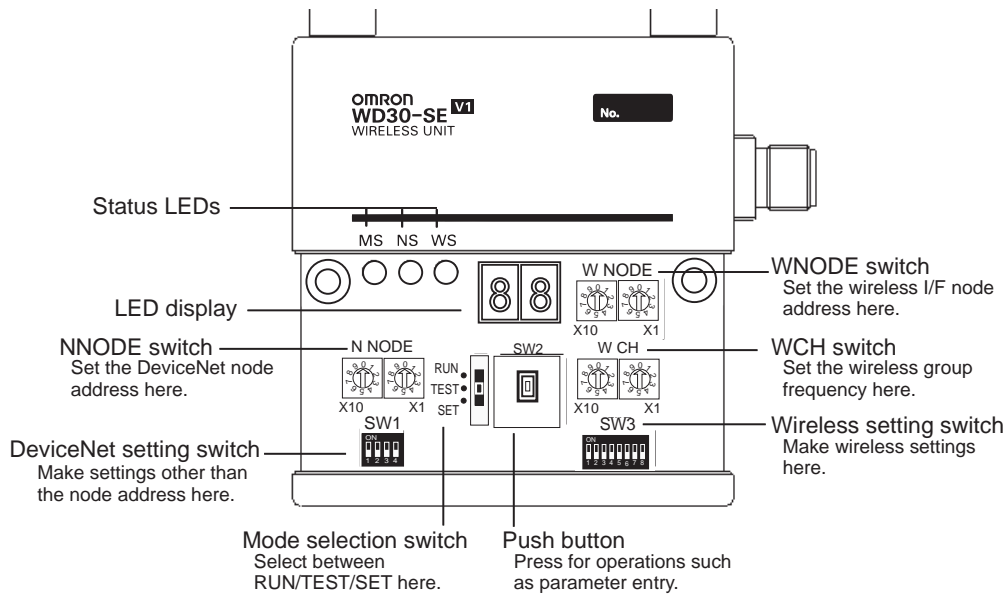

### 4-2-2 Settings

#### NNODE switch (DeviceNet node address setting switch)

Set the DeviceNet interface node address here. Set the switches before turning on the power supply. Only the setting values detected immediately after the power supply has been turned on are enabled. Changes to switch settings after the power supply has been turned on are ignored.

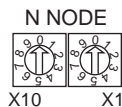

#### DeviceNet setting switch (SW1)

Set the DeviceNet interface communication speed, relay station, and measures for when communication errors occur.

"Maintain/Clear output when communication errors occur" is for setting whether to maintain or clear the ON output when a wireless network error occurs and while communication continues in the DeviceNet network that the wireless slave station is connected to. (Although communication continues in the wireless network when an error occurs in the DeviceNet network, the ON input to the wireless master station at that time becomes "Maintain".)

Set the switches before turning on the power supply. Only the setting values detected immediately after the power supply has been turned on are enabled. Changes to switch settings after the power supply has been turned on are ignored.



No.	Contents	
1	Communication speed selection	MODE1
2		MODE2
3	Relay station/No relay station selection	
4	Maintain/Clear output when communication errors occur	

- DeviceNet communication rate settings

Baud rate	DIP-SW status		Remarks
	1	2	
	MODE1	MODE2	
125k	OFF	OFF	Length of main line: 500m
250k	ON	OFF	Length of main line: 250m
500k	OFF	ON	Length of main line: 100m
-	ON	ON	Settings prohibited, no communication



**Maintaining/  
Clearing output  
when there is a  
DeviceNet slave  
communication  
error**

Applications that require the maintaining of output when a DeviceNet slave communication error occurs (if ON must be maintained when an error is occurred) cannot be used.

No.	Contents	ON	OFF
3	Relay station/No relay station selection	Relay station	No relay station
4	Maintain/Clear output when transmission errors occur	Maintain	Clear

**Wireless setting switch (SW3)**

Perform the various settings for TEST and SET modes. Set the switches before turning on the power supply. Only the setting values detected immediately after the power supply has been turned on are enabled.

Changes to switch settings after the power supply has been turned on are ignored.

SW3



No.	Contents	ON	OFF
1	(Usually OFF)	-	-
2	(Usually OFF)	-	-
3	Wireless channel monitor	Performed	Not performed
4	Installation test	Performed	Not performed
5	(Usually OFF)	-	-
6	DeviceNet slave entry	Enters	Does not enter
7	(Usually OFF)	-	-
8	Default configuration	Default settings used	Default settings not used

**WCH switch**

Set the frequencies for the wireless interface group addresses. The settings should be made in decimals in a range from "01" to "34". "00" will result in a switch setting error. Settings are the same as for wireless master stations.

W CH

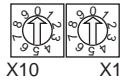

**WNODE switch**

Set the wireless interface node address. The setting range is from "01" to "64".

W NODE

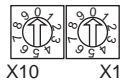

**Mode select switch**

Set the wireless slave station operation mode.(3 positions)



**Tips for using the mode select switch**

The software is reset (switch settings are reread) when the mode select switch is changed. It should be used when you want to enable the switch changes on the main unit.



Operation mode	SW status
Normal mode	RUN
Test mode	TEST
Setting mode	SET

**Push button "SW2"**

Used as a trigger for making various settings while in setting mode. Settings are the same as for wireless master stations.

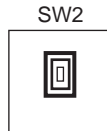

**4-2-3 Display**

**Status LED**

LED	Color	Status		Meaning (primary error)
MS (Module Status)	Green	On	Normal conditions	Communication is normal.
		Flashing	Test/Setting mode	Test mode or Setting mode has been activated.
	Red	On	Critical malfunction	A critical error has occurred that can not be recovered. The unit must be replaced.
		Flashing	Minor malfunction	An error has occurred that can be recovered by resetting the system.
-	Off	No power supply	Power is not being supplied, or the system is resetting.	
NS (Network Status)	Green	On	Online/communication connection complete	Remote I/O communications are established while online. Or, message communications are established.
		Flashing	Online/communication connection not complete	Although the system is online, remote I/O communications and message communications are not established.
	Red	On	Critical communication error	Communication is not possible.
		Flashing	Minor communication error	Communication timeout
	-	Off	Offline, power supply turned off	The system is not online.
WS (Wireless Status)	Green	On	Wireless network addition	Wireless network addition approved
		Flashing	A wireless network is being added to the system.	Approval has been received from the wireless master station to add a wireless network.
	Red	On	Critical wireless communication error	A critical error has occurred that can not be recovered.
		Flashing	Minor wireless communication error	An error has occurred that can be recovered.
	-	Off	Current not sent	No current has been sent.

Refer to 10-2 Troubleshooting for troubleshooting details.

**LED display**

Normally, this displays a node address (NNODE). When an error occurs, error codes are shown in the order of "error code +node where error occurred" and in the order that they occurred. In addition, the receiving wave level is shown in the display during tests.

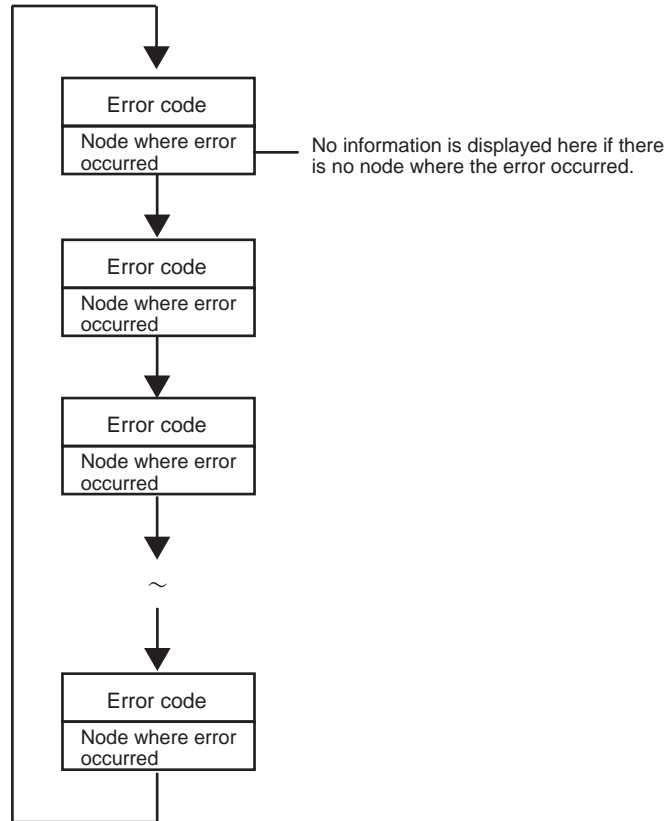

**Note** The MS LED, NS LED, WS LED, and LED display together show information concerning errors. Refer to *10-2 Troubleshooting* for details concerning the specific meanings of these displays.

**4-2-4 External terminals/connectors**

**Antenna connector**

RP-SMA connector. Included with the 2 antennas.

**Communication connector**

DeviceNet communication connector (plug) and DeviceNet microconnector accessory.

**4-2-5 Installation**

**Installation location**

Do not install this device in locations such as the following:

- Areas exposed to direct sunlight
- Areas with extremely high humidity
- Near devices that use electric waves, such as televisions and radios
- Near devices that emit sparks, such as motors and drills
- Near strong magnets
- Near fluorescent lights

**Installation conditions**

When tightening screws, be careful not to apply a torque of greater than 0.3N·m.

External dimensions

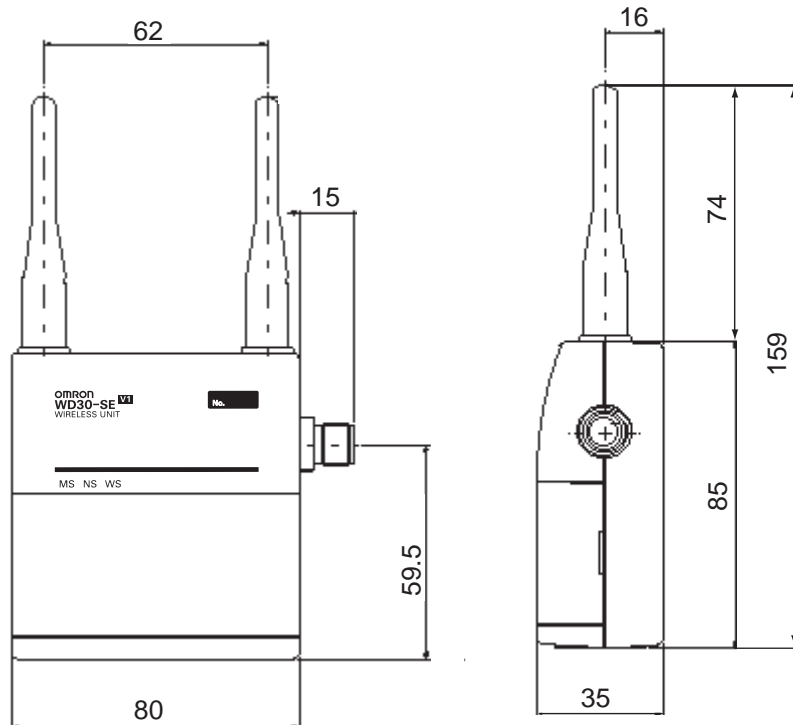

Installation method

Use the screws provided to fix the device in the 2 locations shown in the figure below.

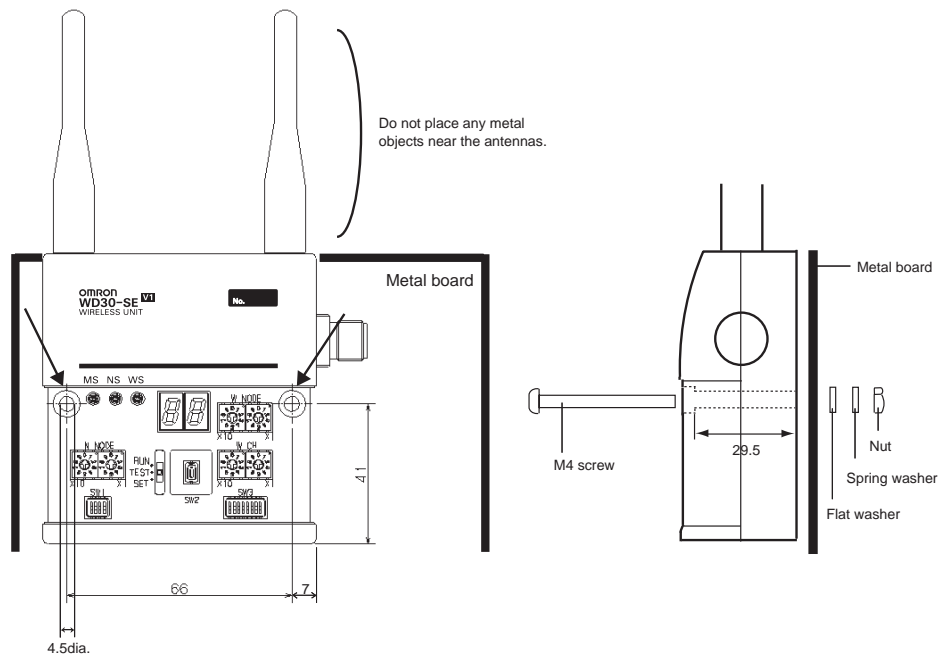

4-2-6 Wiring

DeviceNet communication cable

Use a special DeviceNet cable (with socket on one end). Refer to the appendix for models.

Antennas

Use the 2 antennas included. Both should be installed. If both are not installed, diversity effects will not be attained.



## 4-3 Common Specifications to All DeviceNet Wireless Units

Table 1 General specifications

Item	Specifications
DeviceNet transmission voltage	DC11 - 25V (Supplied from the Device Net network power supply)
Current consumption	350mA maximum (at startup); average: 120mA
Ambient temperature	-10 to +50°C
Ambient humidity	25 to 85%RH
Storage temperature	-20 to +65°C
Weight	Approximately 200g

Table 2 Wireless interface specifications

Item	Specifications
Wave type	Spread Spectrum (direct sequence; DS-SS)
Communication method	Simplex (half duplex)
Frequency band	2.4GHz (2401MHz-2480.2MHz)
Number of channels	34 channels (based on frequency division)
Antenna power	10mW/MHz
Data transfer speed between wireless stations	100kbps
Protocol between wireless stations	1:N polling selection method
Transmission format	Conform to HDLC
Transmission distance (varies according to installation environment)	Indoors: 60m maximum (approx. 50m with magnet-base antennas) An increase in transmission distance is possible using relays. (3 stages maximum)
Max. number of wireless slave stations	64

Table 3 DeviceNet interface specifications (general description)

Item	Specifications	
Communication functions	Master/Slave connections	Remote I/O functions
		Explicit message transmission function
Self-diagnosis function	Unit	WDT errors, hardware errors (memory, CAN), setting errors
	DeviceNet communication	Duplicate node address errors, BUSoff detection, connection timeout
Device profile	Communication control unit	IDs (vender, device type = communication adapter, product code, product revision, product name, serial number, status, and I/O unit IDs) can be found in the appendix.

All other specifications are the same as conventional DeviceNet slave unit and DeviceNet communication specifications.



# SECTION 5

## Test

This section explains the procedures for the system tests required for using the DeviceNet wireless unit.

5-1	Test .....	72
5-2	Installation Test .....	73
5-2-1	Preparation .....	73
5-2-2	Test procedure .....	73
5-3	Confirmation Test .....	75
5-3-1	Preparation .....	75
5-3-2	Test procedure .....	75
5-4	Wireless Channel Monitor .....	77
5-4-1	Method without configurator .....	77

## 5-1 Test

- The test consists of the Installation test, confirmation test and wireless channel monitor.
- The positioning test must be implemented on the system that uses this unit before operation.
- Temporarily fix the unit till the test is finished, and then use screws to firmly fix the unit. While the unit is fixed only temporarily, pay attention so that the unit will not fall and be damaged.
- The purpose of each test is as follows.

Test	Content/Purpose	Test timing
Installation test	Adjusts the installation position (confirmation of receiving wave, etc.) and the setup conditions (selection of available frequencies). Both master and slave stations require the switch	At installation At advance on-site test
Confirmation test	Checks the wireless communication status with each slave station in a system in operation. This is a switch operation from the master station.	At confirmation after installation At maintenance and inspection
Wireless channel monitor	Obtains the receiving wave level of the frequency band (all channels) to allow for the selection of the available channels (frequency band).	At installation At advance on-site test

## 5-2 Installation Test

This test is for adjusting the installation position (confirmation of receiving wave, etc.) and the setup conditions (selection of unused frequencies, selection of transmission output, etc.) at installation. Both master and slave stations require the switch operation.

### 5-2-1 Preparation

- The DeviceNet master and DeviceNet slave do not need to be connected for the installation test.
- Set the WNODE switch of the wireless master station to "00" and the WNODE switch of a wireless slave station to "01" to "64", avoiding duplication.
- Since both the wireless master stations and wireless slave stations require the transmission power supply, connect them to the power supply via the DeviceNet cable prepared for a micro-connector.

### 5-2-2 Test procedure

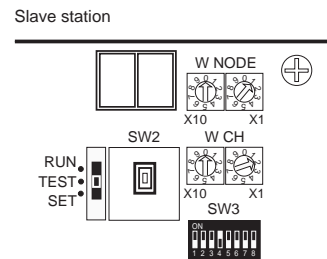
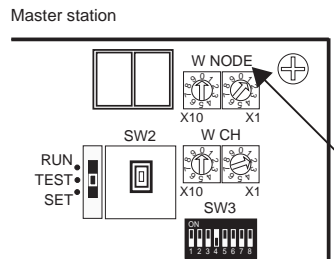

1. Set the mode select switch of the wireless master station to "TEST", and the WNODE switch to the WNODE number of the wireless slave station to be tested. "01" is used for this example. Set SW3 to "bit 4 = ON".

2. Set the mode select switch of the wireless slave station to "TEST".

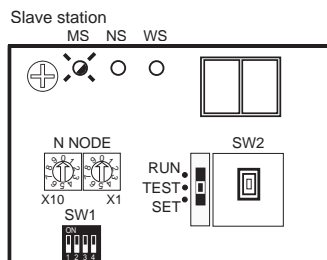
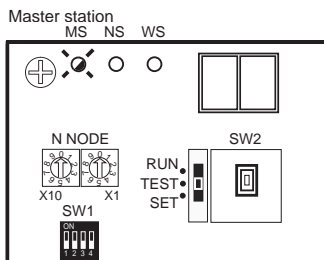

3. Turn on the communication power supplies of the wireless master station and all wireless slave stations. The system is in test operation status.

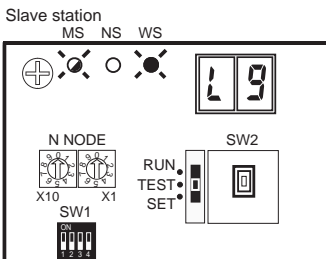
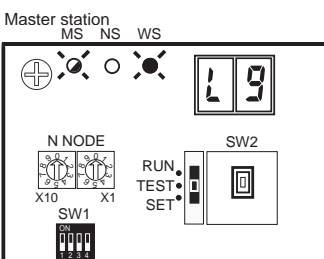

4. The LED display shows the receiving wave level "L1 to L9", if the wireless master station and the wireless slave station to be tested have been installed within the distance where both stations can receive the electric wave from each other.

If the WS LED lights green, this means that the wireless communication link has been established. Position the devices so that the WS LED lights green. If the electric wave is weak, adjust the position of the wireless slave station so that receiving wave level is stabilized in L5 or higher.

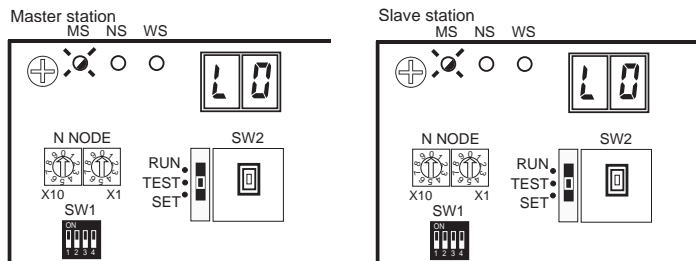

The LED display shows the receiving wave level "L0" if the devices have been installed outside the distance where they cannot receive the electric wave from each other.

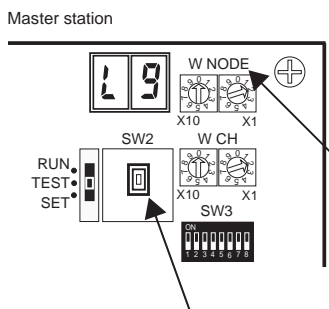

- Set the WNODE switch of the wireless master station to the WNODE number ("00" for this example) of the wireless slave station to be tested next, and then press SW2.

Repeat this procedure till the communication with all wireless slave stations is established and stabilized.

## 5-3 Confirmation Test

This test is for checking the wireless communication status with each slave station in the system in operation after installation. The test can be implemented by the switching operation from the master station.

### 5-3-1 Preparation

- The DeviceNet master does not need to be connected for the confirmation test. (The DeviceNet slave needs to be connected.)
- The confirmation test is employed for the inspection work after installation. Thus, the system registration is assumed to be completed beforehand.
- Leave the mode select switches of the wireless slave stations in the "Run" position.

### 5-3-2 Test procedure

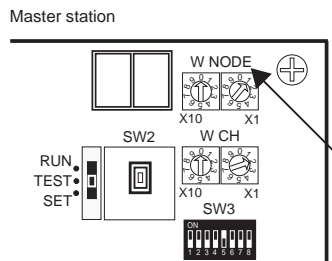

1. Set the mode select switch of the wireless master station to "TEST", and the WNODE switch to the WNODE number of the wireless slave station to be tested. "01" is used for this example. Set SW3 to "bit 5 = ON".

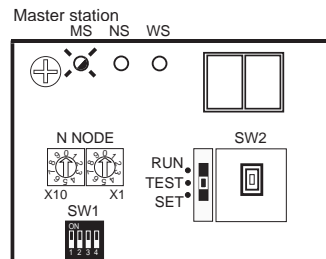

2. Turn on the communication power supply to the wireless master station. The system is in test operation status. The NS LED goes off and the MS LED flashes green.

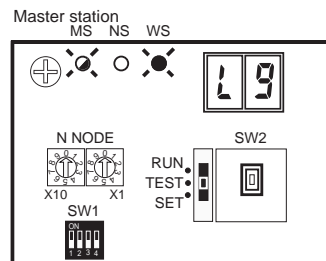

3. The LED display shows the receiving wave level "L1 to L9" if the wireless master station and the wireless slave station to be tested have been installed within the distance where both stations can receive the electric wave from each other. If the WS LED lights green, the wireless communication link has been established. Position the devices so that the WS LED lights green. If the electric wave is weak, adjust the position of the wireless slave station so that the receiving wave level is stabilized at L5 or higher.

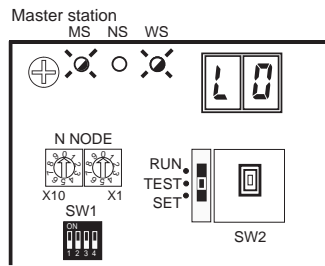

The LED display shows the receiving wave level "L0", if the devices have been installed outside the distance where they cannot receive the electric wave from each other.

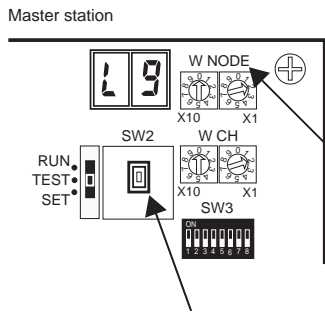

4. Set the WNODE switch of the wireless master station to the WNODE number ("02" for this example) of the wireless slave station to be tested next, and then push SW2. Repeat this procedure till communication with all wireless slave stations is established and stabilized.



## 5-4 Wireless Channel Monitor

Obtains the receiving wave level of the frequency band (all channels) to allow for the selection of the available channels (frequency band).

### 5-4-1 Method without configurator

#### Preparation

- The DeviceNet master and DeviceNet slave do not need to be connected for the positioning test.
- Prepare either the wireless master station or an slave station. (Either one is acceptable.)
- The wireless unit requires a communication power supply. Connect the unit to the power via the DeviceNet cable prepared for a micro-connector.

#### Test procedure

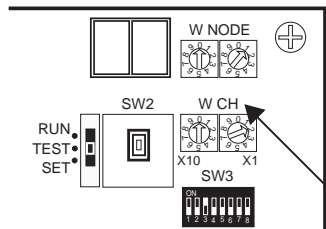

1. Set the mode select switch to "TEST".  
Set SW3 to "bit 3 = ON".  
Set the WCH switch to the wireless channel to be monitored. "02" is used for this example.

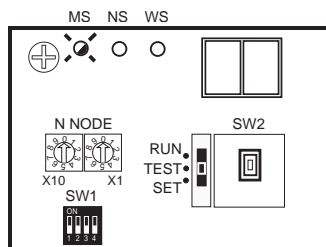

2. Turn on the communication power supply. The system is in test operation status. The NS LED goes off and the MS LED flashes green.

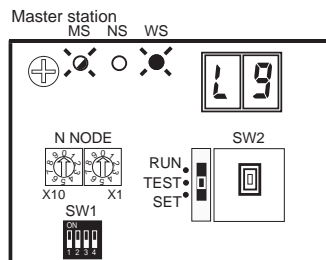

3. The WS LED lights green and the LED display shows the receiving wave level "L1 to L9".

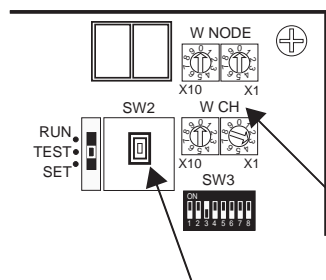

4. Set the WCH switch of the wireless master station to the wireless channel to be monitored next, and then push SW2.  
Repeat this procedure to search the available channel whose receiving wave level is "L1" or lower. Select the wireless channel to be used among the unused channels.



# SECTION 6

## Relay Function

This section gives detailed explanations of the relay function of the wireless slave stations used to enlarge the communications area.

6-1	Relay Function .....	80
6-2	Actual Example.....	81
6-2-1	System configuration example.....	81
6-2-2	System setting.....	81
6-2-3	Installation test.....	81
6-2-4	Preparation.....	83
6-2-5	Communications.....	83
6-2-6	Response.....	84

### 6-1 Relay Function

A wireless slave station can be used as a relay station when expansion of the communication area is intended but the direct communication is blocked by obstacles.

The relay station can select either (1) the mode that does not connect the DeviceNet slave (dedicated relay station mode) or (2) the mode functions as both the DeviceNet master and the relay station by connecting the DeviceNet slave (non-dedicated mode) using DIP switches.

For details, refer to 4-2 DeviceNet Wireless Slave Station Specifications.

The maximum number of relay stages is 3 (no. of hops: 4).

A configurator is used for the relay station system setting. When the wireless slave station is used in the dedicated relay station mode, the DeviceNet slave is not connected. However, since the communication power supply is required, the communication cable needs to be connected.

Also, in the relay station system, the WCH switches of all wireless units must be set to an identical frequency.

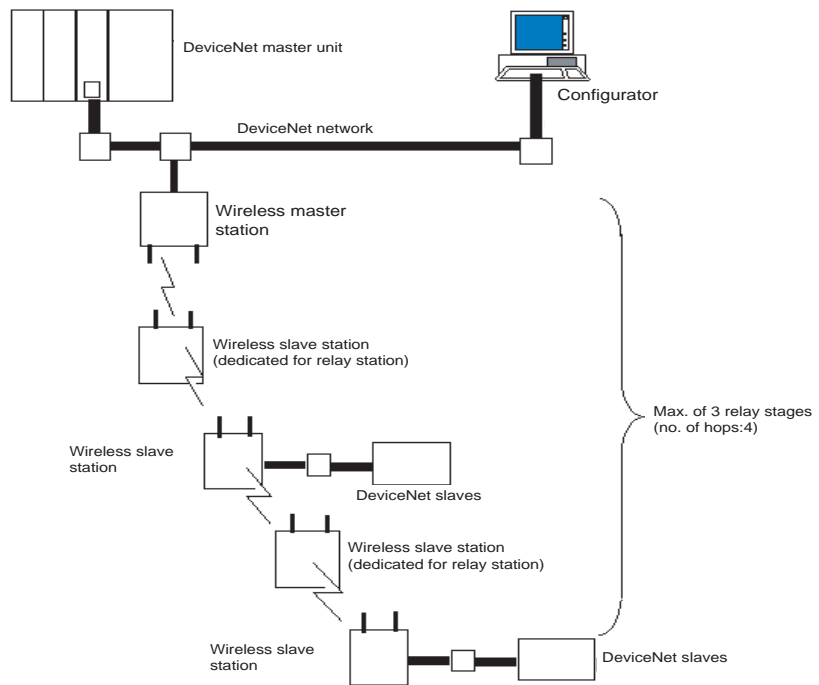

The I/O connected with wireless slave stations are loaded first by ascending order of DeviceNet node addresses in the wireless slave station, and then by ascending order of wireless node addresses for the slave station (WNODE) in the wireless master station.

## 6-2 Actual Example

### 6-2-1 System configuration example

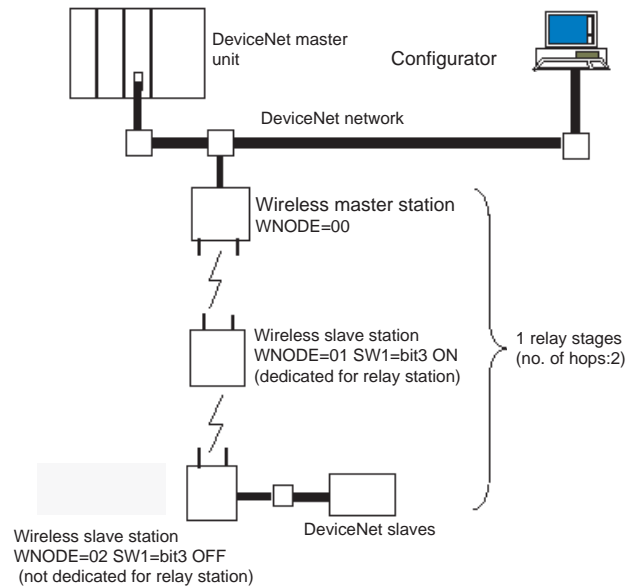

Although omitted in the above illustration, it is assumed that the communication power is supplied to all wireless units via the communication cables and that terminators are installed.

### 6-2-2 System setting

#### Preparation

Connect the wireless master station and configurator with the DeviceNet network. The wireless slave stations do not need to be prepared at this stage.

#### Setting from the configurator

After starting up the configurator, set the system configuration of the relay station and enter it in the wireless master station on the screen of the parameter setting function of the wireless unit.

### 6-2-3 Installation test

#### Temporary installation

- Temporarily install the wireless master station, relay station, and slave stations to the respective determined positions.
- Set the switches as described in the illustration of the system configuration example.

Text execution

- 1,2,3... 1. Perform the installation test between the wireless master station and the relay stations. For the method of installation test, refer to 5-2 *Installation Test*.

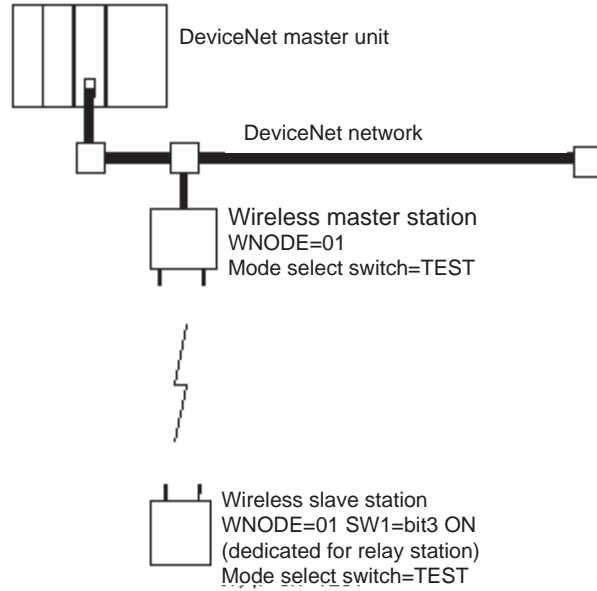

2. Perform the installation test between the wireless master station and the relay stations, and between the relay stations and the slave stations. (Select WNDOE = 2 in the wireless master station.)

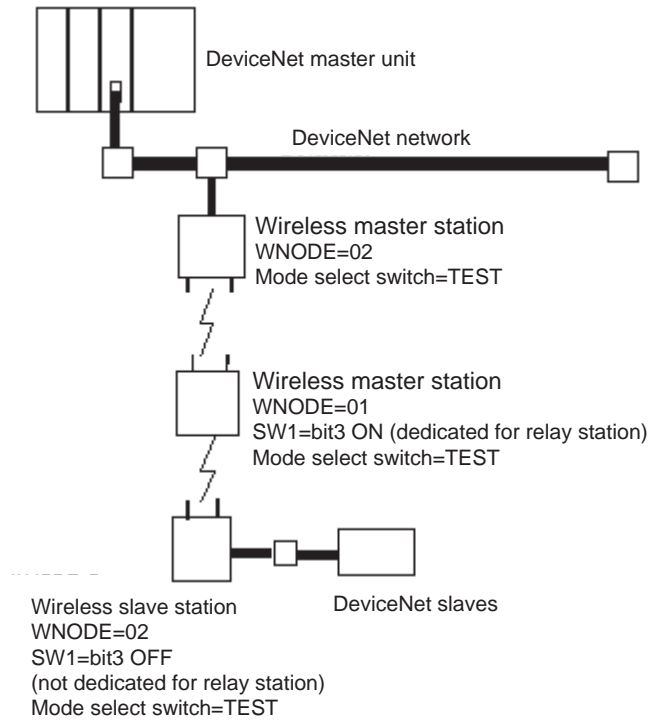

### 6-2-4 Preparation

#### Setting and installation

Set the wireless units as shown in the illustration below and fix the wireless unit that has already been temporarily installed. Connect the required cables. For details, refer to 4-1 DeviceNet Wireless Master Station Specifications or 4-2 DeviceNet Wireless Slave Station Specifications.

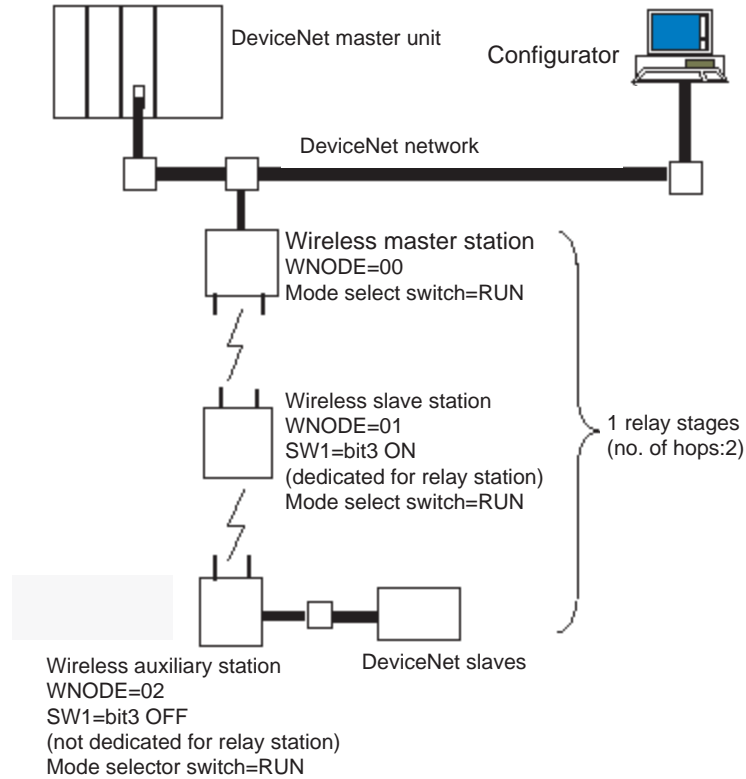

#### Starting the system

Turn on the power supplies to the entire system.

### 6-2-5 Communications

#### Confirming unit LEDs

If the WS LED of a wireless unit lights green, this indicates that the wireless remote I/O communication is properly made.

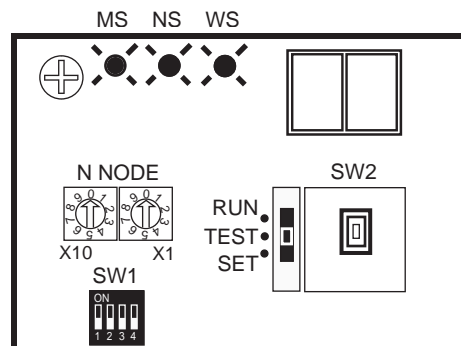

**Checking with the configurator**

Check if the system is communicating correctly on the wireless network monitoring screen.

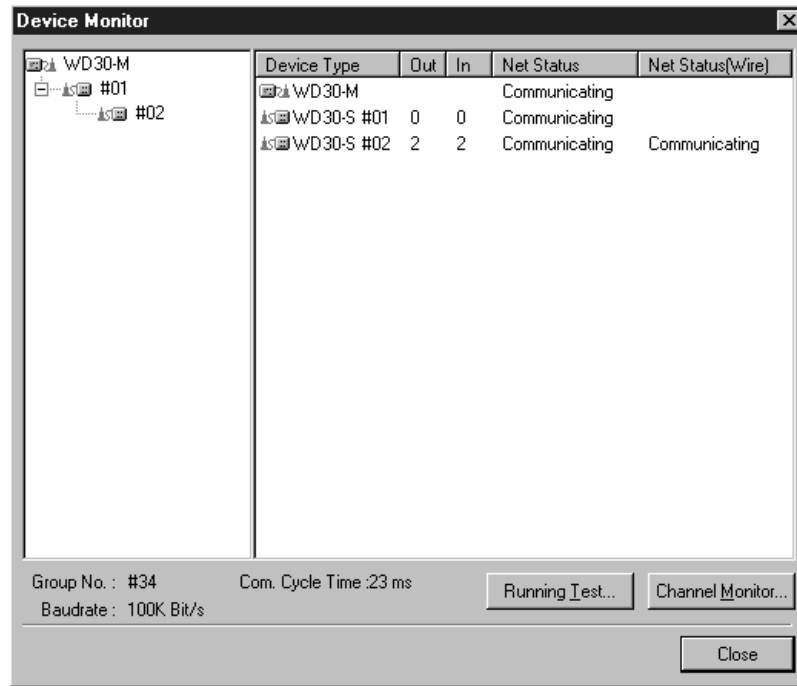

**6-2-6 Response**

For the system response of the relay station, refer to *9-1 Remote I/O Communications Performances*.



# SECTION 7

## Message Communication Function

This section gives detailed explanations of the basic format and commands for the Explicit messages used in the Message Communications Function performed by setting and reading the status of the DeviceNet wireless master station.

7-1	Explicit Messages Addressed to the DeviceNet Wireless Master Station . . .	86
7-1-1	Basic format . . . . .	86
7-2	List of Explicit Messages Addressed to DeviceNet Wireless Master Station.	88
7-2-1	Reading actual time of wireless communication cycle. . . . .	89
7-2-2	Reading addition information of lower DeviceNet slave . . . . .	90
7-2-3	Reading addition information of the wireless slave station . . . . .	91
7-2-4	Entering/deleting wireless slave station . . . . .	92
7-2-5	Setting the number of IN points . . . . .	92
7-2-6	Reading the number of IN points . . . . .	93
7-2-7	Setting the number of OUT points . . . . .	94
7-2-8	Reading the number of OUT points . . . . .	94
7-2-9	Setting upper station node address . . . . .	95
7-2-10	Reading upper station node address . . . . .	96
7-2-11	Reading wireless network status. . . . .	96
7-2-12	Reading wireless error counts. . . . .	97
7-2-13	Reading DeviceNet master status . . . . .	98
7-2-14	Writing settings/soft reset. . . . .	99
7-3	Explicit Messages Addressed to DeviceNet Slave Connected before DeviceNet Wireless Slave Station. . . . .	101

## 7-1 Explicit Messages Addressed to the DeviceNet Wireless Master Station

The following items are possible by issuing Explicit messages to the wireless master station from the PLC and PC on the DeviceNet network on which the wireless master station is connected.

- Wireless master station parameter setting/reference
- Command transmissions to the wireless master station

The information in this section applies only to wireless units. For information on other areas, refer to the DeviceNet User's Manual.

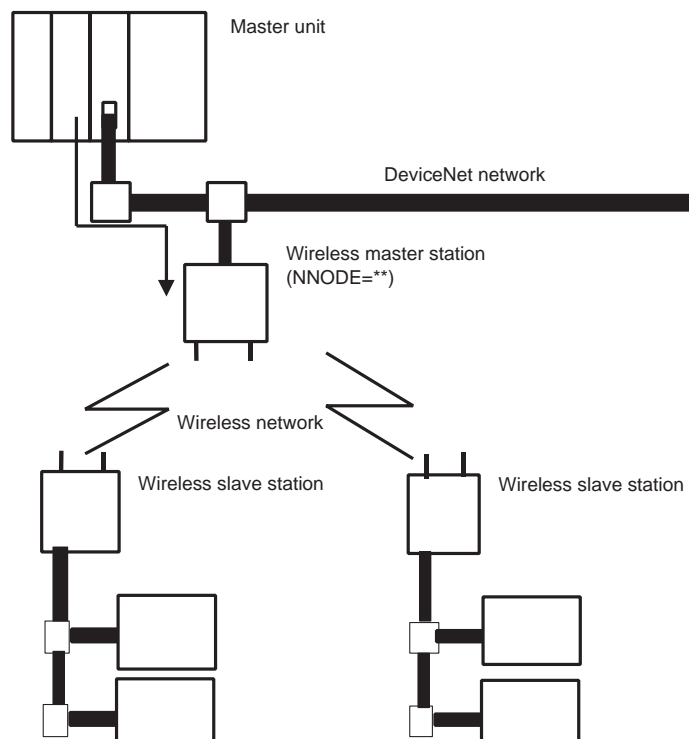

### 7-1-1 Basic format

The following explains common parts in each command response.

The number of the specified byte of ClassID, InstanceID, and AttributeID may be different depending on a master unit. In the case of the OMRON DeviceNet master unit, 2 byte (4 digits) for ClassID and InstanceID, and 1 byte (2 digits) for AttributeID.



#### Parameter setting timing to become valid

The set data of the parent wireless station parameter settings take effect when the power supply is reset or a soft reset is executed in the Explicit message.

**Command format**

"Destination node address"

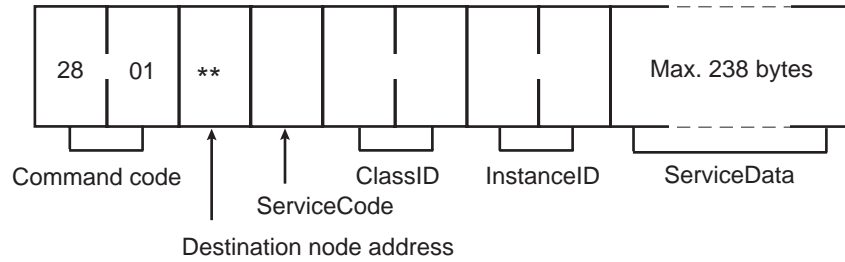

"Transmission destination node address"

Specifies the wireless master station node address (NNODE) controlled by the Explicit message.

"ServiceCode", "ClassID", "InstanceID"

These are parameters to specify command types, processing objects, and the details of the process.

"ServiceData"

This data is set as necessary. The maximum specifiable byte is 238.

**Response format**

1,2,3...

1. The issued Explicit message is normally responded to:

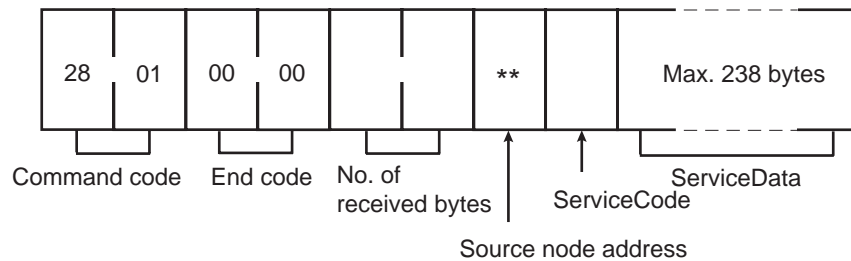

"No. of received bytes"

The number of bytes of the received data from the source node address and after are responded to in hexadecimal.

"Communication source node address"

Specifies the wireless master station node address (NNODE) issued by the command.

"ServiceCode"

If the system ends normally, the value resulting when the uppermost bit of the ServiceCode specified by the command becomes ON is stored. Code 0004 Hex always results when an error is responded.

"ServiceData"

When a read command is issued, the read data is stored. 238 byte is the maximum.

2. The issued Explicit message is responded to with an error:

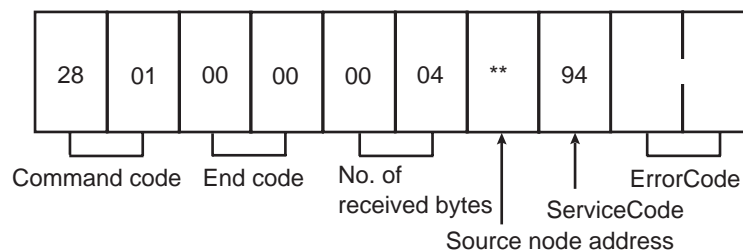

"ErrorCode"

This is the error code of the Explicit message. For details, refer to the DeviceNet specifications.

## 7-2 List of Explicit Messages Addressed to DeviceNet Wireless Master Station

The following table shows the Explicit messages that can be processed by the wireless master station.

Explicit message	Function	ServiceCode Format in ( ) is response	ClassID	InstanceID	AttributeID	Page
Reading actual time of wireless communication cycle	Reads the latest actual time of wireless communication cycle at a user system.	0E Hex (8E Hex)	A7 Hex	01 Hex	65	89
Reading addition information of lower DeviceNet slave	Reads the addition information of the DeviceNet slave connected to a wireless slave station.	0E Hex (8E Hex)	A7 Hex	01 Hex	6A	90
Reading addition information of wireless slave station	Reads the addition information of wireless slave station.	0E Hex (8E Hex)	A7 Hex	01 Hex	6B	91
Entering a specified wireless slave station	Enters a specified wireless slave station to wireless network.	10 Hex (90 Hex)	A8 Hex	01 to 40 Hex	64	92
Deleting a specified wireless slave station	Deletes a specified wireless slave station from the network.	10 Hex (90 Hex)	A8 Hex	01 to 40 Hex	64	92
Setting the No. of IN points	Sets the number of IN points of a specified wireless slave station.	10 Hex (90 Hex)	A8 Hex	01 to 40 Hex	6D	92
Reading the No. of IN points	Reads the number of IN points of a specified wireless slave station.	0E Hex (8E Hex)	A8 Hex	01 to 40 Hex	6D	93
Setting No. of OUT points	Sets the number of OUT points of a specified wireless slave station.	10 Hex (90 Hex)	A8 Hex	01 to 40 Hex	6E	94
Reading the number of OUT points	Reads the number of OUT points of a specified wireless slave station.	0E Hex (8E Hex)	A8 Hex	01 to 40 Hex	6E	94

Explicit message	Function	ServiceCode For- mat in ( ) is response	ClassID	InstancelD	AttributelD	Page
Setting upper station node address	Sets the node address of the upper station on the relay route of a specified wireless slave station.	10 Hex (90 Hex)	A8 Hex	01 to 40 Hex	6F	95
Reading upper station node address	Reads the node address of the upper station on the relay route of a specified wireless slave station.	0E Hex (8E Hex)	A8 Hex	01 to 40 Hex	6E	96
Reading wireless network status	Reads the status information of wireless network between the master station and a specified wireless slave station.	0E Hex (8E Hex)	AA Hex	01 to 40 Hex	64	96
Reading wireless error count	Reads the error counts between the master station and a specified wireless slave station.	0E Hex (8E Hex)	AA Hex	01 to 40 Hex	65	97
Reading DeviceNet master status	Reads the DeviceNet master status of a specified wireless slave station.	0E Hex (8E Hex)	AA Hex	01 to 40 Hex	67	98
Writing settings/ soft reset	Writes settings in EEPROM or executes soft reset.	10 Hex (90 Hex)	AC Hex	01 Hex	64	99

The following pages explain each command. By the way, in the command (response) format, the command codes and end codes in the header section are omitted.

### 7-2-1 Reading actual time of wireless communication cycle

Reads the latest actual time of wireless communication cycle at a user system.

#### Command format

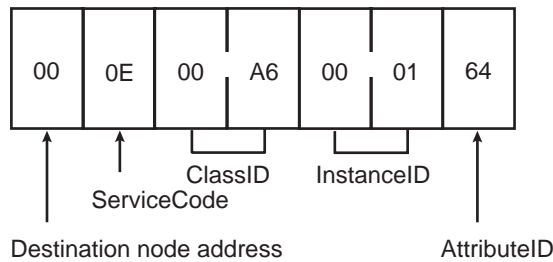

#### Response format

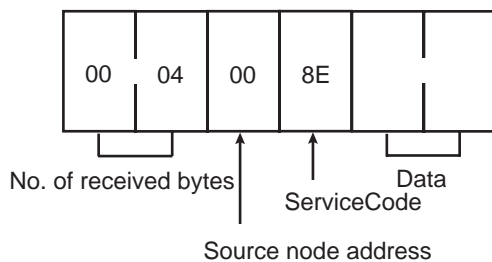

**Parameter details**

"Data" (response)

The read actual cycle time of wireless communication is stored. The data consists of 2-byte character codes. Unit in ms.

Actual cycle time (lower)
Actual cycle time (upper)

### 7-2-2 Reading addition information of lower DeviceNet slave

Reads the addition information of the DeviceNet slave connected to a wireless slave station.

**Command format**

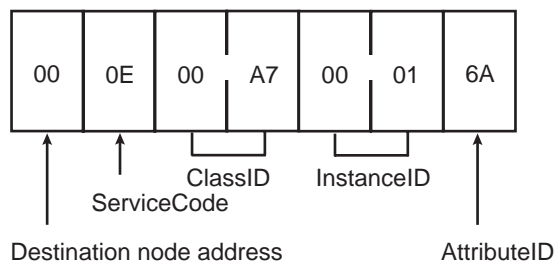

**Response format**

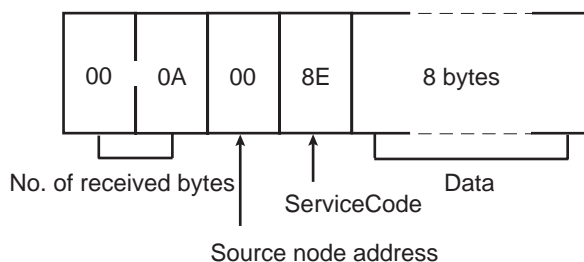

**Parameter details**

The read addition information of the lower DeviceNet slave is stored. The data consists of 8-byte character codes.

D7	D6	D5	D4	D3	D2	D1	D0
7	6	5	4	3	2	1	0
15	14	13	12	11	10	9	8
23	22	21	20	19	18	17	16
31	30	29	28	27	26	25	24
39	38	37	36	35	34	33	32
47	46	45	44	43	42	41	40
55	54	53	52	51	50	49	48
63	62	61	60	59	58	57	56

If the DeviceNet slave of the above node address is 1, an slave station is added, and if 0, not added.

### 7-2-3 Reading addition information of the wireless slave station

Reads the addition information of the wireless slave station.

#### Command format

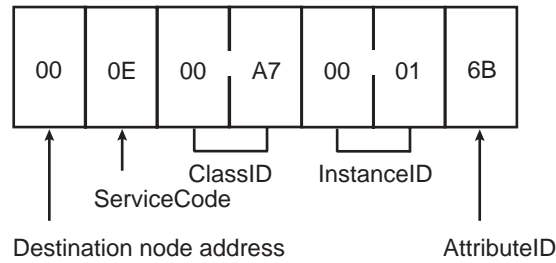

#### Response format

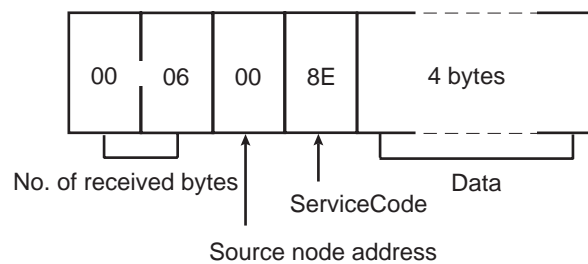

#### Parameter details

1. The read addition information of the wireless slave station is stored. If bit 4 of SW1 of the wireless master station is OFF, the data consists of 4-byte character codes.

D7	D6	D5	D4	D3	D2	D1	D0
8	7	6	5	4	3	2	1
16	15	14	13	12	11	10	9
24	23	22	21	20	19	18	17
35	31	30	29	28	27	26	25

If the wireless slave station of the above node address is 1, a slave station is added, and if it is 0, no slave station is added.

2. If bit 4 of SW1 of the wireless master station is ON, the data consists of 8-byte character codes.

D7	D6	D5	D4	D3	D2	D1	D0
8	7	6	5	4	3	2	1
16	15	14	13	12	11	10	9
24	23	22	21	20	19	18	17
32	31	30	29	28	27	26	25
40	39	38	37	36	35	34	33
48	47	46	45	44	43	42	41
56	55	54	53	52	51	50	49
64	63	62	61	60	59	58	57

If the wireless slave station of the above node address is 1, a slave station is added, and if it is 0, no slave station is added.

### 7-2-4 Entering/deleting wireless slave station

Enters or deletes a specified wireless slave station to or from the wireless network, enables or disables serial number check, and sets the Disconnect/Connect Switch.

#### Command format

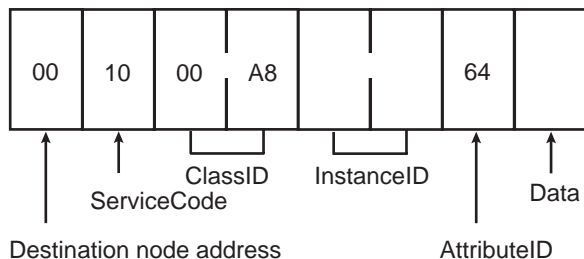

#### Response format

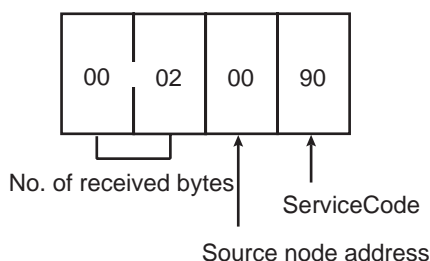

#### Parameter details

"InstanceID" (command)

Sets WNODE:01 - 40 Hex of a specified wireless slave station.

"Data" (command)

Set in the way shown below. The data consists of 1-byte character codes.

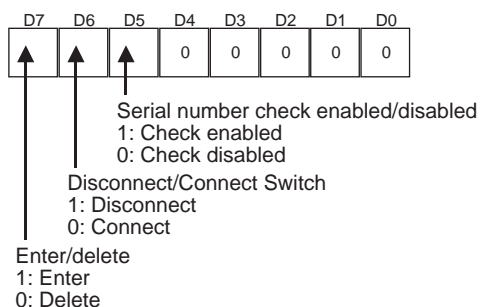

### 7-2-5 Setting the number of IN points

Sets the number of IN points of a specified wireless slave station.

#### Command format

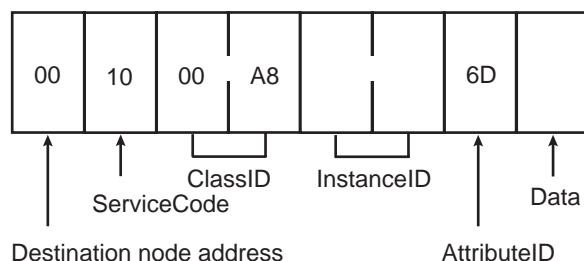



**Response format**

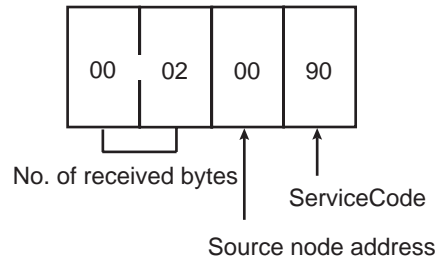

**Parameter details**

"InstanceID" (command)

Sets WNODE:01 - 40 Hex of a specified wireless slave station.

"Data" (command)

Sets the IN points (512 points (32 words) at maximum) as follows. The data consists of 1-byte character codes.

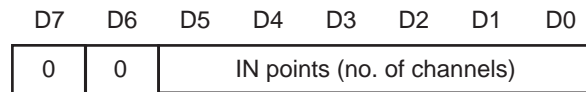

**7-2-6 Reading the number of IN points**

Reads the number of IN points of a specified wireless slave station.

**Command format**

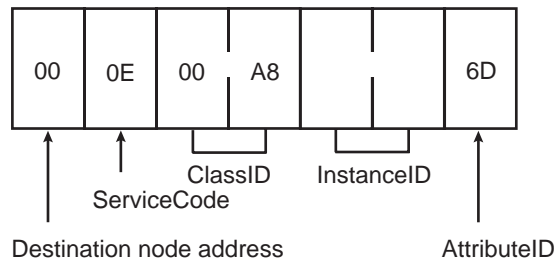

**Response format**

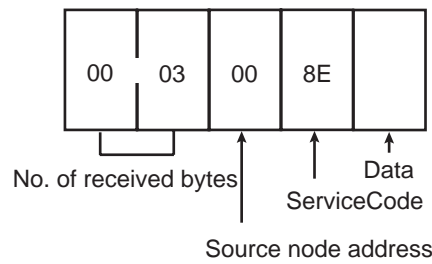

**Parameter details**

"InstanceID" (command)

Sets WNODE:01 - 40 Hex of a specified wireless slave station.

"Data" (response)

The read IN points (512 points (32 words) at maximum) are stored as follows. The data consists of 1-byte character codes.

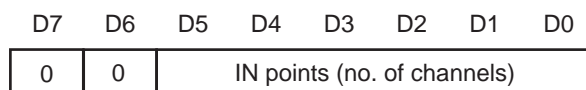

### 7-2-7 Setting the number of OUT points

Sets the number of OUT points of a specified wireless slave station.

**Command format**

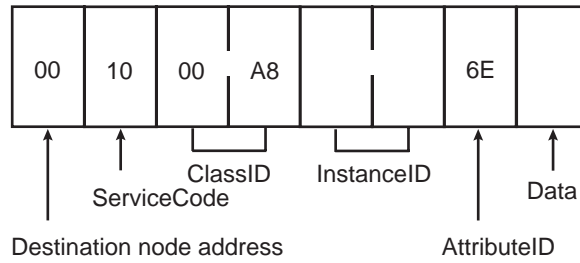

**Response format**

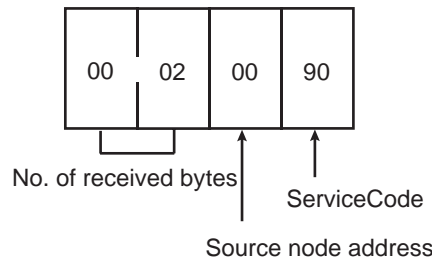

**Parameter details**

"InstanceID" (command)

Sets WNODE:01 - 40 Hex of a specified wireless slave station.

"Data" (command)

Sets the OUT points (512 points (32 words) at maximum) as follows. The data consists of 1-byte character codes.

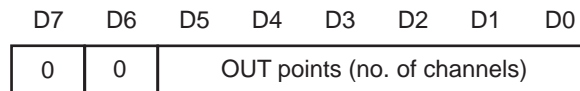

### 7-2-8 Reading the number of OUT points

Reads the number of OUT points of a specified wireless slave station.

**Command format**

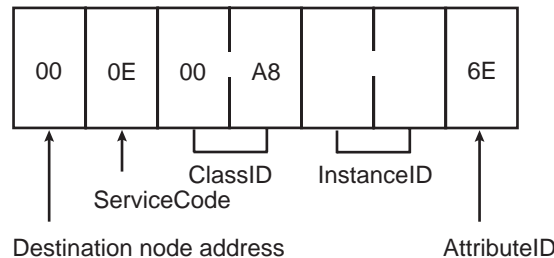

**Response format**

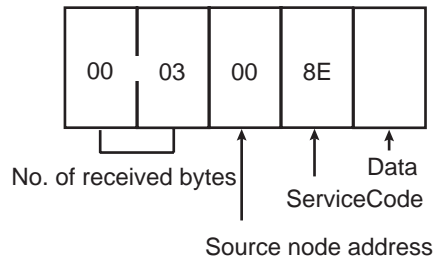

**Parameter details**

"InstanceID" (command)

Sets WNODE:01 - 40 Hex of a specified wireless slave station.

"Data" (response)

The read number of OUT points (512 points (32 words) at maximum) are stored as follows.

The data consists of 1-bit character codes.

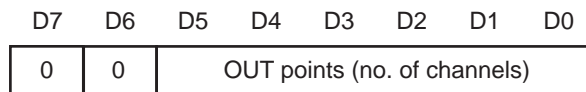

**7-2-9 Setting upper station node address**

Sets the node address of the upper station on the relay route of a specified wireless slave station.

**Command format**

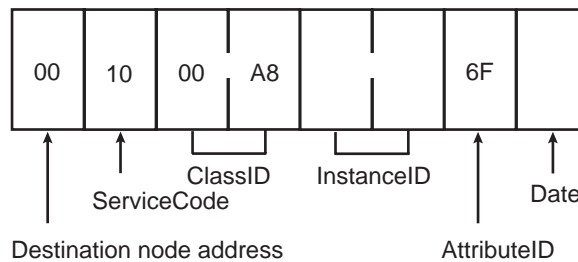

**Response format**

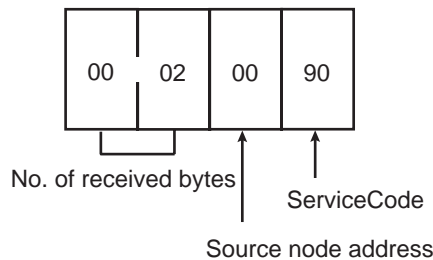

**Parameter details**

"InstanceID" (command)

Sets WNODE:01 - 40 Hex of a specified wireless slave station.

"Data" (command)

Sets the node address of the upper station as follows. The data consists of 1-byte character code.

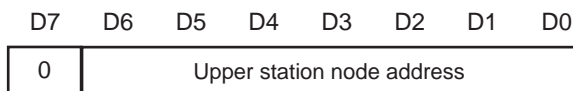

### 7-2-10 Reading upper station node address

Reads the node address of the upper station on the relay route of a specified wireless slave station.

#### Command format

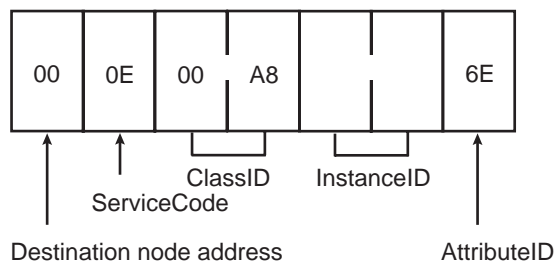

#### Response format

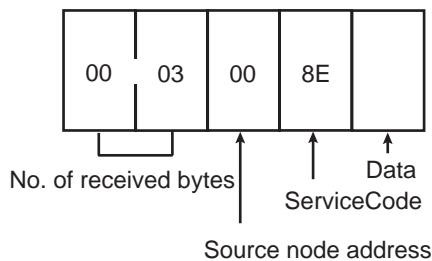

#### Parameter details

"InstanceID" (command)

Sets WNODE:01 - 40 Hex of a specified wireless slave station.

"Data" (response)

The read node address of the upper station is stored as follows. The data consists of 1-byte character codes.

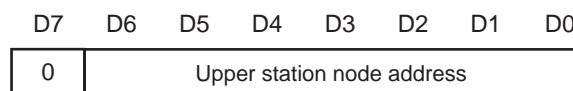

### 7-2-11 Reading wireless network status

Reads the status information of wireless network between the master station and a specified wireless slave station.

#### Command format

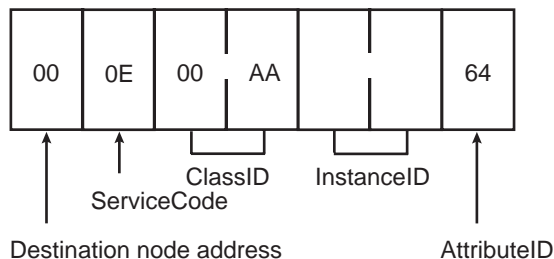

**Response format**

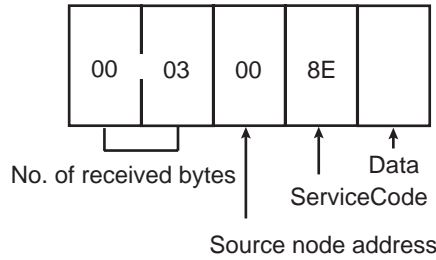

**Parameter details**

"InstanceID" (command)

Sets WNODE:01 - 40 Hex of a specified wireless slave station.

"Data" (response)

The read wireless network status is stored as follows. The data consists of 1-byte character codes.

D7	D6	D5	D4	D3	D2	D1	D0
0	0	0	0	Routing error	I/O structural error	0	Addition/Separation

**7-2-12 Reading wireless error counts**

Reads the error counts between the master station and a specified wireless slave station.

**Command format**

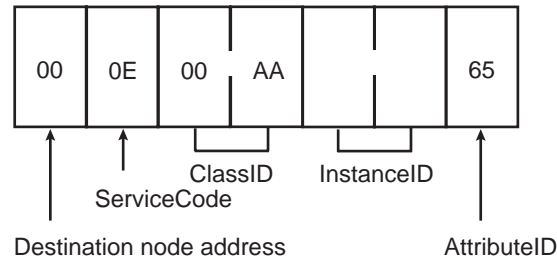

**Response format**

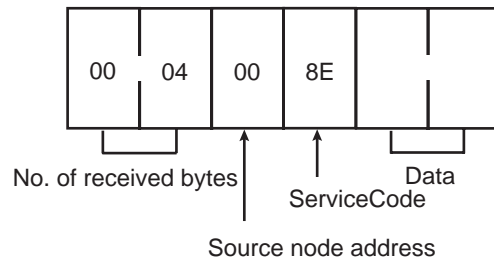

**Parameter details**

"InstanceID" (command)

Sets WNODE:01 - 40 Hex of a specified wireless slave station.

"Data" (response)

The number of the read wireless error counts is stored. The data consists of 2-byte character codes.

Error count (lower)
Error count (upper)

### 7-2-13 Reading DeviceNet master status

Reads the DeviceNet master status of a specified wireless slave station.

#### Command format

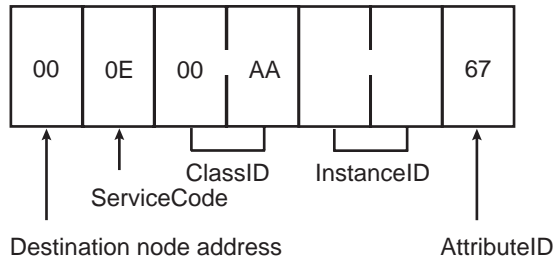

#### Response format

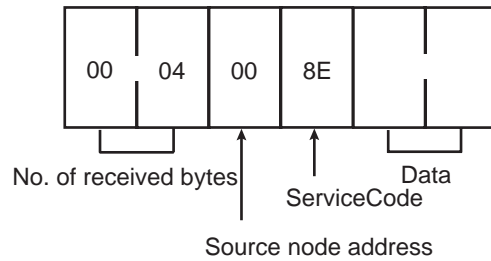

#### Parameter details

"InstanceID" (command)

Sets WNODE:01 - 40 Hex of a specified wireless slave station.

"Data" (response)

The read DeviceNet master status is stored. The data consists of 2-byte character codes.

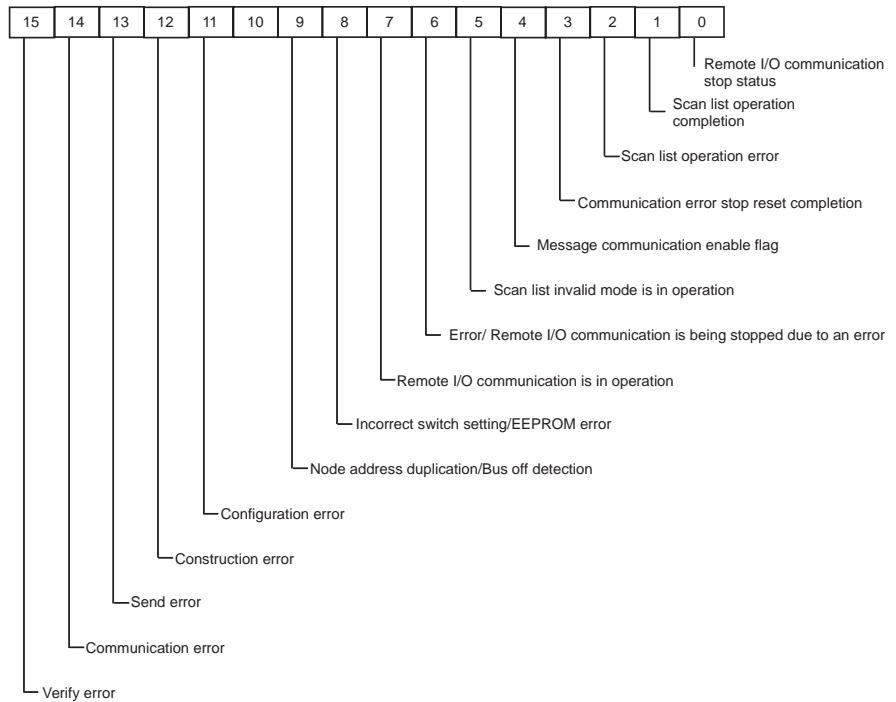

### 7-2-14 Writing settings/soft reset

Writes the settings in EEPROM or executes soft reset.

#### Command format

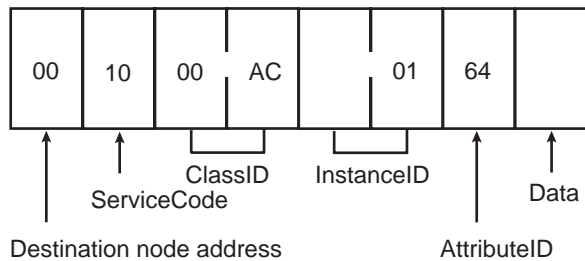

#### Response format (not for when executing soft reset)

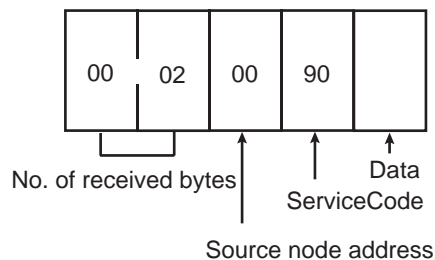

Parameter details

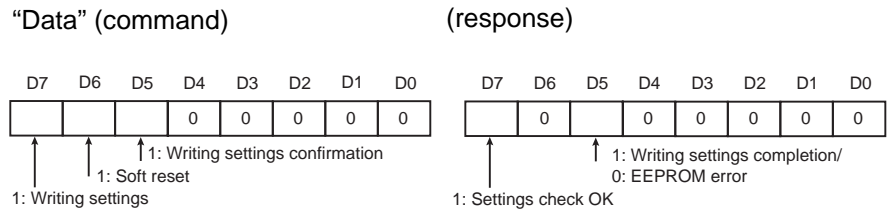

Error code

The error codes of when setting check NG are as shown in the following table.

Errors	Error code	Additional error code
I/O points error	19 Hex	01 Hex
Routing error	19 Hex	02 Hex



## 7-3 Explicit Messages Addressed to DeviceNet Slave Connected before DeviceNet Wireless Slave Station

The following items are possible by issuing Explicit messages to a DeviceNet slave connected before the wireless slave station from the PLC and PC on the DeviceNet network to which the wireless master station is connected.

- DeviceNet slave parameter settings/reference
- Commands issued to the DeviceNet slave

The transmission method for Explicit messages is shown below.

By installing a relay class that relays messages to the wireless master and slave stations, specifying the relay destination node to the relay class with an Instance ID, and specifying the relay service with a Service Code, the value set to the Service Data area is relayed.

ServiceCode	Relay Service	
ClassID	Relay Class	
InstanceID	Relay destination node	Wireless slave station WNODE
ServiceData	Data length	Data length of the data area
	ServiceCode	Explicit message relayed
	ClassID	
	InstanceID	
	AttributeID	

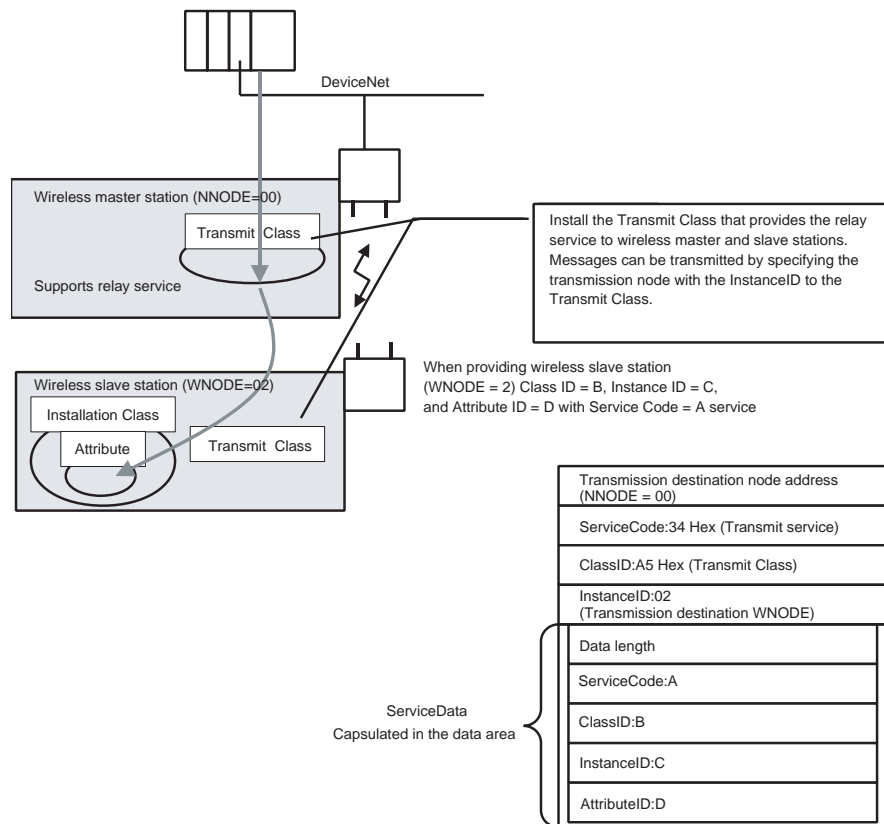

For example, when providing Service Code = A service for wireless slave station (WNODE = 02) Class ID:B, Instance ID: C, and Attribute ID: D with a wireless master station node address of NNODE = 00, the following is transmitted.

ServiceCode	34 Hex	Transmit service
ClassID	00A5 Hex	Transmit Obj
InstanceID	0002 Hex	Wireless master station WNODE
ServiceData	04 Hex	Data length 4 bytes
	A	ServiceCode
	B	ClassID
	C	InstanceID
	D	AttributeID

The command format is shown below.

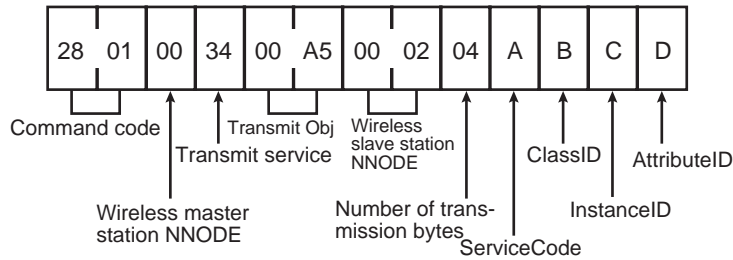

When performing multiple-staged relays, the message relayed to the Service Data area is capsulated before transmission. For example, when providing Service Code = A service for DeviceNet slave (WNODE = 03) Class ID:B, Instance ID: C, and Attribute ID: D connected before a wireless slave station (WNODE = 02), the following is transmitted.

ServiceCode	34 Hex	Transmit service
ClassID	00A5 Hex	Transmit Obj
InstanceID	0002 Hex	Wireless slave station WNODE
ServiceData	08 Hex	Number of transmission bytes 8 bytes
	34 Hex	Transmit service
	A5 Hex	Transmit Obj*
	03 Hex	DeviceNet slave node address*
	04 Hex	Data length 4 bytes
	A	ServiceCode
	B	ClassID*
	D	AttributeID

} 8 Byte

} 4 Byte

(\*Class ID and Instance ID are 1 byte in capsulated areas.)

The command format is shown below.

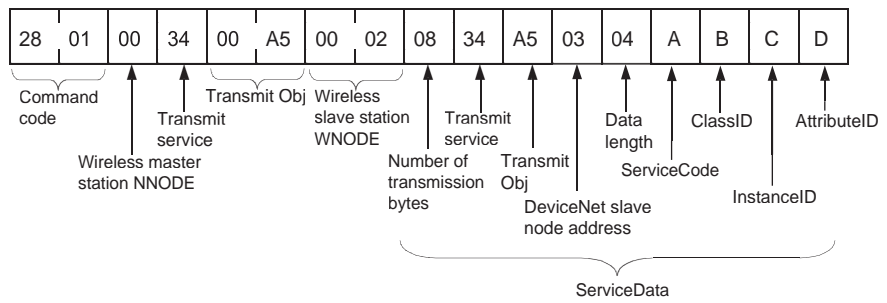

A representative example of the method for issuing Explicit messages to the RS232C unit (Model DRT1-232C2) is shown below.

(Ex. 1)

When transmitting an "RS232C receiving data read" command (specified to port 1) to the DRT1-232C with the system configuration shown below of a 1:1:1 connection of wireless master station (NNODE = 00), wireless slave station (WNODE = 02), and DRT1-2332C2 (node address = 03):

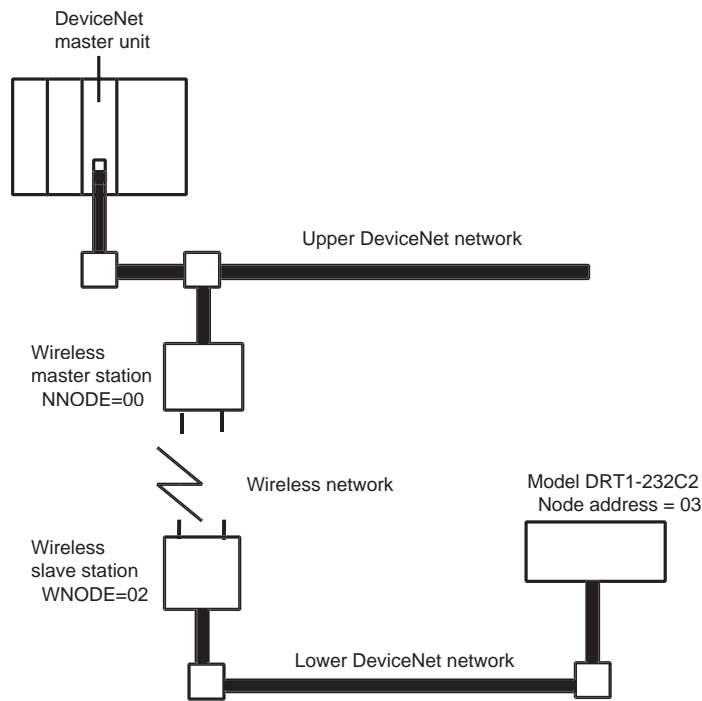

**Command format**

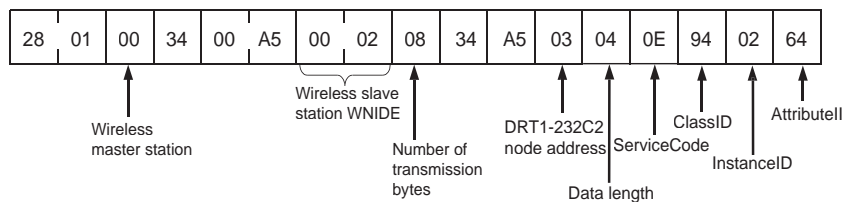

**Response format (when abcd is 4 bytes for receiving data)**

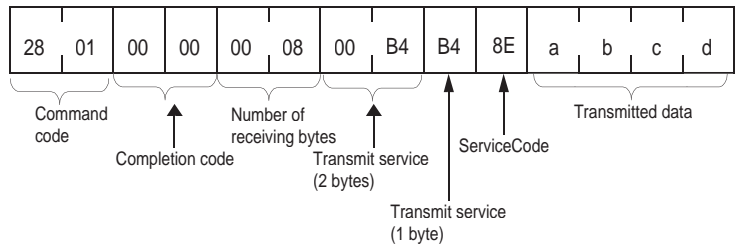

(Ex. 2)

When transmitting a "RS232C receiving data read" command (specified to port 1) to the DRT1-232C with the system configuration shown below of a 1:1:1:1 connection of wireless master station (NNODE = 00), 1 relay station, wireless slave station (WNODE = 03), and DRT1-232C2 (node address = 04):

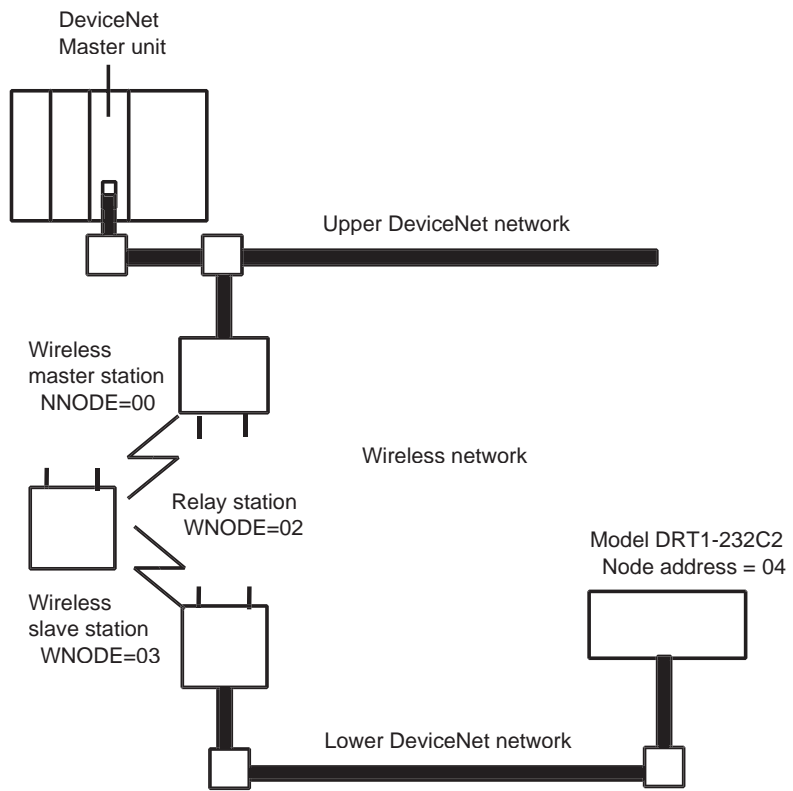

**Command format**

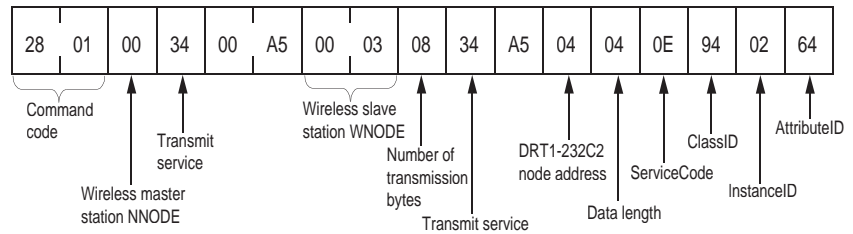

**Response format (when abcd is 4 bytes for receiving data)**

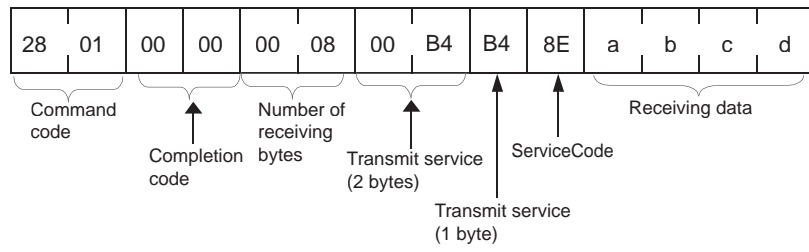

Refer to Section 3-2 for an example of an Explicit message transmission sample program.



# SECTION 8

## Using the Configurator

This section explains how to monitor the conditions and make the various settings of the wireless network used for the configurator.

8-1	Additional Functions . . . . .	108
8-1-1	Operating environment . . . . .	108
8-2	Wireless Network Configuration Display . . . . .	108
8-3	Wireless Network Parameter Editing . . . . .	112
8-3-1	Setting procedure flow . . . . .	112
8-3-2	Setting procedure . . . . .	112
8-4	Wireless Channel Monitor . . . . .	116
8-4-1	Monitoring all channels . . . . .	117
8-4-2	Monitoring 1 channel . . . . .	119
8-5	Running Test . . . . .	121
8-5-1	Explanation of functions . . . . .	121
8-5-2	Test procedure . . . . .	122

## 8-1 Additional Functions

The following functions have been added to the DeviceNet configurator for use with the DeviceNet wireless unit.

- Wireless network configuration display
- Wireless network parameter editing (setting/reading device parameters)
- Wireless channel monitor
- Running test

### 8-1-1 Operating environment

Model	3G8F5-DRM21	3G8E2-DRM21
Hardware	Dedicated ISA board	Dedicated PCMCIA card (Type II)
Compatible computers	DOS/V compatible computers (IBM PC/AT compatible) Recommended model: FC55 model 11 (OMRON)	DOS/V compatible computers (IBM PC/AT compatible)
OS	Windows 95/98 Windows NT 4.0 Workstation	Windows 95/98
CPU	When using Windows95: at least i486DX2 66MHz When using WindowsNT: at least Pentium 90MHz	
Available hard disk space	At least 5 megabytes (Although this depends on varying conditions, a separate capacity of 30 megabytes maximum is required per day.)	
Memory	When using Windows95: at least 12MB (at least 16MB recommended) When using WindowsNT: at least 16MB (at least 24MB recommended)	
Floppy disk drive	1 drive for 1.44MB 3.5 inch 2HD floppy disks	
Display	At least VGA display functions	

## 8-2 Wireless Network Configuration Display

Wireless slave station route information and the wireless network configuration are shown in the "Device" window.

The tree display of the wireless master station is shown in real time as a tree view route according to wireless slave station route information.

### Device monitor display

Refer to the DeviceNet Configurator Operation Manual for details about starting up and shutting down the DeviceNet configurator.

- 1,2,3...**
1. Set the wireless master station "mode select switch" to RUN.
  2. Read the Network Configuration from the Network.
    - a) Place the Configuration online.
    - b) Select Network.
    - c) Select Upload.



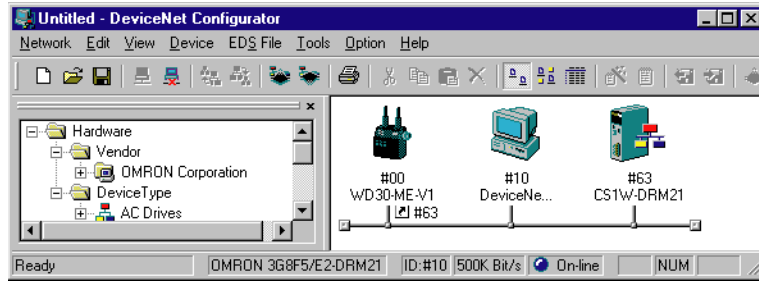

3. Select the WD30-ME-V1 icon and right-click to run "Monitor".  
The following window will be displayed. Wireless slave stations for which the Disconnect/Connect Switch has been turned ON will not be displayed.

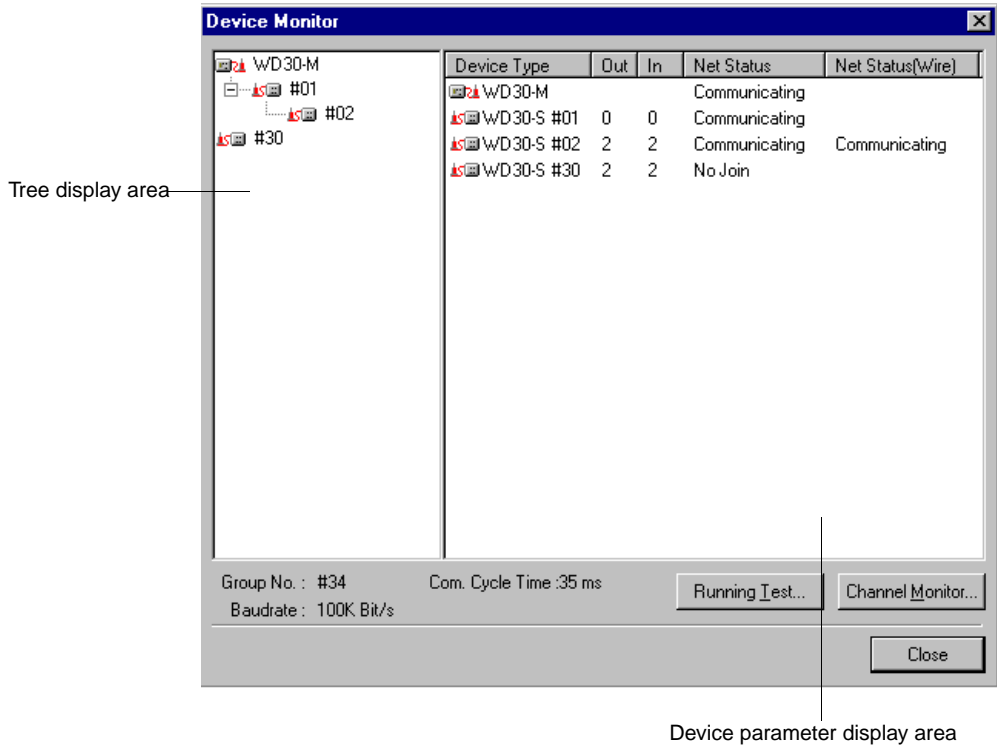

- Device type: Product model (displays the wireless slave station unit node No.)
- Out: OUT size registered with the wireless slave station
- In: IN size registered with the wireless slave station
- Net Stat (Wire): Displays the wireless network communication status.  
The following types of messages are displayed.
  - Communicating (Communication are occurring normally.)
  - No join (Communication is blocked.)
  - Error (An error has occurred.)
- Net Status (Wire): Displays the DeviceNet network communication status.
- Group No.: Displays the contents set at the DeviceNet wireless unit WCH.
- Com.Cycle Time: The latest wireless communication cycle time for the user's system.

Baudrate (Wireless communication speed):

This value is fixed.

The status when communication is normal between wireless master station and wireless slave station (#01), and when normal communication is not possible for the wireless slave station (#30), is displayed on the screen above.

- Click the "Running Test" button to log the wireless network communication error status in a file. Refer to section 8-5 *Running Test* for details.

Click the "Channel Monitor" button to monitor the status of each channel or all channels together. Refer to section 8-4 *Wireless Channel Monitor* for details.

**Note** When starting up the DeviceNet configurator, click the "Online" button on the "Online Settings" window to display the following message.

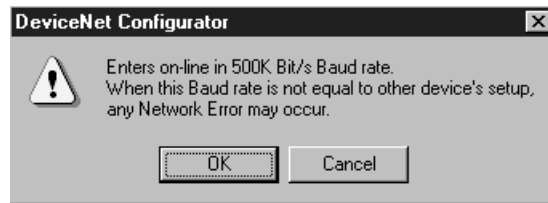

Click the "OK" button to start up the DeviceNet configurator.

**DeviceNet network configuration display for wireless slave station**

- Select Move to Lower Network.

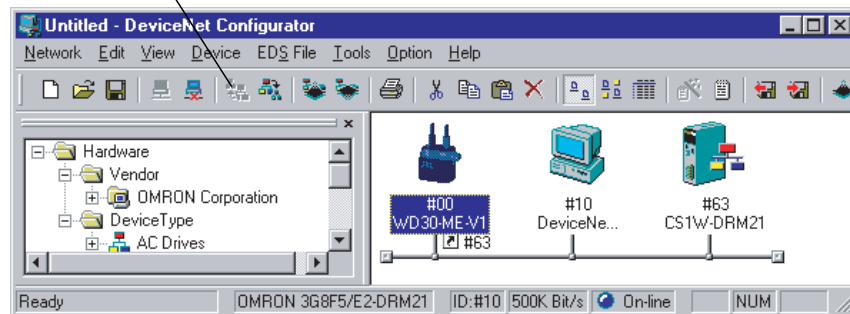

- The following window will be displayed. It shows the wireless slave stations registered at the wireless master station that can be moved to. Select one wireless slave station and click the "OK" button.

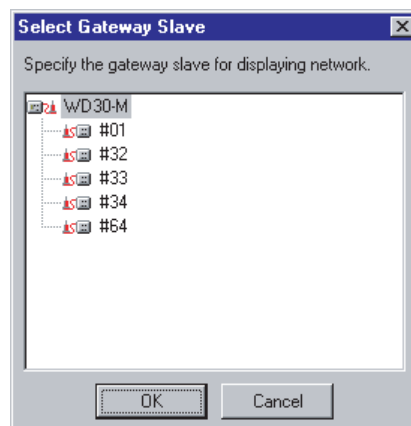

- The DeviceNet slaves (DRT1-ND16S in this example) connected to the DeviceNet network for the selected wireless slave station will be displayed.

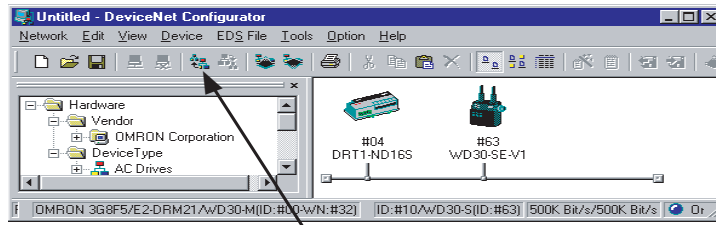

4. To return to the original window, select Move to Upper Network.



**Resetting the wireless slave station**

Although the wireless master station has a reset function, the wireless slave station does not have this function. Executing the reset operation will have no effect.

## 8-3 Wireless Network Parameter Editing

This section covers the setting procedures for wireless network configuration parameters, such as wireless slave station registration.

### 8-3-1 Setting procedure flow

The procedure for setting wireless network parameters is shown below.

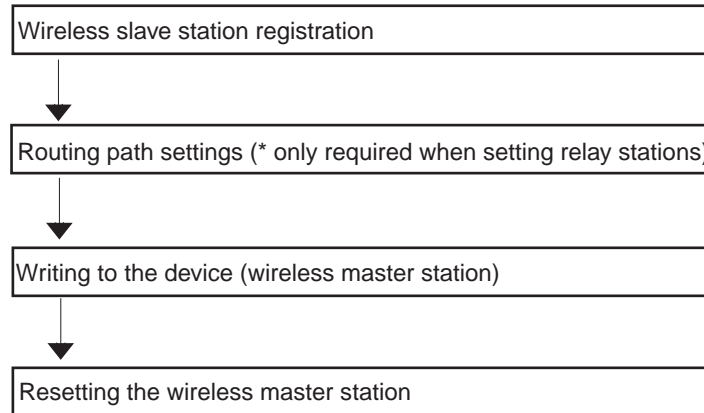

### 8-3-2 Setting procedure

#### Wireless slave station registration

The wireless slave station to be registered on the wireless network should be registered on the wireless master station.

1,2,3...

1. Set the wireless master station "mode select switch" to RUN.
2. Select the wireless master station to which the wireless slave station is to be registered from the "Network Configuration" window on the DeviceNet configurator.

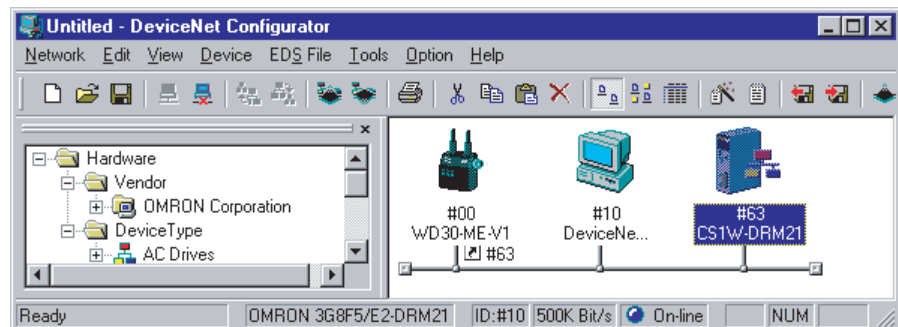

3. Select "Edit Device Parameters" from "Edit" on the menu bar.  
Depending on the type of wireless master station used, one of the following screens is displayed.  
If the wireless master station is a WD30-M or a WD30-ME, the following screen is displayed.

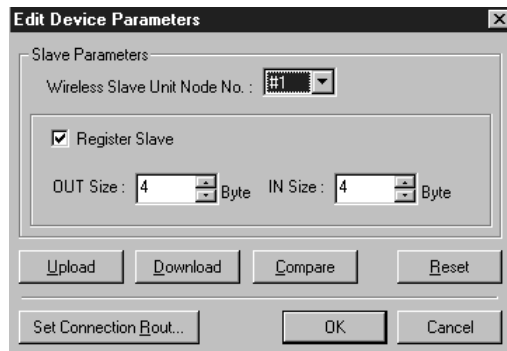

If the wireless master station is a WD30-ME-V1, the following screen is displayed.

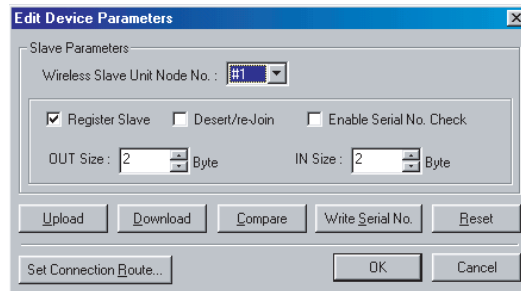

4. Select the node No. of the wireless slave station unit you want to register from the drop down box. Click the box to the left of "Register Slave" so that a check mark  appears.
5. Set the "OUT Size" and the "IN Size".  
Be careful to enter the byte number (even number), not the channel number.  
Enter "0" to create a relay station.
6. Enable serial number check for the wireless slave station by clicking the box to the left of "Enable Serial No. Check" so that a check mark appears.

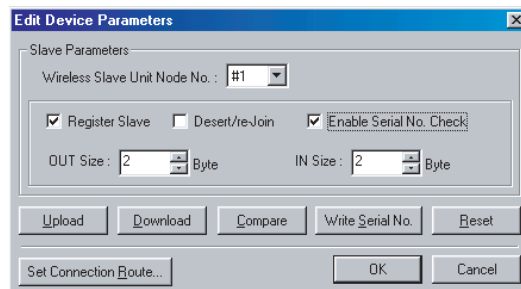

7. To disconnect the wireless slave station from the network, click the Disconnect/Connect Switch box (indicated by "Desert/re-Join" in the display) so that a check mark appears.

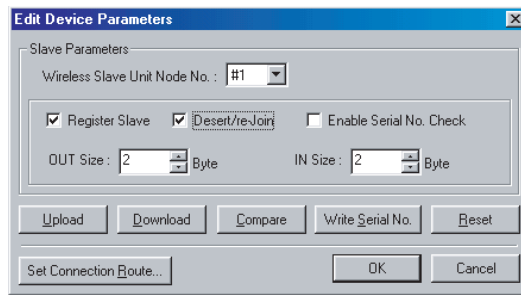

**Routing path settings  
(\* only required when  
setting relay stations)**

Set the wireless network configuration to be set with the wireless slave station as a relay station.

1,2,3...

1. Set the wireless slave station (including relay stations) "mode select switch" to RUN.
2. Click the "Set Connection Routing" button in the "Edit Device Parameters" window.

The following window will be displayed.



Wireless slave stations for which the Disconnect/Connect Switch has been turned ON will not be displayed.

3. Drag and drop the wireless slave station to set the routing path.

At this time, the wireless slave station (#01) becomes a relay station.



Drag and drop  
→

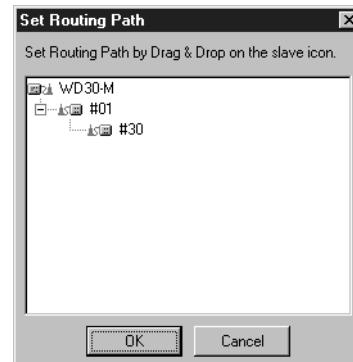

4. After completing the settings, click the "OK" button.

Write the set parameters to the wireless master station.

**Writing to the device  
(wireless master station)**

1,2,3...

1. Click the "Download" button on the "Edit Device Parameters" window.
2. The following message will be displayed. Click "Yes".

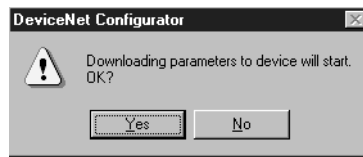

- With WD30-ME-V1 wireless master units with Identity Object Revision value 3.01, which do not have the Disconnect/Connect Switch or serial number check functions, after clicking the "Download" button on the "Edit Device Parameters" window, the following warning message will be displayed. Click "OK" to download.

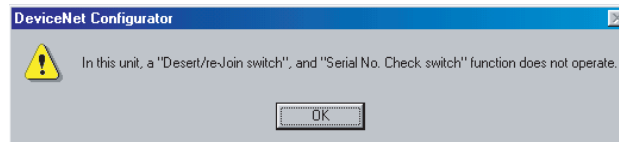

- The following window will be displayed during writing. Also, once writing begins, the wireless master station 7 segments LED will display "st".

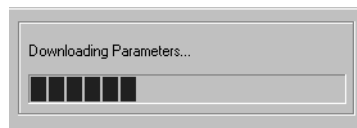

- When the window disappears, writing to the wireless master station is complete.

### Resetting the wireless master station

Reset the wireless master station. The parameters written to the wireless master station will be followed.

1,2,3...

- Click the "Reset" button in the "Edit Device Parameters" window.
- The following message will be displayed. Click "Yes". The wireless master station will be reset.

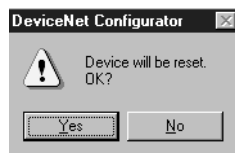

### Writing the serial number

Use the following procedure to communicate with registered wireless slave stations and register their serial numbers to the wireless master station.

1,2,3...

- Turn ON the power to the wireless slave stations to allow communications.
- Click the "Write Serial No." button in the "Edit Device Parameters" window. The following message will be displayed. Click "Yes."

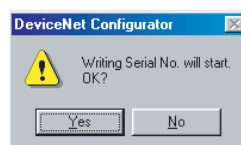

- While communications is performed and the serial numbers are written, the following window will be displayed.

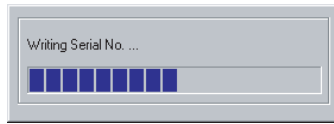

- 4. If this window disappears and the following window is displayed, the serial numbers have been successfully written.

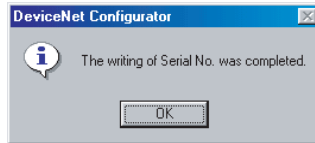

If there were some wireless slave stations for which the serial number could not be written (e.g., because communications were not possible), those wireless slave stations are displayed in the way shown below.

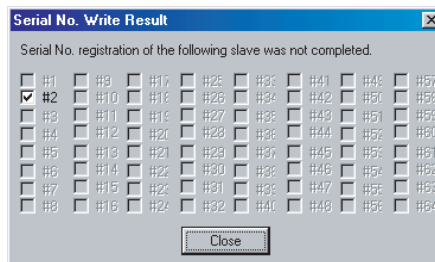

After taking any steps necessary to restore communications with the wireless slave stations (e.g., by making switch settings), click the "Write Serial No." button again.

## 8-4 Wireless Channel Monitor

- You can acquire the receiving wave level for the frequency bands used (all channels) to select a channel (frequency band) that can be used.
- You can log all channels or the temporal variation in the receiving wave level of a specified channel.
- While monitoring all channels, you can display a bar graph with the receiving wave level along the vertical axis and the wireless channels along the horizontal axis, with the current values and maximum values for each channel.
- While monitoring a single channel, you can display a broken line graph with the receiving wave level along the vertical axis and the time along the horizontal axis.
- The monitoring results can be saved as CSV files on the computer.



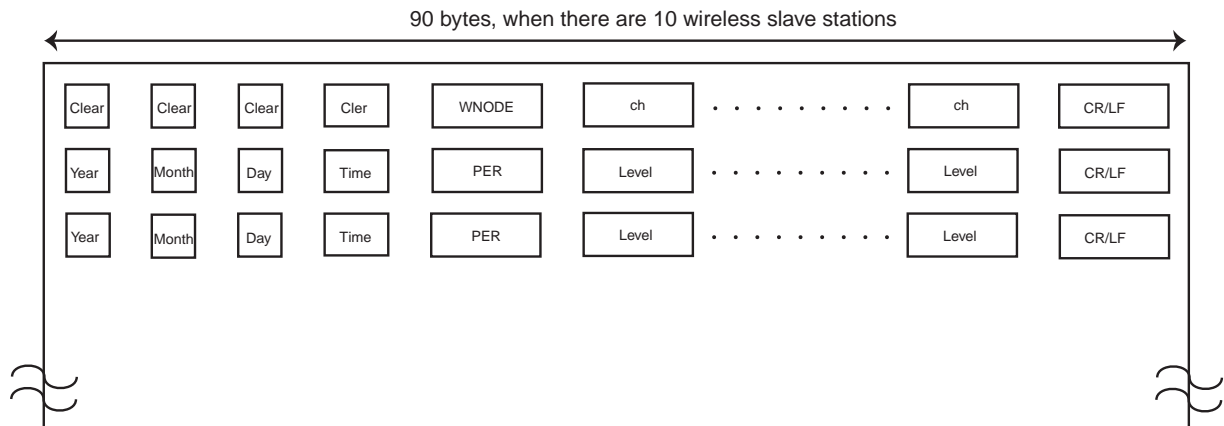

Item	Meaning	Data size (bytes)	Value
ch	Wireless channel number	2	01 to 34
Year	Calendar year	4	2001 or more
Month	Month	2	1 to 12
Day	Day	2	1 to 31
Time	Time	8	00:00:00 to 23:59:59
Level	Receiving wave level	2	00 to 64
CR/LF	Line feed	2	* ASCII code indicating a line return
Clear	Space	As appropriate	* ASCII code indicating a space

### 8-4-1 Monitoring all channels

- 1,2,3...**
1. Set the wireless master station "mode select switch" to RUN.
  2. Click the "Channel Monitor" button on the "Device Monitor" screen.
  3. The following message will be displayed. Click "Yes".

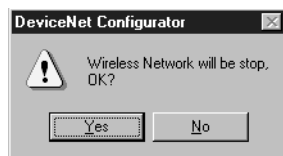

4. The channel monitor window will be displayed.

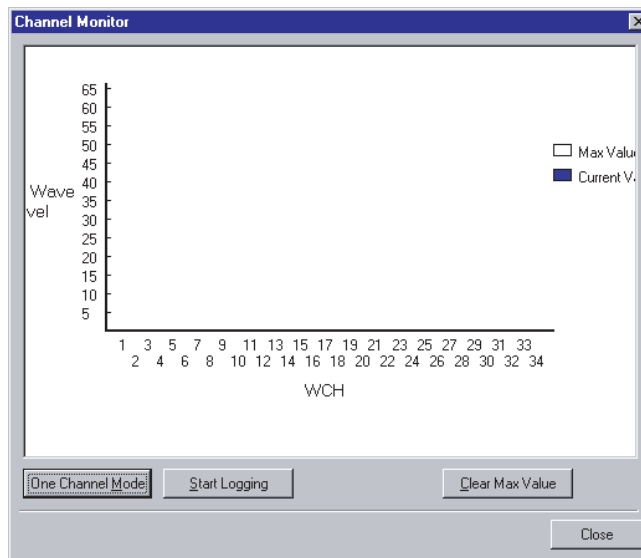

A few minutes after this window is opened, the graph display for monitoring all channels will begin.

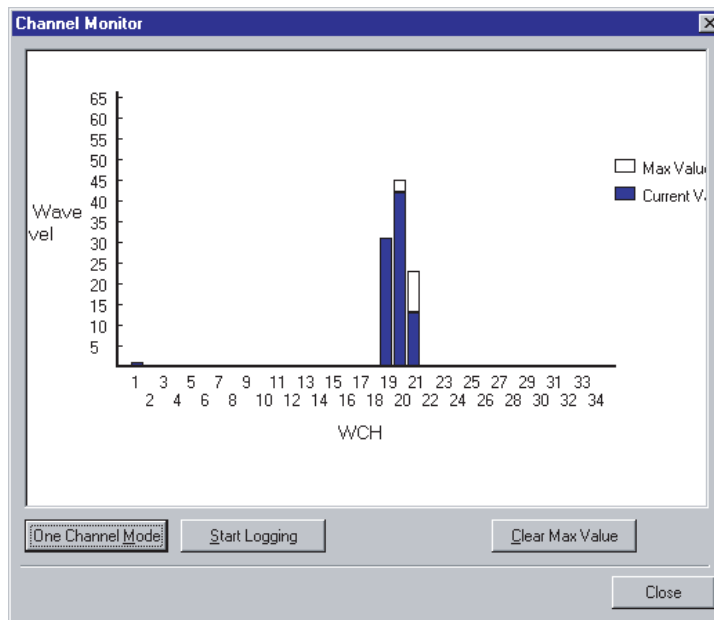

Maximum value (white): The maximum value of all acquired receiving wave levels is displayed.

Current value (blue): The latest receiving wave level is displayed.

Select a channel with a wave level of 5 or less (as a rough guide). A wave level of approximately 5 may be displayed for 1CH due to small waves from the wireless device itself. Do not, however, select this channel.

5. Click the "Clear Max Value" button to clear the maximum value.

**Logging**

The results from monitoring all channels are saved in CSV format in the computer.



**Caution when logging**

Even while making logging settings, logging will end if the disk becomes too full to write additional data.

- 1,2,3...**
1. Click the "Start Logging" button.
  2. The following window is displayed.  
Set the "Term", "Interval", "Filename", and "Save Folder", and then click the "OK" button.  
Logging will then begin.

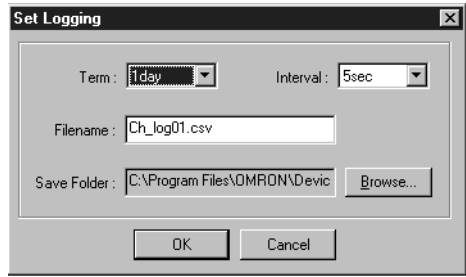

The setting values and initial values are as shown below.

	Possible setting values	Initial values
Interval (Logging interval)	5, 10, 30, 60 (seconds)	5 (seconds)
Term (Logging term)	1, 7, 15, 30 (days)	1 (days)
File name	File names possible with Windows	Ch_log## ## is the number in the save directory.
Save Folder	Directory names possible with Windows	C:\Program Files \Omron \CompoBus/D \Configurator  (When the DeviceNet configurator is installed in default installation directory)

3. Click the "Stop Logging" button to stop logging.
4. The following message will be displayed. Click "Yes" to stop logging.

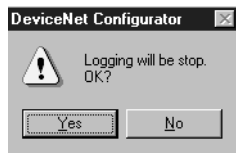

### 8-4-2 Monitoring 1 channel

- 1,2,3...**
1. Click the "One Channel Mode" button in the "Channel Monitor" window.
  2. The following window will be displayed.  
Select the channel you want to monitor, and click the "OK" button.

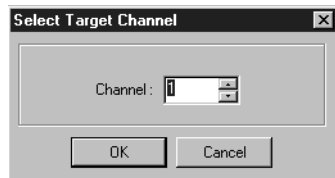

3. A graph indicating the temporal variations in the transmission level of the selected channel begins to appear.

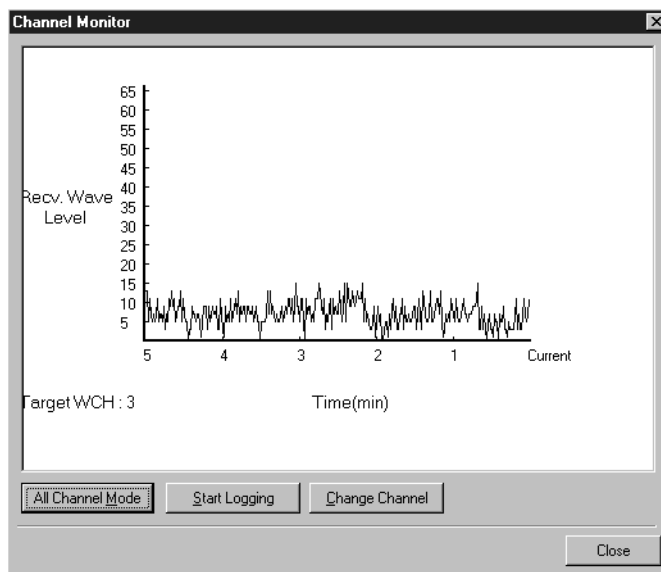

**Changing channels**

- 1,2,3...**
1. Click the "Change Channel" button to change the channel you want to monitor.
  2. The "Select Target Channel" window will be displayed.  
 Select the channel you want to monitor, and click the "OK" button.  
 A graph indicating the transmission level of the selected channel begins to appear.

**Logging**

The results from monitoring all channels are saved in CSV format in the computer.

- 1,2,3...**
1. Click the "Start Logging" button.
  2. The following window is displayed.  
 Set the "Term", "Interval", "Filename", and "Save Folder", and then click the "OK" button.  
 Logging will then begin.

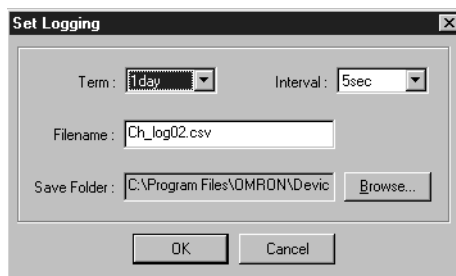

The setting values and initial values are as shown below.

	Possible setting values	Initial values
Interval (Logging interval)	5, 10, 30, 60 (seconds)	5 (seconds)
Term (Logging term)	1, 7, 15, 30 (days)	1 (days)

	Possible setting values	Initial values
File name	File names possible with Windows	Ch_log## ##is the number in the save directory.
Save Folder	Directory names possible with Windows	C:\Program Files \Omron \CompoBus/D \Configurator (When the DeviceNet configurator is installed in default installation directory)

3. Click the "Stop Logging" button to stop logging.
4. The following message will be displayed. Click "Yes" to stop logging.

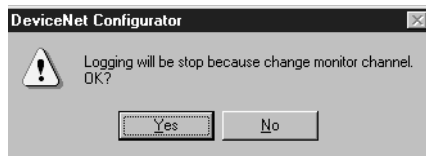

Click the "Close" button to end channel monitoring.  
The "Channel Monitor" window will close.

## 8-5 Running Test

With a running test, you can log the wireless network transmission error status into a file. This can be useful when performing maintenance on the user systems.

### 8-5-1 Explanation of functions

- Multiple wireless slave stations can be specified for the test.
- The number of test packet transmissions and the number of test packet receiving errors for each wireless station are acquired every 5 minutes to calculate the packet error rate. This data is stored in CSV format in the computer.

The wireless master station transmission and error counters are cleared by the data acquisition message. Therefore, the latest acquired data is displayed for 10 seconds.

- Before performing a running test, complete wireless slave station registration, and then connect the registered I/O points.



#### Packet error rate

The packet error rate is the ratio of receiving error packets to the number of test packet transmissions.

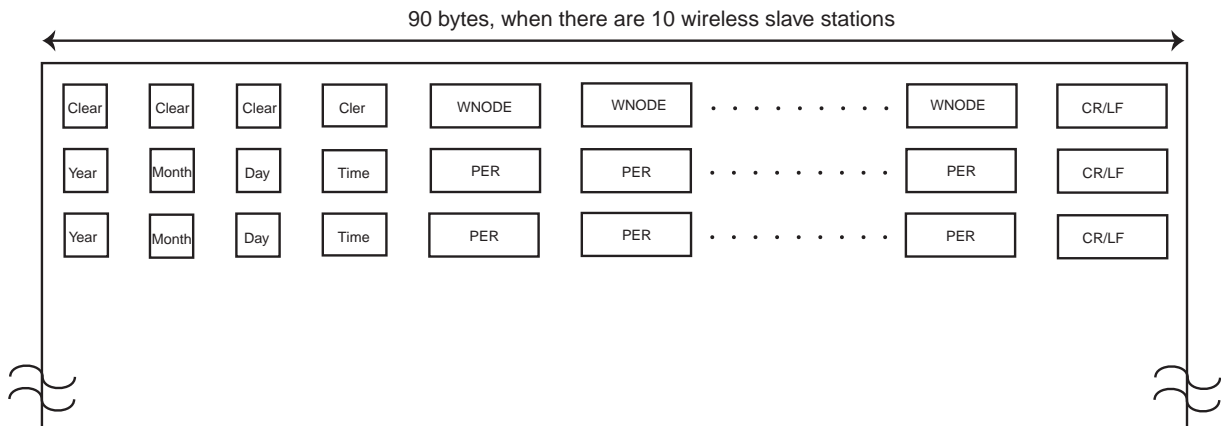

Item	Meaning	Data size (bytes)	Value
Year	Calendar year	4	2001 or more
Month	Month	2	1 to 12
Day	Day	2	1 to 31
Time	Time	8	00:00:00 to 23:59:59
WNODE	Test match No.	2	01 to 64
Level	Packet error rate	6	0, 0.0001 to 1.0000
CR/LF	Line feed	2	* ASCII code indicating a line return
Clear	Space	As appropriate	* ASCII code indicating a space

### 8-5-2 Test procedure

- 1,2,3...
1. Set the wireless master station "mode select switch" to RUN.
  2. Click the "Running Test" button on the "Device Monitor".
  3. The running test window is displayed.

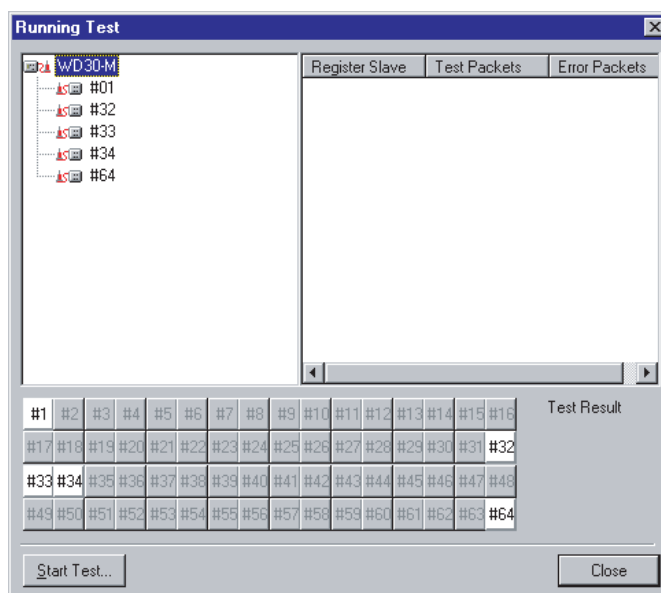

4. Click the node address for the wireless slave station to be tested. The selected wireless slave station is displayed in blue in the "Register Slave" box on the right side of the screen.

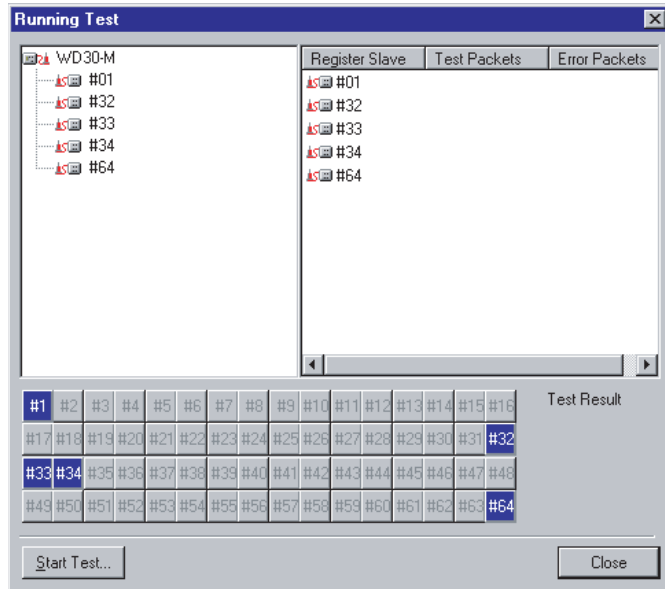

5. After wireless slave station selection is complete, click the "Start Test" button.
6. The following window is displayed.  
Select the "Term", "Filename", and "Save Folder", and then click the "OK" button.

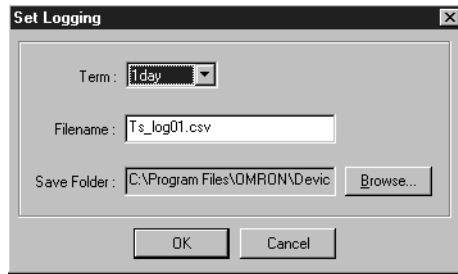

The setting ranges and initial values are shown below.

	Possible setting values	Initial values
Term (Logging term)	1, 7, 15, 30 (days)	1 (days)
File name	File names possible with Windows	Ts_log## ##is the number in the save directory.
Save Folder	Directory names possible with Windows	C:\Program Files \Omron \CompoBus/D \Configurator (When the DeviceNet configurator is installed in default installation directory)

7. Start the running test and logging.



**Caution when logging**

Even while making logging settings, logging will end if the disk becomes too full to write additional data.

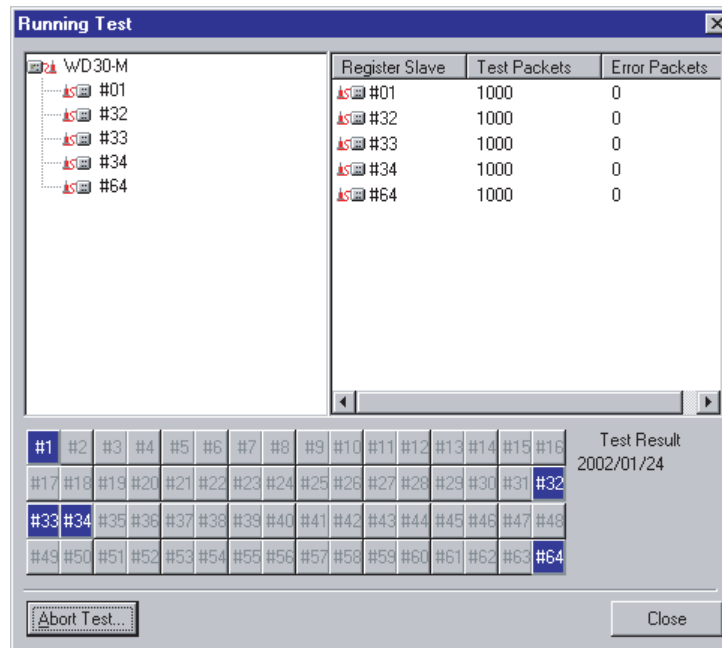

The number of test packets and the number of error packets will be displayed on the screen. Although the criteria varies with the application, 10 or less error packets (i.e., a packet error rate of 0.01 or less) indicates that communications are satisfactory.

8. To stop the running test and logging, click the "Abort Test" button.

The running test and logging will stop.

Click the "Close" button to close the "Running Test" window.



# SECTION 9

## Communications Timing

This section explains the remote I/O communications response time and the delay time between wireless networks when the DeviceNet wireless unit is connected.

9-1	Remote I/O Communications Performances . . . . .	126
9-1-1	I/O response time . . . . .	126
9-1-2	Wireless communication cycle time (TWCY) . . . . .	128
9-1-3	Actually measured reference data. . . . .	128
9-2	Message Communication Performance . . . . .	134
9-2-1	Message communication time . . . . .	134
9-2-2	Reference data . . . . .	135

## 9-1 Remote I/O Communications Performances

This section describes the performances of remote I/O communications when the DeviceNet wireless unit is used. Specifying communications timing as calculated is difficult in a wireless network compared to a wire communication network. Thus, the timings presented here are in accordance with the standard expressions and the actually measured data resulting from the OMRON system test. This unit is not applicable for applications requiring real time control. Instead, use this data as a scale to determine if this unit is applicable to your need.

The equations provided here are valid under the following conditions:

- The DeviceNet Master Unit is an OMRON product.
- The Master Unit is operating with the scan list valid mode.
- All of the required wireless slave stations and DeviceNet slaves have been added in communications.
- No errors are being indicated at either the DeviceNet master unit or wireless units.
- Messages are not being produced in the Network (from another company's configurator, for example).

- Note**
1. The values provided by these calculations may not be accurate if another company's DeviceNet Master or Slave unit is being used.
  2. This manual only refers to parts related to the wireless unit. For details about the DeviceNet Master unit or the entire DeviceNet system, refer to the "DeviceNet User's Manual", and for details about Slaves, refer to the "DeviceNet Slave Manual".

### 9-1-1 I/O response time

The I/O response time is the time it takes from the reception of an input signal at an Input Slave (REMOTE I/O TERMINAL) to the output of the corresponding output signal at an Output Slave (REMOTE I/O TERMINAL) via the process by the ladder program in the PLC module.

Since the wireless master station operates as a DeviceNet slave virtually, and the wireless slave station operates as the DeviceNet master, also virtually, a time delay among wireless network is not noticeable in the operation from the PLC. However, the actual I/O response time depends on the number of wireless slave stations, and if relayed, on the number of relay stages due to the time delay among wireless networks and 1:N polling communication.

The following describes the maximum I/O response time.

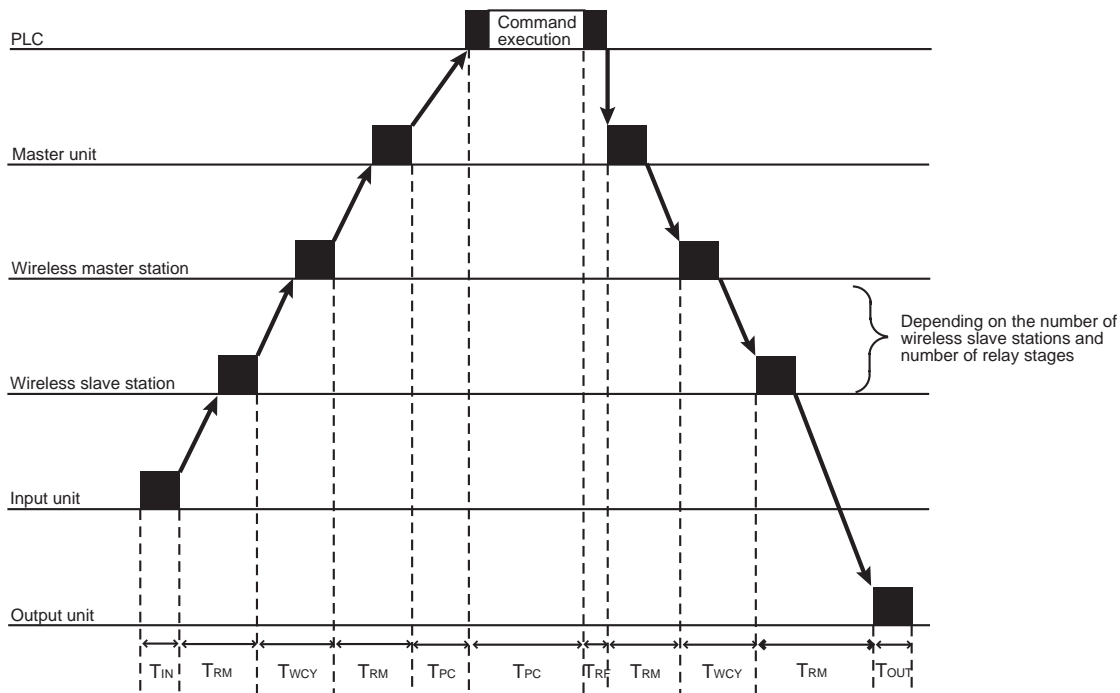
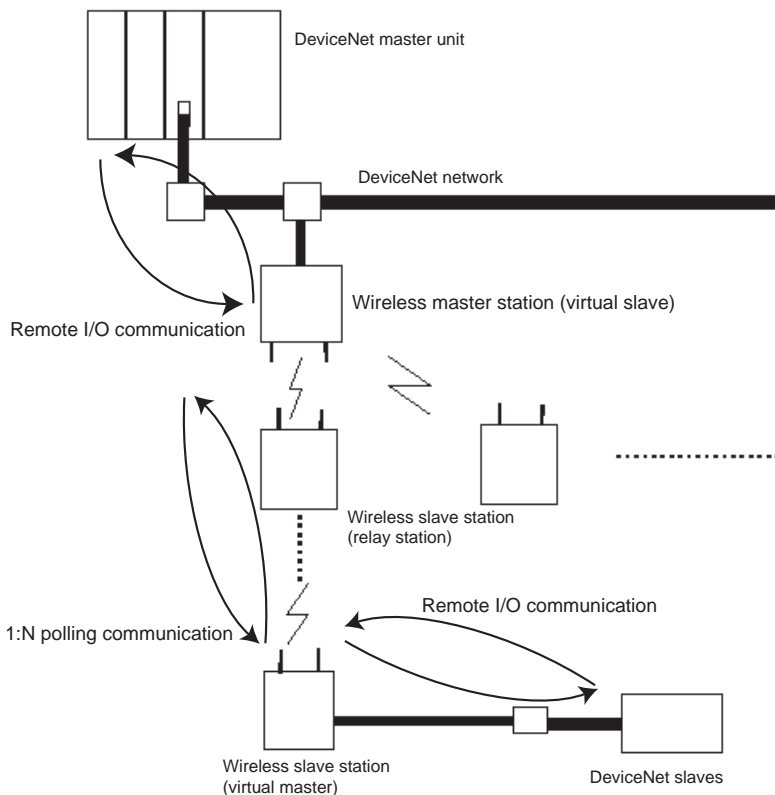

- $T_{IN}$  : Input I/O unit ON (OFF) delay time
- $T_{OUT}$  : Output I/O unit ON (OFF) delay time
- $T_{RM}$  : Communication cycle time (DeviceNet)
- $T_{WCY}$  : Wireless communication delay time
- $T_{PLC}$  : Peripheral devices execution system cycle time at the PLC
- $T_{RF}$  : DeviceNet unit refresh time at the PLC

**Note** For details on the Input I/O Unit input delay time and the Output I/O Unit output delay time, refer to the information in the "DeviceNet Slave Manual"; for details on the communication cycle and refresh processing time, refer to the information of the remote I/O communication performance in the "DeviceNet User's Manual". Refer to the PLC Operation Manual for details on the PLC cycle time.

The maximum I/O response time (T MAX) can be obtained from the following expression:

$$T_{MAX} = T_{IN} + T_{OUT} + 4 \times T_{RM} + 2 \times T_{WCY} + 2 \times T_{PLC} + T_{RF}$$

### 9-1-2 Wireless communication cycle time (T<sub>WCY</sub>)

Wireless communication delay time occurs in a wireless network when using wireless units. The wireless communication delay time becomes longer depending on the increase in the number of wireless slave stations and relay stages. The unit is ms.

$$T_{WCY} = \sum_{WNODE} (\text{Total cycle time of wireless slave stations})$$

$$= \sum_{WNODE} \{ (T_{X\_LEN<WNODE>} + R_{X\_LEN<WNODE>}) / 12 + 2 + 2 \} \times (\text{No. of relay stages} + 1)$$

T<sub>X\\_LEN<WNODE></sub>: Command data length

R<sub>X\\_LEN<WNODE></sub>: Response data length

$$T_{X\_LEN<WNODE>} = 29 + \text{OUTSIZE [byte]} + \text{No. of relay stages (No. of stages = byte)}$$

Command header

$$R_{X\_LEN<WNODE>} = 41 + \text{INSIZE [byte]} + \text{No. of relay stages (No. of stages = byte)}$$

Response header

OUTSIZE [byte]: Add 1, if an odd number results when even numbers, slave 8-point output, etc. are used.

INSIZE [byte]: Add 1, if an odd number results when even numbers, slave 8-point input, etc. are used.

Wireless slave stations for which the Disconnect/Connect Switch is set to ON (i.e., disconnected) are not included in the total cycle time of wireless slave stations.

### 9-1-3 Actually measured reference data

Use the following values of the I/O response time (IN input -PLC processing -OUT output) measured by the OMRON system test as reference.

The data described is the smallest and largest values resulting from 30 times of continuous testing. The actual measurements could be longer than the largest value depending on the environment where the measurements were taken. Thus, use the results only as a reference.

(Ex. 1)

1 wireless master station:1 slave station:2 DeviceNet slaves -->  
Min. 21ms, Max. 33ms

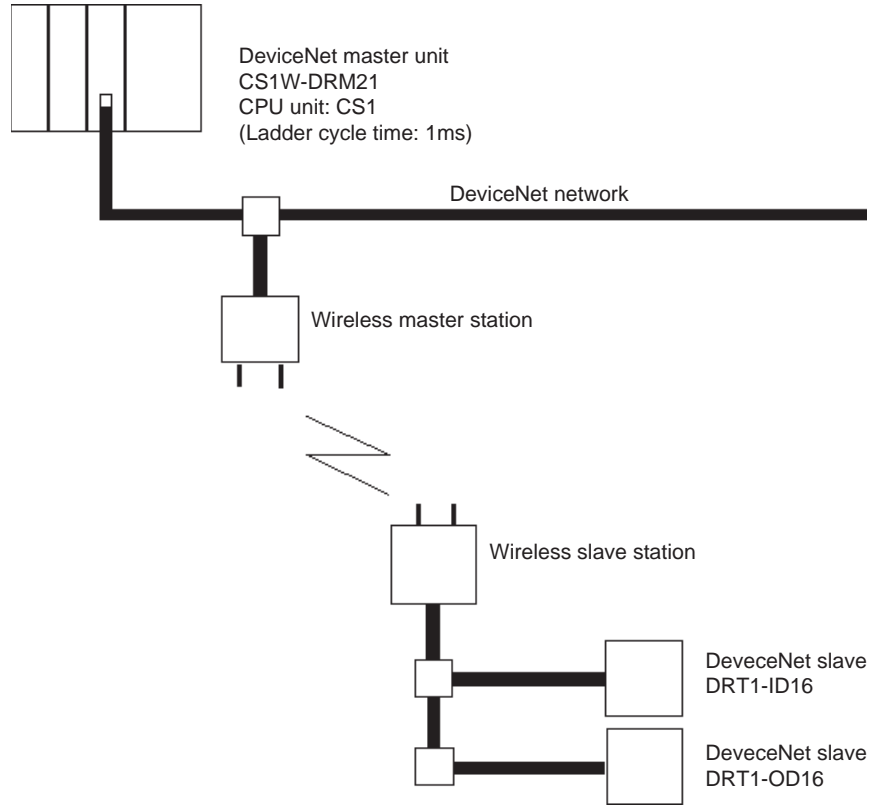

(Ex. 2)

1 wireless master station: 4 slave station: 2 DeviceNet slaves -->  
Min. 72ms, Max. 105ms

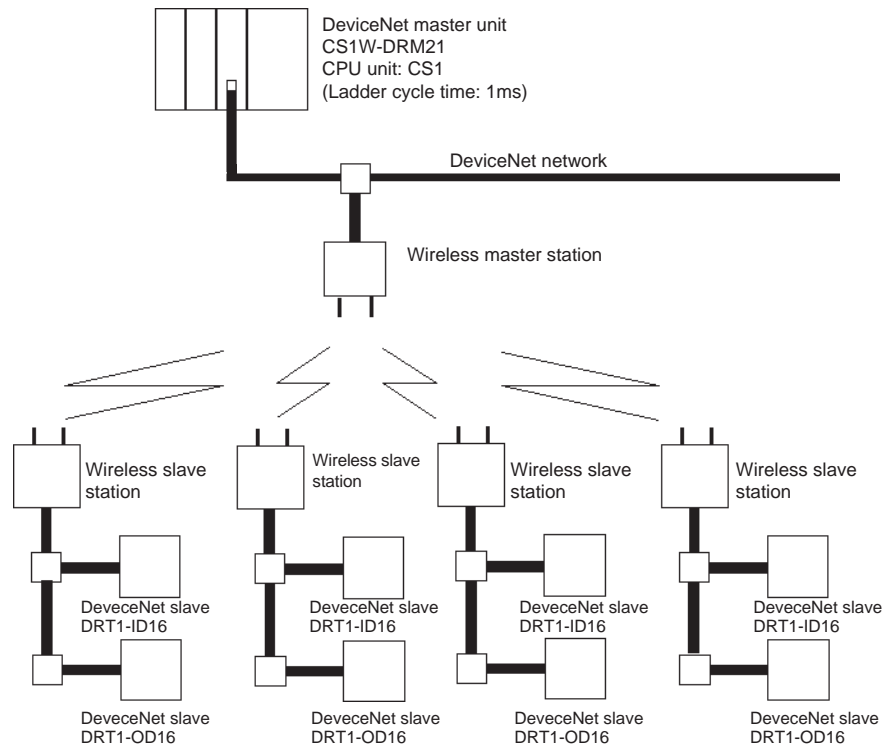

(Ex. 3)

1 wireless master station: 1 relay station: 4 slave stations:

2 DeviceNet slaves --> Min. 155ms, Max. 225ms

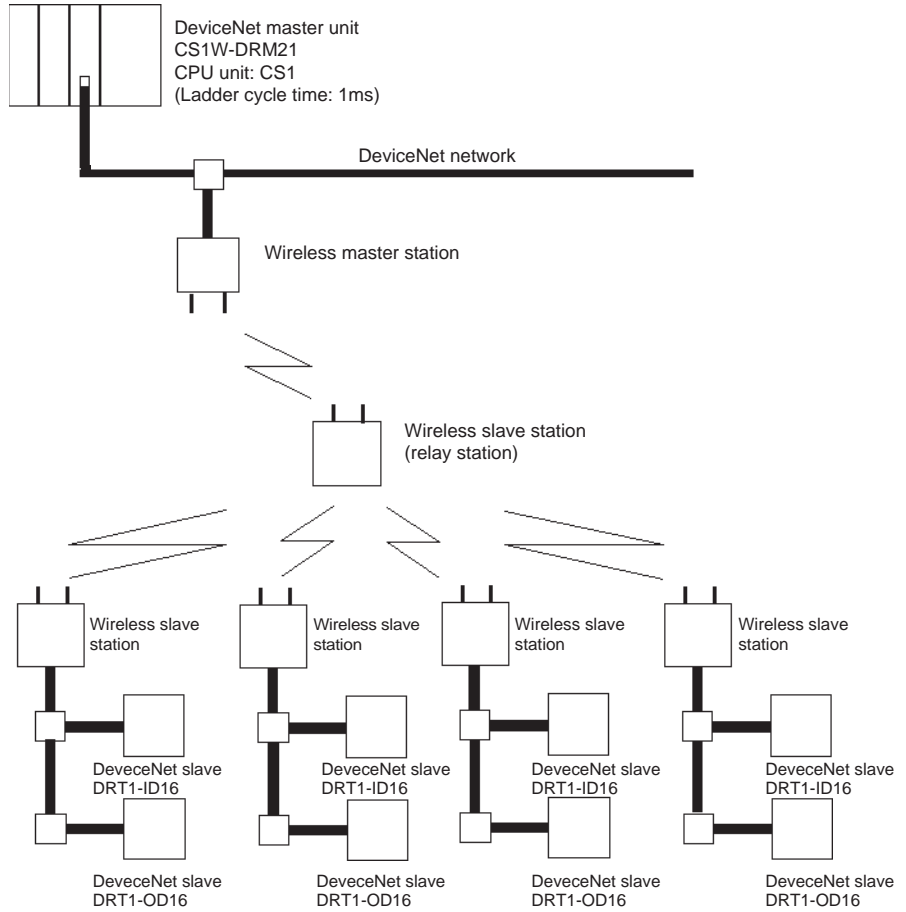

(Ex. 4)

1 wireless master station: 2 relay station: 4 slave stations:

2 DeviceNet slaves -->Min. 250ms, Max. 365ms

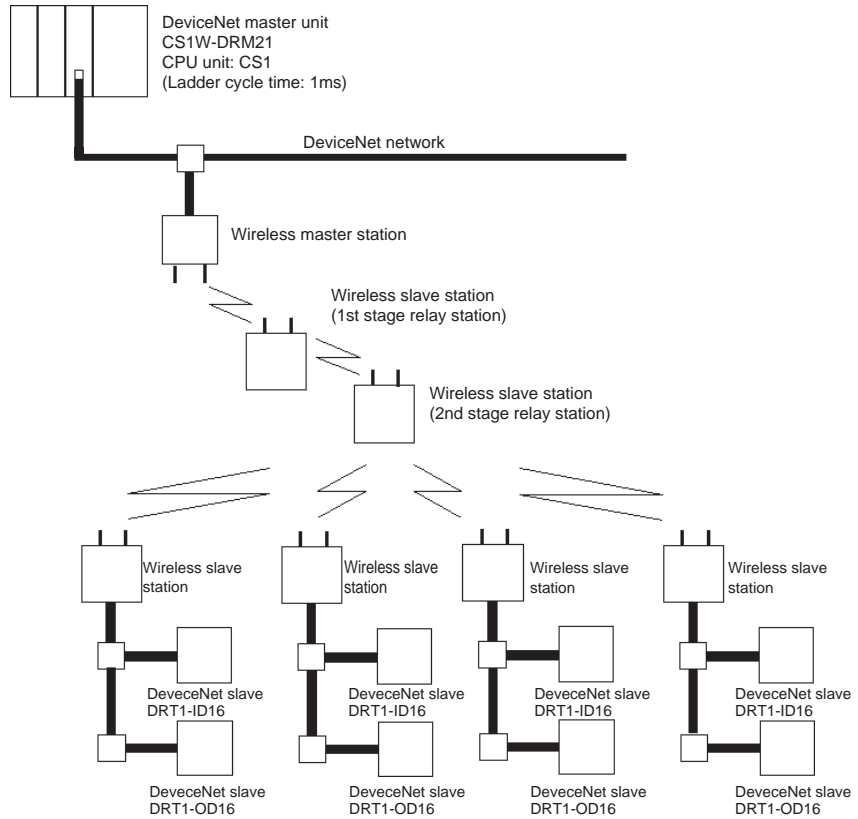



(Ex. 5)

1 wireless master station: 3 relay station: 4 slave stations:

2 DeviceNet slaves -->Min. 365ms, Max. 538ms

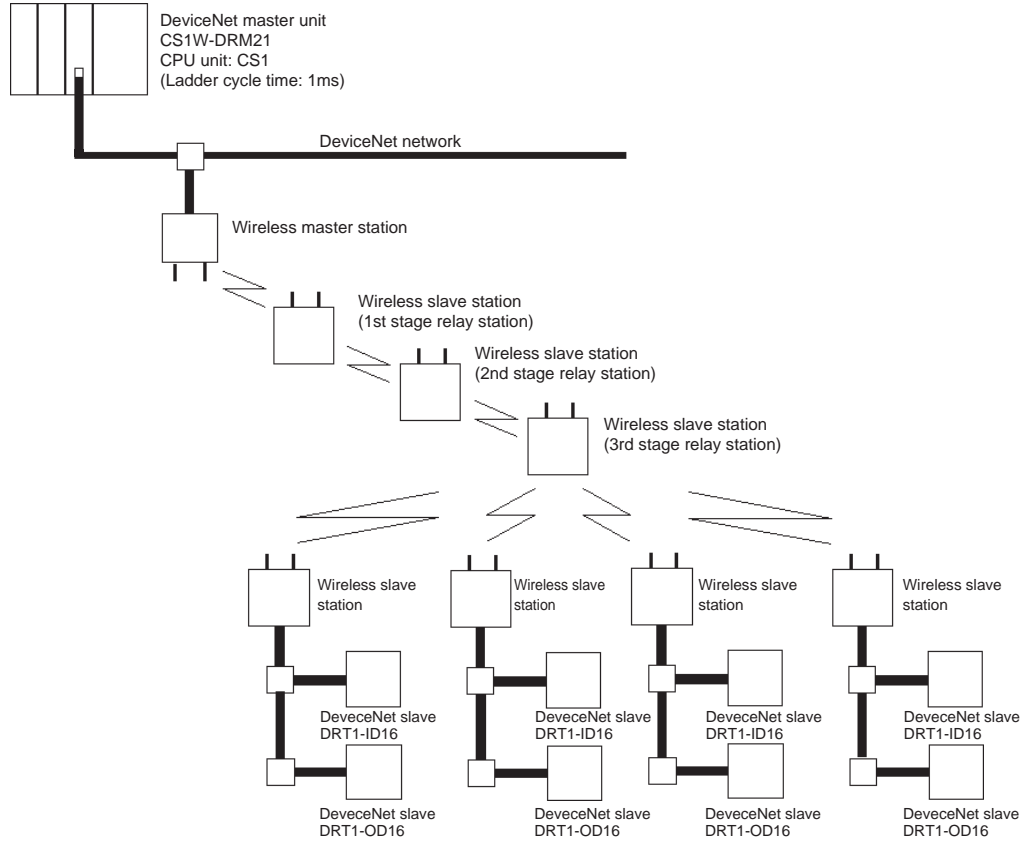

## 9-2 Message Communication Performance

### 9-2-1 Message communication time

When issuing a message on the DeviceNet network from one node to another (data and CMND for SEND/RCV commands, FINS command for IOWR commands), the time from the start of the departure of the message from the DeviceNet master on the network until the end of the departure of the message is called the "message communication time". This is defined as the time required for the message to reach the DeviceNet slave.

If a DeviceNet wireless unit is used, since the wireless master station works temporarily as the DeviceNet slave and the wireless slave unit works temporarily as the DeviceNet master, this will be the total of the following 3 times.

- "Message communication time" from the DeviceNet master to the wireless master station
- "Message communication delay time" from the wireless slave station to the DeviceNet slave
- "Wireless communication extension time" within the wireless network

However, regarding the actual message transmission time, since some latency may occur within the wireless network and 1:N polling is performed, when there are several wireless slave stations or a relay, there are relay stages. Actual data is provided on the following page as a reference. Although this can not be used with applications that require real time control, you should determine whether or not this data can be used as a reference.

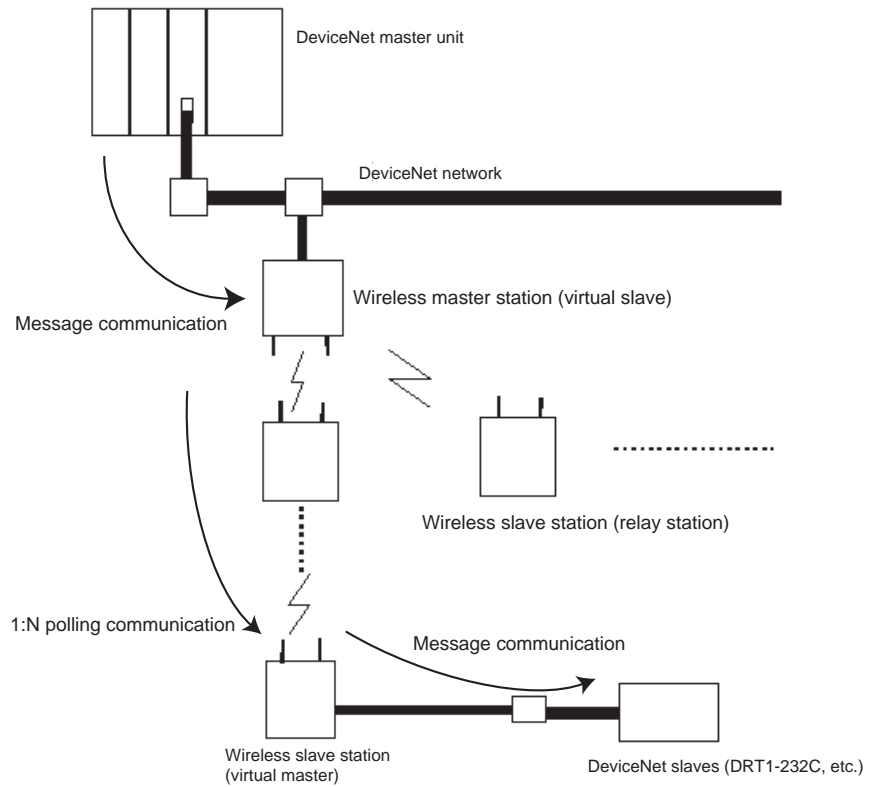

**Note** Refer to the message communication capacity explanations in the DeviceNet Slave Manual and the DeviceNet User's Manual regarding message communication times on the DeviceNet network.

### 9-2-2 Reference data

Actual measurements of message communication times on our system (PLC CPU unit ->DeviceNet master ->>wireless master station -> DeviceNet slave (Model DRT1-232C2 back to back)->>wireless slave station ->>wireless master station ->DeviceNet master ->PLC CPU unit) are shown below for reference.

The specific Explicit message commands issued are:

- RS-232C data transmission
- RS-232C receiving data reading

128 bytes of data are returned by the Model DRT1-232C.

The data shows the minimum and maximum values of the results of 30 continuous tests. Depending on the actual on-site environment, there may be cases that take more time than the maximum value. These values are only for reference.

(Ex. 1)

Wireless master station 1: slave station 1: DRT1-232C2 1 -->  
Min. 600ms, Max. 700ms

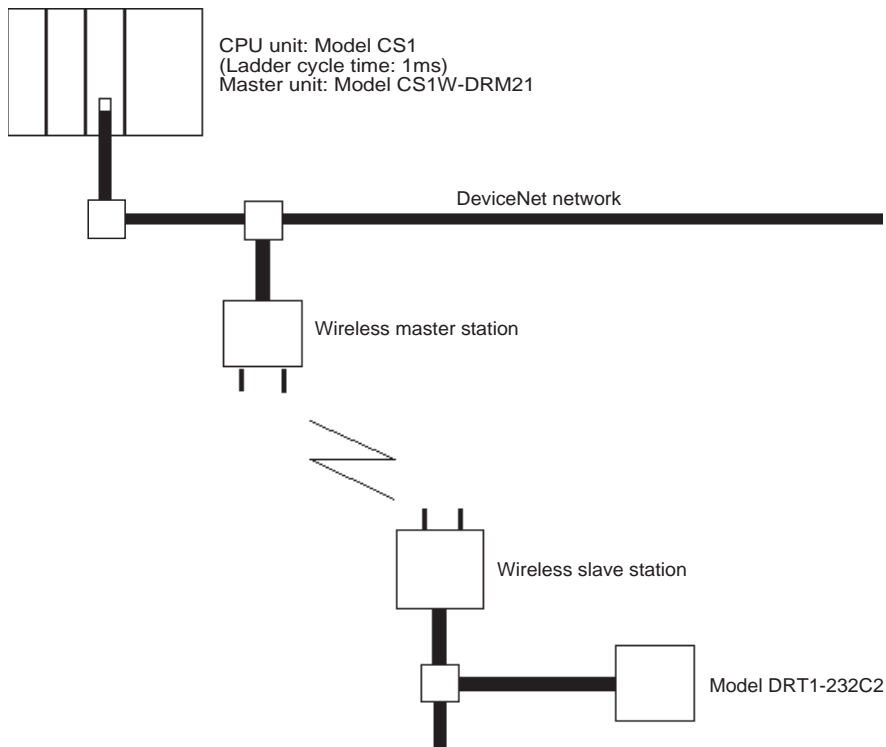

(Ex. 2)

Wireless master station 1: slave station 4: DRT1-232C2 1 -->  
Min. 380ms, Max. 780ms

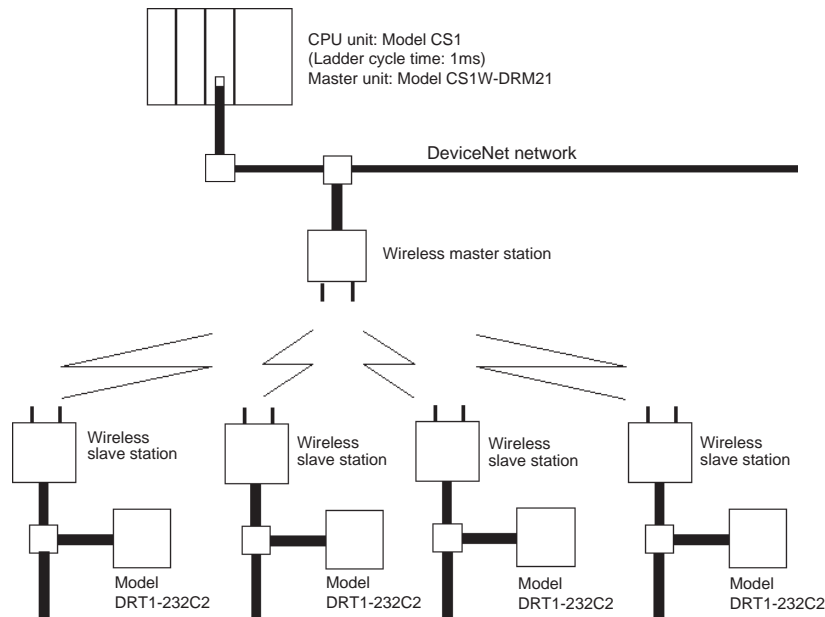

(Ex. 3)

Wireless master station 1: relay station 1: slave station 4:  
DRT1-232C2 1 -->Min. 500ms, Max. 1010ms

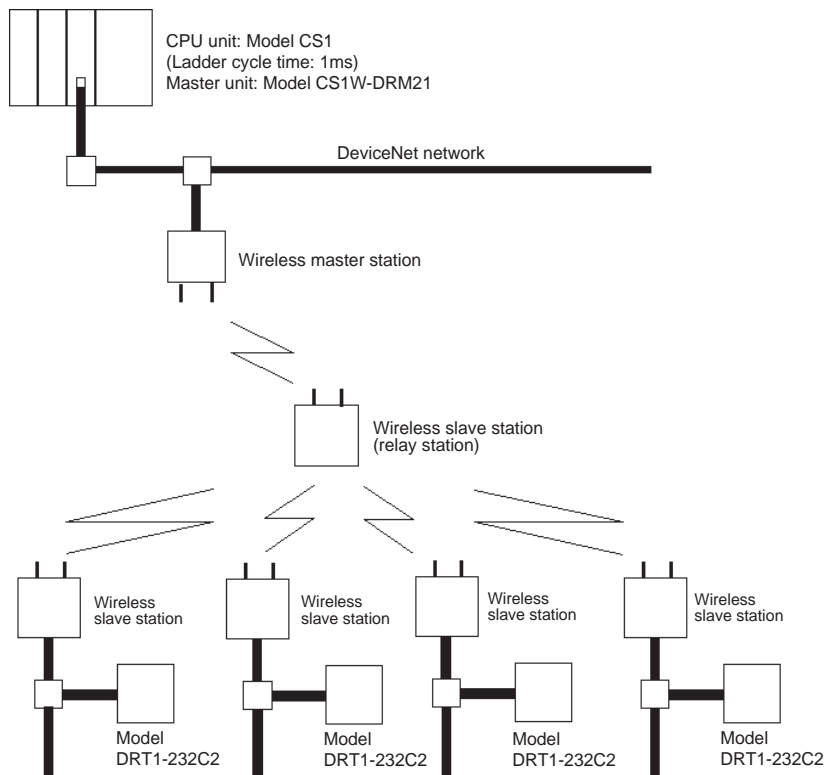

(Ex. 4)

Wireless master station 1: relay station 2: slave station 4:

DRT1-232C2 1 --> Min. 600ms, Max. 1360ms

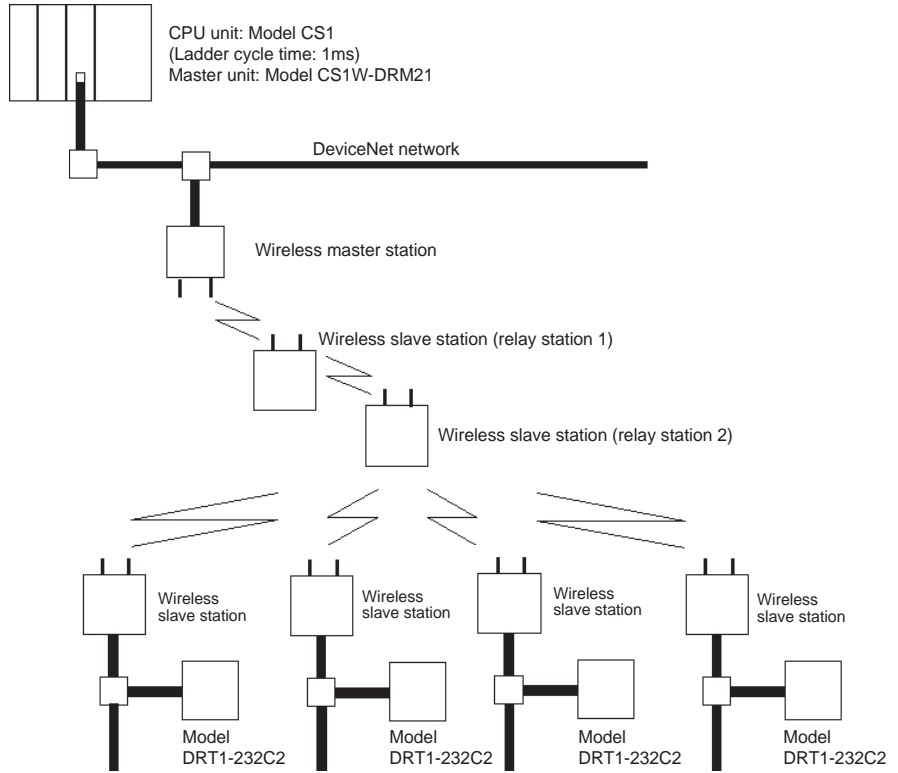

(Ex. 5)

Wireless master station 1: relay station 3: slave station 4

DRT1-232C2 1 -->Min. 750ms, Max. 1690ms

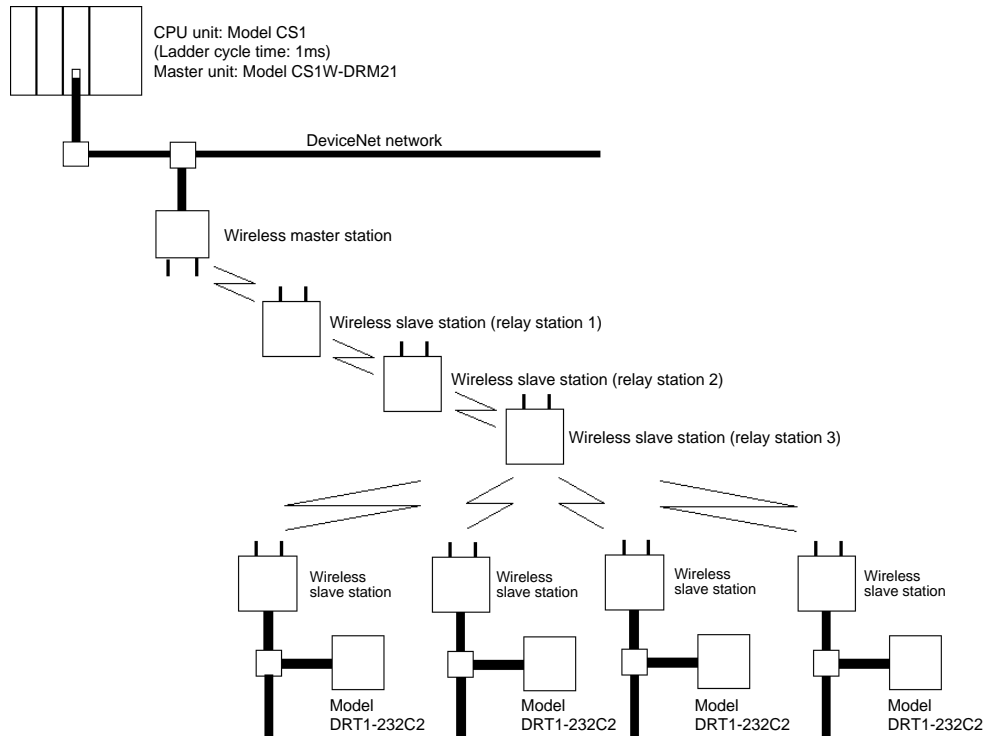

(Ex. 6)

Wireless master station 1: relay station 3: slave station 4:  
DRT1-232C2, DRT1-ID16 --> Min. 840ms, Max. 2300ms

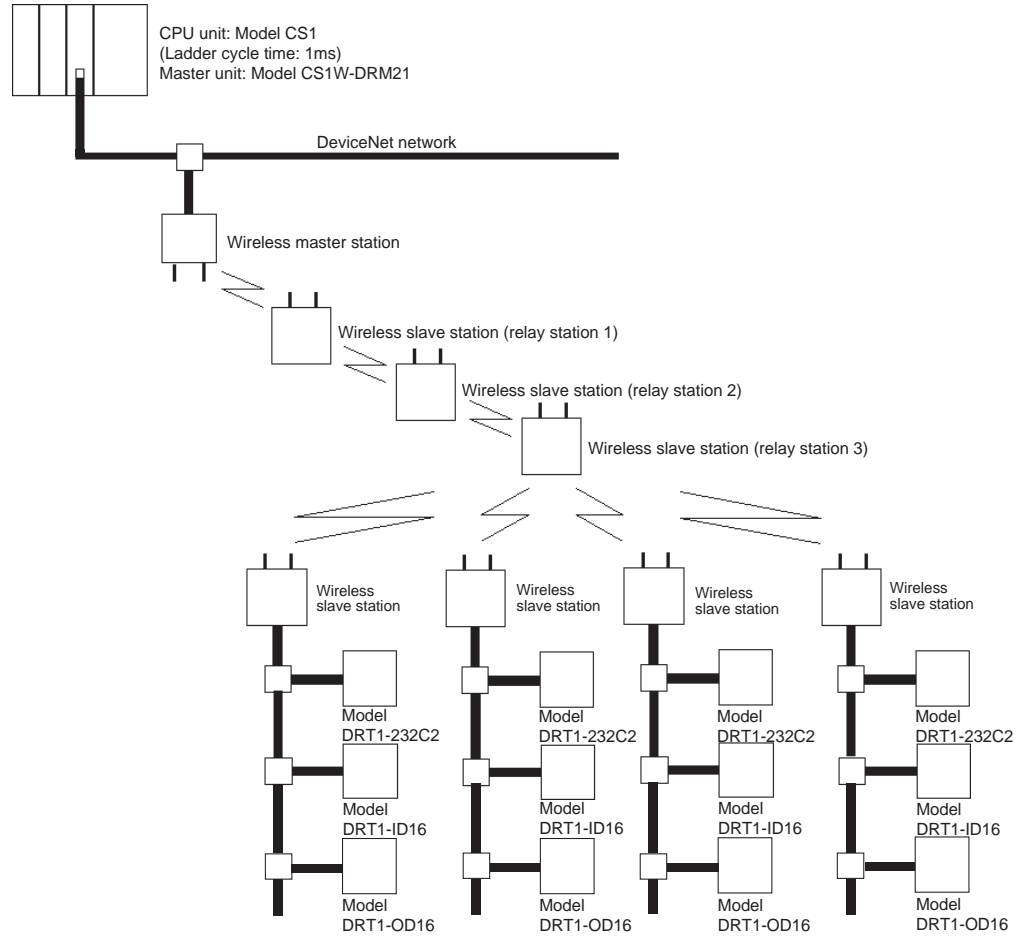





# SECTION 10

## Troubleshooting

This section contains information regarding troubleshooting and inspection methods to be performed by daily inspectors when errors occur.

- 10-1 Normal Indication . . . . . 142
  - 10-1-1 MS/NS/WS LED display . . . . . 142
  - 10-1-2 LED display . . . . . 144
- 10-2 Troubleshooting . . . . . 144
  - 10-2-1 How to locate errors when the system is having trouble . . . . . 144
  - 10-2-2 Check by LED display and remedy . . . . . 147
  - 10-2-3 Check by status area and remedy . . . . . 150
- 10-3 Maintenance . . . . . 152
  - 10-3-1 Cleaning . . . . . 152
  - 10-3-2 Inspection . . . . . 152
  - 10-3-3 Replacing nodes . . . . . 153

## 10-1 Normal Indication

When the DeviceNet wireless unit is operating normally, the status will be as follows.

### 10-1-1 MS/NS/WS LED display















MS (Module Status) LED indicates the conditions of nodes.

NS (Network Status) LED indicates the conditions of the DeviceNet network.















WS (Wireless Status) LED indicates the conditions of the wireless zone.

In normal conditions, all three LEDs turn on green in both master and slave stations.

#### Wireless master station LEDs

LED	Color	Status		Meaning (primary error)
MS (Module Status)	Green	 On	Normal conditions	Communication is normal.
		 Flashing	Test/Setting mode	Test mode or Setting mode has been activated.
	Red	 On	Critical fault	A critical error has occurred that can not be recovered. The unit must be replaced.
		 Flashing	Minor fault	An error has occurred that can be recovered by resetting the system.
	-	 Off	No power supply	Power is not being supplied, or the system is resetting.
NS (Network Status)	Green	 On	Online/communication connection complete	If online, the remote I/O communication with the slave registered on the scan list has been established. Or, the message communication has been established.
		 Flashing	Online/communication connection not complete	Although the system is online, remote I/O communications and message communications are not established.
	Red	 On	Critical communication error	Communication is not possible.
		 Flashing	Minor communication error	Communication timeout
	-	 Off	Offline/power supply turned off	The system is not online.
WS (Wireless Status)	Green	 On	Wireless communication connection complete	Communications have been established between the wireless systems.
		 Flashing	Wireless communication connection not complete	During startup, wireless master station is adding an slave station or there is no remote I/O slave.
	Red	 On	Critical wireless communication error	A critical error has occurred that can not be recovered.
		 Flashing	Minor wireless communication error	An error has occurred that can be recovered.
	-	 Off	Radio wave not sent	No radio wave has been sent.

Wireless slave station LEDs

LED	Color	Status		Meaning (primary error)
MS (Module Status)	Green	 On	Normal conditions	Communication is normal.
		 Flashing	Test/Setting mode	Test mode or Setting mode has been activated.
	Red	 On	Critical fault	A critical error has occurred that can not be recovered. The unit must be replaced.
		 Flashing	Minor fault	An error has occurred that can be recovered by resetting the system.
	-	 Off	No power supply	Power is not being supplied, or the system is resetting.
NS (Network Status)	Green	 On	Online/communication connection complete	If online, the remote I/O communication slave registered on the scan list has been established. Or, the message communication has been established.
		 Flashing	Online/communication connection not complete	Although the system is online, remote I/O with the slave registered on the scan list has been established. Or, the message communication has been established.
	Red	 On	Critical communication error	Communication is not possible.
		 Flashing	Minor communication error	Communication timeout
	-	 Off	Offline/power supply turned off	The system is not online.
WS (Wireless Status)	Green	 On	Adding in the wireless network	Communications have been established between the wireless systems
		 Flashing	Waiting for permission to be added to wireless network	The slave wireless station is waiting for permission to be added to wireless network.
	Red	 On	Critical wireless communication error	A critical error has occurred that can not be recovered.
		 Flashing	Minor wireless communication error	An error has occurred that can be recovered.
	-	 Off	Radio wave not sent	No radio wave has been sent.

### 10-1-2 LED display

Under normal conditions, the dot LEDs of the wireless master station come on depending on the registration status of the wireless slave station serial numbers, and the wireless slave station displays the node numbers (NNODE). In the wireless slave station, the right and left dot LEDs come on in the scan list invalid mode and go off in the scan list valid mode.

Under error conditions, "error code +error occurrence node" are displayed sequentially, according to the error codes in the order of detection. The error codes are conform to DeviceNet error codes. In addition, the receiving wave level is displayed during the test.

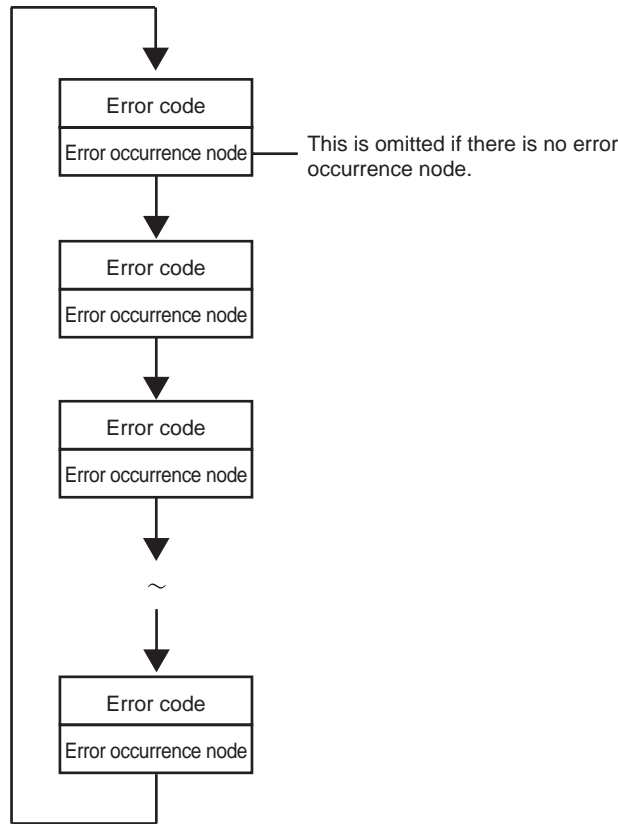

## 10-2 Troubleshooting

This section explains the causes of errors, how to determine their locations, and the actions to be taken when errors occur in a DeviceNet wireless unit.

### 10-2-1 How to locate errors when the system is having trouble

Trouble assumable in the system using the DeviceNet wireless can be roughly classified into the following two cases.

- 1,2,3...
1. Hardware error in each unit
  2. Communication error in each network (the upper DeviceNet network between the DeviceNet master unit and wireless master station, the wireless network between the wireless master station and a wireless slave station, the lower DeviceNet network between a wireless slave station and the DeviceNet slave connected with a wireless slave station)

Hardware errors in each unit can be determined either by the LEDs of the unit or by the fact that a unit is not added to the upper unit (this could be a wireless

slave station if it is a DeviceNet slave connected with the end of a wireless slave station, the wireless master station if it is a wireless slave station, or a DeviceNet master if it is the wireless master station) to which the unit should have been added.

(Ex. 1) A hardware error occurs in a DeviceNet slave:

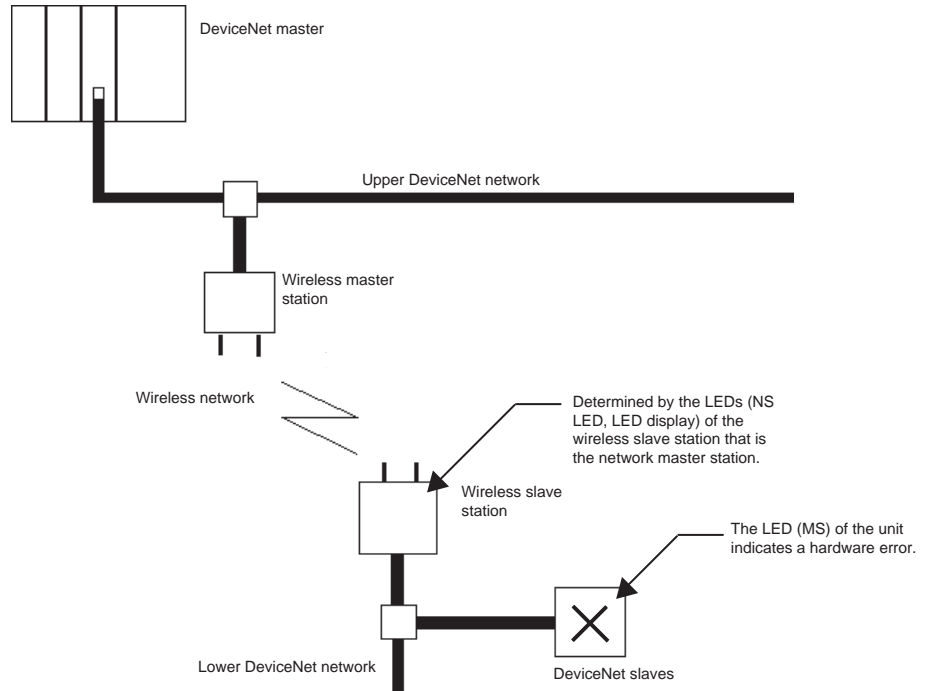

(Ex. 2) A hardware error is present in a wireless slave station:

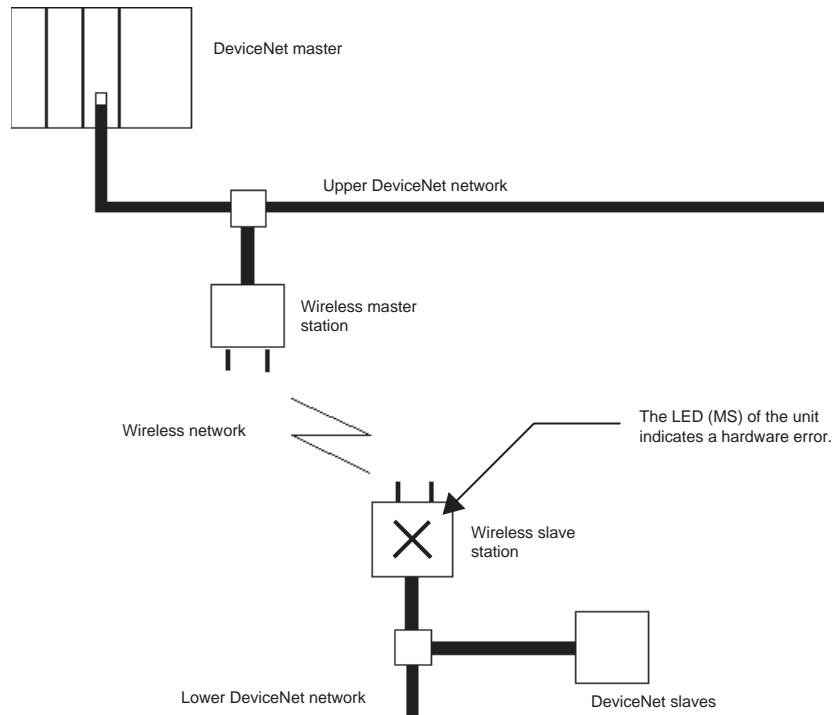

Hardware errors in each unit can be determined either by the LEDs or the status of the master station of each network (this could be a wireless slave station if it is the lower DeviceNet network, the wireless master station if it is the wireless network, or the DeviceNet master if it is the upper DeviceNet net-

work). When an error unit is found in each network, the cause can be pin down by implementing the communication test on each network after the settings of the unit in concern have been checked.

(Ex. 3) A hardware error is present in the lower DeviceNet network:

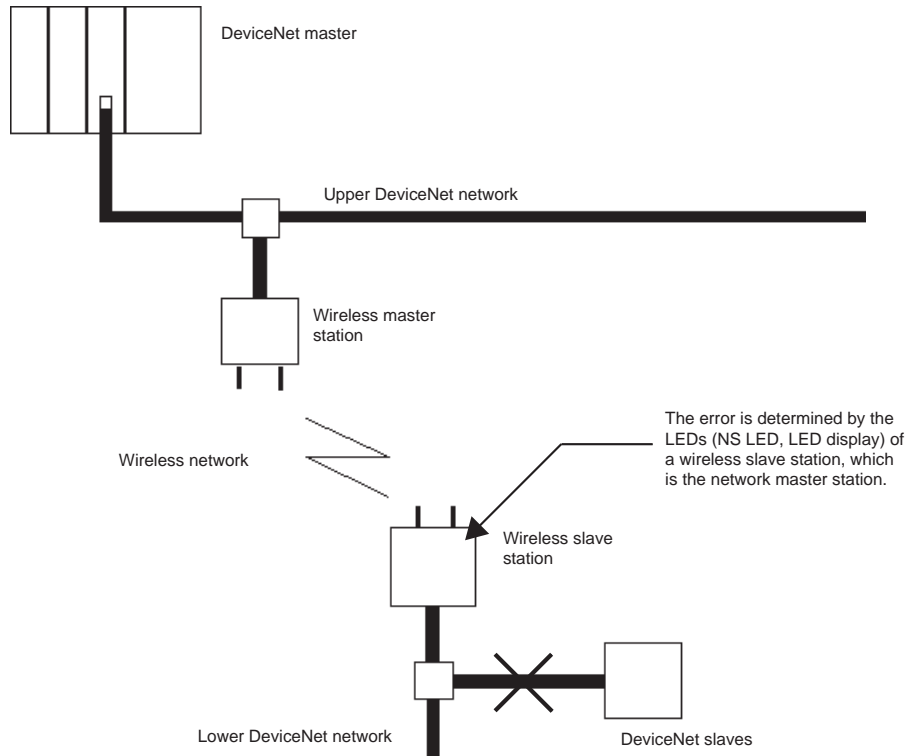

(Ex. 4) A communication error is present in the wireless network:

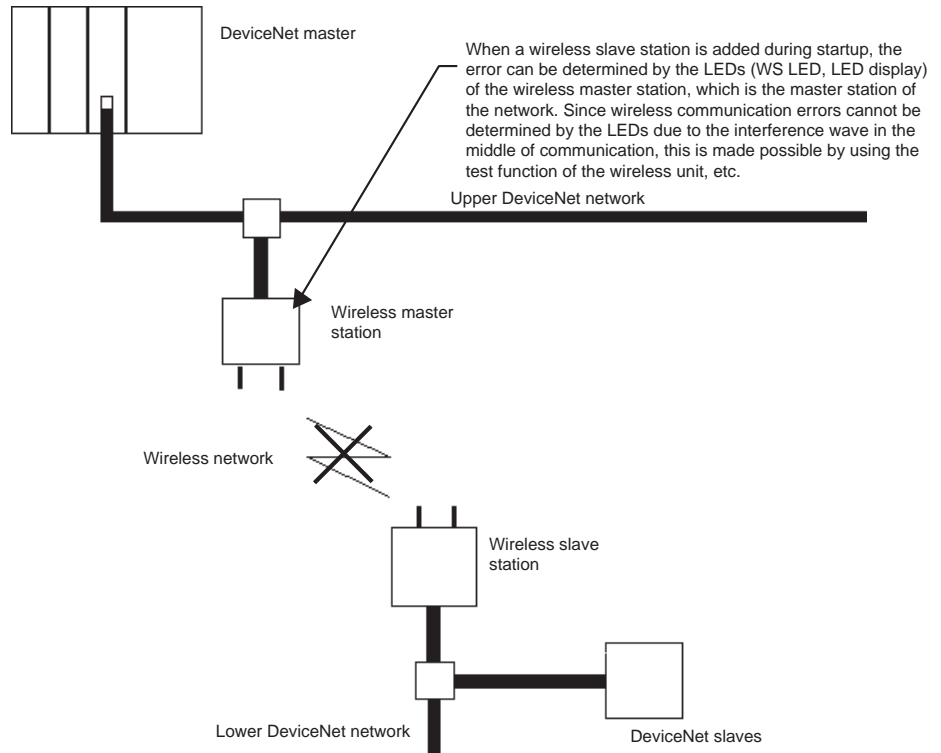



### 10-2-2 Check by LED display and remedy



The wireless unit has LEDs indicating its status.

Inspecting the LEDs allows you to pinpoint the content and cause of the error.

#### Causes of wireless master station errors and remedies by MS LED



MS LED status	LED display	Condition	Cause	Remedy
MS OFF 	OFF	Power OFF	The power is not being supplied.	Check if the power is properly supplied from the communication power supply.
MS ON (red) 	F8 F9 FA F7 OFF	Unrecoverable error	Hardware error during startup (EEPROM error, etc.)	Reset the power supply or initialize the unit. If the error persists, contact our sales department for assistance.
MS Flashing (red) 	F3	Recoverable error	Incorrect switch setting	Check the switch setting and reset correctly.
	F8		EEPROM SUM error	Initialize the unit. If the error persists, the unit needs to be replaced. Contact our sales department for assistance.

#### Causes of wireless master station errors and remedies by NS LED

NS LED status	LED display	Condition	Cause	Remedy
NS ON (red) 	OFF E2	DeviceNet Busoff detection error	Communication interruption due to multiple data errors DeviceNet node address duplicates.	After reviewing the following items, restart the unit. <ul style="list-style-type: none"> <li>• Communication speed</li> <li>• Cable length (main/branch)</li> <li>• Broken or loose cable</li> <li>• Terminating resistor should only be installed on both ends of the main line.</li> <li>• Excessive noise</li> <li>• Node address duplication</li> </ul>
NS Flashing (red) 	OFF E2	Recoverable error	Communication time out	After reviewing the following items, restart the unit. <ul style="list-style-type: none"> <li>• Communication speed</li> <li>• Cable length (main/branch)</li> <li>• Broken or loose cable</li> <li>• Terminating resistor should only be installed on both ends of the main line.</li> <li>• Excessive noise</li> </ul>

**Causes of wireless master station errors and remedies by WS LED**



(LEDs with a "\*" mark display error occurrence node addresses alternately.)

WS LED status	LED display	Condition	Cause	Remedy
 ON (red)	E9	Unrecoverable error	Carrier sense error An electric wave of the other WD30-ME is output to the same wireless channel.	Reset the power supply or change the WCH to the other wireless channel, and then restart the system.
 Flashing (red)	D1	Recoverable error (wireless zone configuration error)	Total I/O size over	Check the switch setting and reset correctly.
	D6*		Routing pass	
	E5*		No registered slave	
	E8		Discrepancy I/O size	Check the switch setting and reset correctly. If normal operation is not restored, it is possible that intermodulation is the cause of the error. With reference to <i>Points for Consideration with Wireless Systems</i> on page 16, reset the frequency to a level for which intermodulation does not occur.

**Note** Refer to 10-1 Normal Indication for details on the conditions when the WS LED is green and flashing.



**Causes of wireless slave station errors and remedies by MS LED**

(LEDs with a "\*" mark display error occurrence node addresses alternately.)

MS LED status	LED display	Condition	Cause	Remedy
 OFF	OFF	Power OFF	The power is not being supplied.	Check if the power is properly supplied from the communication power supply.
 ON (red)	F8 F9 FA F7 OFF	Unrecoverable error	Hardware error during startup (EEPROM error, etc.)	Reset the power supply once or initialize the unit. If the error persists, contact our sales department for assistance.
 Flashing (red)	F3*	Recoverable error	Incorrect switch setting	Check the switch setting and reset correctly.
	E8		EEPROM SUM error	Initialize the unit. If the error persists, the unit needs to be replaced. Contact our sales department for assistance.







**Causes of wireless slave station errors and remedies by NS LED  
(LEDs with a "\*" mark display error occurrence node addresses alternately.)**

NS LED status	LED display	Condition	Cause	Remedy
 ON (red)	F0*	Unrecoverable error (DeviceNet node address duplication.)	DeviceNet node address duplication.	Check the settings and reset correctly.
	F1*	Unrecoverable error (Busoff status)	Communication stop due to multiple data errors	After reviewing the following items, restart the unit. <ul style="list-style-type: none"> <li>• Communication speed</li> <li>• Cable length (main/branch)</li> <li>• Broken or loose cable</li> <li>• Terminating resistor should only be installed on both ends of the main line.</li> <li>• Excessive noise</li> </ul>
 Flashing (red)	D0*	Unrecoverable error (communication time-out)	I/O area duplication	Reset node address of the slave.
	D1*		I/O area zone over	
	D2*		Unsupported slave	
	D5*	No slave	After reviewing the following items, restart the unit. <ul style="list-style-type: none"> <li>• Power supply to the slave</li> <li>• Communication speed</li> <li>• Cable length (main/branch)</li> <li>• Broken or loose cable</li> <li>• Terminating resistor should only be installed on both ends of the main line.</li> <li>• Excessive noise</li> <li>• Contents of registered DeviceNet slave</li> </ul>	
	D6*	Discrepancy slave I/O size	After checking the slave, initialize the unit and register the slave again.	
D9*	Remote I/O communication timeout	After reviewing the following items, restart the unit. <ul style="list-style-type: none"> <li>• Power supply to the slave</li> <li>• Communication speed</li> <li>• Cable length (main/branch)</li> <li>• Broken or loose cable</li> <li>• Terminating resistor should only be installed on both ends of the main line.</li> <li>• Excessive noise</li> </ul>		

**Causes of wireless slave station errors and remedies by WS LED**

(LEDs with a "\*" mark display error occurrence node addresses alternately.)

WS LED status	LED display	Condition	Cause	Remedy
 WS ON (red)	NNODE E2	Unrecoverable error	Node address duplication in wireless zone	Check the switch setting and reset correctly. If normal operation is not restored, it is possible that intermodulation is the cause of the error. With reference to <i>Points for Consideration with Wireless Systems</i> on page 16, reset the frequency to a level for which intermodulation does not occur.
			Verify error, routing error	Check the settings and reset correctly.
 WS Flashing (red)	E2	Recoverable error	Wireless zone timeout	Set the unit so the wireless communication is stabilized by changing the frequency (WCH) or implementing the setup test.
 WS ON (red)	OFF	Unrecoverable error	Relay station Node address duplication in wireless zone, verify error, routing error	Check the settings and reset correctly.
 WS Flashing (red)	OFF	Unrecoverable error	Relay station Wireless zone timeout	Set the unit so the wireless communication is stabilized by changing the frequency (WCH) or implementing the setup test.

**Note** Refer to 10-1 Normal Indication for details on the conditions when the WS LED is green and flashing.

**10-2-3 Check by status area and remedy**

When "Status" is selected in the DIP switch settings of the wireless master station, the status area that displays the wireless slave station status is available in the first two or four words of the input area in the Master. The contents and causes of errors can be found by checking this area.

To be concrete, an error flag is allocated for each wireless station in the status area, as shown in the following diagram.

- When maximum number of I/O = 32 words/32 words:

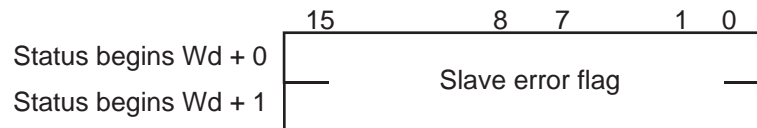

15	14	13	12	11	10	9	8	7	6	5	4	3	2	1	0
16	15	14	13	12	11	10	9	8	7	6	5	4	3	2	1
32	31	30	29	28	27	26	25	24	23	22	21	20	19	18	17

- When maximum number of I/O = 100 words/100 words:



15	14	13	12	11	10	9	8	7	6	5	4	3	2	1	0
16	15	14	13	12	11	10	9	8	7	6	5	4	3	2	1
32	31	30	29	28	27	26	25	24	23	22	21	20	19	18	17
48	47	46	45	44	43	42	41	40	39	38	37	36	35	34	33
64	63	62	61	60	59	58	57	56	55	54	53	52	51	50	49

Each of the following for the DeviceNet master status of added wireless slave stations is set to an OR value.

- Incorrect switch setting/EEPROM error (bit address 00)
- Repetitive node address/Busoff detection (bit address 01)
- Configuration error (bit address 03)
- Structural error (bit address 04)
- Sending error (bit address 05)
- Communication error (bit address 06)
- Verify error (bit address 07)

Also, if a wireless slave station has been registered by not added, the bit will be 1. For example, if a wireless slave station error occurs for WNODE = 16, the highest bit for "status begin word +0" (16) becomes 1.

If you issue a command (Explicit message) to the wireless slave station to which an error flag is set, the detailed contents of the error can be obtained.

(See SECTION 3 Sample Program.)

After the details are obtained, take action according to the following table.

Error content	Bit address	Cause	Remedy
Incorrect switch setting/EEPROM error	00	Incorrect DIP switch setting or EEPROM hardware error	Check the switch settings. Reset the power supply. If the error persists, the unit needs to be replaced. Contact our sales window for assistance.
Node address duplication/Busoff detection	01	A node address (NNODE) duplication or the unit is in Busoff status (Communication stop due to multiple data errors).	Check the node address of other nodes. Review the following items. <ul style="list-style-type: none"> <li>• Communication speed</li> <li>• Cable length (main/branch)</li> <li>• Broken or loose cable</li> <li>• Terminating resistor should only be installed on both ends of the main line.</li> <li>• Excessive noise</li> </ul>
Configuration error	03	Configuration data error	Initialize the unit and register the slave again.
Structural error	04	I/O area duplication, I/O area zone over, and unsupported slave	Check the node address of the slave and reset correctly.

Error content	Bit address	Cause	Remedy
Send error	05	Network power supply error, send timeout	Check the network power supply and the network cable wiring. Review the following items. <ul style="list-style-type: none"> <li>• Communication speed</li> <li>• Cable length (main/branch)</li> <li>• Broken or loose cable</li> <li>• Terminating resistor should only be installed on both ends of the main line.</li> <li>• Excessive noise</li> </ul>
Communication error	06	Remote I/O communication timeout	Review the following items <ul style="list-style-type: none"> <li>• Communication speed</li> <li>• Cable length (main/branch)</li> <li>• Broken or loose cable</li> <li>• Terminating resistor should only be installed on both ends of the main line.</li> <li>• Excessive noise</li> </ul>
Verify error	07	Discrepancy slave I/O size, no slave	After checking the slave, initialize the unit and re-entry the slave again. <ul style="list-style-type: none"> <li>• Communication speed</li> <li>• Cable length (main/branch)</li> <li>• Broken or loose cable</li> <li>• Terminating resistor should only be installed on both ends of the main line.</li> <li>• Excessive noise</li> </ul>

## 10-3 Maintenance

This section describes the routine cleaning and inspection and the equipment handling procedure for replacement.

### 10-3-1 Cleaning

Clean the network regularly as described below in order to keep it in its optimal operating condition.

- Wipe the Unit with a dry, soft cloth for regular cleaning.
- When a spot cannot be removed with a dry cloth, dampen the cloth with a neutral cleaner (diluted to 2%), wring out the cloth, and wipe the Unit.
- A smudge may remain on the Unit from gum, vinyl, or tape that was left on for a long time. Remove the smudge when cleaning.

 **Caution** Never use volatile solvents such as paint thinner or benzene or chemical wipes. These substances could damage the surface of the Unit.

### 10-3-2 Inspection

Be sure to inspect the system periodically to keep it in its optimal operating condition. In general, inspect the system once every 6 to 12 months, but inspect more frequently if the system is used at high temperatures or humidity or under dirty/dusty conditions.

#### Inspection equipment

Prepare the following equipment before inspecting the system.

#### **Required equipment**

- Standard and Phillips screwdrivers
- Multimeter (or digital volt meter)

- Equipment that could be needed**
- Alcohol and all-cotton cloth
  - Synchroscope
  - Oscilloscope (pen-writing type)
  - Thermometer, hygrometer

**Inspection item**

Check the items in the following table to make sure they meet the standard. If they do not, improve the surrounding environment so they meet the standard or adjust this unit.

Item	Inspection contents	Standard	Inspection method
Environmental conditions	Ambient and in-panel temperature	See below.	Thermometer
	Ambient and in-panel humidity	See below.	Thermometer
	Dust/dirt accumulation	None	Visual
Installation	Are the units installed securely?	No looseness	
	Are the communications cables securely connected?	No looseness	
	In the antenna tight?	No looseness	

The following table shows the operating ambient temperature and humidity ranges for each unit

Unit	Acceptable	Acceptable humidity
DeviceNet wireless master station	-10 to 50 °C	25%to 85% (with no condensation or icing)
DeviceNet wireless slave station	-10 to 50 °C	25%to 85% (with no condensation or icing)

**10-3-3 Replacing nodes**

Each node (master, slave, wireless master station, wireless slave station) makes up the network. The entire network is affected when a node is faulty, so a faulty node must be repaired or replaced quickly. We recommend having spare parts available to restore network operation as quickly as possible.

**Precautions**

- Observe the following precautions when replacing a faulty unit.
- After replacement make sure there are no errors with the new unit.
  - When a unit is being returned for repair, attach a sheet of paper detailing the problem and return the unit to your OMRON dealer listed at the end of this manual.
  - If there is a faulty contact, try wiping the contact with a clean, lint-free cloth dampened with alcohol.

 **Caution** To prevent electric shock when replacing a unit, be sure to turn OFF the power supplies to all of the nodes (master and slaves) before removing the faulty unit.



# Appendix A

## Device Profiles

Refer to the specifications and device profile in this manual when connecting an OMRON DeviceNet wireless master station to another company's master.

### Device profile of DeviceNet wireless unit master station (WD30-ME/-ME01)

General data	Applicable DeviceNet Specifications	Volume I-Release 2.0 Volume II-Release 2.0	
	Vender name	OMRON Corporation	Vender ID = 47
	Device profile	Slaves : Communication Adapter	Device profile = 12
	Product catalog number	Manual number	
	Product revision	1.0	
Physical conformance data	Network current consumption		
	Connector type	Open plug	
	Physical insulation	Yes	
	Supported indicator	Module Network Wireless	
	MAC ID setting	Rotary switch	
	Default MAC ID	0	
	Transmission communication speed setting	DIP switch	
	Supported transmission communication speeds	125 kbps 250 kbps 500 kbps	
Communications data	Predefined Master/Slave connection set	Group 2 only server	
	Dynamic connection support (UCMM)	No	
	Explicit message fragmentation support	Yes	

## Object Loading

### Identity Object (0 x 01)

Object class	Attribute	Not supported
	Service	Not supported

Object instance	Attribute	ID content	Get	Set	Value
		1 Vendor	<input type="radio"/>	<input checked="" type="checkbox"/>	47
2 Product type	<input type="radio"/>	<input checked="" type="checkbox"/>	12		
3 Product code	<input type="radio"/>	<input checked="" type="checkbox"/>	505		
4 Revision	<input type="radio"/>	<input checked="" type="checkbox"/>	3.02		
5 Status (bits supported)	<input type="radio"/>	<input checked="" type="checkbox"/>	Unique for each unit		
6 Serial number	<input type="radio"/>	<input checked="" type="checkbox"/>	Bit 0 only		
7 Product name	<input type="radio"/>	<input checked="" type="checkbox"/>	WD30-ME-V1		
8 State	<input checked="" type="checkbox"/>	<input checked="" type="checkbox"/>			
Service	DeviceNet service	Parameter option			
	05 Reset	No			
	OE Get_Attribute_Single	No			

### Message Router Object (0 x 02)

Object class	Attribute	Not supported
	Service	Not supported
Object instance	Attribute	Not supported
	Service	Not supported
Vender fix specification addition		No

### DeviceNet Object (0 x 03)

Object class	Attribute	Not supported
	Service	Not supported

Object instance	Attribute	ID content	Get	Set	Value
		1 MAC ID	<input type="radio"/>	<input checked="" type="checkbox"/>	
2 Communication speed	<input type="radio"/>	<input checked="" type="checkbox"/>			
3 BOI	<input type="radio"/>	<input checked="" type="checkbox"/>	00H		
4 Bus-off counter	<input type="radio"/>	<input checked="" type="checkbox"/>			
5 Allocation Information	<input type="radio"/>	<input checked="" type="checkbox"/>			
6 MAC ID switch changed	<input checked="" type="checkbox"/>	<input checked="" type="checkbox"/>			
7 Communication speed switch changed	<input checked="" type="checkbox"/>	<input checked="" type="checkbox"/>			
8 MAC ID switch value	<input checked="" type="checkbox"/>	<input checked="" type="checkbox"/>			
9 Communication speed switch	<input checked="" type="checkbox"/>	<input checked="" type="checkbox"/>			
Service	DeviceNet service	Parameter option			
	0E Get_Attribute_Single	No			
	4B Allocate Master/Slave_Connection_Set	No			
	Release_Master/Slave_Connection_Set	No			



**Connection Object (0 x 05)**

Object class	Attribute	Not supported
	Service	Not supported
	Max. number of active connections	1

Object instance 1	Section	Information	Max. number of instances		
	Instance type	Explicit Message	1		
	Production trigger	Cyclic			
	Transport type	Server			
	Transport class	3			
	Attribute	ID content	Get	Set	Value
		1 State	<input type="radio"/>	<input checked="" type="radio"/>	
		2 Instance type	<input type="radio"/>	<input checked="" type="radio"/>	0000H
		3 Transport class trigger	<input type="radio"/>	<input checked="" type="radio"/>	8300H
		4 Produced connection ID	<input type="radio"/>	<input checked="" type="radio"/>	
		5 Consumed connection ID	<input type="radio"/>	<input checked="" type="radio"/>	
		6 Initial comm. characteristics	<input type="radio"/>	<input checked="" type="radio"/>	2100H
		7 Produced connection size	<input type="radio"/>	<input checked="" type="radio"/>	FF00H
		8 Consumed connection size	<input type="radio"/>	<input checked="" type="radio"/>	FF00H
		9 Expected packet rate	<input type="radio"/>	<input type="radio"/>	
		12 Watchdog time-out action	<input type="radio"/>	<input checked="" type="radio"/>	0100H
		13 Produced connection path length	<input type="radio"/>	<input checked="" type="radio"/>	0000H
		14 Produced connection path	<input type="radio"/>	<input checked="" type="radio"/>	
		15 Consumed connection path length	<input type="radio"/>	<input checked="" type="radio"/>	0000H
		16 Consumed connection path	<input type="radio"/>	<input type="radio"/>	
	Service	DeviceNet service	Parameter option		
	05 Reset	No			
	0E Get_Attribute_Single	No			
	10 Set_Attribute_Single	No			

Object instance 2	Section	Information	Max. number of instances		
	Instance type	Polled I/O		1	
Production trigger	Cyclic				
Transport type	Server				
Transport class	2				
Attribute	ID content		Get	Set	Value
	1 State		<input type="radio"/>	<input checked="" type="checkbox"/>	
	2 Instance type		<input type="radio"/>	<input checked="" type="checkbox"/>	0100H
	3 Transport class trigger		<input type="radio"/>	<input checked="" type="checkbox"/>	8200H
	4 Produced connection ID		<input type="radio"/>	<input checked="" type="checkbox"/>	
	5 Consumed connection ID		<input type="radio"/>	<input checked="" type="checkbox"/>	
	6 Initial comm. characteristics		<input type="radio"/>	<input checked="" type="checkbox"/>	0100H
	7 Produced connection size		<input type="radio"/>	<input checked="" type="checkbox"/>	*1
	8 Consumed connection size		<input type="radio"/>	<input checked="" type="checkbox"/>	*1
	9 Expected packet rate		<input type="radio"/>	<input type="radio"/>	
	12 Watchdog time-out action		<input type="radio"/>	<input checked="" type="checkbox"/>	0000H
	13 Produced connection path length		<input type="radio"/>	<input checked="" type="checkbox"/>	0000H
	14 Produced connection path		<input type="radio"/>	<input checked="" type="checkbox"/>	
	15 Consumed connection path length		<input type="radio"/>	<input checked="" type="checkbox"/>	0000H
	16 Consumed connection path		<input type="radio"/>	<input type="radio"/>	
	Service	DeviceNet service	Parameter option		
		05 Reset	No		
		0E Get_Attribute_Single	No		
		10 Set_Attribute_Single	No		

\*1 This is the total number of DeviceNet slaves connected to the wireless slave station.

Object instance 3	Section	Information	Max. number of instances		
	Instance type	Polled I/O	1		
	Production trigger	Cyclic			
	Transport type	Server			
	Transport class	2			
	Attribute	ID content	Get	Set	Value
		1 State	<input type="radio"/>	<input checked="" type="radio"/>	
		2 Instance type	<input type="radio"/>	<input checked="" type="radio"/>	0100H
		3 Transport class trigger	<input type="radio"/>	<input checked="" type="radio"/>	8200H
		4 Produced connection ID	<input type="radio"/>	<input checked="" type="radio"/>	
		5 Consumed connection ID	<input type="radio"/>	<input checked="" type="radio"/>	
		6 Initial comm. characteristics	<input type="radio"/>	<input checked="" type="radio"/>	0100H
		7 Produced connection size	<input type="radio"/>	<input checked="" type="radio"/>	0400H
		8 Consumed connection size	<input type="radio"/>	<input checked="" type="radio"/>	0800H
		9 Expected packet rate	<input type="radio"/>	<input type="radio"/>	
		12 Watchdog time-out action	<input type="radio"/>	<input checked="" type="radio"/>	0000H
		13 Produced connection path length	<input type="radio"/>	<input checked="" type="radio"/>	0000H
		14 Produced connection path	<input type="radio"/>	<input checked="" type="radio"/>	No
		15 Consumed connection path length	<input type="radio"/>	<input checked="" type="radio"/>	0000H
		16 Consumed connection path	<input type="radio"/>	<input type="radio"/>	
Service	DeviceNet service	Parameter option			
	0E Get_Attribute_Single	No			
	10 Set_Attribute_Single	No			



# Appendix B

## Connection-related Devices Model List

### Basic unit

Model	Specifications	Manufacturer
WD30-ME	DeviceNet wireless master station (pencil antenna)	OMRON
WD30-SE	DeviceNet wireless slave station (pencil antenna)	OMRON
WD30-ME01	DeviceNet wireless master station (magnet-base antenna)	OMRON
WD30-SE01	DeviceNet wireless slave station (magnet-base antenna)	OMRON

### Configurator

Model	Specifications	Manufacturer
3G8F5-DRM21	ISA board compatible configurator	OMRON
3G8E2-DRM21	PCMCIA card compatible configurator	OMRON
WS02-CFDC1-E	Installation disk (CD-ROM)	OMRON

### Connection cable for DeviceNet

Model	Specifications	Manufacturer
DCA1-5CNC01F1 DCA1-5CNC02F1 DCA1-5CNC03F1 DCA1-5CNC05F1 DCA1-5CNC10F1	Connection cable for DeviceNet Cable with connector at one side (socket side)	OMRON

### Power supply for communication

Model	Specifications	Manufacturer
S82K-03024*1	Switching power supply	OMRON
S82J-0224*2 S82J-2224 S82J-5224 S82J-6224	Switching power supply	OMRON

\*1: type of 30W or above

\*2: type of 25W or above

### Connector with terminating resistors

Model	Specifications	Manufacturer
DRS2-1	Shielded terminating resistors (plug)	OMRON
DRS2-2	Shielded terminating resistors (socket)	OMRON

### T-branch connector

Model	Specifications	Manufacturer
DCN2-1	Shielded T-branch connector	OMRON



# Appendix C

## Current Consumption List

### Current Consumption List

Model	*1 Total current consumption
WD30-ME/-ME01	Max. 350mA
WD30-SE/-SE01	Max. 350mA

\*1 The wireless unit receives the total power supply from the communication power supply via the dedicated DeviceNet cable. Thus, the total power supply listed here does not distinguish the internal circuit area from the communication area. Taking the maximum current at startup into consideration, however, use a power supply of at least 350mA. If using an OMRON S82K or S82J switching power supply, use a model with a capacity of at least 30W (S82K) or 25W (S82J).





# Appendix D

## Optional Products List

### WD30-AT001 magnet-base antenna

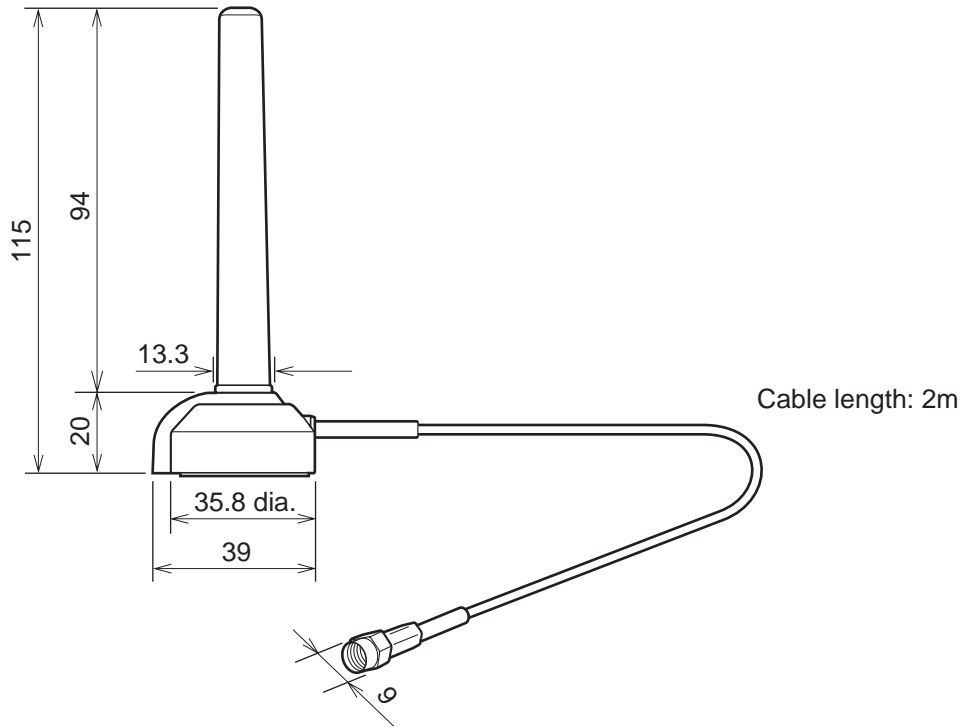



# Index

## A

Accessories, 4  
Actually measured reference data, 128  
Allocation, 6  
Antenna connector (wireless master station), 60  
Antenna connector (wireless slave station), 67  
Antennas (wireless master station), 62  
Antennas (wireless slave station), 68  
Applicable connectors, 4  
Application limitations, 14

## B

Basic format, 86  
Basic operation procedure, 20

## C

Cable connections, 25  
Caution when logging, 118, 123  
Certificate of conformance with technological standards, 3  
Check by LED display and remedy, 147  
Cleaning, 152  
Common specifications to all DeviceNet wireless units, 69  
Communication connector (wireless master station), 60  
Communication connector (wireless slave station), 67  
Communication speed selection (wireless master station), 57  
Communication speed selection (wireless slave station), 64  
Communications, 83  
Communications error output, 16  
Communications power supply, 23  
Configurator, 108  
Confirmation of specifications, 22  
Confirmation test, 57, 72, 75  
Connection-related devices, 161  
Construction of multiple wireless systems, 16  
Current consumption list, 163

## D

Default settings, 11, 57, 65  
Determination of system configuration, 22  
Device monitor display, 108

Device profiles, 155  
DeviceNet communication cable (wireless master station), 62  
DeviceNet communication cable (wireless slave station), 68  
DeviceNet interface specifications, 69  
DeviceNet manuals, v  
DeviceNet node addresses, 10  
DeviceNet setting switch (wireless master station), 57  
DeviceNet setting switch (wireless slave station), 64  
DeviceNet slave entry, 27, 65  
DeviceNet wireless master station, 3  
DeviceNet wireless master station initialization, 35  
DeviceNet wireless master station settings and installation, 24  
DeviceNet wireless master station specifications, 56  
DeviceNet wireless slave station, 4  
DeviceNet wireless slave station deletion, 32  
DeviceNet wireless slave station entry, 29  
DeviceNet wireless slave station initialization, 36  
DeviceNet wireless slave station settings and installation, 24  
DeviceNet wireless unit, 4  
DeviceNet wireless unit status, 8  
Diversity functions, 3

## E

Example of using an explicit message, 49  
Explicit messages addressed to DeviceNet slave connected before DeviceNet wireless slave station, 101  
Explicit messages addressed to DeviceNet wireless master station, 86  
External dimensions (magnet-base antenna), 62  
External dimensions (wireless master station), 61  
External dimensions (wireless slave station), 68  
External terminals/connectors (wireless master station), 60  
External terminals/connectors (wireless slave station), 67

## F

Features, 2

## G

General specifications, 69

## H

Hardware settings and wiring, 24  
How to locate errors when the system is having trouble, 144

## I

I/O limitations, 22  
I/O response time, 126  
Initializing the wireless master station, 4  
Inspection, 152  
Installation (wireless master station), 61  
Installation (wireless slave station), 67  
Installation conditions (wireless master station), 61  
Installation conditions (wireless slave station), 67  
Installation example, 41  
Installation location (wireless master station), 61  
Installation location (wireless slave station), 67  
Installation method (wireless master station), 62  
Installation method (wireless slave station), 68  
Installation of connection equipment, 25  
Installation test, 57, 65, 72, 73  
Installation test (relay function), 81

## L

Ladder program, 45  
LED display, 144  
LED display (wireless master station), 60  
LED display (wireless slave station), 67  
List of explicit messages address to DeviceNet wireless master station, 88  
Logging (monitoring 1 channel), 120  
Logging (monitoring all channels), 118

## M

magnet-base antenna, 165  
Maintain/Clear output when communication errors occur, 64, 65  
Maintenance, 152  
Message communication performance, 134  
Message communication time, 134  
Mode select switch (wireless master station), 59  
Mode select switch (wireless slave station), 65  
Model list, 4

Monitoring 1 channel, 119  
Monitoring all channels, 117  
MS LED (wireless master station), 60, 147  
MS LED (wireless slave station), 67, 148  
MS/NS/WS LED display, 142  
Multi-pass phasing, 3

## N

NNODE switch (wireless master station), 56  
NNODE switch (wireless slave station), 64  
Normal indication, 142  
NS LED (wireless master station), 60, 147  
NS LED (wireless slave station), 67, 149

## O

Operation confirmation, 31

## P

Packet error rate, 121  
Peer to peer communications, 15  
Pre-work preparations, 22  
Processing when an error occurs, 5  
Push button (wireless master station), 59  
Push button (wireless slave station), 66

## R

Reading actual time of wireless communication cycle, 89  
Reading addition information of lower DeviceNet slave, 90  
Reading addition information of the wireless slave station, 91  
Reading DeviceNet master status, 44, 98  
Reading receiving data to port 1 of the RS232C unit, 50  
Reading the number of IN points, 93  
Reading the number of OUT points, 94  
Reading upper station node address, 96  
Reading wireless error counts, 97  
Reading wireless network status, 96  
Relay function, 3, 80  
Relay station/No relay station selection, 64, 65  
Remote I/O communications performances, 126  
Replacing data, 4  
Replacing nodes, 153

Resetting the wireless master station, 115  
Routing path, 114  
Running test, 121

WS LED (wireless slave station), 67, 150

## **S**

Setting the number of IN points, 92  
Setting the number of OUT points, 94  
Setting upper station node address, 95  
Slave error flag, 8  
Status confirmation, 31  
Status LED (wireless master station), 59  
Status LED (wireless slave station), 66  
Status monitoring program example, 44  
System configuration, 2  
System initial setting and starting communications, 26  
System start, 26

## **T**

Temporary installation and installation test, 23  
Terminating resistor installation, 24  
Test, 72  
Troubleshooting, 144

## **W**

WCH switch (wireless master station), 57  
WCH switch (wireless slave station), 65  
Wireless channel monitor, 57, 65, 72, 77, 116  
Wireless communication cycle time, 109, 128  
Wireless interface specifications, 69  
Wireless network configuration display, 108  
Wireless setting switch (wireless master station), 57  
Wireless setting switch (wireless slave station), 65  
Wireless slave station, 4  
Wireless slave station deletion, 57  
Wireless slave station entry, 57  
Wireless slave station entry/deletion, 92  
Wireless slave station registration, 112  
WNODE switch (wireless master station), 59  
WNODE switch (wireless slave station), 65  
Writing settings/soft reset, 99  
Writing to the device, 114  
WS LED (wireless master station), 60, 147



## Revision History

A manual revision code appears as a suffix to the catalog number on the front cover of the manual.

Cat. No. M071-E1-02

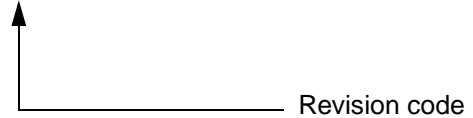

The following table outlines the changes made to the manual during each revision. Page numbers refer to the previous version.

Revision code	Date	Revised content
01	April 2002	Original production
01A	September 2002	<p><b>Page 9:</b> Information on Disconnect/Connect Switch function added.</p> <p><b>Page 10:</b> Information on serial number check function added.</p> <p><b>Page 16:</b> Changes made to precautionary information.</p> <p><b>Page 29:</b> Supplementary information added at bottom of page.</p> <p><b>Page 90:</b> Changes made to explanation on entering/deleting wireless slave stations in two places.</p> <p><b>Page 107:</b> Text added to step 3 in procedure.</p> <p><b>Pages 110, 111, 112:</b> Several changes made to setting procedures.</p> <p><b>Page 124:</b> Text added to explanation on wireless communication cycle time.</p> <p><b>Page 140:</b> Changes made to information on LED display.</p> <p><b>Page 144, 146:</b> Notes added.</p> <p><b>Page 152:</b> Identity Object Revision value changed from 3.01 to 3.02.</p>
02	December 2010	<p><b>Page 23:</b> "WCH = 01" changed to "WCH = 02" at right of first figure.</p> <p><b>Pages 23, 27 to 30, 33 to 38, and 73 to 77:</b> Setting of right-side WCH switch (X1) changed in figure.</p> <p><b>Page 77:</b> "01" changed to "02" to right of first figure.</p>







**OMRON Corporation Industrial Automation Company**  
Tokyo, JAPAN

Contact: [www.ia.omron.com](http://www.ia.omron.com)

**Regional Headquarters**

**OMRON EUROPE B.V.**

Wegalaan 67-69-2132 JD Hoofddorp  
The Netherlands  
Tel: (31)2356-81-300/Fax: (31)2356-81-388

**OMRON ELECTRONICS LLC**

One Commerce Drive Schaumburg,  
IL 60173-5302 U.S.A.  
Tel: (1) 847-843-7900/Fax: (1) 847-843-7787

**OMRON ASIA PACIFIC PTE. LTD.**

No. 438A Alexandra Road # 05-05/08 (Lobby 2),  
Alexandra Technopark,  
Singapore 119967  
Tel: (65) 6835-3011/Fax: (65) 6835-2711

**OMRON (CHINA) CO., LTD.**

Room 2211, Bank of China Tower,  
200 Yin Cheng Zhong Road,  
PuDong New Area, Shanghai, 200120, China  
Tel: (86) 21-5037-2222/Fax: (86) 21-5037-2200

**Authorized Distributor:**

© OMRON Corporation 2002 All Rights Reserved.  
In the interest of product improvement,  
specifications are subject to change without notice.

**Cat. No. M071-E1-02**

Printed in Japan  
1210