

**SYSMAC**  
**CS/CJ/CP/NSJ/NJ Series**

**CX-Integrator Ver. 2.□**

**CXONE-AL□□C-V4/AL□□D-V4**

# **OPERATION MANUAL**

**OMRON**



**SYSMAC**

**CX-Integrator Ver. 2.□**

**CXONE-AL□□C-V4/AL□□D-V4**

**Operation Manual**

*Revised April 2012*





## Notice:

OMRON products are manufactured for use according to proper procedures by a qualified operator and only for the purposes described in this manual.

The following conventions are used to indicate and classify precautions in this manual. Always heed the information provided with them. Failure to heed precautions can result in injury to people or damage to property.

 **DANGER** Indicates an imminently hazardous situation which, if not avoided, will result in death or serious injury. Additionally, there may be severe property damage.

 **WARNING** Indicates a potentially hazardous situation which, if not avoided, could result in death or serious injury. Additionally, there may be severe property damage.

 **Caution** Indicates a potentially hazardous situation which, if not avoided, may result in minor or moderate injury, or property damage.

## OMRON Product References

All OMRON products are capitalized in this manual. The word “Unit” is also capitalized when it refers to an OMRON product, regardless of whether or not it appears in the proper name of the product.

The abbreviation “Ch,” which appears in some displays and on some OMRON products, often means “word” and is abbreviated “Wd” in documentation in this sense.

The abbreviation “PLC” means Programmable Controller. “PC” is used, however, in some Programming Device displays to mean Programmable Controller.

## Visual Aids

The following headings appear in the left column of the manual to help you locate different types of information.

**Note** Indicates information of particular interest for efficient and convenient operation of the product.

**1,2,3...** 1. Indicates lists of one sort or another, such as procedures, checklists, etc.

## © OMRON, 2008

All rights reserved. No part of this publication may be reproduced, stored in a retrieval system, or transmitted, in any form, or by any means, mechanical, electronic, photocopying, recording, or otherwise, without the prior written permission of OMRON.

No patent liability is assumed with respect to the use of the information contained herein. Moreover, because OMRON is constantly striving to improve its high-quality products, the information contained in this manual is subject to change without notice. Every precaution has been taken in the preparation of this manual. Nevertheless, OMRON assumes no responsibility for errors or omissions. Neither is any liability assumed for damages resulting from the use of the information contained in this publication.



# TABLE OF CONTENTS

## PRECAUTIONS

1	Intended Audience .....	xx
2	Safety Precautions .....	xx
3	Application Precautions .....	xxii
4	Operating Environment Precautions .....	xxv
5	Guide to Version Upgrade .....	xxvi

## Section 1 Overview

1-1	The CX-Integrator .....	1-2
1-1-1	Overview .....	1-2
1-1-2	Functions According to Network .....	1-4
1-1-3	Connecting to the Relay PLC .....	1-4
1-1-4	Accessible Network.....	1-5
1-1-5	Communicating Across Network Layers.....	1-7
1-1-6	Starting Other Applications .....	1-7
1-2	Specifications.....	1-8
1-2-1	CX-Integrator Specifications .....	1-8
1-2-2	Files Created by the CX-Integrator .....	1-12
1-3	Installation.....	1-14
1-4	PLC Connecting Cables.....	1-15
1-4-1	Direct Serial Connections to a PLC .....	1-15
1-4-2	Connecting CJ-series CJ2 CPU Units, CP-series PLCs, NSJ-series Controllers, and NJ-series Controllers Using Commercially Available USB Cable .....	1-21
1-5	Window Descriptions .....	1-33
1-5-1	Starting Methods.....	1-33
1-5-2	Main Window .....	1-33
1-6	Menus .....	1-48
1-6-1	Menus .....	1-48
1-6-2	Pop-up Menus.....	1-53
1-6-3	Toolbars .....	1-61

## Section 2 Basic Operations

2-1	Basic Procedures .....	2-2
2-2	Connecting Online to the Relay PLC .....	2-10
2-2-1	Overview .....	2-10
2-2-2	Procedures.....	2-11
2-2-3	CPU Unit Troubleshooting .....	2-22
2-3	Uploading Network Configurations and Checking for Communications Unit Errors.....	2-23
2-3-1	Overview .....	2-23
2-3-2	Procedure .....	2-23
2-3-3	Checking and Correcting Communications Unit Errors .....	2-31
2-4	Switching the Target PLC .....	2-33
2-4-1	Overview .....	2-33
2-4-2	Procedure .....	2-33

2-5	Creating Virtual Network Configurations Offline .....	2-35
2-5-1	Overview .....	2-35
2-5-2	Procedure.....	2-35
2-5-3	Changing Node Addresses .....	2-45
2-5-4	Editing Components (Devices) .....	2-46
2-6	Manipulating Component Parameters .....	2-49
2-6-1	Overview .....	2-49
2-6-2	Procedure.....	2-50
2-7	Uploading, Downloading, and Comparing Network Parameters .....	2-54
2-7-1	Overview .....	2-54
2-7-2	Procedure.....	2-54
2-8	Comparing Network Configurations .....	2-55
2-8-1	Overview .....	2-55
2-8-2	Procedure.....	2-55
2-9	File Operations.....	2-56
2-9-1	Overview .....	2-56
2-9-2	Procedures.....	2-57
2-10	Target PLC Online Operations.....	2-60
2-10-1	Overview .....	2-60
2-10-2	Procedure.....	2-60
2-11	Starting Specified Applications .....	2-62
2-11-1	Overview .....	2-62
2-11-2	Procedure.....	2-62
2-12	Printing .....	2-63

### Section 3 Routing Tables

3-1	Routing Table Overview.....	3-2
3-1-1	Definition of Routing Tables.....	3-2
3-1-2	Network Conditions That Require Routing Tables.....	3-4
3-1-3	Routing Table Setting Methods.....	3-5
3-1-4	Routing Table File Types Supported by the CX-Integrator.....	3-6
3-1-5	Transferring the Routing Tables .....	3-6
3-1-6	Operating Procedures Prior to Routing Table Transfer .....	3-7
3-2	Setting the Routing Tables.....	3-11
3-2-1	Routing Table Setting Example .....	3-11
3-2-2	Creating the FINS Local Routing Tables .....	3-12
3-2-3	Setting the Gateway Counter.....	3-20
3-2-4	Checking Routing Tables for Errors.....	3-23
3-2-5	Transferring Routing Tables to a Directly Connected PLC.....	3-24
3-2-6	Saving Routing Tables.....	3-26
3-2-7	Reading Routing Tables .....	3-26
3-2-8	Verifying Routing Tables.....	3-26
3-2-9	Printing Routing Tables.....	3-27
3-2-10	Transferring Routing Tables to a Network PLC through a Direct Serial Connection .....	3-28



3-3	Maintenance after Network Configuration .....	3-32
3-3-1	FINS Network Routing Tables .....	3-32
3-3-2	Editing the FINS Local Network Tables .....	3-32

## Section 4 Data Links for Controller Link and SYSMAC LINK

4-1	Overview .....	4-2
4-1-1	What Are Data Links? .....	4-2
4-1-2	Overview of Procedure by Data Link Setting Method .....	4-3
4-2	User Interface Overview .....	4-4
4-2-1	Starting the Data Link Component.....	4-4
4-2-2	Datalink Component .....	4-4
4-3	Manually Setting Data Links .....	4-8
4-3-1	Procedure through Data Link Startup .....	4-8
4-3-2	Creating Data Link Tables .....	4-9
4-3-3	System Configuration Example .....	4-11
4-3-4	Creating Data Link Tables Offline.....	4-12
4-3-5	Procedure Using Setup Example.....	4-23
4-3-6	Checking Data Link Tables .....	4-25
4-3-7	Printing Data Link Tables.....	4-25
4-3-8	Saving Data Link Tables.....	4-26
4-3-9	Creating, Reading, and Writing CSV Files (Saving) .....	4-26
4-3-10	Reading and Data Link Tables .....	4-32
4-3-11	Transferring the Data Link Table .....	4-34
4-3-12	Starting and Stopping Data Links (Including Status Displays) .....	4-41
4-4	Automatically Set Data Links .....	4-43
4-4-1	Procedure Through Data Link Startup .....	4-43
4-4-2	Controller Link Automatic Setup .....	4-44
4-4-3	SYSMAC LINK Automatic Setup .....	4-49
4-4-4	Transferring Automatic Data Link Setup Parameters to the Startup Node.....	4-50
4-4-5	Monitoring Data Link Status.....	4-52

## Section 5 Ethernet

5-1	Broadcast Node Search.....	5-2
5-1-1	Overview .....	5-2
5-1-2	Procedure .....	5-2
5-2	Ping Test.....	5-4
5-2-1	Overview .....	5-4
5-2-2	Procedure .....	5-4

## Section 6 DeviceNet

6-1	DeviceNet Setting Procedures.....	6-2
6-1-1	Designing Networks Offline.....	6-2
6-1-2	Downloading Saved Parameters .....	6-2
6-1-3	Saving the Parameters for the Entire Existing Network.....	6-3
6-2	Setting Slave Parameters .....	6-4
6-2-1	Editing Slave Parameters .....	6-4
6-2-2	Checking and Setting I/O Size .....	6-6

6-3	Adding Slaves to the Master .....	6-8
6-3-1	Automatic I/O Area Allocation with Registration .....	6-8
6-3-2	Adding Slaves .....	6-10
6-4	Setting Master Properties.....	6-13
6-4-1	CS1W-DRM21(-V1) and CJ1W-DRM21 .....	6-13
6-4-2	CVM1-DRM21-V1 or C200HW-DRM21-V1 .....	6-14
6-5	Editing Master Parameters.....	6-15
6-6	Parameter Wizard .....	6-16
6-7	Master Parameter Editing Details (Tab Descriptions).....	6-21
6-7-1	Edit Device Parameters on CS1W-DRM21(-V1)/CJ1W-DRM21 .....	6-22
6-7-2	Editing Device Parameters on CVM1-DRM21-V1 and C200HW-DRM21-V1 ...	6-24
6-7-3	Editing Device Parameters on 3G8F7-DRM21 DeviceNet PCI Board Scanner .....	6-26
6-7-4	Canceling Slave Registration with the Master .....	6-28
6-7-5	Automatic Allocation with Registration .....	6-28
6-8	Manual I/O Allocations .....	6-29
6-8-1	I/O Allocation Tab Page .....	6-29
6-8-2	Changing the First Address of Output/Input Block.....	6-30
6-8-3	Allocating I/O .....	6-32
6-8-4	Slave Information .....	6-35
6-9	Advanced Settings (Connection, Communication Cycle Time, Slave Function Settings, Etc.) .....	6-36
6-9-1	Advanced Settings .....	6-36
6-9-2	Communication Cycle Time Settings .....	6-38
6-9-3	Setting Message Timers .....	6-39
6-9-4	Slave Function Settings .....	6-41
6-9-5	Setting/Canceling Explicit Message Communications.....	6-42
6-9-6	Starting Remote I/O Communications .....	6-42
6-10	Creating and Editing I/O Comments .....	6-43
6-11	Displaying Device Properties .....	6-45
6-11-1	Property Dialog Box Common to All Devices .....	6-45
6-11-2	I/O Information Inherent to Each Slave Device.....	6-46
6-11-3	Information for Master .....	6-48
6-12	Downloading the Network Configuration/Device Parameters to Devices.....	6-51
6-12-1	Downloading the Network Configuration.....	6-51
6-12-2	Downloading Device Parameters.....	6-53
6-12-3	Resetting the Device .....	6-55
6-13	Uploading and Verifying Device Parameters .....	6-56
6-13-1	Uploading the Network Configuration .....	6-56
6-13-2	Uploading Device Parameters .....	6-56
6-13-3	Verifying the Network Configuration .....	6-58
6-13-4	Verifying Device Parameters .....	6-59
6-14	Monitoring Devices.....	6-61
6-14-1	Setting Monitor Refresh Timer .....	6-61
6-14-2	Monitoring Devices.....	6-62
6-15	Using General-purpose Tools to Set Devices.....	6-69
6-15-1	Setting Device Parameters with Class Instances .....	6-69

6-16	Optional Functions .....	6-71
6-16-1	Installing Expansion Modules .....	6-71
6-16-2	Adding Vendors and Device Types .....	6-71

## Section 7 CompoNet

7-1	Overview .....	7-2
7-1-1	What Is CompoNet?.....	7-2
7-2	Basic Procedures .....	7-3
7-2-1	Basic Procedures .....	7-3
7-2-2	Optional Settings.....	7-4
7-3	Uploading, Downloading, and Comparing Network Configurations.....	7-5
7-3-1	Upload the Network Configuration to the Computer .....	7-5
7-3-2	Comparing Network Configurations .....	7-6
7-4	Component Monitor .....	7-7
7-4-1	Starting Monitoring .....	7-7
7-4-2	Master Unit Monitor Window.....	7-8
7-5	Uploading, Downloading, and Comparing Component Parameters.....	7-13
7-5-1	Uploading Component Parameters to a Computer .....	7-13
7-5-2	Comparing Component Parameters .....	7-14
7-5-3	Downloading the Component Parameters to the Components .....	7-15
7-5-4	Resetting Component .....	7-17
7-6	Editing Master Unit Parameters .....	7-18
7-6-1	Master Unit Parameter Settings.....	7-18
7-6-2	Editing the Registration Table.....	7-23
7-6-3	Editing the Software Setting Table .....	7-26
7-7	Editing Slave Parameters .....	7-28
7-7-1	Setting Slave Parameters .....	7-28
7-7-2	Checking the Slave I/O Size .....	7-29
7-8	Other CompoNet Functions .....	7-30
7-8-1	Additional Functions.....	7-30
7-8-2	Installing Expansion Modules .....	7-31

## Section 8 CompoWay/F

8-1	CompoWay/F System Configuration .....	8-2
8-1-1	Overview .....	8-2
8-2	CompoWay/F Slaves Connected to a PLC.....	8-3
8-2-1	Communications with CompoWay/F Slaves through a PLC .....	8-3
8-2-2	Setting the CompoWay/F Slave's Parameters .....	8-8
8-3	CompoWay/F Slaves Connected to a Computer.....	8-10
8-3-1	Reading from Slaves Connected to the Computer .....	8-10

## Section 9 NT Links

9-1	NT Link Connection Auto-detect Function .....	9-2
9-1-1	Overview .....	9-2
9-1-2	Procedure .....	9-2

9-2	Transferring Screen Data through the PLC .....	9-6
9-2-1	Overview .....	9-6
9-2-2	Procedure.....	9-6

## Section 10 Network Testing

10-1	Controller Link Network Diagnostic Tool.....	10-2
10-1-1	Diagnostic Functions and Flowcharts .....	10-2
10-1-2	Diagnosing Network Status.....	10-5
10-1-3	Diagnosing Node Settings .....	10-11
10-1-4	Diagnosing Disconnections.....	10-14
10-1-5	Diagnosing Transmission Status .....	10-17
10-1-6	Node Status .....	10-18
10-1-7	Collecting Error Logs.....	10-21
10-2	Echoback Test between Nodes .....	10-22
10-2-1	Overview .....	10-22
10-2-2	Start Methods.....	10-22
10-2-3	PLC Internode Echoback Test Dialog Box.....	10-22
10-2-4	Executing an Echoback Test between Nodes .....	10-23
10-3	Ethernet Ping Test .....	10-25
10-3-1	Overview .....	10-25
10-3-2	Start Methods.....	10-25
10-3-3	Ping Test Dialog Box.....	10-25
10-3-4	Executing a Ping Test .....	10-26

## Appendices

A-1	CPS File Management.....	A-2
A-1-1	Description of CPS Files .....	A-2
A-2	EDS File Management.....	A-5
A-2-1	Installing EDS Files .....	A-5
A-2-2	Creating EDS Files.....	A-6
A-2-3	Deleting EDS Files.....	A-7
A-2-4	Saving EDS Files .....	A-7
A-2-5	Searching EDS Files .....	A-8
A-2-6	Displaying EDS File Properties.....	A-8
A-3	Precautions When Using Windows Vista or Windows 7 .....	A-9

## Revision History

## About this Manual:

This manual describes the installation and operation of CX-Integrator and includes the sections described below.

Please read this manual carefully and be sure you understand the information provided before attempting to use the CX-Integrator. Be sure to read the precautions provided in the following section.

**Precautions** provides general precautions for using the CX-Integrator.

**Section 1** outlines the functions of the CX-Integrator and describes the menus and connecting to networks.

**Section 2** describes the basic operations required to use the CX-Integrator.

**Section 3** describes how to set routing tables.

**Section 4** describes how to set data links for Controller Link and SYSMAC LINK Networks.

**Section 5** describes how to use the diagnostic tools for Controller Link Networks.

**Section 6** describes settings and operations unique to DeviceNet Networks, including registering slaves in the master, allocating I/O, monitoring devices, etc.

**Section 7** describes the basic use of and how to set parameters for CompoNet Networks.

**Section 8** describes settings and operations unique to CompoWay/F Networks.

**Section 9** settings and operations unique to NT Links.

**Section 10** describes operations for testing networks using the Controller Link Network Diagnostic Tool, echoback tests between nodes, and Ethernet ping tests.

The **Appendix** describes CPS files for Ethernet, Controller Link, CompoWay/F, and NT Link Networks and EDS files for DeviceNet Networks.

 **WARNING** Failure to read and understand the information provided in this manual may result in personal injury or death, damage to the product, or product failure. Please read each section in its entirety and be sure you understand the information provided in the section and related sections before attempting any of the procedures or operations given.

## Manuals Related to the CX-Integrator

Cat No.	Models	Name	Description
W464 (this manual)	CXONE-AL□□C-V4/ AL□□D-V4	CX-Integrator Operation Manual	Describes CX-Integrator operating methods, e.g., for setting up and monitoring networks.
W463	CXONE-AL□□C-V4/ AL□□D-V4/LT□□C-V4	CX-One Setup Manual	Describes installation and provides an overview of the CX-One FA Integrated Tool Package.
W446	CXONE-AL□□C-V4/ AL□□D-V4	CX-Programmer Operation Manual	Describes CX-Programmer operations except those related to function blocks.
W447	CXONE-AL□□C-V4/ AL□□D-V4	CX-Programmer Operation Manual: Function Blocks and Structured Text	Describes function block functions and programming in structured text language. For basic CX-Programmer operations, refer to the <i>CX-Programmer Operation Manual</i> (W446).
W469	CXONE-AL□□C-V4/ AL□□D-V4	CX-Programmer Operation Manual: SFC	Describes the SFC programming functions. For basic CX-Programmer operations, refer to the <i>CX-Programmer Operation Manual</i> (W446).
W504	SYSMAC-SE2□□□	Sysmac Studio Version 1 Operation Manual	Describes the procedures and operations of the Sysmac Studio, including operations for functions, function blocks, and structured text programming.

## Manuals Related to DeviceNet

Cat No.	Models	Name	Description
W267	---	DeviceNet Operation Manual	Describes network communications settings and wiring common to all DeviceNet networks.
W380	CS1W-DRM21(-V1) CJ1W-DRM21	DeviceNet Unit Operation Manual	Describes CX/CJ-series DeviceNet Units.
W379	C200HW-DRM21-V1 CVM1-DRM21-V1	DeviceNet Master Unit Operation Manual	Describes C200H and CV/CVM1-series DeviceNet Master Units.
W381	3G8F7-DRM21	DeviceNet PCI Board Operation Manual	Describes the DeviceNet PCI Board.

## Manuals Related to CompoNet

Cat No.	Models	Name	Description
W456	CS1W-CRM21 CJ1W-CRM21	CompoNet CS1W-CRM21/CJ1W-CRM21 CompoNet Master Units Operation Manual	Provides an overview of the CompoNet Network and describes network communications settings and wiring common to all CompoNet networks. Also describes CS/CJ-series CompoNet Master Units.
W457	CRT1 Series CRS1 Series	CompoNet Slave Units and Repeater Unit Operation Manual	Provides CompoNet Slave Unit and Repeater Unit specifications.

## ***Read and Understand this Manual***

Please read and understand this manual before using the product. Please consult your OMRON representative if you have any questions or comments.

## ***Warranty and Limitations of Liability***

### ***WARRANTY***

- (1) The warranty period for the Software is one year from either the date of purchase or the date on which the Software is delivered to the specified location.
- (2) If the User discovers a defect in the Software (i.e., substantial non-conformity with the manual), and returns it to OMRON within the above warranty period, OMRON will replace the Software without charge by offering media or downloading services from the Internet. And if the User discovers a defect in the media which is attributable to OMRON and returns the Software to OMRON within the above warranty period, OMRON will replace the defective media without charge. If OMRON is unable to replace the defective media or correct the Software, the liability of OMRON and the User's remedy shall be limited to a refund of the license fee paid to OMRON for the Software.

### ***LIMITATIONS OF LIABILITY***

- (1) THE ABOVE WARRANTY SHALL CONSTITUTE THE USER'S SOLE AND EXCLUSIVE REMEDIES AGAINST OMRON AND THERE ARE NO OTHER WARRANTIES, EXPRESSED OR IMPLIED, INCLUDING BUT NOT LIMITED TO, WARRANTY OF MERCHANTABILITY OR FITNESS FOR A PARTICULAR PURPOSE. IN NO EVENT WILL OMRON BE LIABLE FOR ANY LOST PROFITS OR OTHER INDIRECT, INCIDENTAL, SPECIAL, OR CONSEQUENTIAL DAMAGES ARISING OUT OF USE OF THE SOFTWARE.
- (2) OMRON SHALL ASSUME NO LIABILITY FOR DEFECTS IN THE SOFTWARE BASED ON MODIFICATION OR ALTERNATION OF THE SOFTWARE BY THE USER OR ANY THIRD PARTY.
- (3) OMRON SHALL ASSUME NO LIABILITY FOR SOFTWARE DEVELOPED BY THE USER OR ANY THIRD PARTY BASED ON THE SOFTWARE OR ANY CONSEQUENCE THEREOF.

## ***Application Considerations***

<b><i>SUITABILITY FOR USE</i></b>
THE USER SHALL NOT USE THE SOFTWARE FOR A PURPOSE THAT IS NOT DESCRIBED IN THE ATTACHED USER MANUAL.



## ***Disclaimers***

### ***CHANGE IN SPECIFICATIONS***

The software specifications and accessories may be changed at any time based on improvements or for other reasons.

### ***EXTENT OF SERVICE***

The license fee of the Software does not include service costs, such as dispatching technical staff.

### ***ERRORS AND OMISSIONS***

The information in this manual has been carefully checked and is believed to be accurate; however, no responsibility is assumed for clerical, typographical, or proofreading errors, or omissions.



# PRECAUTIONS

This section provides precautions for using the CX-Integrator.

**The information contained in this section is important for the safe and reliable application of the CX-Integrator. You must read this section and understand the information contained before attempting to use the CX-Integrator.**

1	Intended Audience .....	xx
2	Safety Precautions .....	xx
3	Application Precautions.....	xxii
4	Operating Environment Precautions.....	xxv
5	Guide to Version Upgrades .....	xxvi

# 1 Intended Audience

This manual is intended for the following personnel, who must also have knowledge of electrical systems (an electrical engineer or the equivalent).

- Personnel in charge of installing FA systems
- Personnel in charge of designing FA systems
- Personnel in charge of managing FA systems and facilities

# 2 Safety Precautions

 **WARNING**

Provide safety measures in external circuits (i.e., not in the Programmable Controller), including the following items, to ensure safety in the system if an abnormality occurs due to malfunction of the PLC or another external factor affecting the PLC operation. Not doing so may result in serious accidents.

- Emergency stop circuits, interlock circuits, limit circuits, and other safety measures must be provided in external control circuits.
- The PLC will turn OFF all outputs when its self-diagnosis function detects any error or when a severe failure alarm (FALS) instruction is executed. Unexpected operation, however, may still occur for errors in the I/O control section, errors in I/O memory, and other errors that cannot be detected by the self-diagnosis function. As a countermeasure for all such errors, external safety measures must be provided to ensure safety in the system.
- The PLC outputs may remain ON or OFF due to deposits on or burning of the output relays, or destruction of the output transistors. As a countermeasure for such problems, external safety measures must be provided to ensure safety in the system.
- When the 24-V DC output (service power supply) is overloaded or short-circuited, the voltage may drop and result in the outputs being turned OFF. As a countermeasure for such problems, external safety measures must be provided to ensure safety in the system.

 **WARNING**

The CPU Unit refreshes I/O even when the program is stopped (i.e., even in PROGRAM mode). Confirm safety thoroughly in advance before changing the status of any part of memory allocated to I/O Units, Special I/O Units, or CPU Bus Units. Any changes to the data allocated to any Unit may result in unexpected operation of the loads connected to the Unit. Any of the following operation may result in changes to memory status.

- Transferring I/O memory data to the CPU Unit from a Programming Device
- Changing present values in memory from a Programming Device.
- Force-setting/-resetting bits from a Programming Device.
- Transferring I/O memory files from a Memory Card or EM file memory to the CPU Unit.
- Transferring I/O memory from a host computer or from another PLC on a network.

 **Caution** When performing any of the following operations, always check the network address and node address of the other node (PLC) and the node address

and unit number of the mounted Unit (PLC CPU Bus Unit or Special I/O Unit) or the node address of the Component (DeviceNet Master/Slave or CompoWay/F Slave), and be sure that these operations can be performed safely for the current status of the node (Unit or Component):

- Transferring parameter or program data to the other node
- Changing the operating mode of the other node

Unexpected operation may result if parameter or program data is transferred to the wrong node (DeviceNet Master/Slave, CompoNet Master/Slave or CompoWay/F Slave), the operating mode of the wrong node is changed, or the other node is not in a suitable status to receive the program or parameter data or the operating mode change.

 **Caution** When changing the target PLC to any PLC other than the relay PLC, check the node address and node number of the target PLC carefully before executing the change. Unexpected operation and injury may result if the wrong PLC is set as the target PLC.

- Changing the operating mode
- Transferring or verifying user-set data link tables
- Transferring or verifying routing tables
- Performing I/O table operations (including transferring CPU Bus Unit or Special I/O Unit parameters)

**Note** Operations performed from the CX-Integrator are performed for the target PLC, which is not necessarily the same as the relay PLC.

 **Caution** When transferring parameters that have been created or edited on the computer to actual Units (PLC CPU Bus Units or PLC Special I/O Units) or to actual Components (DeviceNet Masters/Slaves, CompoNet Master/Slave or CompoWay/F Slaves), always check the identifying number of the actual Units or Components (i.e., the unit numbers and unit addresses or node addresses) before executing the transfer. Unexpected operation and injury may result if parameters are transferred to the wrong Unit or Component.

 **Caution** When changing or removing a routing table (see note), be sure to update the display for the Online Connection Information Window. The display for the Online Connection Information Window could possibly be different from the actual network status. If operations are executed without first updating the display, particularly online operations in the Network Configuration Window, it could cause data to be mistakenly read or written for the wrong network or node address or unit number.

**Note:** Changing or removing a routing table refers to using the CX-Integrator (or a CX-Integrator for another personal computer) to start the Routing Table Component and then changing or removing a routing table for the target PLC (either a local network table or a relay network table).

 **Caution** Do not execute a broadcast node search if a node exists for something other than an OMRON Ethernet Unit or FinsGateway within the same segment on Ethernet, and when the Ethernet network system is in operation. When a broadcast node search is executed, an OMRON FINS command is sent to all nodes in the segment. Therefore, if a node exists for something other than an OMRON Ethernet Unit or FinsGateway, the FINS command will not be received at that node and unexpected operation may occur.

 **Caution** Confirm safety thoroughly in advance before transferring program data to another node on the network or changing the I/O memory. Otherwise, injuries may occur.

## 3 Application Precautions

Observe the following precautions when using the CX-Integrator.

### General Communications Precautions

- Do not turn OFF the power to the PLC or disconnect the cable connecting the PLC when the CX-Integrator is online with the PLC. Doing so may cause the computer running CX-Integrator to malfunction.
- Before changing the operating mode, always confirm that doing so will not adversely affect system operation.
- Always check the operation of parameters sufficiently before using them for actual system operation.
- Confirm that resetting CPU Bus Units and Special I/O Units will not adversely affect system operation before resetting these Units.
- Use only the specified communications cables.
- Do not extend connection distances beyond the ranges given in the specifications.
- Take appropriate measures to ensure that the specified power with the rated voltage and frequency is supplied. Be particularly careful in places where the power supply is unstable. An incorrect power supply may result in malfunction.
- When installing the PLC, ground to 100 $\Omega$  min.
- Install external breakers and take other safety measures against short-circuiting in external wiring. Insufficient safety measures against short-circuiting may result in burning.
- Check all wiring and switch settings to be sure they are correct before turning ON the power supply.
- Check the user programming (e.g., the ladder program) for proper execution before actually running it on the PLC. Not checking the program may result in unexpected operation.

### DeviceNet

- Enable the scan list to before operating the system.
- When adding a new node to the network, make sure that the baud rate is the same as other nodes.
- Use specified communications cables.
- Do not extend connection distances beyond the ranges given in the specifications.
- Always turn OFF the power supply to the personal computer, Slaves, and Communications Units before attempting any of the following.
  - Attaching or detaching the DeviceNet Board or Card
  - Assembling the Units
  - Setting rotary switches
  - Connecting or wiring the cables
  - Connecting or disconnecting connectors

- Be sure that the communications cables and other items with locking devices are properly locked into place.
- Observe the following precautions when wiring the communications cable.
  - Separate the communications cables from the power lines or high-tension lines.
  - Do not bend the communications cables.
  - Do not pull on the communications cables.
  - Do not place heavy objects on top of the communications cables.
  - Be sure to wire communications cable inside ducts.
  - Use appropriate communications cables.
- Before touching the PCI Board, be sure to first touch a grounded metallic object in order to discharge any static build-up. Not doing so may result in malfunction or damage.
- When transporting a Board or Card, use the special box in which it was shipped to protect the LSIs and ICs from being damaged. Also do not subject the Board or Card to excessive vibration or shock.
- Because the devices are reset in order, communications errors will temporarily occur in the master and slaves. For this reason, do not download the network configuration while the master-side PLC (CPU Unit) is operating.
- When downloading the network configuration, each of the devices is reset. If the Master Unit is reset first, it may cause errors in writing parameters to the subsequent slaves. For that reason, this method (downloading the network configuration) should be used only when the Master Unit has been given the highest address.
- Downloaded device parameters will be valid only after the devices are reset unless they are the OMRON CVM1-DRM21-V1, C200HW-DRM21-V1, CS1W-DRM21(-V1), or CJ1W-DRM21.
- When the devices are reset, communications errors will temporarily occur. For this reason, do not reset the devices while the master-side PLC (CPU Unit) is operating.

#### **Data Links in Controller Link or SYSMAC LINK Networks**

- The data link mode (manual setting or automatic setting) and data link method are determined according to the data link setting in the startup node. In the startup node, set a data link table for manual settings and data link automatic setting parameters for automatic settings. If the settings are incorrect, the data links will not start. Check the following items before starting data links.
  - (1) Manually Set Data Links  
Check the data link tables in each node participating in the data link to see that they are correct.  
Be sure that data link tables are deleted from nodes that are not participating in the data links.
  - (2) Automatically Set Data Links  
Be sure that the correct DM parameters have been set in the data link startup node.

### **3 Application Precautions**

- If incorrect data link tables or parameters are set, injury may result due to unexpected operation of the system. Even if the correct data link tables and parameters have been set, do not start or stop data links before verifying that there will be no adverse influence on the system.

#### **Routing Tables**

CPU Bus Units are reset when routing tables are transferred from a Programming Device to a PLC to allow set routing tables to be read. Make sure that resetting CPU Bus Units will not cause equipment damage or dangerous system behavior before transferring tables.

#### **CompoNet**

- Be sure to start operation only after transferring the necessary parameters in the EEPROM of the CompoNet Master Unit (e.g., software settings and registration table settings) from the CX-Integrator to the CompoNet Master Unit.
- I/O allocations may change if the communications mode of the CompoNet Master Unit is changed.



## 4 Operating Environment Precautions

 **Caution** Perform installation properly, according to the procedures described in this manual.

 **Caution** Do not install in the following locations:

- Locations subject to direct sunlight
- Locations subject to temperatures or humidity outside the range specified in the specifications
- Locations subject to condensation as the result of severe changes in temperature
- Locations subject to corrosive or flammable gases
- Locations subject to dust (especially iron dust) or salts
- Locations subject to exposure to water, oil, or chemicals
- Locations subject to shock or vibration

 **Caution** Take appropriate and sufficient countermeasures when installing in the following locations:

- Locations subject to static electricity or other forms of noise
- Locations subject to strong electromagnetic fields
- Locations subject to possible exposure to radioactivity
- Locations close to power supplies

## 5 Guide to Version Upgrades

The following table shows the changes in the upgrade from CX-Integrator Ver. 2.52 to Ver. 2.53.

Item	Previous (Ver. 2.52)	Ver. 2.53
Support for CP-series CP1L-EM/EL CPU Units	Not supported.	The CP1L-EM□□□□-□ and CP1L-EL□□□□-□ are now supported.

The following table shows the changes in the upgrade from CX-Integrator Ver. 2.5 to Ver. 2.52.

Item	Previous (Ver. 2.5)	Ver. 2.52
Support for NJ-series NJ301 CPU Units	Not supported.	The NJ301-1100/1200 are supported.

The following table shows the changes in the upgrade from CX-Integrator Ver. 2.4 to Ver. 2.5.

Item	Previous (Ver. 2.4)	Ver. 2.5
Support for NJ-series CPU Units	Not supported.	NJ501-1300/1400/1500 are supported.

The following table shows the changes in the upgrade from CX-Integrator Ver. 2.3 to Ver. 2.4.

Item	Previous (Ver. 2.3)	Ver. 2.4
Support for Windows 7	Not supported.	Supported.
Support for CJ-series CJ2M CPU Units	Not supported.	CJ2M-CPU□□ are supported. Note: To enable support for CJ2M CPU Units, the common component version upgrade program in the CX-One Version 4 Auto-update (February 2010) must be applied.

The following table shows the changes in the upgrade from CX-Integrator Ver. 2.2 to Ver. 2.3.

Item	Previous (Ver. 2.2)	Ver. 2.3
Support for CJ-series CJ2 CPU Units and EtherNet/IP Units	None	Supported. CJ2H-CPU6□-EIP, CJ2H-CPU6□ and CS1W/CJ1W-EIP□□ Units are now supported.

The following table shows the changes in the upgrade from CX-Integrator Ver. 2.1 to Ver. 2.2.

Item	Previous (Ver. 2.1)	Ver. 2.2
CompoNet Network support	Not supported.	Supported. Component parameter settings and monitoring is now possible on CompoNet, a field network in which connection and settings can be performed easily.

The following table shows the changes in the upgrade from CX-Integrator Ver. 2.0 to Ver. 2.1.

Item	Previous (Ver. 2.0)	Ver. 2.1
Switching of the target PLC from the PLC Routing Table Window	Not supported. (When the CX-Integrator is directly connected by a serial connection to a PLC without transferred routing tables, routing tables can be transferred only to that PLC.)	Supported. (When the CX-Integrator is directly connected by a serial connection to a PLC without transferred routing tables, the connection can be switched to other nodes in the network that are connected to that PLC, and the routing tables can be transferred to those connected nodes. The directly connected PLC must have a CS/CJ-series CPU Unit with unit version 4.0 or later.)
Transferring routing tables to a PLC that is connected directly by Ethernet	Not supported. (It was not possible to select <b>Work Online</b> to connect directly through Ethernet to a PLC without transferred routing tables.) Note: The CX-Programmer can connect online.	Supported. (A PLC without transferred routing tables can be connected directly through Ethernet, and the routing tables can be transferred.)
Resuming an upload of the DeviceNet network information	Not supported.	Supported. (If an error occurred while transferring the DeviceNet network information due to a communications error or other error, the information can be transferred only from the nodes where the transfer error occurred.)
Maximum number of send words per node in a Controller Link data link	1,000 words max.	4,000 words max. (The CS1W-CLK13, CS1W-CLK23, CJ1W-CLK23, and CS1W-CLK53 Controller Link Units support this feature.)
Number of entries registered in the relay network table (Number of destination network, relay network, and relay node combinations)	20 entries max.	64 entries max. (An expansion mode for the number of relay networks is available.) (This feature is supported only for CJ2/CJ1-R CPU Units.)
Display of the transferred (network to PC) CompoWay/F network address	No	Yes (When a network address is allocated to the CompoWay/F network transferred to the PC, that network address will be displayed.)

## Guide to Version Upgrades

The following table shows the changes in the upgrade from CX-Integrator Ver. 1.1 to Ver. 2.0.

Item	Previous (Ver. 1.1)	Ver. 2.0
System overview showing network configuration relationships	Not supported.	A System Overview Window displays the relationships between different networks. You can understand the relationships between networks on one display. Also, you can easily switch between the System Overview and the Network View.
Registering networks and components	Entered in dialog box for each setting.	A Wizard can be used to enter settings. You can also return to the previous setting to correct it.
Workspace Window	Only networks are listed.	Components and networks are listed.
Property Window	Not supported.	The properties of the selected component or network are displayed.
Data link mode (automatic/manual) confirmation when transferring Controller Link data link tables	Not supported. (The Data Link Specification in the software switched in allocated DM Area words does not change.)	When transferring Controller Link data link tables, the data link mode (automatic or manual) can be checked for all the nodes on the network.  After confirmation, the data link modes for all nodes can be changed to user-set data links.
Combining PLCs between networks	When more than one network is uploaded by connecting to different PLCs, the Network Configuration Windows sometimes have the same PLC registered as two separate PLCs.	If the same PLC is registered separately, the PLCs can be combined as the same PLC in the Network Configuration Window.

The following table shows the changes in the upgrade from CX-Integrator Ver. 1.0 to Ver. 1.1.

Item	Previous (Ver. 1.0)	Ver. 1.1
Ethernet network PING test	Not supported.	Yes
Echoback test between nodes on Ethernet, Controller Link, SYSMAC LINK, and DeviceNet	Not supported.	Yes. (Response time can be measured.)
Controller Link network diagnosis Repeater display	Not supported.	Branching information can be displayed by Repeater Units.
Start Special Application	Not supported.	It is possible to select an Inverter on DeviceNet, and to start the CX-Drive.
Support for NSJ Series	No	Yes

# **Communications**

## **Section 1 Overview**

This section provides an overview of the CX-Integrator and describes CX-Integrator menus and connections.

# 1-1 The CX-Integrator

## 1-1-1 Overview

# 1-1 The CX-Integrator

## 1-1-1 Overview

The CX-Integrator is a Programming Device software package that enables reading the PLC's network and serial network configuration from a personal computer via an online connection. This enables easily performing many operations, such as monitoring the connection status of various networks, setting parameters, and diagnosing networks.

The CX-Integrator can be placed online manually or automatically with the CS/CJ-series PLC to which it is directly connected to enable uploading and monitoring the network configuration (including device parameters) for that PLC or other network PLCs for each network.

Direct connection to serial communications using the CompoWay/F protocol is also possible without going through a PLC. The CompoWay/F network configuration can be uploaded or automatic connection is possible using the NT Link protocol for NS-series PTs and CS/CJ-series PLCs.

Furthermore, parameters in slaves on the networks can be set, edited, uploaded, and downloaded.

Whenever required, network configuration information can be saved in files. The configuration information in previously saved files can be later compared to the actually current configuration.

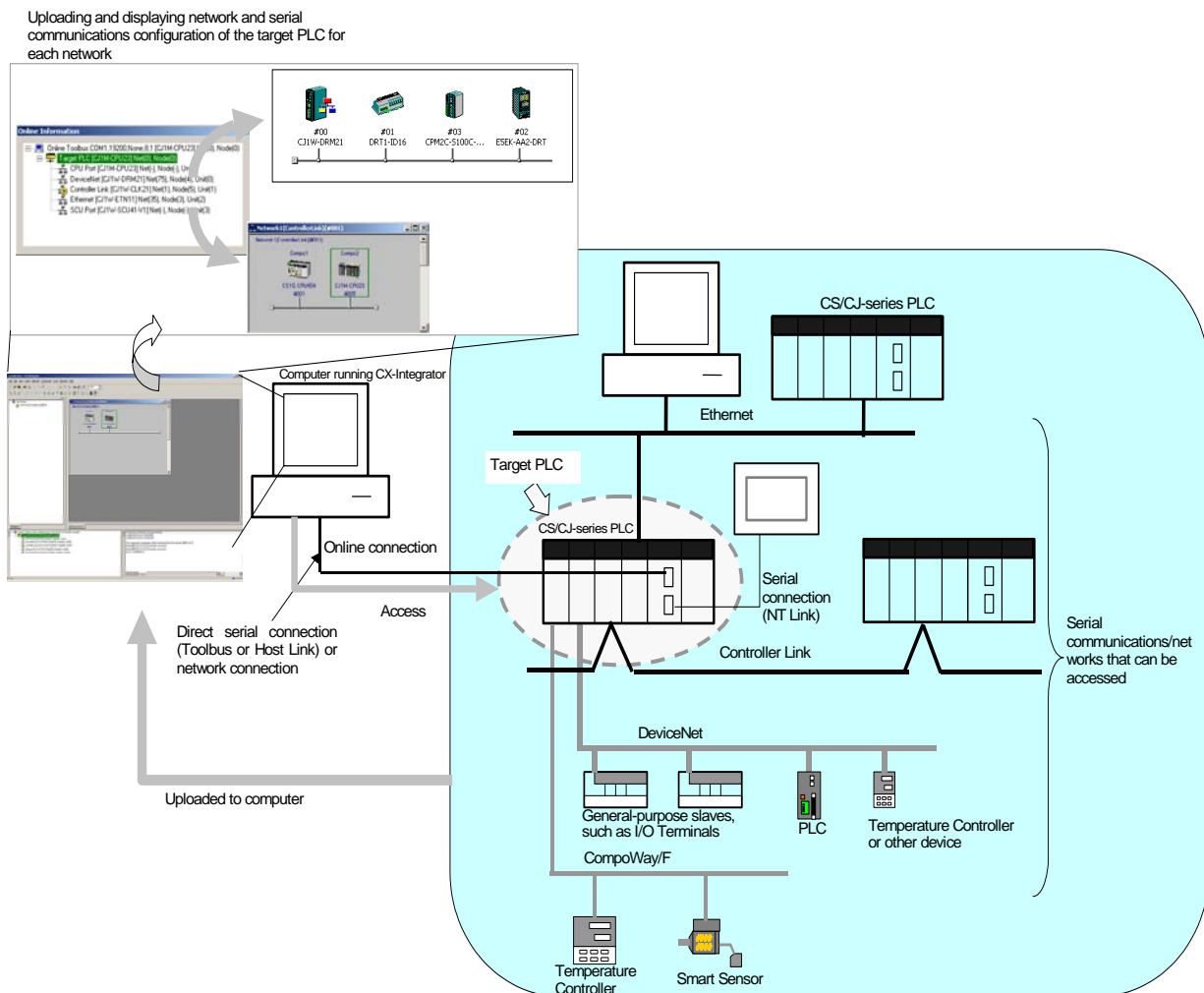

The network/serial communications configuration of a PLC other than the one originally connected to online to can be set as the target. The PLC that was originally connected to online (called the relay PLC, see note 1), is relayed through to connect to another PLC (called the target PLC, see note 2) to switch the online connection.

**Note 1:** The relay PLC is the PLC to which an online connection was first made from the computer through a network or serial connection.

**Note 2:** The target PLC is the PLC from which the network configuration can be uploaded.

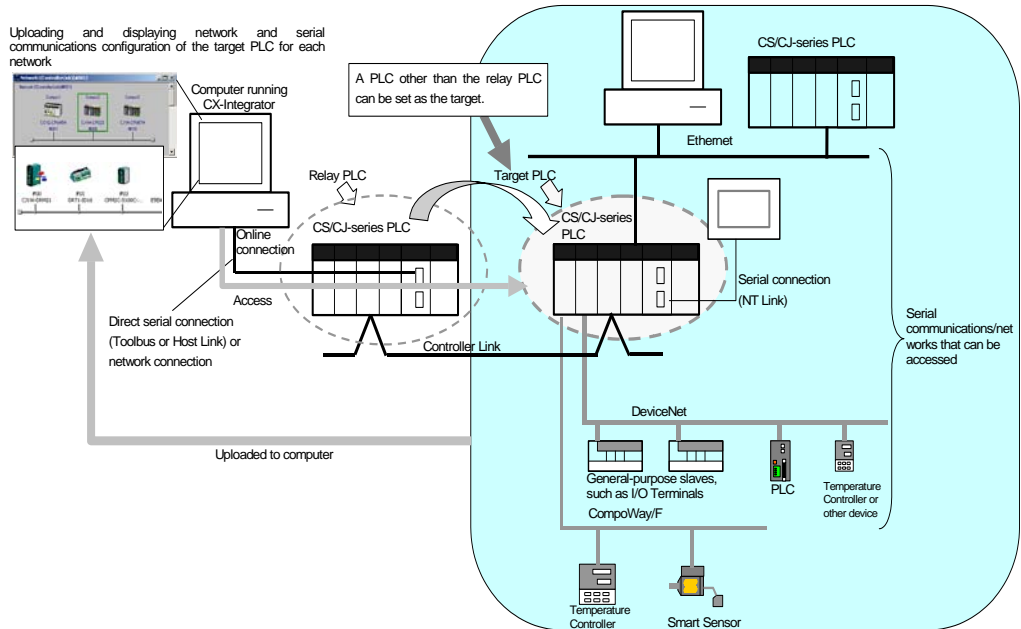

Direct connection from the CX-Integrator to serial communications using the CompoWay/F protocol is also possible using RS-232C or RS-485 communications without going through a PLC. The CompoWay/F network configuration can also be uploaded.

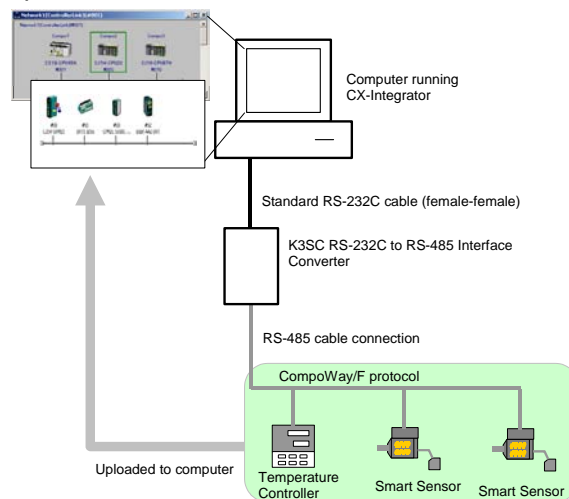

**1-1 The CX-Integrator**  
**1-1-2 Functions According to Network**

**1-1-2 Functions According to Network**

The functions for each network are listed in the following table.

Network	Functions
DeviceNet, CompoNet, or CompoWay/F	A virtual network or virtual serial communications configuration can be created offline and connected device parameters can be set, and data can be uploaded, downloaded, and compared when online.
Controller Link or SYSMAC LINK	User-set data link tables can be created offline and then transferred online to CS/CJ-series PLCs. Data link parameters can be set automatically online and then transferred to CS/CJ-series PLCs.
Controller Link	A Controller Link Network Diagnostic Tool can be started to diagnose Controller Link networks.
Ethernet	Broadcast node searches and ping tests are enabled (with CX-Integrator Ver. 1.1 or higher).
NT Link	Settings for an NS-series PT with a model number ending in V1 or later serially connected to a CS/CJ-series PLC via NT Link can be automatically detected and set for the serial port of the CS/CJ-series PLC. This is called NT Link Auto Online Setting function.
FINS networks, such as Ethernet, Controller Link, SYSMAC LINK, and DeviceNet	Routing tables can be set offline and then transferred online to CS/CJ-series PLCs. Echoback tests between nodes are enabled (with CX-Integrator Ver. 1.1 or higher).

**1-1-3 Connecting to the Relay PLC**

Either of the following methods can be used to connect the CX-Integrator online to the relay PLC.

Serial communications (Toolbus or Host Link Mode)

FINS network communications, such as Controller Link<sup>1</sup>, SYSMAC LINK<sup>1</sup>, Ethernet, Ethernet FINS/TCP, or FinsGateway<sup>2</sup> (See note.)

**Note:** If the computer running the CX-Integrator is connected directly to a network, the network address and node can be specified to set any PLC on the local network or an interconnected network as the relay PLC.

**\*1:** When running the CX-Integrator on Windows Vista or Window 7, an online connection will not be possible to the relay PLC even if communications for one of these networks is selected.

**\*2:** If FinsGateway is selected, connection will not be possible to a DeviceNet, CompoNet, or CompoWay/F network. To connect to any of these networks, use Ethernet, Ethernet (FINS/TCP), Controller Link, or SYSMAC LINK instead of FinsGateway.



## 1-1-4 Accessible Network

The network configuration of the target PLC (i.e., either the relay PLC or a PLC connected to the relay PLC) can be uploaded and monitored for each of the following networks.

### Accessible Networks

Network	Conditions
Ethernet <sup>*1</sup>	Monitoring and editing parameters is possible for all CS/CJ-series PLCs and NSJ-series NSJ Controllers on the Ethernet network. Only monitoring the network configuration is possible for CVM1/CV-series PLCs and computers with FinsGateway.
Controller Link <sup>*1</sup>	Monitoring and editing parameters is possible for all CS/CJ-series PLCs and NSJ-series NSJ Controllers on the Controller Link network. Only monitoring the network configuration is possible for C200HX/HG/HS PLCs, CVM1/CV-series PLCs, and computers with FinsGateway.
SYSMAC LINK <sup>*1</sup>	Monitoring and editing parameters is possible for all CS-series PLCs on the SYSMAC LINK network. Only monitoring the network configuration is possible for C200HX/HG/HS PLCs, CVM1/CV-series PLCs, and computers with FinsGateway.
DeviceNet	Monitoring and editing parameters is possible for all CS/CJ-series DeviceNet Units and NSJ-series NSJ Controllers. Only setting the DeviceNet Master Unit is possible for C200H-series DeviceNet Master Unit and CVM1/CV-series DeviceNet Master Units.
CompoNet <sup>*2</sup>	Parameter and monitor editing is only supported only for CS/CJ-series CompoNet Master Units and CompoNet Slave Units.

\*1 These networks are not supported for NJ-series CPU Units.

\*2 With an NJ-series CPU Unit, a CPU Unit with version 1.01 or later and a CJ-series CompoNet Master Unit with unit version 1.3 or later are required.

### Accessible Serial Communications

Serial communications	Conditions
CompoWay/F	The serial communications mode of the serial port must be Serial Gateway Mode or Protocol Macro Mode. (See note.) Note: To use the built-in serial ports on CS/CJ-series CPU Units, unit version 3.0 or later must be used. For Serial Communications Boards and Serial Communications Units, unit version 1.2 or later must be used. Monitoring and parameter editing is possible only for CompoWay/F slaves for which CPS files have been installed on the computer running the CX-Integrator. (If the CompoWay/F slave is a Temperature Controller, however, only monitoring the network configuration is possible. Parameters are edited using the CX-Thermo.)
NT Link	The serial communications mode of the serial port must be 1:N NT Link. Monitoring is possible only for NS-series PTs with model numbers ending in V1 or later. (Monitoring is not possible for earlier NS-series PTs without a model number suffix or for NT-series PTs.)

## **Local Network Table Requirements**

A local network table must be registered in the target PLC in the following cases.

<b>Communications</b>	<b>Conditions</b>
Network communications	<ul style="list-style-type: none"> <li>• More than one Network Communications Unit is mounted to the target PLC. (See note.)</li> </ul> <p>Note: In this context, the following are Network Communications Units: Ethernet Unit, Controller Link Unit, SYSMAC LINK Unit, DeviceNet Unit, FL-net Unit, EtherNet/IP Unit, or built-in EtherNet/IP port. Serial Communications Units and Serial Communications Boards are not included except in the following case: If serial ports are registered in the local network table to treat them as networks, the serial ports must be treated as Network Communications Units, including the serial ports on the CPU Unit. EtherNet/IP Units and built-in EtherNet/IP ports are treated as Ethernet Units.</p> <ul style="list-style-type: none"> <li>• Routing tables are already registered in one or more nodes on the network.</li> <li>• Communications are required between networks.</li> </ul>
Serial communications	<p>Serial ports on Serial Communications Units and Serial Communications Boards are used as serial gateways to Host Link FINS and access is required via networks via Host Link FINS to PLCs functioning as Host Link slaves.</p> <p>Note: Serial ports do not necessarily need to be registered in the local network table (to treat them as networks) to enable using other serial gateway functions. Registration is normally not required to convert from serial to serial. Refer to <i>3-6 Overview of Serial Gateway Functions in the CS/CJ-series Communications Commands Reference Manual</i> for details on whether local network tables are required to use serial gateway functions.</p>

**Note:** As an exception, local network tables are not required even when more than one Network Communications Unit is mounted in the following situation:

Access is possible without a local network table when connecting online to the target PLC via a direct serial connection and access is required only to the network of the Network Communications Unit with the smallest unit number (set on the front panel rotary switches) of all the Network Communications Units that are mounted to the target PLC.

### 1-1-5 Communicating Across Network Layers

If relay network routing tables are set in the CPU Units of the PLCs, a PLC on a different network layer than the network of the PLC connected to the CX-Integrator can be set as the target PLC to enable uploading, saving, and comparing the network configuration of the target PLC.

Uploading and displaying network and serial communications configuration of a target PLC on a remote network for each network

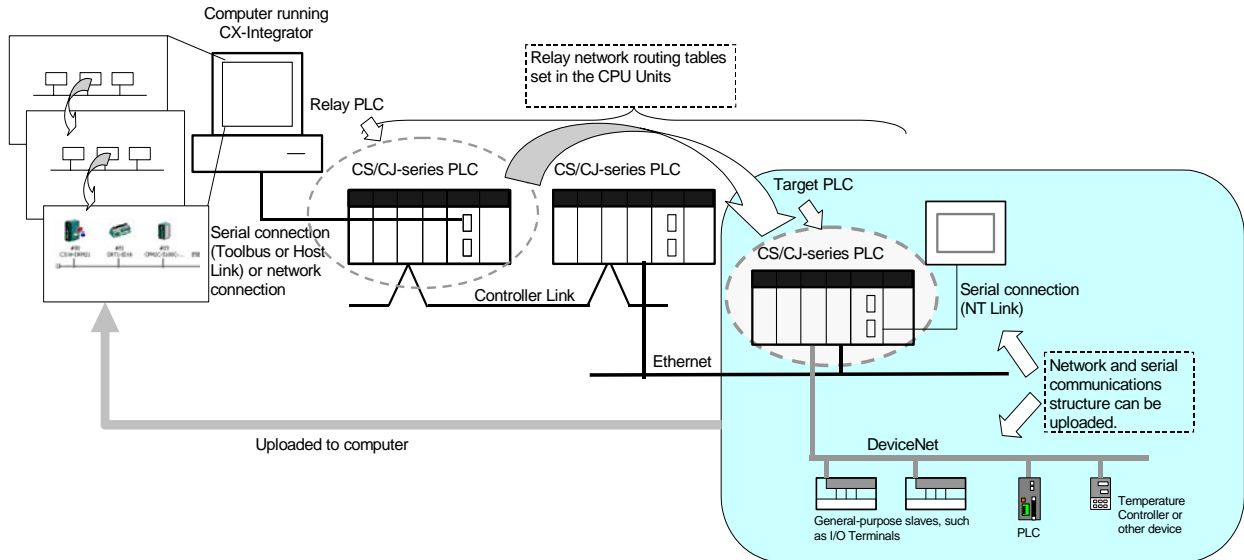

### 1-1-6 Starting Other Applications

The following applications can be started from the CX-Integrator.

Application	Starting method
CX-Programmer	Right-click the desired CS/CJ-series PLC in the Network Configuration Window and select <b>Start Special Application</b> from the pop-up menu.
Data Link Component	Either select <b>Tools – Start Data Link</b> or right-click the desired Controller Link Unit in the Online Connection Information Window and select <b>Start Data Link</b> from the pop-up menu.
Routing Table Component	Either select <b>Tools – Start Routing table</b> or right-click the desired Communication Unit/port in the Online Connection Information Window and select <b>Start Routing table</b> from the pop-up menu.
Controller Link Network Diagnostic Tool	Select <b>Tools – Controller Link tool – Network diagnosis</b> .
CX-Designer	Right-click the desired NS-series PT in the Network Configuration Window and select <b>Start Special Application</b> from the pop-up menu.
CX-Thermo	Right-click the desired OMRON Temperature Controller in the Network Configuration Window and select <b>Start Special Application</b> from the pop-up menu.
CX-Drive	Right-click the desired Inverter or Servo in the Network Configuration Window and select <b>Start Special Application</b> from the pop-up menu.

**1-2 Specifications**  
**1-2-1 CX-Integrator Specifications**

# 1-2 Specifications

## 1-2-1 CX-Integrator Specifications

Item	Specification			
Model	Provided in the CX-One FA Integrated Tool Package (CXONE-AL□□C-V4/ CXONE-AL□□D-V4).			
Setup media	CXONE-AL□□C-V4: CD-ROM CXONE-AL□□D-V4: DVD-ROM			
Applicable computers (with FinsGateway)	Refer to the <i>CX-One Setup Manual (W463)</i> for the specifications required for computers to use the CX-Integrator. Note: To use CX-Integrator version 2.2 or higher, the display resolution must be XGA or better.			
PLCs that can be used as relay PLC for online connections  Note: A relay PLC is the PLC to which the CX-Integrator is connected online.	Series	Device type (See note 1.)	CPU Unit model	
	NJ Series	NJ	NJ501-1300/1400/1500, NJ301-1100/1200	
	CS Series	CS1H	CS1H-CPU67/66/65/64/63(-V1)	
		CS1G/CJ1G	CS1G-CPU45/44/43/42(-V1)	
		CS1G-H	CS1G-CPU45H/44H/43H/42H	
		CS1H-H	CS1H-CPU67H/66H/65H/64H/63H	
		CS1D-H	CS1D-CPU67H/65H (See note 2.)	
		CS1D-S	CS1D-CPU67S/65S/44S/42S	
	CJ Series	CJ2H	CJ2H-CPU6□(-EIP)	
		CJ2M	CJ2M-CPU□□	
		CS1G/CJ1G	CJ1G-CPU45/44	
		CJ1M	CJ1M-CPU23/22/21/13/12/11	
		CJ1G-H	CJ1G- CPU45H/44H/43H/42H	
		CJ1H-H	CJ1H-CPU67H/66H/65H	
			CJ1H-CPU67H-R/66H-R/65H-R/64H-R	
	CP-Series (See note 3.)	CP1H-XA	CP1H-XA□□□□-□	
		CP1H-X	CP1H-X□□□□-□	
		CP1H-Y	CP1H-Y□□□□-□	
		CP1L-M	CP1L-M□□□□-□	
		CP1L-L	CP1L-L□□□□-□	
		CP1L-EM	CP1L-EM□□□□-□	
		CP1L-EL	CP1L-EL□□□□-□	
	NSJ Series	NSJ	G5D (Used for the NSJ5-TQ0□-G5D, NSJ5-SQ0□-G5D, NSJ8-TV0□-G5D, NSJ10-TV0□-G5D, and NSJ12-TS0□-G5D.)	
			M3D (Used for NSJ5-TQ0□-M3D, NSJ5-SQ0□-M3D, and NSJ8-TV0□-M3D.)	
	<p>Note 1: To connect the computer running CX-Integrator directly as a CompoWay/F slave, set the Device type to <i>CompoWay/F Device</i>.</p> <p>Note 2: When using a pre-Ver. 1.1 CS1D-H CPU Unit, use it as if it were a CS1H-H CPU Unit.</p> <p>Note 3: Use commercially available USB cable (B type to A type connectors) for connecting CP-series CPU Units.</p>			

**1-2 Specifications**  
**1-2-1 CX-Integrator Specifications**

Item	Specification
Connecting to the Relay PLC	<p>Either of the following can be used.</p> <p><b>Serial communications</b></p> <p>Direct connection is possible to any of the following serial ports on a CS/CJ/CP-series PLC.</p> <ul style="list-style-type: none"> <li>• CPU Unit USB port (Toolbus)</li> <li>• CPU Unit peripheral port (Toolbus or Host Link)</li> <li>• CPU Unit RS-232C port (Toolbus or Host Link)</li> <li>• A CP-series CPU Unit is connected to the USB port using a commercially available USB cable (type B – type A).</li> <li>• Serial Communications Board or Serial Communications Unit RS-232C port or RS-422A/485 port (Host Link) (See note.)</li> </ul> <p>Note: For a CP-series CPU Unit, connect to a CP1W-CIF01/11 Option Board (Toolbus or Host Link).</p> <p>Direct connection is possible to any of the following serial ports on an NSJ-series NSJ Controller.</p> <ul style="list-style-type: none"> <li>• RS-232C port A (Toolbus) on NSJ Controller</li> <li>• RS-232C port B (Toolbus) on NSJ Controller</li> <li>• USB port on NSJ Controller</li> </ul> <p>Note: Automatic online connection is possible for serial communications ports. (The user does not have to set the computer communications settings.) The communications settings will be automatically set to those of the PLC. Connection is possible to a serial port on the CPU Unit, a Serial Communications Board, or a Serial Communications Unit. For PLC serial ports, however, only the Toolbus or Host Link serial communications modes can be used and the baud rate must be 9600, 19200, 38400, or 115200 bits/s.</p>
	<p><b>FINS network communications</b></p> <p>Direct connection is possible through any of the following networks on a CS/CJ-series PLC or NSJ-series NSJ Controller.</p> <ul style="list-style-type: none"> <li>• Ethernet (Ethernet, Ethernet FINS/TCP, or FinsGateway<sup>2</sup>)</li> <li>• Controller Link (Controller Link<sup>1</sup> or FinsGateway<sup>2</sup>)</li> <li>• SYSMAC LINK (SYSMAC LINK<sup>1</sup> or FinsGateway<sup>2</sup>)</li> </ul> <p>Direct connection is possible through any of the following networks on an NJ-series Controller.</p> <ul style="list-style-type: none"> <li>• Ethernet (Ethernet, Ethernet FINS/TCP, or USB)</li> </ul>

- \*1:** When running the CX-Integrator on Windows Vista or Windows 7, an online connection will not be possible to the relay PLC even if communications for one of these networks is selected.
- \*2:** If FinsGateway is selected, connection will not be possible to a DeviceNet, CompoNet, or CompoWay/F network. To connect to any of these networks, use Ethernet, Ethernet (FINS/TCP), Controller Link, or SYSMAC LINK instead of FinsGateway.

## 1-2 Specifications

### 1-2-1 CX-Integrator Specifications

Item	Specification			
PLCs that are accessible as target PLCs  Note: The target PLC is the PLC actually being accessed, e.g., to upload/download the PLC's network configurations.	Series	Device type	CPU Unit model	
	NJ Series	NJ	NJ501-1300/1400/1500, NJ301-1100/1200	
	CS Series	CS1H	CS1H-CPU67/66/65/64/63(-V1)	
		CS1G/CJ1G	CS1G-CPU45/44/43/42(-V1)	
		CS1G-H	CS1G-CPU45H/44H/43H/42H	
		CS1H-H	CS1H-CPU67H/66H/65H/64H/63H	
		CS1D-H	CS1D-CPU67H/65H Note: When using a pre-Ver. 1.1 CS1D-H CPU Unit, use it as if it were a CS1H-H CPU Unit.	
	CJ Series	CJ2H	CJ2H-CPU6□(-EIP)	
		CJ2M	CJ2M-CPU□□	
		CS1G/CJ1G	CJ1G-CPU45/44	
CJ1M		CJ1M-CPU23/22/21/13/12/11		
CJ1G-H		CJ1G-CPU45H/44H/43H/42H		
CJ1H-H		CJ1H-CPU67H/66H/65H CJ1H-CPU67H-R/66H-R/65H-R/64H-R		
CP-Series	CP1H-XA	CP1H-XA□□□□-□		
	CP1H-X	CP1H-X□□□□□-□		
	CP1H-Y	CP1H-Y□□□□□-□		
	CP1L-M	CP1L-M□□□□□-□		
	CP1L-L	CP1L-L□□□□□-□		
	CP1L-EM	CP1L-EM□□□□□-□		
	CP1L-EL	CP1L-EL□□□□□-□		
NSJ Series	NSJ	G5D (Used for the NSJ5-TQ0□-G5D, NSJ5-SQ0□-G5D, NSJ8-TV0□-G5D, NSJ10-TV0□-G5D, and NSJ12-TS0□-G5D.) M3D (Used for NSJ5-TQ0□-M3D, NSJ5-SQ0□-M3D, and NSJ8-TV0□-M3D.)		
Note: The CS/CJ-series PLC must have a lot number of 030201 or later (manufactured 1 February 2003 or later) to start the CX-Designer and transfer screen data to an NS-series PT from the CX-Designer through the PLC. The following PLCs can be used: CS1G-H, CS1H-H, CS1D-S, CJ1M, or CJ1H-H. (The CS1D-H cannot be used.)				
Windows	<ul style="list-style-type: none"> <li>• Network Configuration Window: Connected component configuration for each type of communications.</li> <li>• System Overview: Interconnections between networks</li> </ul>			
Supported communications	The following communications are possible for a directly connected target PLC.			
	Supported network communications	<ul style="list-style-type: none"> <li>• Ethernet (Access is possible only to CS/CJ-series PLCs, NS-series PTs, and computers with FinsGateway on the Ethernet network. For CVM1/CV-series PLCs, only display functions are supported.) Note: With a CJ2H-CPU6□-EIP or CJ2M-CPU3□ CPU Unit, connecting to an Ethernet network is not possible from the built-in EtherNet/IP port or an EtherNet/IP Unit port if the network connection is set for EtherNet/IP. Always set Ethernet or Ethernet (FINS/TCP) to connect to an Ethernet network.</li> <li>• Controller Link (Access is possible only to CS/CJ/CP-series PLCs, NS-series PTs, and computers with FinsGateway on the Controller Link network.) For C200H-series PLCs and CVM1/CV-series PLCs, only display functions are supported.) Note: When the Controller Link Network Diagnosis application is being used, it is possible to monitor and troubleshoot PLC models in the Controller Link network other than CS/CJ-series PLCs.</li> <li>• SYSMAC LINK (Monitoring is possible only to CS/CJ-series PLCs, NS-series PTs, and computers with FinsGateway on the SYSMAC LINK network.)</li> <li>• DeviceNet (CS/CJ-series DeviceNet Units, C200H DeviceNet Master Units, or CVM1/CV-series DeviceNet Master Units) Note: A C200H-DRM21-V1 or CVM1-DRM21-V1 DeviceNet Master Unit can be used through a CS/CJ-series DeviceNet Unit.</li> <li>• CompoNet (CS/CJ-series CompoNet Master Units)</li> <li>• The EtherNet/IP network cannot be used.</li> </ul>		

**1-2 Specifications**  
**1-2-1 CX-Integrator Specifications**

Item	Specification	
Supported communications	Supported serial communications	<ul style="list-style-type: none"> <li>• CompoWay/F (CS/CJ-series CPU Units must be unit version 3.0 or later.) Serial Communications Boards and Serial Communications Units must be unit version 1.2 or later. Only slaves for which CPS files are installed on the computer can be accessed.</li> <li>• NT Links (Connection is possible only for NS-series PTs with model numbers ending in V1 or later.) Note: For the CJ2 CPU Units, connection is impossible when "USB" is selected in the network settings. Select "USB (Toolbus)".</li> </ul>
	Note: Accessing PLC Communications Across Network Layers If relay network routing tables are set, a PLC on a different network layer than the network of the PLC connected to the CX-Integrator can be set as the target PLC.	
Online Connection Information Window	When the target PLC is online, Communications Units connected to the target PLC (referred to here as simple "Communications Units") are displayed as follows: Target Device, Target PLC CPU Unit model (network address) (node address) <ul style="list-style-type: none"> <li>• CPU Unit name [model] (network address) (-) (serial port FINS unit address)</li> <li>• Communications Unit name [model] (network address) (node address) (unit number)</li> <li>• Communications Unit name [model] (network address) (node address) (unit number)</li> </ul> Communications configuration information can be uploaded by right-clicking a Communications Unit and selecting <b>Transfer – Network to PC</b> .	
Communications monitoring functions	Ethernet	Node information for FINS communications (CPU Unit model, Ethernet Unit mode, node address, and network address)
	Controller Link	Information on nodes participating in the Controller Link network (CPU Unit model, Controller Link Unit mode, node address, and network address)  The following functions are also possible if the Controller Link Network Diagnostic Tool is started. Configuration node diagnosis (network participation status, current Controller Link Unit errors, current CPU Unit errors, and differences from node files), setting diagnosis (e.g., DM Area parameter setting consistency), line disconnection information diagnosis, transmission status diagnosis, node status (displaying current error status and error log), error log collection, and node file editing (node names, connection order, and Repeater Units)
	SYSMAC LINK	Information on nodes participating in the SYSMAC LINK network (CPU Unit model, Controller Link Unit mode, node address, and network address)
	DeviceNet	Information on nodes connected to DeviceNet for which EDS files are installed on the computer (DeviceNet Unit model, slave model, master/slave node addresses)
	CompoNet	Information on nodes connected to CompoNet for which DTM is installed on the computer (CompoNet Master Unit models, Slave Unit models, Master/Slave Unit status)
	CompoWay/F	Information on nodes connected to a serial port in serial gateway mode or protocol macro mode for which CPS files are installed on the computer (CompoWay/F SLAVE model and CompoWay/F node address). Note: CS/CJ-series CPU Units with unit version 3.0 or later, or Serial Communications Boards/Units with unit version 1.2 or later, or CP-series Communications Option Boards must be used.
	NT Link	Information on nodes connected to 1:N NT Links (NS-series PT model and NT Link unit number) Note: Automatic detection of NS-series PTs connected serially to a CS/CJ-series PLC is also possible. (The NT Link Automatic Setting Function automatically changes the setting of the PLC's serial port to match those of the NS-series PT.)

## 1-2 Specifications

### 1-2-2 Files Created by the CX-Integrator

Item	Specification	
Setting functions	Ethernet	Ethernet Unit settings (CPU Bus Unit System Settings)
	Controller Link	User-set data link tables
	SYSMAC LINK	Controller Link and SYSMAC LINK Unit settings (in allocated DM Area words), including automatically set data link parameters (transferred to the startup node set as the target PLC)
	DeviceNet	DeviceNet Unit master parameters (remote I/O allocations, connection settings, component information check, communications cycle time, etc.) Slave parameters
	CompoNet	CompoNet Master Unit parameters (Registration Table, message function enable/disable, settings of Input Data Clear Mode for Communications Errors, Manual Start Mode for remote I/O communications, Software Setting table) CompoNet Slave parameters
	CompoWay/F	CompoWay/F slave parameters (except for Temperature Controllers) Note: Parameters for CompoWay/F-compatible Temperature Controllers are set using the CX-Thermo, started as an application. PLC serial port communications settings (CPU Unit: part of PLC Setup, Serial Communications Boards/Units: allocated DM Area words)
	NT Link	None
	FINS networks, such as Ethernet, Controller Link, SYSMAC LINK, and DeviceNet	Routing tables (FINS local routing tables and FINS network routing tables) Note: The FINS local routing table is transferred to the target PLC.
Verification functions	Verifying communications/network configurations Verifying component parameters	
Operations	The following operations are possible for the CPU Unit at the target PLC. Creating, editing, and transferring I/O tables Displaying current errors and error logs Changing the operating mode Transferring or verifying a manually set data link table Transferring or verifying a routing table (FINS local routing table)	

### 1-2-2 Files Created by the CX-Integrator

The following files can be created by the CX-Integrator.

Files	Contents	Details
Project files (.cin)	Connection information to relay PLC, all network configurations for target PLC, and parameters for DeviceNet masters, DeviceNet slaves, CompoNet masters, CompoNet slaves, and CompoWay/F slaves	These files are used offline to check network configurations and parameters and for other purposes, such as printing. Each file consists of the following: Device type setting information of the relay PLC Communications Unit models connected to the target PLC (Ethernet Units, Controller Link Units, SYSMAC LINK Units, DeviceNet Units, and Serial Communications Boards/Units) Device models connected to the above CPU Units or Communications Units via communications (DeviceNet slaves, CompoNet slaves, CompoWay/F slaves, NS-series PTs, etc.) Parameters for DeviceNet Master Units and DeviceNet slaves (for all devices for which EDS files are installed on the computer, including slaves from other manufacturers) Parameters for CompoNet Master Units and CompoNet slaves (for all devices for which DTM is installed on the computer, including slaves from other manufacturers) Parameters for CompoWay/F slaves (for all components for which CPS files are installed on the computer (except for Temperature Controllers)) Controller Link network parameters Controller Link and SYSMAC LINK Unit allocated DM Area words settings, including automatically set data link parameters Ethernet Unit CPU Bus Unit System Settings Serial Communications Board/Unit serial communications settings Note: Routing tables (local network tables and relay network tables) and user-set data link tables are not included in project files.
Network configuration files	DeviceNet network structure files (.npf)	Network configuration for one DeviceNet network connected directly to the target PLC (including master and slave parameters) Note: These are the same as the DeviceNet network structure files (.npf) created with DeviceNet Configurator version 2.□. Files created with DeviceNet Configurator version 2.□ can be imported/exported.



**1-2 Specifications**  
**1-2-2 Files Created by the CX-Integrator**

Files	Contents	Details
Network configuration files	Controller Link node files (.crg)	Network configuration for Controller Link networks connected directly to the target PLC
Component parameter files	DeviceNet device parameter files (.dvv)	Parameters for individual DeviceNet devices (master or slave) Note: These are the same as the DeviceNet device parameter files (.dvv) created with DeviceNet Configurator version 2.□. Files created with DeviceNet Configurator version 2.□ can be imported.
	CompoWay/F component parameter files (.xml)	Parameters for individual CompoNet devices (master or slaves) Parameters for individual CompoWay/F slaves (except for Temperature Controllers) CPU Unit parameters (parts of PLC Setup: serial communications settings) Controller Link or SYSMAC LINK network parameters Controller Link and SYSMAC LINK Unit allocated DM Area words settings, including automatically set data link parameters Ethernet Unit CPU Bus Unit System Settings Serial Communications Board/Unit serial communications settings
Data link table files	Controller Link data link table files (.cl2)	Controller Link user-set data link tables Note: These are the same as the Controller Link data link table files (.cl2) created with the CX-Net. Files created with the CX-Net can be imported.
	SYSMAC LINK data link table files (.sl3)	SYSMAC LINK user-set data link tables Note: These are the same as the SYSMAC LINK data link table files (.sl3) created with the CX-Net. Files created with the CX-Net can be imported.
Routing table files	FINS local routing table files (.rtg, .rxg) (See note 2.)	Routing tables of the target PLC Note 1: These are the same as the FINS local routing table files (.rtg, .rxg) created with the CX-Net. Files created with the CX-Net can be imported. Note 2: Standard number of relay network table entries (20 max.): .rtg Extended number of relay network table entries (64 max.): .rxg
	FINS network routing table files (.rt3, .rx3) (See note 2.)	Routing tables for all PLCs on networks to which the target PLC belongs Note 1: These are the same as the FINS network routing table files (.rt3, .rx3) created with the CX-Net. Files created with the CX-Net can be imported. Note 2: Standard number of relay network table entries (20 max.): .rt3 Extended number of relay network table entries (64 max.): .rx3

**Note** With DeviceNet only, the following files can also be exported and saved.

- EDS files (.eds)
- The device list saved in CSV format (.csv)
- The I/O comments saved in CSV format (.csv)
- The device parameters of an OMRON DeviceNet Master Unit saved as an Open Network Controller DRM\_UNIT (virtual unit) file
- The device parameters of an OMRON DeviceNet Master Unit saved as a NetX Server (NetX Server for DeviceNet) file

**Note** The CX-Integrator does not support files created in the DeviceNet Configurator Ver. 1.0 file format.

## **1-3**    **Installation**

The CX-Integrator is installed from the CX-One Installer. Refer to the *CX-One Ver. 4.□ Setup Manual (W463)* for details.

# 1-4 PLC Connecting Cables

## 1-4-1 Direct Serial Connections to a PLC

When connecting the computer running the CX-Integrator directly to a PLC using a serial line, make the connection correctly using the following Connecting Cables and connection diagrams.

### Connecting Cables to CS/CJ-series PLCs

Unit	Unit port	Computer	Computer port	Network type (serial communications mode)	Model	Length	Remarks
CPU Unit	Built-in peripheral port	IBM PC/AT or compatible	D-sub 9-pin male	Peripheral bus (Toolbus) or Host Link (SYSWAY)	CS1W-CN226/626	2 m/6 m	---
	Built-in RS-232C port D-sub 9-pin female	IBM PC/AT or compatible	D-sub 9-pin male	Peripheral bus (Toolbus) or Host Link (SYSWAY)	XW2Z-200S-CV/ 500S-CV	2 m/5 m	Connector with ESD (electrostatic discharge) counter-measures used.
				Host Link (SYSWAY)	XW2Z-200S-V/ 500S-V	2 m/5 m	---
	USB port	IBM PC/AT or compatible	USB port	Peripheral bus (Toolbus)	---	---	---
Serial Communications Boards/Units	RS-232C port D-sub 9-pin female	IBM PC/AT or compatible	D-sub 9-pin male	Host Link (SYSWAY)	XW2Z-200S-CV/ 500S-CV	2 m/5 m	Connector with ESD (electrostatic discharge) counter-measures used.
					XW2Z-200S-V/ 500S-V	2 m/5 m	---

Refer to the following connection diagrams.

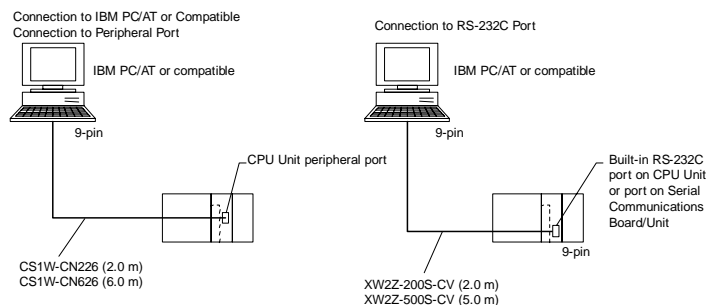

**Note**

- When using an RS-232C cable for the computer running CX-Integrator and connecting to a CS/CJ-series PLC with a Toolbus connection, use a XW2Z-200S-CV/500S-CV Connecting Cable. (This cable can be used only with IBM PC/AT or compatible computers.)
- The following connection methods can be used when connecting an RS-232C cable to a peripheral port on a CS/CJ-series PLC.

**1-4 PLC Connecting Cables**  
**1-4-1 Direct Serial Connections to a PLC**

Unit	Unit port	Computer	Computer port	Network type (serial communications mode)	Model	Length	Remarks
CPU Unit	Built-in peripheral port	IBM PC/AT or compatible	D-sub 9-pin male	Peripheral bus (Toolbus) or Host Link (SYSWAY)	CS1W-CN118 + XW2Z-200S-CV/500S-CV	0.1 m + 2 m/5 m	The XW2Z-□□□S-CV uses a connector with ESD (electrostatic discharge) counter-measures.
		IBM PC/AT or compatible	D-sub 9-pin male	Host Link (SYSWAY)	CS1W-CN118 + XW2Z-200S-V/500S-V	0.1 m + 2 m/5 m	---

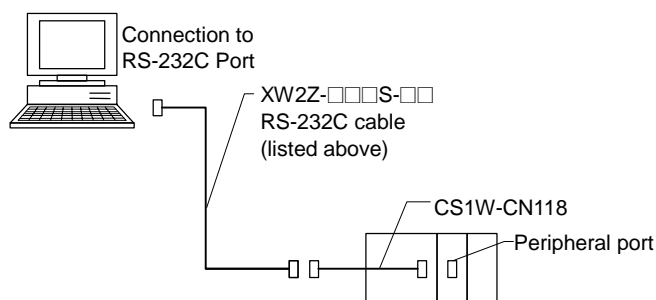

**Note** The following connection methods can be used when connecting an CQM1-CIF01/02 cable to a peripheral port on a CS/CJ-series PLC.

Unit	Unit port	Computer	Computer port	Network type (serial communications mode)	Model	Length	Remarks
CPU Unit	Built-in peripheral port	IBM PC/AT or compatible	D-sub 9-pin male	Host Link (SYSWAY) Note: Baud rate must be 19.2 Kbits/s or less.	CS1W-CN114 + CQM1-CIF02	0.05 m + 3.3 m	---

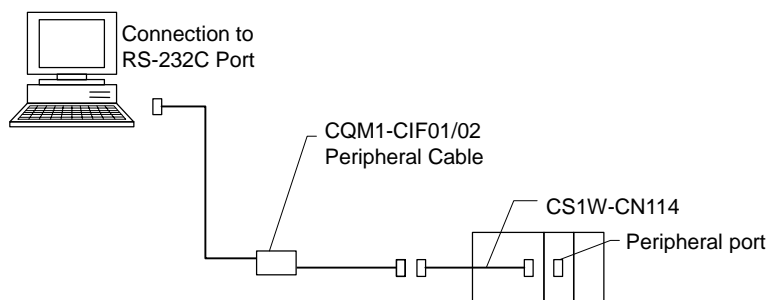

## 1-4 PLC Connecting Cables

### 1-4-1 Direct Serial Connections to a PLC

**Note** Connecting the PLC Using a USB Port on the Computer

A USB port on the computer can be used to connect the computer running the CX-Integrator to a CS/CJ-series PLC. To do so, connect the computer to the PLC as shown below using a CS1W-CIF31 USB-Serial Conversion Cable.

The driver software included with the CJ1W-CIF31 must be installed on the computer to use a USB port to connect the CX-Integrator. Refer to the PDF User's Manual included with the CS1W-CIF31 USB-Serial Conversion Cable for details.

When connecting the computer to a CP-series PLC, it is possible to make a direct connection using a commercially available USB cable (B type – A type connectors).

#### PLC Connection Methods

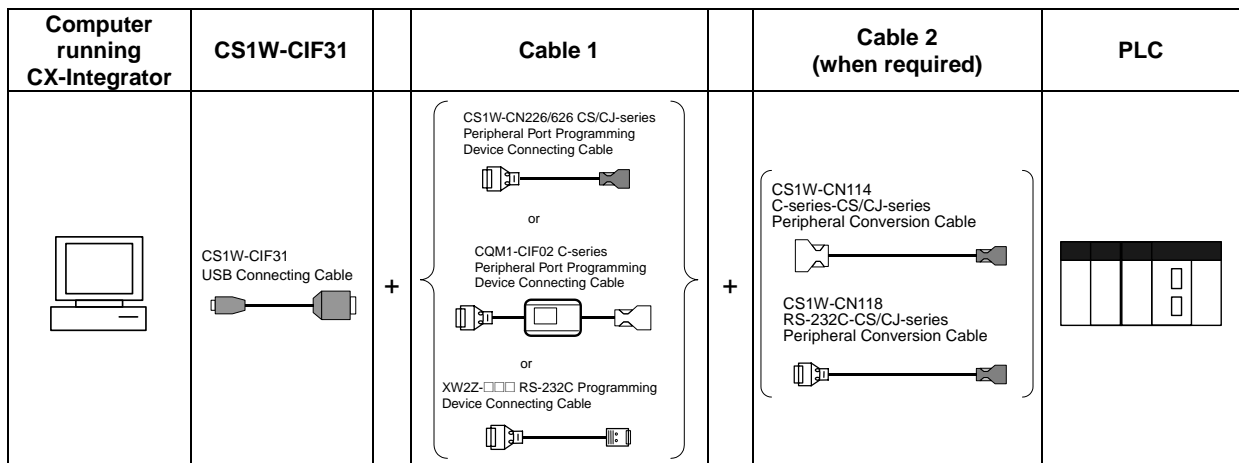

#### CS/CJ-series CPU Unit Connection Patterns

USB Connecting Cable	Cable 1			Cable 2			Port	Serial communications mode (network type)
	Model	Connector	Model	Connector	Connector	Model		
CS1W-CIF31	D-sub 9-pin female	CS1W-CN226/626 (length: 2 m/6 m)	CS/CJ peripheral	Not needed.			CS/CJ peripheral	Peripheral (Toolbus) or Host Link (SYSWAY)
	D-sub 9-pin female	CQM1-CIF02 (length: 3.3 m)	C peripheral	C peripheral	CS1W-CN114 (length: 5 cm)	CS/CJ peripheral		Host Link (SYSWAY)
	D-sub 9-pin female	XW2Z-200S-CV /500S-CV (length: 2 m/5 m)	D-sub 9-pin male	D-sub 9-pin female	D-sub 9-pin female	CS1W-CN118 (length: 0.1 m)	CS/CJ peripheral	Peripheral (Toolbus) or Host Link (SYSWAY)
	D-sub 9-pin female	XW2Z-200S-V /500S-V (length: 2 m/5 m)	D-sub 9-pin male	D-sub 9-pin female	D-sub 9-pin female	CS1W-CN118 (length: 0.1 m)	CS/CJ peripheral	Host Link (SYSWAY)
	D-sub 9-pin female	XW2Z-200S-CV /500S-CV (length: 2 m/5 m)	RS-232C D-sub 9-pin male	Not needed.			RS-232C D-sub 9-pin female	Peripheral (Toolbus) or Host Link (SYSWAY)
	D-sub 9-pin female	XW2Z-200S-V /500S-V (length: 2 m/5 m)	RS-232C D-sub 9-pin male	Not needed.				Host Link (SYSWAY)

**1-4 PLC Connecting Cables**  
**1-4-1 Direct Serial Connections to a PLC**

Connection diagrams are shown below.

**Connecting to the Peripheral Port**

- Using the CS1W-CN226/626 Connecting Cable

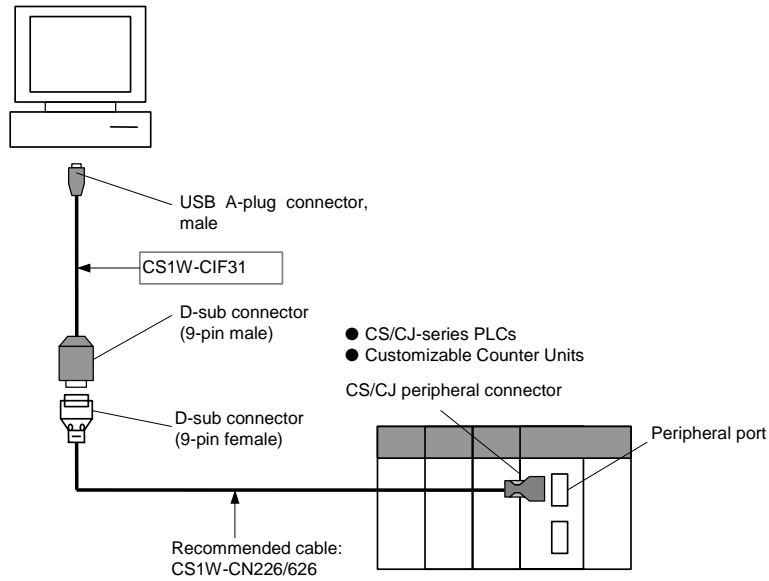

- Using the CQM1-CIF02 Connecting Cable

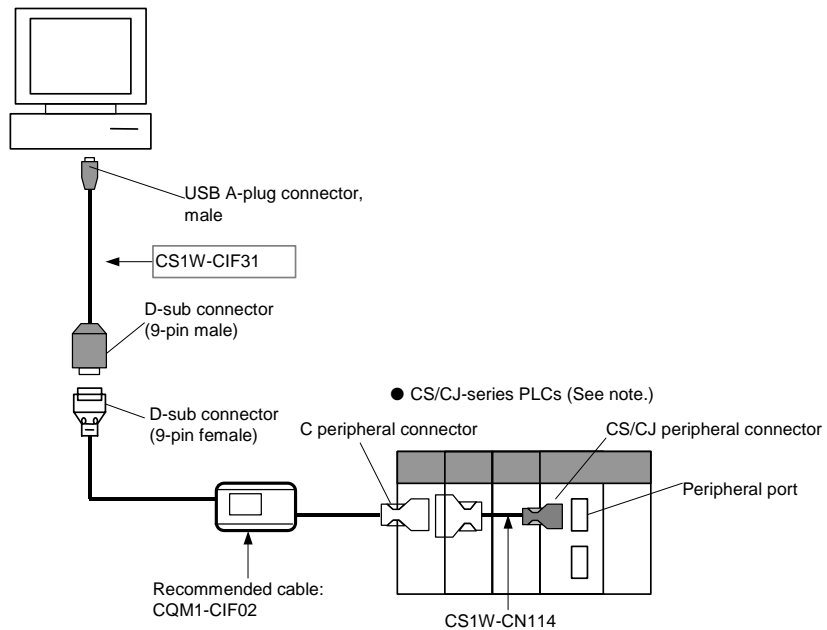

**Note:** Only a Host Link connection is possible for CS/CJ-series PLCs.

## 1-4 PLC Connecting Cables

### 1-4-1 Direct Serial Connections to a PLC

- Using the XW2Z-200S-CV/500S-CV or XW2Z-200S-V/500S-V Connecting Cable for RS-232C

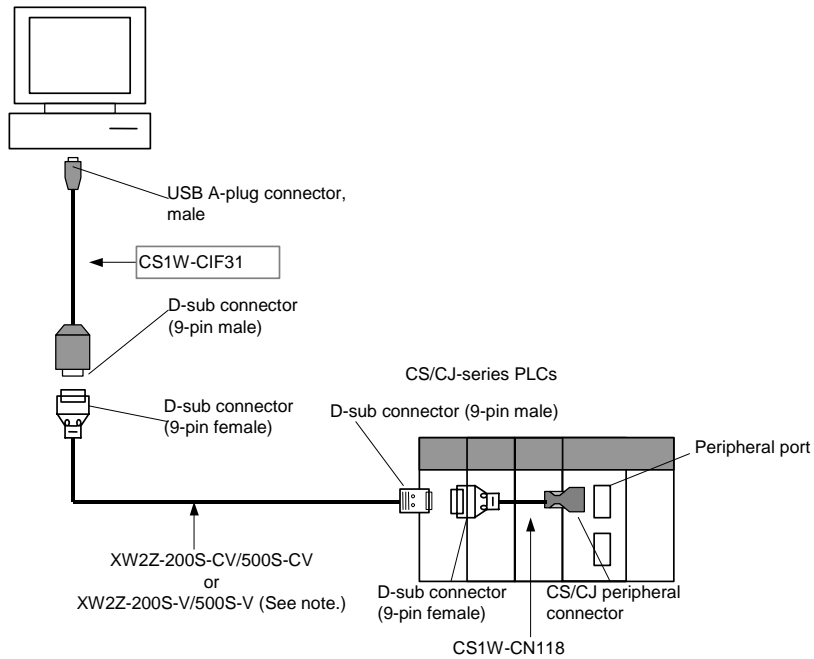

**Note:** Only a Host Link connection is possible for CS/CJ-series PLCs.

- Using the XW2Z-200S-CV/500S-CV or XW2Z-200S-V/500S-V Connecting Cable for RS-232C

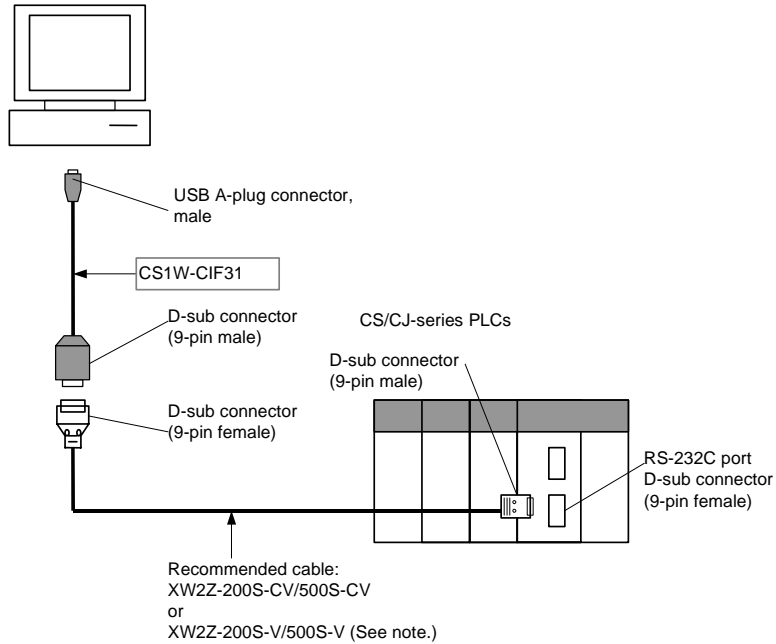

**Note:** Only a Host Link connection is possible for CS/CJ-series PLCs.

**1-4 PLC Connecting Cables**  
**1-4-1 Direct Serial Connections to a PLC**

**Connecting Cables for CP-series PLCs**

**Connecting to USB Port in CPU Unit Using Commercially Available USB Cable**

Unit	Port at Unit	Computer	Port at computer	Network type (serial communications mode)	Model	Length	Remarks
CPU Unit	USB port (B connector)	DOS/V	USB port (A connector)	USB	Cable for USB 1.1 or 2.0	5 m max.	---

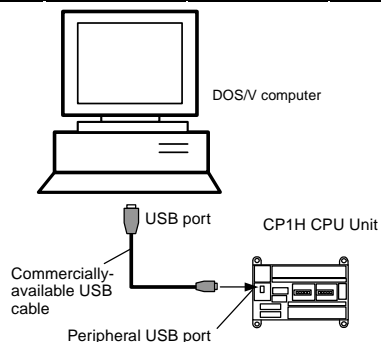

**Connecting by RS-232C Cable to the RS-232C Port in a Serial Communications Option Board**

Unit	Unit port	Computer	Computer port	Network type (serial communications mode)	Model	Length	Remarks
CP1W-CIF01 Serial Option Board	RS-232C port, D-SUB 9-pin, female	IBM PC/AT or compatible	D-SUB 9-pin, male	Peripheral (Toolbus) or Host Link (SYSWAY)	XW2Z-200S-CV/ 500S-CV	2 m/ 5 m	Connect or with ESD (electrostatic discharge) counter-measure used.
				Host Link (SYSWAY)	XW2Z-200S-V/ 500S-V	2 m/ 5 m	---



1-4-2 Connecting CJ-series CJ2 CPU Units, CP-series PLCs, NSJ-series Controllers, and NJ-series Controllers Using Commercially Available USB Cable

1-4-2 Connecting CJ-series CJ2 CPU Units, CP-series PLCs, NSJ-series Controllers, and NJ-series Controllers Using Commercially Available USB Cable

A computer running the CX-One can be connected to the peripheral USB port on a CJ-series CJ2 CPU Units or a CP-series PLC or to the USB connector (SLAVE) on an NSJ-series Controller using commercially available USB cable. The procedures are provided in this section.

**Restrictions when Connecting by USB**

Due to USB specifications, the following restrictions apply when connecting a computer running Support Software.

- A USB connection is possible for only one CP-series PLC from a single computer. It is not possible to connect multiple CP-series PLCs or an NSJ-series Controller simultaneously.
- Do not disconnect the USB cable while the Support Software is connected online. Before disconnecting the USB cable, be sure to place the application in offline status. If the USB cable is disconnected while online, the situations described below will occur.  
The Support Software cannot be returned to online status by simply reconnecting the USB cable. First return the Support Software to offline status, and then reconnect the USB cable. Then perform the online connection procedure for the Support Software.
- While a computer and a CJ2/CP-series PLC is connected via a USB cable, the computer cannot be placed in standby status.

**CJ-series CJ2 CPU Units**

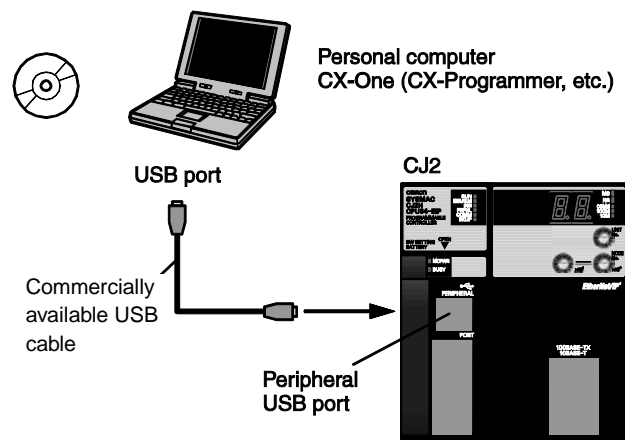

The peripheral USB port (conforming to USB 1.1, B connector) is a dedicated port for connecting Support Software, such as the CX-Programmer.

## 1-4 PLC Connecting Cables

### 1-4-2 Connecting CJ-series CJ2 CPU Units, CP-series PLCs, NSJ-series Controllers, and NJ-series Controllers Using Commercially Available USB Cable

#### CP-series PLCs

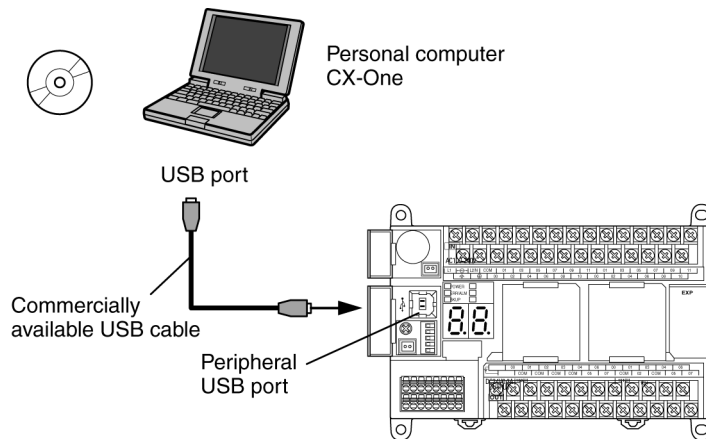

The peripheral USB port (conforming to USB 1.1, B connector) is a dedicated port for connecting Support Software, such as the CX-One (e.g., CX-Programmer).

#### NSJ-series Controllers

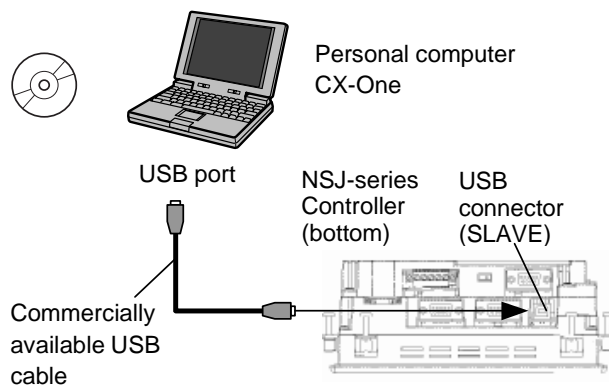

The USB port (SLAVE, conforming to USB 1.1, B connector) is a dedicated port for connecting Support Software, such as the CX-One (e.g., CX-Designer and CX-Programmer).

#### NJ-series Controllers

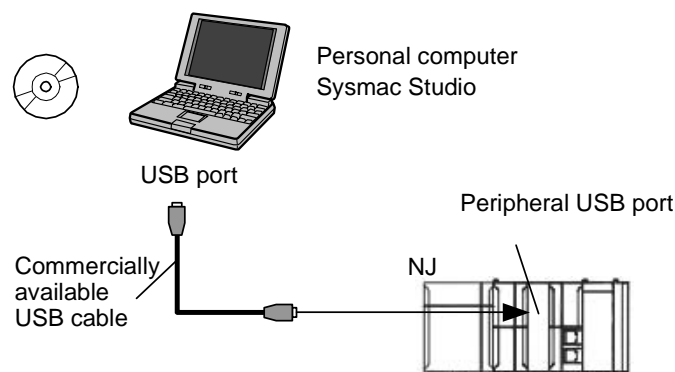

The peripheral USB port is a special port that is used to connect software in the Sysmac Studio Package (including the CX-Designer and CX-Protocol). (It has a USB 1.1 B-type connector.)

1-4-2 Connecting CJ-series CJ2 CPU Units, CP-series PLCs, NSJ-series Controllers, and NJ-series Controllers Using Commercially Available USB Cable

Items Required for USB Connection

Operating system	Windows 2000, XP, Vista, or 7
Support Software	CX-One (e.g., CX-Designer and CX-Programmer)
USB driver	Included with above Support Software.
USB cable	USB 1.1(or 2.0) cable (A connector-B connector), 5 m max.

**Installing the USB Driver**

Use the following procedure when connecting the personal computer to the peripheral USB port for the first time. It is assumed that the Support Software has already been installed.

**Windows 2000, Vista, or 7**

1. Turn ON the power supply to the PLC and connect the peripheral USB port on the PLC to the personal computer using a USB cable. The USB driver will be automatically installed when the cable is connected.



**Note:** If the software is not automatically installed, refer to *Installing a Specified USB Driver* later in this section.

**Windows XP**

1. Turn ON the power supply to the PLC and connect the peripheral USB port on the PLC to the personal computer using a USB cable. The computer will automatically detect the device when the cable is connected and display the following message.

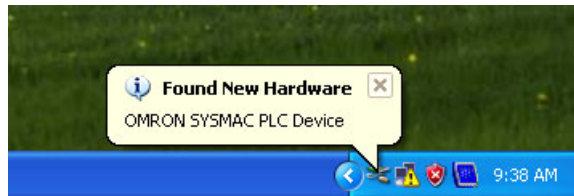

2. The following dialog box will be displayed. Select one of the options and click the **Next Button**.



**1-4 PLC Connecting Cables**  
**1-4-2 Connecting CJ-series CJ2 CPU Units, CP-series PLCs, NSJ-series Controllers, and NJ-series Controllers Using Commercially Available USB Cable**

3. The following dialog box will be displayed. Select the *Install the software automatically (Recommended)* Option and click the **Next** Button.

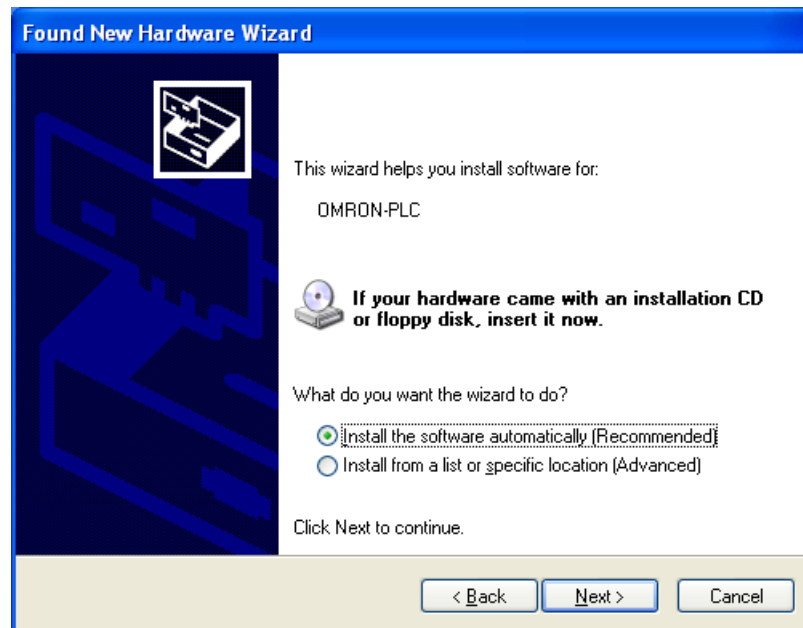

- Note 1:** If the software cannot be installed automatically, refer to *Installing a Specified USB Driver* later in this section.
- 2:** If the installation media is not inserted or the USB device driver is installed for another port, a Driver List Dialog Box will be displayed. Make sure that the newest driver is selected and click the **Next** Button.

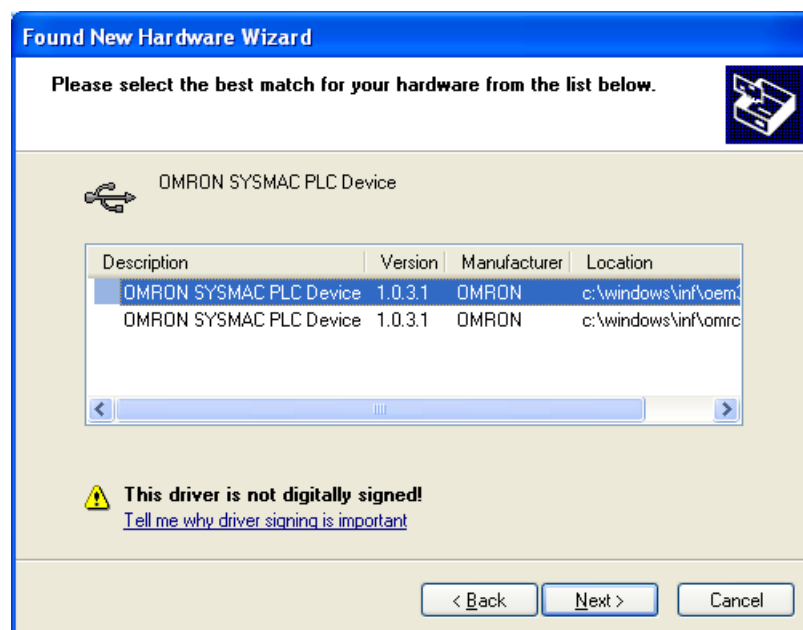

### 1-4-2 Connecting CJ-series CJ2 CPU Units, CP-series PLCs, NSJ-series Controllers, and NJ-series Controllers Using Commercially Available USB Cable

4. Ignore the following dialog box if it is displayed and click the **Continue Anyway** Button.

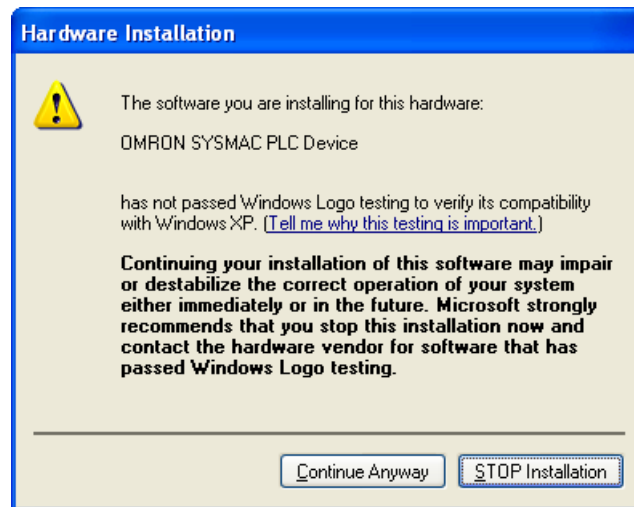

5. The following dialog box will be displayed if the installation is completed normally. Click the **Finish** Button.

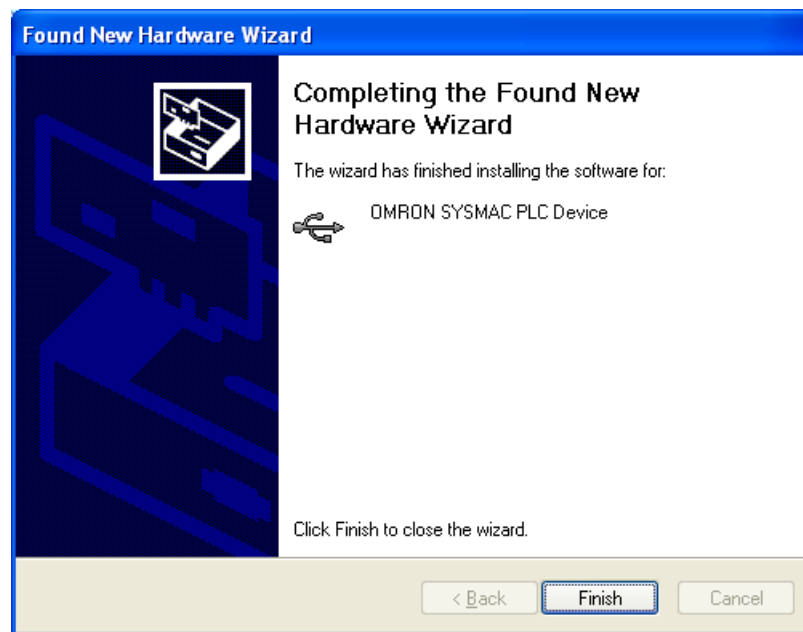

### Installing a Specified USB Driver

If the USB driver cannot be installed automatically, use the following procedure to install it.

#### **Windows Vista or Windows 7**

1. Turn ON the power supply to the PLC and connect the peripheral USB port on the PLC to the personal computer using a USB cable.

## 1-4 PLC Connecting Cables

### 1-4-2 Connecting CJ-series CJ2 CPU Units, CP-series PLCs, NSJ-series Controllers, and NJ-series Controllers Using Commercially Available USB Cable

2. The following dialog box will be displayed. Select **Locate and install driver software (Recommended)**.

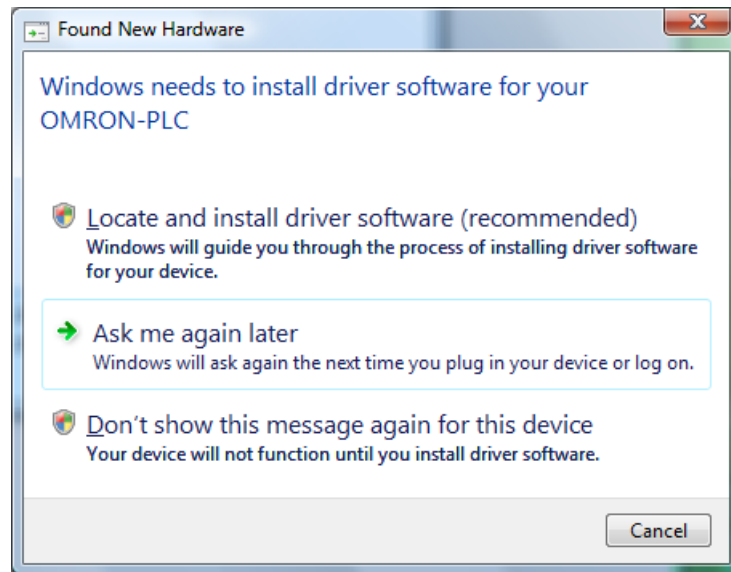

3. The following dialog box will be displayed. Select **I don't have the disc. Show me other options.**

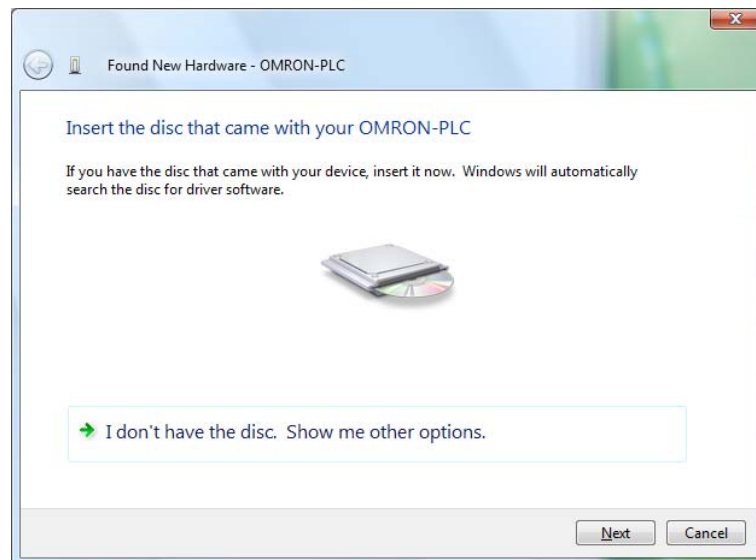

1-4-2 Connecting CJ-series CJ2 CPU Units, CP-series PLCs, NSJ-series Controllers, and NJ-series Controllers Using Commercially Available USB Cable

4. The following dialog box will be displayed. Click the **Browse** Button, specify one of the following locations, and then click the **Next** Button.

- When connected to a CS-series, CJ-series, CP-series, or NSJ-series Controller

Windows7(64bit)  
 C:\Program Files\OMRON\CX-Server\USB\7\64bit  
 Windows7(32bit)  
 C:\Program Files\OMRON\CX-Server\USB\7\32bit  
 WindowsVista(64bit)  
 C:\Program Files\OMRON\CX-Server\USB\Vista\64bit  
 WindowsVista(32bit)  
 C:\Program Files\OMRON\CX-Server\USB\Vista\32bit

- When connected to an NJ-series Controller

Windows7(64bit)  
 C:\Program Files\OMRON\Communications Middleware\USB\7\64bit  
 Windows7(32bit)  
 C:\Program Files\OMRON\Communications Middleware\USB\7\32bit  
 WindowsVista(32bit)  
 C:\Program Files\OMRON\Communications Middleware\USB\Vista\32bit

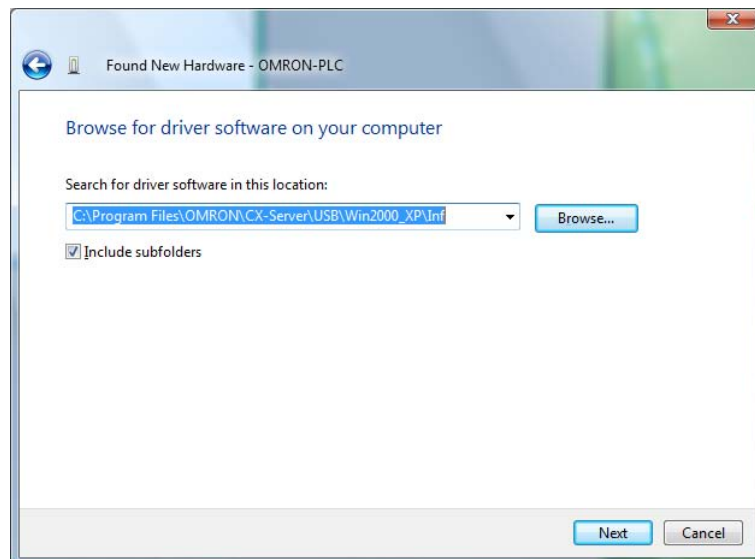

5. Ignore the following dialog box if it is displayed and select **Install this driver software anyway**.

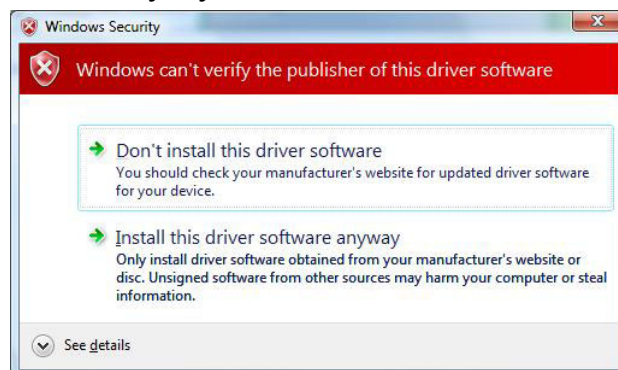

## 1-4 PLC Connecting Cables

### 1-4-2 Connecting CJ-series CJ2 CPU Units, CP-series PLCs, NSJ-series Controllers, and NJ-series Controllers Using Commercially Available USB Cable

6. The following dialog box will be displayed when the driver software has been installed successfully.

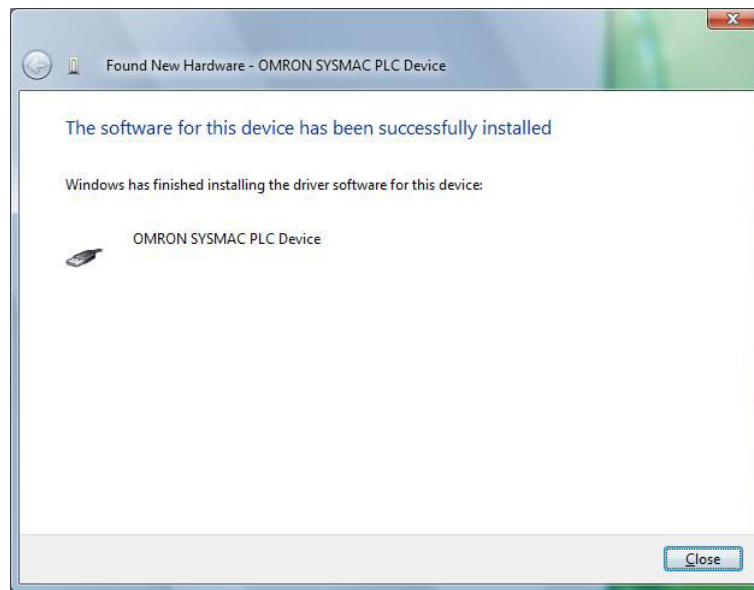

## Windows XP

1. In the Found New Hardware Wizard Dialog Box, select the *Install from a list or specific location (Advanced)* Option and click the **Next** Button.

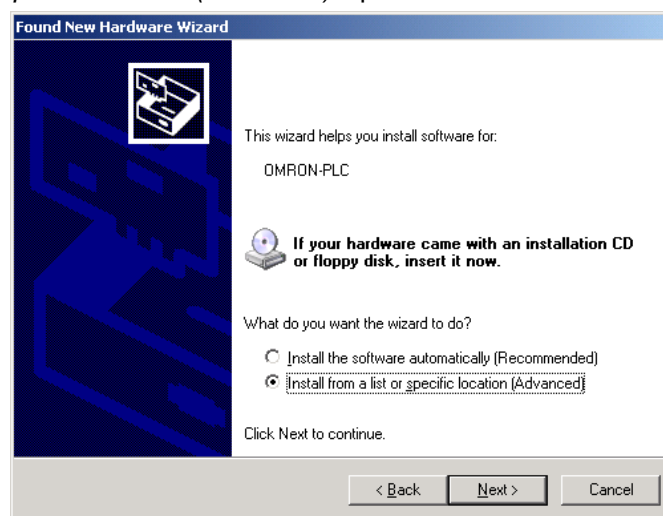



1-4-2 Connecting CJ-series CJ2 CPU Units, CP-series PLCs, NSJ-series Controllers, and NJ-series Controllers Using Commercially Available USB Cable

2. The following dialog box will be displayed. Make sure that the following location is displayed in the *Include this location in the search* Field, and then click the **Next** Button. The driver will be installed.

- When connected to a CS-series, CJ-series, CP-series, or NSJ-series Controller  
C:\Program Files\OMRON\CX-Server\USB\XP
- When connected to an NJ-series Controller  
C:\Program Files\OMRON\Communications Middleware\USB\XP

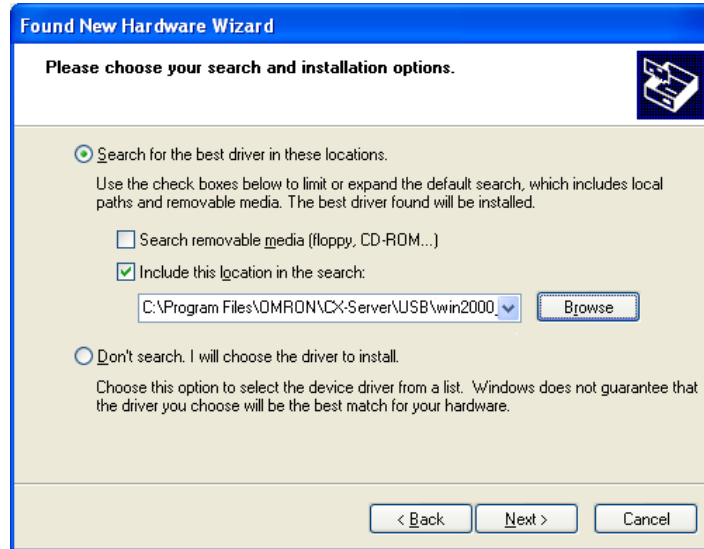

3. Ignore the following dialog box if it is displayed and click the **Continue Anyway** Button.



## 1-4 PLC Connecting Cables

### 1-4-2 Connecting CJ-series CJ2 CPU Units, CP-series PLCs, NSJ-series Controllers, and NJ-series Controllers Using Commercially Available USB Cable

4. The following dialog box will be displayed if the installation is completed normally. Click the **Finish** Button.

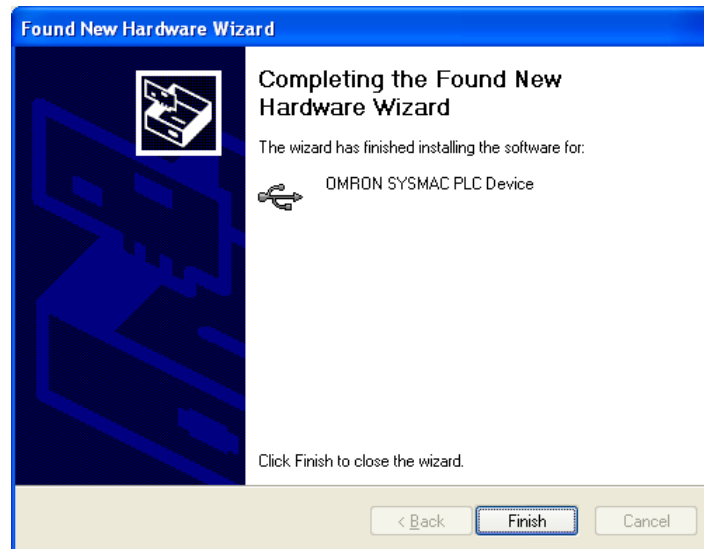

### Checking after Installation (Reference Information)

1. Display the Device Manager at the computer.
2. Click *USB (Universal Serial Bus) Controller*, and confirm that *OMRON SYSMAC PLC Device* is displayed.

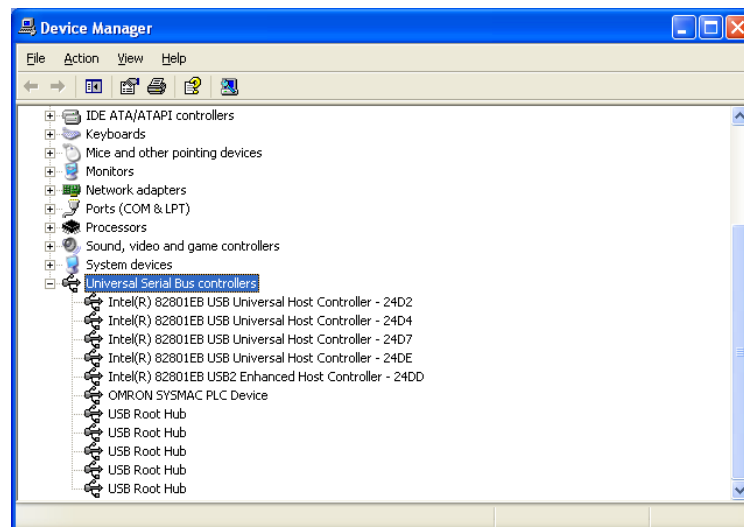

### Re-installing the USB Driver

If the USB driver installation fails for some reason or is cancelled in progress, the USB driver must be reinstalled.

#### Checking USB Driver Status

1. Display the Device Manager on the computer.
2. If the *OMRON-PLC* is displayed under *Universal Serial Bus controllers*, installation of the USB driver software failed.

1-4-2 Connecting CJ-series CJ2 CPU Units, CP-series PLCs, NSJ-series Controllers, and NJ-series Controllers Using Commercially Available USB Cable

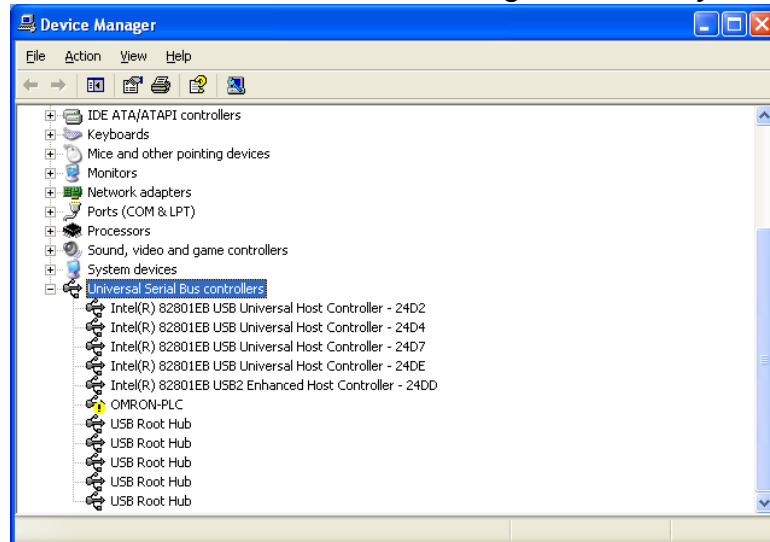

**Re-installing the USB Driver**

1. Right-click *OMRON-PLC* under *Universal Serial Bus controllers* and select **Properties**. The properties will be displayed.

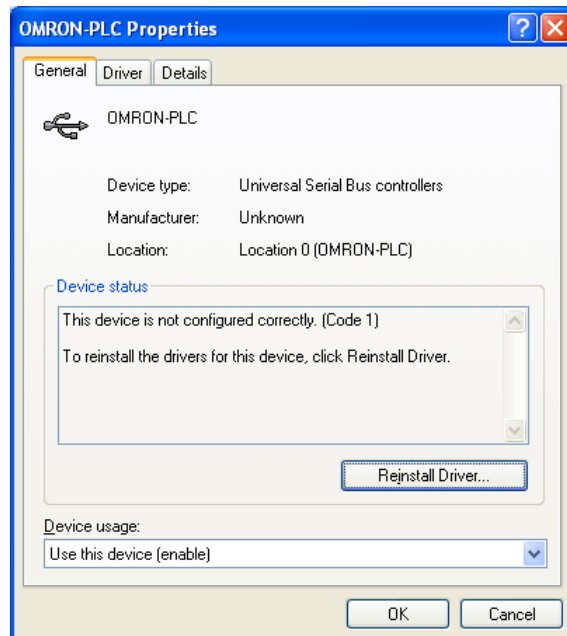

## 1-4 PLC Connecting Cables

### 1-4-2 Connecting CJ-series CJ2 CPU Units, CP-series PLCs, NSJ-series Controllers, and NJ-series Controllers Using Commercially Available USB Cable

2. Click the **Reinstall Driver** Button. The Hardware Update Wizard Dialog Box will be displayed. Install the driver software using the procedure described in *Installing the USB Driver*.

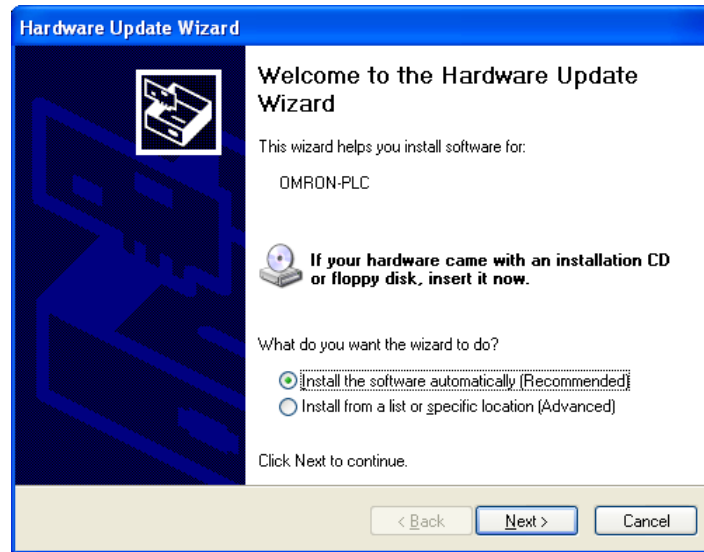

# 1-5 Window Descriptions

## 1-5-1 Starting Methods

The CX-Integrator can be started with any of the following three methods.

- 1) When using the CX-Programmer Ver. 6.0 or higher, select **Tools – Network Settings**.
- 2) When using the CX-Programmer that was installed from the CX-One, right-click a Communication Unit in the CX-Programmer's I/O table display and select **Start Special Application** from the pop-up menu.

**Note:** If the Communication Unit is a Serial Communications Board/Unit, a Start Special Application Dialog Box will be displayed. Select *CX-Integrator* in the dialog box to start the CX-Integrator.

- 3) Select **CX-Integrator** from the Start Menu.

## 1-5-2 Main Window

One of the following windows will appear when the CX-Integrator is started.

### Offline Window

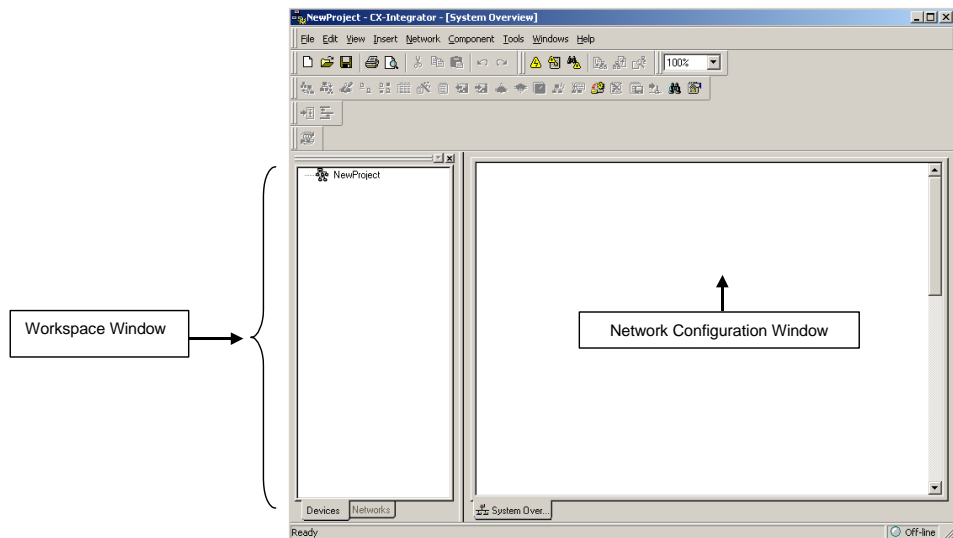

**Note:** The Component List Window and Output Window are not displayed by default. They can be displayed using the **View – Windows** Menu.

### Online Window

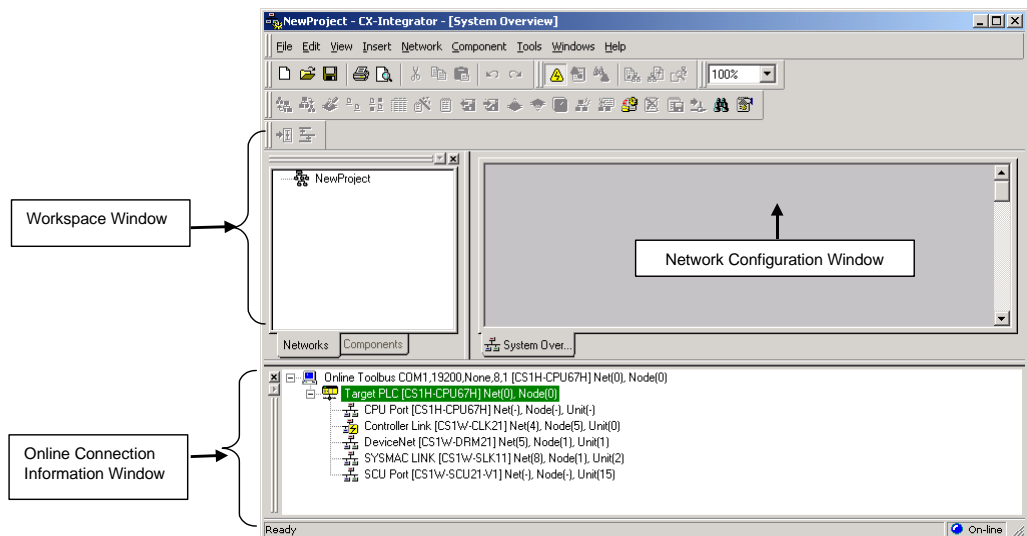

**1-5 Window Descriptions**  
**1-5-2 Main Window**

**Note** The following operations can be performed on the Workspace Window, Output Window, Component List Window, and Outline Window.

**Moving a Window and Displaying the Window Separately**

Drag the window by its top border to move it.

**Closing a Window**

Click the X Button (**Close** Button) at the upper-right corner of the window.

**Displaying a Window**

Select the desired window from the **View – Windows** Menu. (A check mark appears next to the windows that are displayed.)

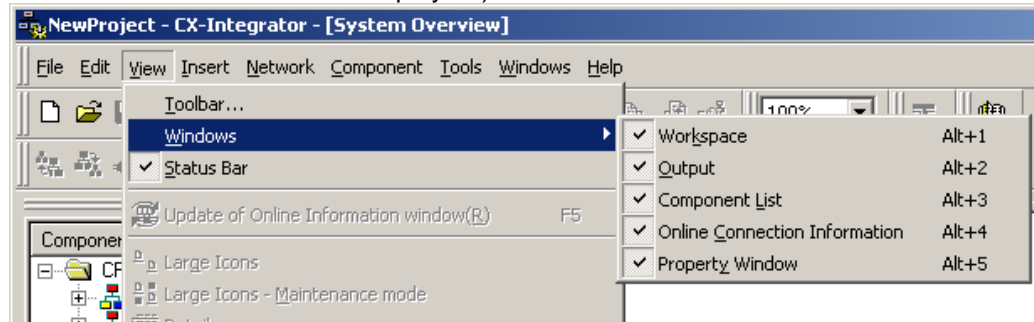

**Online Connection Information Window**

The Online Connection Information Window displays the online/offline status and the Relay PLC's communications settings.

When online, the target PLC will be displayed in a tree structure with all of the Communications Units and ports that belong to it.

**Online Operation**

The target PLC and Communication Units/ports mounted to the target PLC will be listed below the relay PLC.

**Relay PLC Communications Settings**

The relay PLC's communications settings will be displayed to the right of the Online icon (🖥️ Online).

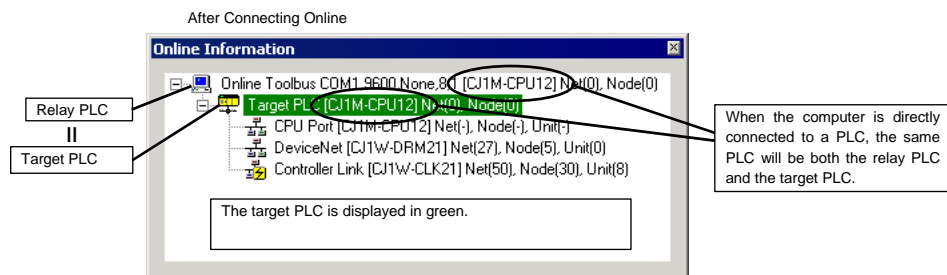

**Target PLC Information**

🖥️ Target PLC [CJ1M-CPU22] Net (0), Node (0)

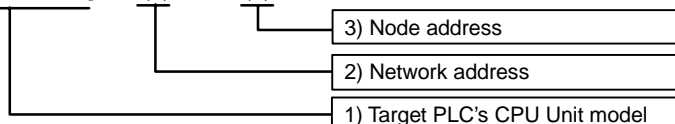

Description:

In brackets [ ] to the right of Target PLC	1) [Target PLC's CPU Unit model]	2) Network address	3) Node address
Target PLC's CPU Unit model	Target PLC's CPU Unit model	Network address (1 to 127, decimal) Note: This is the network address registered when this PLC is registered as the target PLC via the relay PLC.	Node address (decimal) Note: This is the node address on the network registered when this PLC is registered as the target PLC via the relay PLC.

**Communications Unit and Port Information for Target PLC**

The following CPU Unit built-in serial ports, Inner Boards, and Communications Units (referred to here as Communications Units/Ports) that are part of the target PLC are displayed under *TargetPLC* in directory tree format.

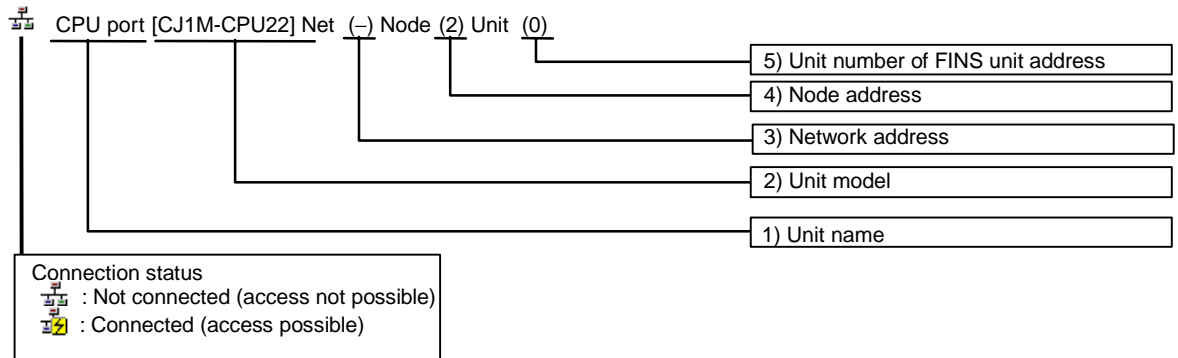

Description:

Communications Unit/port	1) Right of  or : Unit name	2) Unit model	3) Network address	4) Node address	5) Unit number or FINS unit address
<b>CPU Unit built-in serial port</b>	CPU Unit/port	Target PLC's CPU Unit model	The network address (1 to 127, decimal), when the serial port is registered in the local network table to treat it as a network. Note: “-” will be displayed if the serial port is not registered in the local network table.	– (Does not change.)	Serial port's FINS unit address (decimal) Peripheral port: 253 RS-232C port: 252 Note: “-” will be displayed if the serial port is not registered in the local network table.
<b>Serial port on Inner Board (Nothing displayed if an Inner Board is not mounted.)</b>	Serial Communications Board	Serial Communications Board model	Same as above.	– (Does not change.)	Serial port's FINS unit address (decimal) Port 1: 225 Port 2: 226 Note: “-” will be displayed if the serial port is not registered in the local network table.
<b>Communications Unit name, Model</b>	Communications Unit name (Ethernet Unit, Controller Link Unit, SYSMAC LINK Unit, or DeviceNet Unit)	Communications Unit model	Network address (1 to 127, decimal) Note: “-” will be displayed if a local network table is not registered.	Node address (node ID on the network)	Unit number (decimal) (Rotary switch on front of CPU Bus Unit: 0 to 15)
	CompoNet Master Unit name		– (Does not change.)	– (Does not change.)	Unit number (decimal) (Master Unit rotary switch number: 0 to 99)

If a connection is established and access is enabled for a Communications Unit/port, the icon on the left will be instead of .

Right-click the Communications Unit/port and select **Connect** to connect to the Communications Unit/port and enable access. (With the CX-Integrator, only one Communications Unit/port can be accessed at any one time.)

The actual network configuration can then be uploaded by right-clicking the Communications Unit/port and selecting **Transfer – Network to PC**.

# 1-5 Window Descriptions

## 1-5-2 Main Window

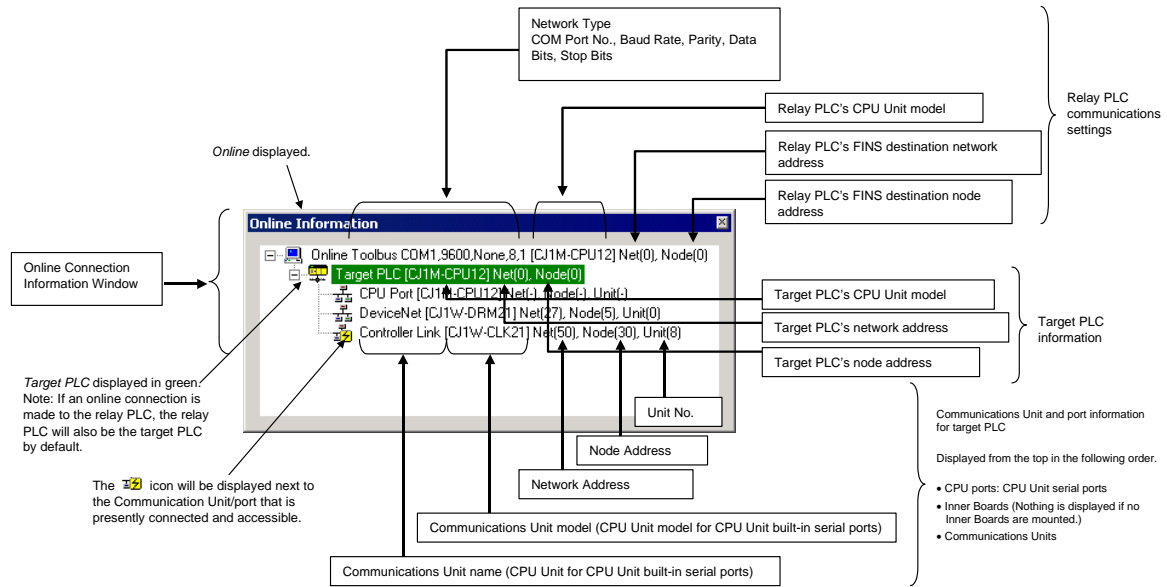



**Note:** If an online connection is made to the relay PLC, that PLC will be both the relay PLC and the target PLC. The Communications Units mounted in the relay PLC will be displayed in the Online Connection Information Window. Normally, the CX-Integrator is used with the same PLC as both the relay PLC and the target PLC.

Once a connection has been made, it is possible to download the network configuration and switch the target PLC to any PLC on the network. To do this, right-click a PLC on a network and select **Connect to this PLC**.

**Note** CX-Integrator Communications Connections

There are three levels of CX-Integrator communications connections depending on where the connection is made.



Display in Online Connection Information Window	Level	Operation	Remarks
 Online	1) Online connection to the relay PLC	Right-click the communications settings for the relay PLC and select <b>Auto Online</b> or <b>Work Online</b> .	Remember that this icon indicates that the online connection is to the relay PLC.
 TargetPLC or TargetComponent (See note.)	2) Status Online connection to the target PLC	The operation is the same as above when the relay PLC is the target PLC. If the target PLC is different from the relay PLC, upload the communications configuration, right-click the target PLC, and select <b>Connect to this PLC</b> .	An online connection to the target PLC is made after connecting online to the relay PLC, as described above. The following operations are possible for the CPU Unit at the target PLC. I/O tables: Creating, editing, and transferring I/O tables Error log: Displaying current errors and error logs Mode setting: Changing the operating mode
	3) A connection to one of the Communications Units/ports at the target PLC (Access is possible.)	Right-click the Communications Unit/port and select <b>Connect</b> .	Only one Communications Unit/port can be accessed at any one time. Communications configurations can be uploaded only for a Communications Unit/port in this status. Note: Access is possible to a Communications Unit/port only when it is connected. Access is not possible when disconnected.

**Note:** To connect the computer (CX-Integrator) directly to a CompoWay/F Slave through a serial connection, select **CompoWay/F Device** as the PLC model.

### Offline Displays

#### Relay PLC Communications Settings

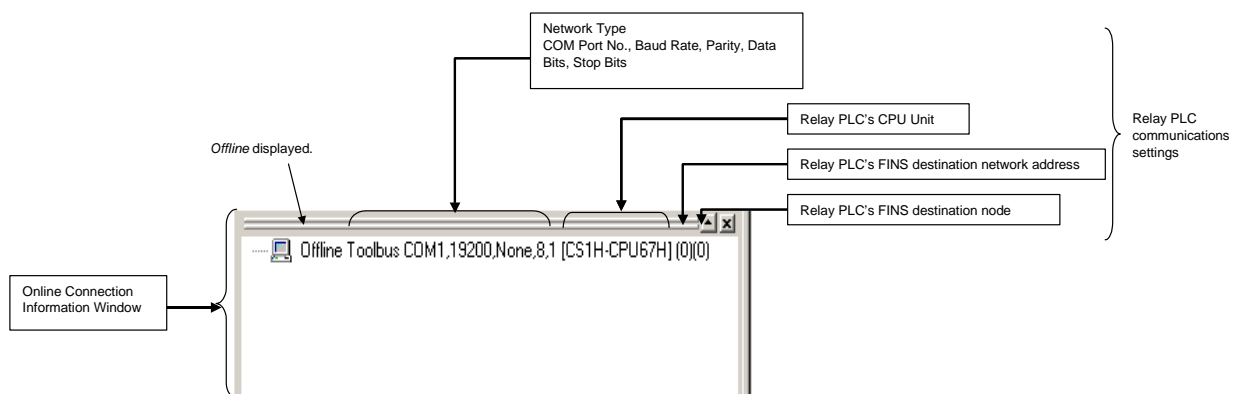

# 1-5 Window Descriptions

## 1-5-2 Main Window

### Relay PLC Communications Settings

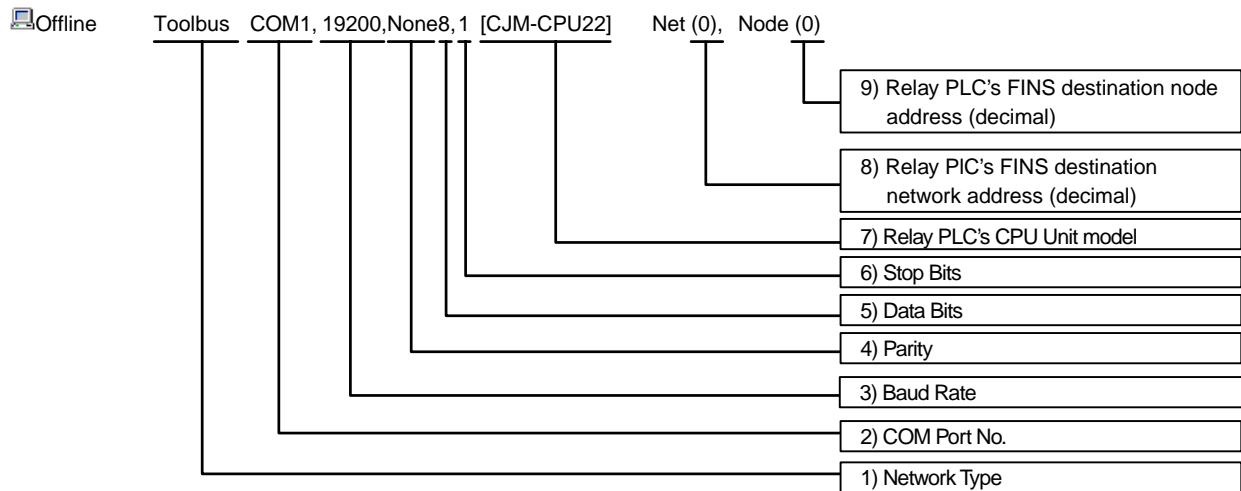

Description:

Display item	1) Network Type	2) COM Port No.	3) Baud Rate	4) Parity	5) Data Bits	6) Stop Bits
Contents	The following network types will be displayed for the connection to the relay PLC. USB Toolbus (peripheral) SYSMAC WAY (Host Link) SYSMAC LINK Ethernet Ethernet (FINS/TCP) FinsGateway Controller Link	COM port on computer	(Displayed only for Toolbus or SYSMAC WAY) Baud rate is displayed in bits/s.	(Displayed only for SYSMAC WAY) The communications data format parity is displayed. Even, Odd, or None	(Displayed only for SYSMAC WAY) 7 or 8	(Displayed only for SYSMAC WAY) 1 or 2
Example	Toolbus	COM1,	19200,	None,	8,	1

Display item	7) Relay PLC's CPU Unit model	8) Relay PLC's FINS destination network address (decimal)	9) Relay PLC's FINS destination node address (decimal)
Example	[CS1H-CPU67H]	Net (0)	Node (0)
Contents	Relay PLC's CPU Unit model	For a direct serial connection, the FINS destination network and node addresses are normally displayed as 0. For direct network connections, any FINS destination network (1 to 127) and node addresses can be set. (If routing tables are registered in the PLCs on the networks, specifying a PLC on any network other than the network that is directly connected to is also possible.	

### Updating the Online Connection Information Window Display

This section describes how to update the target PLC display in the Online Connection Information Window display, and how to display the updated information.

**⚠ Caution** When changing or removing a routing table (see note), be sure to update the display for the Online Connection Information Window. The display for the Online Connection Information Window could possibly be different from the actual network status. If operations are executed without first updating the display, particularly online operations in the Network Configuration Window, it could cause data to be mistakenly read or written for the wrong network or node address or unit number.

**Note:** Changing or removing a routing table refers to using the CX-Integrator (or a CX-Integrator for another personal computer) to start the Routing Table Component and then changing or removing a routing table for the target PLC (either a local network table or a relay network table).

Use the following procedure.

1. In the Online Connection Information Window, either select **Update of Online**

**Information Window** from the View Menu or press the **F5** Key.

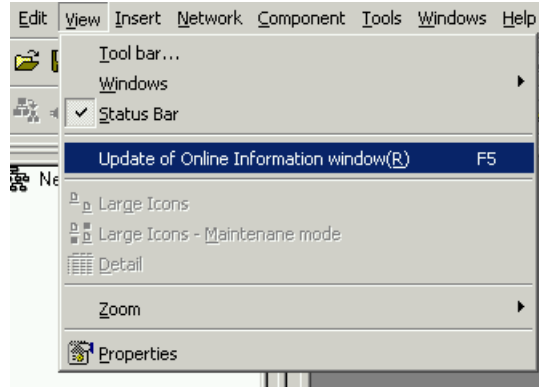

2. The following dialog box will be displayed for confirmation. To execute the update, click the **Yes** Button.

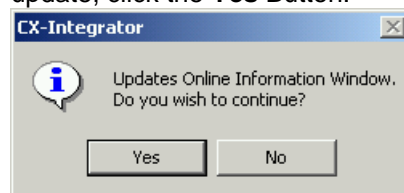

3. The display contents of the Online Connection Information Window will be updated.
4. After the display has been updated, operations can be executed with respect to the Units and Components that are displayed.

### **Precautions for Online Operations After a Routing Table has been Changed or Removed**

After a routing table has been changed or removed, observe the following precautions regarding the windows from which to execute online operations such as connections, network transfers, and starting of special applications.

1. **Executing online operations in the Network Configuration Window:**  
The actual network status may be different from what is being displayed in the Online Connection Information Window. Be sure to select **Display – Change Online Connection Information Window** and update the Online Connection Information Window.
2. **Executing online operations except for “connect” (see note) in a window other than the Network Configuration Window:**  
A dialog box will be displayed to notify of a display update. Click the **OK** Button to update the Online Connection Information Window display. Then execute the online operation again.

**Note:** When the “connect” operation is executed, the connection is made after the Online Connection Information Window display has been automatically updated, without any dialog box displayed for updating the window display.

### Workspace Window

The Workspace Window lists components and networks.

#### **Component Tab Page**

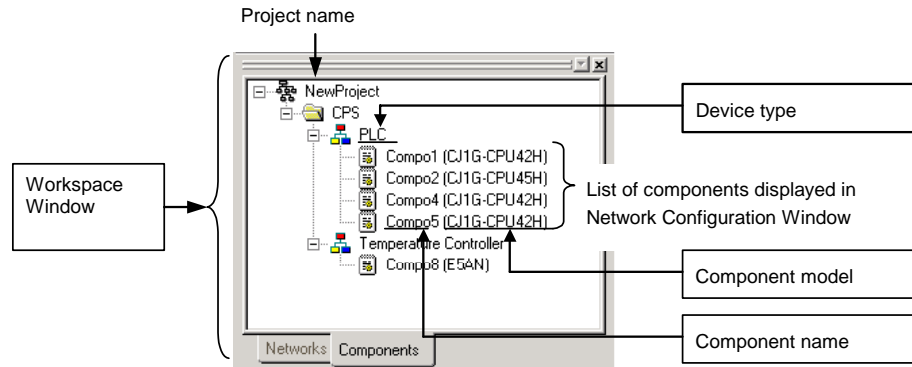

The Component Tab Page lists the components displayed in the Network Configuration Window.

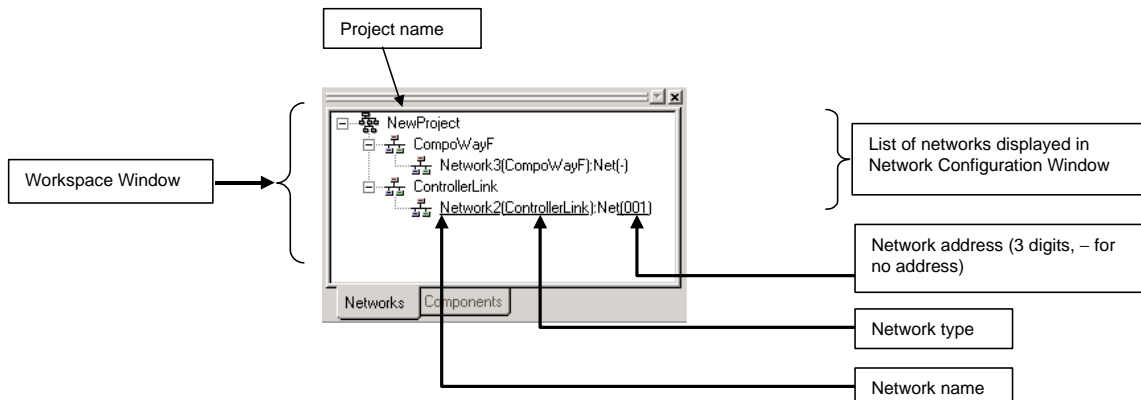

#### **Network Tab Page**

The Network Tab Page lists the networks displayed in one Network Configuration Window.





The icon to the left of the network that is currently connected and can be accessed will be either  or . (With the CX-Integrator, only one Communications Unit/port can be accessed at any one time.) To enable accessing a network, right-click on it and select **Connect**. The actual communications configuration can then be uploaded by right-clicking the Communications Unit/port and selecting **Transfer – Network to PC**. To compare the actual communications configuration with that on the CX-Integrator, right-click the Communications Unit/port and select **Compare**.

Note: The Workspace Window corresponds 1:1 to the Network Configuration Window.

If the Network Configuration Window is closed, double-click on a network in the Workspace Window, and the communications configuration of that network will be displayed in the Network Configuration Window.

**Note** Accessible Status for Networks

The following status is possible for a network displayed in the Workspace Window.

Display in Workspace Window	Status	Operation	Remarks
	Accessible network	Right-click the network and select <b>Connect</b> .	Only one network can be accessed at any one time. Network configurations can be uploaded or compared only for a network in this status. Note: Access is possible to a network only when it is connected.
	Inaccessible networks	Networks created offline or networks for which the communications configuration has been uploaded and then the connection was changed to a different network by right-clicking and selecting <b>Connect</b> .	Note: Access is not possible to a network that is not connected.

### Network Configuration Window

When the network configuration is uploaded online from the target PLC, the network configuration will be displayed in this window. If a network is inserted offline, the new network will be displayed in the Network Configuration Window.

The Network Configuration Window corresponds 1:1 with the Workspace Window.

#### Online (Same for All Network Types)

The target component's actual network configuration (including component parameters) can be uploaded online from the target component by selecting **Transfer [Network to PC]** after selecting **Connect**. The uploaded network configuration will be displayed in this Network Configuration Window.



#### Meaning of Window Background Colors and Target Component Highlighting

The background of the Network Configuration Window will be gray when the window can be accessed. The target component will be highlighted with a green border.

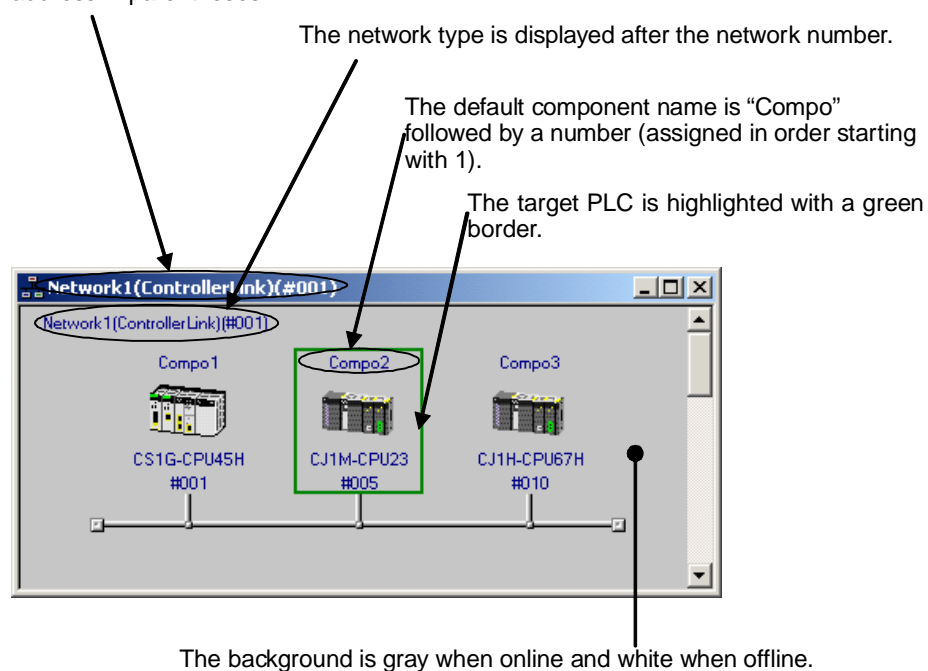
The window title shows network number (assigned in order starting with Network1), then the network type, and finally the network address in parentheses.



**1-5 Window Descriptions**  
**1-5-2 Main Window**

Item		Online	Offline
Network Configuration Window	Background color	Gray 	White 
	Component display	Green border 	No border
	Other component	No border	

Note: The relay PLC will remain the target PLC with the green border until another node (PLC) is specified as the target PLC by selecting **Connect to this PLC**.

**Offline (for DeviceNet or CompoWay/F Only)**

When offline in a DeviceNet network, components can be selected from the Component List Menu and added to the virtual network in the Network Configuration Window by dragging them from the EDS (DeviceNet) Tab and dropping them in the Network Configuration Window.

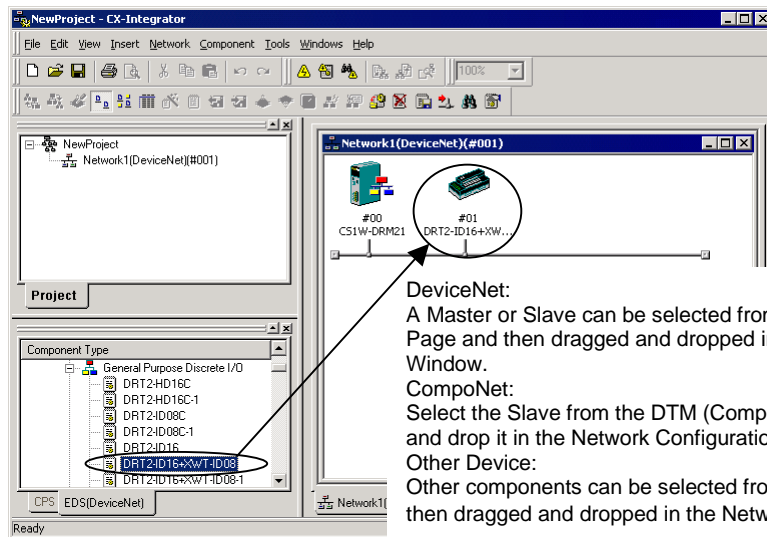

**DeviceNet:**  
 A Master or Slave can be selected from the EDS (DeviceNet) Tab Page and then dragged and dropped in the Network Configuration Window.  
**CompoNet:**  
 Select the Slave from the DTM (CompoNet) Tab Page, and drag and drop it in the Network Configuration Window.  
**Other Device:**  
 Other components can be selected from the CPS Tab Page and then dragged and dropped in the Network Configuration Window.

With DeviceNet or CompoNet, the node address, product name, and slave allocation status in the master will be displayed as shown below.

DeviceNet Example:

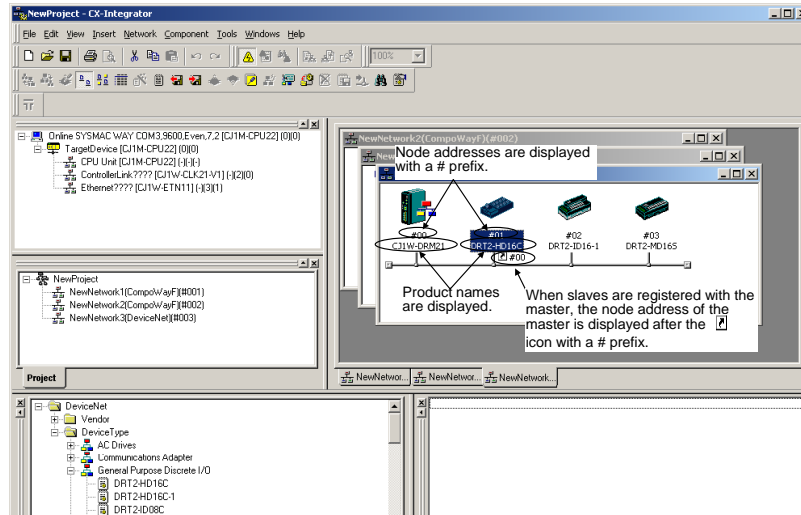

CompoNet Example:

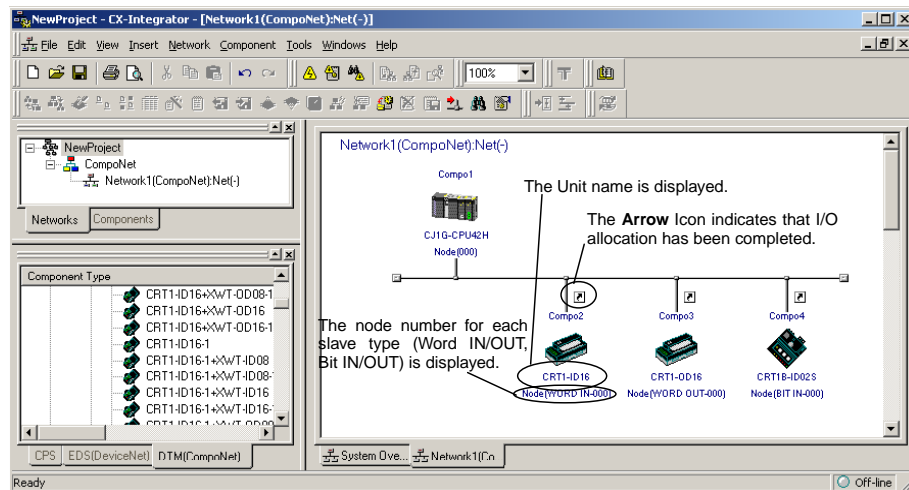

Later, the component parameters in the virtual network that was created can be downloaded to the devices on the actual network online. Furthermore, the configuration of the virtual network that was created (not including component parameters) or selected component parameters can be compared to the actual network configuration or the parameters in the actual component.

**Note** The same functions can be performed by right-clicking in the window and selecting from the Edit or Component Menu. If the mouse pointer is moved to a component, a description of the component will be displayed in a pop-up. For networks other than DeviceNet, the version of each component is also displayed (except for version 0).



**System Overview**

The System Overview displays the relationships between networks.

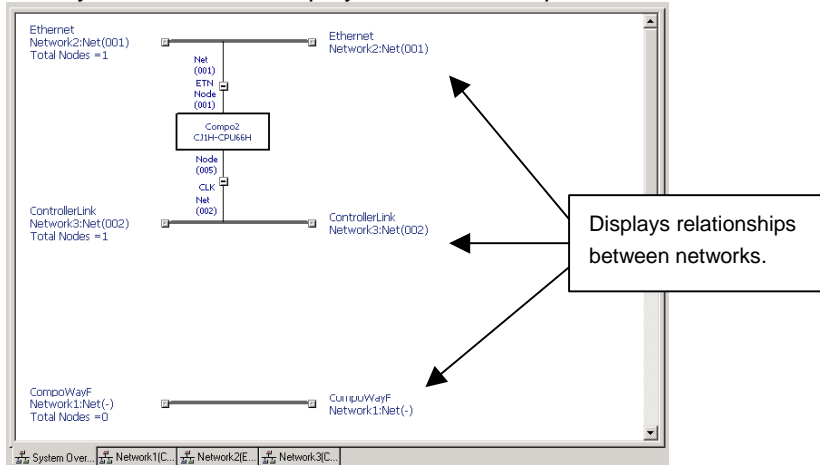

- The System Overview displays the relationships between all networks registered in the current project and the relationships to components connected to more than one network. The following information is displayed.
  - Networks types, names, and addresses (The address is not displayed if a local network table is not registered, i.e., when the network address is 0.)
  - Number of nodes on each network.
  - Component models, names, and node addresses (The node address is displayed only if it has been set.)

Note: CompoWay/F and NT Links are not displayed by default. They can be displayed using the System Overview Setting Dialog Box, described later.
- The Network Configuration Window for any network can be displayed by double-clicking the network or by right-clicking the network and selecting **Open Detailed Network View**.
- The following Network View Setting Dialog Box can be displayed by right-clicking in any open area in the System Overview and selecting **Network View Setting**.

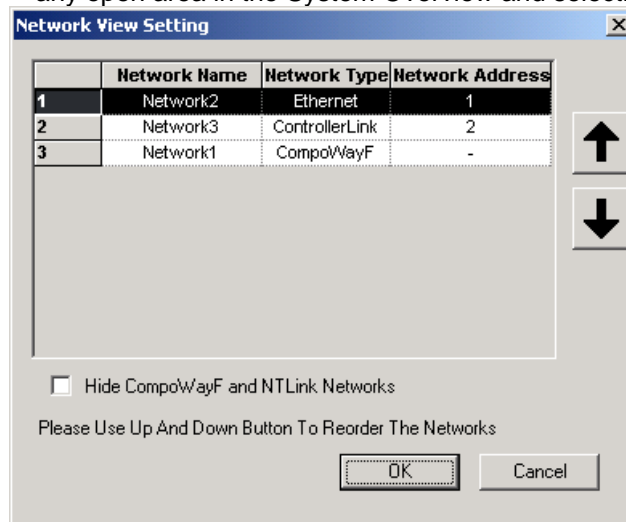

Select a network and click the Up and Down Arrows to change the display order. You can also clear the *Hide CompWayF and NTLINK Networks* Option so that serial communications for CompoWay/F and NT Links are displayed as networks.



## Property Window

The Property Window displays the properties of the selected component, network, or project.

### Components

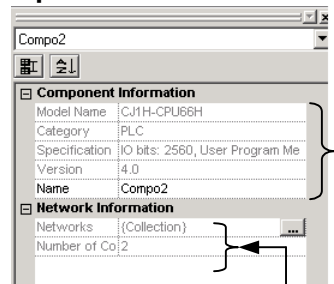

Select existing components from the pull-down list.

Component Information.

- Model Name: Unit model No.
- Category: PLC, etc.
- Specification: Simply specifications (See note.)
- Version: Unit version
- Component

Network Information

- Networks
- Number of Connected Network: Network address

**Note:** Will not be displayed when using DeviceNet.

### Networks

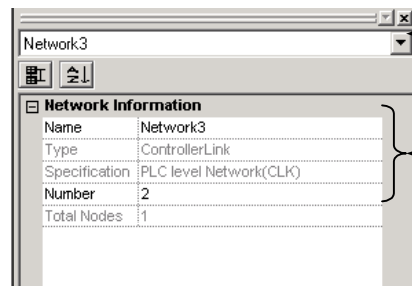

Select existing networks from the pull-down list.

Network Information

- Name: Network name
- Type: Network type
- Specification: Simply specifications
- Network address: FINS network address
- Connected: Number of connected nodes

### Projects

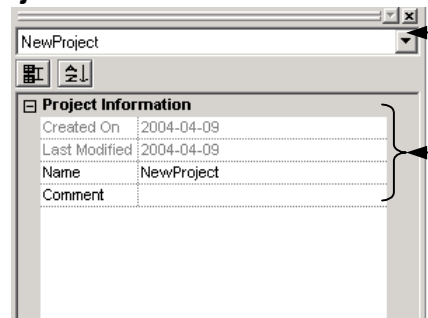

Select existing networks from the pull-down list.

Project Information

- Created on
- Last Modified
- Name
- Comment

### Parts List (Component List)

Components are listed in the Parts List. A component can be added to the network just by selecting the component in the Parts List and then dragging and dropping it in the Network Configuration Window. There are lists on the CPS, EDS (DeviceNet), and DTM (CompoNet) Tab Pages.

#### CPS Tab

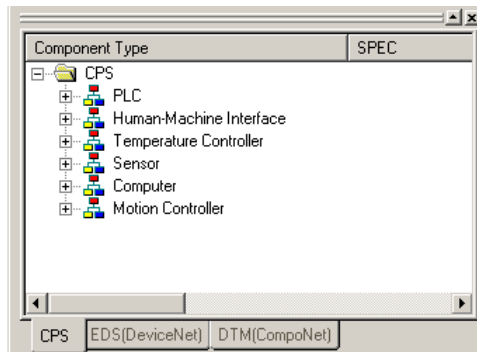

The Parts List shows the OMRON components that have had CPS files installed. The components are organized by component type in the directory tree format. A component can be added by selecting the desired component from the Parts List Pane and then dragging and dropping it in the non-DeviceNet and non-CompoNet Network Configuration Window.

The following component types are available.

Component type	Description
Generic Device	These are general-purpose devices such as computers that are not CPS-compatible.
Human-Machine Interface	Contains the supported OMRON NS-series PT models.
PLC	Contains the supported OMRON CS/CJ-series PLC (CPU Unit) models.
Sensor	Contains the supported OMRON ZX-series Smart Sensor models.
Temperature Controller	Contains the supported OMRON E5□-series Temperature Controllers.

Note: The CPS files are installed in the following directory:  
 Program Files\Common Files\Omron\Profiles\CPSFiles

#### EDS (DeviceNet) Tab

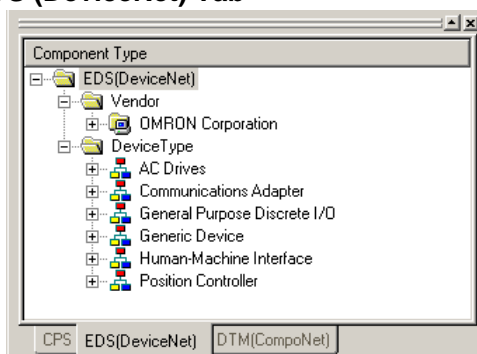

The Parts List shows components that have had EPS files installed. The components are organized by both vendor and component type in the directory tree format. A single device will be displayed in both the vendor and component type directory trees. Select the device in whichever directory is easier to use. A component can be added by selecting the desired component from the Parts List and then dragging and dropping it in the DeviceNet Network Configuration Window.

▪ Vendor List

The installed devices are organized by vendor name in this directory. When the CX-Integrator is first installed, the OMRON directory will be the only directory, but other manufacturer's directories will be created automatically when another manufacturer's EDS files are installed.

▪ Device Type List

The installed devices are organized by device type in this directory. The following device types are available.

Device type	Description
Generic Purpose Discrete I/O	Contains general-purpose I/O devices.
Communications Adapter	Contains devices that operate as network gateways.
Human-Machine Interface	Contains devices that operate as human-machine interfaces, such as PTs.
AC Drives	Contains AC drive devices.
Position Controller	Contains devices equipped with positioning functions, such as servomotors and stepping motors.
Generic Device	Other devices

**DTM (CompoNet) Tab Page**

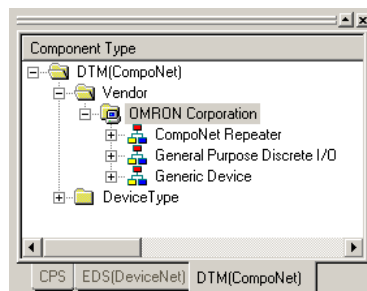

The Parts List Pane shows components installed in DTM. The components are organized by both vendor and device type in a directory tree format. Select the device in whichever directory is easier to use. A component can be added by selecting the desired component from the Parts List Pane and then dragging and dropping it in the CompoNet Network Configuration Window.

▪ Vendor List

The installed devices are organized by vendor name in this directory. Components manufactured by OMRON will be displayed immediately after the CX-Integrator has been installed. Once DTM is installed, the applicable components will be added to the Parts List.

▪ Device Type List

The installed devices are organized by device type in this directory. The following device types are available.

Device type	Description
CompoNet Repeater	Contains components that expand network wiring.
General Purpose Discrete I/O	Contains general-purpose I/O components.
Generic Device	Other devices

## 1-6 Menus

### 1-6-1 Menus

## 1-6 Menus

### 1-6-1 Menus

Main menu	Sub-menu/command		Description	Network type	Offline	Online	
File	New		Creates a new project.	All networks	OK	OK	
	Open		Opens a project that already exists.		OK	OK	
	Close		Closes the project being edited.		OK	OK	
	Save		Saves (overwrites) the project being edited.		OK	OK	
	Save As		Saves the project being edited under a different name.		OK	OK	
	Import	Network	Imports a DeviceNet network configuration file (.npf).	DeviceNet only	OK	No	
	Export	Network		Exports the DeviceNet network configuration file (.npf) for the DeviceNet network selected in the Workspace Window.	DeviceNet only	OK	OK
		DeviceNet Component	Comment list	Saves I/O comments in a CSV-format file.	DeviceNet only	OK	OK
		Export Network As V1.0		Exports the data to a file that can be read by CX-Integrator version 1.0.	All networks except DeviceNet	OK	OK
	Print Preview		Displays a printing preview.	All networks	OK	OK	
	Print		Prints component parameters and I/O comment lists.		OK	OK	
	NewProject.smt		Opens the previous file.		OK	OK	
	Exit		Exists the CX-Integrator.		OK	OK	
Edit	Undo		Undoes the previous operation.	All networks except DeviceNet	OK	No	
	Redo		Restores an operation that has been undone.		OK	No	
	Cut		Cuts the specified range.	All networks	OK	No	
	Copy		Copies the selected object to the clipboard.		OK	No	
	Paste		Pastes the object on the clipboard to the cursor position.		OK	No	
	Delete		Deletes the selected object.		OK	No	
	Select All		Selects all objects.		OK	No	
	Toggle Position		Switches the positions of components in the Network Configuration Window between above and below the network line.		OK	No	
View	Tool bar		Used to customize the toolbar.		OK	OK	
	Windows	Workspace Alt+1		Displays and hides the Workspace Window.		OK	OK
		Output Alt+2		Displays and hides the Output Window.		OK	OK
		Component List Alt+3		Displays and hides the Component List Window.		OK	OK
		Online Connection Information Alt+4		Displays and hides the Online Connection Information Window.		OK	OK
		Property Window Alt+5		Displays and hides the Property Dialog Box.		OK	OK
	Status Bar		Displays and hides the status bar.		OK	OK	
	Update of Online Connection Information Window		Updates the display for the Online Connection Information Window.		No	OK	
	Large Icons		Displays components in the Network Configuration Window with large icons.	DeviceNet only	OK	OK	
	Large Icons-Maintenance mode		Displays components in the Network Configuration Window with large icons in Maintenance Mode.	DeviceNet only	OK	OK	
	Detail		Switches to a detailed display.	DeviceNet only	OK	OK	

Main menu	Sub-menu/command		Description	Network type	Offline	Online
View	Zoom	200%	Displays components in the Network Configuration Window at 200% of the default size.	All networks	OK	OK
		100%	Displays components in the Network Configuration Window at the default size.			
		75%	Displays components in the Network Configuration Window at 75% of the default size.			
		50%	Displays components in the Network Configuration Window at 50% of the default size.			
	Properties		Displays the properties of the selected project, network, component, or EDS file.		OK	OK
Insert	Network		Adds a new virtual network to the Network Configuration Window offline.		OK	No
	Component		Adds the component selected in the Component List Window to the Network Configuration Window offline.		OK	No
	Insert TBranch		Adds a new T-branch to the Network Configuration Window offline (Controller Link only).		OK	No
Network	Work Online		Switches between working offline and online with the relay PLC using the device type setting in the computer.		OK	OK
	Communication Settings		Used to change the device type settings of the relay PLC on the computer. The Change Dialog Box PLC is displayed.		OK	No
	IP address table setting		Sets the CX-Integrator IP address table. (Only when the relay PLC is set for Ethernet communications and the network address is 1 or greater.)	Ethernet only	OK	OK
	Auto Online		Automatically connects to the relay PLC using the communications settings of the PLC (supported for serial communications only). After the auto-connection has been made, the device type information of the relay PLC that was connected to will be uploaded.		OK	No
	Change connection to this PLC		Switches the connection to the selected network to enable accessing it.		No	OK
	Transfer [PC to Network]		Downloads all component parameters from the virtual network on the computer to the components in the actual network.		No	OK
	Transfer [Network to PC]		Uploads the network configuration of the Communications Unit selected in the Online Connection Information Window, provided that the network can be displayed and accessed in the Workspace Window.		No	OK
	Compare		Compares the virtual network on the computer to the network configuration of the actual networks (without component parameters). The target PLC must be online and accessible.		No	OK

**1-6 Menus**  
**1-6-1 Menus**

Main menu	Sub-menu/command		Description	Network type	Offline	Online
Network	Parameter	Edit	Enables editing the parameters of the selected Controller Link network.	All networks	OK	OK
		Write	Writes the parameters of the selected component to a component parameter file.		OK	OK
		Read	Reads the parameters from a component parameter file to a selected component.		OK	No
		Transfer [PC to Network]	Downloads all component parameters or network parameters from the virtual network on the computer to the actual network.		No	OK
		Transfer [Network to PC]	Uploads the network configuration and all component parameters or network parameters from the actual network to the virtual network on the computer.		No	OK
		Compare	Compares the network configuration and all component parameters or network parameters between the actual network and the virtual network on the computer.		No	OK
	Move to upper network		Displays the next higher network layer.	DeviceNet only	No	OK
	Move to lower network		Displays the next lower network layer.	DeviceNet only	No	OK
	Rename Network		Changes the network name.	All networks	OK	No
	Change Network Address		Changes the network address.		OK	No
	Update Maintenance Information		Updates the device's maintenance information.	DeviceNet only	No	OK
Component	Parameter	Wizard	Enables setting component parameters with a wizard (for supported components only).	DeviceNet only	OK	OK
		Edit	Enables editing the parameters of the selected component.	All networks	OK	OK
		Load	Reads the parameters from a component parameter file to a selected component.		OK	OK
		Save	Saves the parameters of the selected component to a component parameter file.		OK	OK
		Download	Downloads the selected component parameters to the actual component.		No	OK
		Upload	Uploads the selected component parameters from the actual component.		No	OK
		Compare	Compares the selected component parameters with those in the actual component.		No	OK
	Monitor		Enables monitoring the selected component (for supported components only).	DeviceNet and CompoNet	No	OK
	Reset		Resets the selected component.	DeviceNet only	No	OK
	Start Special Application	Start with Settings Inherited	Starts the associated Support Software for the selected component or PLC, keeping the CX-Integrator settings.	All networks	No	OK
		Start Only	Starts the associated Support Software for the selected component or PLC, without keeping the CX-Integrator settings.		OK	OK

Main menu	Sub-menu/command		Description	Network type	Offline	Online	
Component	IO table		Starts the I/O Table Component online.	All networks	No	OK	
	Error Log		Display the CPU Unit error log online.		No	OK	
	Mode Setting		Reads or changes the CPU Unit's operating mode online.		No	OK	
	Maintenance information		Displays the maintenance information of the selected component.	DeviceNet only	No	OK	
	Status/Error of Communication Unit		Displays the status and error information on a Communications Unit online.	All networks	No	OK	
	Error Log of Communication Unit		Displays the error log of a Communications Unit online.		No	OK	
	Resister to another device	(Component name)	Registers the current device to the scan list in another device.	DeviceNet only	OK	No	
	Change Node address		Changes the node address of a component.	All networks	OK	No	
	I/O Comment		Enables editing the comments of a DeviceNet device (component).	DeviceNet only	OK	No	
	Edit Device Comment		Enables changing the comment of a component.	DeviceNet only	OK	No	
Tools	Start Data Link		Starts the Data Link Component.	All networks	OK	OK	
	Start Routing Table		Starts the Routing Table Component.		OK	OK	
	NT Link tool	Auto online setting	Automatically detects an NS-series PT connected serially via an NT Link to a CS/CJ-series PLC.	NT Link only	No	OK	
	DeviceNet tool	Generic parameter setting		Sends an explicit message.	DeviceNet only	OK	OK
		Setup Node Address/Baud Rate		Sets the slave node address and baud rate to a user-set value from a computer.	DeviceNet only	No	OK
		Edit Configuration file		Edits each settings file.	DeviceNet only	OK	OK
		Edit Configuration file		Edits a variety of setting files.	DeviceNet only	OK	OK
		Install of plugin module		Enables installing a plug-in module.	DeviceNet only	OK	OK
		Setup monitor refresh timer		Set the monitor refresh timer for the device monitor window.	DeviceNet only	OK	OK
		Parameter auto update when I/O size changed		Enables automatically updating the slave I/O size registered in the scan list in the master when a slave I/O size is changed. The default setting is OFF (not automatically updated). Normally, leave this function set to OFF.	DeviceNet only	OK	OK
	Controller Link tool	Network Diagnosis		Starts the Controller Link Network Diagnosis Tool.	All networks	No	OK
	Ethernet tool	Ping test		Starts the Ethernet ping test tool.	Ethernet only	No	OK
		Broadcast node search		Uses IP broadcast to search for nodes on Ethernet.		OK	OK
	Echoback test between PLC nodes		Starts the echoback test tool for checking the communications status of the network.	All networks	No	OK	
	CPS file	Install CPS			Installs a CPS file on the computer and adds the component to the CPS list.	OK	OK
	EDS file	Install EDS		Installs an EDS file on the computer and adds the device to the EDS list (DeviceNet) or DTM list (CompoNet).	DeviceNet and CompoNet	OK	OK
		Create		Creates a new EDS file on the computer and adds the device to the EDS list.	DeviceNet only	OK	OK

## 1-6 Menus

### 1-6-1 Menus

Main menu	Sub-menu/command		Description	Network type	Offline	Online
Tools	EDS file	Delete	Deletes an EDS file from the EDS list.	DeviceNet only	OK	OK
		Save	Saves an EDS file from the EDS list in a file with a different name.	DeviceNet only	OK	OK
		Find	Searches for the specified EDS file in the EDS list.	DeviceNet only	OK	OK
	Update DTM Catalog		Refreshes the DTM (CompoNet) list to the latest state.	CompoNet only	OK	OK
	Options		Sets the CX-Integrator operation options.	All networks	OK	OK
Window	Close All		Closes all windows.	All networks	OK	OK
	Next Docked		Moves the focus to the next docked window.		OK	OK
	Previous Docked		Moves the focus to the previous docked window.		OK	OK
	Cascade		Cascades the windows.		OK	OK
	Tile Horizontally		Tiles the windows horizontally.		OK	OK
	Tile Vertically		Tiles the windows vertically.		OK	OK
Help	Help Contents		Displays help.	OK	OK	
	Online Registration		Displays the online registration window.	OK	OK	
	About CX-Integrator		Displays version information.	OK	OK	



## 1-6-2 Pop-up Menus

### Online Connection Information Window

#### Pop-up Menu for the Relay PLC's Communications Settings

The following pop-up menu will be displayed if you right-click the relay PLC's communications settings line (starting with *Offline*) in the Online Connection Information Window.

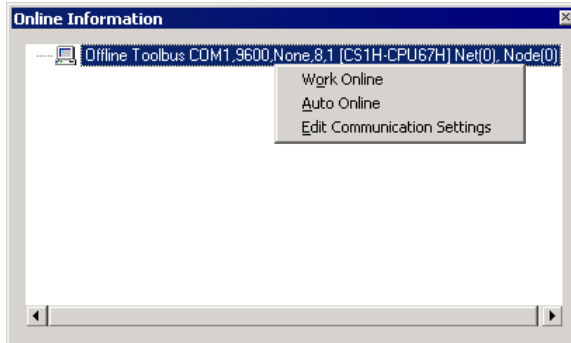

Pop-up menu item	Description	Offline	Online
Work Online	Connects to the relay PLC using the device type settings on the computer.	OK	No
Auto Online	For a serial connection, automatically connects using the communications settings in the PLC. (The device type settings of the connected relay PLC will be uploaded.)	OK	No
Edit Communication Settings	Used to change the device type settings of the relay PLC on the computer. The Change PLC Dialog Box is displayed.	OK	No

Note: The following will be displayed when online.

Pop-up menu item	Description	Offline	Online
Offline	Closes the connect and places the CX-Integrator offline.	No	OK

#### Pop-up Menu for Target PLC Online

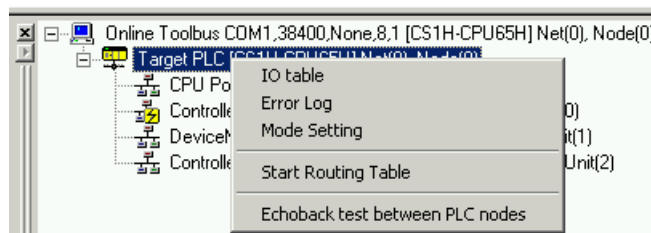

Pop-up menu item	Description	Offline	Online
I/O table	Starts the I/O Table Component.	No	OK
Error Log	Starts the PLC Error Component.	No	OK
Mode Setting	Changes the operating mode of the CPU Unit	No	OK
Start Routing Table	Starts the Routing Table Component.	No	OK
Echoback test between PLC nodes	Starts the echoback test for checking the communications status of the network.	No	OK

**1-6 Menus**  
**1-6-2 Pop-up Menus**

**Pop-up Menu for Communications Units/Ports under TargetPLC Online**

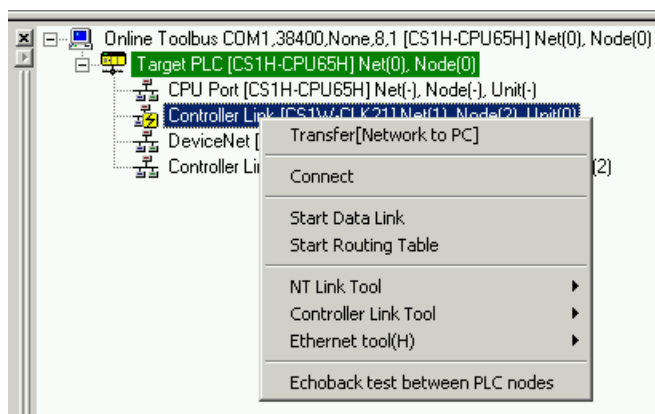

Pop-up menu	Description	Offline	Online	
			Not connected	Connected
Transfer [Network to PC]	Uploads the communications configuration of the selected Communications Unit/port.	No	No	OK
Connect	Enables accessing the selected Communications Unit/port.	No	OK	OK
Start Data Link	Starts the Data Link Component. (Controller Link or SYSMAC Link only)	No	OK	OK
Start Routing Table	Starts the Routing Table Component.	No	OK	---
NT Link Tool - NT Link Auto Online Setting	Automatically detects the communications settings of an NS-series PT that is connected serially to the selected Communications Unit/port, overwrites the PLC serial port's communications settings to match them, and connects automatically.	No	OK	OK
Controller Link Tool – Network diagnosis	Starts the Controller Link Network Diagnostic Tool.	No	OK	OK
Ethernet tool – Ping test	Starts the Ethernet ping test tool.	No	OK	OK
Echoback test between PLC nodes	Starts the echoback test for checking the communications status of the network.	No	OK	OK

## Network Configuration Window

### Pop-up Menu for Components PLCs

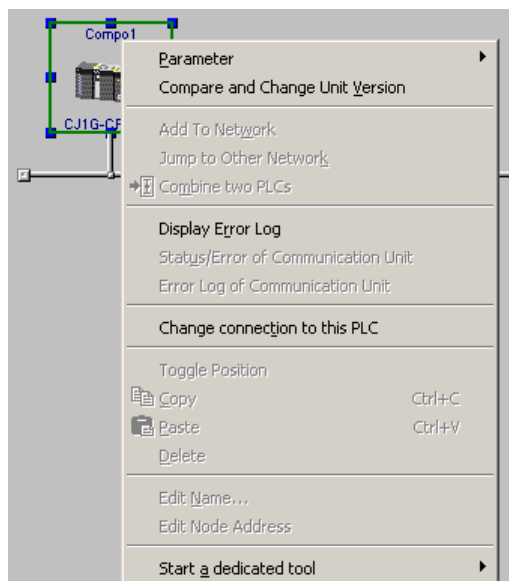

Pop-up menu		Description	Offline	Online
Parameter	Edit	Edits the selected PLC's parameters.	OK	No
	Load	Reads the selected PLC's parameters from a file.	OK	No
	Save	Saves the selected PLC's parameters.	OK	OK
Compare and Change Unit Version		Compares the unit version of the actual component (Unit) with the unit version supported by the software on the computer. Also changes the unit version of the component on the computer to match the unit version of the actual component (Unit).	No	OK
Add To Network		Add the selected PLC to another network.	OK	No
Jump to Other Network		Switches the display to another network to which the selected PLC is connected.	OK	No
Combine two PLCs		Combines two PLCs in different Network Configuration Windows into one PLC	OK	No
Display Error Log Note: You cannot use this menu command for an NJ-series CPU Unit.		Displays present CPU Unit errors and the CPU Unit error log online.	No	OK
Status/Error of Communication Unit		Displays a Communications Unit's status and error information online.	No	OK
Error Log of Communication Unit		Displays a Communications Unit's error log online.	No	OK
Change connection to this PLC		Switches to the selected PLC as the target PLC so it is possible to access that PLC. Allows the network configuration to be read.	No	OK
Toggle Position		Moves a component's icon above or below the network line.	OK	No
Copy		Copies the selected PLC.	OK	No
Paste		Pastes the selected PLC in the network.	OK	No
Delete		Deletes the selected PLC.	OK	No
Edit Name		Changes the selected PLC's name.	OK	No
Edit Node Address		Edits the selected PLC's node address.	OK	No
Start a dedicated tool	Start with Settings Inherited	Starts the associated application while keeping the PLC model settings.	OK	OK
	Start Only	Starts the associated application (CX-Programmer for a PLC).	OK	OK

**1-6 Menus**  
**1-6-2 Pop-up Menus**

**Other Components**

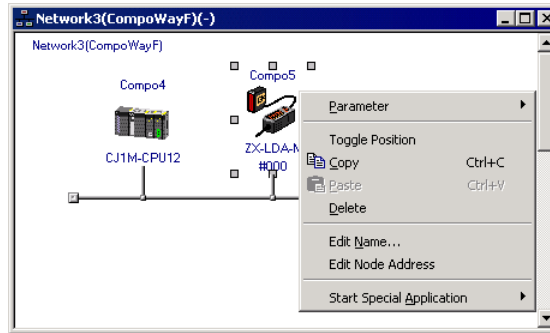

Pop-up menu		Description	Offline	Online
Parameter	Edit	Edits the selected PLC's parameters.	OK	No
	Load	Reads the selected PLC's parameters from a file.	OK	No
	Save	Saves the selected PLC's parameters.	OK	OK
Toggle Position		Moves a component's icon above or below the network line.	OK	No
Copy		Copies the selected PLC.	OK	No
Paste		Pastes the selected PLC in the network.	OK	No
Delete		Deletes the selected PLC.	OK	No
Edit Name		Changes the selected PLC's name.	OK	No
Edit Node Address		Edits the selected PLC's node address.	OK	No
Start Special Application	Start with Settings Inherited	Starts the associated application while keeping the PLC model settings.	OK	OK
	Start Only	Starts the associated application (CX-Thermo for a Temperature Controller).	OK	OK

## DeviceNet Networks

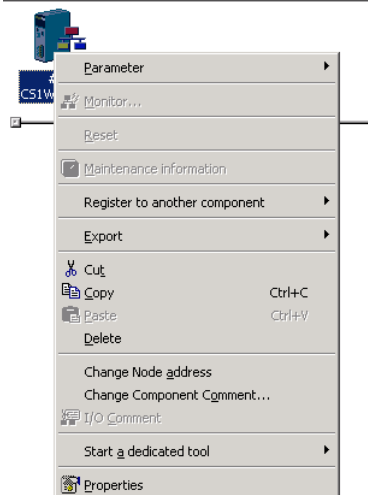

Sub-menu/command		Description	Offline	Online
Parameter	Wizard	Enables setting device parameters with a wizard (for supported devices only).	OK	OK
	Edit	Enables editing device parameters.	OK	OK
	Load	Loads parameters from a device parameter file.	OK	OK
	Save	Saves device parameters to a file.	OK	OK
	Upload	Uploads device parameters from a device on the network.	No	OK
	Download	Downloads device parameters to a device on the network.	No	OK
	Compare	Compare device parameters with the parameters in a device on the network.	No	OK
Monitor		Enables monitoring a device on the network (supported devices only).	No	OK
Reset		Resets a device on the network.	No	OK
Maintenance information		Displays the maintenance information for the selected device.	OK	OK
Resister to another component		Registers the current device to the scan list in another device.	OK	OK
Export	Comment list	Exports I/O comments in CSV format (supported devices only).	OK	OK
	NX-Server DDE Setup File	Scan list information is output in the NX-Server DDE Edition file format.	OK	OK
	NX-Server ONC Setup File	Scan list information is output in the NX-Server ONC Edition file format.	OK	OK
	ONC DRM Unit Setup File	Scan list information is output in the ONC Master parameter file format.	OK	OK
Cut		Cuts the selected device.	OK	No
Copy		Copies the selected device.	OK	No
Paste		Pastes the device on the clipboard.	OK	No
Delete		Deletes the selected device.	OK	No
Change Node Address		Changes the selected device's node address.	OK	No
Change Device Comment		Changes the selected device's description (comment).	OK	No
I/O Comment		Enables editing I/O comments.	OK	No
Start a dedicated tool	Start with Settings Inherited	Starts the associated application while keeping the PLC model settings.	OK	OK
	Start Only	Starts the associated application.	OK	OK
Properties		Displays the properties of the device.	OK	OK

**1-6 Menus**  
**1-6-2 Pop-up Menus**

**CompoNet Networks**

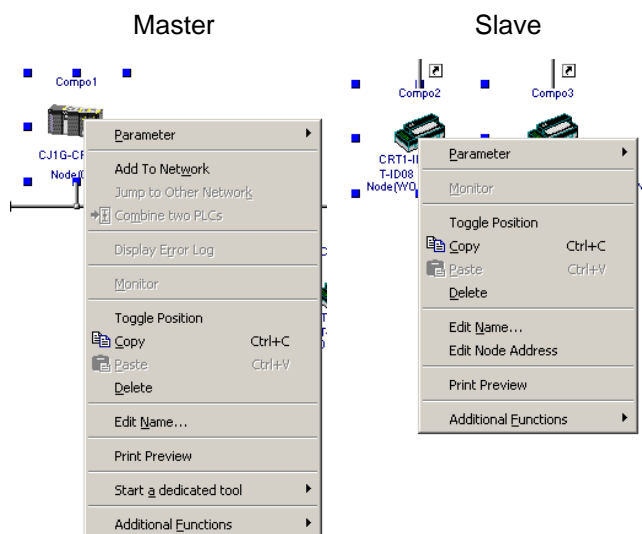

Sub-menu/command		Description	Offline	Online
Parameter	Edit	Enables editing device parameters.	OK	OK
	Load	Loads parameters from a device parameter file.	OK	No
	Save	Saves device parameters to a file.	OK	OK
Add To Network (master only)		Adds the PLC to which the selected master is connected to another network.	OK	No
Jump to Other Network (master only)		Switches the display to another network to which the PLC of the selected master is connected.	OK	No
Combine two PLCs (master only)		Combines two PLCs in different Network Configuration Windows into one PLC.	OK	No
Display Error Log (master only)		Displays present errors and the CPU Unit error log online of the CPU Unit to which the selected master is connected.	No	OK
Monitor		Enables monitoring a device on the network (supported devices only).	No	OK
Toggle Position		Moves a component's icon which is shown in the Network Configuration Window above or below the network line.	OK	No
Copy		Copies the selected device.	OK	No
Paste		Pastes the device on the clipboard.	OK	No
Delete		Deletes the selected device.	OK	No
Edit Name		Changes the selected device's name.	OK	No
Edit Node Address (slave only)		Edits the selected device's node address.	OK	No
Print Preview		Displays the print preview for the selected device's parameters.	OK	OK
Start a dedicated tool	Start with Settings Inherited	Starts the associated application while keeping the communication settings of the PLC to which the selected master is connected.	No	OK
	Start Only	Starts the associated application.	OK	OK
Additional Functions		Starts the device's additional functions. The functions depend on the device. For details on functions, refer to the corresponding Unit manual.	OK	OK

## Workspace Window

### Pop-up Menu for the Project Name or Network

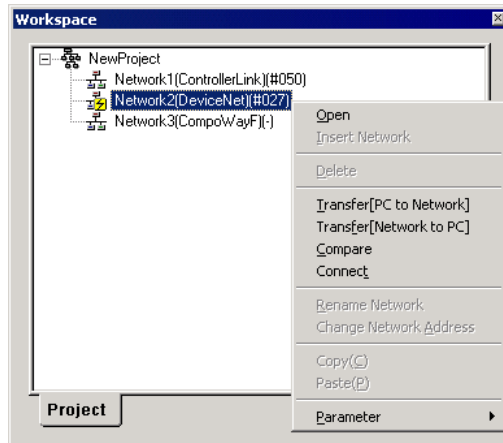

Pop-up menu	Selected	Description	Offline	Online		
				Not connected	Connected	
Open	Network	Displays the network configuration of the selected network in the Network Configuration Window.	OK	OK	OK	
Insert Network	Project name	Adds a new network on the computer.	OK	No	No	
Delete	Network	Deletes a virtual network from the computer.	OK	No	No	
Transfer [PC to Network]	Network	Downloads the network configuration (including component parameters) of a virtual network on the computer to the network with the same network address.	No	No	OK	
Transfer [Network to PC]		Uploads the network configuration and component parameters from the actual network to the virtual network on the computer for the actual network of the same network address as the virtual network.	No	No	OK	
Compare		Compares the virtual network on the computer to the network configuration of the actual network (without component parameters).	No	No	OK	
Connect		Enables access the virtual network on the computer.	No	OK	OK	
Rename Network		Changes the name of a virtual network on the computer.	OK	OK	OK	
Change Network Address		Changes the network address of a virtual network on the computer.	OK	No	No	
Copy		Copies the selected network.	OK	No	No	
Paste		Project name	Pastes the virtual network that was copied offline.	OK	No	No































**1-6 Menus**  
**1-6-2 Pop-up Menus**

Pop-up menu		Selected	Description	Offline	Online	
					Not connected	Connected
Parameter	Edit	Network	Edits the network parameters of a virtual Controller Link network on the computer (Controller Link or SYSMAC Link only).	OK	OK	OK
	Load		Reads the network parameters from a network parameter file to the selected network.	OK	OK	No
	Save		Writes the selected network's network parameters to a network file.	OK	OK	No
	Transfer [PC to Network]		Downloads the network parameters from the computer to the network.	No	No	OK
	Transfer [Network to PC]		Uploads the actual network's network parameters to the computer.	No	No	OK
	Compare		Compares the computer's network parameters with the actual network parameters.	No	No	OK















## 1-6-3 Toolbars

The most commonly used functions are provided as icons on toolbars.  
The following menu commands are allocated to these icons.

Icon	Description	Actual menu command
	Creates a new project.	File - New
	Opens a project file.	File - Open
	Saves a project.	File - Save
	Print.	File - Print
	Print Preview.	File - Print Preview
	Undo.	Edit - Undo
	Redo.	Edit - Redo
	Cuts devices.	Edit - Cut
	Copies devices.	Edit - Copy
	Pastes devices.	Edit - Paste
	Switches between working offline and online with the device type setting in the computer.	Network - Work Online
	Enables changing device type settings on the computer.	Network - Communication Settings
	Automatically connects to the relay PLC using the communications settings of the PLC (supported for serial communications only).	Network - Auto Online
	Downloads a network configuration created offline in the Network Configuration Window to the Communications Unit selected in the Online Connection Information Window.	Network - Transfer [PC to Network]
	Uploads the network configuration of the Communications Unit selected in the Online Connection Information Window.	Network - Transfer [Network to PC]
	Compares a network configuration created offline in the Network Configuration Window with network configuration of the Communications Unit selected in the Online Connection Information Window.	Network - Compare
	Increases or decreases the magnification of the components displayed in the Network Configuration Window.	View - Zoom
	Displays the next higher network layer.	Network - Move to upper network
	Displays the next lower network layer.	Network - Move to Lower network
	Maintenance Information Update	Network - Updates Maintenance information
	Displays the windows in network configuration mode.	View - Large Icons
	Maintenance mode	View - Large Icons Maintenance Mode
	Displays the windows in detailed report mode.	View - Detail
	Device parameter wizard.	Component - Parameter - Wizard
	Edits device parameters.	Component - Parameter - Edit
	Reads parameters from device parameter files.	Component - Parameter - Read
	Saves device parameters in files.	Component - Parameter - Save
	Uploads device parameters.	Transfer [Component to PC]
	Downloads device parameters.	Transfer [PC to Component]
	Maintenance information	Component - Maintenance information
	Monitors supported network devices.	Component - Monitor

**1-6 Menus**  
**1-6-3 Toolbars**

Icon	Description	Actual menu command
	Edits I/O comments.	Component - I/O Comment
	Adds new EDS files.	Tools - EDS file - Install EDS
	Deletes EDS files.	Tools - EDS file - Delete
	Saves a new EDS file with a new EDS file name.	Tools - EDS file - Save
	Inserts components.	Insert - Component
	Searches for EDS files.	Tools - EDS file - Find
	Displays EDS file properties.	View - Properties
	Inserts T-Branch.	Insert - T-Branch
	Combine two PLCs	Right-click the device and select <b>Combine two PLCs</b> from the pop-up menu
	Network View Setting	Right-click the <b>Network View Setting</b> Icon and select <b>Network View Setting</b> from the pop-up menu.
	Updates online information.	View - Update of Online information window
	Updates DTM Catalog.	Tools - Update DTM Catalog

# **Communications**

## **Section 2 Basic Operations**

This section describes the basic operations used for the CX-Integrator.

## 2-1 Basic Procedures

This section describes the overall procedures used for the CX-Integrator.

Basic procedure		Page
Uploading Network Configurations Online	PLCs with Only One Network Communications Unit	2-2-2
	PLCs with More Than One Network Communications Unit	2-2-3
Uploading Network Configurations from Target PLCs Other than the Relay PLC		2-2-5
Reading Network Configurations and Parameters from Actual Networks and Saving Them to Files Online		2-2-6
Designing DeviceNet, CompoNet, and CompoWay/F Networks Offline		2-2-7
Reading Saved Parameters and Downloading Them Online to DeviceNet, CompoNet, or CompoWay/F Components		2-2-8
Directly Connecting the Computer Running CX-Integrator to CompoWay/F Components without Going Through a PLC		2-2-9

### Uploading Network Configurations Online

The PLC that is initially connected online from the CX-Integrator is called the relay PLC. The relay PLC is connected directly, either serially or through a network. The network configuration and component parameters of the relay PLC can be uploaded.

#### PLCs with Only One Network Communications Unit

If the relay PLC (which is the target PLC when the online connection is first made) has only one Network Communications Unit (see note), it is not necessary to create and transfer a local network table.

**Note:** In this context, the following are Network Communications Units: Ethernet Unit, Controller Link Unit, SYSMAC LINK Unit, DeviceNet Unit, FL-net Unit, EtherNet/IP Unit, built-in EtherNet/IP port, or Serial Communications Board/Unit (when the serial port is treated as a Network Communications Unit). EtherNet/IP Units and built-in EtherNet/IP ports are treated as Ethernet Units.

#### Overall Procedure

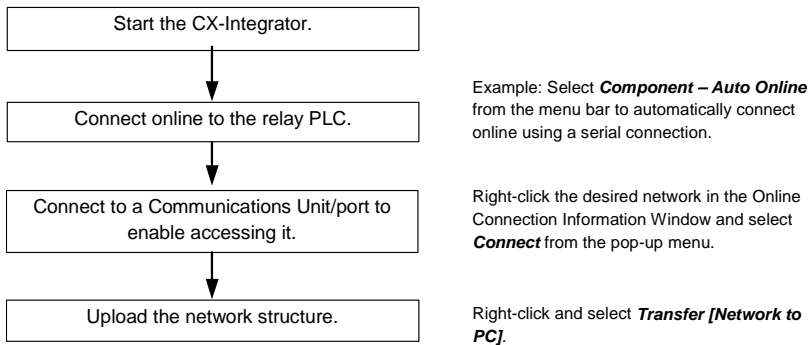

#### Network Configuration Example

Computer running CX-Integrator

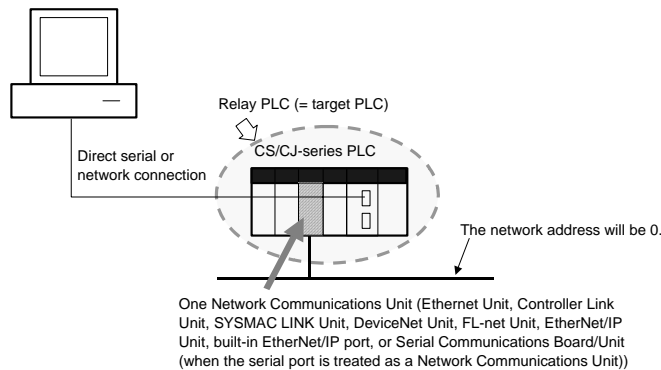

### PLCs with More Than One Network Communications Unit

If the relay PLC has more than one Network Communications Unit (see note 1), it is normally necessary to create and transfer a local network table (see note 2).

Select **Tools – Start Routing Table** to start the Routing Table Component, set the local network table, and download it to the relay PLC.

**Note 1:** In this context, the following are Network Communications Units: Ethernet Unit, Controller Link Unit, SYSMAC LINK Unit, DeviceNet Unit, FL-net Unit, EtherNet/IP Unit, or built-in EtherNet/IP port: If serial ports are registered in the local network table to treat them as networks, the serial ports must be treated as Network Communications Units, including the serial ports on the CPU Unit. An EtherNet/IP Unit, built-in EtherNet/IP port, or Ethernet Unit can be used.

**Note 2:** The local network table is one of the routing tables. It lists the unit numbers and network addresses of the network Communications Units.

Number of Network Communications Units	Local network table registration
Only 1	Not required
More than 1	Required

### Overall Procedure

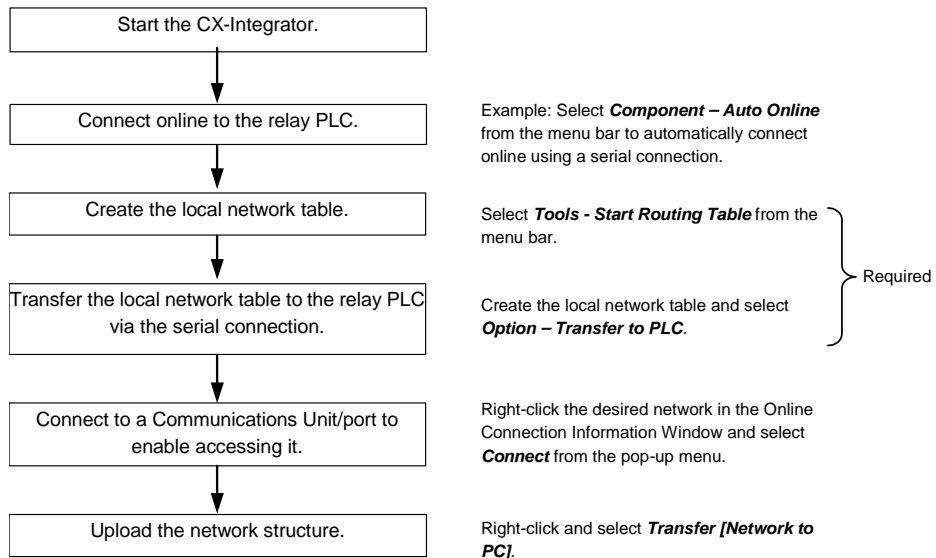

### Network Configuration Example

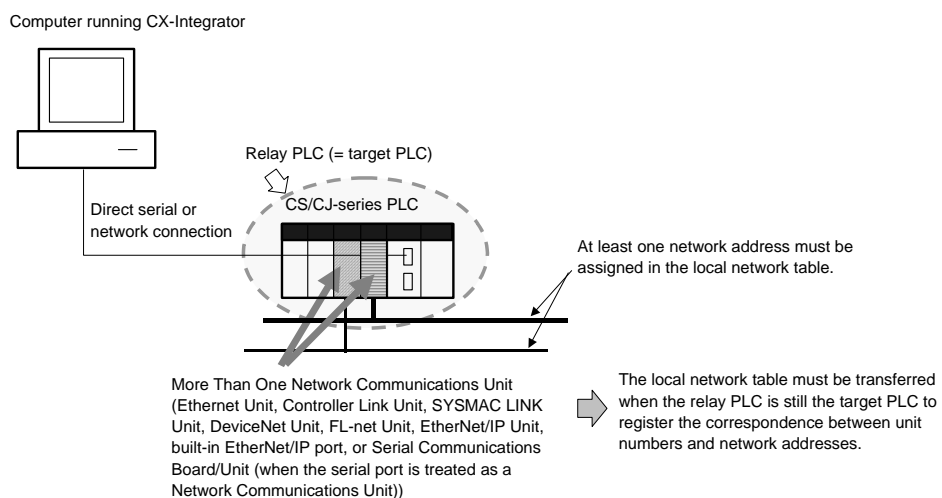

**Note**

1. A local network table must be registered in the CPU Unit when the target PLC has more than one Network Communications Unit, except in the case outlined below. Even if an online connection is made to a PLC, it will not be possible to upload or download the network configurations unless a local network table is registered.
2. When any other tools are connected via the USB port in a CJ2-series CPU Unit, make the tools offline, and then connect CX-Integrator online.

**Note**

The following case is an exception to the rule that a local network table must be registered if there are two or more Network Communications Units mounted.

**Overview:** If a local network table is not registered and a direct serial connection is made to a target PLC in which two or more Network Communications Units are mounted, it will be possible to access only the network of the Communications Unit with the lowest unit number.

In this case, the network address of each network will be 0 and the network addresses will be displayed as “-” in the Online Connection Information Window.

**Procedure:** Connect online to the relay PLC. Open the Online Connection Information Window and right-click the Network Communications Unit with the lowest unit number and select **Connect** from the pop-up menu. That Network Communication Unit’s network is the only network that will be accessible.

**Computer running CX-Integrator**

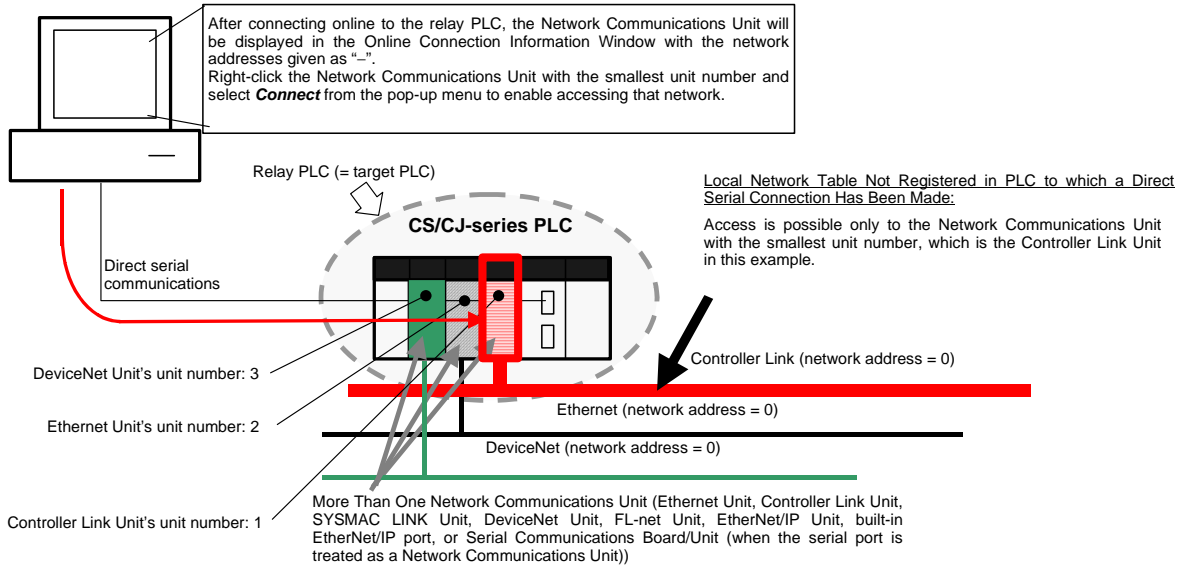

## Uploading Network Configurations from Target PLCs other than the Relay PLC

The network configuration of another PLC can be read via the PLC that was first connected to the computer (known as the relay PLC). To read another PLC's network configuration, switch the target PLC from the relay PLC to the desired PLC connected. At this point, it is possible to upload the configuration of the network (including component parameters) of the network connected to that target PLC.

Note: When accessing a target PLC other than the relay PLC, observe the following two precautions, set routing tables, and transfer them to the PLCs.

- Always create local network tables and transfer them to the relay PLC and target PLC.
- When specifying a target PLC in another network, register both local network tables and relay network tables in all of the PLCs on the path between the relay PLC and target PLC.

### Overall Procedure

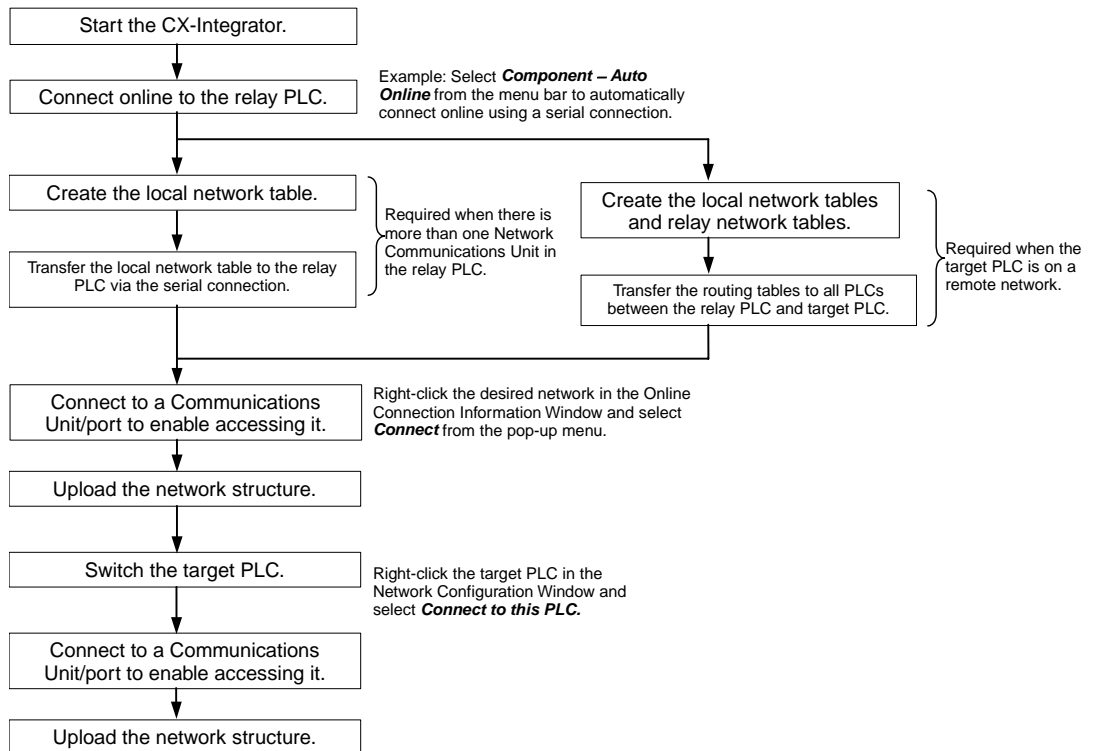

**Reading Network Configurations and Parameters from Actual Networks and Saving Them to Files Online**

To simplify maintenance, the target PLC's actual network configuration and component parameters can be uploaded and saved in a project file (.cin) for each network.

**Overall Procedure**

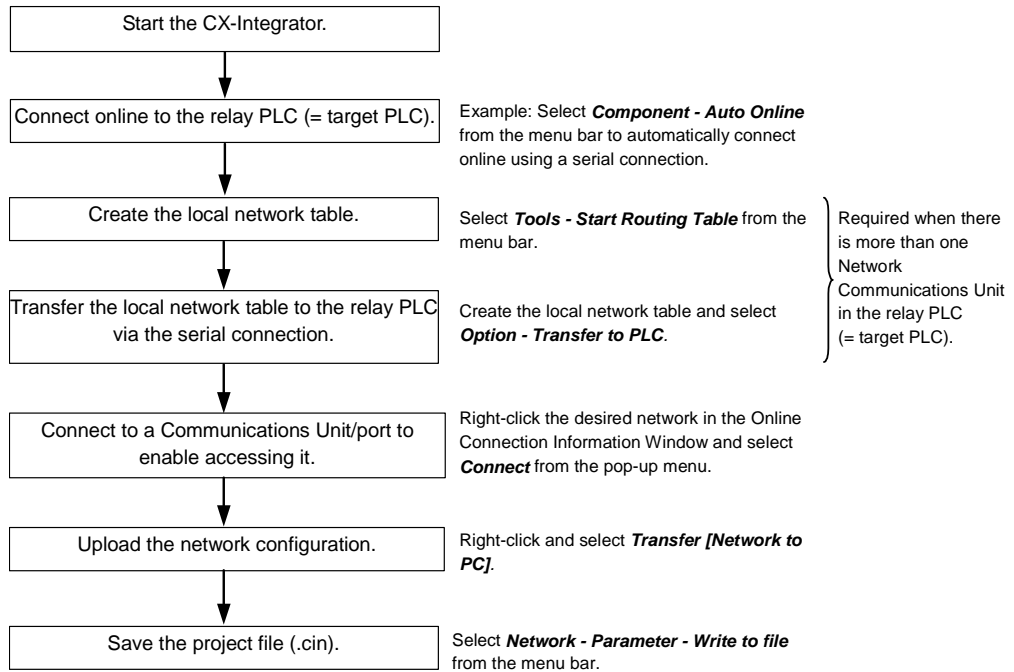



## Designing DeviceNet, CompoNet, and CompoWay/F Networks Offline

Networks can be designed on the CX-Integrator even before they have been installed. Parameters for individual DeviceNet and CompoNet masters and slaves can be set. Parameters for individual CompoWay/F slaves can be set. The specified parameters can be saved in project files. All DeviceNet device, CompoNet, and CompoWay/F component properties are included in the project file (.cin).

### Overall Procedure

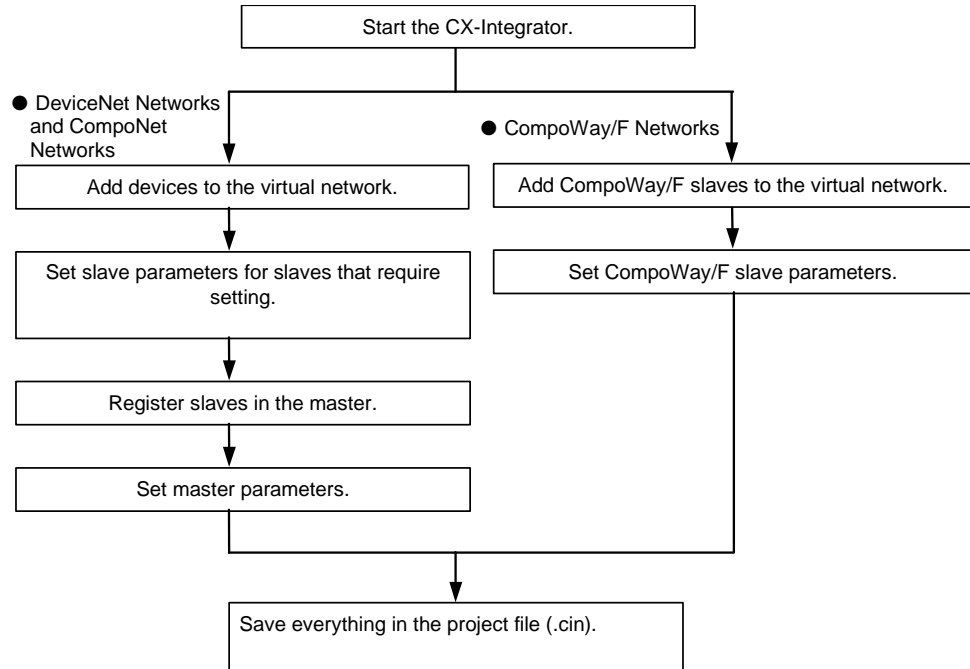

**Reading Saved Parameters and Downloading Them Online to DeviceNet, CompoNet, or CompoWay/F Components**

All of the component parameters on a network can be downloaded to the actual components from a previously saved project file (.cin) after the network has been installed. Parameters can also be downloaded for individual components.

**Overall Procedure**

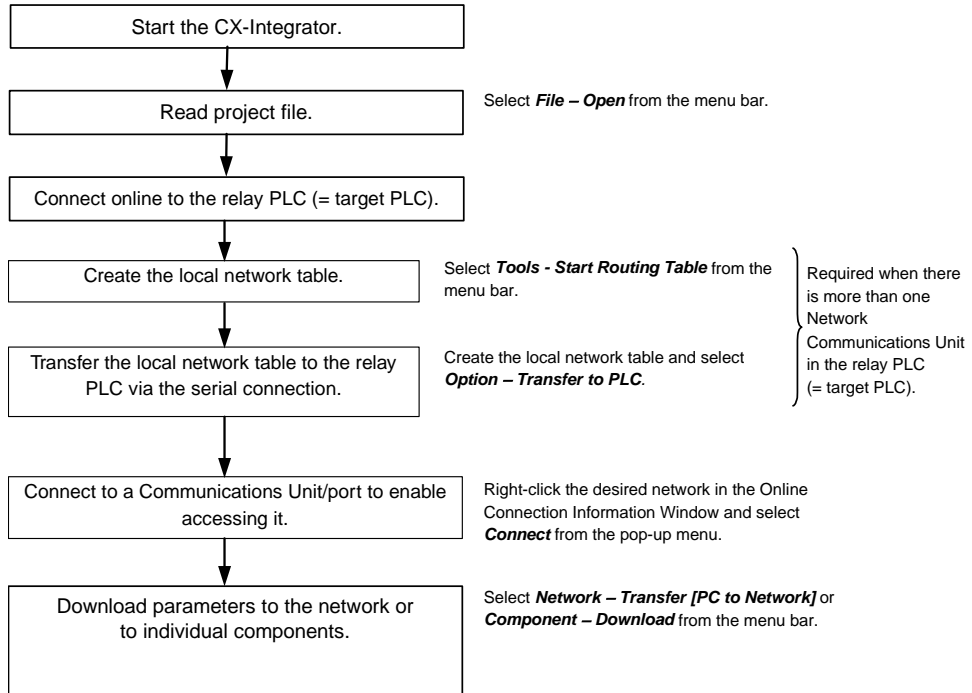

## Directly Connecting the Computer Running CX-Integrator to CompoWay/F Components without Going Through a PLC

Uploading the CompoWay/F network configuration is possible through a direct connection from the CX-Integrator to CompoWay/F protocol components using RS-232C or RS-485 communications without going through a PLC. Component parameters can also be set.

### **Overall Procedure**

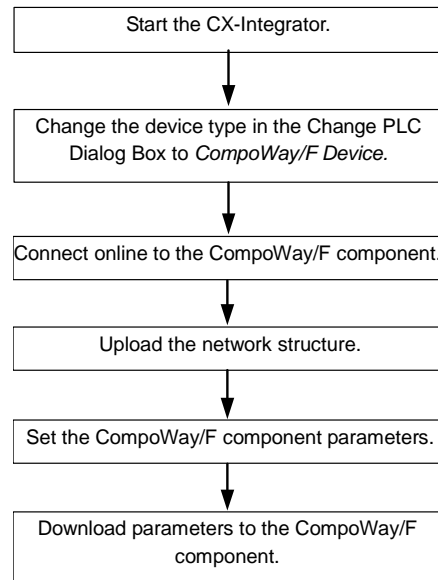

## 2-2 Connecting Online to the Relay PLC

### 2-2-1 Overview

## 2-2 Connecting Online to the Relay PLC

### 2-2-1 Overview

To use the CX-Integrator, the computer must first connect online to a PLC connected through a direct serial connection or another PLC in the network (known as the relay PLC). Once the online connection is established with the relay PLC, another PLC can be specified as the target PLC and accessed through the relay PLC. Normally, the same PLC is both the relay PLC and the target PLC.

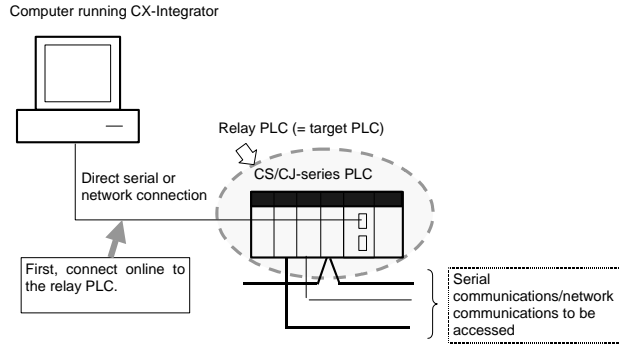

**Note:** If an online connection is made to the relay PLC, the same PLC will be both the relay PLC and the target PLC. Once the relay PLC has been connected to online, the network configuration can be uploaded or the target PLC can be changed to a different PLC.

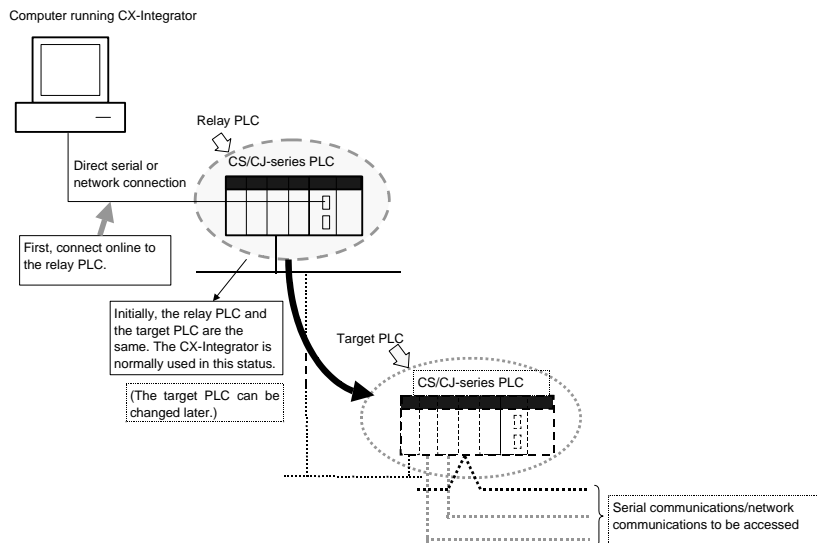

After connecting online to the relay PLC, check for CPU Unit errors, eliminate the cause of the errors, and clear the errors.

## 2-2-2 Procedures

An online connection to the relay PLC can be established automatically or manually.

### Automatic Online Connection

For automatic connections, the communications settings are automatically set to those of the PLC (i.e., the user does not have to make any communications settings on the computer).

1. Select **Network – Auto Online** from the menu bar or click the  icon.

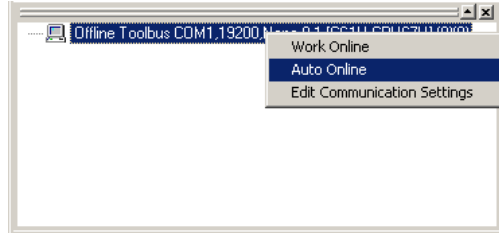

The Auto Online Dialog Box will be displayed.

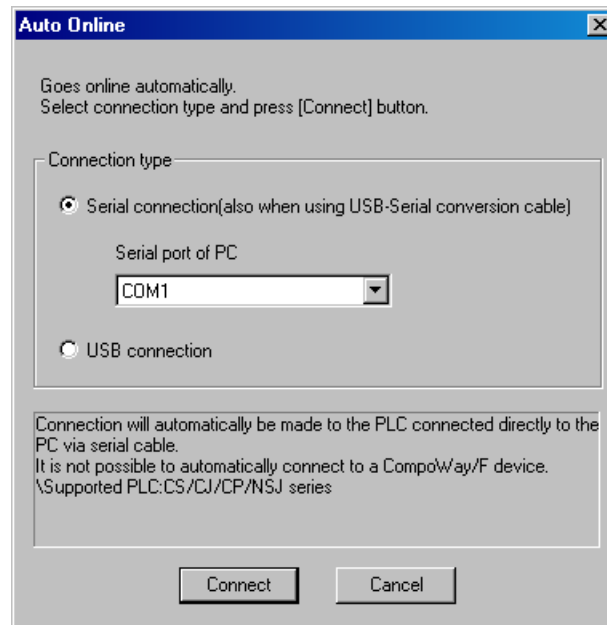

2. Select the connection method.
  - If the connecting port at the PLC is a serial port (peripheral, RS-232C, or RS-422/485), check the box for a serial connection (including when Serial-USB conversion cable is used). From the *Serial port of PC* pull-down list, select the COM port for the computer that is to be used.
  - If the connecting port is the USB port on the CJ2 CPU Units, NSJ-series or CP-series PLCs, select *USB connection*.Depending on the connection method selected, follow the procedures described below.

**2-2 Connecting Online to the Relay PLC**  
**2-2-2 Procedures**

**When Serial Connection Is Selected**

1. Detection of the serial connection method will start and the Auto-Connecting Dialog Box will be displayed.

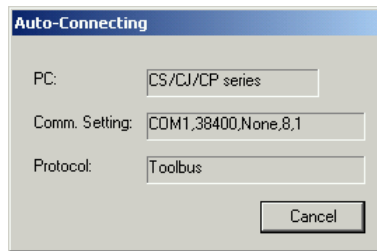

2. If automatic connection with the PLC is successful, the online status and information on the target PLC will be displayed in the Online Connection Information Window.

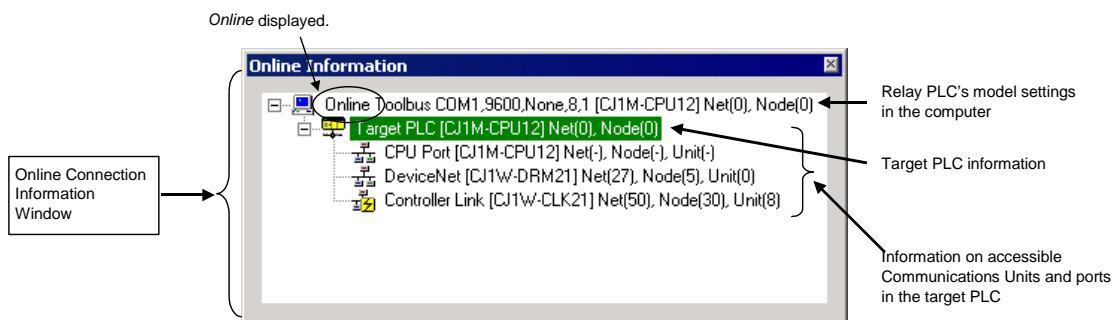

- Note 1:** The device type information that was uploaded can be checked offline by clicking the icon or selecting **Network - Communications Settings** from the menu bar.
- Note 2:** Once an automatic connection has been made, switching between offline and online is possible by clicking the icon or selecting **Network - Work Online** from the menu bar. If the network and node address settings for the relay PLC and the target PLC are the same, the Unit that was connected immediately before will be automatically connected again the next time online.
- Note 3:** When connecting online for the first time after opening a project, the target Unit will be determined in the following order.
1. The Unit with the same network and node addresses.
  2. When a routing table is set for the target PLC, the communicating Unit or port with the lowest network address in the target networks.

**When USB Connection Is Selected**

(You can select a USB connection for a CJ2 CPU Unit, NSJ-series Controller, or NJ-series Controller.)

1. Detection of the selected connection method will start and the Auto-Connecting Dialog Box will be displayed.

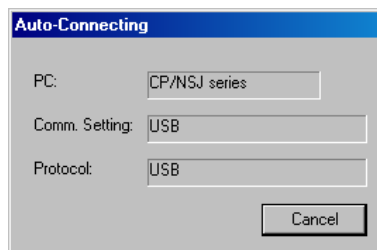

2. If automatic connection with the Controller is successful, just as with serial connection, the online status and information on the target Controller will be displayed in the Online Connection Information Window.

## Manual Online Connections

For a manual connection, the communications settings of the relay PLC on the computer are set first before an online connection is made.

### **Communications Settings**

Select **Network – Communication Settings** from the menu bar, click the  communications setting icon.

The Change PLC Dialog Box will be displayed.

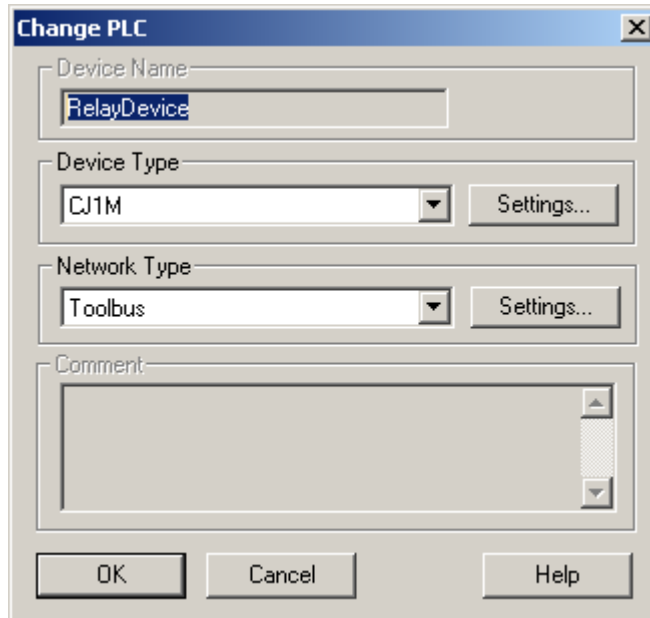

**2-2 Connecting Online to the Relay PLC**  
**2-2-2 Procedures**

Item	Contents		
Device Name	Relay Device (fixed)		
Device Type	Series	Device Type	CPU Unit model
	NJ Series	NJ	NJ501-1300/1400/1500, NJ301-1100/1200
	CS Series	CS1H	CS1H-CPU67/66/65/64/63(-V1)
		CS1G/CJ1G	CS1G-CPU45/44/43/42(-V1)
		CS1G-H	CS1G-CPU45H/44H/43H/42H
		CS1H-H	CS1H-CPU67H/66H/65H/64H/63H
		CS1D-H	CS1D-CPU67H/65H
		CS1D-S	CS1D-CPU67S/65S/44S/42S
	CJ Series	CJ2H	CJ2H-CPU□□(-EIP) (See note 1.)
		CJ2M	CJ2M-CPU11/12/13/14/15/31/32/33/34/35
		CS1G/CJ1G	CJ1G-CPU45/44
		CJ1M	CJ1M-CPU23/22/21/13/12/11
		CJ1G-H	CJ1G-CPU45H/44H/43H/42H, CJ1G-CPU45P/44P/43P/42P
		CJ1H-H	CJ1H-CPU67H/66H/65H CJ1H-CPU67H-R/66H-R/65H-R/64H-R
	CP-Series	CP1H	CP1H-XA□□□□-□
			CP1H-X□□□□-□
			CP1H-Y□□□□-□
		CP1L	CP1L-M□□□□-□
			CP1L-L□□□□-□
		CP1L-E	CP1L-EM□□□□-□ CP1L-EL□□□□-□
	NSJ Series	NSJ	G5D (Used for the NSJ5-TQ0□-G5D, NSJ5-SQ0□-G5D, NSJ8-TV0□-G5D, NSJ10-TV0□-G5D, and NSJ12-TS0□-G5D.) M3D (Used for the NSJ5-TQ0□-M3D, NSJ5-SQ0□-M3D, and NSJ8-TV0□-M3D.)
	---	CompoWay/F Device	Select CompoWay/F Device to connect the computer running CX-Integrator directly as a CompoWay/F slave using serial communications.
	SYSMAC CS1 Board	CS1G/CJ1G	CS1PC-PC101-DRM (CS1G-CPU45, See note 2.)
CS1G-H		CS1PC-PC101H-DRM (CS1G-CPU45H, See note 2.)	
Network Type	Select one of the following network types.		
	Network type	Contents	
	Toolbus	Select to connect the computer with a direct serial connection using the Toolbus protocol. Note: The Toolbus (peripheral) protocol is faster than the SYSMAC WAY protocol. Serial connections are generally made using this network type.	
	Toolbus (USB port)	Select to directly connect the computer to a CJ2 CPU Unit with a USB cable. (See note 1.)	
	SYSMAC WAY (See note 3.)	Select to connect the computer with a direct serial connection using the SYSMAC WAY protocol. Note: The SYSMAC WAY protocol enables 1:N connections, which are not possible for the Toolbus protocol.	
	Ethernet	Select to connect the computer directly to an Ethernet network using the Ethernet UDP/IP protocol. (See note 1.)	
	Ethernet (FINS/TCP)	Select to connect the computer directly to an Ethernet network using the Ethernet TCP/IP protocol. (See note 1.)	
	FinsGateway (See note 3.)	Select to use FinsGateway for communications. (Selected when using FinsGateway for all communications.) Note: If FinsGateway is selected, connection will not be possible to a DeviceNet, CompoNet, or CompoWay/F network.	
	Controller Link (See note 3.)	Select to connect the computer directly to a Controller Link network through a Controller Link Support Board.	
	SYSMAC LINK (See note 3.)	Select to connect the computer directly to a SYSMAC LINK network through a SYSMAC LINK Support Board.	
	CompoWay/F	Select to connect the computer with a direct serial connection to a CompoWay/F slave.	
	USB	Select this network type to use a USB cable to connect the computer to a CJ-series PLC, NSJ-series Controller, CJ2 CPU Unit, or NJ-series Controller.	
CS1 Board (See note 3.)	Select to connect the computer with a SYSMAC CS1 Board. (See note 2.)		



- Note 1:** With a CJ2H-CPU6□-EIP or CJ2M-CPU3□ CPU Unit, connecting to an Ethernet network is not possible from the built-in EtherNet/IP port or an EtherNet/IP Unit port if the network connection is set for EtherNet/IP. Always set Ethernet or Ethernet (FINS/TCP) to connect to an Ethernet network. In addition, connection is impossible when “USB” is selected in the network settings. Select “Toolbus (USB port)”.
- Note 2:** When connecting online with a SYSMAC CS1 Board, specify one of the device types in parentheses. *CS1 Board* can be selected as the network type only when one of these device types is selected.
- Note 3:** The following functions cannot be used when running the CX-Integrator on Windows Vista or Windows 7.
- Online connections to PLCs on Controller Link networks are not possible through a Controller Link Support Board when Controller Link is selected as the network type.
  - Online connections to PLCs on SYSMAC LINK networks are not possible through a SYSMAC LINK Support Board when SYSMAC LINK is selected as the network type.
  - Online connections to PLCs on SYSMAC NET networks are not possible through a SYSMAC NET Support Board when SYSMAC NET is selected as the network type.
  - Online connections to CS1 Boards in computers are not possible when "CS1 board" is selected as the network type.
  - Online connections to SYSMAC Boards in computers are not possible when "SYSMAC Board" is selected as the network type.
  - Online connections to PLCs on the network are not possible when FinsGateway is selected as the network type.

Click the **Settings** Button to display the Network Settings Dialog Box for each type of network. Details are described here for Toolbus, SYSMAC WAY, and Ethernet. Refer to the *CX-Programmer Operation Manual* (Cat. No. W446) for other methods.

**Toolbus**

Click the **Driver** Tab and set the following settings as required.

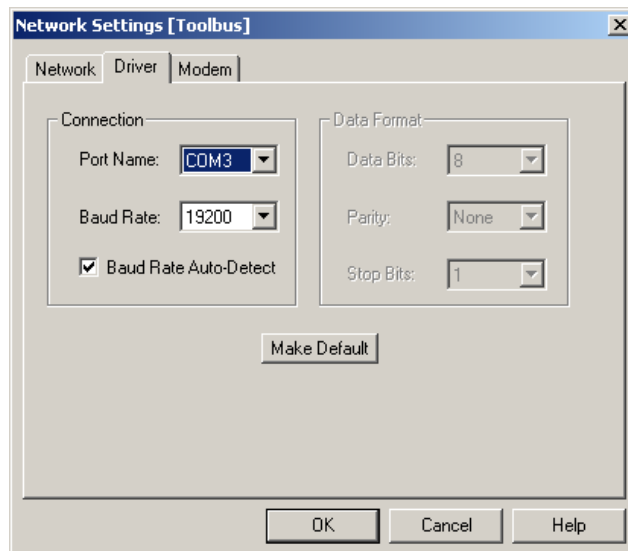

- Port Name:** Select the computer’s COM port from the drop-down list.
- Baud Rate:** Select the baud rate (bits/s) from the drop-down list.
- Baud Rate Auto-Detect:** Clear this selection to connect with the baud rate set on the computer, ignoring the baud rate of the serial port on the CPU Unit. To disable automatic detection of the baud rate, the DIP switch on the CPU Unit must be set as follows:

**2-2 Connecting Online to the Relay PLC**  
**2-2-2 Procedures**

For peripheral port connection: Pin 4 of the DIP switch must be OFF (automatic detection of communications settings: use Programming Console or CX-Integrator settings).

For RS-232C port connection: Pin 5 of the DIP switch must be ON (automatic detection of communications settings: use CX-Integrator settings).

**Note** For automatic baud rate detection with the Toolbus protocol, the baud rate setting on the computer is used and the serial port on the CPU Unit is set to the same value. For automatic online connections, the communications settings (device type, serial communications mode, baud rate, and other communications settings) of the serial port on the CPU Unit are detected and the device type information on the computer are set to the same values.

### SYSMAC WAY

Click the **Driver** Tab and set the following settings as required.

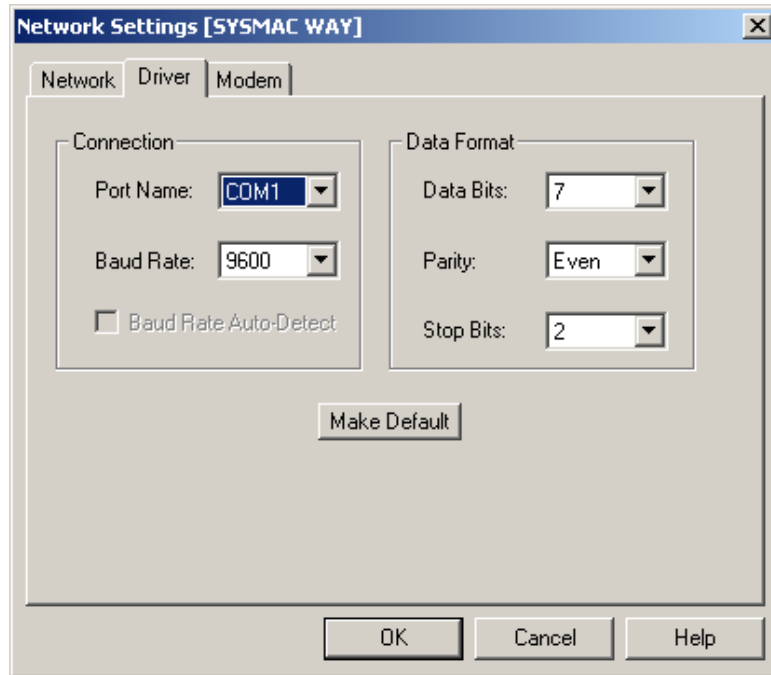

- Port Name: Select the computer's COM port from the drop-down list.
- Baud Rate: Select the baud rate (bits/s) from the drop-down list.
- Data Format: Select the data length (data bits), parity, and number of stop bits from the pull-down lists.
- Data Bits: 7 or 8 (Settings of 4 to 6 are not used.)
- Parity: Even, odd, none, mark (no parity), or space (no parity)
- Stop bits: 1 or 2

### Ethernet

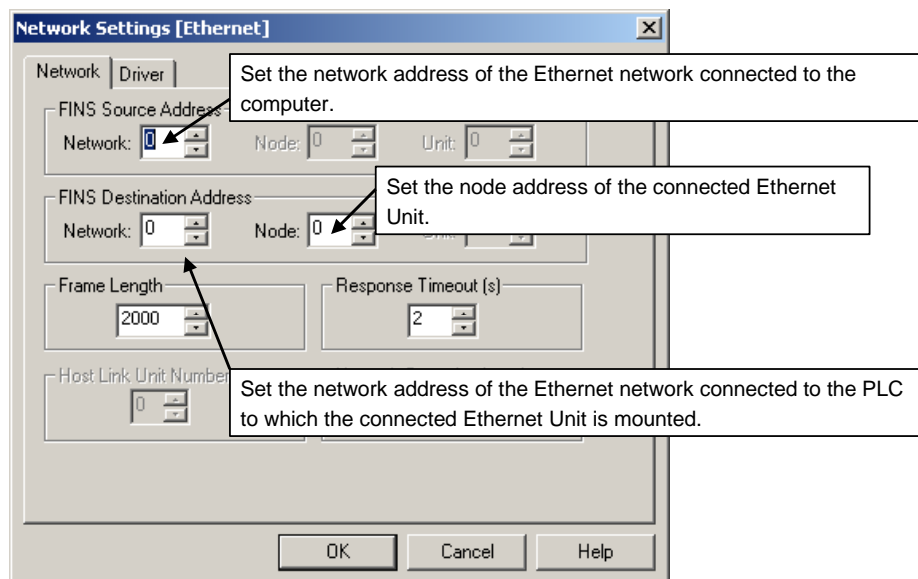

**2-2 Connecting Online to the Relay PLC**  
**2-2-2 Procedures**

Field name on Network Tab Page	Item	Contents	Settings
FINS Source Address	Network	Set the network address of the Ethernet network connected to the computer.	1 to 127 Use the default setting of 0 if there is only one Ethernet Unit in the PLC and only one network is being used.
FINS Destination Address	Network	Set the network address of the Ethernet network connected to the PLC to which the connected Ethernet Unit is mounted.	1 to 127 Use the default setting of 0 if there is only one Ethernet Unit in the PLC and only one network is being used.
	Node	Set the node address of the connected Ethernet Unit. Set the node address set on the rotary switches on the Ethernet Unit.	1 to 254
	Frame Length	Set the maximum frame length. Do not change the default setting.	CS/CJ-series PLCs: 2,000 bytes CVM1/CV-series PLCs: 1,950 bytes
	Response Timeout	This is the timeout time for receiving a response. Increase this setting only if there are many communications errors.	2 s

Click the **Driver** Tab and set the following settings as required.

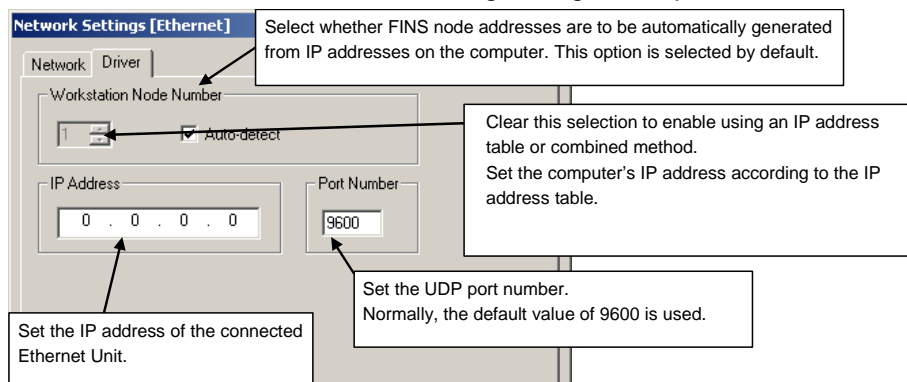

Field name on Driver Tab Page	Contents		Settings
Workstation Node Number	Auto-detect	Selected (default).	The node number (node address) is automatically created based on the IP address of the computer. The node number on the left will be grayed out and the node number will be the least-significant digit of the IP address of the computer at that time.
		Selection cleared.	Clear this selection to enable using an IP address table or combined method. The workstation node address on the left can be input when the selection is cleared.
	The node address of the computer is set when the <i>Auto-detect</i> selection is cleared (IP address table or combined method).		1 to 254
IP Address	Set the IP address of the connected Ethernet Unit. Note: The IP address setting method and default depends on the model of Ethernet Unit being used. Refer to the operation manual of the Ethernet Unit for details.		Default IP address for the CS1W-ETN21/CJ1W-ETN21 Ethernet Unit: <i>192.168.250.FINS_node_address</i>
Port Number	Set the UDP port number. Normally, the default value of 9600 should be used.		1 to 65535 Default: 9600

**Setting the IP Address Table at the CX-Integrator (Computer)**

When Ethernet is selected as the network type in the communications settings, and the IP conversion for any node on Ethernet (i.e., an Ethernet Unit or personal computer) is set for either the IP address table method or the combined method, the IP address table at the CX-Integrator (personal computer) must be preset. (For details on IP conversion, refer to the *Ethernet Units Construction of Networks Operation Manual*.)

1. Select **Communication Settings** from the Network Menu.

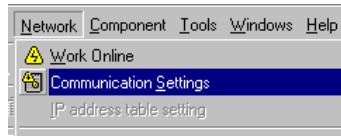

2. The Change PLC Dialog Box will be displayed.

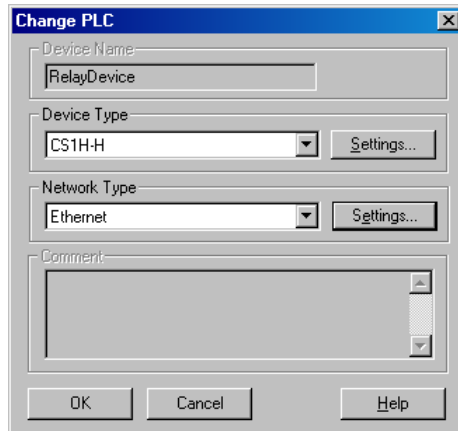

3. Select Ethernet as the network type, and click the **Settings** Button. The Network Settings [Ethernet] Dialog Box will be displayed.

**2-2 Connecting Online to the Relay PLC**  
**2-2-2 Procedures**

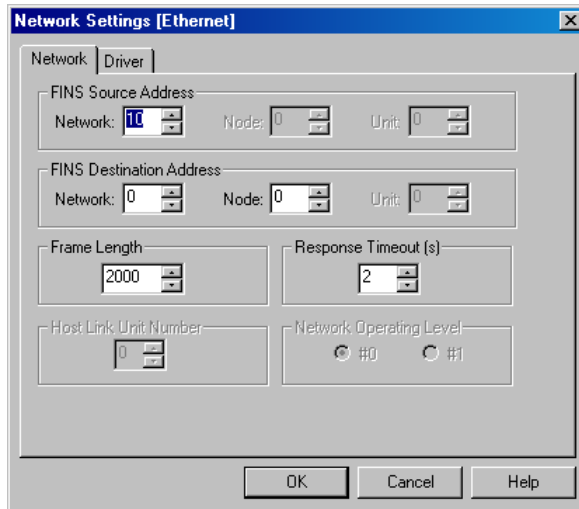

4. For *Network*, under *FINS Destination Address*, enter the network address of the network to be connected, and then click the **OK** Button.
5. Select **IP address table setting** from the Network Menu.

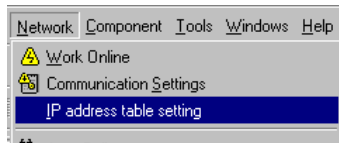

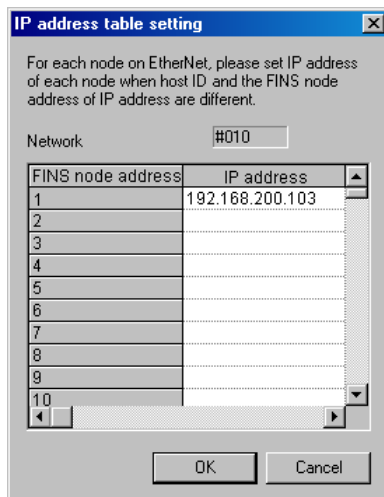

6. The IP address table setting Dialog Box will be displayed.



In the *IP address* column, enter the IP address corresponding to the FINS node address. Enter the IP address for all nodes for which the conversion is set for either the IP address table method or the combined method, and click the **OK** Button to complete the setting. It need not be input for nodes for which the conversion is set for automatic generation (either dynamic or static).

**Note** If the IP address table is not set correctly, the target node may not be displayed when network uploads are executed.

## Online Connection

Click the  Online Connection Icon or select **Network – Work Online** from the menu bar to go online. The  Online Icon will be displayed in the Online Connection Information Window. The following will appear in the status bar at the same time:

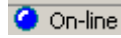

**Note** With the CX-Integrator version 2.1 or higher, the CX-Integrator can be directly connected through Ethernet to a PLC without a transferred routing table by setting the Ethernet IP address to network address 0 and node address 0, and connecting online.

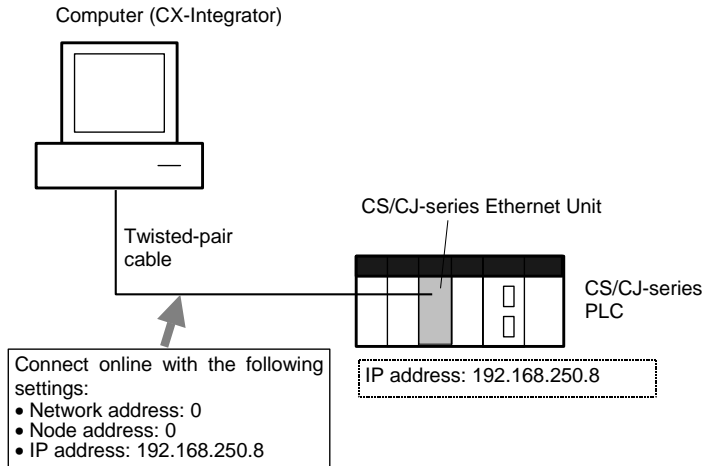

With this connection method, the following dialog box is displayed before the online connection. Click the appropriate buttons in the dialog box, based on the settings of the PLC that will be connected online.

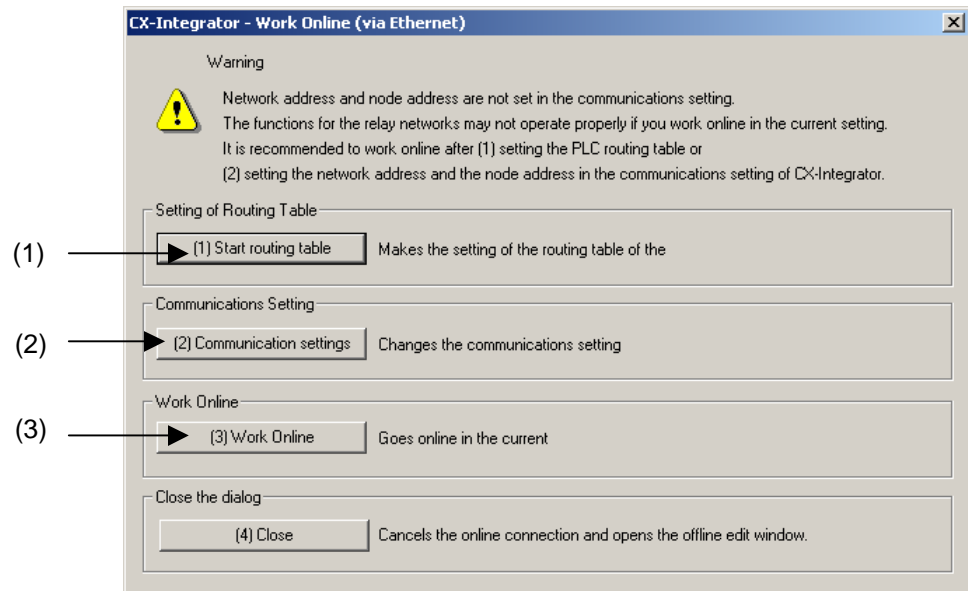

## 2-2 Connecting Online to the Relay PLC

### 2-2-3 CPU Unit Troubleshooting

1. Setting the Routing Tables and Connecting Online  
Start the routing table setting tool.  
At this point, you can set the routing tables before connecting online, and transfer the routing tables to a PLC that does not have a transferred routing table.  
After transferring the routing tables, make the communications settings in step 2.
2. Changing the Communications Settings to Match the Routing Table Settings of the Connected PLC  
Display the Change PLC Device Dialog Box.  
When connecting to a PLC that has routing tables set already, the network address and node address settings in this box will be changed to the routing table settings set in the PLC, and the PLC will be connected online.
3. The CX-Integrator connects online with the current communications settings.  
When the communications settings were not changed in step 2, the CX-Integrator will connect online with the original settings of network address 0 and node address 0. Some of the CX-Integrator's functions cannot be used if the online connection is made with network address 0 and node address 0.

### 2-2-3 CPU Unit Troubleshooting

Right-click the desired target PLC in the Online Connection Information Window and select **Error Log**. Refer to **2-4 Switching the Target PLC** for details.

Note: You cannot use this menu command for an NJ-series CPU Unit.

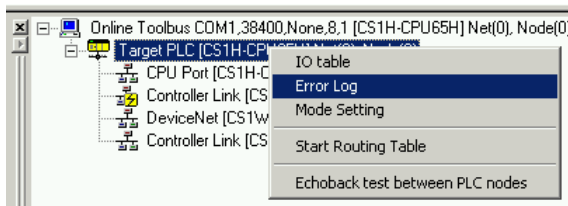

The PLC Errors Dialog Box will be displayed. Check the errors that have occurred in the CPU Unit and perform any required error processing.

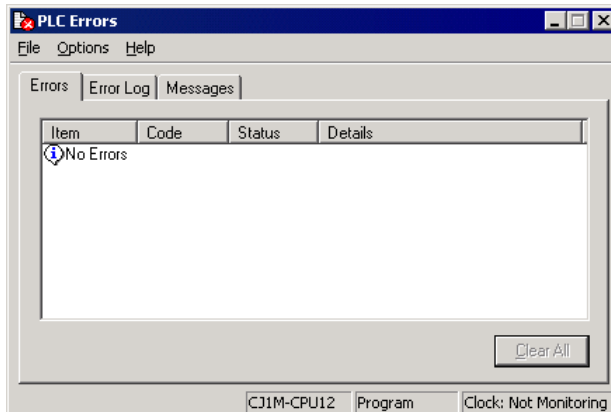

For example, the PLC Errors Window above will be displayed when an I/O Table Setting Error has occurred in a CJ-series PLC. In this case, the registered I/O table does not match the actual I/O table. There are three ways to correct this error: change the actual Units in the PLC, create a new I/O table, or edit and transfer the I/O table.



## 2-3 Uploading Network Configurations and Checking for Communications Unit Errors

### 2-3-1 Overview

With the CX-Integrator, the actual network configuration including component parameters can be uploaded from the target PLC and displayed in the Network Configuration Window.

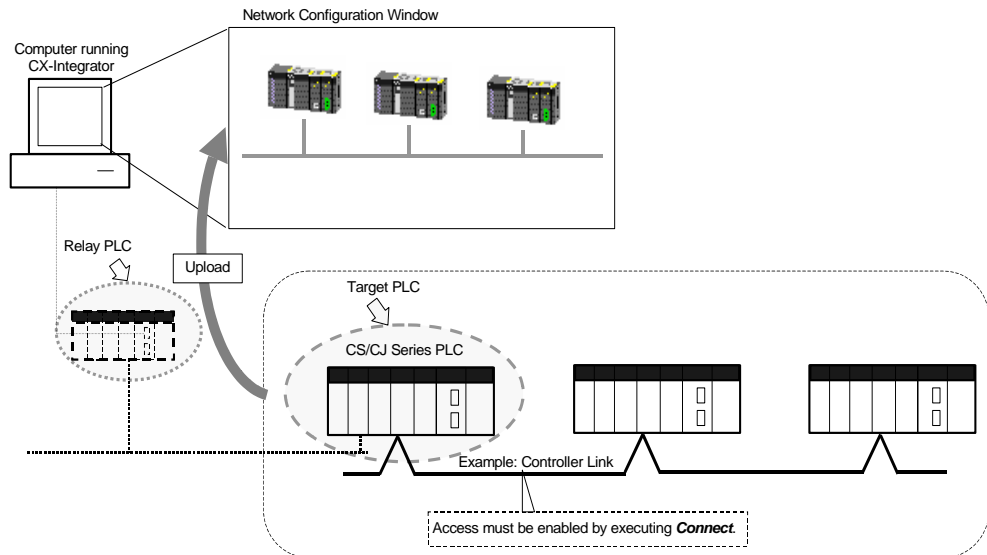

**Note:** The network that is uploaded will be automatically added to the Workspace Window. After uploading the network, check the connection status of the nodes and check the status of Communications Units (check for errors).

### 2-3-2 Procedure

Right-click a Communications Unit or port below *TargetDevice* in the Online Connection Information Window and select **Connect** from the pop-up menu. Accessing the Communications Unit or port will be enabled and the icon to the left will change to . (If the network has been uploaded but a network address is not displayed (Net(-) displayed), it will be necessary to select the desired network in the Workspace Window, right-click, and select **Connect**.)

Then select **Transfer [Network to PC]**.

**Note:** When uploading the network configuration of a target PLC through the relay PLC, select and right-click the desired target PLC on the network and select **Connect to this PLC** from the pop-up menu to make that PLC the target PLC. Refer to **2-4 Switching the Target PLC** for details.

## Uploading the Serial Network Configuration Connected to a CPU Unit

### CompoWay/F Networks

Right-click a CPU Unit under *TargetPLC* in the Online Connection Information Window and select **Connect** from the pop-up menu. The serial port will become accessible. (If the network has been uploaded but a network address is not displayed (Net(-) displayed), it will be necessary to select the desired network in the Workspace Window, right-click, and select **Connect**.)

Right-click the CPU Unit again and then select **Transfer [Network to PC]**.

Refer to **8-2 CompoWay/F Slaves Connected to a PLC** for details.

**2-3 Uploading Network Configurations and Checking for Communications Unit Errors**  
**2-3-2 Procedure**

**NT Link**

Right-click a CPU Unit under *TargetPLC* in the Online Connection Information Window and select **Connect** or **NT Link Auto Online Setting** from the pop-up menu.

**NT Link Auto Online Setting**

With an NT Link, the NT Link baud rate and maximum PT unit number for an NS-series PT with a model number ending in V1 or later serially connected to a CS/CJ-series PLC via an NT Link can be automatically detected and set for the serial port on the CS/CJ-series PLC. This is called NT Link Auto Online Setting.

Refer to *Communications Section 9 NT Links, 9-1 NT Link Connection Auto-detect Function* for details.

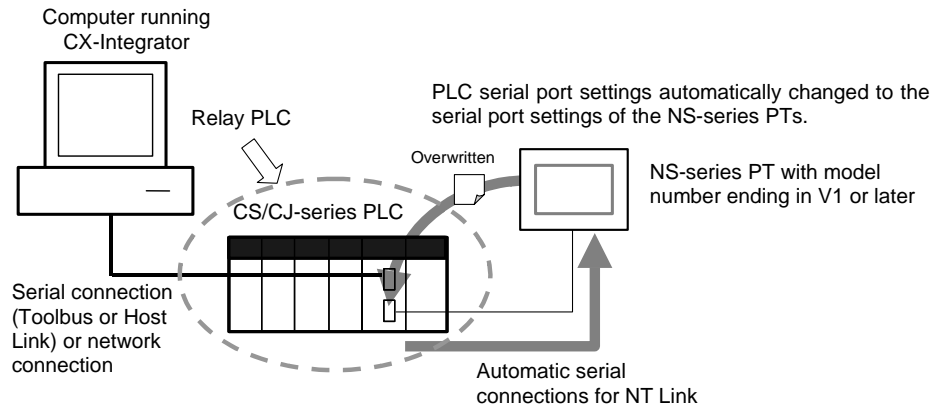

**Note:** The settings of the PLC serial port will be as follows after automatic connection:

Serial communications mode:	1:N NT Link
Port baud rate:	Same as NS-series PT
Maximum unit number in NT Link Mode:	Same as NS-series PT unless it is set to 0, in which case 1 will be used.

**Uploading the Network Configuration Connected to a Communications Unit**

Use the following procedure to upload the network configuration of a network connected to an Ethernet, Controller Link, SYSMAC LINK, DeviceNet, or CompoNet Communications Unit.

1. With the CX-Integrator online, right-click a Communications Unit under *TargetPLC* in the Online Connection Information Window and select **Connect** from the pop-up menu.

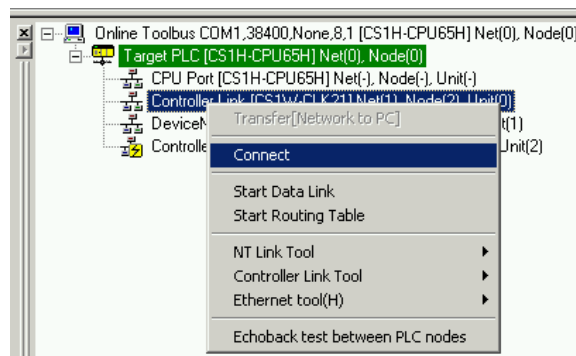

The same operation can be executed by double-clicking the Communications Unit.

2. Right-click the Communications Unit/port and select **Transfer [Network to PC]**.

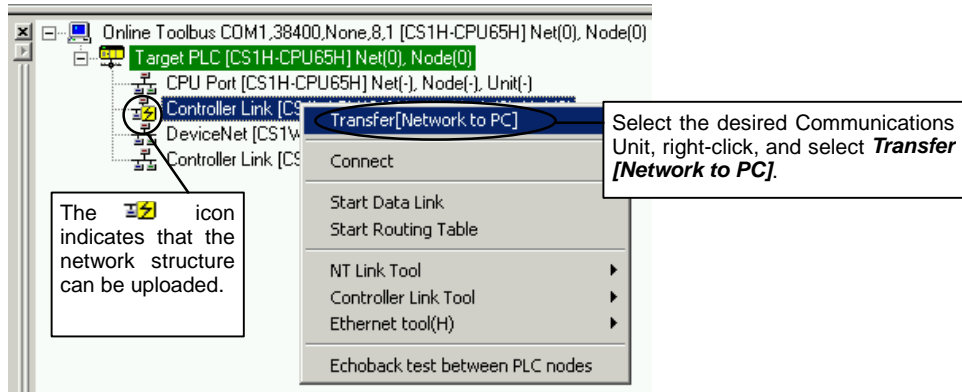

3.

**1) For networks other than Ethernet:**

The dialog box for selecting the data to be transferred will be displayed.

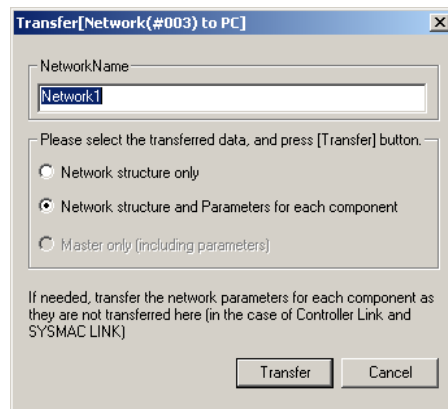

The selection is fixed for DeviceNet.

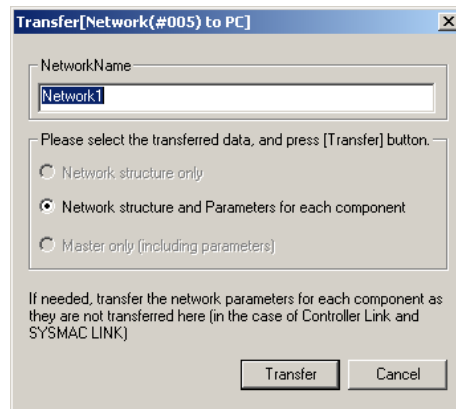

When using CompoNet, the following dialog box will be displayed.

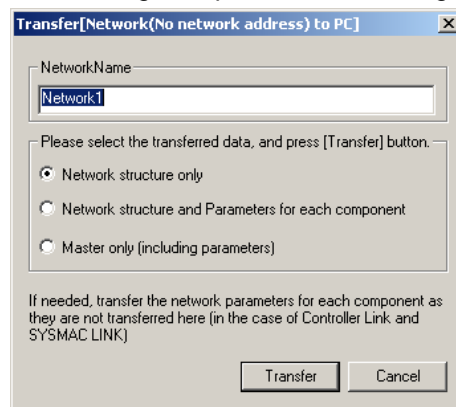

## 2-3 Uploading Network Configurations and Checking for Communications Unit Errors

### 2-3-2 Procedure

Clicking the **Transfer** Button will start the transfer. Clicking the **Cancel** Button will cancel it.

#### 2) For Ethernet networks:

The following message will be displayed for verification.

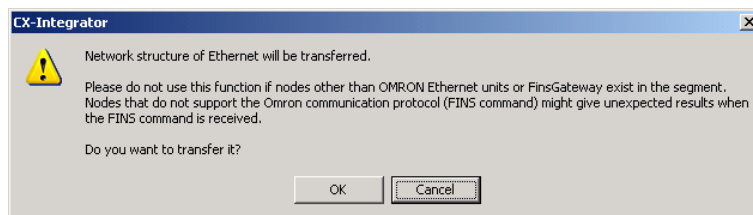

Check to confirm that no nodes other than OMRON Ethernet Units or FinsGateway exist in the same segment, and then click the **OK** Button. The dialog box will then be displayed for selecting the data to be transferred.

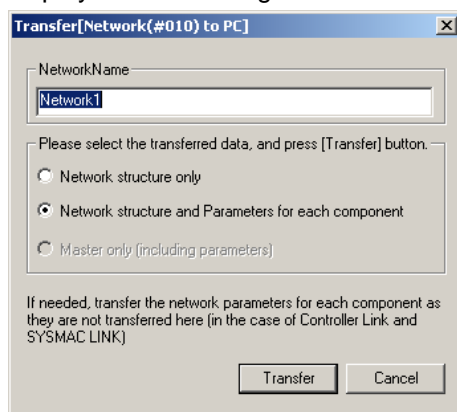

Click the **Transfer** Button to display the following Searching Node Setting Dialog Box.

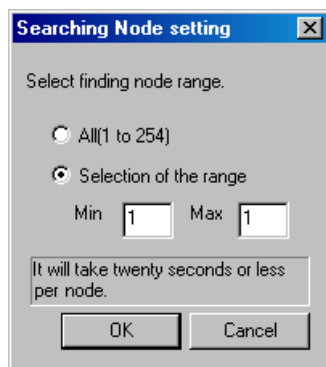

Check the range of FINS node addresses on the Ethernet network for the applicable nodes and input the minimum and maximum values of the range. Then click the **OK** Button. The transfer will start.

If the range of addresses is unknown, select *All (1 to 254)*, and then click the **OK** Button.

Click the **Cancel** Button to cancel the transfer.

#### Note

If the default settings are used for the minimum and maximum nodes (1 for both), the network configuration will be uploaded only from the node with node address 1. Always set the minimum and maximum node addresses.

If nodes in the specified range do not exist, it will take 20 seconds per node to search for it. If *All (1 to 254)* is selected, it will take up to approximately 85 minutes for the transfer to be completed. The transfer will also take longer if a maximum address is entered that is higher than any of the existing node address.



#### Caution

Do not use this function if a node exists for something other than an OMRON Ethernet Unit or FinsGateway within the same segment on Ethernet, and when the Ethernet network system is in operation. When an Ethernet network configuration

upload is executed, an OMRON FINS command is sent to all nodes in the segment. Therefore, if a node exists for something other than an OMRON Ethernet Unit or FinsGateway, the FINS command will not be received at that node and unexpected operation may occur.

4. The network configuration uploaded from the Unit will be displayed in the Network Configuration Window.

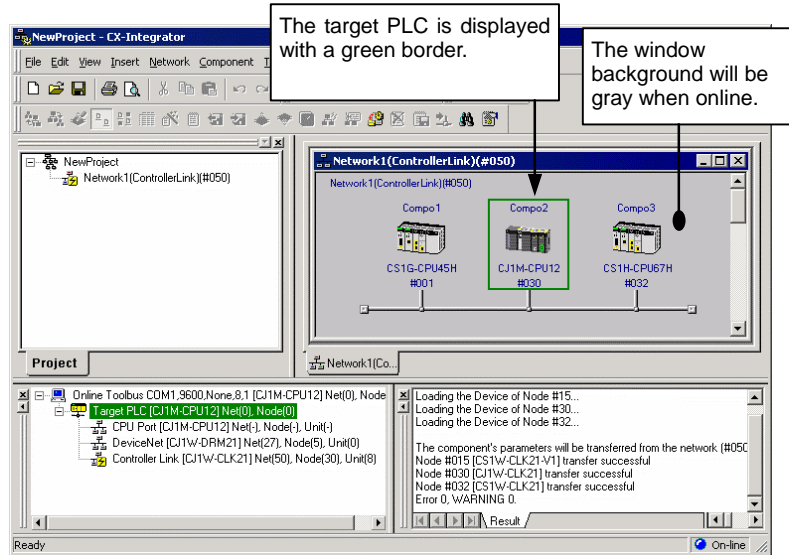

5. Check the connection status of the nodes. To check the CPU Unit and Communications Units for errors, right-click the node in the Network Configuration Window and select **Error Log** or **Status/Error of Communication Unit** from the pop-up menu.

**Note** Confirming Relay Points between Networks

The System Overview Tab Page shows the relay points between networks. The relationship between the relay points for all networks can be understood on one display.

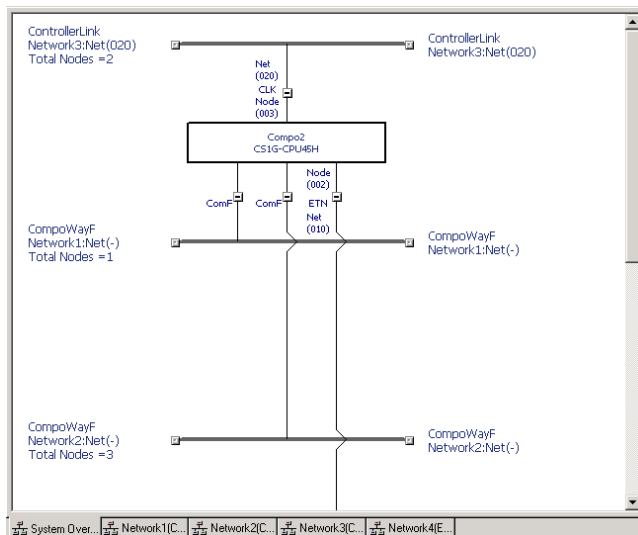

**2-3 Uploading Network Configurations and Checking for Communications Unit Errors**  
**2-3-2 Procedure**

**Note** DeviceNet Network Upload Resume Function.  
 If the DeviceNet network configuration is being uploaded with the CX-Integrator version 2.1 or higher, and the upload is cancelled or fails, that network configuration upload can be restarted to upload the configuration only for the nodes where the upload failed.

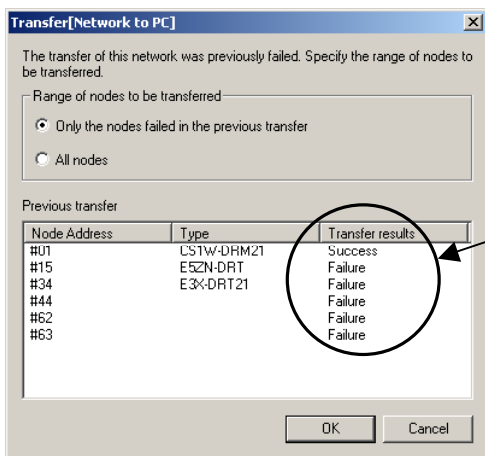

Data is transferred only for the nodes where the transfer ended in "Failure" previously.

**Note** Combining PLCs  
 If different networks are uploaded when connected to different PLCs, a single PLC can sometimes be registered as different PLCs in the Network Configuration Windows. If this happens, the *Combine two PLCs* menu item can be used to combine the two PLCs into the same PLC.

Example  
 1. Upload network N1 (Ethernet) while connected to PLC1.

Network1(Ethernet):Net(001)

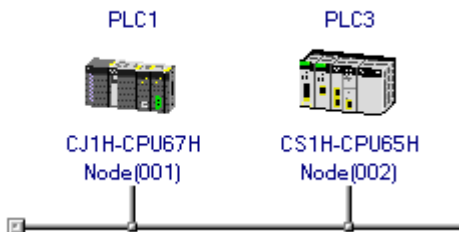

2. Upload network N2 (Controller Link) while connected to PLC2.

Network2(ControllerLink):Net(002)

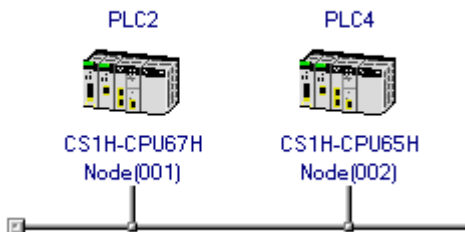

3. The same PLC is registered as both PLC3 and PLC4 in the Network Configuration Windows.

**2-3 Uploading Network Configurations and Checking for Communications Unit Errors**  
**2-3-2 Procedure**

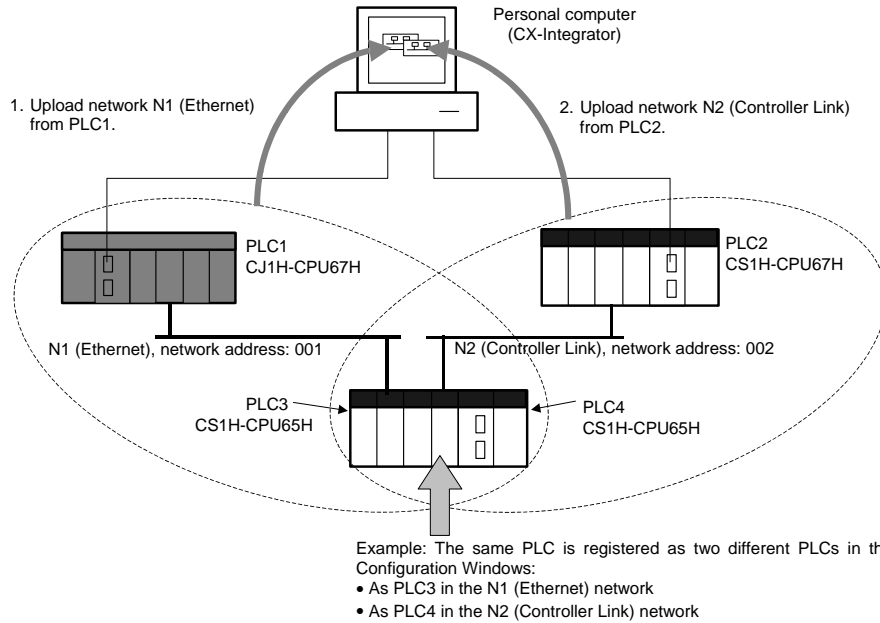

Here, for example, PLC4 can be eliminated and combined with PLC3 as the same PLC. The procedure is as follows:

1. Go offline after uploading the networks, right-click PLC3 in network N1 (Ethernet), and select **Combine two PLCs**.

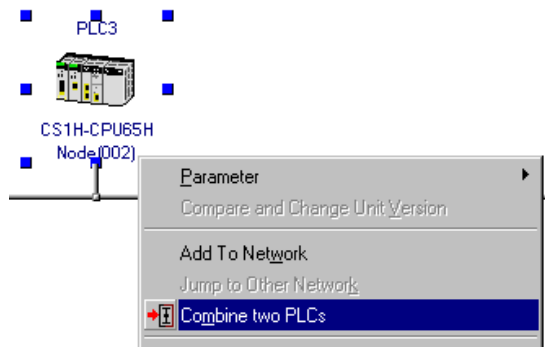

**2-3 Uploading Network Configurations and Checking for Communications Unit Errors**  
**2-3-2 Procedure**

The following Combine two PLCs Dialog Box will be displayed.

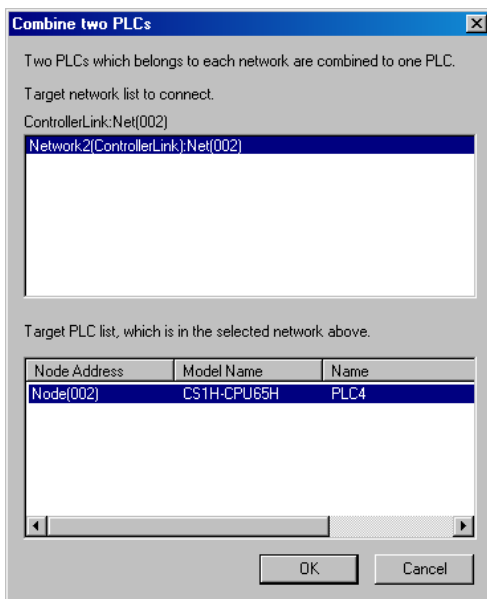

- Other networks registered in the project will be display at the top of the dialog box.
  - All PLCs with the same model of CPU Unit on the selected network will be displayed at the bottom of the dialog box.
2. Select the PLC that should be the same as PLC3 (but is registered as a different PLC) and click the **OK** Button. The following Select PLC Dialog Box will be displayed.

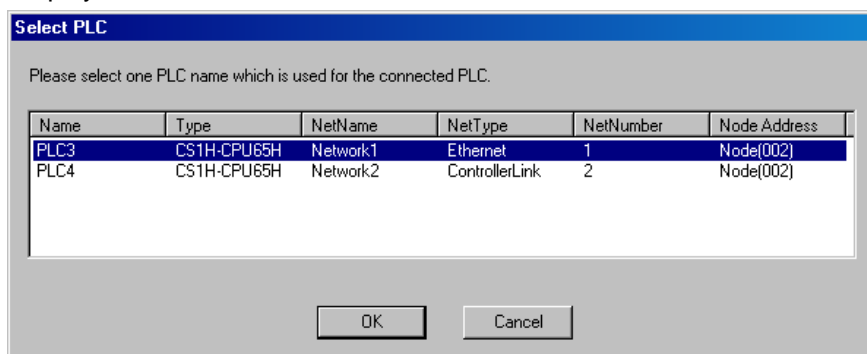



## 2-3 Uploading Network Configurations and Checking for Communications Unit Errors

### 2-3-3 Checking and Correcting Communications Unit Errors

3. Select the name of the PLC to remain in the Network Configuration Windows (here, PLC3) and click the **OK** Button.

The System Overview Tab Page will appear as follows:

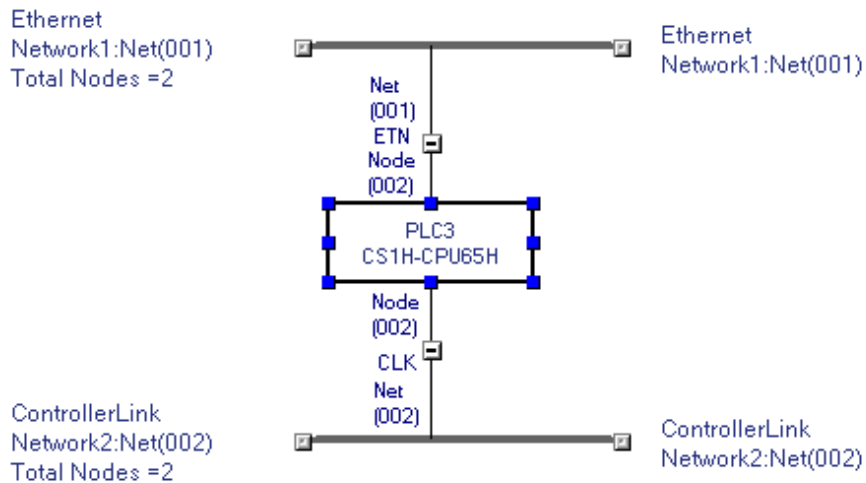

The PLCs can also be combined by selecting the two networks on the System Overview, right-clicking, and selecting **Combine two PLCs**.

## 2-3-3 Checking and Correcting Communications Unit Errors

### Checking a Communications Unit's Status and Errors

Right-click the target PLC in the Network Configuration Window and select **Status/Error of Communication Unit** from the pop-up menu.

The PLC Unit Status Dialog Box will be displayed. In this example, a Controller Link Unit is selected.

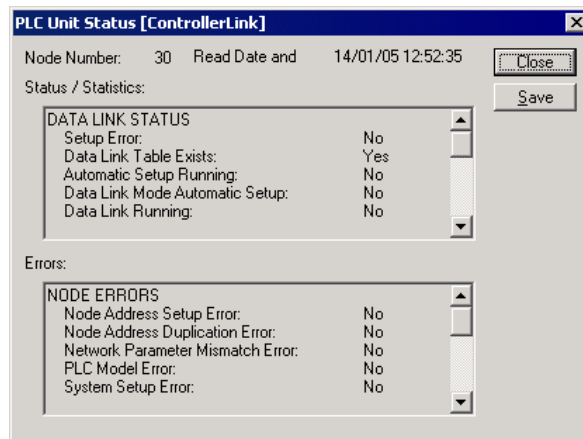

**Note:** The Communications Unit's status and error information can be saved as a CSV file by clicking the **Save** Button, so the Communications Unit's status at that point can be read from the CSV file later and analyzed.

2-3 **Uploading Network Configurations and Checking for Communications Unit Errors**  
2-3-3 **Checking and Correcting Communications Unit Errors**

**Checking a Communications Unit's Error Log**

Right-click the target PLC in the Network Configuration Window and select **Error Log of Communication Unit** from the pop-up menu.

The Error log Dialog Box will be displayed. In this example, a Controller Link Unit is selected.

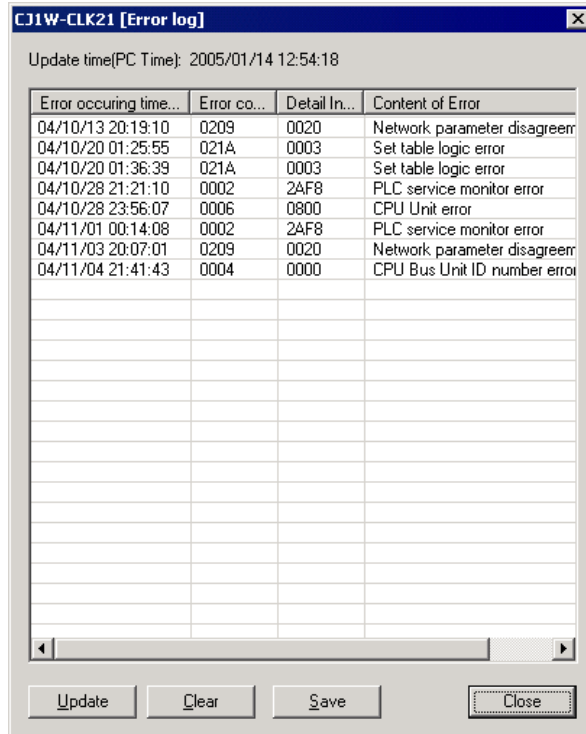

The Communications Unit's error log (stored in the Unit's EEPROM) will be displayed, showing each error's *Error occurring time*, *Error code*, *Detail information*, and *Content of Error*. Refer to the *Communications Unit's Operation Manual* or details on individual errors.

**Note:** The Communications Unit's error log can be saved as a CSV file by clicking the **Save** Button, so the Communications Unit's error log at that point can be read from the CSV file later and analyzed.

## 2-4 Switching the Target PLC

### 2-4-1 Overview

When an online connection is made from the CX-Integrator to the relay PLC, initially the same PLC will be both the relay PLC and the target PLC and the Communications Units and ports of the relay PLC will be displayed in the Online Connection Information Window.

From there, the network configuration can be uploaded and other PLC on a network specified to make it the target PLC.

### 2-4-2 Procedure

1. Right-click a Communications Unit or port connected of the relay PLC and select **Connect** to enable accessing the Communications Unit or port. (If the network has been uploaded but a network address is not displayed (Net(-) displayed), it will be necessary to select the desired network in the Workspace Window, right-click, and select **Connect**.) The  icon will be displayed to indicate the selected Communications Unit or port can be accessed.
2. Right-click the Communications Unit/port again and select **Transfer [Network to PC]** to upload the network configuration. The network configuration will be displayed in the Network Configuration Window.

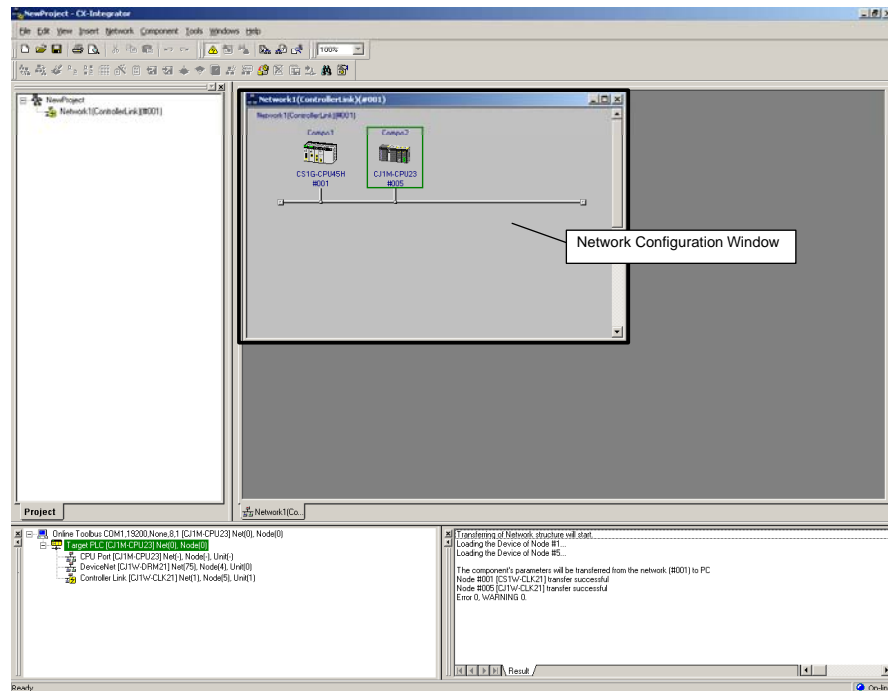

**2-4 Switching the Target PLC**  
**2-4-2 Procedure**

3. Right-click a PLC on the network and select **Connect to this PLC** from the pop-up menu.

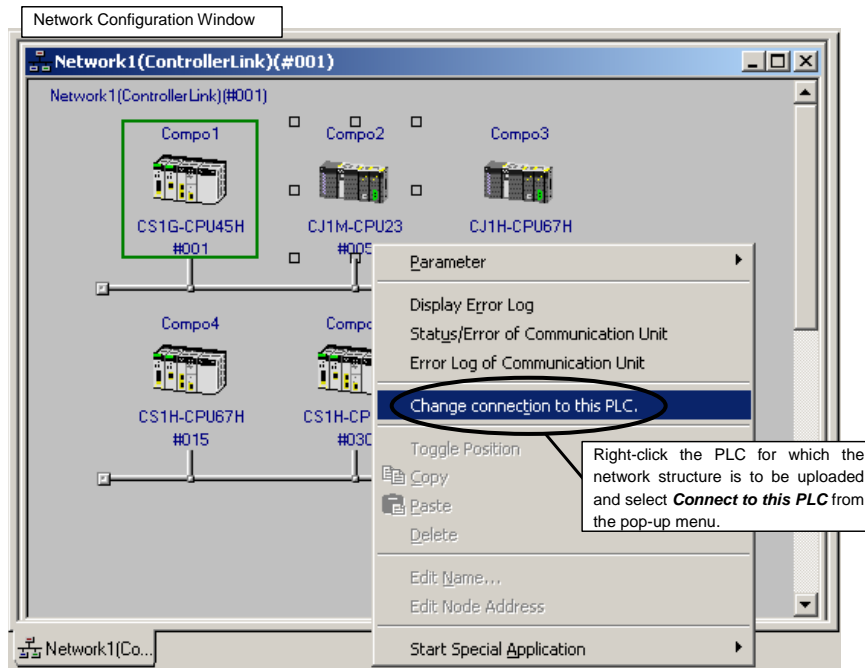

The selected PLC will be set as the target PLC.

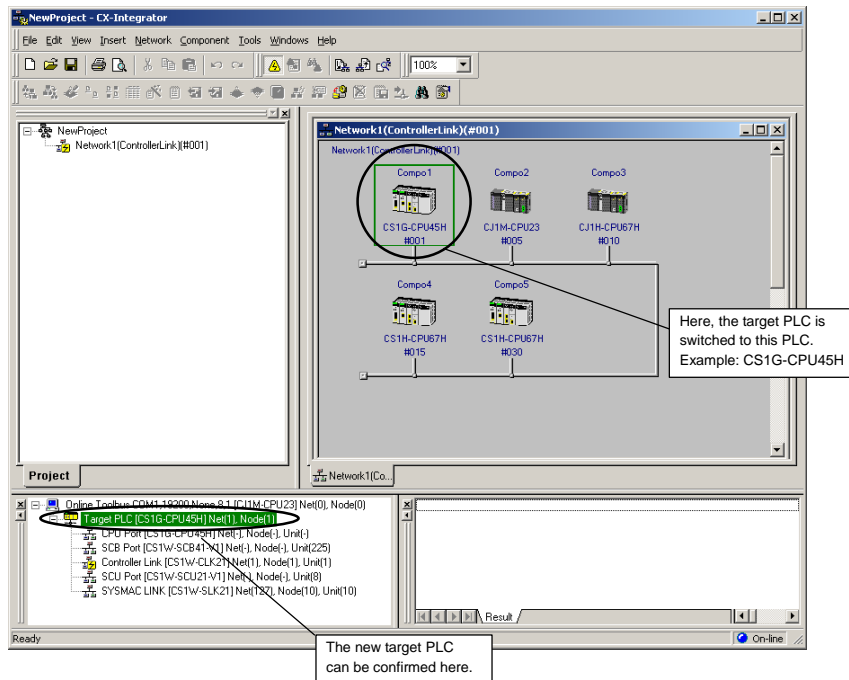

4. Right-click a Communications Unit/port from the new target PLC and select **Transfer [Network to PC]** to upload the network configuration.

## 2-5 Creating Virtual Network Configurations Offline

### 2-5-1 Overview

For a DeviceNet, CompoNet, or CompoWay/F network, the network configuration can be created offline, the component parameters can be set, and both the configuration and parameters can be saved in a network configuration file even before the network has been installed.

All of the component parameters on a network can be downloaded to the actual components from a previously saved network configuration file after the network has been installed.

### 2-5-2 Procedure

#### CompoWay/F Networks

1. Offline, select **Insert – Network**. The Network/Component Settings Wizard will be displayed.

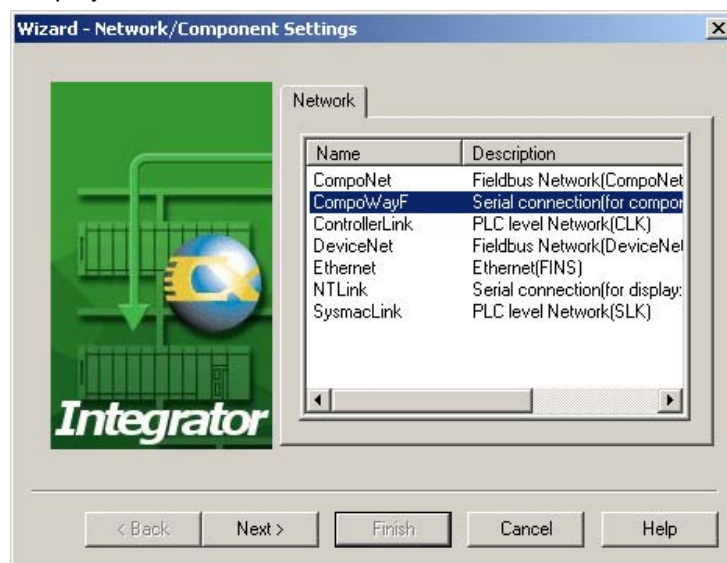

2. Select **CompoWay/F** and click the **Next** Button.

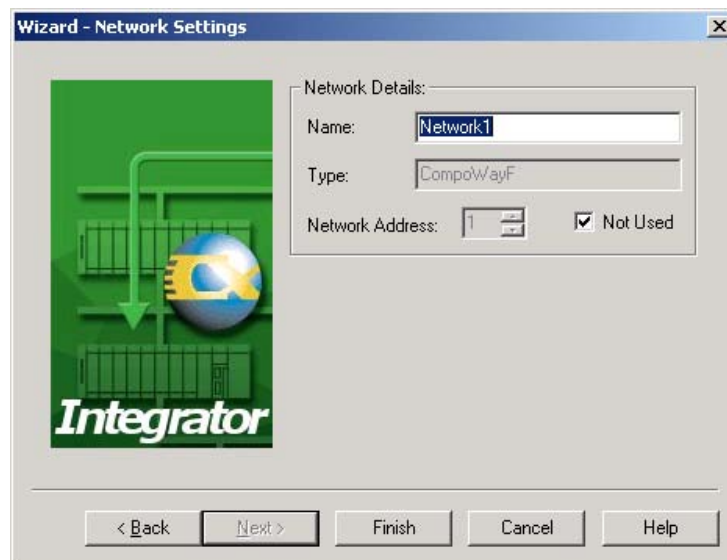

3. Enter the name of the network and click the **Finish** Button.
4. Select a component from the CPS Tab Page in the Component List Window and drag and drop it in the Network Configuration Window.

2-5 **Creating Virtual Network Configurations Offline**  
2-5-2 **Procedure**

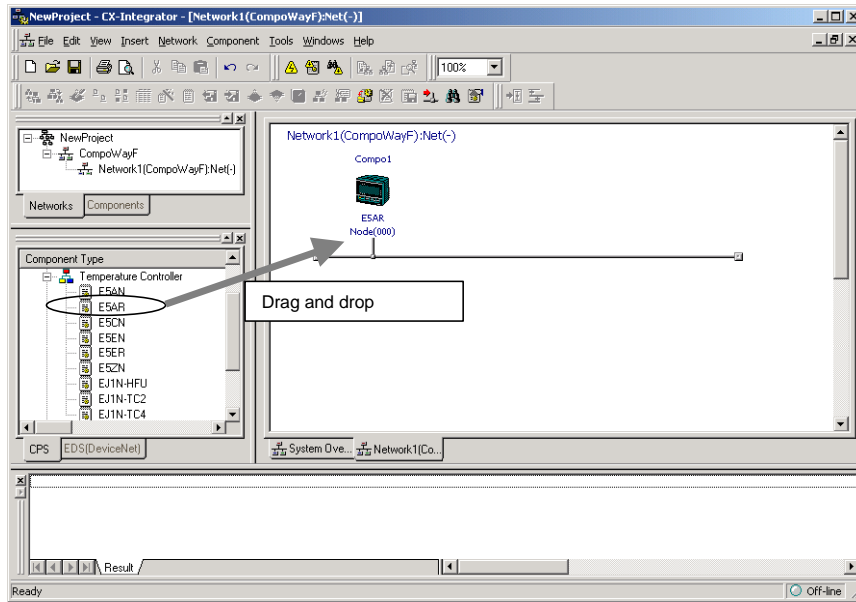

5. The following Component Settings Wizard will be displayed.

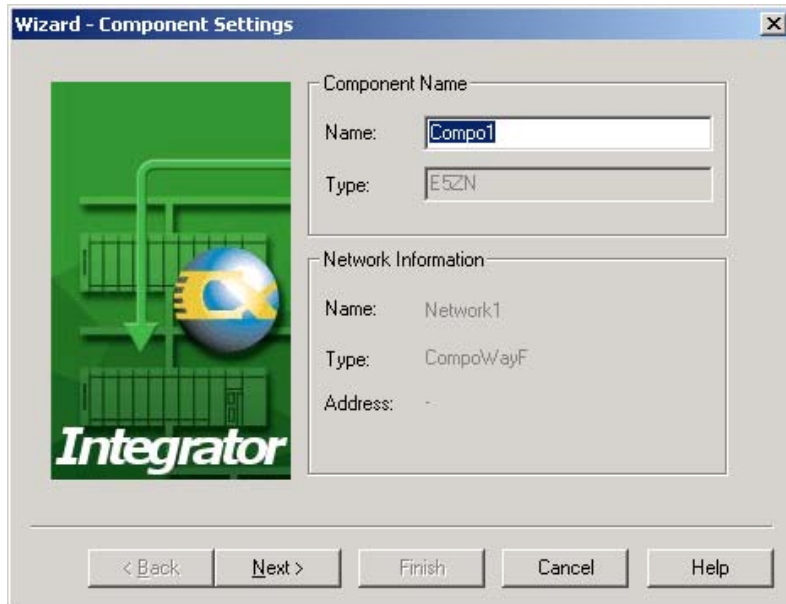

6. Enter the component name and click the **Next** Button.

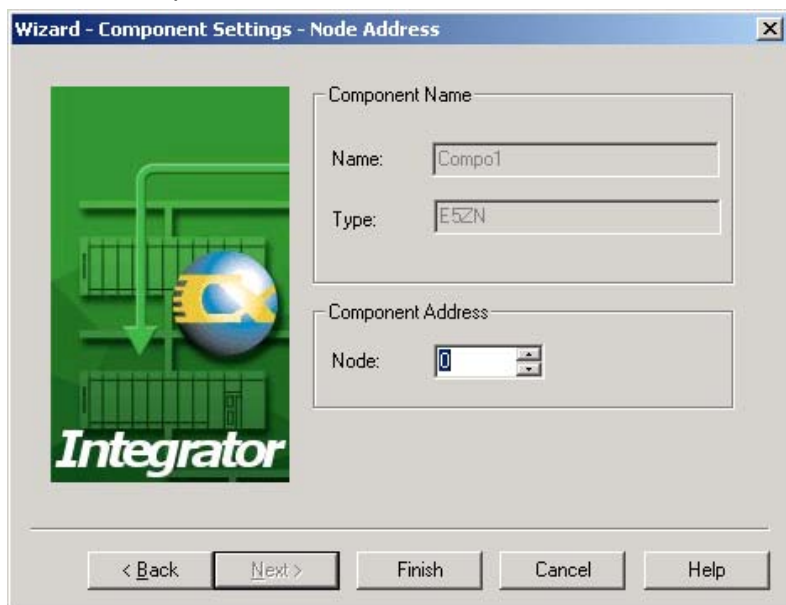

7. Enter the node address and click the **Next** Button for a PLC click the **Finish** Button for a CompoWay/F Slave (e.g., Temperature Controlled).

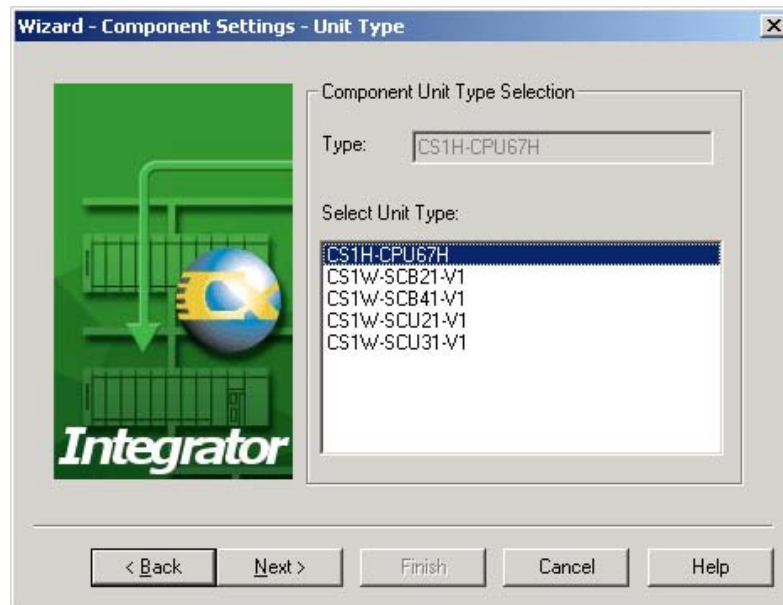

8. For a PLC, select the port to connect.
- To connect CompoWay/F to a serial port on the CPU Unit, select the CPU Unit with the port to connect CompoWay/F and click the **Next** Button.

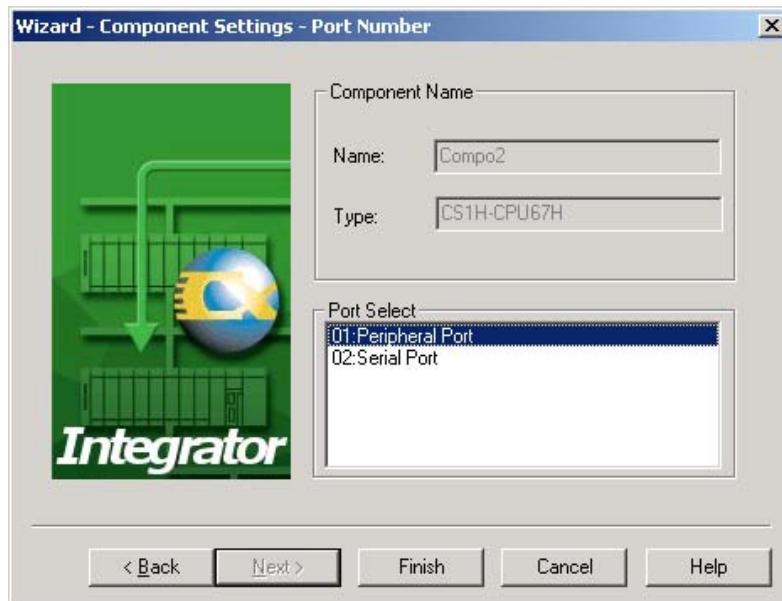

Select the port to connect to CompoWay/F and click the **Finish** Button.

- To connect CompoWay/F to a serial port on a Serial Communications Unit, select the Unit with the port to connect CompoWay/F and click the **Next** Button.

2-5 **Creating Virtual Network Configurations Offline**  
2-5-2 **Procedure**

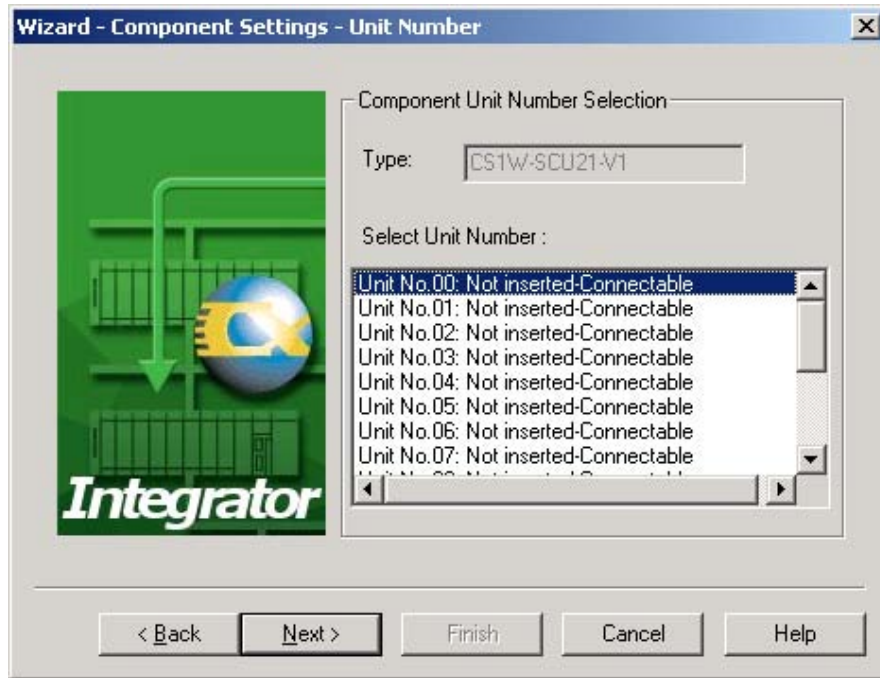

Select the unit number of the Unit that was selected click the **Next** Button.

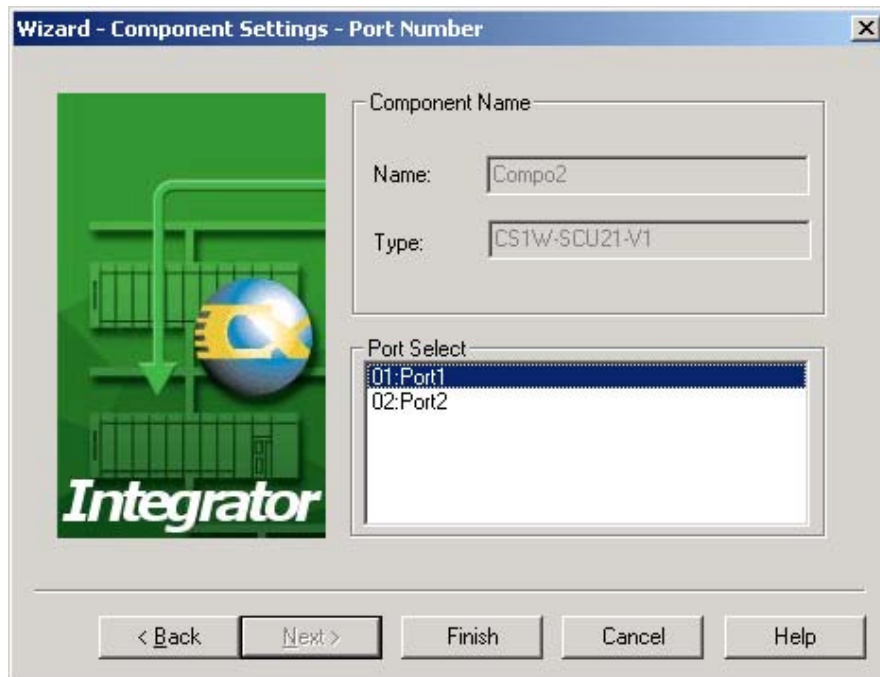

Select the port to connect to CompoWay/F and click the **Finish** Button.

- To connect CompoWay/F to a serial port on a Serial Communications Board, select the Board with the port to connect CompoWay/F and click the **Next** Button.



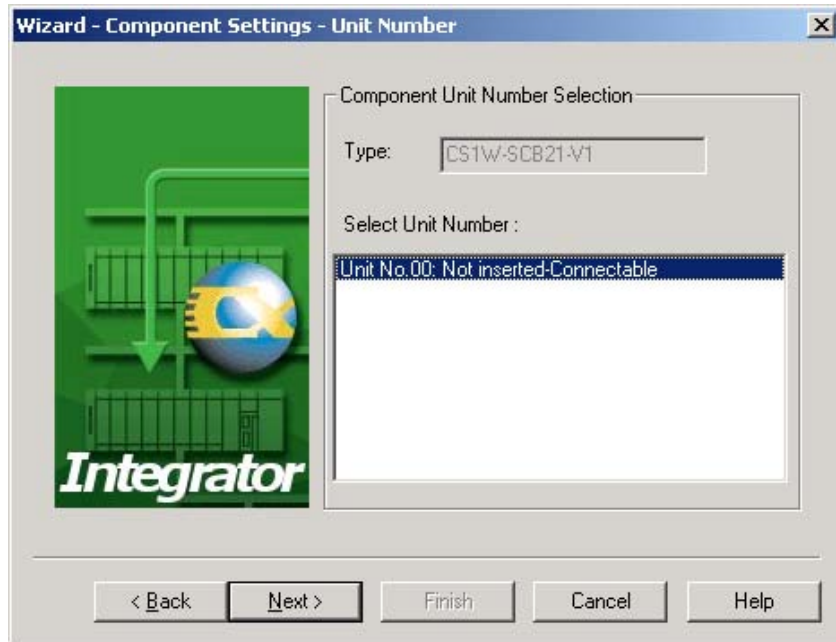

Click the **Next** Button.

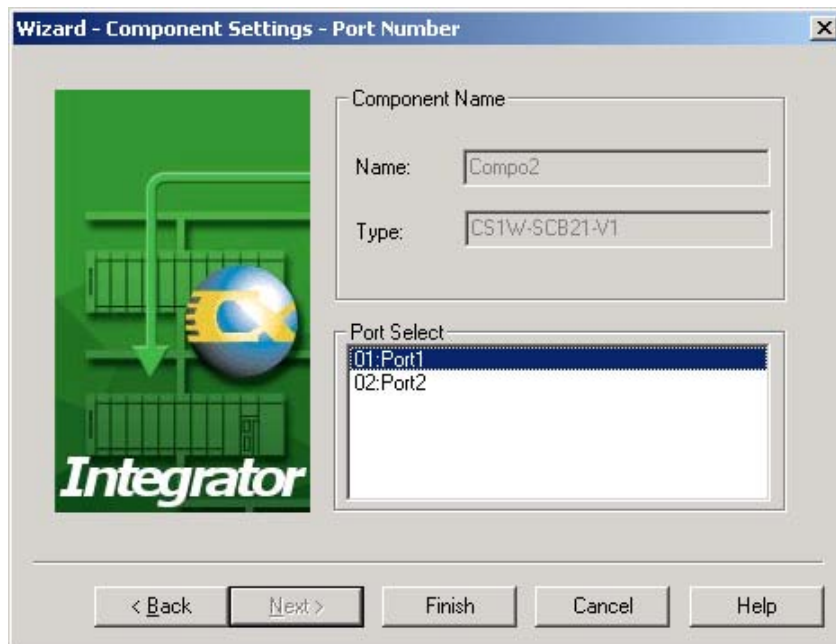

Click the port to connect to CompoWay/F and click the **Finish** Button.

9. The component will be registered in the Network Configuration Window as shown below.

In this example, a PLC CPU Unit and two Temperature Controllers have been dragged and dropped:

2-5 **Creating Virtual Network Configurations Offline**  
2-5-2 **Procedure**

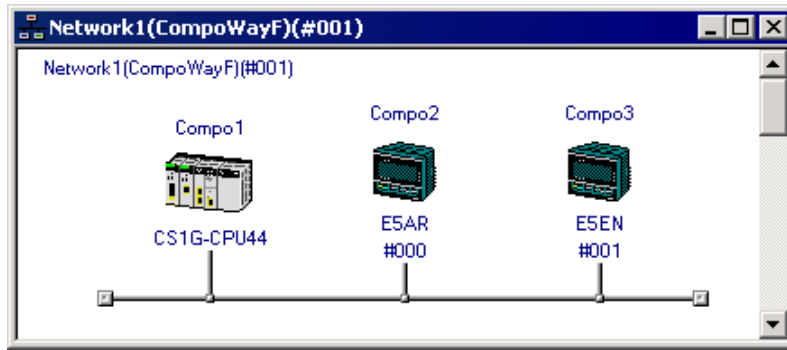

**DeviceNet Networks**

**Adding the Master**

1. Offline, select **Insert – Network**. The Network/Component Settings Wizard will be displayed.

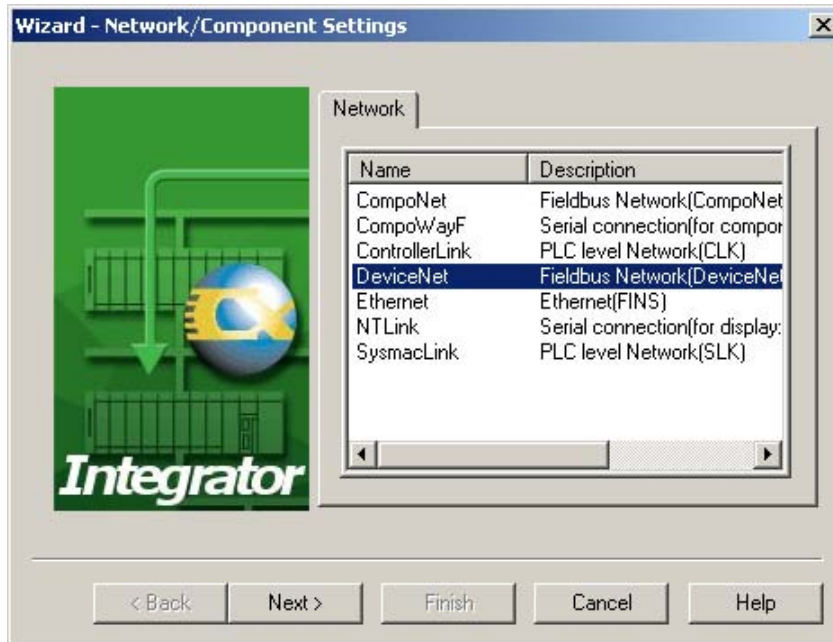

2. Select DeviceNet and click the **Next** Button.

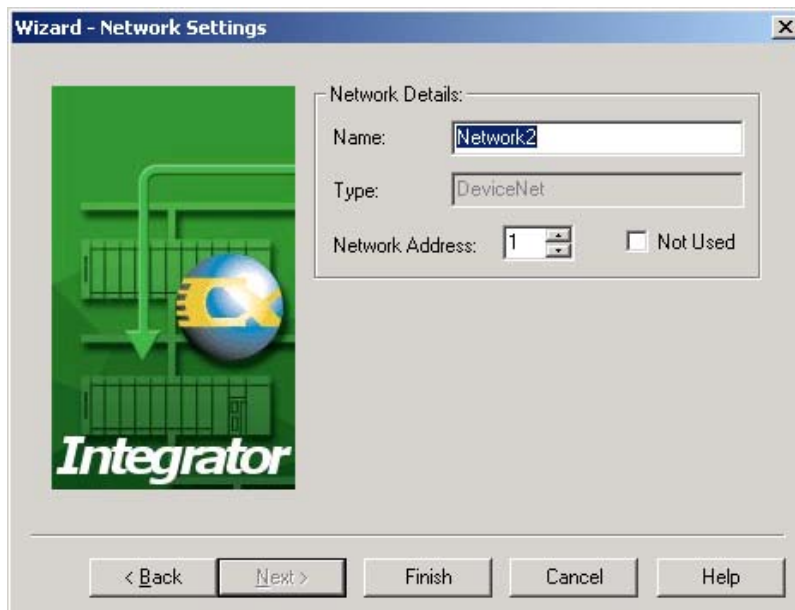

**2-5      Creating Virtual Network Configurations Offline**  
**2-5-2    Procedure**

3. Enter the name of the network and the network address and click the **Finish** Button.
4. Select a device (component) from the EDS (DeviceNet) Tab Page in the Component List Window and drag and drop it in the Network Configuration Window.
5. The Node Address Setup Dialog Box will be displayed. Set the node address and click the **OK** Button.



6. The device will be registered in the Network Configuration Window as shown below.

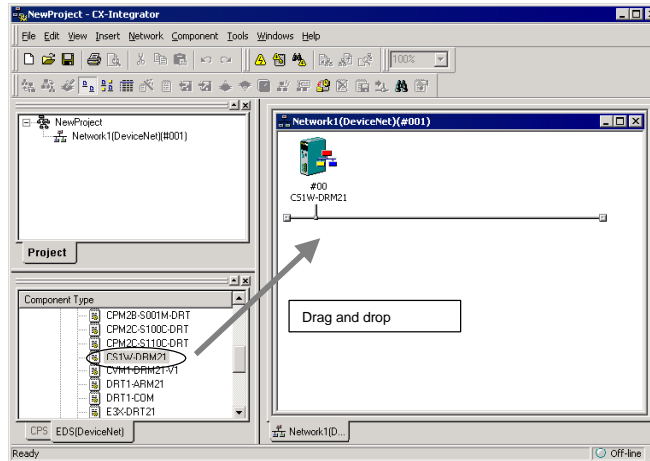

## 2-5 Creating Virtual Network Configurations Offline

### 2-5-2 Procedure

#### Adding Slaves

Slaves are added just like the master was, by dragging and dropping them from the Component List Window.

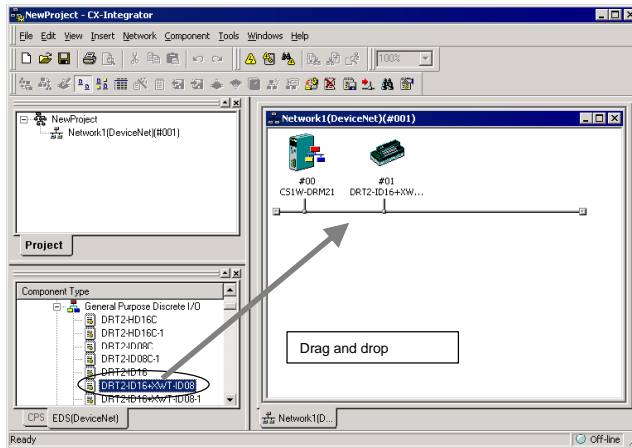

#### Example of Devices Registered by Dragging and Dropping

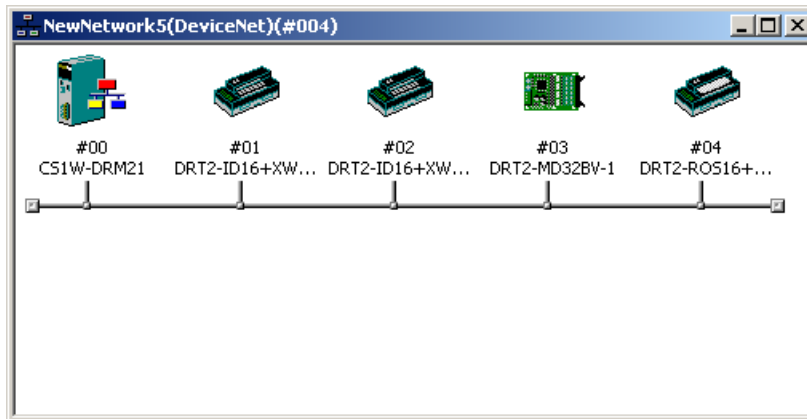

**Note** Devices can also be added to the network by right-clicking the device in the Component List Window and selecting **Add To Network** from the pop-up menu.

## CompoNet Networks

### Adding the Master

1. Offline, select **Insert – Network**. The Network/Component Settings Wizard will be displayed.

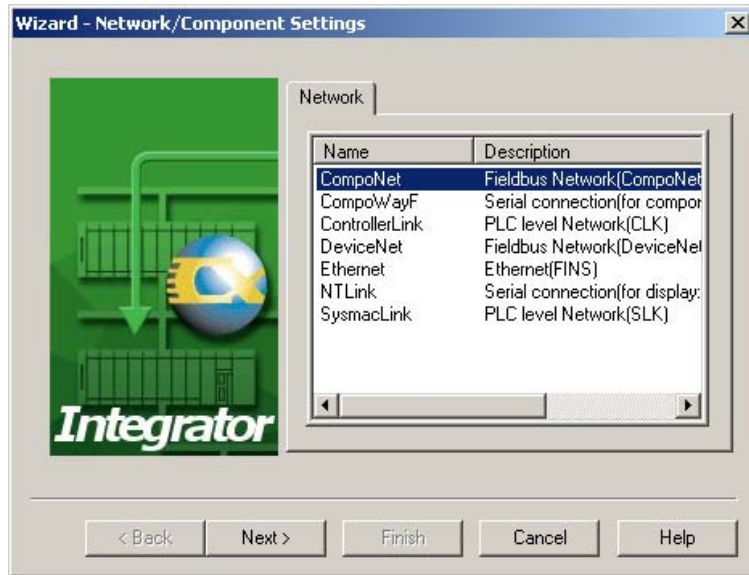

2. Select CompoNet and click the **Next** Button.
3. Enter the name of the network and click the **Next** Button.

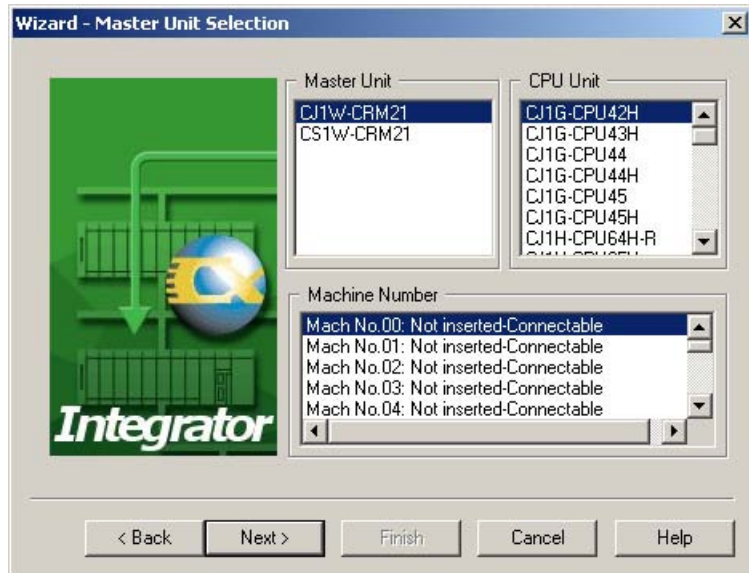

4. Select the Master Unit and CPU Unit to use, select the Machine Number (i.e., the unit number) of the Master Unit, and then click the **Next** Button.

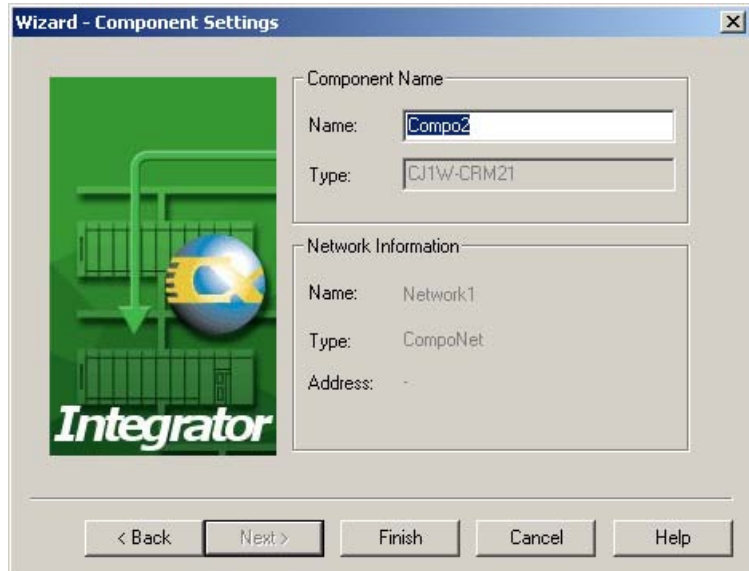

**2-5 Creating Virtual Network Configurations Offline**  
**2-5-2 Procedure**

5. Enter a name for the Master Unit, and then click the **Finish** Button to finish adding the Master.

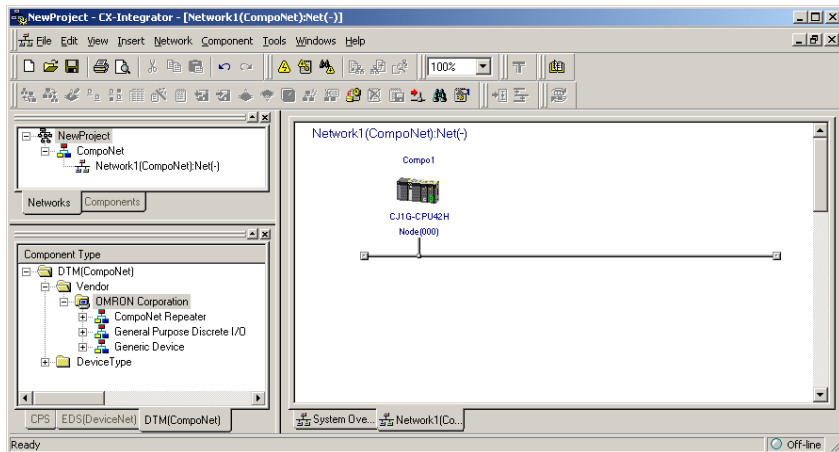

**Adding Slaves**

1. Select the component model from the component list DTM (CompoNet) Tab Page, and drag and drop it in the Network Configuration Window.
2. Enter the name and node address, and click the **Finish** Button.
3. The slave is now registered.

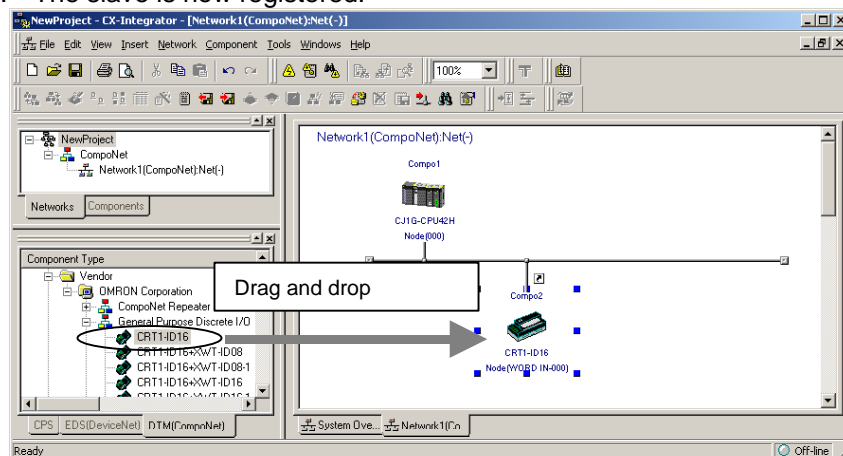

**Note**

If a slave that is not allowed is added when the Master Unit is in Communications Mode 0 (a Bit Slave or a Word Slave at node address 8 or higher), the dialog box shown below will be displayed requesting that the user check the communications mode.

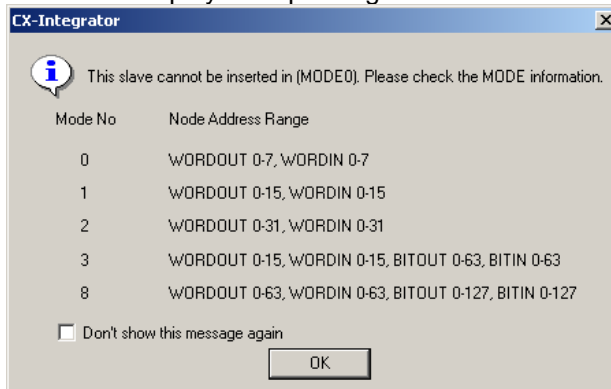

Check the communications mode of the Master Unit, and if the number of slaves being used is within the allowable Node Address Range, select *Don't show this message again* and click the **OK** Button.

To display the dialog box again, select **Options** from the Tools Menu, and select *Display the information message while inserting the Slave Device which cannot be used on Mode 0*, and click the **OK** Button.

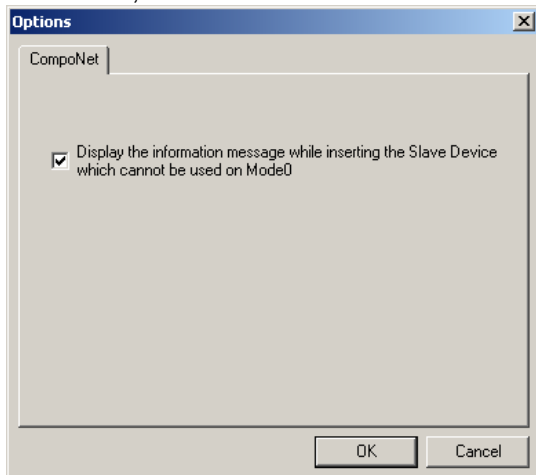

## 2-5-3 Changing Node Addresses

### Component – Change Node Address

Node address between 0 and 63 will be automatically assigned to devices as they are added to the network.

Use the following procedure to change a node address that has been assigned.

- 1 Select the device for which the node address is to be changed.
- 2 Select **Component – Change Node Address** from the menu bar. Alternately, right-click the device and select **Change Node Address** from the pop-up menu. The Change Node Address Dialog Box will be displayed.

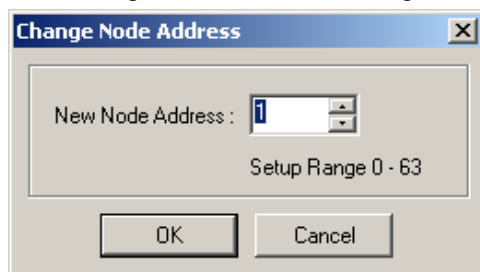

- 3 Change the node address to a value between 0 and 63 and click the **OK** Button. The node address will be changed. Repeat this operation to change any other node address in the network that should be different.

## 2-5-4 Editing Components (Devices)

### Deleting Components (Devices)

#### **Edit - Delete**

Use the following procedure to delete a component from a network.

- 1 Select the component to be deleted. (More than one device can be selected.)
- 2 Select **Edit**.
- 3 Select **Delete**.
- 4 The following dialog box will be displayed to confirm deletion. Click the **Yes** Button to delete the selected component.

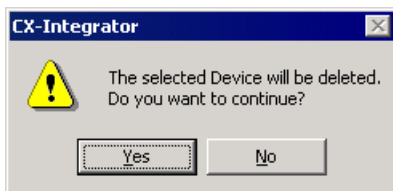

If a slave device that is registered in the master device is deleted, the registration in the master device will be deleted and the slave will be deleted from the scan list automatically.

**Note:** The Master Unit cannot be deleted when using CompoNet.

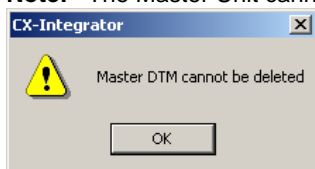

### Copying Components (Devices)

#### **Edit - Copy**

Use the following procedure to copy a component on a network.

- 1 Select the component to be copied. (More than one device can be selected.)
  - 2 Select **Edit**.
  - 3 Select **Copy**.
- The component and its parameters will be copied to the CX-Integrator's clipboard.

### Pasting Components (Devices)

#### **Edit - Paste**

Use the following procedure to paste a component from the CX-Integrator's clipboard into a network.

- 1 Select the component at the location where the component on the clipboard is to be pasted. If no component is selected, pasted components will be added to the end of the network.
  - 2 Select **Edit - Paste**.
- An unused node address will be assigned to the newly inserted component.

### Changing the Locations of Components (Devices)

Use the following procedure to move the locations in which components are displayed on a network.

#### **CompoWay/F and CompoNet Networks**

- 1 Left-click the component to be moved and drag it.
- 2 Drop the component at the new location where it is to be displayed.
- 3 The new component will be moved to the new display location.



**DeviceNet Networks**

Use the following procedure to change the display locations of DeviceNet components in the Network Configuration Window.

- 1 Right-click the device to be moved and drag it.
- 2 Drop the device at the new location where it is to be displayed.
- 3 The new device will be moved to the new display location.

Example 1: Moving Device #00 to the Location of Device #02

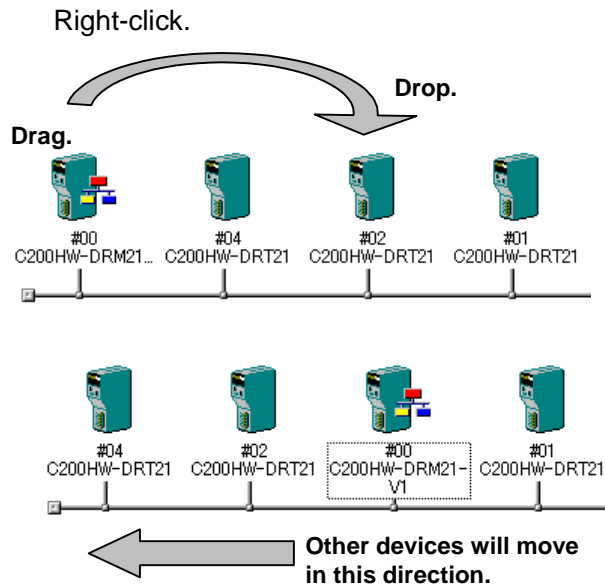

Example 2: Moving Device #00 to the Location of Device #02

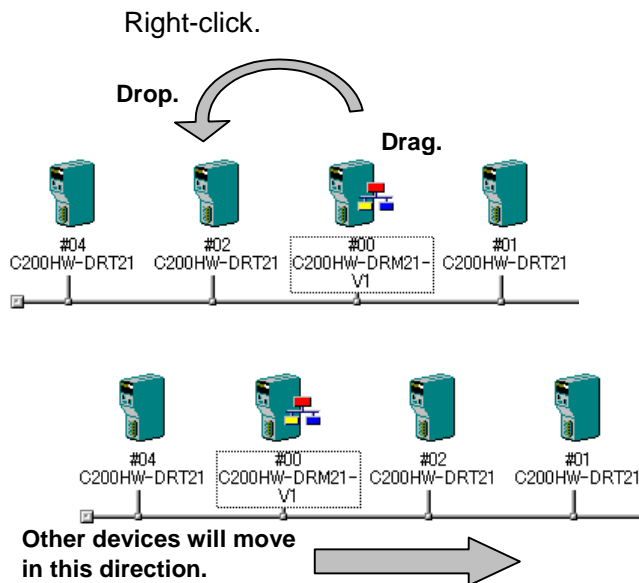

**Changing DeviceNet Device Comments**

**Component - Change Device Comment**

Comments can be registered for DeviceNet devices registered in a network. The default comment is the product name.

Use the following procedure to change the device comment.

- 1 Select the device to be edited.
- 2 Select **Component - Change Device Comment**. The Change Device Comment Dialog Box will be displayed.

2-5 **Creating Virtual Network Configurations Offline**  
2-5-4 **Editing Components (Devices)**

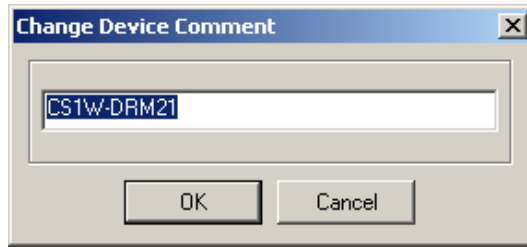

- 3 Change the device comment and click the **OK** Button.  
Device comments can be displayed by moving the mouse pointer to the locations of devices in the Network Configuration Window.

**Note** Device comments will be displayed when devices are pointed at on a network. In the detailed display, comments are displayed in the *Comment* column.

## 2-6 Manipulating Component Parameters

### 2-6-1 Overview

With the CX-Integrator, the parameters on components in the Network Configuration Window can be set. They can also be uploaded from, downloaded to, and compared with the parameters of the components on the actual network.

#### Applicable Components and Parameters

The components and parameters that can be manipulated are listed in the following table.

The parameters depend on the network type and Unit model. For details on parameter settings, refer to the corresponding network explanations and Unit manuals.

Component (See note 1.)	Parameters (See note 2.)
CPU Unit	Part of the PLC Setup: Communications settings for the peripheral and RS-232C ports and FINS protection settings Note: There are no parameters that can be set with the CX-Integrator for an NJ-series CPU Unit.
Serial Communications Boards/Units	Serial port communications settings
Controller Link Units	Unit communications settings and data link settings
SYSMAC LINK Units	Unit communications settings and data link settings
Ethernet Units	Unit communications settings
CompoWay/F slaves	CompoWay/F slave device parameters
DeviceNet Units	DeviceNet Unit device parameters
DeviceNet slaves	DeviceNet slave device parameters
CompoNet Master Unit	CompoNet Master Unit component parameters
CompoNet slaves	CompoNet Slave Unit component parameters

**Note 1:** The applicable component (Unit) when a PLC is selected on a Network Configuration Window depends on the type of communications and the serial port being used, as shown in the following table.

Communications	Applicable Unit
Ethernet	Ethernet Unit and EtherNet/IP Unit
Controller Link	Controller Link Unit
SYSMAC LINK	SYSMAC LINK Unit
CompoNet	CompoNet Master Unit
CompoWay/F	<ul style="list-style-type: none"> <li>• Serial port on CPU Unit: CPU Unit</li> <li>• Serial port on Serial Communications Unit/Board:</li> </ul>
NT Link	Serial Communications Unit/Board

**Note 2:** The parameters depend on the network type and Unit model. For details on parameter settings, refer to the corresponding network explanations and Unit manuals.

2-6 **Manipulating Component Parameters**  
 2-6-2 **Procedure**

2-6-2 **Procedure**

**Setting Parameters Offline**

To set parameters offline, right-click a component in the Network Configuration Window and select **Edit Parameters**. The Edit Parameters Dialog Box will be displayed. This dialog box can be used to set component parameters.

**Example for a PLC**

Right-click the PLC and select **Edit Parameters**, or double-click the PLC. The following dialog box will be displayed.

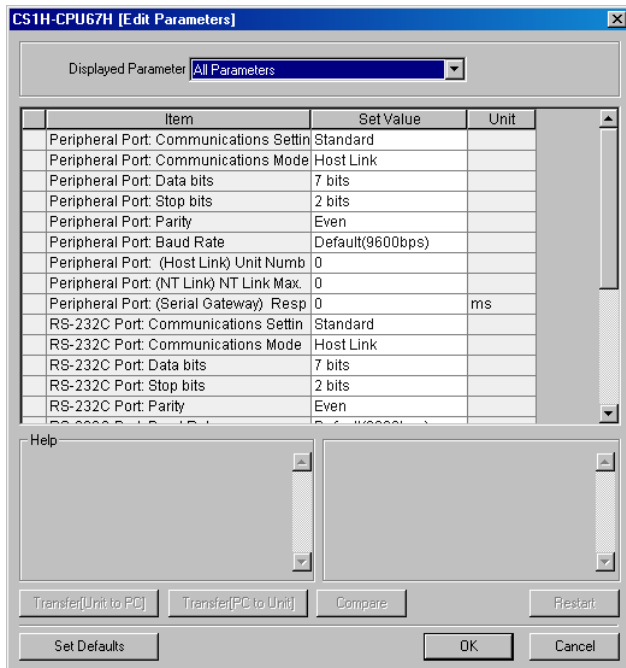

The following list will be displayed if the down arrow is clicked in the *Displayed Field*.

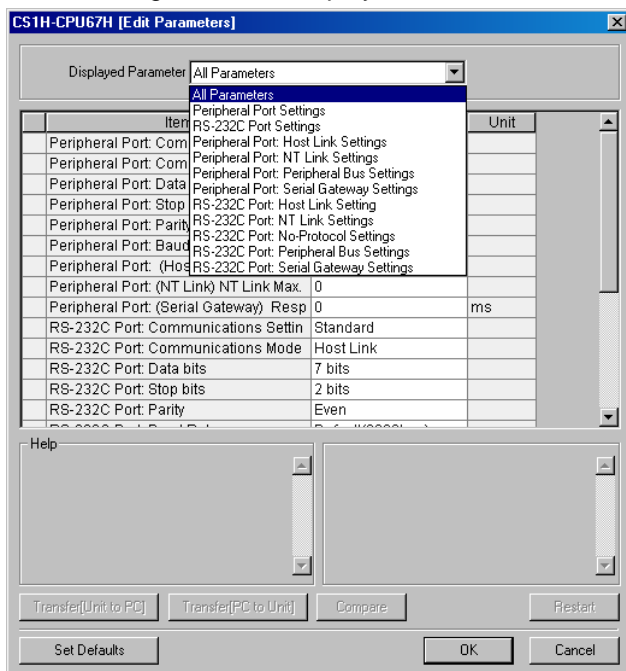

The following parameters can be set here: Communications settings for the peripheral and RS-232C ports and FINS protection settings across networks.

Select the appropriate value for each item from the pull-down lists and click the **OK** Button to change the settings.

**Note 1:** The items displayed here are the same ones as displayed on the Peripheral Port, Host Link Port, and FINS Protect Tab Pages of the PLC Setup in the CX-Programmer.

**Note 2:** Set other settings in the PLC Setup using the CX-Programmer PLC Setup settings.

**Example for a CompoWay/F Slave Component.**

Right-click a CompoWay/F slave component and select **Edit Parameters**. The Edit Parameter Dialog Box will be displayed.

## **Downloading and Uploading Parameters from Actual Components**

### **Uploading and Downloading Component Parameters for Individual Components**

#### **Downloading**

To download component parameters set on the computer to the actual component, select *Transfer [PC to Unit]* in the Edit Parameter Dialog Box. The parameters will be downloaded to the actual component.

**Note** Depending on the Unit, it may be necessary to restart in order to make the downloaded settings effective. Click the **OK** Button in the verification dialog box, and restart the Unit.

#### **Uploading**

To upload component parameters from the actual component to the computer, select *Transfer [Unit to PC]* in the Edit Parameter Dialog Box. The parameters will be uploaded from the actual component.

#### **Comparing**

To compare the component parameters set on the computer to those in the actual component, and select *Compare* in the Edit Parameter Dialog Box. The parameters set for the component on the computer will be compared with those set in the actual component.

**Note** When downloading parameters to the actual component, the unit version of the component on the computer and the unit version of the actual component must be the same.  
If the following message is displayed when attempting to download parameters, the unit version of the component on the computer is different from the unit version of the actual component.

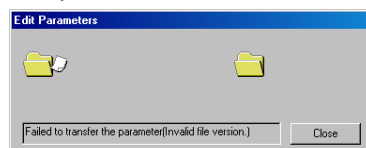

Use the following procedure to change the unit version of the component on the computer to the same unit version as the actual component and then download the parameters.

1. Right-click the PLC in the Network Window and select **Compare and Change Unit Version** from the pop-up menu.

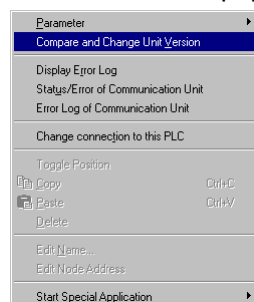

**2-6 Manipulating Component Parameters**  
**2-6-2 Procedure**

3. The results of comparing the unit version of the component on the computer to the unit version of the actual component will be displayed as shown below.
  - The following display will appear if the unit version of the component on the computer is newer than the unit version of the actual component.

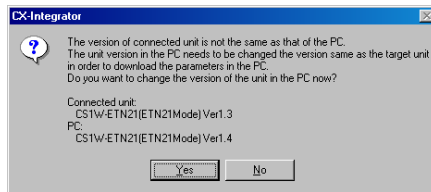

- The following display will appear if the unit version of the component on the computer is older than the unit version of the actual component.

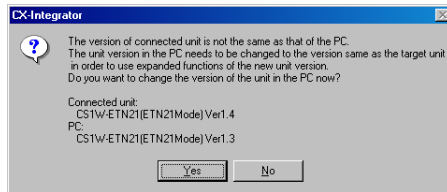

3. Click the **Yes** Button to change the unit version of the component on the computer so that it is the same as the unit version of the actual component.
4. The unit version of the component on the computer will be changed and the following dialog box will be displayed. Click the **OK** Button.

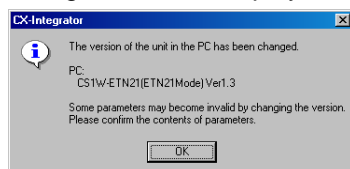

5. Changing the unit version of the component on the computer may make some of the parameters that have been set invalid. Check the parameter settings and then download the parameters.

**Uploading and Downloading Parameters for All Components in the Network**

**Downloading**

To download all of the component parameters set in the virtual network on the computer to all components on the actual network, right-click the network in the Workspace Window and select **Transfer [PC to Network]** from the pop-up menu. All parameters will be downloaded to all of the components on the actual network with the same network address.

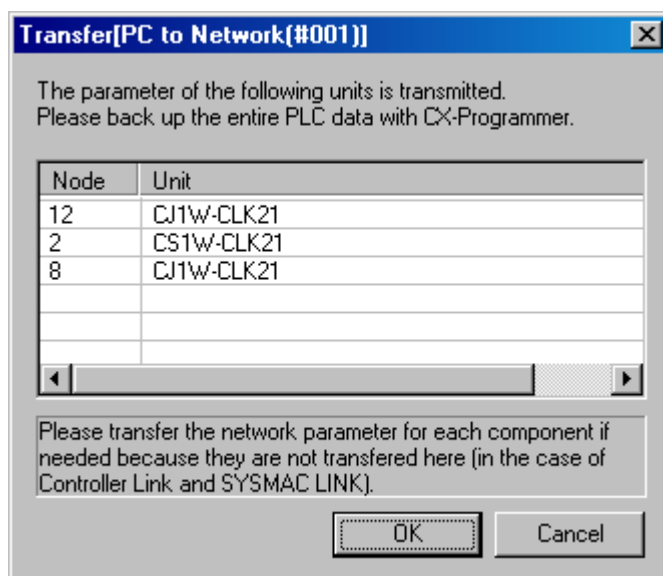

A list will be displayed of the Units to which the parameters will be downloaded. Clicking the **OK** Button will start the transfer. Clicking the **Cancel** Button will cancel the transfer.

For DeviceNet, the following dialog box will be displayed.

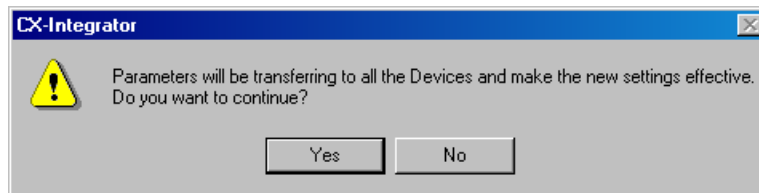

Clicking the **Yes** Button will start the transfer. Clicking the **No** Button will cancel the transfer.

### **Uploading**

To upload all of the component parameters set in the components on the actual network to all components in the virtual network on the computer, right-click the network in the Workspace Window and select **Parameter - Upload** from the pop-up menu. All parameters will be uploaded from all of the components on the actual network with the same network address.

## 2-7 **Uploading, Downloading, and Comparing Network Parameters**

### 2-7-1 **Overview**

With the CX-Integrator, the parameters of networks in the Workspace Window can be uploaded from, downloaded to, and compared with the parameters of the actual network.

#### **Applicable Networks**

The networks and parameters for which network parameters can be uploaded, downloaded, and compared are listed in the following table.

<b>Network</b>	<b>Parameters</b>
Controller Link networks	Network parameters: Maximum node address, number of polling nodes, allowable number of send/receive frames
SYSMAC LINK networks	Network parameters: Communications cycle time, maximum node address, number of polling nodes, allowable number of send/receive frames

### 2-7-2 **Procedure**

#### **Setting Parameters Offline**

To set parameters offline, right-click a network in the Workspace Window and select **Parameter – Edit**. The Edit Parameter Dialog Box will be displayed. The network parameters can be set in this dialog box.

#### **Downloading and Uploading Parameters from Actual Networks**

##### **Downloading**

To download the parameters set for the virtual network on the computer to an actual network, right-click the network in the Workspace Window and select **Parameter – Transfer [PC to Network]** from the pop-up menu. The parameters will be downloaded to the actual network with the same network address.

##### **Uploading**

To upload the parameters set for the actual network to the virtual network on the computer, right-click the network in the Workspace Window and select **Parameter - Transfer [Network to PC]** from the pop-up menu. The parameters will be uploaded from the actual network with the same network address.

##### **Comparing**

To compare the parameters set for the virtual network on the computer to the parameters of an actual network, right-click the network in the Workspace Window and select **Parameter - Compare** from the pop-up menu. The parameters set for the virtual network on the computer will be compared with those set in the actual network with the same network address.



## 2-8 Comparing Network Configurations

### 2-8-1 Overview

The configuration of a virtual network on the computer can be compared to the configuration of an actual network. The model numbers of all nodes are also compared. Component parameters are not compared.

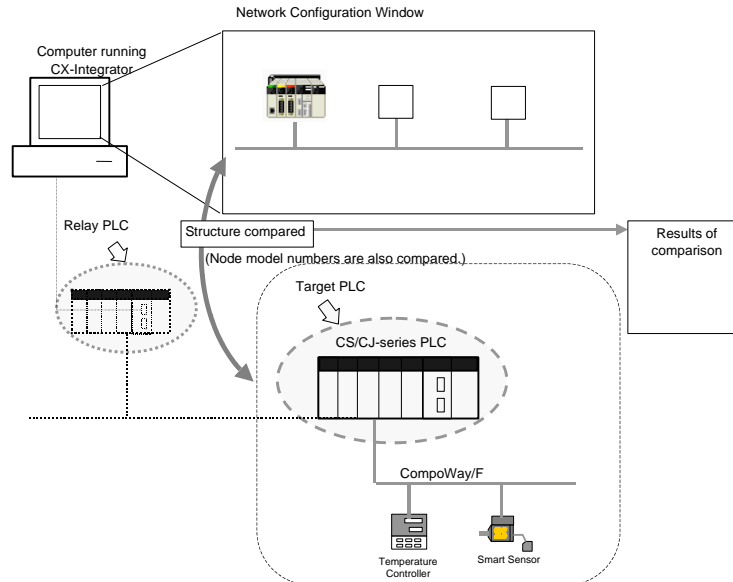

### 2-8-2 Procedure

1. Right a network in the Workspace Window and select **Connect** from the pop-up menu. Accessing the network will be enabled and the icon to the left will change to .

If the network has been uploaded but a network address is not displayed (Net(-) displayed), it will be necessary to select the desired network in the Workspace Window, right-click, and select **Connect**.

2. Right-click the network and select **Compare** from the pop-up menu. For an Ethernet network, the following dialog box will be displayed.

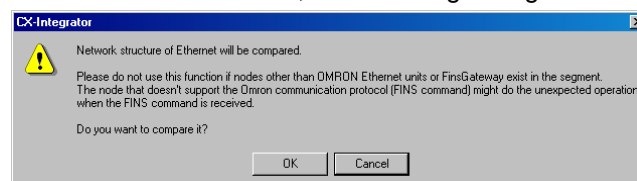

Check to confirm that no nodes other than OMRON Ethernet Units or FinsGateway exist in the same segment, and then click the **OK** Button.



#### Caution

Do not use this function if a node exists for something other than an OMRON Ethernet Unit or FinsGateway within the same segment on Ethernet, and when the Ethernet network system is in operation. When an Ethernet network configuration upload is executed, an OMRON FINS command is sent to all nodes in the segment. Therefore, if a node exists for something other than an OMRON Ethernet Unit or FinsGateway, the FINS command will not be received at that node and unexpected operation may occur.

3. The network configuration of the virtual network will be compared to the configuration of the network with the same network address and the results will be displayed.

**Note:** The virtual networks on the computer correspond to actual networks with the same network addresses.

## 2-9 File Operations

### 2-9-1 Overview

The following files can be saved and read by the CX-Integrator.

File name		File name extension	Contents	Storage location when downloaded
Project files		.cin	Connection information to the Relay PLC Overall network configuration of the target PLC including parameters (See note.)	---
Network configuration files	Network structure files	.npf	DeviceNet configuration of the target PLC including parameters Note: Each file contains only one network.	All DeviceNet slaves on the network
	Controller Link node files	.csv	Network configuration for Controller Link networks connected directly to the target PLC	---
Component parameter files	DeviceNet device parameter files	.dvf	Parameters for individual DeviceNet devices (master or slave)	All DeviceNet slaves
	Component parameter files	.xml	Parameters for all components except for DeviceNet devices Note: These files do not include Temperature Controller information.	All components
Data link files	Controller Link data link table files (.cl2)	.cl2	Controller Link user-set data link tables	CPU Bus Unit setup area in the parameter area of the CPU Unit
	SYSMAC LINK data link table files	.sl3	SYSMAC LINK user-set data link tables	CPU Bus Unit setup area in the parameter area of the CPU Unit
FINS local routing table files		.rtg .rxg	Routing tables of the target PLC Note: The rtg files are compatible with the earlier file format, and up to 20 relay routing tables can be registered.	Parameter area in the CPU Unit
FINS network routing table files		.rt3 .rx3	Routing tables for all PLCs on the networks to which the target PLC belongs Note: The rt3 files are compatible with the earlier file format, and up to 20 relay routing tables can be registered.	Parameter area in the CPU Unit

**Note:** A project file that contains a CompoNet Network cannot be used with CX-Integrator version 2.1 or lower. Upgrade to CX-Integrator version 2.2 or higher.

**Note** Network configurations and device parameters can be saved individually in network configuration files and component parameter files. Doing so will enable quicker system recovery when a failed device is replaced because the parameter file can be read to quickly reset the replaced device.

## 2-9-2 Procedures

### Saving Files

#### Project Files (.cin)

1. Select **File – Save** or **File – Save as** from the menu bar. The Save As Dialog Box will be displayed.
2. Specify the directory and file name and click the **Save** Button. The default name is *NewProject.cin*.

#### DeviceNet Network Structure Files (.npf)

1. Double-click a DeviceNet network in the Workspace Window to make the network active in the Network Configuration Window.
2. Select **File – Export – Network** from the menu bar. The Network Structure (npf). Export DeviceNet List (CSV) Dialog Box will be displayed.

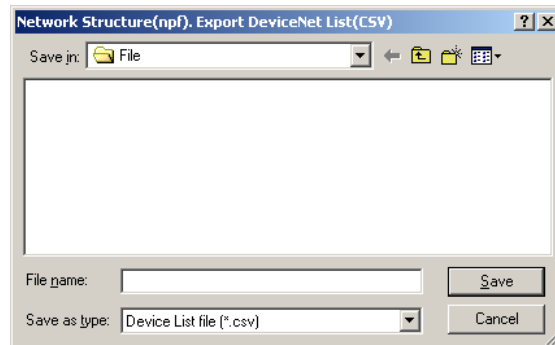

3. Select the type of file to be saved (.npf or .csv) and click the **Save** Button.

#### Project Files in the CX-Integrator Version 1 Format (\*.cin)

1. Select **File – Export – Export Network As V1.0**. The Select Network Dialog Box will be displayed. Select the network to be saved, and click the **OK** Button.

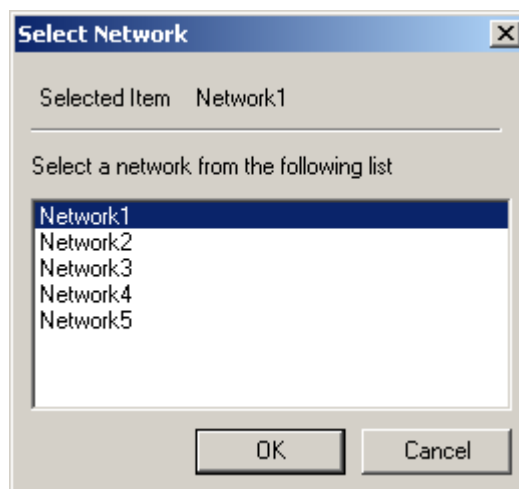

**Note:** CompoNet Networks are not supported by CX-Integrator version 1. They cannot be selected.

2. Specify the desired directory, input the desired filename, and click the **Save** Button. The default file name is the network name with filename extension .cin.

**Note** The registered device parameters will be saved along with the network configuration.

### Component Parameter Files

#### DeviceNet Device Parameter Files (.dvp)

1. Select a device in a DeviceNet network in the Network Configuration Window.
2. Select **Component – Parameter - Save** from the menu bar.

#### Component Parameter Files (.xml)

1. Select a component in the Network Configuration Window.
2. Select **Component – Parameter – Save** from the menu bar.  
 A dialog box to specify the folder and file name in which to save the component parameters will be displayed.
3. Specify the folder and file name and click the **Save** Button.  
 The file will be saved.

### Reading Files

#### Project Files (.cin)

1. Select **File – Open** from the menu bar.  
 The Open Dialog Box will be displayed.
2. Select the project file and click the **Open** Button.  
 The project file will be read.

#### Network Configuration Files

##### DeviceNet Network Structure Files (.npf)

1. Select **File - Import - Network** from the menu bar.  
 The Open Dialog Box will be displayed.
2. Select a DeviceNet configuration file (.npf) and click the **Open** Button.  
 The DeviceNet network configuration in the file will be added to the Workspace Window.

#### Component Parameter Files

##### DeviceNet Device Parameter Files (.dvp)

1. Select a device in a DeviceNet network in the Network Configuration Window.
2. Select **Component - Parameter - Load** from the menu bar.  
 The DeviceNet device parameter file will be read.

##### Component Parameter Files (.xml)

1. Select a component in the Network Configuration Window.
2. Select **Component - Parameter - Load** from the menu bar.  
 The component parameter file will be read.

#### DeviceNet Comment Lists (.csv)

1. Select a device in a DeviceNet network in the Network Configuration Window.
2. Select **File – Export - Component - Comment Lists** from the menu bar.

Device type	Exported comment data
Master device	Comment for the master (if one exists) and comments for devices registered in the scan list If more than one connection is supported for a slave device registered in the scan list, only the comment for the connection used by the master device will be exported.
Slave device	Comment for the slave If more than one connection is supported for a slave device, the comments for all connections will be exported even if they are not registered in the master device.

**Note** Exporting Master Unit Device Parameters to Special Files

Device parameters for OMRON DeviceNet Master Units and DeviceNet Units (CVM1-DRM21-V1, C200HW-DRM21-V1, and CS1W-DRM21(-V1)) can be exported to files for NetXServer for DeviceNet or DRM\_UNIT files for Open Network Controllers. Use the following procedure to export device parameters for OMRON DeviceNet Master Units and DeviceNet Units.

- 1 Select the Master Unit.
- 2 Select **Network – Parameter – Save** from the menu bar.
- 3 Select the export type.

The three export types listed in the following table are supported.

Export type	Contents
NetXServer DDE setting file	Scan list information in NetXServer DDE Edition file format
NetXServer ONC setting file	Scan list information in NetXServer ONC Edition file format
ONC master setting file	Scan list information in ONC master parameter setting file format

- 4 If valid devices are registered in the scan list, a dialog box will be displayed to specify the folder and file name.
- 5 Specify the folder and file name and click the **Save** Button.  
The data will be exported to a file.

Refer to the hardware and software manuals for the specific product for application methods of the exported files.

**Note** Some of the comment data exported in CSV format can be used in the CX-Programmer's conversion tables by taking the data through spreadsheet software.

## 2-10 Target PLC Online Operations

### 2-10-1 Overview

With the CX-Integrator, the following operations are possible for the target PLC.

- Creating, editing, and transferring I/O tables (See note.)
- Displaying CPU Unit errors (See note.)
- Changing the CPU Unit operating mode

Note: These operations are not supported for NJ-series CPU Units with the CX-Integrator.

### 2-10-2 Procedure

Right-click the target PLC online. The following pop-up menu will be displayed.

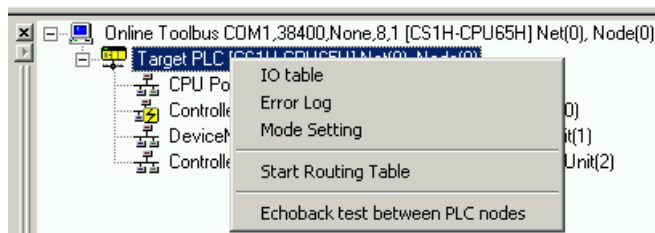

Popup menu	Function
IO table (See note.)	Starts the I/O table component.
Error Log (See note.)	Starts the PLC Error Component.
Mode Setting	Changes the operating mode of the CPU Unit
Start Routing Table (See note.)	Starts the Routing Table Component.
Echoback test between PLC nodes	Starts an echoback test to check the network communications status.

Note: You cannot use these menu commands for an NJ-series CPU Unit.

#### I/O Tables (Online Only)

If **IO table** is selected, the PLC I/O Table Dialog Box (I/O Table Component) will be displayed.

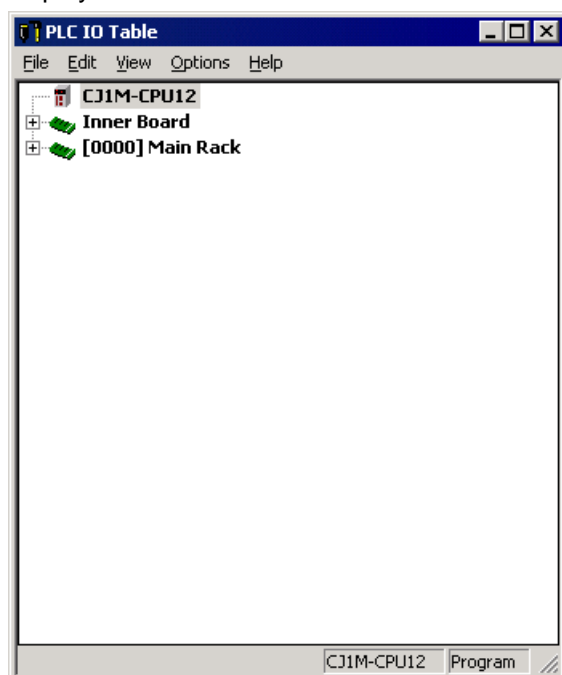

To upload the I/O tables, select **Options – Transfer from the PLC** from the menu bar.

### Displaying Current Errors and Error Logs (Online Only)

If **Error Log** is selected, the PLC Errors Dialog Box will be displayed.

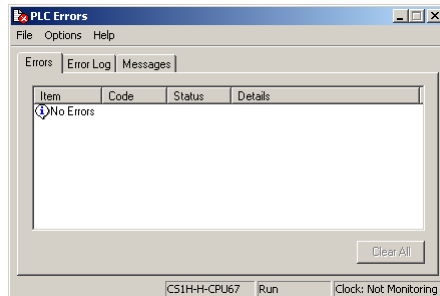

**Errors Tab:** All current errors are displayed.

**Error Log:** A total of 20 error records will be registered in the error log (or up to the maximum number of error records supported by the PLC).

**Messages:** Messages generated by execution of the MSG instruction will be displayed.

### Changing the Operating Mode (Online Only)

If **Mode Setting** is selected, the PLC Mode Setting Dialog Box will be displayed. The operating mode of the CPU Unit can be changed.

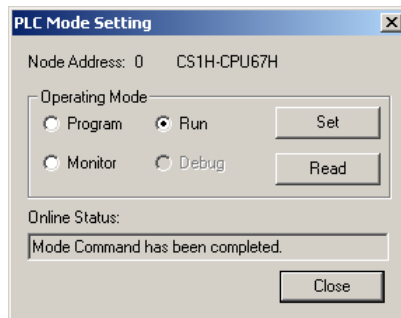

Select **Program**, **Run**, or **Monitor** in the **Operating Mode** Field and click the **Set** Button. Click the **Read** Button to display the current operating mode of the target PLC in the **Online Status** field.

### Starting the Routing Table Component

If **Start Routing Table** is selected, the Routing Table Component will start.

### Echoback Test between PLC Nodes

Selecting **Echoback test between PLC nodes** starts an echoback test between the PLC nodes. For details on this operation, refer to *10-2 Echoback Test between Nodes*.

## 2-11 Starting Specified Applications

### 2-11-1 Overview

When starting specified applications, a dialog box is displayed for selecting applications for individual components.

### 2-11-2 Procedure

1. Right-click the component in the Network Configuration Window, and select **Start Special Application – Start with Settings Inherited** or **Start Special Application – Start Only** from the pop-up menu.

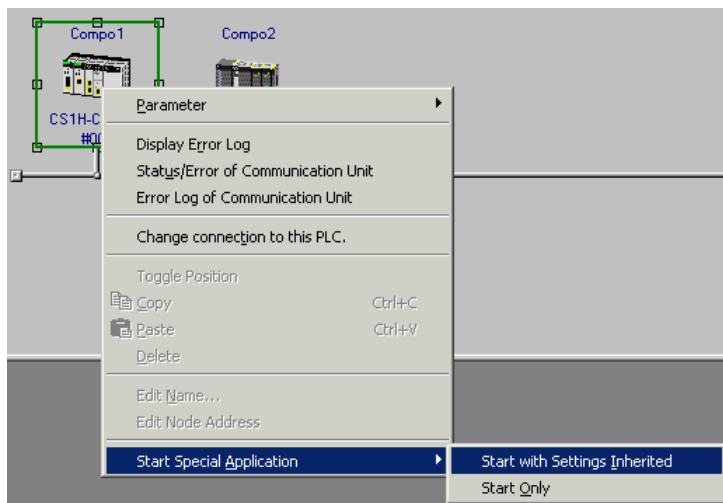

2. The following dialog box will be displayed.

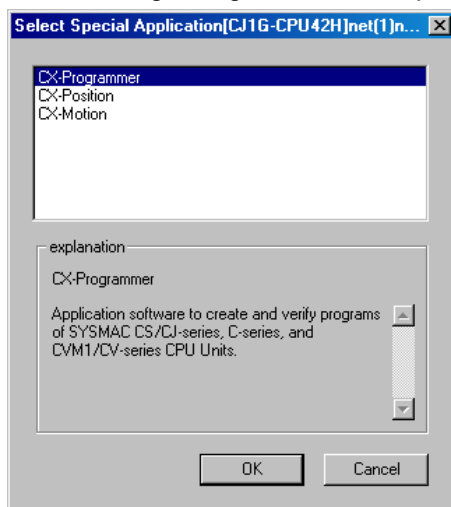

Select any of the applications to display an explanation of that application.

3. To start a special application, select it and click the **OK** Button.



## 2-12 Printing

### File – Print

This section describes the procedure for printing device parameters and comments from the currently displayed network configuration.

Use the following procedure to print.

- 1 To print only part of the device parameters or comments, select the devices for which to print.
- 2 Select **File – Print**.  
If DeviceNet devices were selected, the following dialog box will be displayed.

- Using DeviceNet

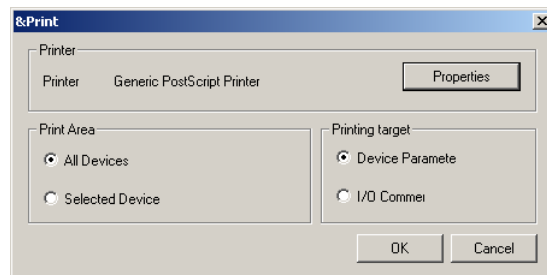

- Using CompoNet

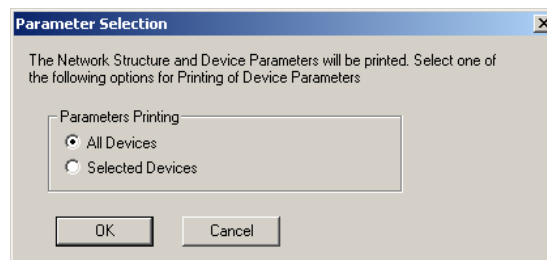

- 3 For DeviceNet and CompoNet devices, select the range of devices for which to print.  
All Devices: Prints data for all devices in the network configuration.  
Selected Device: Prints data for only the selected devices.  
Only one of these options can be selected.
- 4 Select the data to print. (DeviceNet only)  
Device Parameter: Prints the device parameters.  
I/O Comments: Prints device comments.  
Only one of these options can be selected.
- 5 If necessary, click the **Properties** Button and set the printer.  
The printer settings will depend on the printer being used.
- 6 Click the **OK** Button.  
The data will be printed.  
If I/O comments are being printed when using DeviceNet, the following comments will be printed depending on the device.

Device type	Printed comment data
Master device	Comment for the master (if one exists) and comments for devices registered in the scan list If more than one connection is supported for a slave device registered in the scan list, only the comment for the connection used by the master device will be printed.
Slave device	Comment for the slave If more than one connection is supported for a slave device, the comments for all connections will be printed even if they are not registered in the master device.



# **Communications**

## **Section 3 Routing Tables**

This section describes how to set the routing tables.

## 3-1 Routing Table Overview

### 3-1-1 Definition of Routing Tables

The routing tables register the paths to destination networks and the addresses for the nodes in FINS communications. The routing tables are required when transferring data between networks by message communications or other functions, or switching the destination PLC in the network accessed from a Programming Device or ladder program instruction.

Set the routing tables in the PLCs as required. Refer to 3-1-2 *Network Conditions That Require Routing Tables* for details on the cases when routing tables are required.

Routing tables consist of the following two tables.

1) Local network table

When two or more Communications Units are mounted in a single PLC, the CPU Unit uses the local network table to identify the Communications Units and associated networks.

The local network table is required when two or more Communications Units are mounted in a single PLC, or data will be transferred across network levels.

2) Relay network table

When transferring data between networks, the relay network table indicates how to relay a received message to reach the final destination node.

The relay network table is required when data will be transferred across network levels.

#### Local Network Table

The local network table lists the unit numbers of the Communications Units mounted in each PLC, and the network addresses of the connected networks. When data is being transferred from the PLC to a destination network address, the local network table indicates which Communications Unit can be used to send data to the destination network address.

The local network table is stored in the CPU Unit, and it is possible to switch the destination network first accessed from a Programming Device or ladder program instruction.

#### Unit Number

This value (0 to 15) is set with the rotary switches on the front of each Communications Unit

#### Network Address

- Sets the network address (1 to 127) of the network to which each Communications Unit is connected.
- The network address must be greater than zero. (See note.)

Note: Setting a network address of 0 indicates to the computer that a local network table is not set in the PLC.

In this manual, network address 0 is called the local network address.

Example Local Network Table

Unit number	Local network address
00	1
01	2
02	3

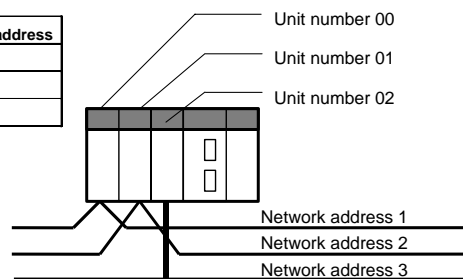

**Note**

1. If there is no local network table and the network is accessed from a Programming Device or ladder program instruction with the network address = 0, the CPU Unit will automatically access the network of the Communications Unit with the lowest unit number in the FINS system.
2. With CX-Integrator version 2.1 or higher, the destination network can be switched when transferring routing tables. (The FINS system is used in the example described above.)  
 For details, refer to *3-2-10 Transferring Routing Tables to a Network PLC through a Direct Serial Connection*.

**Relay Network Table**

The relay network table indicates the network address and node address of the first relay node to reach each destination network (final network). When data is being transmitted across network levels, the data is transmitted to the final network by being passed through the relay nodes set in the relay network tables. With the standard table format, up to 20 networks (lines) can be registered in the relay network table. With the extended table format (see note), up to 64 networks (lines) can be registered in the relay network table.

Note: The extended table format is supported only for CJ2/CJ1-R CPU Units.

Example: In this case, the tables have been set to route communications from network address 1 (local node: PLC1) to network address 3 (destination node: PLC4).

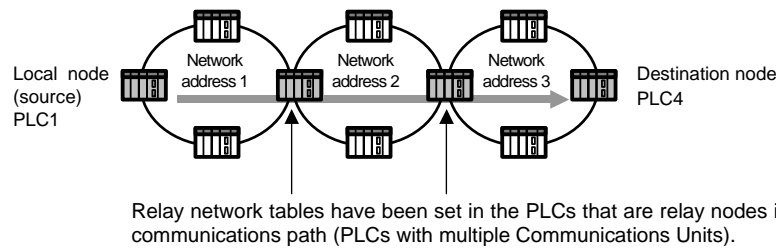

**Items in the Relay Network Table**

The relay network table is made up of the following items.

- 1) Destination network address  
 Specifies the address (1 to 127) of the final destination network, which is in another network level.
- 2) Relay network address  
 Specifies the address (1 to 127) of the network containing the first relay node in the path to the destination network.
- 3) Relay node address  
 Specifies the node address of the first relay node in the path to the destination network.

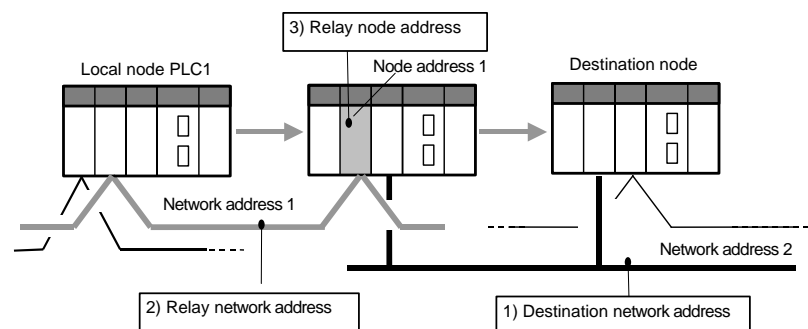

**Setting Example**

The following example shows the routing tables that route communications from PLC1

### 3-1 Routing Table Overview

#### 3-1-2 Network Conditions That Require Routing Tables

(network address 1, node address 1) to PLC4 (network address 3, node address 2).

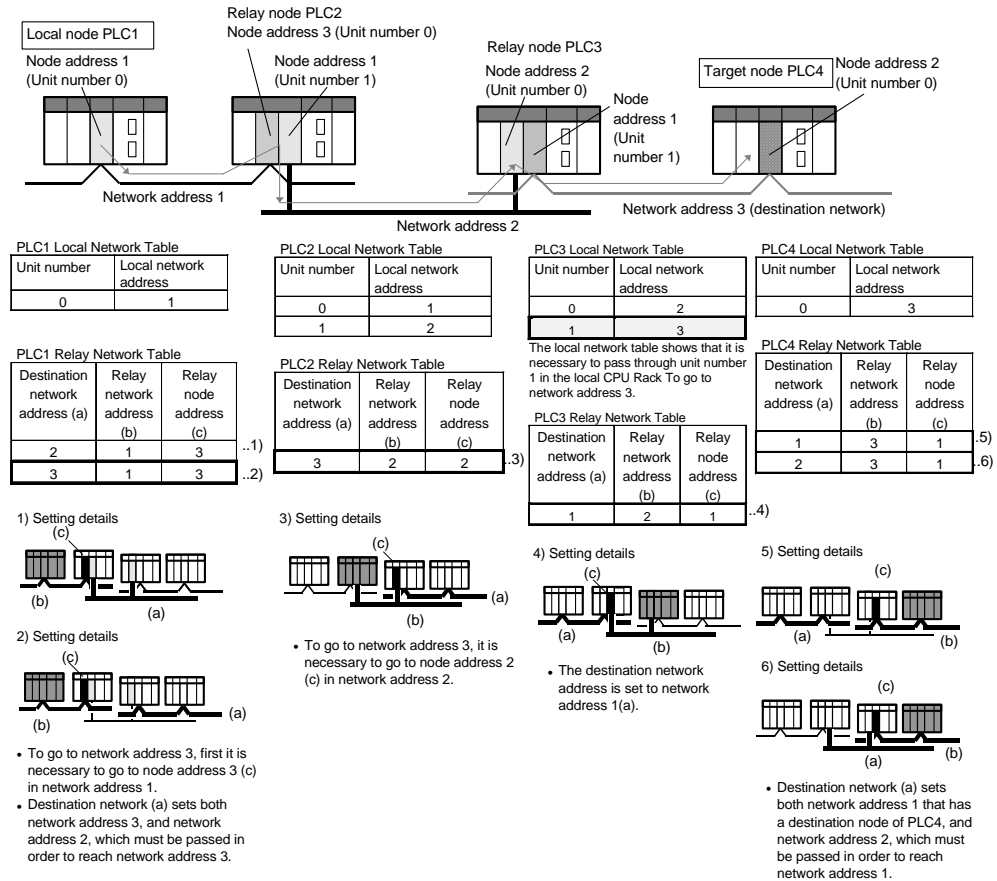

### 3-1-2 Network Conditions That Require Routing Tables

When necessary, set the routing tables (local network table and relay network table) in the PLC as shown in the following table.

Network usage	Routing table	
	Local network table	Relay network table
One Communications Unit is mounted in the PLC, and that Unit is connected to one network.	Not required	Not required
Two or more Communications Units are mounted to one PLC (CPU Unit).	Required	Not required
Routing tables have been set in at least one other node in the same network.	Required	Not required
Communications are made across network levels.	Required	Required

#### Routing Table Settings not Required

Routing tables are not required when just one Communications Unit is installed in each PLC and those Communications Units are connected in a single network.

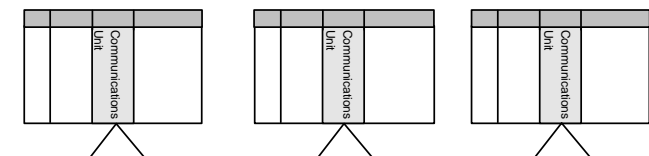

#### Local Network Table Settings Required

- A local network table is required when there is even one other node in the same

## 3-1 Routing Table Overview

### 3-1-3 Routing Table Setting Methods

- network in which routing tables have been set already.
- A local network table is required when there are two or more Network Communications Units (see note) mounted to a single CPU Unit.

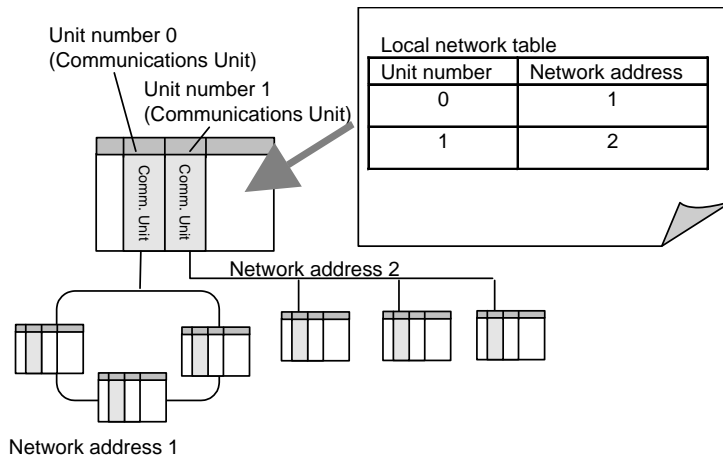

**Note:** In this context, the following are Network Communications Units: Ethernet Unit, Controller Link Unit, SYSMAC LINK Unit, DeviceNet Unit, FL-net Unit, EtherNet/IP Unit, built-in EtherNet/IP port, or Serial Communications Board/Unit (when the serial port is treated as a Network Communications Unit). EtherNet/IP Units and built-in EtherNet/IP ports are treated as Ethernet Units.

#### Note

The following, however, is an exception. In this case, a local network table does not need to be registered even if there is more than one Network Communications Unit. If a local network table is not registered, network access will be possible to only the network of the Communications Unit with the smallest unit number when a direct serial connection is made to a target PLC.

### Relay Network Table Settings Required

#### Communicating across Network Levels

Routing tables are required when communicating with another PLC in a network outside of the local network.

Setting routing tables makes it possible to communicate with other network levels using FINS message communications or the CX-Programmer's remote programming and monitoring functions.

## 3-1-3 Routing Table Setting Methods

To set the routing tables, start the Routing Table Component. The Routing Table Component can be started with either of the following methods.

For details on making the routing table settings in the Routing Table Component, refer to 3-2-2 *Creating the FINS Local Routing Tables*.

Method 1:

While online, right-click the Communications Unit or Port in the Online Connection Information Window select **Start Routing Table** from the popup menu.

Method 2:

While offline, select **Tools - Start Routing Table** from the menu bar.

Method 3:

While online, right-click the target PLC in the Online Connection Information Window select **Start Routing Table** from the popup menu.

### 3-1 Routing Table Overview

#### 3-1-4 Routing Table File Types Supported by the CX-Integrator

### 3-1-4 Routing Table File Types Supported by the CX-Integrator

The following two kinds of routing tables can be set in the CX-Integrator.

When the routing tables have been set, they can be saved to a file and retrieved later.

File type	Functions	File name extension
FINS local routing table files	<p>This file contains the routing tables set in each PLC. The file is mainly used to create the network configuration when the network starts up. Transfer the files to PLCs connected directly to the CX-Integrator by a serial connection, and PLCs in the network via the PLC directly connected by a serial connection. For details on setting methods, refer to 3-2 <i>Setting the Routing Tables</i>.</p> <p>Create or edit the routing table for the PLC connected directly to the CX-Integrator. Create the file for the network structure, read the created files, and transfer them to the directly connected PLC.</p> <p>Note: It is also possible to read routing table files (*.rtg) created with Support Software such as SYSMAC Support Software, CV Support Software, and Controller Link Support Software.</p>	<p>The number of nodes that can be registered in the relay network table depends on the registration mode.</p> <ul style="list-style-type: none"> <li>• Standard mode: .rtg</li> <li>• Extended mode: .rxg</li> </ul>
FINS network routing table files	<p>This file contains the routing tables of all PLCs in the network (the network containing the PLC that is directly connected to the CX-Integrator). This file is used for maintenance after configuring the network.</p> <p>After configuring the network (transferring the routing table to each node, connecting to the network, and completing settings), the routing tables can be read through the network and edited to create the FINS network routing table file. For details on setting methods, refer to 3-3 <i>Maintenance after Network Configuration</i>.</p>	<p>The number of nodes that can be registered in the relay network table depends on the registration mode.</p> <ul style="list-style-type: none"> <li>• Standard mode: .rtg</li> <li>• Extended mode: .rxg</li> </ul>

### 3-1-5 Transferring the Routing Tables

With the CX-Integrator, routing tables can be transferred to a PLC directly connected by serial communications (see note).

The following two methods can be used to transfer the routing tables to the PLC.

Note: A PLC is “directly connected by serial communications” in the following case:

The CX-Integrator is connected to the PLC’s peripheral port or RS-232C port (or USB port) by a special Programming Device cable (or standard USB cable), and online communications are indicated with network address 0 and node address 0.

#### Method 1: Transferring to a PLC through a Direct Serial Connection

Connect directly to individual PLCs by serial communications, and transfer the tables. This is the basic transfer method.

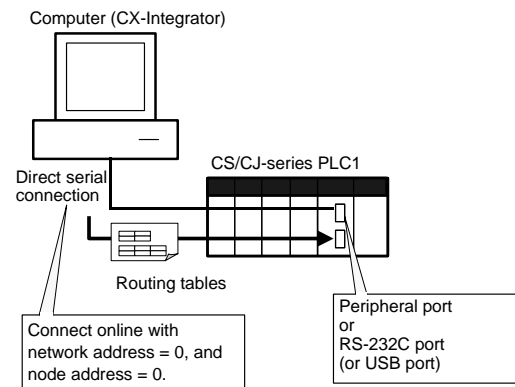

#### Note

With the CX-Integrator version 2.1 or higher, it is also possible to connect online directly by Ethernet (connecting with network address 0 and node address 0), and transfer the routing tables.



## 3-1 Routing Table Overview

### 3-1-6 Operating Procedures Prior to Routing Table Transfer

#### Method 2: Transferring to a PLC in the Same Network as the Directly Connected PLC (FINS Local Routing Table Only)

When a PLC is connected directly by serial communications, the routing tables can be transferred to each PLC in the same network as the directly connected PLC. (See notes 1 and 2.)

The routing tables cannot be transferred to another network level.

Note 1: Use CX-Integrator version 2.1 or higher.

Note 2: Use one of the following PLC models as the PLC directly connected by serial communications.

- A CS/CJ-series CPU Unit with unit version 4.0 or later

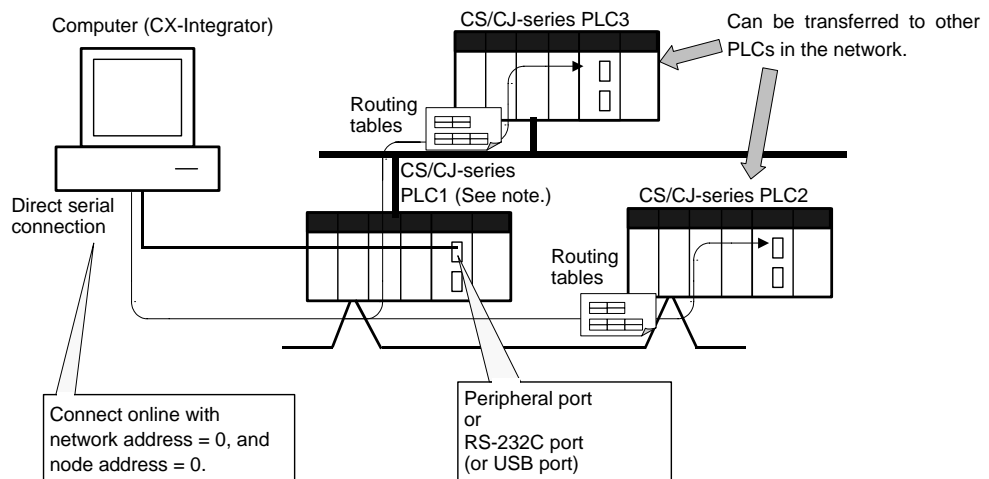

**Note** When connecting online through Ethernet, the FINS network routing table cannot be set or transferred if there is even one node in the network that does not automatically generate an Ethernet IP address from the FINS node address. Be sure that all of the nodes will automatically generate IP addresses when using Ethernet.

### 3-1-6 Operating Procedures Prior to Routing Table Transfer

This section describes the operating procedures necessary to create the routing tables for the first time up to the point where the files are transferred to the PLCs.

**Note** When constructing the network, set FINS local routing tables in all nodes (CPU Units) that will participate in the network.

## 3-1 Routing Table Overview

### 3-1-6 Operating Procedures Prior to Routing Table Transfer

#### Network Configuration Procedures

##### Creating the FINS Local Routing Tables Online

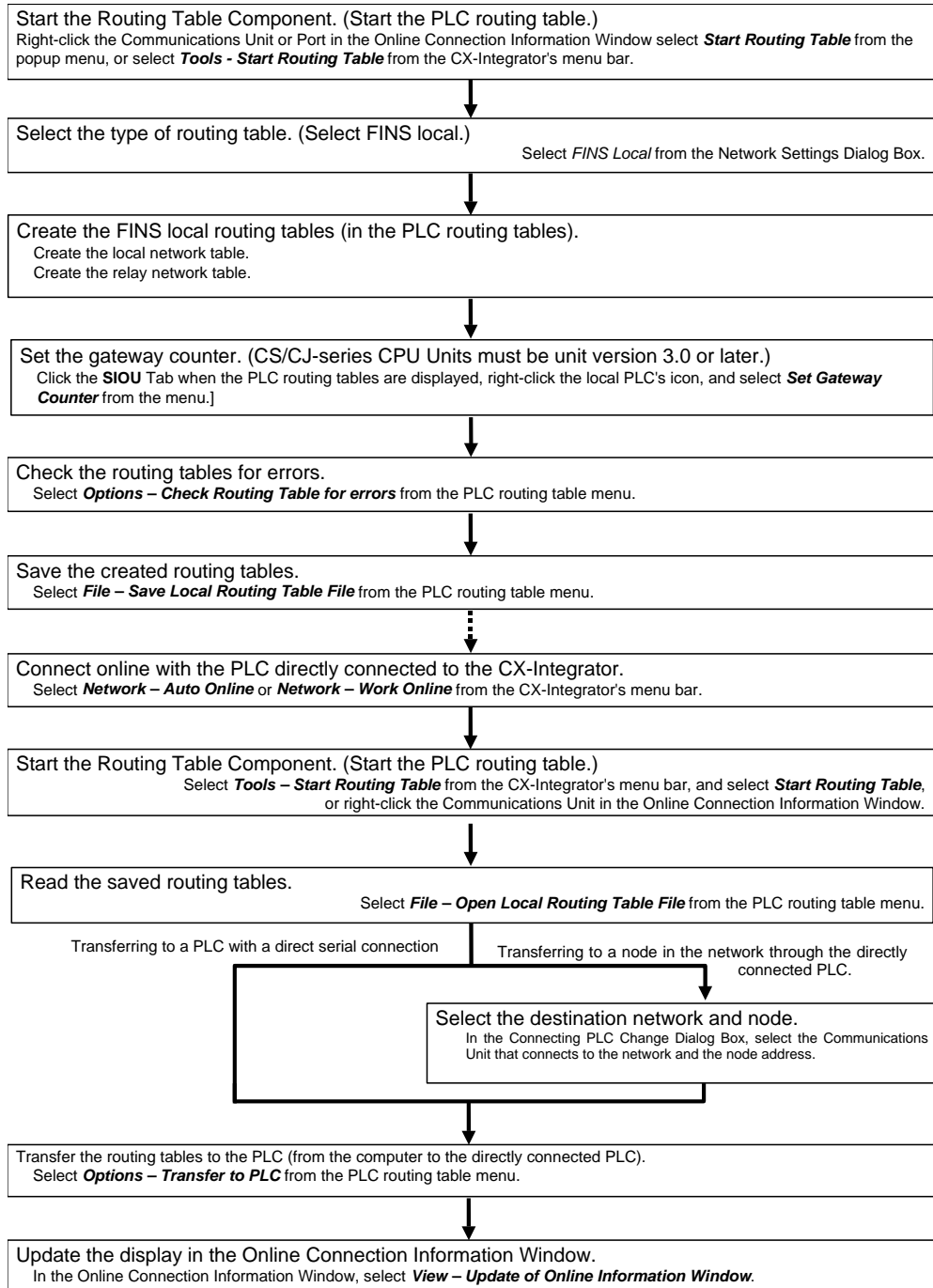

## 3-1 Routing Table Overview

### 3-1-6 Operating Procedures Prior to Routing Table Transfer

#### Creating the FINS Local Routing Tables Offline

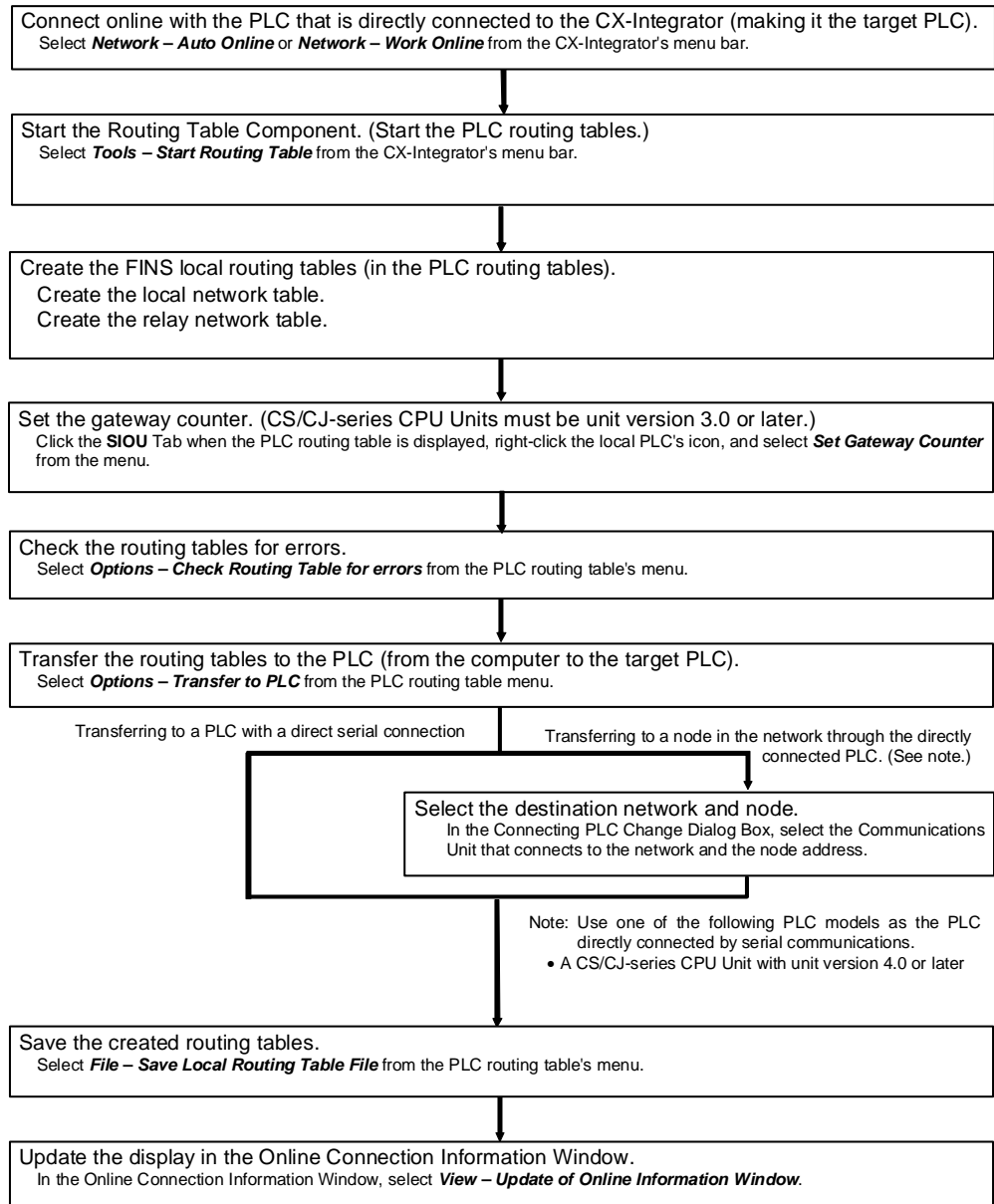

## 3-1 Routing Table Overview

### 3-1-6 Operating Procedures Prior to Routing Table Transfer

#### Procedures after Network Configuration

Connect the CX-Integrator online to each node (CPU Unit) in the network, and read and edit each node's FINS local routing table in the FINS Network Routing Table Window.

All of the FINS local network tables read from the network's PLCs can be saved together in the FINS network routing table file.

Note: After the network is configured, use the FINS network routing table when reading and editing (via the network) the routing tables of all nodes in the network.

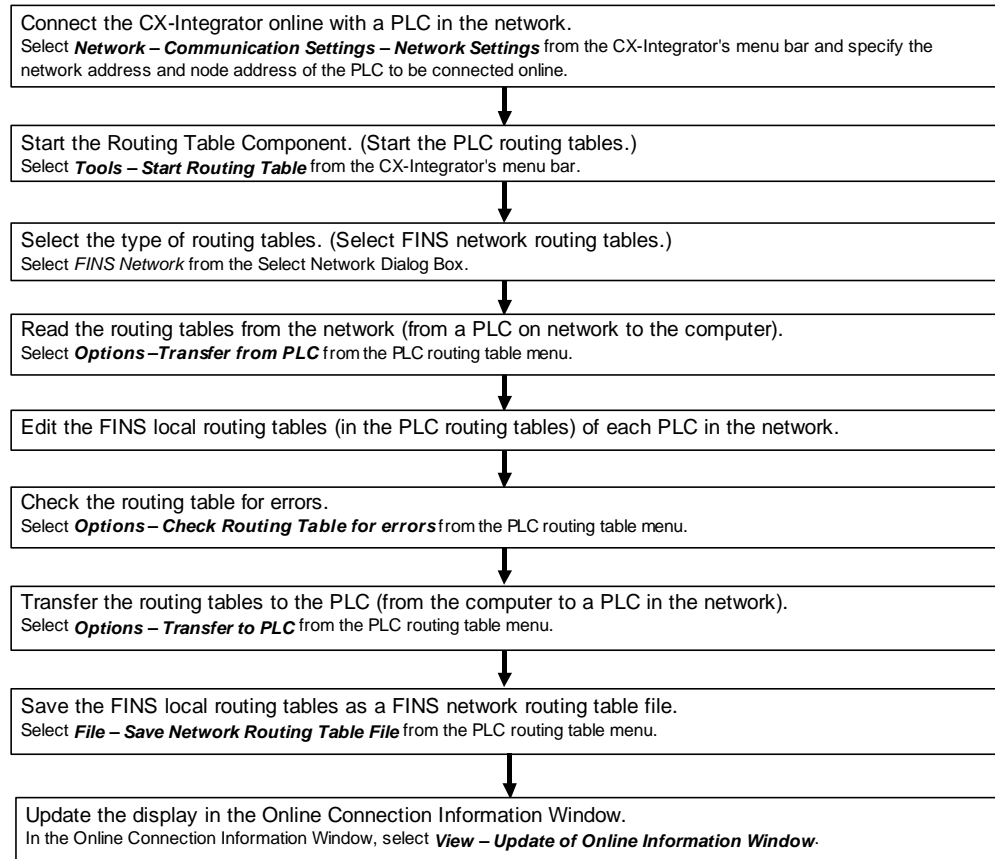

## 3-2 Setting the Routing Tables

This section explains how to make the necessary settings when transferring the FINS local routing tables to a PLC connected directly by a serial connection.

Note: You cannot set routing tables for NJ-series CPU Units with the CX-Integrator. Use the Sysmac Studio to set them.

### 3-2-1 Routing Table Setting Example

This section explains how to create and transfer the FINS local routing tables for the following network structure.

Example: Routing from PLC1 to PLC3

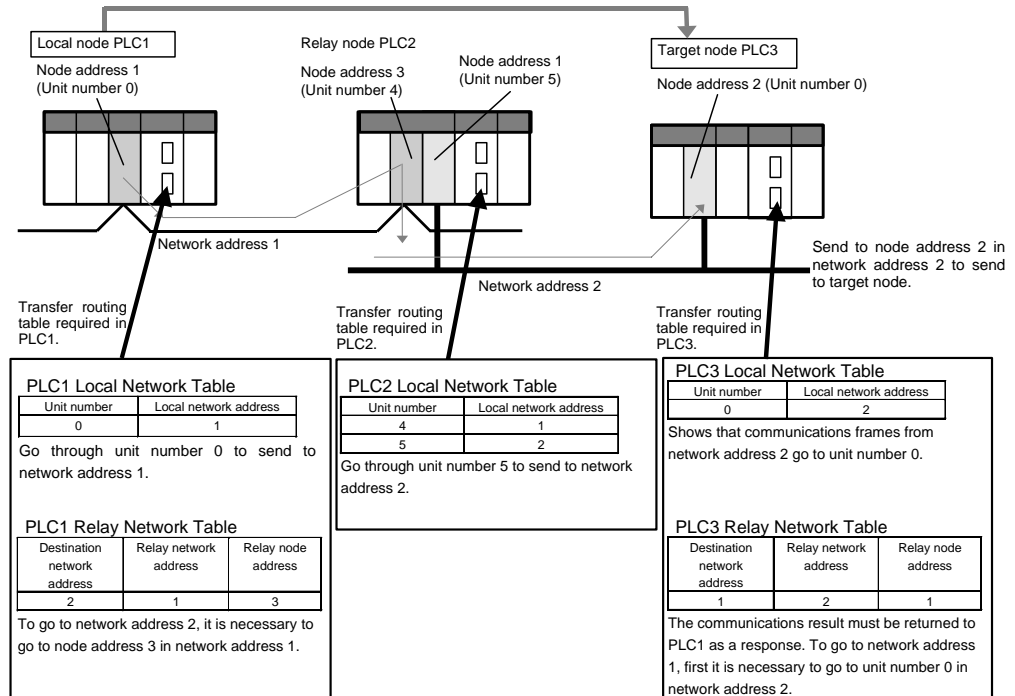

All of the following routing tables must be created and transferred for this example network.

#### PLC1

##### Local Network Table

Unit number	Local network address
0	1

##### Relay Network Table

Destination network address	Relay network address	Relay node address
2	1	3

#### PLC2

##### Local Network Table

Unit number	Local network address
4	1
5	2

#### PLC3

##### Local Network Table

Unit number	Local network address
0	2

##### Relay Network Table

Destination network address	Relay network address	Relay node address
1	2	1

### 3-2 Setting the Routing Tables

#### 3-2-2 Creating the FINS Local Routing Tables

### 3-2-2 Creating the FINS Local Routing Tables

This section shows how to set the routing tables (FINS local routing tables) for PLC1, which is connected directly to the CX-Integrator.

#### Creating the Local Network Table

Create PLC1's local network table online.

1. Select **Tools – Start Routing Table**.  
(When operating online, it is also possible to right-click the Communications Unit or Port in the Online Connection Information Window select **Start Routing Table** from the popup menu.)

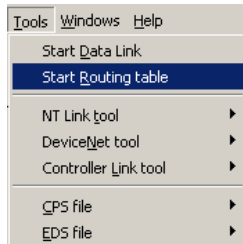

2. When operating online, the following Select Network Dialog Box will be displayed. Select **FINS Local** from the list and click the **OK** Button.

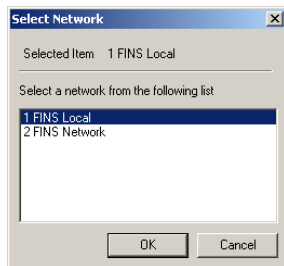

3. The PLC Routing Table Window will be displayed in the Main View format.

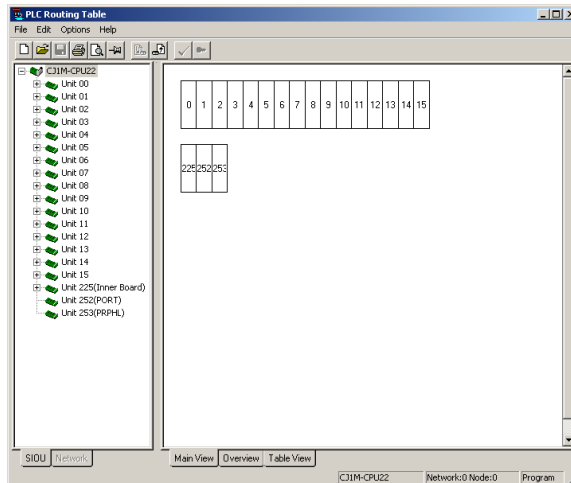

## 3-2 Setting the Routing Tables

### 3-2-2 Creating the FINS Local Routing Tables

**Note**

Node Status Indications in Online Windows:

If the PLC Routing Table Window is displayed while online, the node status of the connected PLC is reflected in the PLC Routing Table Window.

- Workspace

Main View and Table View

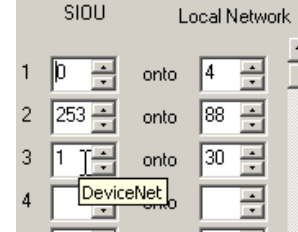
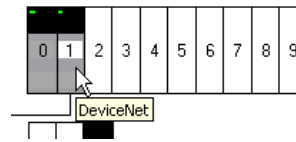
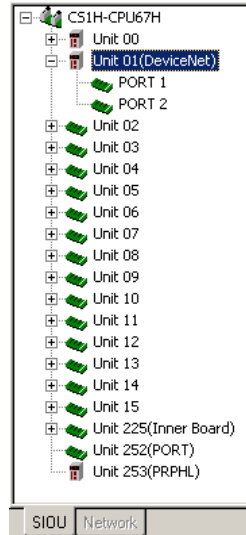

When the cursor is moved over the unit number, the Unit type will be displayed in a popup text box.

Indicates the current node address and the Communications Unit's name.

4. Click the **Table View** Tab at the bottom of the PLC Routing Table Window to switch to the Table View format.

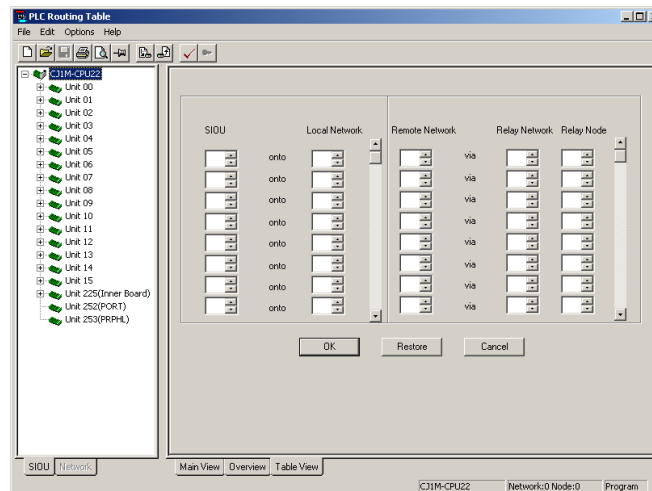

5. Input the corresponding unit number and network address and click the **OK** Button. For PLC1, input unit number 0 and local network address 1.

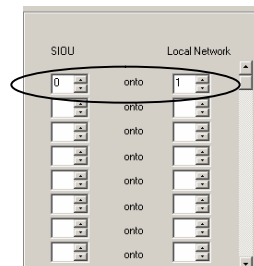

PLC1 Local Network Table

Unit number	Local network address
0	1

### 3-2 Setting the Routing Tables

#### 3-2-2 Creating the FINS Local Routing Tables

Input the appropriate settings in the local network tables for PLC2 and PLC3, as shown below.

PLC2		PLC3	
<b>Local Network Table</b>		<b>Local Network Table</b>	
<b>Unit number</b>	<b>Local network address</b>	<b>Unit number</b>	<b>Local network address</b>
4	1	0	2
5	2		

#### Menu Items in the PLC Routing Table Window

Main menu	Sub-menu/command	Functions	
File	New	Initializes (clears) the FINS local routing table.	
	Open Local Routing Table File	Opens a FINS local routing table file (.rtg, .rxg extension).	
	Save Local Routing Table File	Saves a FINS local routing table file (.rtg, .rxg extension).	
	Open Network Routing Table File	Opens a FINS network routing table file (.rt3, .rx3 extension).	
	Save Network Routing Table File	Saves a FINS network routing table file (.rt3, .rx3 extension).	
Edit	Add Remote Network	Adds a relay network table.	
	Add SIOU	Adds a local network table.	
Options	Always On Top	The PLC Routing Dialog Box will always be displayed in the front of the windows.	
	Main View	Zoom Out	Reduces the Main View display.
		Zoom In	Enlarges the Main View display.
	Transfer to PLC	Transfers the edited routing tables to the PLC that is directly connected online.	
	Transfer from PLC	Reads the edited routing tables from the PLC that is directly connected online.	
	Delete Routing Table	Deletes the routing tables in the registered PLC that is directly connected online.	
	Active Routing Table	Enables the routing tables. (See note 1.)	
	Deactive Routing Table	Disables the routing tables. (See note 1.)	
	Verify Routing Table	Compares the edited routing tables to the routing tables in the PLC that is directly connected online.	
	Check Routing Table for errors	Checks the created routing tables.	
	Automatic Network Search	(Cannot be used.)	
	Switching the target PLC (See note 2.)	Switches the target PLC to the PLC directly connected by a serial connection, or a PLC in the network connected to that PLC.	
	Number of Remote Network: Standard [20]	Sets the maximum number of destination networks to the standard value of 20.	
	Number of Remote Network: Expanded [64]	Sets the maximum number of destination networks to the extended value of 64. This command is supported only for CJ2/CJ1-R CPU Units.	
Show File Information	Inputs the author, title, and comment information to be saved in the routing table file.		
Help	Help Topics	Displays help.	
	About	Displays the Routing Table Component's version information.	

Note 1: The Enable/Disable function is supported by C-series PLCs (Controller Link) only.

Note 2: This command is supported only when connected to PLC with CS/CJ-series CPU Units with unit version 4.0 or later.



**Note** The local network table can also be set using the following procedure.

1. Click the **Main View** Tab and select **Edit – Add SIOU**.

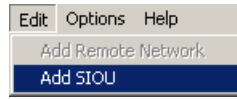

2. The Enter SIOU Details Dialog Box will be displayed. Input the CPU SIOU (unit number) and local network address.

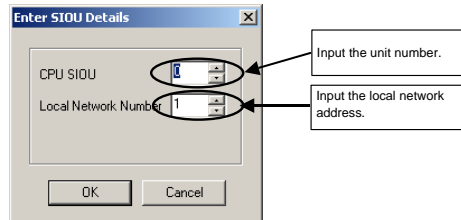

The local network table will be added to the PLC Routing Table Window (Main View).

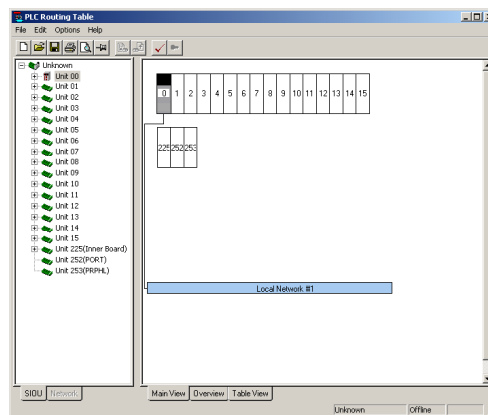

**Note** Creating the Serial Port's Local Network Table:

A local network table can be created for the serial port in the CPU Unit or a Serial Communications Board or Unit (Version 1.2 or later) so that the serial port can be specified instead of the Communication Unit's unit number. Creating the local network table allows the serial port to be managed in the network.

Example 1:

When an NS-series PT is connected to a serial port on the CPU Unit, the PT's screen data can be transferred from CX-Designer through Ethernet.

**Note:** In order to transfer screen data through the PLC, the PLC must be a CS/CJ-series PLC with a CPU lot number of 030201 (manufactured February 1, 2003) or later. In addition, the CPU Unit must be a CS1G-H, CS1H-H, CS1D-S, CJ1M, CJ1G-H, or CJ1H-H. (The screen data cannot be transferred through a CS1D-H).

Example 2:

The serial gateway to Host Link FINS can be used across networks.

1. Click the **SIOU** Tab in the PLC Routing Table Window.  
 The CPU Unit's serial port and the serial ports of Serial Communications Boards/Units (Unit version 1.2 or later) will be displayed in the directory tree.
2. The following steps show how to set the local network table for each serial port.  
 Serial Communications Board or Unit:  
 For a Serial Communications Unit, right-click the **Port 1** or **Port 2** Icon below the unit number and select **Insert PORT**. For a Serial Communications Board, right-click the **Port 1** or **Port 2** Icon below unit 225 and select **Insert PORT**.

## 3-2 Setting the Routing Tables

### 3-2-2 Creating the FINS Local Routing Tables

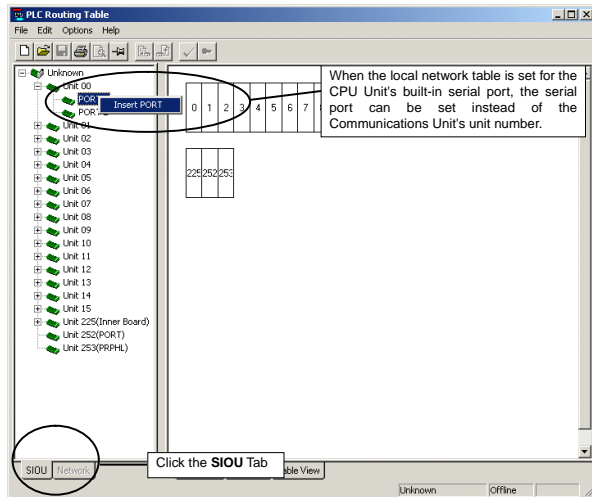

Note: For an Inner Board, the Special I/O Unit number of the Board itself is 225, but the Special I/O Unit numbers of the ports are 228 for port 1 and 229 for port 2.

CPU Unit's Built-in Serial Port:

Right-click the Unit 225 or Unit 252 icon and select **Insert CPU SIOU**.

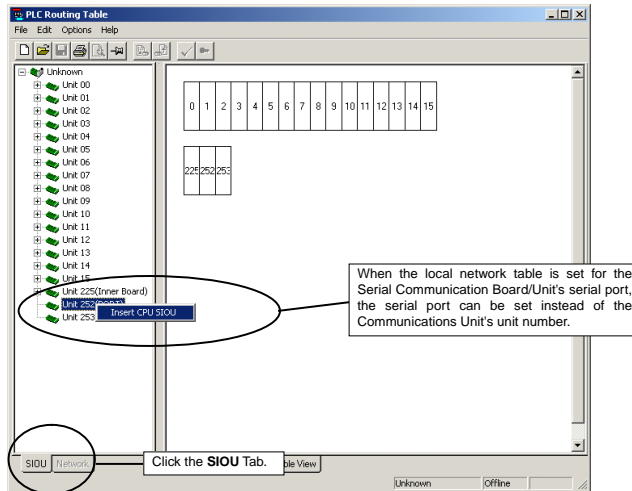

3. The Enter SIOU Details Dialog Box will be displayed.

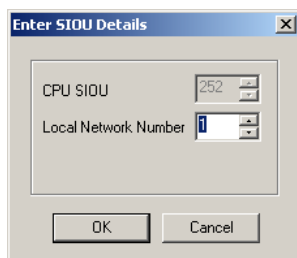

Set the serial port's local network address in the *Local Network Number* Field and click the **OK** Button.

The local network table will be registered for the serial port.

## 3-2 Setting the Routing Tables

### 3-2-2 Creating the FINS Local Routing Tables

**Note** The serial port's *CPU SIOU* value (unit number) is allocated automatically, so it cannot be changed. The following FINS unit addresses (decimal) are allocated.

Serial Communications Unit	Serial port 1	80 hex + 04 hex × unit number
	Serial port 2	81 hex + 04 hex × unit number
Serial Communications Board	Serial port 1	E4 hex (228 decimal)
	Serial port 2	E5 hex (229 decimal)
CPU Unit	Peripheral port	FD hex (253 decimal)
	RS-232C port	FC hex (252 decimal)

A Unit and the Unit's serial port cannot be registered in the local network table at the same time.

#### Setting the Relay Network Table

Set the relay network table for PLC1.

1. Click the **Table View** Tab at the bottom of the PLC Routing Table Window to switch to the Table View format.

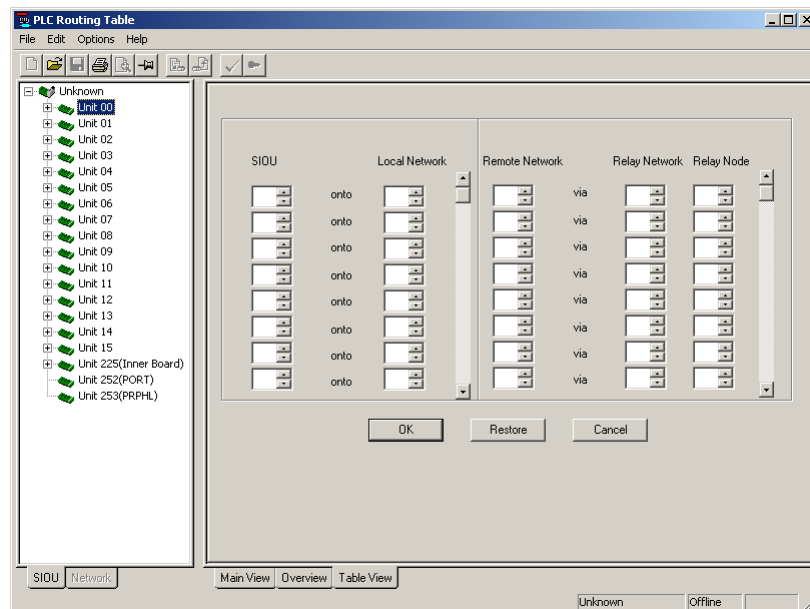

2. Input the destination (remote) network address, relay network address, and relay node address and click the **OK** Button.

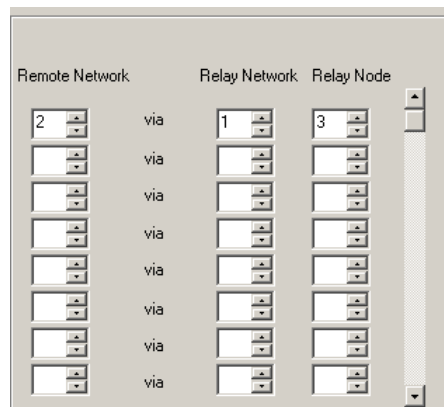

### 3-2 Setting the Routing Tables

#### 3-2-2 Creating the FINS Local Routing Tables

- When the relay network table is set in the PLC Routing Table Window, the display automatically changes to the Main View format.

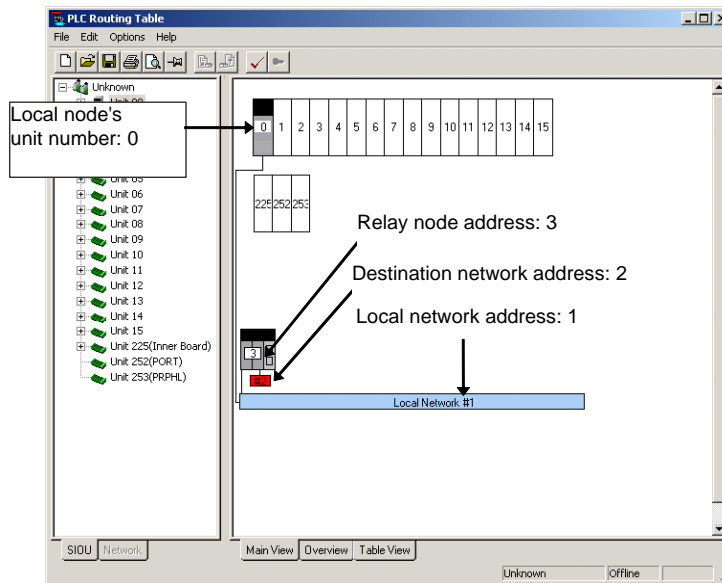

#### Increasing the Number of Registered Networks in the Relay Network Table

When using CX-Integrator Version 2.1 or higher, the capacity of the relay network table can be expanded to register up to 64 networks. To extend the relay network table, select **Options – Number of Remote Network: Extended [64]** (see note).

Relay network table registration mode	Contents	Selection method	Created files	
			FINS local routing table file	FINS network routing table file
Standard mode	Up to 20 networks (lines) can be registered in the relay network table.	Select <b>Options – Number of Remote Network: Standard [20]</b>	Filename extension: .rtg	Filename extension: .rt3
Extended mode (See note.)	Up to 64 networks (lines) can be registered in the relay network table.	Select <b>Options – Number of Remote Network: Extended [64]</b>	Filename extension: .rxg	Filename extension: .rx3

Note: The extended table format is supported only for CJ2/CJ1-R CPU Units.

#### Note

When setting the relay network table in extended mode, set the table in the Table View Tab Page.

A relay network table with more than 20 entries cannot be set in the Main View Tab Page or Overview Tab Page.

## 3-2 Setting the Routing Tables

### 3-2-2 Creating the FINS Local Routing Tables

**Note** The relay network table can also be set using the following procedure.

1. Click the **Main View** Tab and select **Edit – Add Remote Network**.

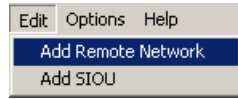

2. The Enter SIOU Details Dialog Box will be displayed.  
Input the CPU SIOU (unit number) and local network address.

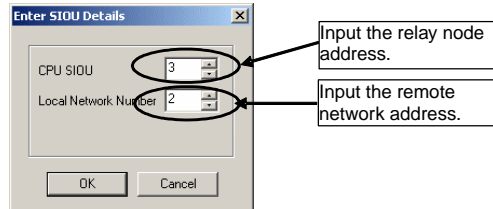

The relay network table will be added to the PLC Routing Table (Main View).

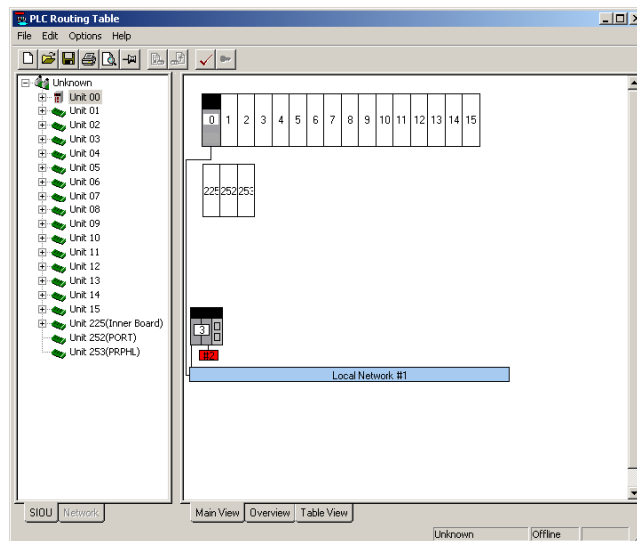

## 3-2 Setting the Routing Tables

### 3-2-3 Setting the Gateway Counter

#### 3-2-3 Setting the Gateway Counter

Use the following procedure to set the gateway counter in the PLC.

To set the gateway counter, the routing tables must be displayed in the PLC Routing Table Window. The gateway counter can be set offline or online.

#### Function of the Gateway Counter

In a FINS network, a GCT value (gateway counter: number of allowed bridge passes) is set in each FINS command frame's FINS header when a FINS command is sent or a FINS response is returned. When a FINS response is received, this GCT is automatically decremented by the number of times that the message passed across network layers. The following examples illustrate the function of the GCT value.

When GCT = 02 hex, up to 3 network layers can be crossed.

When GCT = 07 hex, up to 8 network layers can be crossed. (The network must be configured for PLC models with the GCT set to 07 hex.)

#### Setting the Gateway Counter

##### Setting the Gateway Counter Value for each PLC Model

The allowed settings for the GCT value depend upon the PLC model.

##### CS/CJ-series Units Version 3.0 and Later

The GCT value can be set to 02 hex or 07 hex.

Set the GCT value in the Gateway Counter Setting Dialog Box when creating the routing tables.

Setting the Gateway Counter in a FINS Local Routing Table:

1. Click the **SIUO** Tab at the bottom of the PLC Routing Table Window and right-click the local PLC's icon.

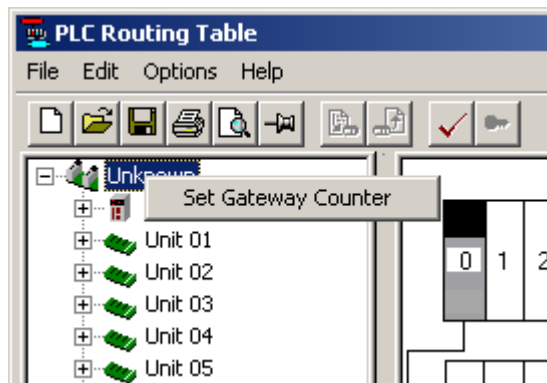

## 3-2 Setting the Routing Tables

### 3-2-3 Setting the Gateway Counter

Setting the Gateway Counter in a FINS Network Routing Table:

1. Click the **Network** Tab at the bottom of the PLC Routing Table Window, right-click the icon of a PLC in the network, and select **Set Gateway Counter**.

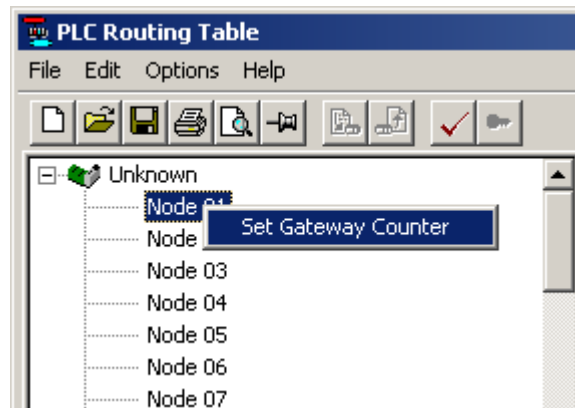

2. The Gateway Counter Setting Dialog Box will be displayed. Select *Standard* or *Expand* and click the **OK** Button.



Standard: Up to 3 level crossings (GCT = 02 hex)

Expand: Allows 4 to 8 level crossings (GCT = 07 hex)

The gateway counter value is displayed in the Main View, Overview, and Table View windows.

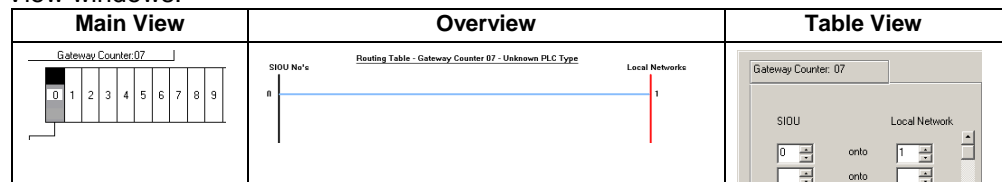

#### CS/CJ-series Units Version 2.0

The GCT (gateway counter) is fixed at 07 Hex. The GCT cannot be set for a maximum of 3 network layer crossings. The maximum number of network crossings is always 8 layers max.

When CX-Programmer version 5.0 or a later version is being used, the *Standard/Expand* setting in the Gateway Counter Setting Dialog Box is ignored. When the routing tables are transferred to a Version 2.0 CS/CJ-series Unit, the GCT value is always set to 07 Hex and operates in Expand Mode.

#### Pre-Version 2.0 CS/CJ-series Units

The GCT (gateway counter) is fixed at 02 Hex. In this case, the maximum number of network crossings is always 3 layers max.

When CX-Programmer version 5.0 or a later version is being used, the setting in the Gateway Counter Setting Dialog Box is ignored and the *Standard* setting is always selected. If the *Expand* setting has been set, the routing tables cannot be transferred.

## 3-2 Setting the Routing Tables

### 3-2-3 Setting the Gateway Counter

**Note** More than 3 network layer crossings (8 max.) are allowed with CS/CJ-series Units with Version 2.0 or later ratings. However, up to 8 network layer crossings are allowed only when the destination of the FINS command is a CPU Unit. If the destination of the FINS command is not a CPU Unit, the maximum number of network layer crossings is 3.

**Note** When the maximum number of network layer crossings is set to 3, it is possible to combine Version 2.0 or later CS/CJ-series Units with other models. If the maximum number of network layer crossings is set between 4 and 8, only Version 2.0 or later CS/CJ-series Units can be used in the network. (Models other than Version 2.0 and later CS/CJ-series Units cannot be included.) If other models are used, a routing error (end code 0501 to 0504 Hex) may occur in a relay PLC or the response may not be returned properly to the source node.

**Note** The connection between the computer and relay node can be checked with the *Check connection to Relay Node* command.

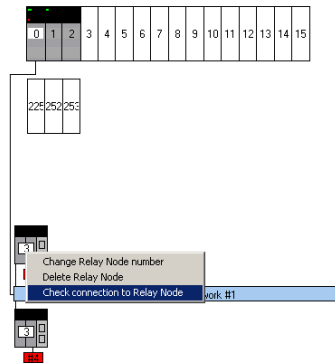

The checking procedure is as follows:

1. Display the PLC Routing Table Window in Main View format and move the cursor over the relay node's icon, as shown above.
2. Right-click over the icon and select *Check connection to Relay Node* from the pop-up menu.
3. The check results will be displayed in a Routing Table Dialog Box, like the one below.

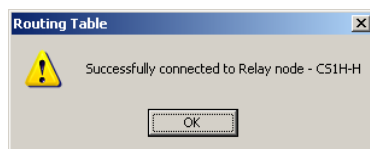

If you click the **Overview** Tab, the following display will appear.

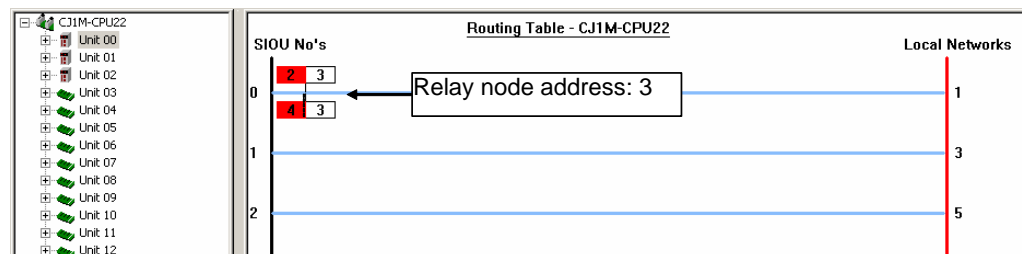

This example completes the procedure for creating a directly connected PLC's routing tables.



## 3-2 Setting the Routing Tables

### 3-2-4 Checking Routing Tables for Errors

#### Crossing Network Layers with Version 2.0 and Later CS/CJ-series Units

With Version 2.0 and later CS/CJ-series Units, FINS commands can cross over up to 8 network layers (see note), including the local network.

##### Applicable Networks:

Not all networks can be crossed up to 8 times. Only the following two kinds of networks can be crossed up to 8 times. (The networks can be crossed in any combination.)

Controller Link

Ethernet

Note: Operation through DeviceNet networks may not be dependable.

##### Configuration of Compatible Models:

Both the node sending the FINS command and the target node must be Version 2.0 or later CS/CJ-series Units. Intermediate nodes may be PLC models other than Version 2.0 or later CS/CJ-series Units, i.e., PLC models that support a maximum of 3 network layer crossings.

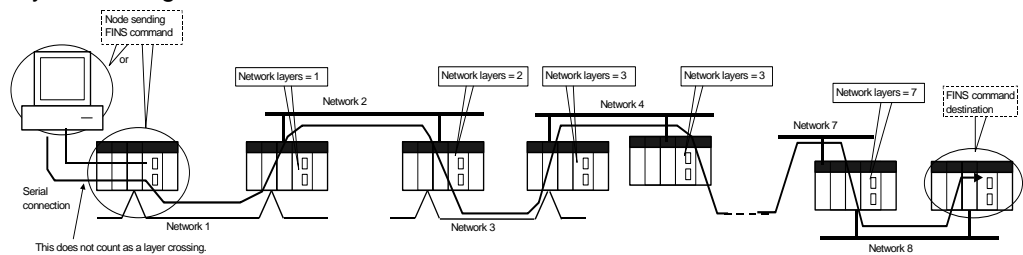

## 3-2-4 Checking Routing Tables for Errors

The error check function checks whether the created local network table and relay network table have been set correctly.

1. Select **Options – Check Routing Table for errors** in the PLC Routing Table Window.

The results of the error check will be displayed.

Normal Result:



Results when Errors Were Detected:

For details on error messages displayed in the routing table Error List Check Dialog Box.

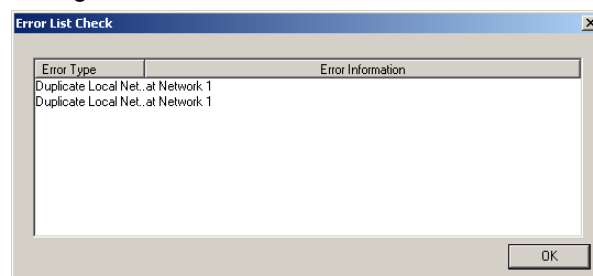

## 3-2 Setting the Routing Tables

### 3-2-5 Transferring Routing Tables to a Directly Connected PLC

#### 3-2-5 Transferring Routing Tables to a Directly Connected PLC

The computers are connected to PLC1, PLC2, and PLC3 by direct serial connections, and the routing tables are transferred to the PLCs.

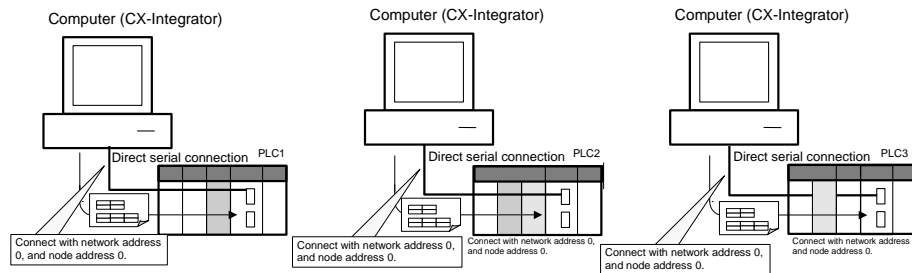

1. Verify that PLC1 is connected directly to the CX-Integrator and online, display the PLC Routing Table Window, and select **Options – Transfer to PLC**.
2. The following dialog box will be displayed to confirm the transfer. To proceed with the transfer to the PLC, click the **Yes** Button.

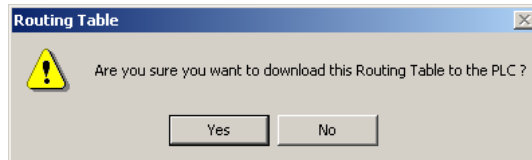

3. The routing tables (local network table and relay network table) will be transferred from the computer (CX-Integrator) to PLC1. The following dialog box will be displayed after the transfer is completed.

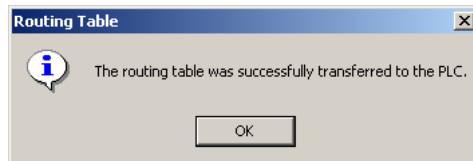

This step completes the transfer of the routing tables to PLC1. Use the procedure outlined above to transfer the routing tables to PLC2 and PLC3.

Note: The following message will be displayed if a CS/CJ-series Unit with no version number is being used and the gateway counter was set to *Expand* in the Gateway Counter Setting Dialog Box.

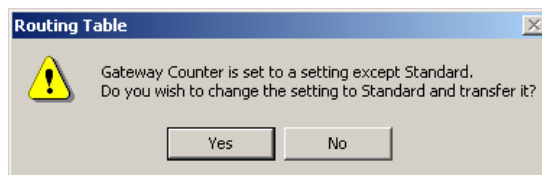

Click the **Yes** Button to change the gateway counter setting to *Standard* and transfer the routing tables.

Click the **No** Button to cancel the routing table transfer.

4. After the routing tables have been transferred, update the Online Connection Information Window by either selecting **Update of Online Information Window** from the View Menu in the Online Connection Information Window or pressing the **F5** Key.

**! Caution** When changing or removing a routing table (see note), be sure to update the display for the Online Connection Information Window. The display for the Online Connection Information Window could possibly be different from the actual network status. If operations are executed without first updating the display, particularly online operations in the Network Configuration Window, it could cause data to be mistakenly read or written for the wrong network or node address or unit number.

**Note:** Changing or removing a routing table refers to using the

## **3-2 Setting the Routing Tables**

### **3-2-5 Transferring Routing Tables to a Directly Connected PLC**

CX-Integrator (or a CX-Integrator for another personal computer) to start the Routing Table Component and then changing or removing a routing table for the target PLC (either a local network table or a relay network table).

**Note** If routing tables are transferred to the PLC from a Programming Device, the CPU Bus Unit will be reset. The Unit is reset in order to read and enable the routing tables that were transferred. Before executing the routing table transfer, verify that no equipment will be damaged and it is safe for the CPU Bus Unit to be reset.

**Note** The routing tables cannot be transferred to another network layer. When transferring to a different network layer, directly connect the CX-Integrator to a PLC in that network and transfer the routing tables.

## 3-2 Setting the Routing Tables

### 3-2-6 Saving Routing Tables

#### 3-2-6 Saving Routing Tables

Use the following procedure to save the created FINS local routing tables. The FINS local routing tables are saved in a file with the ".rtg" filename extension or the ".rxg" filename extension (see note).

1. Select **File – Save Local Routing Table File** in the PLC Routing Table Window. The Save As Dialog Box will be displayed.
2. Input the desired filename ("Sample" is input in this example), specify the directory where the file will be saved, and click the **Save** Button. The file will be saved with either the ".rtg" or ".rxg" filename extension attached. (The file is "Sample.rtg" in this example.)

Note: The file's filename extension depends on the relay network's registration mode.

- Standard mode: \*.rtg
- Extended mode: \*rxg

#### 3-2-7 Reading Routing Tables

Use the following procedure to read FINS local routing tables that were previously saved.

1. Select **File – Open Local Routing Table File** in the PLC Routing Table Window. The Open Dialog Box will be displayed.
2. Select a FINS local routing table file to read (with a ".rtg" or ".rxg" filename extension, see note) and click the **Open** Button. The FINS local routing tables will be read. Once the file is read, the PLC can be connected online and the file can be transferred to the PLC.

Note: The ".rxg" files are supported by CX-Integrator Version 2.1 or higher.

#### 3-2-8 Verifying Routing Tables

Use the following procedure to compare routing tables created in the CX-Integrator to the routing tables in the PLC.

1. Select **Options – Verify Routing Table** in the PLC Routing Table Window. The results of the verification will be displayed.

Normal Result



Error Detected



Click the **OK** Button to display detailed verification results.

Local Network Table Results

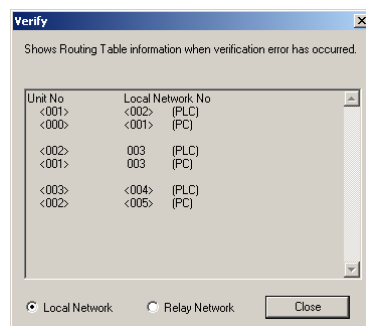

Relay Network Table Results

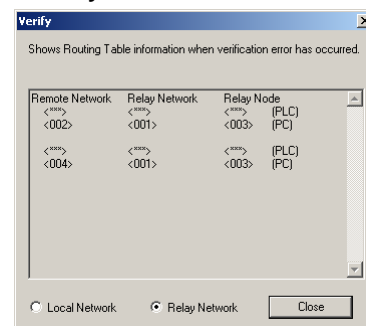

3-2-9 Printing Routing Tables

Use the following procedure to print the created routing tables.

1. Select **File – Print** in the PLC Routing Table Window.  
 Example Printout (PLC1 Table View)

Routing Table - CJ1M-CPU22

SIOU	Local
0	1
1	3
2	5

Remote	R
2	
4	

Example Printout (PLC1 Main View)

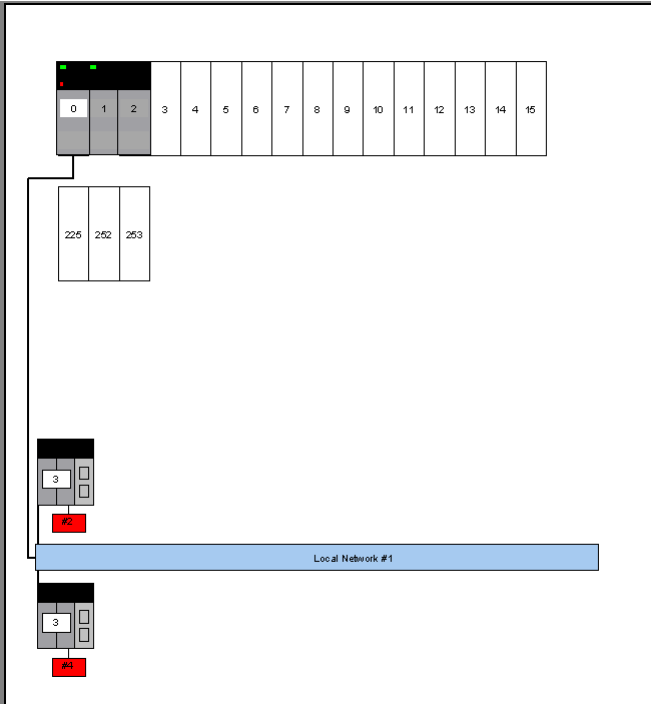

## 3-2 Setting the Routing Tables

### 3-2-10 Transferring Routing Tables to a Network PLC through a Direct Serial Connection

#### 3-2-10 Transferring Routing Tables to a Network PLC through a Direct Serial Connection

Use the following procedure to transfer the FINS local routing tables to a PLC in the network (see note 2) through the PLC that is connected by a direct serial connection with network address 0 and node address 0.

Note 1: The following conditions are required to use this function.

- Use CX-Integrator Version 2.1 or higher.
- The PLC must have a CS/CJ-series CPU Unit with unit version 4.0 or later.

Note 2: The FINS local routing tables can be transferred only to a PLC in the same network as the PLC connected directly by a direct serial connection. The transfer cannot cross a network level to another network.

The following example shows how to transfer the routing tables to PLC2, PLC3, PLC4, and PLC5, which are in the same network as directly connected PLC1, as shown in the network configuration diagram.

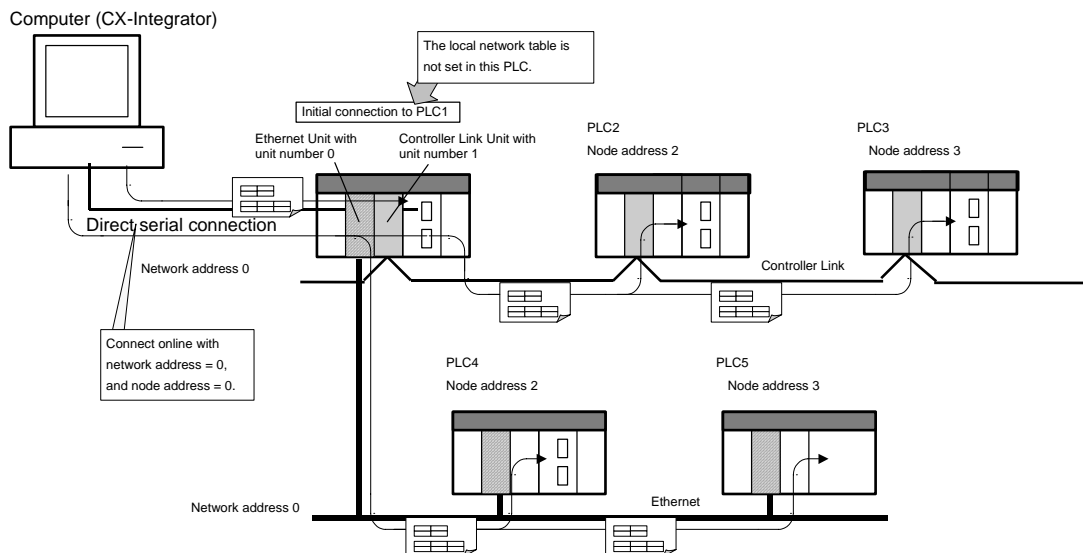

**Note** The data transfer procedure described in this section is applicable to the FINS local routing tables only.

#### Transfer Procedure

1. Confirm that PLC1 is connected directly to the CX-Integrator by a serial connection (with network address = 0, and node address = 0), and online.)
2. Select **Tools – Start Routing Table**.  
It is also possible to right-click the Communications Unit or Port in the Online Connection Information Window select **Start Routing Table** from the popup menu.

## 3-2 Setting the Routing Tables

### 3-2-10 Transferring Routing Tables to a Network PLC through a Direct Serial Connection

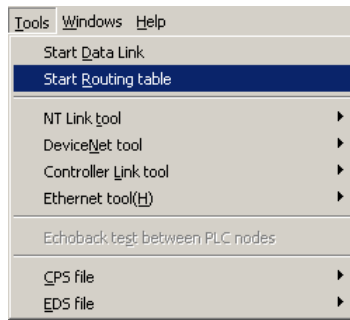

3. The PLC Routing Table Window will be displayed in the Main View format.

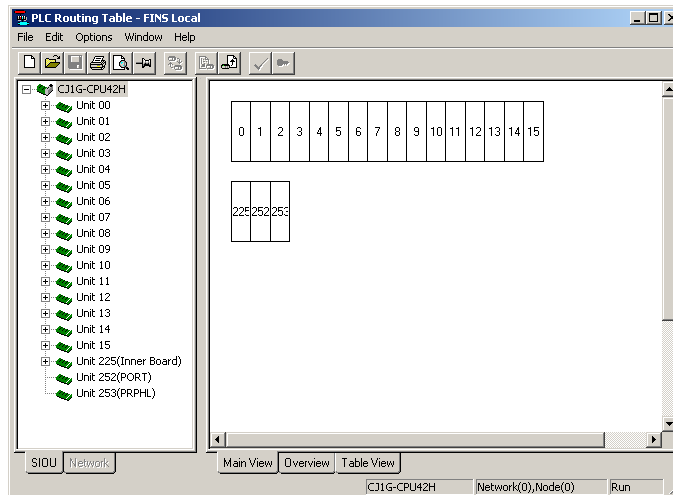

4. Select **File – Open Local Routing Table File** to read the saved FINS local routing table file.

5. Select **Options – Switching the target PLC**, or click the  icon in the toolbar.

6. The Switching the target PLC Dialog Box will be displayed.

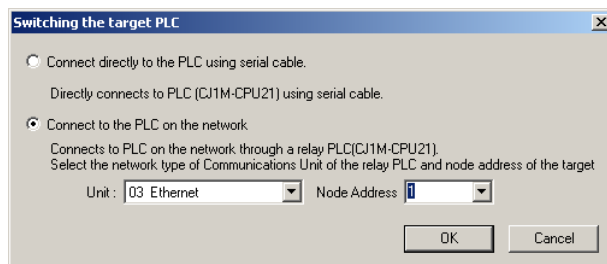

Set the following items, and switch the target PLC.

Select either of the following options.

**Connect directly to the PLC using serial cable.**

Select this option when switching to the PLC that is directly connected by a serial connection. In this case, the *Unit* and *Node Address* Fields in the lower half of the dialog box are disabled.

**Connect to the PLC on the network**

Select this option when switching to another PLC in the same network as the directly connected PLC.

- **Unit**

Select the Communications Unit that connects to the network containing the PLC that is the destination of the routing table transfer.

- **Node Address**

Select the node address to which the routing parameters are transferred. Set the node address based on the type of network, as follows.

### 3-2 Setting the Routing Tables

#### 3-2-10 Transferring Routing Tables to a Network PLC through a Direct Serial Connection

- Controller Link or SYSMAC Link data link network:  
The nodes connected to the network are listed in the pull-down list in the *Node Field*. Select the destination node address from the pull-down list.
- Ethernet or DeviceNet network  
Specify the destination node's node address directly in the *Node Address Field*.  
If a node address is specified and that node is connected even once, the node will be added to the pull-down list in the *Node Field* the next time the dialog box is opened.

#### Setting Example:

In this example, the tables are transferred to node address 2 in the Controller Link network connected to the Controller Link Unit with unit number 1.

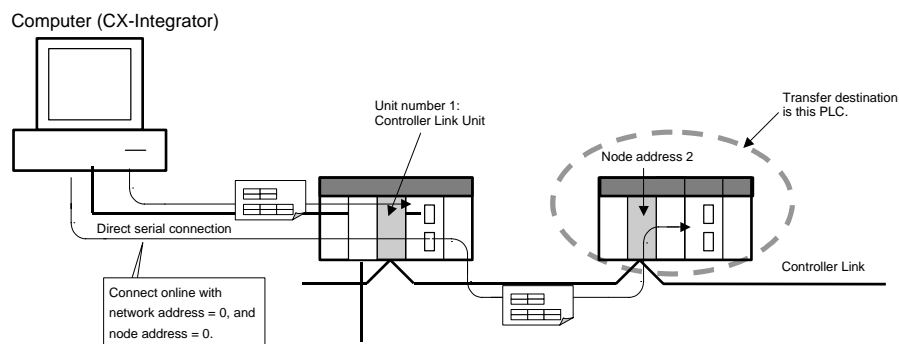

Make the settings in the Switching the target PLC Dialog Box, as shown in the following diagram.

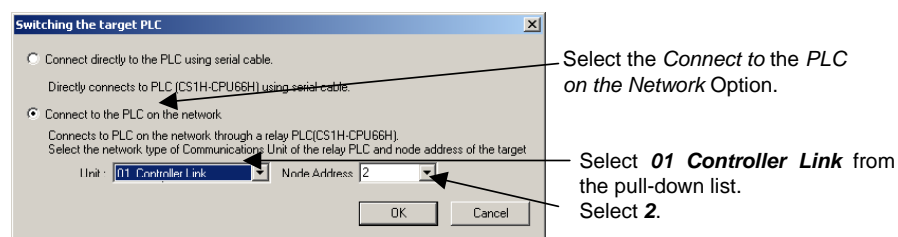

7. Select **Options – Transfer to PLC**.

8. The following dialog box will be displayed to confirm the transfer. Verify that it is all right to proceed with the transfer to the PLC, click the **Yes** Button.

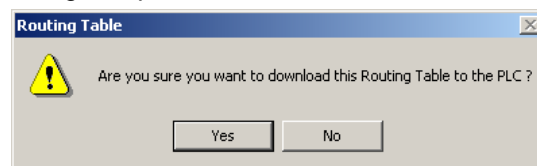

#### Note

If routing tables were previously set in the target PLC, those tables will be overwritten with the routing table that is being edited. Verify that the routing tables are being written to the correct PLC.

9. The routing tables (local network table and relay network table) will be transferred from the CX-Integrator to PLC2.

The following dialog box will be displayed after the transfer is completed.

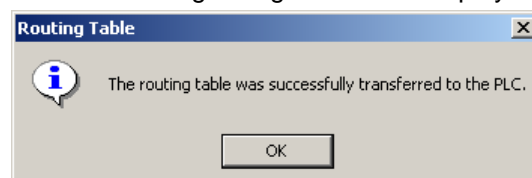



3-2-10 Transferring Routing Tables to a Network PLC through a Direct Serial Connection

10. Step 9 completes the transfer of the routing tables to PLC2.

Repeat steps 4 through 9, and perform the same procedure to transfer the routing tables to PLC3, PLC4, and PLC5.

**Verifying the Connected PLC**

The output area in the lower-right corner of the PLC Routing Table Window displays information about the currently connected PLC.

The output window is displayed if the PLC is connected online.

Also, the output window can be displayed by selecting **Window – Output** in the PLC Routing Table Window.

**Display Example (When the Target PLC is Changed)**

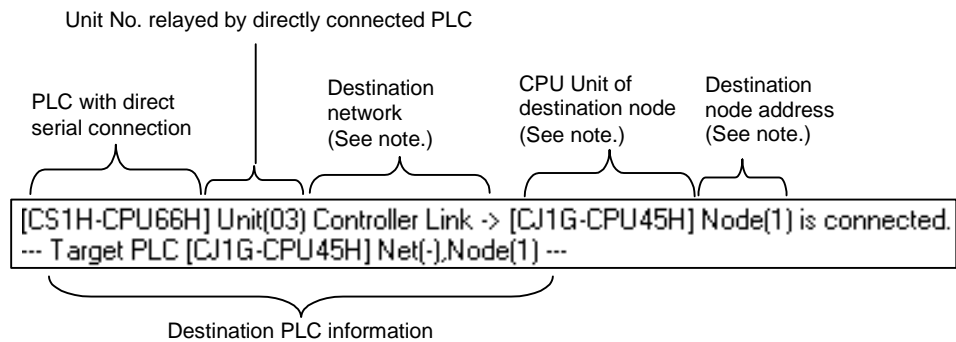

Note: These values are not displayed when the PLC is connected through a direct serial connection.

**Note**

The routing tables cannot be transferred to a PLC in another network layer. When transferring to a PLC in a different network layer, directly connect the CX-Integrator to a PLC in that network and transfer the routing tables.

## 3-3 Maintenance after Network Configuration

### 3-3-1 FINS Network Routing Tables

## 3-3 Maintenance after Network Configuration

### 3-3-1 FINS Network Routing Tables

When the routing tables have been set and transferred to the nodes (CPU Units of the PLCs) in the network, it is possible to connect online to the PLCs through the network from the CX-Integrator and read the network configuration.

This capability allows the FINS local routing table set in each PLC to be read and edited through the network.

In addition, the FINS local network tables set in each PLC can be saved together in a FINS network routing table file.

These operations are performed in the FINS Network Routing Table Window.

### 3-3-2 Editing the FINS Local Network Tables

The following procedure explains how to read the FINS local routing tables set in each PLC. The computer must be directly connected to PLC1 and online.

1. Verify that the PLC is connected directly to the computer (CX-Integrator) and select **Tools – Start Routing Table** from the PLC Routing Table Window's menu.
2. The PLC Routing Table Window will be displayed.

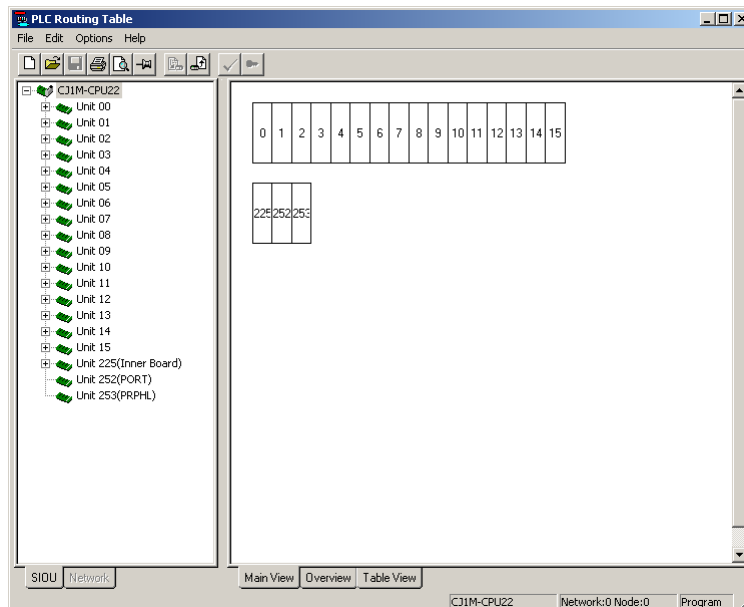

### 3-3 Maintenance after Network Configuration

#### 3-3-2 Editing the FINS Local Network Tables

**Note** When the PLC is connected online, the display will show green and red indicators on the Units that indicate errors with Units registered in the routing tables.

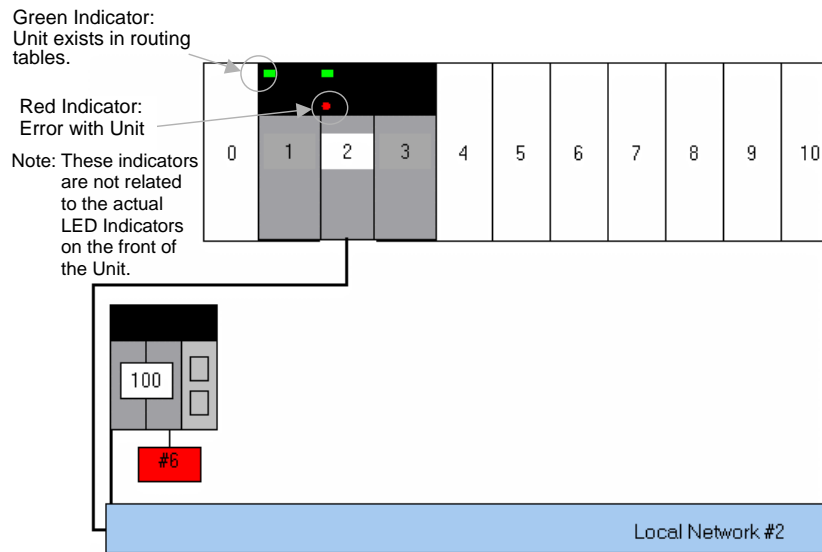

The following table shows the meaning of the display's indicators.

Green indicator	The Unit with the unit number set in the routing tables is actually mounted in the PLC Backplane.
Red indicator	One of the following errors was detected in the Unit with the unit number set in the routing table. <ol style="list-style-type: none"> <li>1. The Unit's node address is duplicated.</li> <li>2. The Unit's node address is out-of-range.</li> <li>3. There is an error in the routing table settings.</li> </ol>

### 3-3 Maintenance after Network Configuration

#### 3-3-2 Editing the FINS Local Network Tables

#### Reading Routing Tables through the Network

1. Click the **Network** Tab in the workspace on the left side of the Window.
2. When each node (in the same network) is specified, the node's icon will indicate the present connection status between the CX-Integrator and that PLC, as shown in the following diagram.

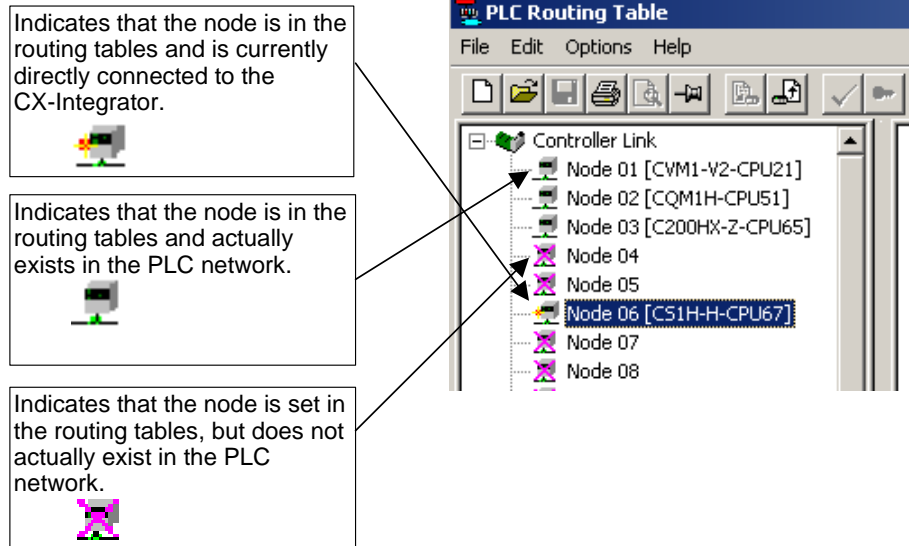

3. Select **Options – Transfer from PLC**.

The routing tables will be read through the network from each PLC and displayed.

#### **Note**

Before executing **Option** Menu operations such as transferring, deleting, or verifying a node's routing tables, check the node's connection status by clicking the **Network** Tab and checking the node's icon in the project workspace. When the CX-Integrator is connected to a PLC on an Ethernet network, it may not be possible to read the routing tables from nodes other than the connected PLC. In this case, directly connect the CX-Integrator to the PLC to read and edit the local routing table.

#### Editing Routing Tables that Were Read

1. Click the **Table View** Tab and edit the local network table and relay network table.

#### Transferring Edited Routing Tables

1. Specify each node (in the same network) and select **Options – Transfer to PLC**. The routing tables will be transferred to each PLC through the network.

#### Saving the FINS Network Routing Table File

1. Select **File – Save Network Routing Table File** in the PLC Routing Table Window.
2. Input the filename, specify the directory where the file will be saved, and click the **Save** Button.

**Note** When transferring the routing tables to a PLC, all CPU Bus Units in that node will be reset except for SYSMAC BUS/2 Masters. Verify that there will be no adverse effects on the system's equipment before transferring the routing tables.

**3-3 Maintenance after Network Configuration**  
**3-3-2 Editing the FINS Local Network Tables**

# **Communications**

## **Section 4 Data Links**

### **for Controller Link and SYSMAC LINK**

This section describes how to set data links for Controller Link and SYSMAC LINK networks.

4-1 Overview  
4-1-1 What Are Data Links?

## 4-1 Overview

### 4-1-1 What Are Data Links?

Data links automatically exchange data in preset areas between nodes (PLCs and/or computers) on a network. Settings can be made either manually or automatically. CX-Integrator operations can be used for all operations from setting up the PLC network to controlling data exchange.

#### Manual Settings

Manual settings enable more flexible allocations, including the send size for each node, the sequence of nodes for sending and receiving, and the setting of nodes for sending only or receiving only. Use manual settings to create flexible data links to meet the requirements of the individual system (e.g., efficient utilization of memory, restrictions on allocated addresses, etc.).

Data link tables (i.e., tables that define data link area allocations) are generated by CX-Integrator or network support software (such as Controller Link Support Software), and sent to all nodes for use.

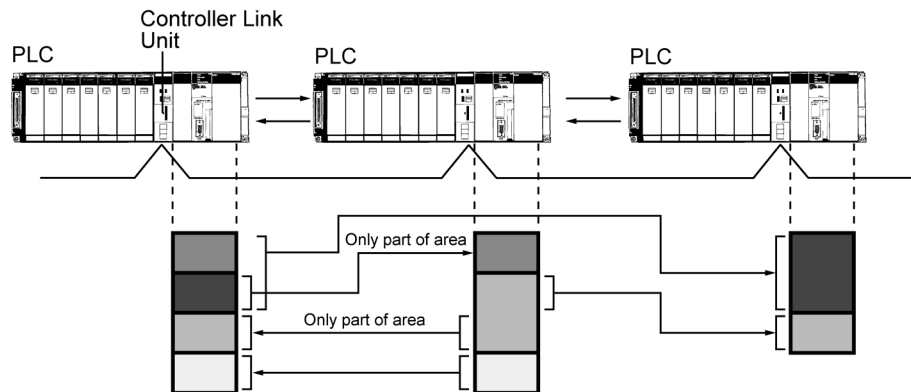

#### Automatic Settings

Automatic settings can be used for simple data exchanges involving fixed allocations, when all nodes are set for the same send size and the same data is to be shared among all nodes in order of node address.

Using a Programming Device (such as the CX-Programmer or a Programming Console), set the data exchange method in the DM parameter area of the startup node.

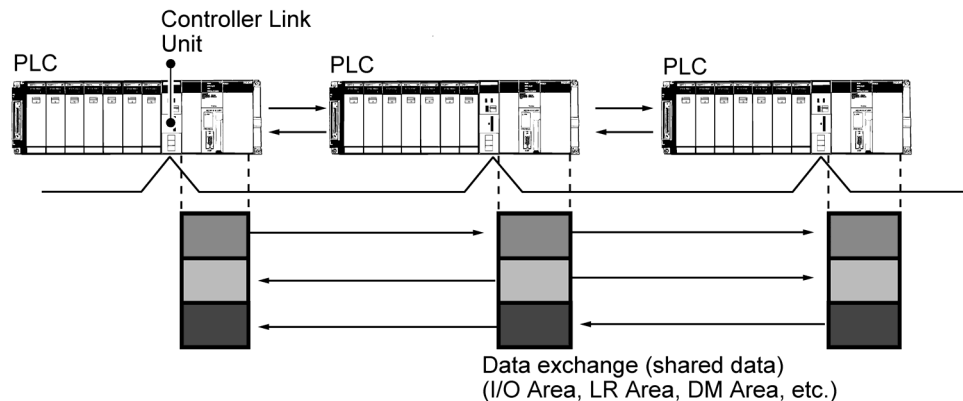



## 4-1-2 Overview of Procedure by Data Link Setting Method

### Step 1: Selecting the Data Link Setting Method

Either of the following methods can be used.

- 1) Select either user-set data links or automatically set data links after selecting **Online - Automatic Data Link Setup** from the Data Link Component.
- 2) Directly set the software switches in the allocated DM Area words.

Note: The settings in the DM Area can also be made from the Special I/O Unit settings in the I/O Table Window for CX-Programmer Ver.6.0 or higher.

1. Right-click the Controller Link Unit or SYSMAC LINK Unit in the I/O Table Window, select **Unit Setup** from the popup menu, and then select *Data Link mode* from the Edit Parameters Dialog Box.

Controller Link Unit: Select *Manual setting*, *Automatic setting (equality layout)*, or *Automatic setting (1:N allocation)*

SYSMAC LINK Unit: *Manual setting*, *Automatic setting (CIO Area only)*, *Automatic setting (DM Area only)*, or *Automatic setting (CIO + DM Areas)*.

2. Place the CX-Programmer online and transfer the parameters to the PLCs. (The **Compare** Button can be clicked to set the parameters which verifying against the setting data in the actual PLCs.

### Step 2: Data Link Allocation Area Settings

Manual: Select **Table - Wizard** from the Data Link Component online or select **File - New**, create the data link tables, and then go online and transfer the tables to all nodes in the network.

Automatic: Use one of the following methods.

- 1) Select **Online - Automatic Data Link Setup** from the Data Link Component and set the parameters for automatically setting data links.
- 2) Directly set the parameter area for automatically allocating data links in the allocated DM Area words.

Note: The Special I/O Unit settings in the I/O Table Window can also be used to set parameters for automatically allocating data links and then these parameters can be transferred to the startup node.

### Step 3: Starting the Data Links

Automatic or manual: Use one of the following methods.

- 1) Select **Online - Data Link Operation/Status** from the Data Link Component, select the *RUN* Option under *Operation* and then click the **Set** Button.
- 2) Turn ON the Data Link Start Bit in the DM Area words allocated to the start node and then cycle the power to the PLC. (Alternately, leave the power to the PLC ON and turn the Data Link Start Bit OFF and then back ON.)

Note: The Special I/O Unit settings in the I/O Table Window can also be used to set parameters for automatically allocating data links, the Data Link Start Bit can be set to be turned ON and then these parameters can be transferred to the startup node.

## 4-2 User Interface Overview

### 4-2-1 Starting the Data Link Component

The Data Link Component can be set with either of the following methods.

Method 1: While online, right-click the Controller Link Unit or SYSMAC LINK Unit in the Online Connection Information Window and select **Start Data Link** from the popup menu. Alternately, select **Tools - Start Data Link** from the menu bar and then select **Controller Link** or **SYSMAC LINK**. **Start Data Link** cannot be selected if there is not a Controller Link Unit or SYSMAC LINK Unit mounted in the PLC that is connected online.

Method 2: While offline, select **Tools - Start Data Link** from the menu bar and then select **Controller Link** or **SYSMAC LINK**.

### 4-2-2 Datalink Component

The following illustration shows the window used when constructing Controller Link or SYSMAC LINK data links manually.

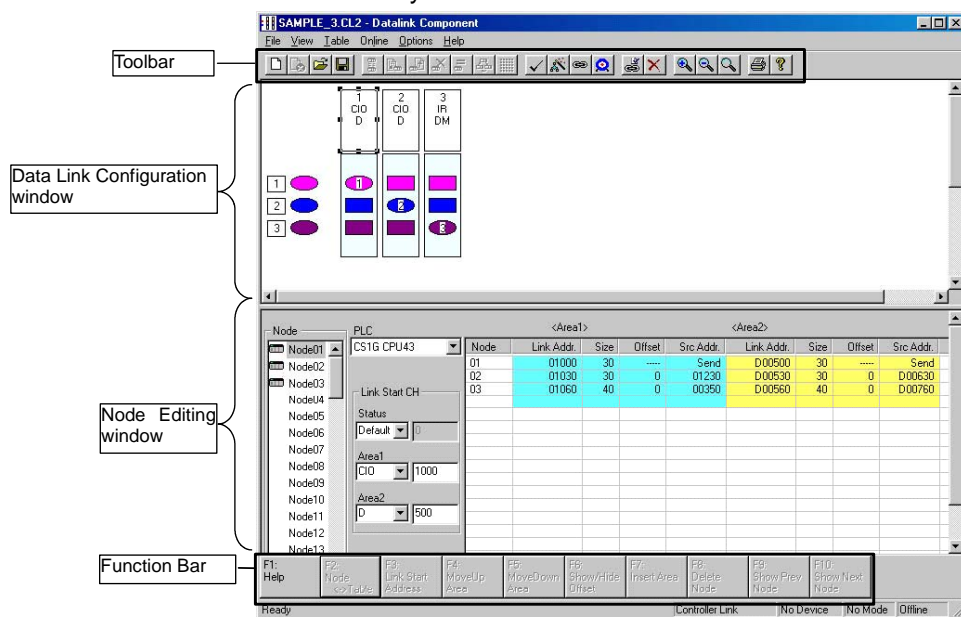

### Data Link Component Menu

Menu	Sub-menus /Commands	Function	
File	New	Creates new data link tables.	
	Open		Opens data link tables, Files with any of the file name extensions shown below can be opened. When a file is opened, the proper editor starts up.
		Controller Link	.cl2 – Controller Link/CLKSS data link tables .cl3 – Controller Link data link tables .clk – CLKSS data link tables .csv – Controller Link data link tables (tab-delimited text file)
		SYSMAC LINK	.sl3 – SYSMAC LINK data link tables .slk – SYSMAC LINK data link tables for SYSMAC Support Software .csv – SYSMAC LINK data link tables (tab-delimited text file)
	Save	Saves the data link tables that are being edited.	
	Save As		Saves data link tables, Files with any of the file name extensions shown below can be saved.
		Controller Link	.cl2 – Controller Link/CLKSS data link tables .cl3 – Controller Link data link tables .clk – CLKSS data link tables .csv – Controller Link data link tables (tab-delimited text file)
SYSMAC LINK		.sl3 – SYSMAC LINK data link tables .slk – SYSMAC LINK data link tables (tab-delimited text file) .csv – SYSMAC LINK data link tables (tab-delimited text file)	
File	Print	Prints data link information.	

## 4-2 User Interface Overview

### 4-2-2 Datalink Component

Menu	Sub-menus /Commands	Function
	Print Preview	Previews the data to be printed.
	Exit	Exits the Datalink Component Window.
View	Move Right	Moves the cursor to the right in the Data Link Configuration Window.
	Move Left	Moves the cursor to the left in the Data Link Configuration Window.
	Move Up	Moves the cursor up in the Data Link Configuration Window.
	Move Down	Moves the cursor down in the Data Link Configuration Window.
	Change Window	Changes the active window.
	Zoom Out	Zooms out from within the Data Link Configuration Window.
	Zoom In	Zooms in within the Data Link Configuration Window.
	Zoom Original	Returns the Data Link Configuration Window to its initial scale.
	Show in List	Shows the Data Link Area settings in list format.
	Show in Table	Shows the Data Link Area settings in table format.
	Show Func Bar	Shows function key guides at the bottom of the Datalink Component Window. (Enabled for table format only.)
Show Offset	Shows the specified offset value on the Node Editing Window.	
Table	Wizard	Executes the Datalink Wizard.
	Add Source Link	Adds a node to the data links.
	Add Destination	Adds the receive area of a participating node to the data links.
	Delete	Deletes nodes.
	Validate Table	Checks data link tables.
	Table Information	Edits data link table information.
	Show Node List	Displays a list of nodes.
	Redraw	Resets colored displays.
Online	Transfer from PLC	Uploads online data link tables to the computer.
	Transfer to PLC	Downloads online data link tables from the computer to a PLC.
	Verify Node	Compares data link tables generated by CX-Integrator with data link tables stored in the PLC. If they do not match, an error dialog box is displayed.
	Data Link Operation/Status	Displays the operation and data link status of manually set data links.
	Automatic Data Link Setup	Sets parameters for automatically set data links, and transfers them to the startup node.
	Set All Nodes for Network Operation	Executes transfer, verify, and delete operations for all nodes.
	Show All Network Nodes	Reads data link tables from all nodes.
	Delete	Deletes data link tables.
Options	Cycle Time	Sets the communications cycle time (for SYSMAC LINK data link tables only).
Help		Displays help.

## 4-2 User Interface Overview

### 4-2-2 Datalink Component

#### Toolbar

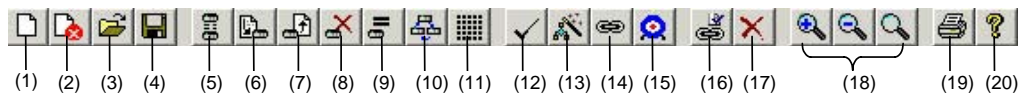

No.	Icon	Function
(1)	New	Creates new data link tables.
(2)	Show All Network Nodes	Shows all nodes in the network.
(3)	Open	Opens a data link tables, Files with any of the file name extensions shown below can be opened. When a file is opened, the proper editor starts up.
	Controller Link	.cl2 – CX-Net Controller Link/CLKSS data link tables .cl3 – CX-Net Controller Link data link tables .clk – CLKSS data link tables .csv – CX-Net Controller Link data link tables (tab-delineated text file)
	SYSMAC LINK	.sl3 – SYSMAC LINK data link tables .slk – SYSMAC LINK data link tables for SYSMAC Support Software .csv – SYSMAC LINK data link tables (tab-delineated text file)
(4)	Save	Saves the data link tables that are being edited.
(5)	Toggle Network/Single Node Operation	Specifies either all nodes or a single node for data transfers.
(6)	Transfer to PLC	Downloads online data link tables from the computer to a PLC.
(7)	Transfer from PLC	Uploads online data link tables to the computer.
(8)	Delete	Deletes data link tables.
(9)	Verify Node	Compares data link tables generated by CX-Integrator with data link tables stored in the PLC. If they do not match, an error dialog box is displayed.
(10)	Data Link Operation/Status	Displays the operation and data link status of manually set data links.
(11)	Automatic Data Link Setup	Sets parameters for automatically set data links, and transfers them to the startup node.
(12)	Validate Table	Checks data link tables.
(13)	Wizard	Executes the Datalink Wizard.
(14)	Add Source Link	Adds a node to the data links.
(15)	Add Destination	Adds the receive area of a participating node to the data links.
(16)	Set Source or Destination Link Area Properties	Displays the Node Settings dialog box. This dialog box is used to modify the node properties.
(17)	Delete Link Destination Service Area	Deletes nodes selected in the Data Link Configuration Window, or deletes a receive area.
(18)	Zoom In/Zoom Out/Zoom Original	Zooms the Data Link Configuration Window in or out, or returns it to the initial scale.
(19)	Print	Prints data link information.
(20)	Help	Displays help.

**Function Bar**

F1: Help	F2: Node <->Table	F3: Link Start Address	F4: MoveUp Area	F5: MoveDown Area	F6: Show/Hide Offset	F7: Insert Area	F8: Delete Area	F9: Show Prev Node	F10: Show Next Node
(1)	(2)	(3)	(4)	(5)	(6)	(7)	(8)	(9)	(10)

No.	Icon	Function
(1)	F1: Help	Displays help.
(2)	F2: Node<->Table	Moves the focus between nodes and tables.
(3)	F3: Link Start Address	Moves the focus between settings for the link start addresses (status, Area 1, Area 2).
(4)	F4: Move Up Area	Moves a node up the node refresh sequence.
(5)	F5: Move Down Area	Moves a node down the node refresh sequence.
(6)	F6: Show/Hide Offset	Shows or hides the offset for the node being displayed.
(7)	F7: Insert Area	Inserts a new receive area (new node).
(8)	F8: Delete Node	Deletes a node or communications area. To delete a node or link area from a node list, select the item from the list and then click <b>F8: Delete Node</b> . To delete a node or link area from a table, select the item from the table and then click <b>F8: Delete Node</b> .
(9)	F9: Show Prev Node	Shows the previous node.
(10)	F10: Show Next Node	Shows the next node.

## 4-3 Manually Setting Data Links

### 4-3-1 Procedure through Data Link Startup

## 4-3 Manually Setting Data Links

Follow the procedure described below to create data link tables manually for Controller Link or SYSMAC LINK data links.

Note: There is no need to create a data link tables when data links are set automatically. For details on automatic setup, refer to *Automatically Set Data Links*.

### 4-3-1 Procedure through Data Link Startup

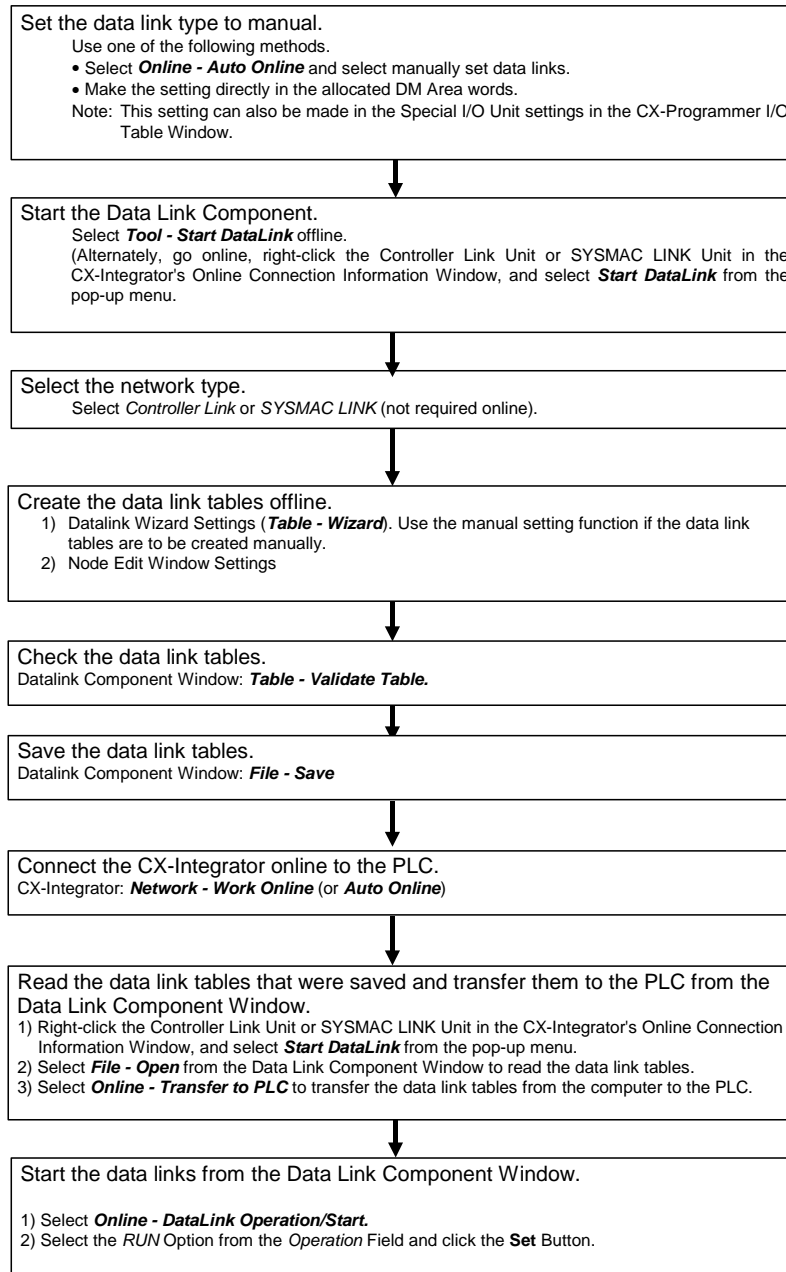

**Reference** Create data link tables manually when any of the following conditions is present:

1. The send area size differs for nodes participating in the data link.
2. The sequence of send nodes differs from the sequence of node addresses.
3. There are nodes that receive only part of the send data (Controller Link only).
4. There are nodes that receive data with an offset specified (Controller Link only).
5. There are nodes that do not send data (Controller Link only).
6. There are nodes that do not receive data.

## 4-3-2 Creating Data Link Tables

Create a data link table for each node registered in the CX-Server file that is read. Make the settings for (1) to (8) below.

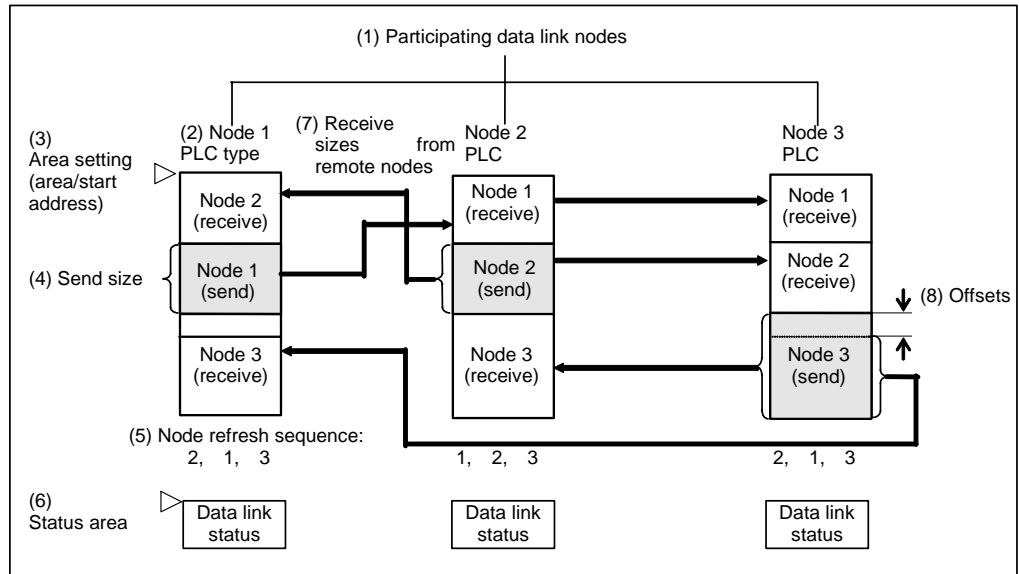

To create a data link table, make the following settings in order.

### 1. Datalink Wizard Settings

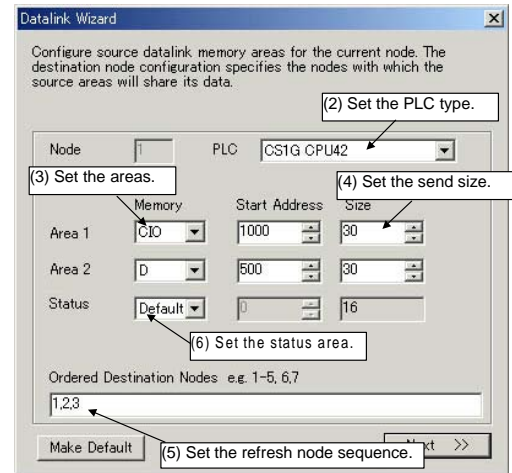
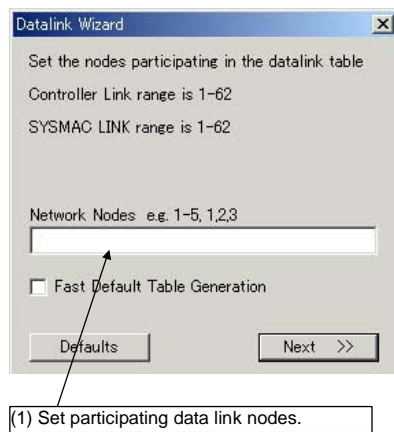

## 2. Node Editing Window Settings

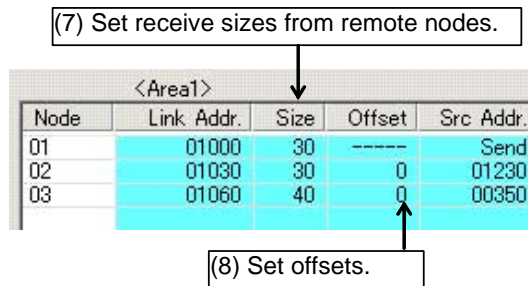

Note 1. It is possible to add or delete nodes from the participating data link nodes (1) using the Datalink Wizard.

Add	Adding nodes	Select <b>Table - Add Source Link</b> .
	Adding link words	Select <b>Table - Add Destination</b> .
Delete	Deleting specified nodes or link areas	Select the node from the node list, and then click <b>F8: Delete Node</b> .
	Deleting link areas from specified nodes	Select the node from the table, and then click <b>F8: Delete Node</b> .

Note 2. It is possible to change the following items set by the Datalink Wizard for each node: (2) PLC type, (3) Area (memory area and start address), (4) Send size, (5) Node refresh sequence (see note 3), and (6) Status area.

Note 3. The node refresh sequence is set using F4: Move Up Area and F5: Move Down Area.

### Note

The operations differ for Controller Link and SYSMAC LINK when creating data links. The following table shows the points on which the manually set data link functions are different.

Function	Controller Link	SYSMAC LINK
(1) Offset setting	Supported	Not supported
(2) Receive size setting	Supported	Not supported. (It is only possible to specify whether all of none of the data sent is to be received.)
(3) Memory area	Area 1: Can be selected. Area 2: Can be selected. (CIO, LR, DM, EM, etc., according to PLC type)	Area 1: CIO Area 2: DM (Fixed.)
(4) Communications cycle time setting	Not supported	Supported

These four differences apply even to data link setup operations using the CX-Integrator. Aside from these points, other operations are basically the same.



### 4-3-3 System Configuration Example

The procedure is described below, from data link creation through startup, taking a Controller Link data link system as an example.

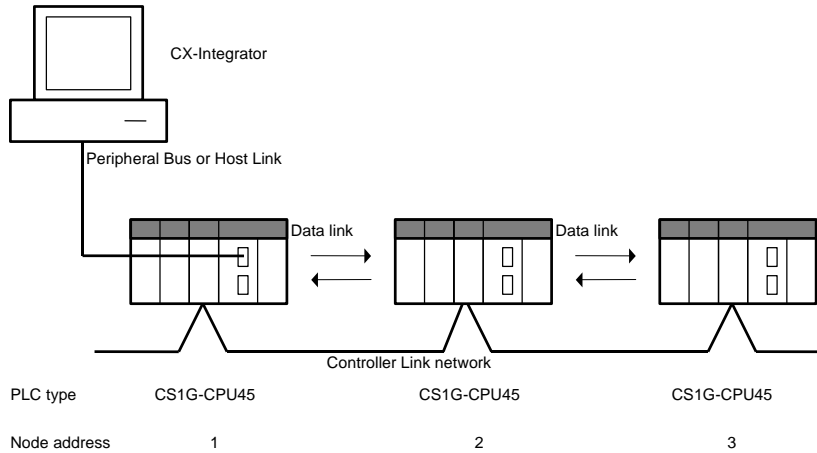

### Data Link Setup Example

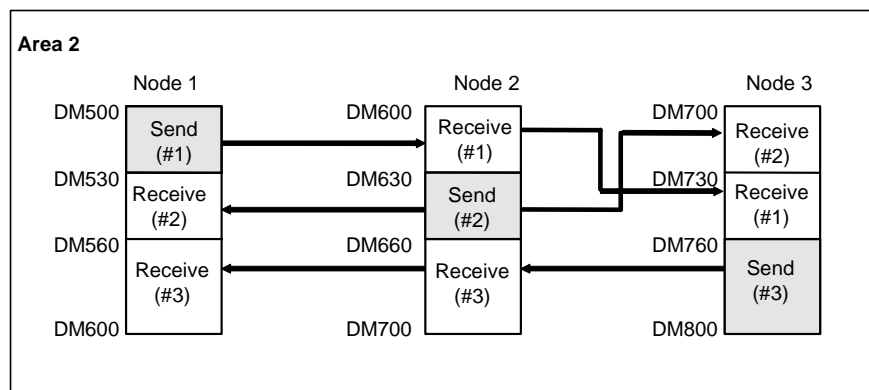
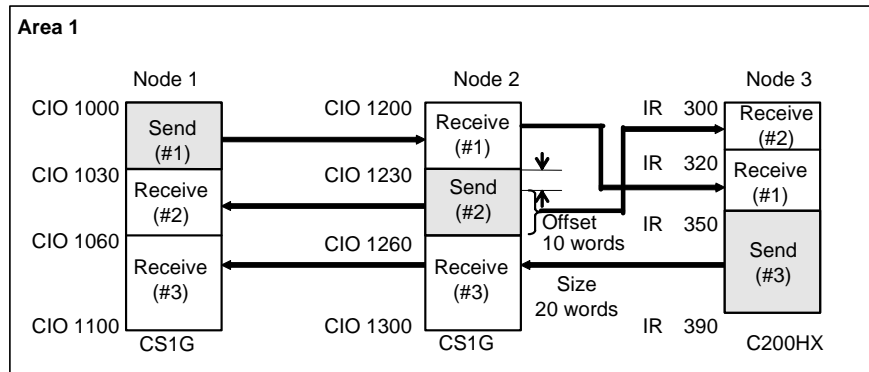

The refresh sequence for nodes 1 and 2 is as follows: #1, #2, #3. For node 3, the order is #2, #1, #3. Node address 03 does not receive all of the data sent from node address 02. Rather, data from the 20 words (CIO 1240 to CIO 1259) beginning from the start address +10 words (i.e., the offset) is received in IR 300 to IR 319. Other data is received with no offset.

**4-3 Manually Setting Data Links**  
**4-3-4 Creating Data Link Tables Offline**

**4-3-4 Creating Data Link Tables Offline**

First create manually set data link tables offline.

**Datalink Wizard Operations**

- 1 While offline, select **Tools - Start Data Link**.

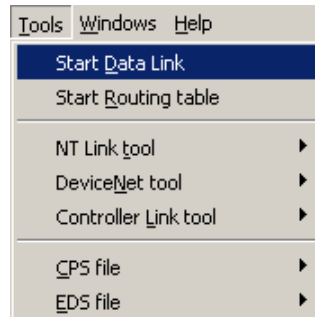

The Select Network Dialog Box will be displayed.

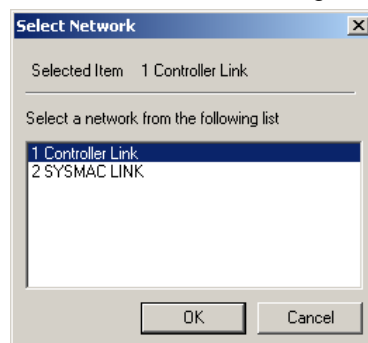

- 2 Select either **Controller Link** or **SYSMAC LINK**, and then click the **OK** Button. The Datalink Component Window will be displayed.

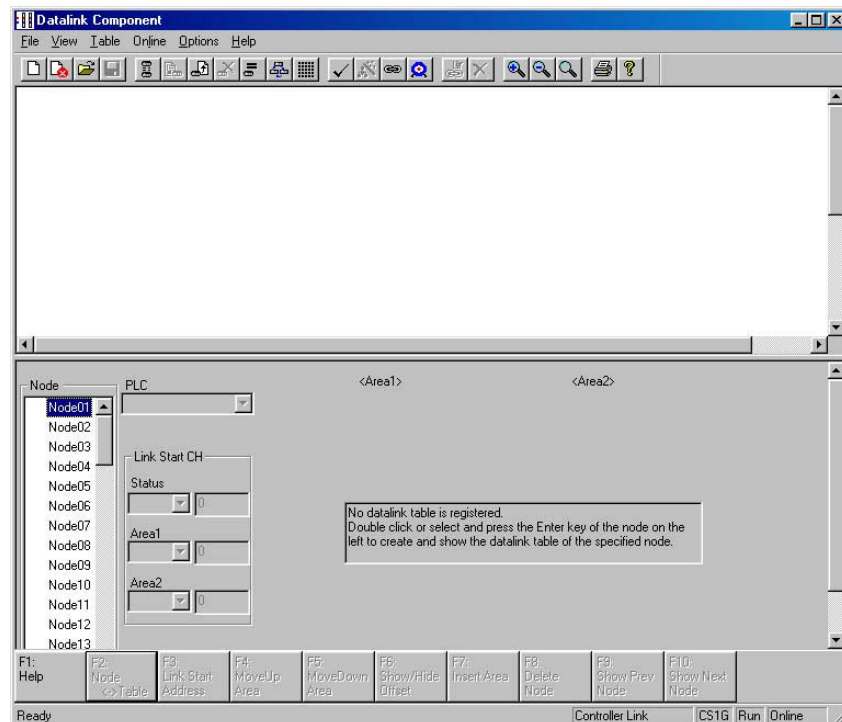

### 4-3 Manually Setting Data Links

#### 4-3-4 Creating Data Link Tables Offline

- 3 Select **Table - Wizard**. If data link tables have already been input, the following dialog box will be displayed. (It will not be displayed if these are the first data link tables being created.)

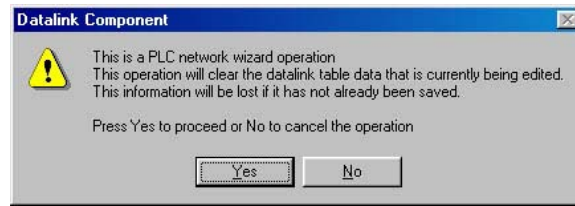

- 4 Click the **Yes** Button. The Datalink Wizard Dialog Box will be displayed for setting the participating data link nodes.

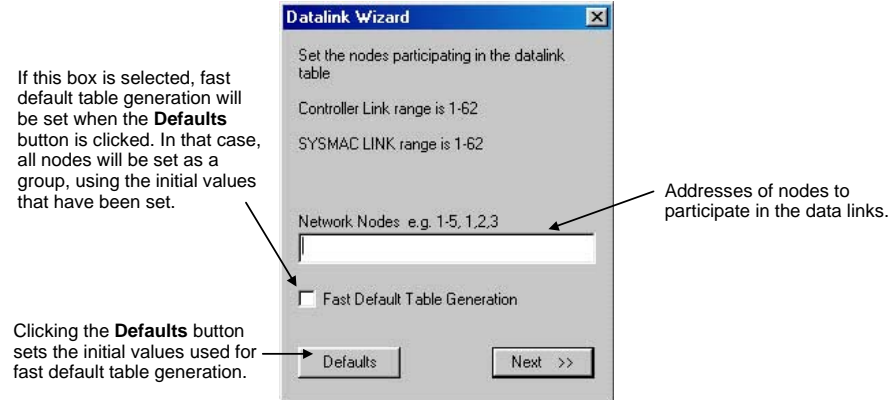

- 5 Set the addresses of the nodes that are to participate in the data links. In this case, input 1-3 to set node addresses 01 to 03. (To set node addresses 01, 02, and 04, for example, input 1,2,4.)
- 6 Click the **Next** Button or press the **Enter** key. The following dialog box will be displayed.

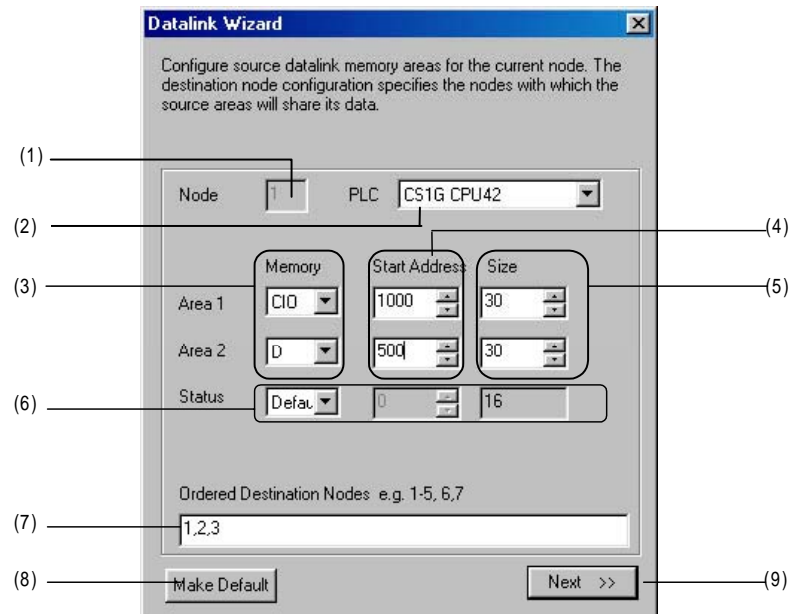

**4-3 Manually Setting Data Links**  
**4-3-4 Creating Data Link Tables Offline**

No.	Item	Function
(1)	Node	Displays node address to set.
(2)	PLC	Sets the PLC type.
(3)	Memory area	Area 1 memory area
		Area 2 memory area
(4)	Start Address	Area 1 start address
		Area 2 start address
(5)	Size	Area 1 local node send size (in words)
		Area 2 local node send size (in words)
(6)	Status	Data link status memory area (See note.)
(7)	Ordered Destination Nodes	Node Refresh Sequence Beginning with the data link start address above, specify which nodes are to have data refreshed at the local node address and the order in which data is to be refreshed (i.e., the node refresh sequence). This order will be the same for Area 1 and Area 2. (For the local node address, data is sent from the local node area. For a remote node address, data is received from the remote node address to the local area.) Note: <ul style="list-style-type: none"> <li>• The local node must be included in the refresh nodes.</li> <li>• If the address of any node participating in the data links is not entered here, data will not be received from that node.</li> </ul> Example: If 1, 2, 3 is input, node addresses 1, 2, and 3 will be allocated in order, beginning with the start address.
(8)	Make Default	Click this button to make the values set for the above items the default values for new data link settings.
(9)	Next >>	Click to proceed to the next dialog box.

**Note:** The default setting for data link status depends on the PLC being used. For details, refer to the *Controller Link Units Operation Manual (W309)*.

PLC	Data link status																				
CS/CJ Series	The data link status is contained in the 16 words (fixed) from CIO 1500 + 25 × unit number + 7 to 22 in the CPU Bus Unit Area. <div style="text-align: center;"> <table border="1" style="margin-left: auto; margin-right: auto;"> <tr> <td style="text-align: right;">+7 words</td> <td style="text-align: center;">15</td> <td style="text-align: center;">8</td> <td style="text-align: center;">7</td> <td style="text-align: center;">0</td> </tr> <tr> <td></td> <td style="text-align: center;">Node 2</td> <td colspan="2"></td> <td style="text-align: center;">Node 1</td> </tr> <tr> <td style="text-align: center;">...</td> <td style="text-align: center;">...</td> <td colspan="2"></td> <td style="text-align: center;">...</td> </tr> <tr> <td style="text-align: right;">+22 words</td> <td style="text-align: center;">Node 32</td> <td colspan="2"></td> <td style="text-align: center;">Node 31</td> </tr> </table> </div>	+7 words	15	8	7	0		Node 2			Node 1	...	...			...	+22 words	Node 32			Node 31
+7 words	15	8	7	0																	
	Node 2			Node 1																	
...	...			...																	
+22 words	Node 32			Node 31																	

7 Set node address 01 as shown in the following table, and then click the **Next** Button or press the **Enter** key. Set node addresses 02 and 03 in the same way.

Item	Data set	Description	
Node address	1	–	
PLC type	CS1G-CPU45	–	
Area 1	Memory area	CIO	
	Start address	1000	Sets CIO 1000 as the data link start address for the Area 1 local node.
	Send size	30	Sets 30 words as the send size (unit: words) for the Area 1 local node.
Area 2	Memory area	D	
	Start address	500	Sets D00500 as the data link start address for the Area 2 local node.
	Send size	30	Sets 30 words as the send size (unit: words) for the Area 2 local node.
Ordered destination nodes	1, 2, 3	Specifies the node refresh sequence. Beginning with the start addresses, nodes 01, 02, and 03 are set in order. (The local node address is 1, so transmission is first, followed by reception from node 02, and finally reception from node 03.)	
Status	Memory area	CIO	
	Start address	1100	Sets CIO 1100 as the data link status start address.

**4-3 Manually Setting Data Links**  
**4-3-4 Creating Data Link Tables Offline**

8 Set node address 02 as shown in the following table.

Item		Data set	Description
Node address		2	–
PLC type		CS1G-CPU45	–
Area 1	Memory area	CIO	Sets CIO 1200 as the data link start address for the Area 1 local node.
	Start address	1200	
	Send size	30	Sets 30 words as the send size (unit: words) for the Area 1 local node.
Area 2	Memory area	D	Sets D00600 as the data link start address for the Area 2 local node.
	Start address	600	
	Send size	30	Sets 30 words as the send size (unit: words) for the Area 2 local node.
Ordered destination nodes		1, 2, 3	Specifies the node refresh sequence. Beginning with the start addresses, nodes 01, 02, and 03 are set in order. (Reception from node 01 is first, followed by transmission from the local node, and finally reception from node 03.)
Data link status start address	Memory area	CIO	Sets CIO 1300 as the data link status start address.
	Start address	1300	

9 Set node address 03 as shown in the following table, and then click the **Next** Button or press the **Enter** key.

Item		Data set	Description
Node address		3	–
PLC type		CS1G-CPU45	–
Area 1	Memory area	IR	Sets IR 300 as the data link start address for the Area 1 local node.
	Start address	300	
	Send size	40	Sets 40 words as the send size (unit: words) for the Area 1 local node.
Area 2	Memory area	DM	Sets DM 700 as the data link start address for the Area 2 local node.
	Start address	700	
	Send size	40	Sets 40 words as the send size (unit: words) for the Area 2 local node.
Ordered destination nodes		2, 1, 3	Specifies the node refresh sequence. Beginning with the start addresses, nodes 02, 01, and 03 are set in order. (Reception from node 02 is first, followed by reception from node 01, and finally transmission from the local node address.)
Data link status start address	Memory area	LR	Sets LR0 as the data link status start address.
	Start address	0	

## 4-3 Manually Setting Data Links

### 4-3-4 Creating Data Link Tables Offline

#### **Note** Fast Datalink Wizard Settings

It is possible to generate a table with all nodes set for the same PLC type and the same areas (using Fast Default Table Generation), and then to modify individual nodes in the Node Editing Window as required.

Make the settings as follows:

- 1 Click the **Defaults** Button and then set the default values in the following dialog box.

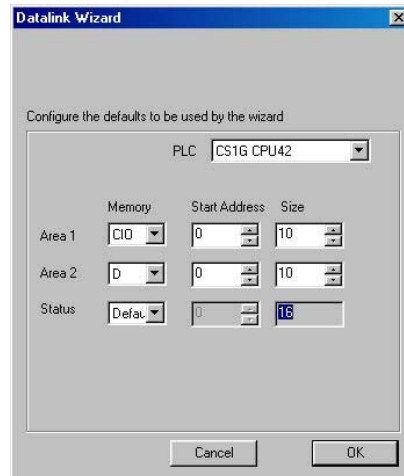

- 2 Select the *Fast Default Table Generation* Option, and then click the **Next** Button or press the Enter key.

The settings for all participating nodes will be generated at the above default values.

- PLC type
- Memory area, data link start address, communications data size
- Status memory area

## Node Editing Window Settings

10 The following Datalink Component Window will be displayed.

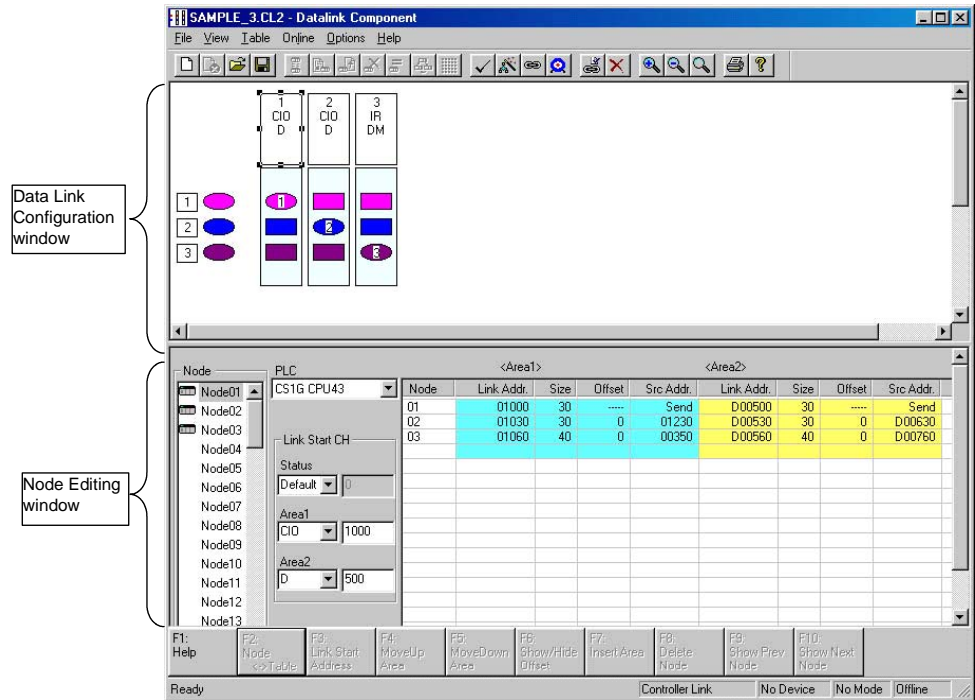

## Data Link Configuration Window

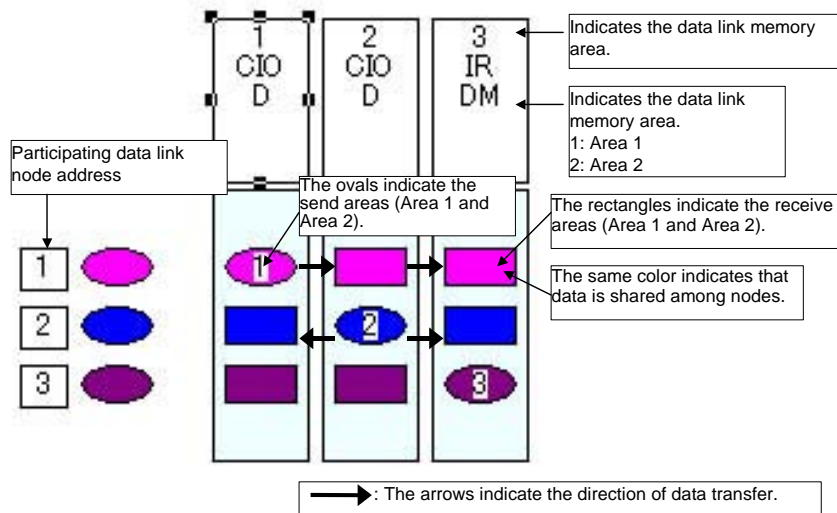

Send areas are indicated by ovals in order of the addresses of nodes participating in the data links. The same color indicates that data is shared among nodes. Therefore, with the number of participating nodes represented by  $n$ , one oval and  $n-1$  rectangles are shown for each node. This window can be used to check the data sent and received between nodes.

**4-3 Manually Setting Data Links**  
**4-3-4 Creating Data Link Tables Offline**

**Node Editing Window Settings**

Set the data link details for each node (i.e., send size, receive size, reception offset) in the Node Editing Window.

Note: The Node Edit Window appears in table format by default, as shown below. To convert it back into the earlier list format, select **View - Show in List**.

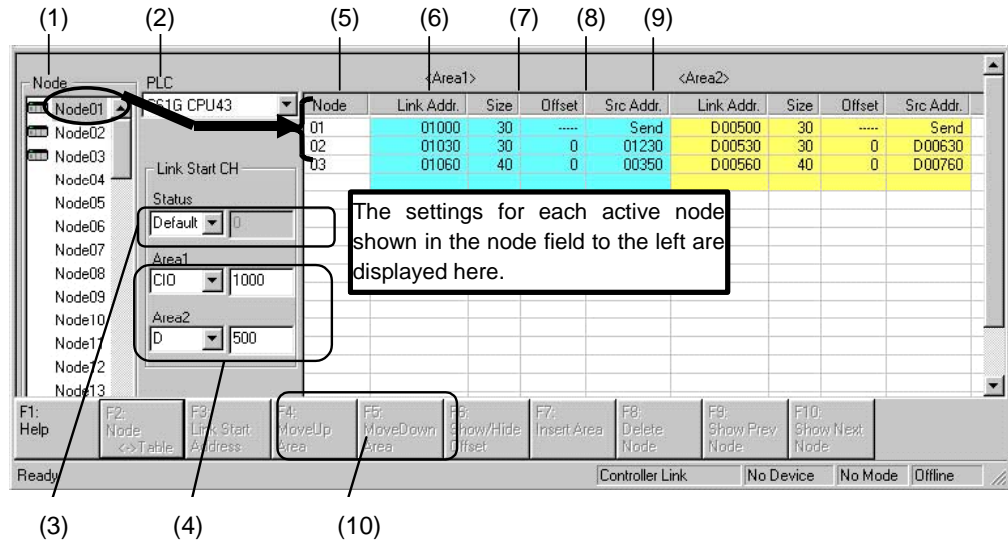

No.	Name	Description
(1)	Node	Selects the address of the node to be edited. The settings for an active node (selected with <input type="checkbox"/> ) are displayed to the right.
(2)	PLC	The PLC type set by the Datalink Wizard is displayed and can be changed here.
(3)	Status	The status memory area and start address set by the Datalink Wizard are displayed and can be changed here.
(4)	Area 1/Area 2	The Area 1 and Area 2 classifications and start addresses set by the Datalink Wizard are displayed and can be changed here.
(5)	Node (Display only. Order can be changed.)	<ul style="list-style-type: none"> <li>Node addresses are displayed from top to bottom, in order of node refreshing at the local node (in order of allocated node address).</li> <li>To change the refresh sequence set by the Datalink Wizard, click either F4: Move Up Area or F5: Move Down Area in the Function Bar, or press the corresponding Function key.</li> </ul>
(6)	Link Addr. (Automatic display)	<ul style="list-style-type: none"> <li>For the local node send area, the start address of the data sent from the local node is automatically displayed.</li> <li>For the receive area from remote nodes, the local node start address for storing data received from remote nodes is automatically displayed.</li> </ul>
(7)	Size (Setting/Display)	<ul style="list-style-type: none"> <li>For the local node send area, the send size set by the Datalink Wizard is displayed and can be changed here.</li> <li>For the receive area from remote nodes, the receive size from remote nodes is set here in word units. (It can only be set here.) The default is the entire send size from remote nodes.</li> </ul>
(8)	Offset (Setting/Display)	The reception offset from the source start address displayed at "Src. Addr." is set here. (The default is 0.)
(9)	Src. Addr. (Automatic display)	<ul style="list-style-type: none"> <li>For the local node send area, "Send" is automatically displayed.</li> <li>For the receive area from a remote node, the remote node's source start address (the value before the offset) is automatically displayed.</li> </ul>
(10)	F4: Move Up Area F5: Move Down Area	Changes the node refresh sequence.

Note: The areas and start addresses that can be set for Controller Link data link status depend on the model of CPU Unit. If the start address is not set correctly, a data link table error will occur and the LNK indicator on the Controller Link Unit will flash. Refer to the *Controller Link Unit Operation Manual* for details.



**Node Editing Window (Edited Node Address: Node 01)**

Node	Link Addr.	Size	Offset	Src Addr.
03	01000	20	0	D00000
01	01020	30	----	Send
02	01050	40	0	00200

Address at local node (points to Link Addr.)      Address at remote node (points to Src Addr.)

(1) → (1)      (2) → (2)      (3) → (3)

Indicates that the node refresh sequence (points to Node column)

Function	
(1)	Indicates that 20 words (D00000 to D00019) from a remote node (node 03) are received into the area starting from CIO 01000 (i.e., CIO 01000 to CIO 01019) at the local node (node 01).
(2)	Indicates that 30 words starting from CIO 01020 (i.e., CIO 01020 to CIO 01049) from the local node (node 01) are sent to a remote node.
(3)	Indicates that 40 words (CIO 00200 to CIO 00239) from a remote node (node 02) are received into the area starting from CIO 01050 (i.e., CIO 01050 to CIO 01089) at the local node (node 01).

**Note** It is also possible to display the Node Editing Window in list format, as before. Select **View - Show in List** from the menu. The change will go into effect the next time the window is opened.

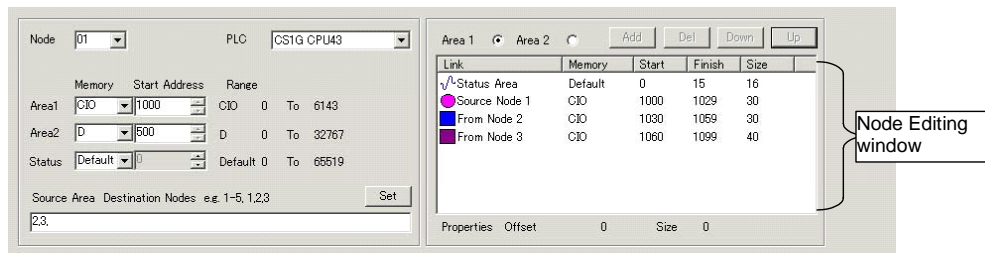

**Setting Size (Send or Receive) and Offset**



- The send size can be set for the local node row by double-clicking in the Size cell. (The default is the size set by the Datalink Wizard.) For remote node rows, the receive size can be set. (The default is the entire send size from remote nodes.)
- The reception offset can be set by double-clicking the Offset cell. (The default is 0.)

Size and offset can be set.

Node	Link Addr.	Size	Offset	Src Addr.
01	01000	30	----	Send
02	01030	30	0	01230
03	01060	40	0	00350

Automatically displayed.

**4-3 Manually Setting Data Links**  
**4-3-4 Creating Data Link Tables Offline**

**Note** Size modifications and offsets can be set in the Area Specify Dialog Box that is displayed by double-clicking on the data link configuration icon (oval for send area  or rectangular for receive area ).

Area Specify Dialog Box (Send Area)

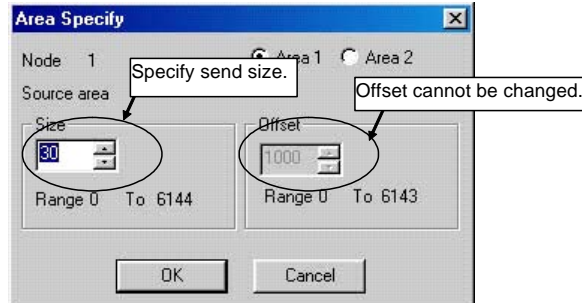

Area Specify Dialog Box (Receive Area)

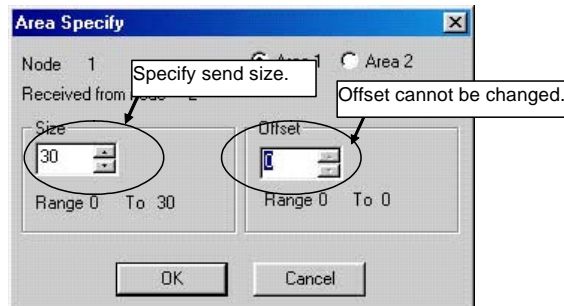

Note: With SYSMAC LINK, the send size can be set, but the receive size and the reception offset cannot. Therefore, the Area Specify Dialog Boxes are as shown in the following example diagrams.

- **Send Area**  
Can be set.

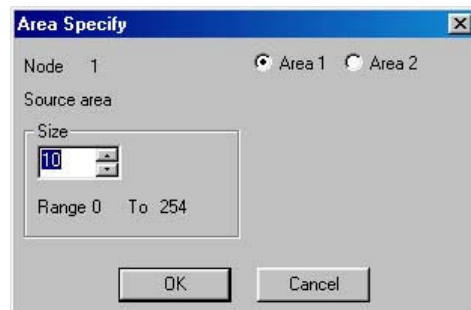

- **Receive Area**  
Cannot be set.

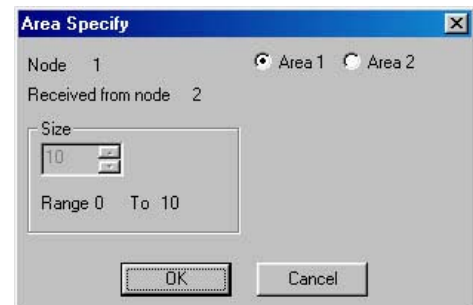

**Changing Node Refresh Sequences**

The node refresh sequence set for each node by the Datalink Wizard can be changed in the Node Editing Window.

In the Node Editing Window, select the node for which the refresh sequence is to be changed.

Node	Link Addr.	Size	Offset	Src Addr.
01	01000	30	----	Send
02	01030	30	0	01230
03	01060	40	0	00350

Change the node refresh sequence by either clicking F4: Move Up Area or F5: Move Down Area in the Function Bar, or pressing the F4 or F5 function keys.

Node	Link Addr.	Size	Offset	Src Addr.
01	01000	30	----	Send
03	01030	40	0	00350
02	01070	30	0	01230

**Note** The node refresh sequence for individual nodes cannot be checked in the Data Link Configuration Window. Node refresh sequence checking and changes must be performed in the Node Editing Window.

**Adding Participating Nodes to Data Links**

In the Node Editing Window, it is possible to add nodes aside from the participating nodes set by the Datalink Wizard's Network Nodes setting.

The following window is displayed by selecting **Table - Add Source Node** from the Datalink Component Menu or by clicking the  Button in the Toolbar.

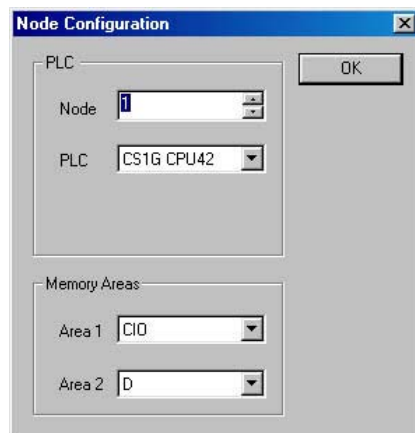

Specify the node address, PLC type, and the Area 1 and Area 2 memory areas, and then click the **OK** Button.

**4-3 Manually Setting Data Links**  
**4-3-4 Creating Data Link Tables Offline**

The node will be added.

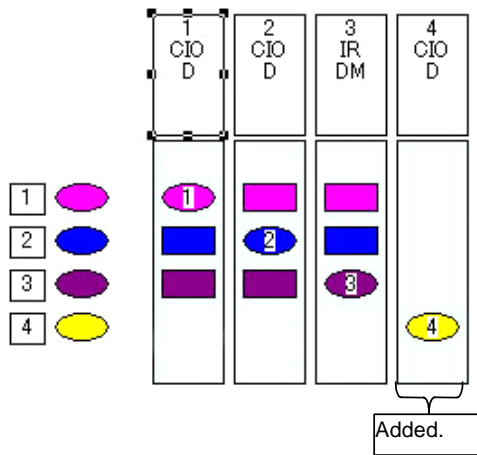

**Deleting Nodes Added to the Data Links**

Select the node to be deleted from the Node Editing Window.  
Delete the node by clicking the **F8: Delete Node** Button in the Function Bar.

**Caution** If the node is deleted by clicking the Button in the Toolbar, the deletion will be executed immediately.

**Setting to Not Receive Data**

Set the receive size to 0 in the Node Editing Window.

<Area1>				
Node	Link Addr.	Size	Offset	Src Addr.
01	01000	30	----	Send
02	01030	0	0	01230
03	01060	40	0	00350

**Setting to Not Send Data**

Set the send size to 0 in the Node Editing Window.

<Area1>				
Node	Link Addr.	Size	Offset	Src Addr.
01	01000	0	----	Send
02	01030	30	0	01230
03	01060	40	0	00350

### 4-3-5 Procedure Using Setup Example

Set Area 1 for each node, based on the data link setup example in the example system configuration.

Note: The receive size and reception offset can only be set for Controller Link, and not for SYSMAC LINK.

#### Setting Node Address 01

- 1 Select node address 01 from the node address list on the left. Node 01 will be highlighted.

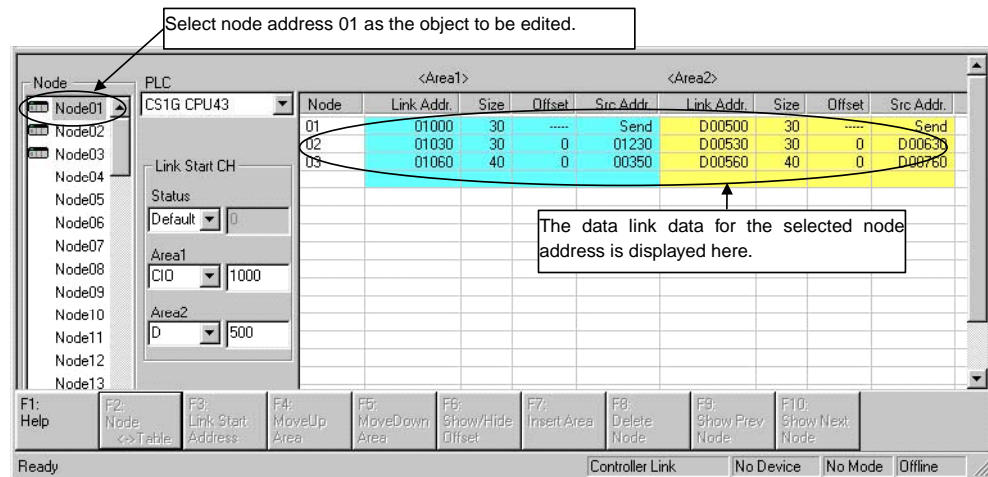

The data link table for node address 01, the node to be edited, is displayed as a list in the Node Editing Window on the right.

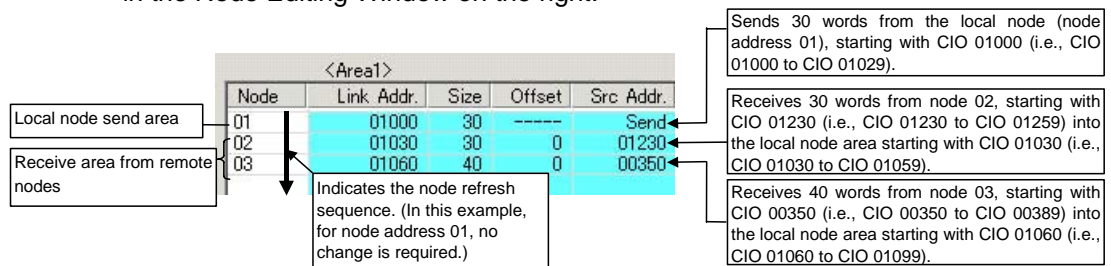

**Note** With node address 01, the node refresh sequence matches the default (order of addresses), so no change is required. With node address 01, the size and offset are both automatically displayed as the defaults, so no changes are required.

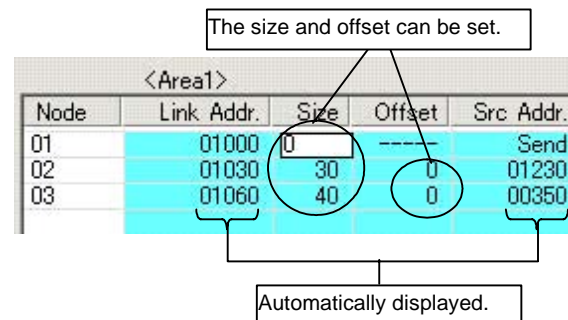

- 2 With node address 01, the node refresh sequence matches the default (order of addresses), so no change is required. With node address 01, the size and offset are both automatically displayed as the defaults, so no changes are required. Settings for area 2 are made using the same method.

**4-3 Manually Setting Data Links**  
**4-3-5 Procedure Using Setup Example**

**Setting Node Address 02**

Node address 02 is set in the same way as node address 01.

Node	Link Addr.	Size	Offset	Src Addr.
01	01200	30	0	01000
02	01230	30	----	Send
03	01260	10	0	00350

Local node send area (points to Node 01)  
 Receive area from remote nodes (points to Node 02 and 03)

**Setting Node Address 03 (Setting an Offset)**

For node address 03, the procedure for setting the node refresh sequence and the offset is as follows:

- 1 Select node address 03 from the node address list on the left.
- 2 With node address 03, the node refresh sequence does not match the default, so the order of addresses must be changed. Change the node refresh sequence by either clicking F4: Move Up Area or F5: Move Down Area in the Function Bar, or pressing the F4 or F5 function keys.

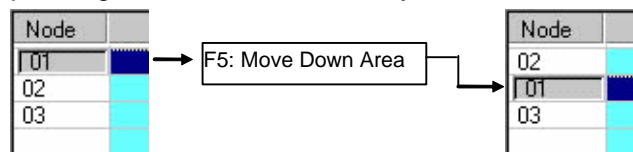

- 3 Double-click on the Offset cell, and input the data size to be offset. In this example, set the offset size to 10 words.

<Area1>				
Node	Link Addr.	Size	Offset	Src Addr.
01	00300	20	10	01000
02	00320	30	0	01230
03	00350	40	----	Send

With this setting, 20 words sent from node 01 will be received, starting from CIO 1000, and with an offset of 10 words (i.e., CIO 1010 to CIO 1030).

### 4-3-6 Checking Data Link Tables

- 1 Select **Table - Validate Table** in the Data Link Editor (Controller Link or SYSMAC LINK). The results of the check will be displayed as shown in the following illustration.

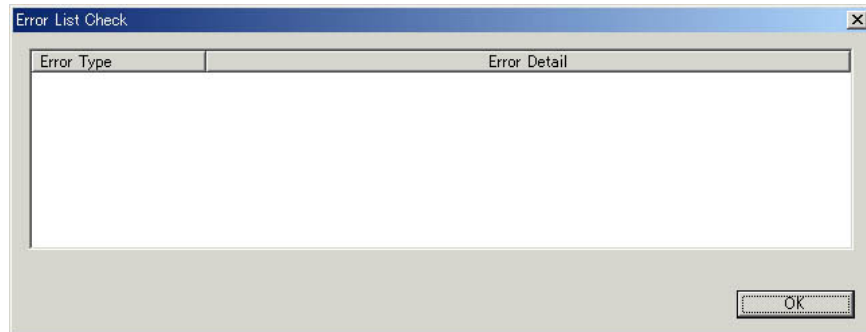

### 4-3-7 Printing Data Link Tables

Follow the procedure below to print data link tables that have been generated.

- 1 Select **File - Print** in the Data Link Editor (Controller Link or SYSMAC LINK).  
 Printing Example:

<< Controller Link Datalink Informat

Node Information

Node	Number of Links	Area 1 Link Words	Area 2 Link Words	Node	Number of Links	Area 1 Link Words	Area 2 Link Words
01	3	100	100	32			
02	3	70	100	33			
03	3	90	100	34			
04				35			
05				36			
06				37			
07				38			
08				39			
09				40			
10				41			
11				42			
12				43			
13				44			
14				45			
15				46			
16				47			
17				48			
18				49			
19				50			
20				51			
21				52			
22				53			
23				54			
24				55			
25				56			
26				57			
27				58			
28				59			
29				60			
30				61			
31				62			

Node [ 1 ] PLC Type [ CS1G CPU43 ] Number of Links [ 3 ] Status Start Address [ Default : 0 ]

Node	< Area 1 > Start Address [ CIO : 1000 ]			< Area 2 > Start Address [ D : 500 ]		
	Link AddressSize	Source Address	Offset	Link AddressSize	Source Address	Offset
1	CIO : 1000	30	Send Area	D : 500	30	Send Area
2	CIO : 1030	30	CIO : 1230	D : 530	30	D : 630
3	CIO : 1060	40	IR : 350	D : 560	40	IM : 760

Node [ 2 ] PLC Type [ CS1G CPU43 ] Number of Links [ 3 ] Status Start Address [ Default : 0 ]

Node	< Area 1 > Start Address [ CIO : 1200 ]			< Area 2 > Start Address [ D : 600 ]		
	Link AddressSize	Source Address	Offset	Link AddressSize	Source Address	Offset
1	CIO : 1200	30	CIO : 1000	D : 600	30	D : 500
2	CIO : 1230	30	Send Area	D : 630	30	Send Area
3	CIO : 1260	10	IR : 350	D : 660	40	IM : 760

Node [ 3 ] PLC Type [ C200HX ] Number of Links [ 3 ] Status Start Address [ DM : 0 ]

Node	< Area 1 > Start Address [ IR : 300 ]			< Area 2 > Start Address [ DM : 700 ]		
	Link AddressSize	Source Address	Offset	Link AddressSize	Source Address	Offset
1	IR : 300	20	CIO : 1010	DM : 700	30	D : 500
2	IR : 320	30	CIO : 1230	DM : 730	30	D : 630
3	IR : 350	40	Send Area	DM : 760	40	Send Area



## 4-3 Manually Setting Data Links

### 4-3-8 Saving Data Link Tables

#### 4-3-8 Saving Data Link Tables

Follow the procedure below to save data link tables that have been generated. Data link tables are saved with a .cl2 file name extension as the default. It is also possible to save them in .csv format.

- 1 Select **File - Save As** in the Data Link Editor (Controller Link or SYSMAC LINK). The Save As Dialog Box will be displayed.
- 2 Input the file name ("Sample" in this example), and specify the location where the file is to be saved. Then click the **Save** Button. The data will be saved to a file with a .cl2 extension added to the file name (i.e., "Sample.cl2" in this case).

#### 4-3-9 Creating, Reading, and Writing CSV Files (Saving)

##### Creating CSV Files

Based on the CSV-format template file (Sample1.csv) provided with this software, it is possible to create files in CSV format for data link tables created manually using spreadsheet software (such as MS Excel).

Including the Sample1.csv file, there are three types of files provided as reference material. The other two, in addition to Sample1.csv, are Sample1.xls (which describes tags and data), and Sample1.cl2 (data link table file format).  
(Sample1.xls window)

	A	B	C	D	E	F	G	H	I	J	K	L	M	N
1	<net-param>													
2	<network-type>	CLK												
3	<cycletime>													
4	<author>													
5	<information>													
6	<comment>													
7	</net-param>													
8	<node-param>													
9	<node>		1				2				3			
10	<cpu>		CSTG				CSTG				CSTG			
11	<cpu-type>		CPU42				CPU42				CPU42			
12	<status-start-type>		Default				Default				Default			
13	<status-start-ch>		0				0				0			
14	</node-param>													
15	<area1>													
16	<start-type>													
17	<start-ch>		100				200				150			
18	<link-area>		2	120	20	0	1	200	15	0	3	150	30	0
19	<link-area>		3	120	30	0	2	215	20	0	1	180	15	0
20	<link-area>		1	150	15	0	3	235	30	0	2	195	20	0
21	</area1>													
22	<area2>													
23	<start-type>		D				D				D			
24	<start-ch>		10100				10200				10150			
25	<link-area>		2	D10100	20	0	1	D10200	15	0	3	D10150	30	0
26	<link-area>		3	D10120	30	0	2	D10215	20	0	1	D10180	15	0
27	<link-area>		1	D10150	15	0	3	D10235	30	0	2	D10195	20	0
28	</area2>													



## Reading CSV Files

Files in CSV format can be read to data link tables.

- 1 While offline, select **Tools - Start Data Link** from the CX-Integrator menu bar. The Select Network Dialog Box will be displayed.

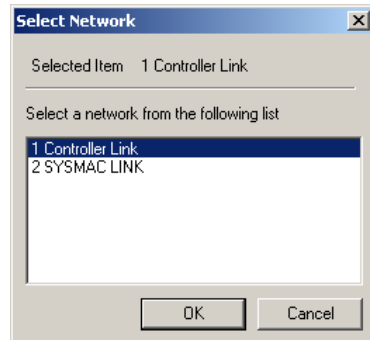

- 2 Select *Controller Link* or *SYSMAC LINK* and click the **OK** Button. The Datalink Component Dialog Box will be displayed.

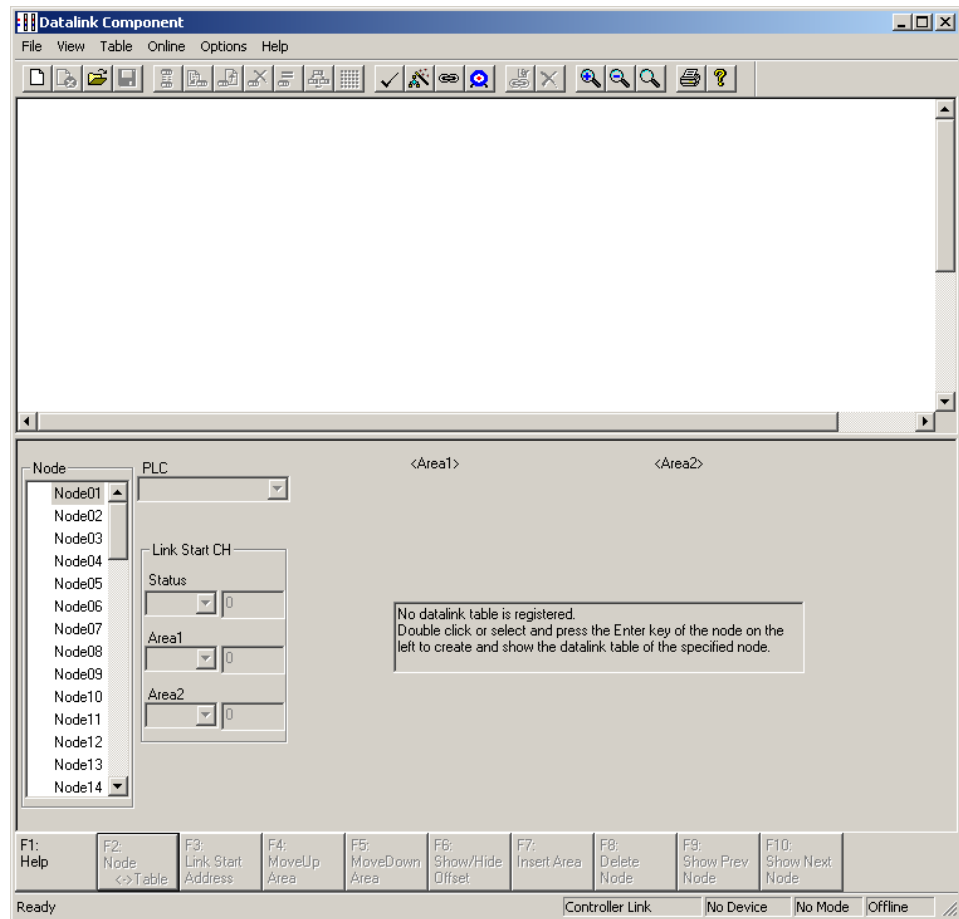

### 4-3 Manually Setting Data Links

#### 4-3-9 Creating, Reading, and Writing CSV Files (Saving)

- 3 Select **File - Open** menu bar, and then select \*.csv from the *File of Type* Field.

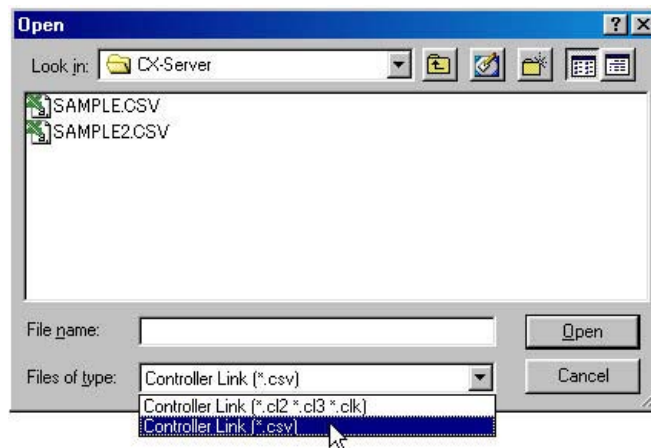

### Writing CSV Files (Saving)

Once data link tables have been created, they can be written to CSV-format files.

- 1 Select **File - Save As** from the menu bar in the Datalink Component Dialog Box, and then select \*.csv from the *File of Type* Field.

**Note** The following illustration provides an example of a written CSV file.

	A	B	C	D	E	F	G	H	I	J	K	L	
1	<net-param>												
2	<network-type>	SLK											
3	<cycletime>		0										
4	<author>												
5	<information>												
6	<comment>												
7	</net-param>												
8	<node-param>												
9	<node>												
10	<coupl>		CS/GJ	1			CS/CJ	2			CS/GJ	3	
11	<status-start-type>												
12	<status-start-ch>			0				0				0	
13	</node-param>												
14	<areal>												
15	<start-type>												
16	<start-ch>												
17	<link-area>			0			1200				300		
18	<link-area>			1	1000	30		1	1200	30		1	300
19	<link-area>			2	1090	30		2	1230	30		2	330
20	<link-area>			3	1060	10		3	1260	10		3	360
21	</areal>												
22	<areal2>												
23	<start-type>			D				D				D	
24	<start-ch>				500				600			700	
25	<link-area>			1	D00500	30		1	D00600	30		1	D00700
26	<link-area>			2	D00530	30		2	D00630	30		2	D00730
27	<link-area>			3	D00660	10		3	D00660	10		3	D00760
28	</areal2>												
29	</areal2>												

Note: When displayed by spreadsheet software (such as MS Excel).

### Types of Data Written to CSV Files

	Tag name	Description	Set value
(1)	<net-param>		
	<network-type>	The network type (CLK/SLK).	CLK network: CLK SLK network: SLK
	<cycletime>	The communications cycle time.	5 to 255. Enabled only when <network-type> is set to SLK, and ignored when <network-type> is set to CLK. An error will be generated if an out-of-range value is set when a file is loaded.
	<author>	The name of the author SLK: (Table information) author	Set any text string (with up to 30 characters). Enabled only when <network-type> is set to SLK.
	<information> (Title or node information)	Input file information. CLK: Node information SLK: (Table information) title	Set any text string (with up to 30 characters).
	<comment>	Comment. SLK: (Table information) comment	Set any text string (with up to 255 characters). Enabled only when <network-type> is set to SLK, and ignored when <network-type> is set to CLK.

**4-3 Manually Setting Data Links**  
**4-3-9 Creating, Reading, and Writing CSV Files (Saving)**

	Tag name	Description	Set value
(2)	<node-param>	<node> (Node No.)	The node No. for the link.  1 to 62. An error will be generated if an out-of-range value is set when a file is loaded.
		<cpu> (PLC type)	The PLC type for the node.  CS1G, CS1G-H, CS1H, CS1H-H, CJ1G, CJ1G-H, CJ1H-H-R, CJ1H-H, CJ1M, CP1H, CS1D-H, CS1D-S, CV500, CV1000, CV2000, CVM1, CVM1-V2, CQM1H, C200HE, C200HE-Z, C200HG, C200HG-Z, C200HX, C200HX-Z, NSB, CS/CJ
		<cpu-type> (CPU model)	The CPU model for the node.  CS1G: CPU42, CPU43, CPU44, CPU45 CS1G-H: CPU42, CPU43, CPU44, CPU45 CS1H: CPU63, CPU64, CPU65, CPU66, CPU67 CS1H-H: CPU63, CPU64, CPU65, CPU66, CPU67 CS1G/CJ1G: CPU44, CPU45 CJ1G-H: CPU42, CPU43, CPU44, CPU45 CJ1H-H-R: CPU64, CPU65, CPU66, CPU67 CJ1H-H: CPU65, CPU66, CPU67 CJ1M: Not specified. CS1D-H: CPU65, CPU67 CS1D-S: CPU42, CPU44, CPU65, CPU67 CV500: Not specified. CV1000: Not specified. CV2000: Not specified. CVM1: CPU01, CPU11, CPU21 CVM1-V2: Not specified. CQM1H: CPU51, CPU61 C200HE: Not specified. C200HE-Z: Not specified. C200HG: Not specified. C200HG-Z: Not specified. C200HX: Not specified. C200HX-Z: Not specified. C200HX-Z: CPU65, CPU85 NSB: Not specified. CS/CJ: Not specified.
		<status-start-type> (Status start address, memory area)	The status start address and the memory area.  Any of the following memory areas can be specified, regardless of the PLC type. Initial value: Default (See note.) CIO: Blank, CIO, or IR DM: D or DM LR: L or LR EM: E + Bank No. HR: H or HR AR: A or AR T/C: T/C Note: Data link status is stored in the default area. For details, refer to the Unit's operation manual.
	<status-start-ch> (Status area start address)	The start address for the status area.  The range differs depending on the status area type.	

**4-3 Manually Setting Data Links**  
**4-3-9 Creating, Reading, and Writing CSV Files (Saving)**

	<b>Tag name</b>	<b>Description</b>	<b>Set value</b>		
(3)	<area1>	<start-type> (Link Area 1 type)	Specify the area type for Link Area 1.	Same as for status area type.	
		<start-ch> (Link Area 1 start address)	The beginning word for Link Area 1.	Same as for status area start address.	
	<link-area>	Node No.	Node address	The node address for linking at Link Area 1.	1 to 62
		Link start address	Link word	The beginning link word for Link Area 1.	Set the link start address + link size for the above link node.
		Link size	Size (Unit: words)	The link size for Link Area 1.	Set any value.
Offset size	Offset	The offset size for Link Area 1.	Set any value. If no offset is required, set 0.		
(4)	<area2>	<start-type> (Link Area 2 type)	The area type for Link Area 2.	Same as for status area type.	
		<start-ch> (Link Area 2 start address)	The beginning word for Link Area 2.	Same as for status area start address.	
	<link-area>	Node No.	Node address	The node address for linking at Link Area 2.	1 to 62
		Link start address	Link word	The beginning link word for Link Area 2.	Set the link start address + link size for the above link node.
		Link size	Size (Unit: words)	The link size for Link Area 2.	Set any value.
Offset size	Offset	The offset size for Link Area 2.	Set any value. If no offset is required, set 0.		

### 4-3 Manually Setting Data Links

#### 4-3-9 Creating, Reading, and Writing CSV Files (Saving)

An example text data configuration for a CSV file is shown below.

```
<net-param>
<network-type>,SLK
<cycletime>,0
<author>,
<information>,
<comment>,
</net-param>
<node-param>
<node>,,1,,,2,,,3,,,
<cpu>,,CS/CJ,,,CS/CJ,,,CS/CJ,,,
<status-start-type>,,,,,,,,,
<status-start-ch>,,00000,,,00000,,,00000,,,
</node-param>
<area1>
<start-type>,,,,,,,,,
<start-ch>,,00000,,,01200,,,00300,,,
<link-area>,,1,01000,30,,1,01200,30,,1,00300,30,
<link-area>,,2,01030,30,,2,01230,30,,2,00330,30,
<link-area>,,3,01060,10,,3,01260,10,,3,00360,10,
</area1>
<area2>
<start-type>,,D,,,D,,,D,,,
<start-ch>,,00500,,,00600,,,00700,,,
<link-area>,,1,D00500,30,,1,D00600,30,,1,D00700,30,
<link-area>,,2,D00530,30,,2,D00630,30,,2,D00730,30,
<link-area>,,3,D00560,40,,3,D00660,40,,3,D00760,40,
</area2>
```

Note: Commas are used for delineation. (They are added when there are blank cells.)

## 4-3 Manually Setting Data Links

### 4-3-10 Reading and Data Link Tables

#### 4-3-10 Reading and Data Link Tables

After a data link table has been created, follow the procedure below for reading it.

- 1 Select **Network - Work Online** or **Network - Auto Online** from the menu bar to connect online to the target PLC.
- 2 Right-click the Controller Link Unit or SYSMAC LINK Unit in the Online Connection Information Window and select **Start Data Link** from the popup menu. Either the Datalink Component (Controller Link) or Datalink Component (SYSMAC LINK) Window will be displayed.

Note: **Start Data Link** cannot be selected if there is not a Controller Link Unit or SYSMAC LINK Unit mounted in the PLC that is connected online.

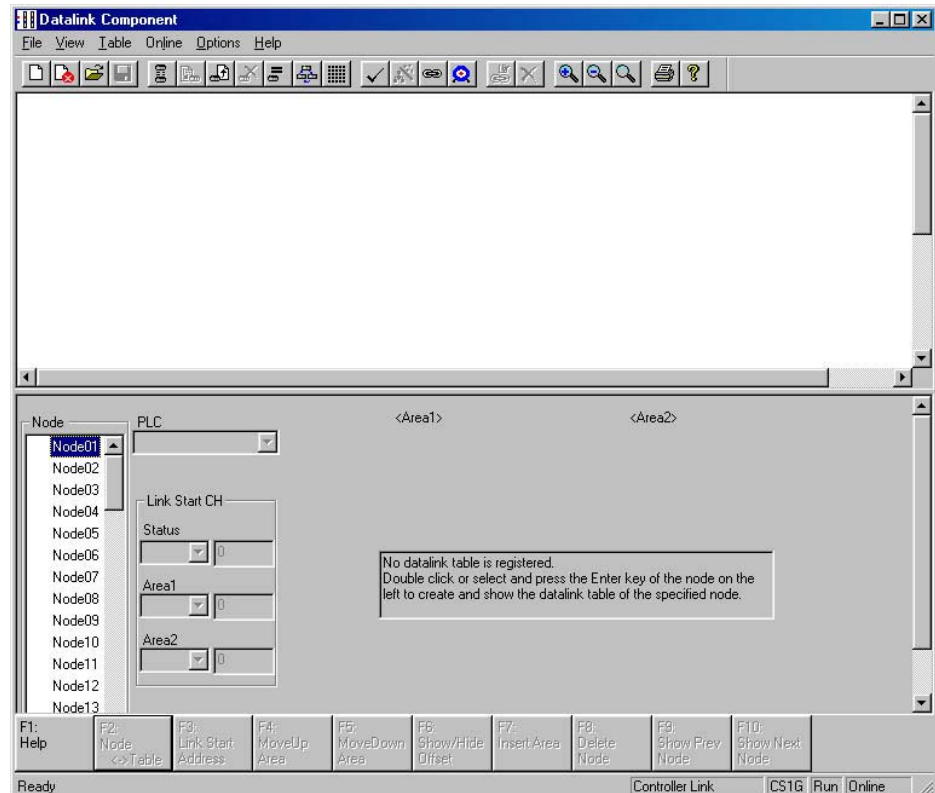

- 3 Select **File - Open**.  
The Open Dialog Box will be displayed.
- 4 Select the data link table file (Sample.cl2 in this example) and then click the **Open** Button.

## 4-3 Manually Setting Data Links

### 4-3-10 Reading and Data Link Tables

The data link tables will be read as shown below.

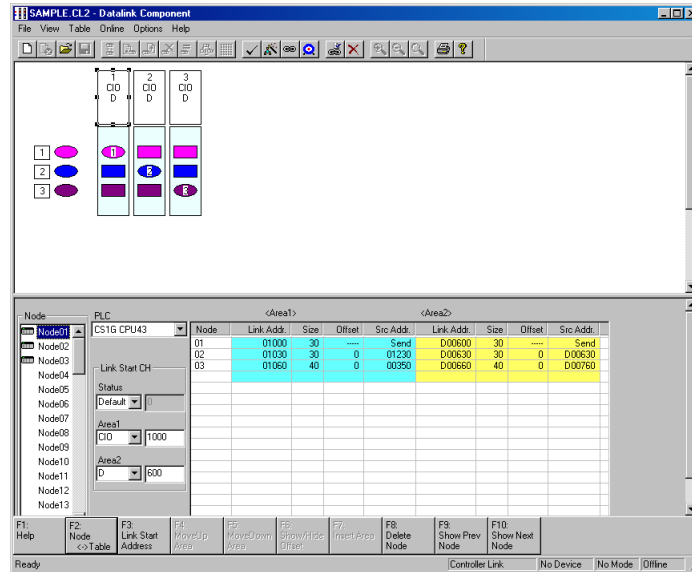

**Note:** Be careful of the following point when reading a SYSMAC LINK data link table file (.slk extension) created by SYSMAC LINK Support Software.  
 With SYSMAC LINK data link table files created by SYSMAC LINK Support Software (SLK files), there is no distinction made between C200H and CV-series PLC models.  
 Immediately after opening an SLK file, be sure to set the PLC model for each node. Then save the file as a default data link table file (.sl2 extension).

## 4-3 Manually Setting Data Links

### 4-3-11 Transferring the Data Link Table

#### 4-3-11 Transferring the Data Link Table

There are two methods that can be used to transfer data link tables.

- Transfer data link tables to all PLC nodes on the network at the same time.
- Transfer data link tables to an individual PLC node on the network at the same time.

##### Transferring to All Nodes on the Network

- 1 Select **Set All Nodes for Network Operation** from the Datalink Component's Online Menu. Selecting this operation allows the data link tables to be transferred simultaneously to multiple PLCs.

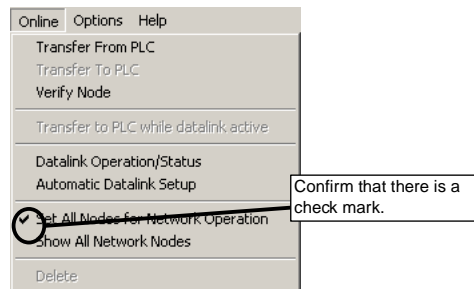

- 2 Select **Online - Transfer to PLC**. The following dialog box will be displayed.

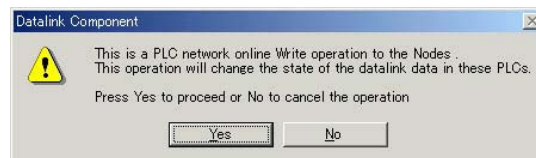

- 3 Click the **Yes Button**.  
An error list will be displayed.

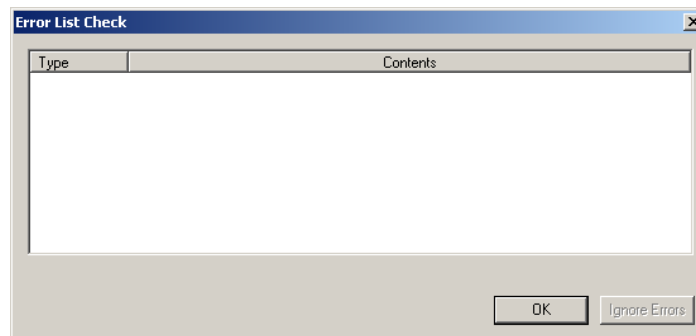

- 4 If there are no errors, click the **OK Button**. The data link tables will be transferred to all PLC nodes and then the transfer results will be displayed.

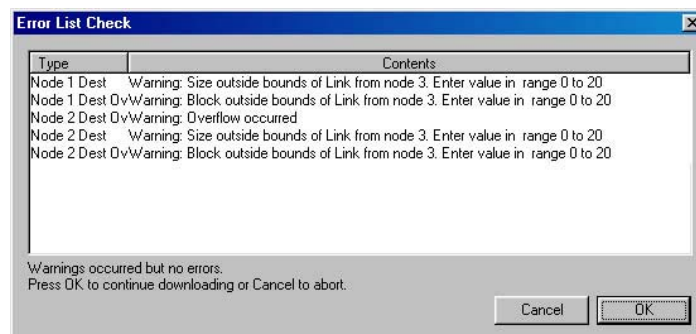



Operation If Errors Are Displayed

<b>OK</b> Button clicked	The data link tables will not be transferred.
<b>Ignore Errors</b> Button clicked	An error message will be displayed if a node does not actually exist on the network. If the Ignore Errors Button is clicked, data link tables will be transferred to the nodes that do exist.

- Using CX-Integrator Ver. 2.0 or Higher for a Controller Link Network: Confirming Data Link Modes (Automatic/Manual) When Transferring Data Link Tables  
 The following dialog box for confirming data link modes will be displayed when the OK Button is clicked after completing data link table transfer.

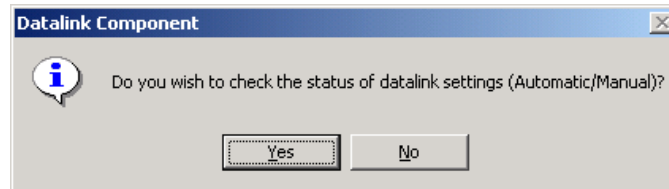

- 1 Click the **Yes** Button to confirm the data link mode settings.  
 The data link mode setting will be read from all nodes on the network.  
 Note: If a local network table has not been registered (i.e., if the network address is 0), a Unit Selection Dialog Box will be displayed. If that occurs, select the Controller Link Unit on the required network.
  - 2 The following dialog box will be displayed showing the data link mode settings.
- The following dialog box shows that all nodes are set to the same mode.

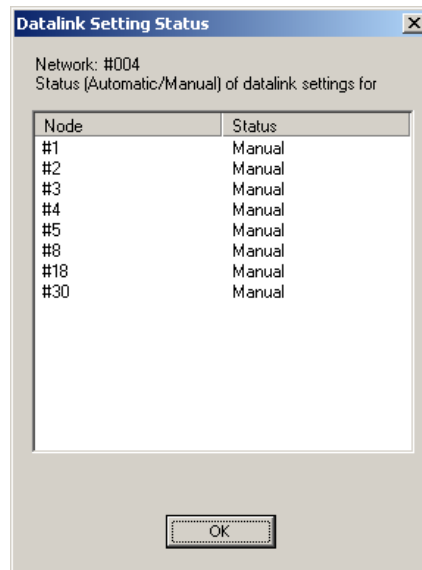

- The following dialog box shows that the data link mode settings could not be read.

## 4-3 Manually Setting Data Links

### 4-3-11 Transferring the Data Link Table

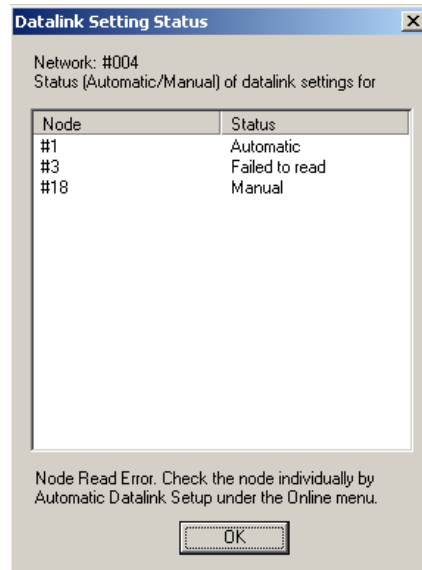

- The following dialog box shows that not all nodes have the same setting.

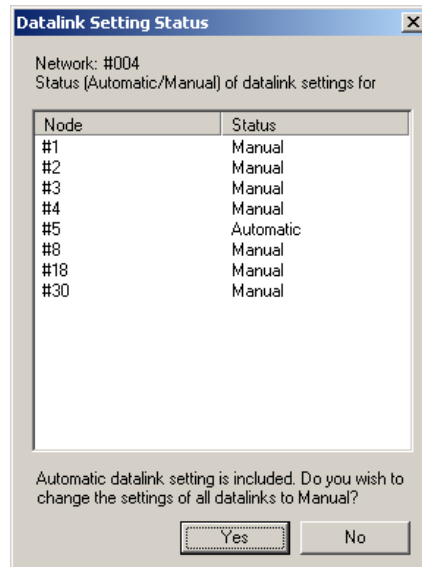

- 3 If the mode settings are mixed, the **Yes** Button can be clicked to set all nodes to manual data links. In this example, the node set for automatic data links will be changed to manual data link mode.

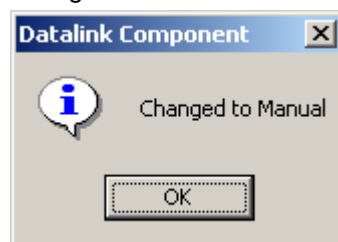

The following message will appear if the data link mode could not be changed for a node.

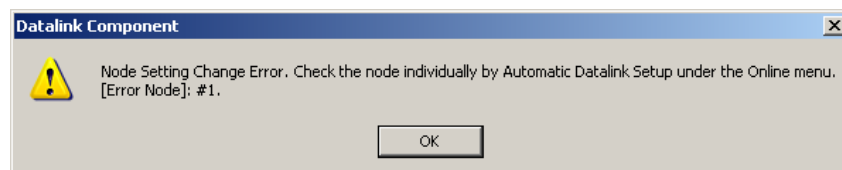

Change the setting individually for this node.

## 4-3 Manually Setting Data Links

### 4-3-11 Transferring the Data Link Table

**Note:** As long as all the data link tables can be transferred to all of the PLCs attempted, Set All Nodes for Network Operation can be selected to transfer the data link tables simultaneously to multiple PLCs. If there are any PLCs with the power turned OFF, or with disconnected cables, use the following method to transfer the data link table to one PLC at a time.

#### Transferring to Individual Nodes on the Network

- 1 Make sure that **Set All Nodes for Network Operation** is not selected in the Online Menu.

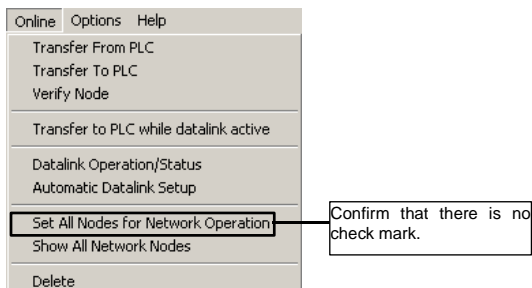

- 2 Select the transfer destination node address from the Node list in the Datalink Component.

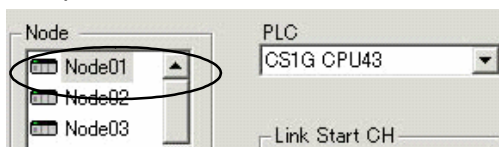

- 3 Select **Online - Transfer to PLC**. The following dialog box will be displayed.

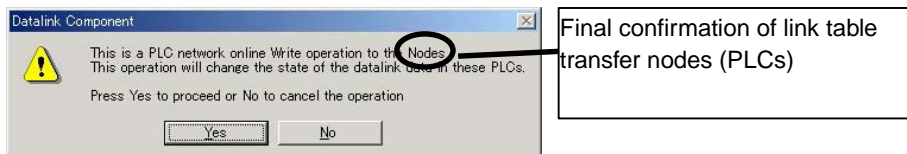

- 3 Click the **Yes** Button.
- 4 The data link tables will be transferred to node 2.
- 5 The transfer results will be displayed. Click the **OK** Button.

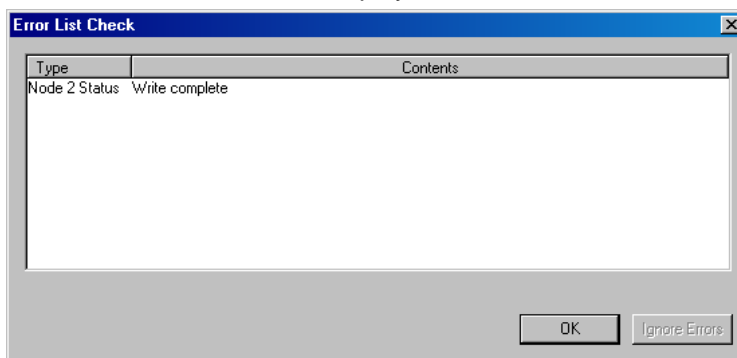

The following dialog box for confirming data link modes will be displayed when the **OK** Button is clicked after completing data link table transfer using CX-Integrator version 2.0 or higher for a Controller Link Network.

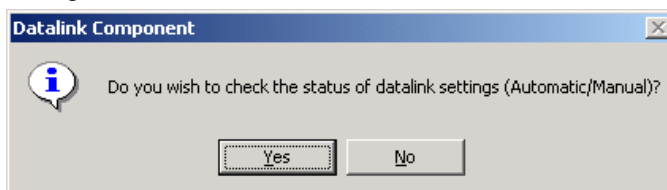

1. Click the **Yes** Button to confirm the data link mode settings. The data link mode setting will be read from all nodes on the network.

## 4-3 Manually Setting Data Links

### 4-3-11 Transferring the Data Link Table

2. Confirm the data link mode settings according to the mode setting status in the same way as previously described for transferring data links to all nodes on a network.

#### Changes in Transferring Data Link Tables during Data Link Operation

Nodes can be added while data links are running if the following Controller Link Units/Boards and Repeater Units (CS1W-RPT01) are used (CX-Programmer version 3.2 or higher).

- CS1W-CLK21-V1
- CS1W-CLK12-V1
- CS1W-CLK52-V1
- CJ1W-CLK21-V1
- 3G8F7-CLK21-V1(-EV1)
- 3G8F7-CLK12-V1(-EV1)
- 3G8F7-CLK52-V1(-EV1)

Note: Refer to the *Controller Link Operation Manual* for the procedure to add nodes and details on changing data link tables while data links are running.

Use the following procedure to transfer data link tables while data links are running.

1. Create the new data link tables offline and save them in a file.
2. Place the CX-Integrator online with the PLC.
3. Select **Tools - Start Data Link** from the menu bar. The Data Link Component will be displayed.
4. Open the data link table file saved in step 1, above.
5. Select the node for which the data link table is to be changed.
6. Select **Online - Transfer to PLC while datalink active** from the menu bar. The following dialog box will be displayed.

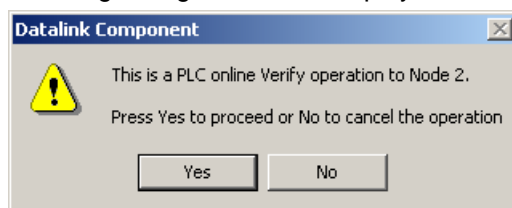

7. Click the **Yes** Button.

Yes Button	The data link tables open on the CX-Integrator will be compared with the data link tables in the node to be changed.
No Button	The data link tables will not be compared.

The results of comparison will be displayed in the following dialog box.

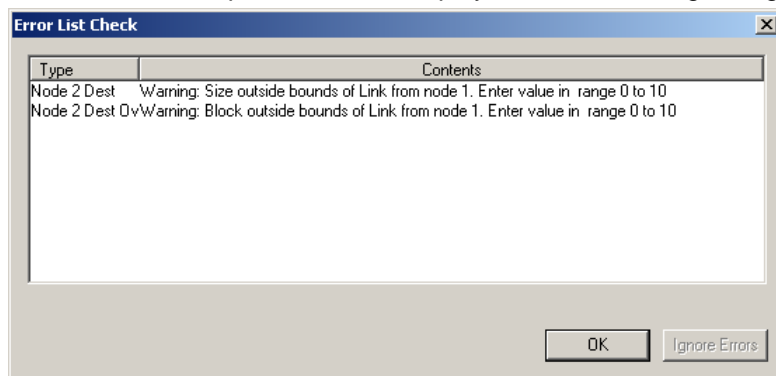

Click the **OK** Button to check the differences. The differences between the data link tables open in the CX-Integrator and the data link tables in the node to be changed will be displayed.

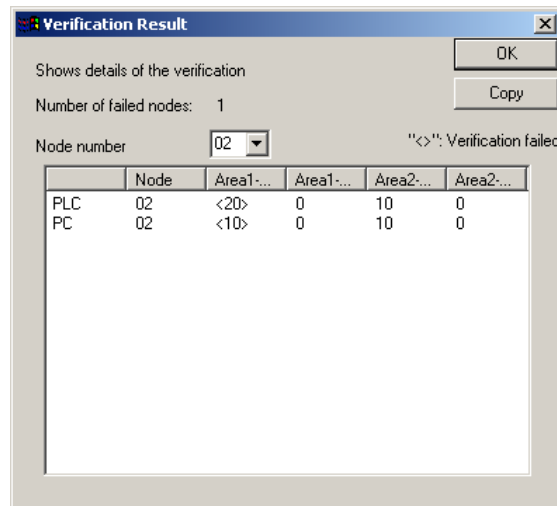

8. Check the difference to be sure they are appropriate and then click the **OK** Button. A dialog box will be display to confirm data link table transfer.

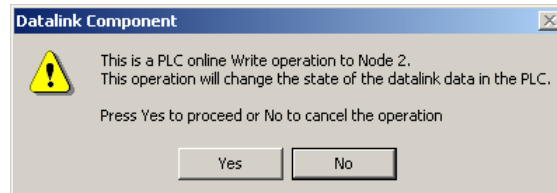

9. Click the **Yes** Button. The data link tables will be transferred. If the **No** Button is clicked, the transfer will be canceled. (The data link tables currently running will not be changed. The following dialog box will be displayed if the transfer is completed normally.



**Note** Transfer the data link tables for only one node at a time when the data links are running.

If **Online - Transfer to PLC** has been selected, the following dialog box will be displayed. Clear the selection and repeat the procedure.

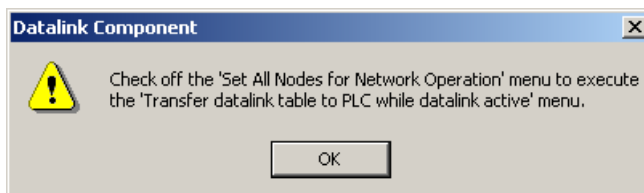

### **Comparing Data Link Tables**

1. In the node list in the Data Link Component, select the node address of the PLC for which data link tables are to be compared with those in the computer.
2. Be sure that **Online - Set All Nodes for Network Operation** is not selected.
3. Select **Online - Verify Node**. The following dialog box will be displayed.

## 4-3 Manually Setting Data Links

### 4-3-11 Transferring the Data Link Table

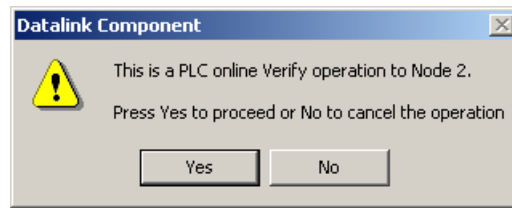

4. Click the **Yes** Button.  
A message will appear to tell you if there are any differences between the two sets of data link table.
5. If differences are found and the **OK** Button is clicked, the Verification Result Dialog Box will be displayed.

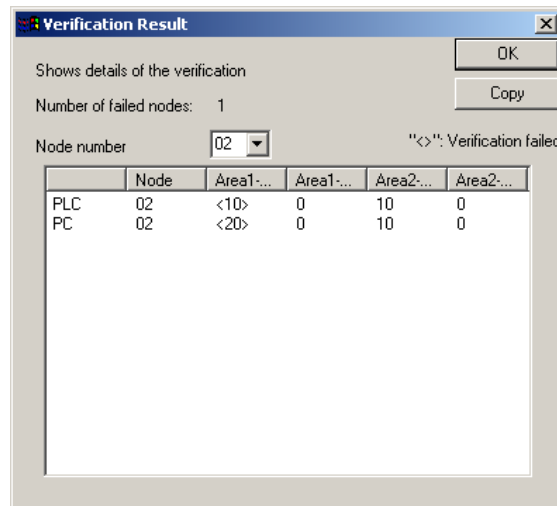

Select the node address to display the data link area data for both the PLC and in the computer for the specified node address: Area 1 Size, Area 1 Offset, Area 2 Size, and Area 2 Offset. The size of this dialog box can be changed. The data for the PLC is display on top and that for the computer (i.e., the data being edited on the CX-Integrator) is displayed on bottom. Inconsistencies are displayed between pointed brackets < >.

Click the **Copy** Button to place a copy of the verification results on the clipboard for use in other programs, e.g., text editors, as shown below.

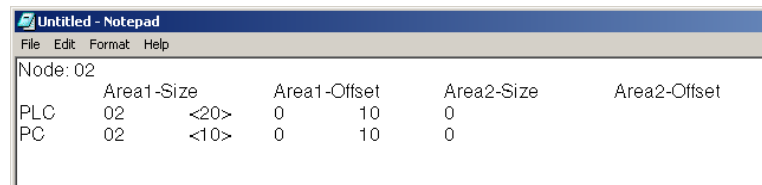

## 4-3-12 Starting and Stopping Data Links (Including Status Displays)

Before performing the operations described below, connect online to a node where the data link table has been transferred. As long as the data link table is stored there, data link starting and stopping can be executed from any node.

**Note** When starting data links with manual setup, the data link mode for the startup node must be set to manual.

### Starting Data Links

- 1 Select **Tools - Start Data Link** from the menu bar. The Select Network Dialog Box will be displayed. (For local network only, i.e., when network address is 0.)

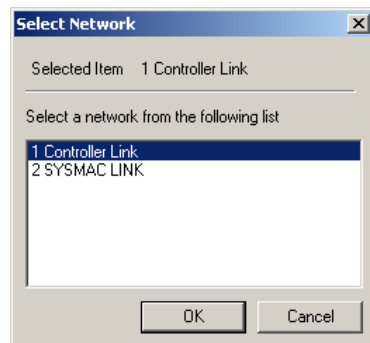

- 2 Select *Controller Link* or *SYSMAC LINK*, and then click the **OK** Button. Either the Datalink Component (Controller Link) or Datalink Component (SYSMAC LINK) Window will be displayed.

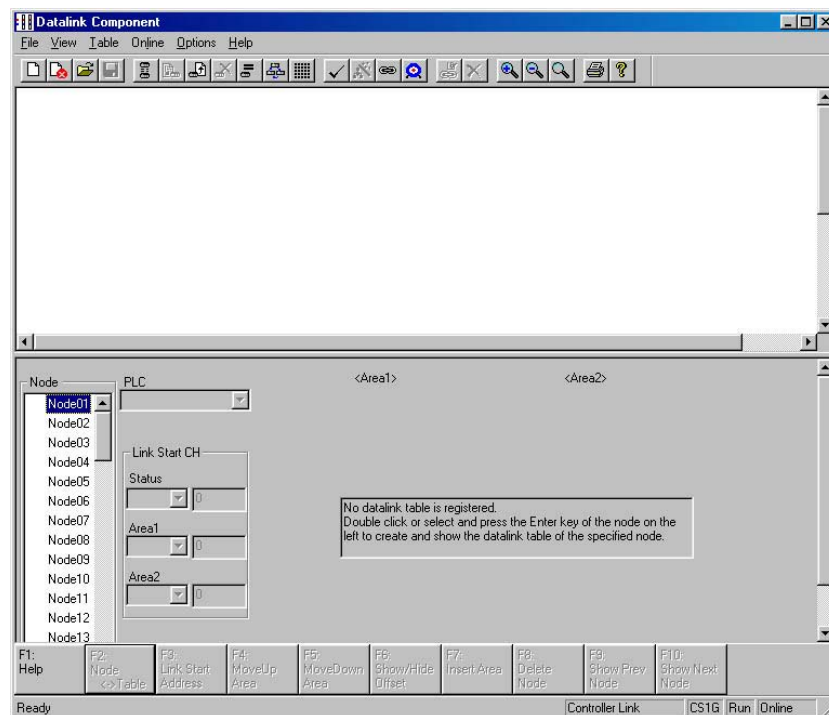

## 4-3 Manually Setting Data Links

### 4-3-12 Starting and Stopping Data Links (Including Status Displays)

- 3 Select **Online - Datalink Operation/Status** from the menu bar.  
The Datalink Status Dialog Box will be displayed. As shown below, the status of various items is displayed. The communications cycle time and refresh cycle time are updated only when this window is opened or when the PLC operating status is changed.

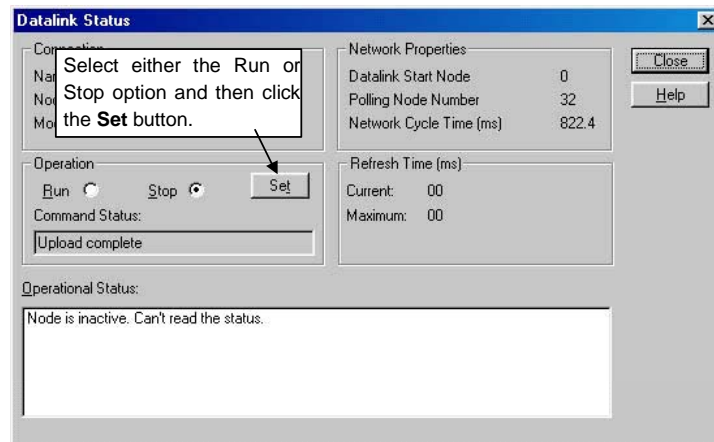

- 4 Select the *Run* Option in the *Operation* Field.
- 5 Click the **Set** Button.  
The data links will start, and the Operational Status box will be displayed.

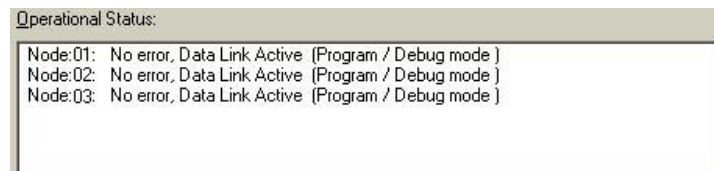

#### Note

- The data link mode (manual/automatic) and data link operation are determined by the data link setup at the startup node. With manual setting the links, it is necessary to set, for the startup node, the data link table and the data link mode (manual setting) in the DM parameter area. If these are not set correctly, the data links will not start.
- Check the following points before starting the data links.  
With manual setting, the appropriate data link table must be set for each node executing the data links. Data link tables must be deleted for nodes that are not participating in the data links. Also, even when the correct data link tables are set, make sure that there will be no effect on the equipment before starting or stopping the data links.

### Stopping Data Links

- 1 Click the *Stop* Option in the *Operation* Field in the Datalink Status Dialog Box.
- 2 Click the **Set** Button.  
The data links will be stopped.



## 4-4 Automatically Set Data Links

This section explains how to make the settings for automatically set data links. Make the settings in the Automatic Datalink (Controller Link) or Automatic Datalink (SYSMAC LINK) Dialog Box.

First make the settings for data link operation at PLC startup, and for the automatic data link setup parameters, and then transfer the data to the startup node.

When using automatically set data links, there is no need to create data link tables with the Data Link Editor.

Note: With CX-Programmer Ver.6.0 or higher, data links can also be set by setting parameters for automatically set data links in the Special I/O Unit settings in the I/O Table Window.

### 4-4-1 Procedure Through Data Link Startup

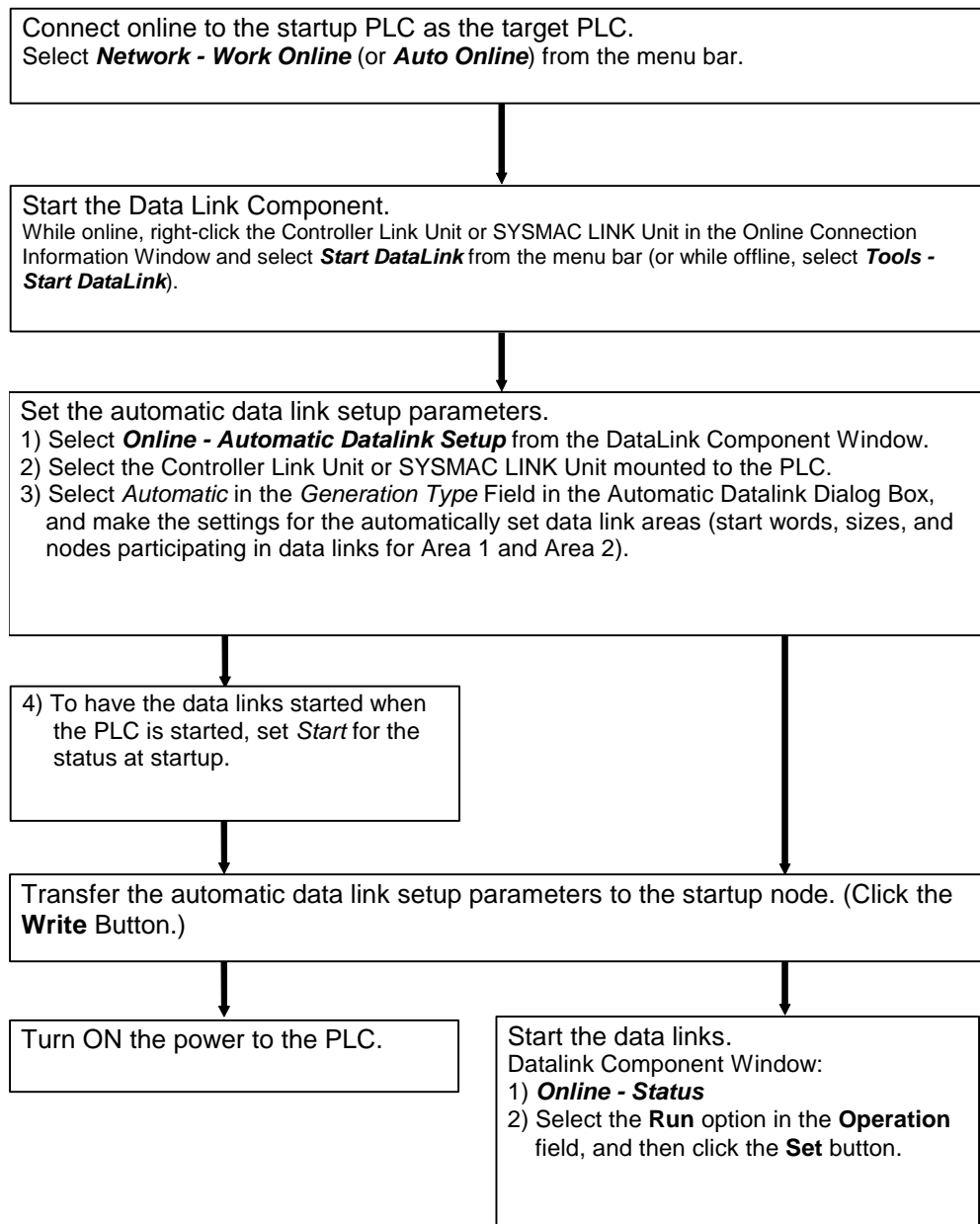

## 4-4 Automatically Set Data Links

### 4-4-2 Controller Link Automatic Setup

#### 4-4-2 Controller Link Automatic Setup

- 1 Before executing the following operations, connect online to the PLC that is serving as the startup node (making it the target PLC).

Select **Network - Work Online** or **Network - Auto Online** from the menu bar.

- 2 Right-click the Controller Link Unit or SYSMAC LINK Unit in the Online Connection Information Window and select **Start Data Link** from the popup menu. Either the Datalink Component (Controller Link) or Datalink Component (SYSMAC LINK) Window will be displayed.

Note: **Start Data Link** cannot be selected if there is not a Controller Link Unit or SYSMAC LINK Unit mounted in the PLC that is connected online.

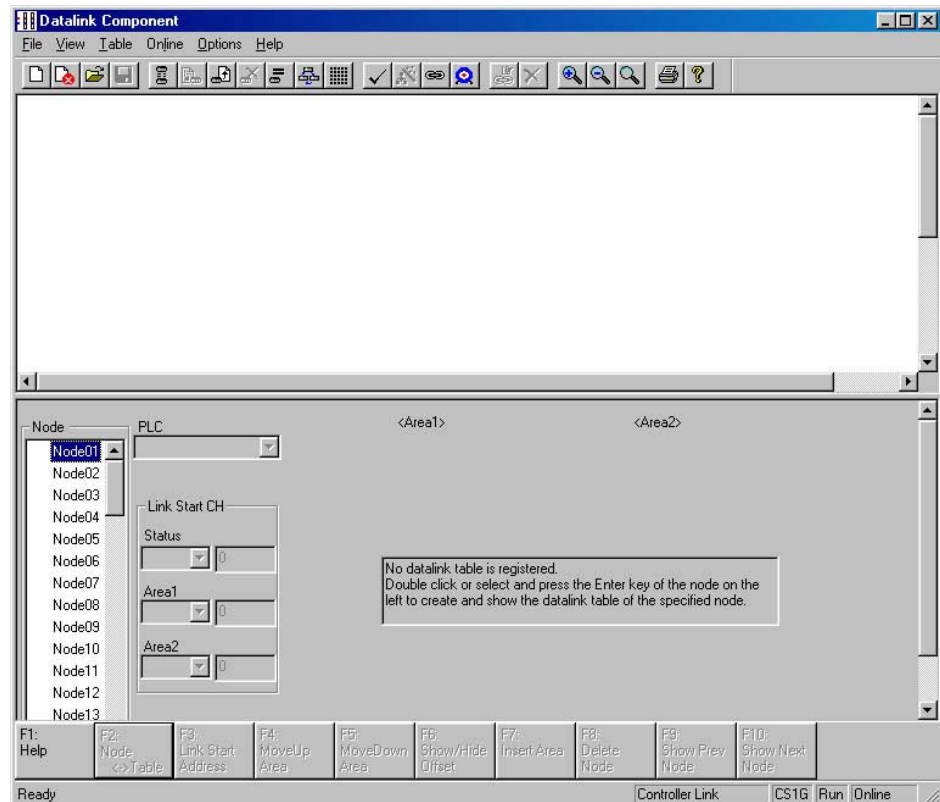

- 3 Select **Automatic Datalink Setup** from the Online Menu.

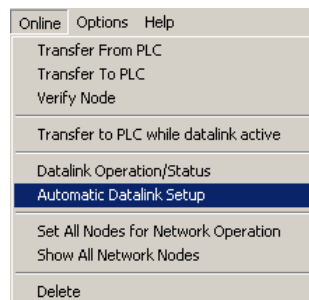

The Automatic Datalink Dialog Box will be displayed.

## 4-4 Automatically Set Data Links

### 4-4-2 Controller Link Automatic Setup

Set the following items.

Setting field	Setting
Generation Type	Select <i>Automatic</i> .
Automatic Datalink Type	Select <i>Equality layout</i> , <i>Common type</i> , <i>1 to 1 type</i> , or <i>Chain type</i> to set the data link areas. Refer to <i>Automatically Set Data Link Areas</i> for details.
Power Up Run State	Select <i>Start</i> or <i>Stop</i> . Select <i>Start</i> to automatically start the data links when power is turned ON without performing a specific startup operation. If <i>Start</i> is set, it will be set in the Controller Link startup node.
Automatic Data Link Area	

### Automatically Set Data Link Areas

If the following Controller Link Units/Support Boards are used, data links can be set between a master and slaves using 1:N allocations. Any of the following four link patterns can be used.

• Equality (same a previous automatic settings)
• Common type
• 1 to 1 type
• Chain type

Applicable Models:

• CS1W-CLK21-V1	• 3G8F7-CLK21-V1(-EV1)
• CS1W-CLK12-V1	• 3G8F7-CLK12-V1(-EV1)
• CS1W-CLK52-V1	• 3G8F7-CLK52-V1(-EV1)
• CJ1W-CLK21-V1	

Note: Automatically set 1:N allocations are not possible for any models other than those listed above. Refer to the *Controller Link Unit Operation Manual* for details.

## 4-4 Automatically Set Data Links

### 4-4-2 Controller Link Automatic Setup

#### Equality Layout (Previous Method)

This is the previous automatic data link type where all nodes are allocated the same sizes of data links.

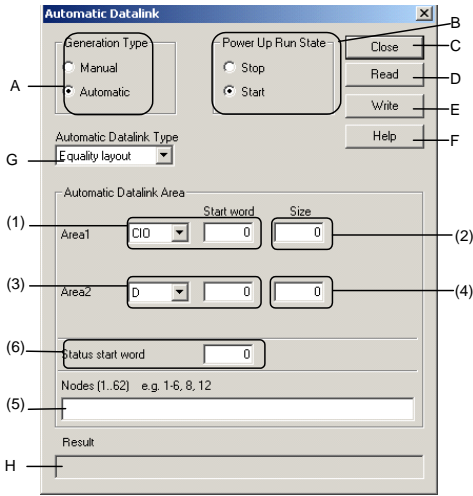

#### Settings Common to All Automatic Data Link Types

No.	Item	Description of function
A	Generation Type	Select <b>Automatic</b> . (If <i>Manual</i> is selected, data links will be run using data link tables set separately.)
B	Power Up Run State	Select <b>Start</b> to automatically start data links when power is turned ON to the PLC.
C	Close	Closes the <i>Automatic Datalink</i> Dialog Box.
D	Read	Reads the settings from the PLC.
E	Write	Writes the settings to the PLC. (If the <i>Power Up Run State</i> is set to <i>Start</i> , the data links will start running when the settings are written to the PLC.)
F	Help	Displays help.
G	Automatic Datalink Type	Select the type of data links to be automatically set up from the following. Equality Layout (Previous method) Common Type (1:N settings) 1 to 1 Type (1:N settings) Chain Type (1:N settings)
H	Result	The status is displayed when the Read or Write Button is clicked.

#### Equality Layout Settings

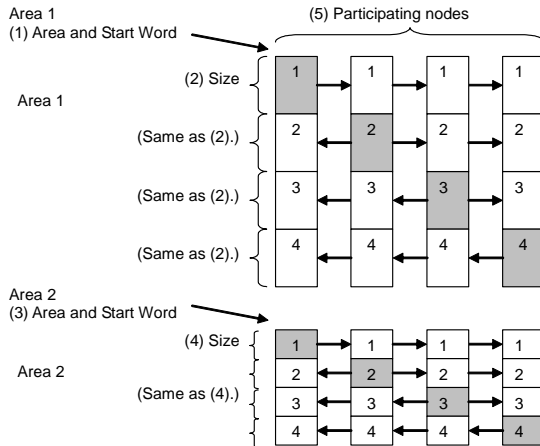

No.	Item	Description of function
(1)	Area and Start Word for Area 1	Set the area and the start data link word to use for area 1.
(2)	Size of Area 1	Set the send size per node for area 1.
(3)	Area and Start Word for Area 2	Set the area and the start data link word to use for area 2.
(4)	Size of Area 2	Set the send size per node for area 2.
(5)	Nodes	Set the nodes to participate in the data links.
(6)	Status start word	Set the first word to store data link status. (If 0 words is set, the default area will be used.)

#### Features of Equality Layout

- The send data sizes is the same for all nodes for each area.
- Area 1 is selected from the bit-access areas (e.g., CIO Area) and area 2 is selected from word-access areas (e.g., DM Area).
- Data link areas are allocated in ascending order of node addresses.
- Data link participation can be specified for each node.
- The same data link areas are shared by all nodes participating in the data links.

## 4-4 Automatically Set Data Links

### 4-4-2 Controller Link Automatic Setup

#### Common Type

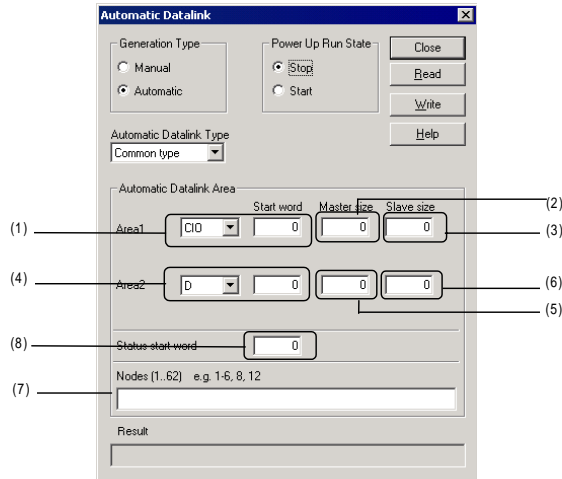

#### Common Type Settings

No.	Item	Description of function
(1)	Area and Start Word for Area 1	Set the area and the start data link word to use for area 1.
(2)	Master size	Set the area 1 send size for the master node.
(3)	Slave size	Set the area 1 send size for the slave node.
(4)	Area and Start Word for Area 2	Set the area and the start data link word to use for area 2.
(5)	Master size	Set the area 2 send size for the master node.
(6)	Slave size	Set the area 2 send size for the slave node.
(7)	Nodes	Set the nodes to participate in the data links.
(8)	Status start word	Set the first word to store data link status. (If 0 words is set, the default area will be used.)

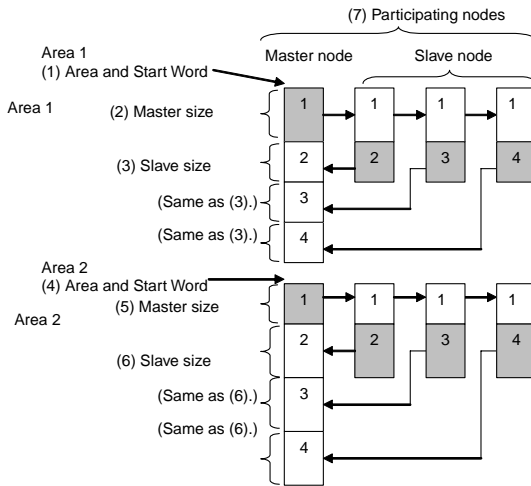

#### Features of Common Type 1:N Allocation

- Data communications are 1:1 between the master node and slave nodes.
- All slave nodes receive the data sent by the master node.
- The master node receives all data sent by the slaves. The reception size for the master node is thus the node send data size times the number of slave nodes.
- Slaves do not send or receive data with other slaves.
- Area 1 is selected from the bit-access areas (e.g., CIO Area) and area 2 is selected from word-access areas (e.g., DM Area).
- Data link areas are allocated in ascending order of node addresses.
- Data link participation can be specified for each node.
- The same area classification can be used for both Area 1 and Area 2, provided that the same addresses are not used (CS/CJ-series Controller Link Units with unit Ver. 1.2 or later).

#### 1 to 1 Type

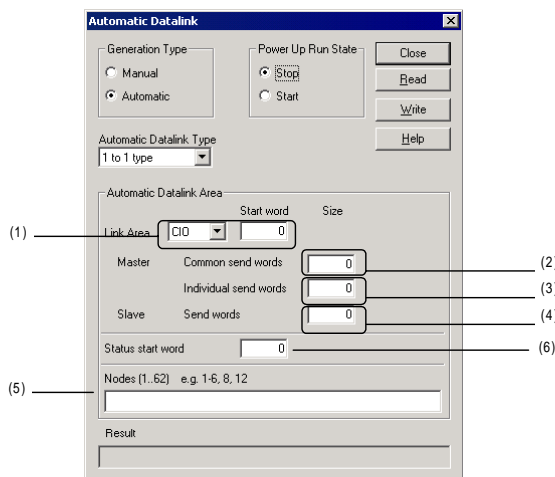

#### 1 to 1 Type Settings

No.	Item	Description of function
(1)	Link Area and Start Word	Set the area and start data link word.
(2)	Master, Common Send Words	Set the send size of the data to send from the master node to all slave nodes. The same size of data is sent to all nodes.
(3)	Master, Individual Send Words	Set the send size for the master node to send individually to each slave node.
(4)	Slave, Send Words	Set the send size of the data sent from each slave node to the master node.
(5)	Nodes	Set the nodes participating in the data links.
(6)	Status start word	Set the start word to store data link status. (If 0 words is set, the default area will be used.)

## 4-4 Automatically Set Data Links

### 4-4-2 Controller Link Automatic Setup

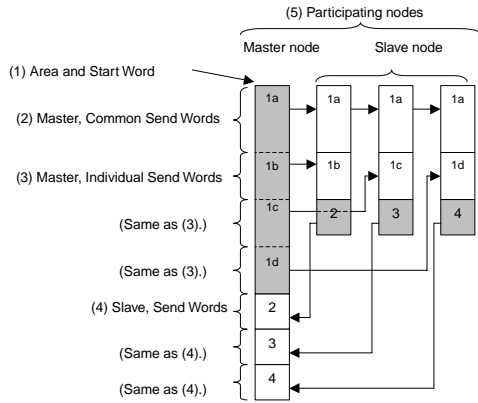

#### Features of 1 to 1 Type 1:N Allocation

- Data communications are 1:1 between the master node and slave nodes.
- All slave nodes receive part of the data sent by the master node. In addition, each slave node receives unique data from the master node (see a to d in figure).
- The master node receives all data sent by the slaves. The data sizes are fixed for all nodes.
- Slaves do not send or receive data with other slaves.
- One area is selected from the bit-access areas (e.g., CIO Area) or word-access areas (e.g., DM Area).
- Data link areas are allocated in ascending order of node addresses.
- Data link participation can be specified for each node.

## Chain Type

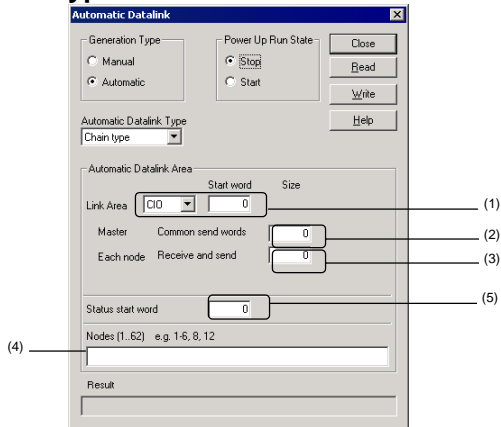

#### Chain Type Settings

No.	Item	Description of function
(1)	Link Area and Start Word	Set the area and the start data link word.
(2)	Master, Common Send Words	Set the send size of the data to send from the master node to all slave nodes. The same size of data is sent to all nodes.
(3)	Each Node, Receive and Send	Set the send size of data for each node to send to the next node.
(4)	Nodes	Set the nodes participating in the data links.
(5)	Status start word	Set the start word to store data link status. (If 0 words is set, the default area will be used.)

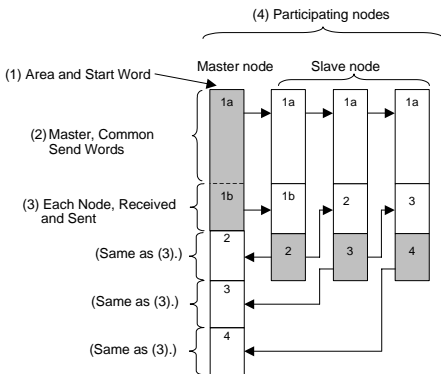

#### Features of Chain Type 1:N Allocation

- Data communications are 1:1 between the master node and slave nodes.
- All slave nodes receive part of the data sent by the master node (1a in figure).
- The master node receives all data sent by the slaves. The data sizes are fixed for all nodes.
- Each slave nodes receives data from the previous node and then sends data to the next node. Data is thus passed in ascending order of the nodes participating in the data link.
- One area is selected from the bit-access areas (e.g., CIO Area) or word-access areas (e.g., DM Area).
- Data link areas are allocated in ascending order of node addresses.
- Data link participation can be specified for each node.

### 4-4-3 SYSMAC LINK Automatic Setup

- 1 Before executing the following operations, connect online to the PLC that is serving as the startup node (making it the target PLC).  
Select **Network - Work Online** or **Network - Auto Online** from the menu bar.
- 2 Right-click the SYSMAC LINK Unit in the Online Connection Information Window and select **Start Data Link** from the popup menu. The SYSMAC LINK Datalink Component Window will be displayed.  
Note: **Start Data Link** cannot be selected if there is not a Controller Link Unit or SYSMAC LINK Unit mounted in the PLC that is connected online.

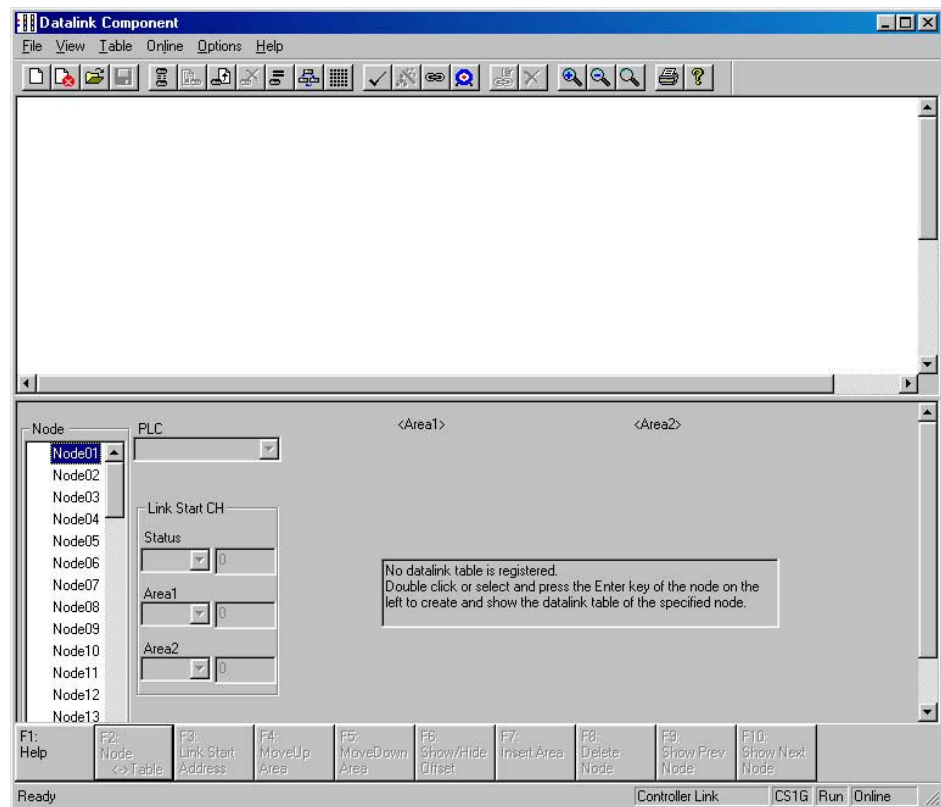

- 3 Select **Online - Automatic Datalink Setup** from the menu bar. The Automatic Datalink (SYSMAC LINK) Dialog Box will be displayed.

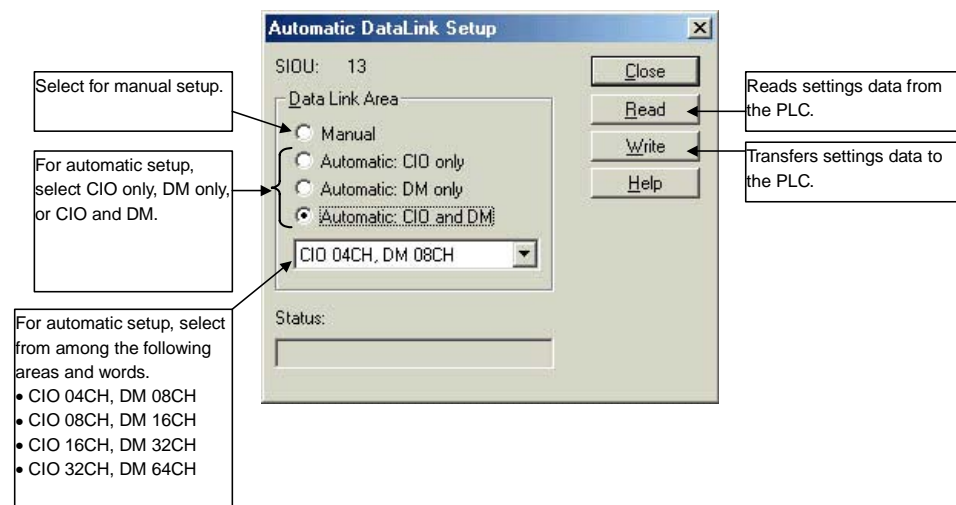

- 4 Select the memory area for automatic setup (CIO Area only, DM Area only, or CIO and DM Areas), and select the area and word settings from the following list.

## 4-4 Automatically Set Data Links

### 4-4-4 Transferring Automatic Data Link Setup Parameters to the Startup Node

**Note** Word Allocations for SYSMAC LINK Automatic Setup (Example: CS/CJ Series)

CIO Area (words)	DM Area (words)	Area and word settings			
		CIO: 4 words DM: 8 words	CIO: 8 words DM: 16 words	CIO: 16 words DM: 32 words	CIO: 32 words DM: 64 words
CIO 1000 to CIO 1003	D00000 to D00007	#1	#1	31	#1
CIO 1004 to CIO 1007	D00008 to D00015	#2			
CIO 1008 to CIO 1011	D00016 to D00023	#3			
CIO 1012 to CIO 1015	D00024 to D00031	#4	#2		
CIO 1016 to CIO 1019	D00032 to D00039	#5	#3		
CIO 1020 to CIO 1023	D00040 to D00047	#6			
CIO 1024 to CIO 1027	D00048 to D00055	#7	#4		
CIO 1028 to CIO 1031	D00056 to D00063	#8	#5		
CIO 1032 to CIO 1035	D00064 to D00071	#9			
CIO 1036 to CIO 1039	D00072 to D00079	#10	#3		
CIO 1040 to CIO 1043	D00080 to D00087	#11			
CIO 1044 to CIO 1047	D00088 to D00095	#12	#6		
CIO 1048 to CIO 1051	D00096 to D00103	#13	#7		
CIO 1052 to CIO 1055	D00104 to D00111	#14			
CIO 1056 to CIO 1059	D00112 to D00119	#15	#4		
CIO 1060 to CIO 1063	D00120 to D00127	#16			

### 4-4-4 Transferring Automatic Data Link Setup Parameters to the Startup Node

The automatic data link parameters that have been set are then sent to the connected startup node PLC. It is also possible to read the automatic data link parameters that have been set for the PLC.

#### Transferring Data to the Startup Node PLC

- 1 Click the **Write** Button in the Automatic Datalink Setup Dialog Box. The following dialog box will be displayed for confirmation.



- 2 Click the **Yes** Button. The set data will be transferred to the startup node PLC.



**Note**

- The data link mode (manual/automatic) and data link operation are determined by the data link setup at the startup node. With automatic setup, it is necessary to set, for the startup node, the data link mode (automatic) and the number of data link words in the Automatic Datalink Setup Dialog Box. If these are not set correctly, the data links will not start.
- Before starting the data links with automatic setup, make sure that the correct automatic data link setup parameters are set for the data link startup node. If incorrect automatic data link setup parameters are set, it may cause the equipment to operate unpredictably. Even when the correct parameters are set, make sure that there will be no adverse effect on the equipment before starting or stopping the data links.

### Reading Data from the Startup Node

Perform this operation to check or change settings.

- 1 Click the **Read** Button in either the Automatic Datalink (Controller Link) or the Automatic Datalink Setup Dialog Box.

The following dialog box will be displayed for confirmation.



- 2 Click the **Yes** Button.  
The set data will be transferred from the PLC and displayed at the Automatic Datalink (Controller Link) or the Automatic Datalink Setup Dialog Box.

## 4-4 Automatically Set Data Links

### 4-4-5 Monitoring Data Link Status

## 4-4-5 Monitoring Data Link Status

### Monitoring Data Link Status, Such as Communications Cycle Time

- 1 Select **Network - Work Online** from the menu bar to connect online.
- 2 Select **Tools - Start Data Link**.

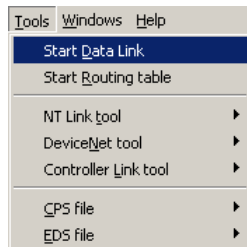

- 3 Select **Controller Link** or **SYSMAC LINK**, and then click the **OK** Button. The Datalink Component Dialog Box will be displayed.

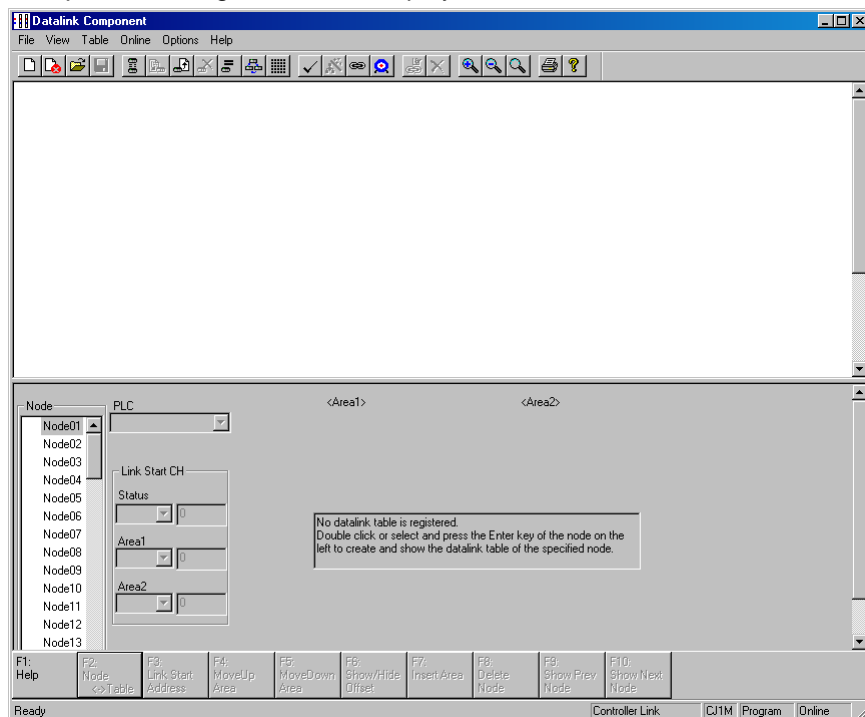

- 4 Select **Online – Datalink Operation/Status**. The Data Link Status Dialog Box will be displayed.

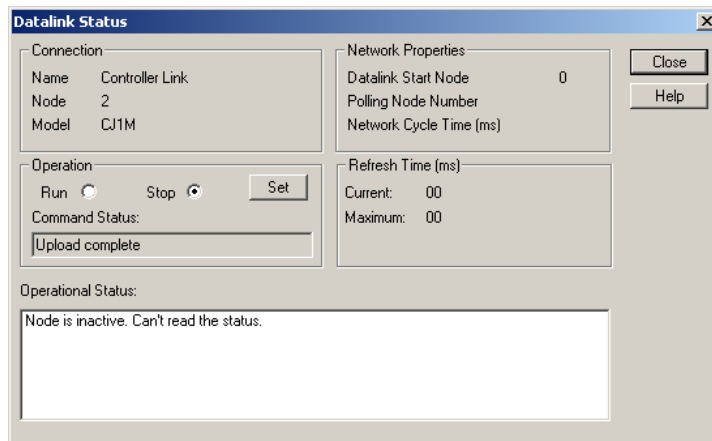

## 4-4 Automatically Set Data Links

### 4-4-5 Monitoring Data Link Status

The following information is displayed in the *Network Properties* Area.

Data link start node
Polling node number
Network cycle time
Current and maximum data link refresh times

The following information is displayed in the *Operational Status* Area.

CPU Unit errors
Data link status
CPU Unit's operating mode
Communications status

### Checking Automatically Set Data Link Tables

The Data Link Component Window is designed for manually setting data links. If data link status is read from the Data Link Component while automatically set data links are running, the data links may not be displayed properly. Furthermore, if the data link tables that were read are then downloaded to a PLC, the data link tables that were originally in the PLC will be overwritten. To prevent these problems, use the following method to check automatically set data link tables.

1. Place the CX-Integrator online with the network PLC from which automatically set data link tables are to be read.
2. Select **Tools - Start Data Link** from the menu bar to open the Data Link Component.
3. Select **Online - Datalink Operation/Status** from the Data Link Component menu bar.
4. The Datalink Status Dialog Box will be displayed.  
Check the data link start node.

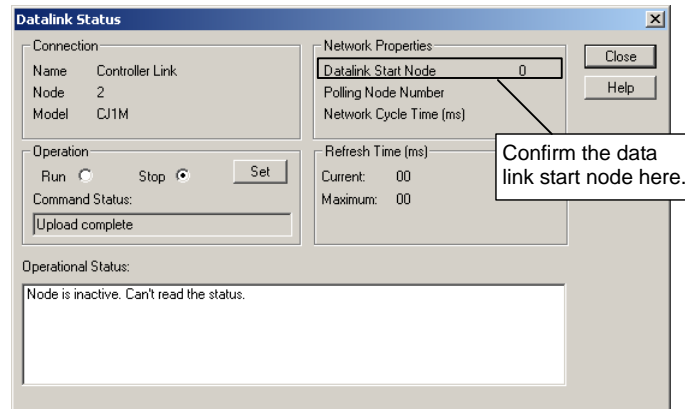

**4-4 Automatically Set Data Links**  
**4-4-5 Monitoring Data Link Status**

5. Place the CX-Integrator online with the data link start node displayed above.
6. Reconnect the CX-Integrator online and open the Data Link Component.
7. Select **Online - Start Data Link** from the Data Link Component menu bar. The Automatic Datalink Dialog Box will be displayed and the settings will be automatically uploaded.

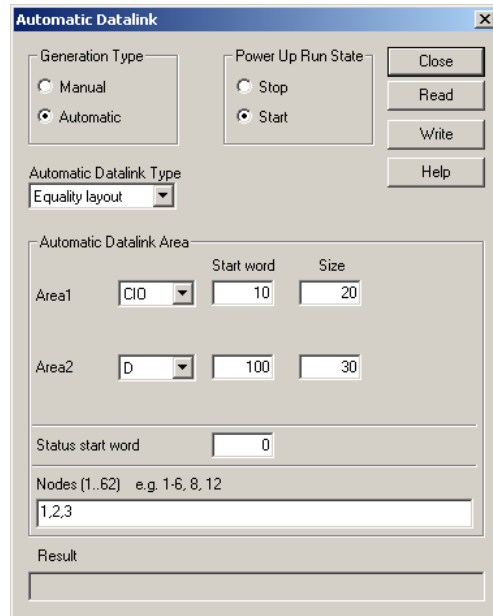

# **Communications**

## **Section 5 Ethernet**

This section describes the operations specific to Ethernet.

5-1 **Broadcast Node Search**  
5-1-1 **Overview**

## 5-1 Broadcast Node Search

### 5-1-1 Overview

The IP broadcast function can be used to search for all OMRON nodes within the same segment of an Ethernet network, and to display them in a list. Any of the OMRON nodes displayed on the list can be selected for online connection. As shown in the following table, however, there are restrictions on the execution of this function depending on the types of devices connected to the network and the operating status of the network.

Devices connected in the same segment of the Ethernet network	Ethernet network in operation	Ethernet network not in operation (during trial operation)
When configured with OMRON Ethernet Units and FinsGateway only	Can be executed.	Can be executed.
When there are devices other than OMRON Ethernet Units and FinsGateway	Cannot be executed.	Can be executed.

 **Caution** Do not execute a broadcast node search if a node exists for something other than an OMRON Ethernet Unit or FinsGateway within the same segment on Ethernet, and when the Ethernet network system is in operation. When a broadcast node search is executed, an OMRON FINS command is sent to all nodes in the segment. Therefore, if a node exists for something other than an OMRON Ethernet Unit or FinsGateway, the FINS command will not be received at that node and unexpected operation may occur.

### 5-1-2 Procedure

#### Node Search

1. Select **Tools – Ethernet tool – Broadcast node search** is selected. The following dialog box will be displayed.

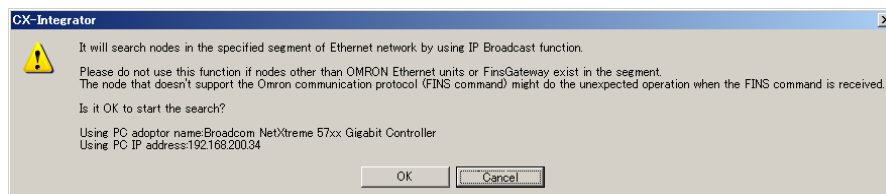

2. Check to confirm that no nodes other than OMRON Ethernet Units or FinsGateway exist in the same segment, and then click the **OK** Button. A list of nodes in the same segment will then be displayed in the Ethernet Search Result Dialog Box.

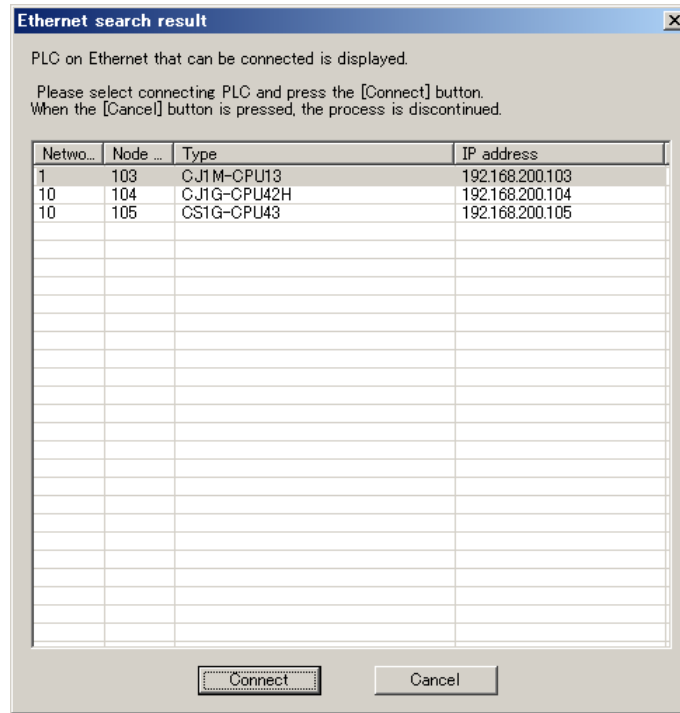

### **Online Connection**

1. To connect online any of the nodes that have been found, select the node from the list in the Ethernet Search Result Dialog Box and then click the **Connect** Button.

**Note** When the IP conversion for any node on Ethernet (i.e., an Ethernet Unit or personal computer) is set for either the IP address table method or the combined method, the IP address table at the CX-Integrator (personal computer) must be preset. (For details on setting IP address tables, refer to *Setting the IP Address Table at the CX-Programmer (Computer)* in 2-2-2 Procedures.

5-2 **Ping Test**  
 5-2-1 **Overview**

5-2 **Ping Test**  
 5-2-1 **Overview**

The connection status of a target PLC can be checked by executing a ping test from a PLC node connected on an Ethernet network. In the example shown here, PLC1 is serially connected and a ping test is executed to check whether PLC3 is connected to the Ethernet network.

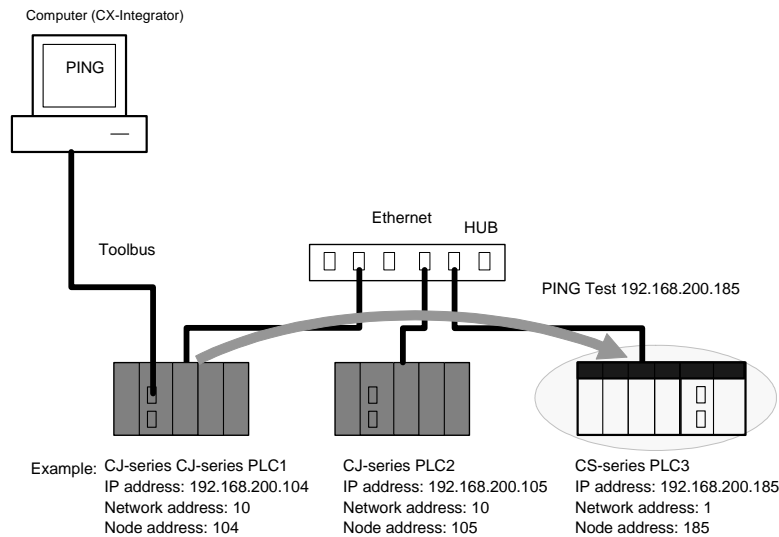

5-2-2 **Procedure**

1. After PLC1 is serially connected by an automatic online connection, right-click the Ethernet Unit and select **Connect**.

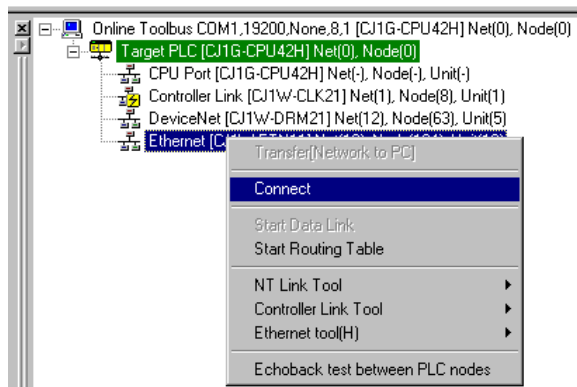

2. After connecting to Ethernet, right-click the Ethernet Unit in the Online Connection Information Window and select **Ethernet tool - Ping test**.

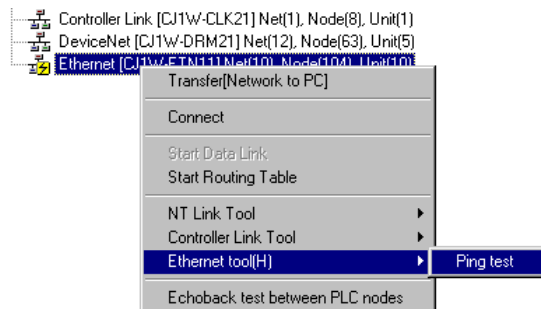



3. The Ping Test Dialog Box will be displayed. Input 192.168.200.185 as the target IP address, and then click the **Ping** Button.

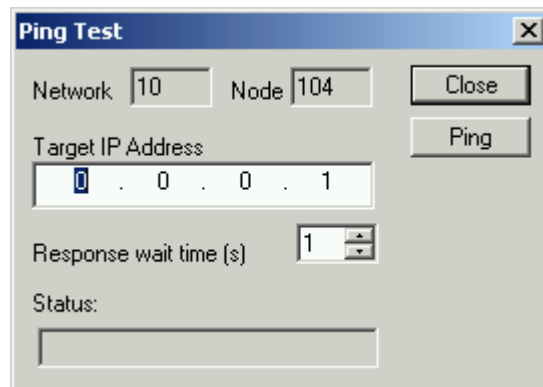

4. The test result will be displayed in the *Status* field. In this case, "Node pinged successfully" is displayed to confirm that PLC3 is connected to the Ethernet network.

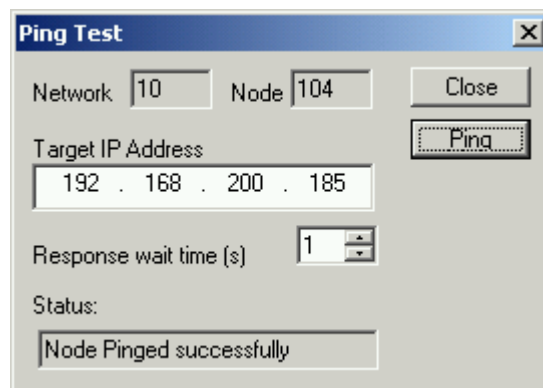

**5-2**    ***Ping Test***  
**5-2-2**    ***Procedure***

# **Communications**

## **Section 6 DeviceNet**

This section describes the settings and operations unique to DeviceNet networks, including registering slaves in the master, I/O allocations, and device monitoring.

## 6-1 DeviceNet Setting Procedures

### 6-1-1 Designing Networks Offline

## 6-1 DeviceNet Setting Procedures

This section describes the setting operations that are unique to DeviceNet networks. Refer to *Section 2 Basic Operations* for operation that are the same as those for other networks.

The following flowcharts show the overall flow of DeviceNet settings.

### 6-1-1 Designing Networks Offline

Prior to constructing the actual network, it can be designed and the master and slave parameters can be set with the CX-Integrator.

The set parameters can be saved as a network configuration file. The network configuration file contains the parameters of all of the devices on the network.

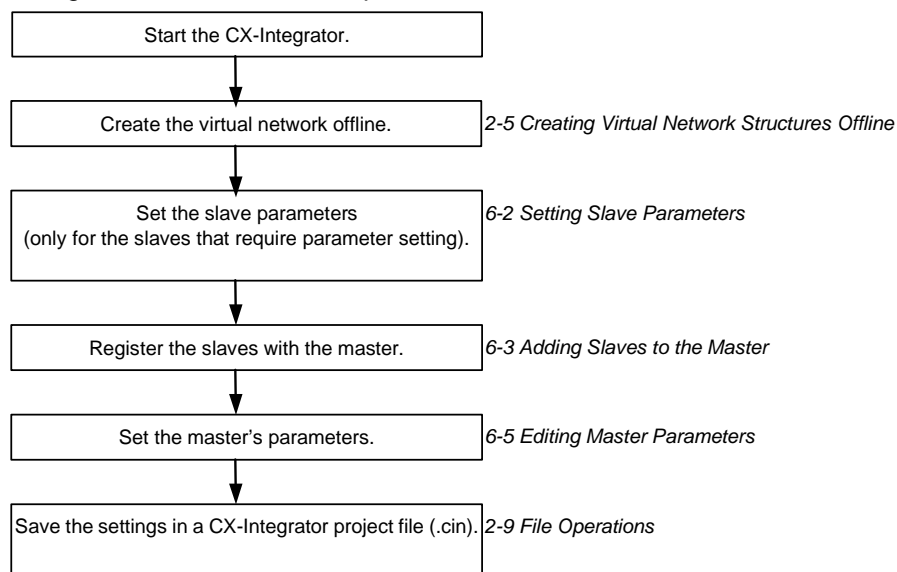

### 6-1-2 Downloading Saved Parameters

The parameters for all of the devices on the network can be set (downloaded) from a network configuration file saved in advance.

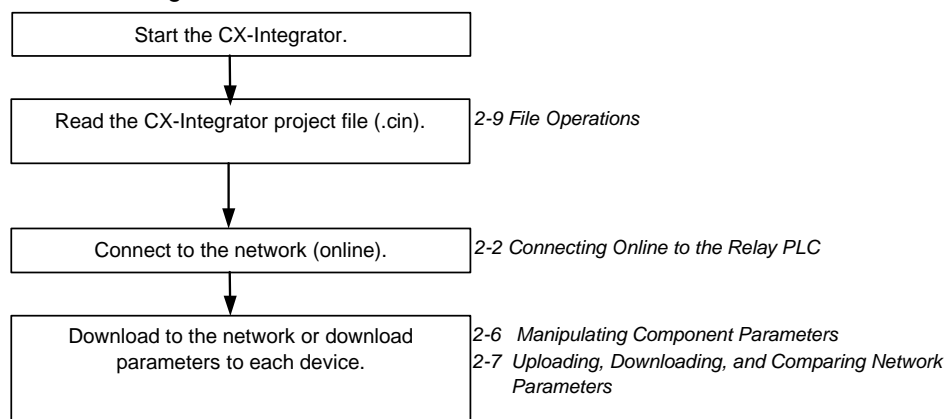

### **6-1-3 Saving the Parameters for the Entire Existing Network**

The parameters for all of the devices on the network can be saved for use in maintenance.

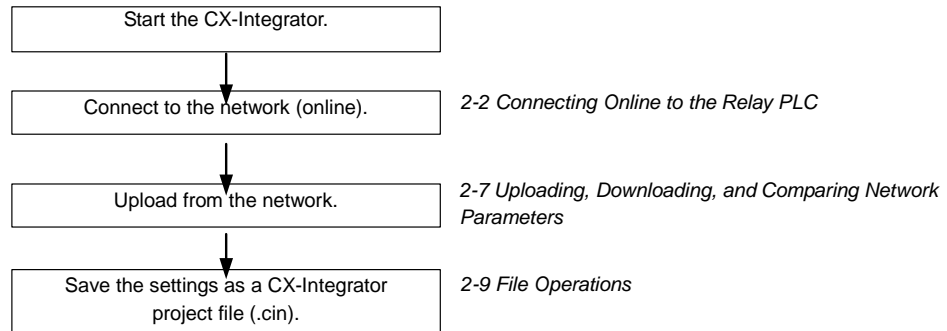

## 6-2 Setting Slave Parameters

### 6-2-1 Editing Slave Parameters

## 6-2 Setting Slave Parameters

### 6-2-1 Editing Slave Parameters

#### Component - Parameter - Edit

The parameters of some slaves can be set. However, doing so may cause the I/O size to change. Because of this, the slave parameters must all be set before setting the master's parameters.

EDS files are required for setting the parameters. If there are no EDS files available, they must be obtained from the device manufacturer.

**Note** Slaves must be added to the Network Configuration Window to edit the parameters. Refer to 2-5 *Creating Virtual Network Configurations Offline* for information on creating a virtual network.

To edit the parameters, use the following procedure.

1. Select the device.
2. Select **Component - Parameter -Edit**.
3. The following warning dialog box will be displayed if there are no editable parameters.

Slaves for which this message is displayed do not require parameter setting.

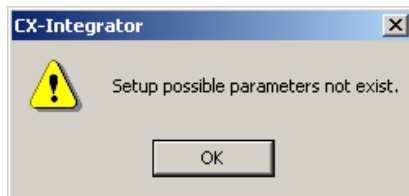

The following dialog box will be displayed if editable parameters exist.

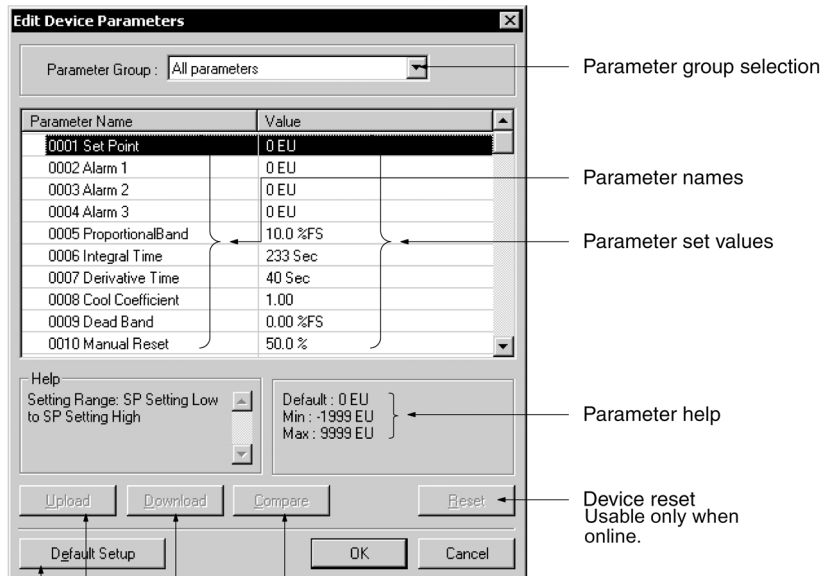





- Upload parameter Usable only when online.
- Download parameters Usable only when online.
- Compare parameters Usable only when online.
- Reset parameters to default settings Usable only when online.

## 6-2 Setting Slave Parameters

### 6-2-1 Editing Slave Parameters

4. Select the parameter and press the **Enter** Key or double-click the parameter. If a push-pin icon is displayed next to a parameter name, it is a read-only parameter and cannot be edited.

Parameter Name
 0001 Output Frequency
 0002 Output Voltage
 0003 Output Current
 0004 Output Power
 0005 Bus Voltage

The set value will be changed as shown below according to the parameter input type.

#### Numerical Input within Certain Range

0004 Port1 header code	02 (STX)
0005 Port1 Delimiter code	03 (ETX)
0006 Port1 Data size	0
0007 Port2 character format	Data=7,Parity=Even ,Stop=2
0008 Port2 frame format	×××××100

Set the value between the maximum and minimum values.

#### Selection from Limited Items

0006 Port1 Data size	0 byte
0007 Port2 character format	Data=7,Parity=Even ,Stop=2
0008 Port2 frame format	Data=7,Parity=odd ,Stop=1 Data=7,Parity=non ,Stop=1
0009 Port2 baud rate	Data=7,Parity=Even ,Stop=2 Data=7,Parity=odd ,Stop=2 Data=7,Parity=non ,Stop=2 Data=8,Parity=even ,Stop=1 Data=8,Parity=odd ,Stop=1 Data=8,Parity=non ,Stop=1
Help	
Set the character format	

Select the set value from the set value list.

#### ON/OFF Settings

0006 Port1 Data size	0 byte
0007 Port2 character format	Data=7,Parity=Even ,Stop=2
0008 Port2 frame format	<input type="checkbox"/> Header code enable <input type="checkbox"/> Bit8
0009 Port2 baud rate	<input type="checkbox"/> Delimiter code enable <input type="checkbox"/> Bit9
Help	<input checked="" type="checkbox"/> Flow control enable <input type="checkbox"/> Bit10
Set the ON or OFF about the Header,Delimiter,flow control	<input type="checkbox"/> Bit3 <input type="checkbox"/> Bit11
	<input type="checkbox"/> Bit4 <input type="checkbox"/> Bit12
	<input type="checkbox"/> Bit5 <input type="checkbox"/> Bit13
	<input type="checkbox"/> Bit6 <input type="checkbox"/> Bit14
	<input type="checkbox"/> Bit7 <input type="checkbox"/> Bit15

Select the item and turn it ON or OFF.

5. Press the **Enter** Key to input the set value.  
Press the **ESC** Key to cancel the change.
6. Click the **OK** Button when all the items have been edited.

## 6-2 Setting Slave Parameters

### 6-2-2 Checking and Setting I/O Size

#### 6-2-2 Checking and Setting I/O Size

##### Checking I/O Size

###### View - Property - I/O Information

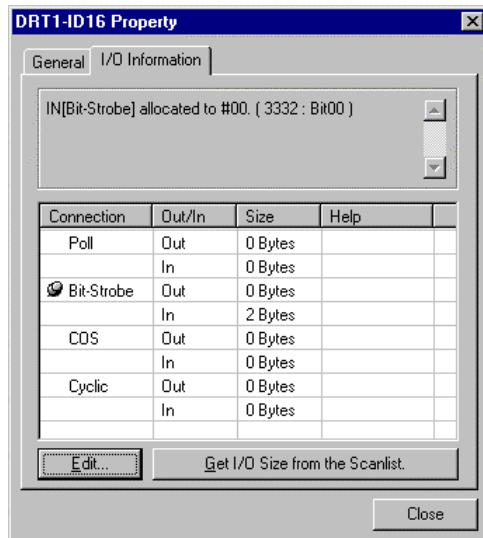

The I/O size of this slave can be checked with the **I/O Information** Tab Page of the Property Window. Check to make sure that the I/O size listed is correct. To change it, use the following procedure.

##### Setting the I/O Size

For slaves in which the I/O size can be changed by switches, or by tools other than the CX-Integrator, the CX-Integrator cannot be used to confirm that the I/O size is correct.

For these slaves, use the following procedure to directly input the I/O size.

1. Select the desired slave, then select **View - Property**.
2. Click the **I/O Information** Tab.
3. Click the **Edit** Button. The Edit I/O Size Dialog Box will be displayed.
4. Input the correct I/O size for each connection. If the connection is not known, input the correct I/O size in the *Poll* settings.
5. Click the **OK** Button.

##### **Note**

The following are OMRON slaves.

- DRT1-AD04 Analog Input Terminal  
Input (4-word/2-word) can be changed by DIP switch.
- GT1-AD08MX Analog Input Unit for MULTIPLE I/O TERMINAL.  
Input (8-word/4-word) can be changed by DIP switch.
- NT-DRT21 Programmable Terminal DeviceNet Interface Unit  
The I/O data area can be set from 1 to 64 words with the PT system menu.
- E3X-DRT21 Fiber Amplifier Communications Unit  
Status and light levels can be added to input data.

Use the same kind of input procedure for slaves of other manufacturers that allow the I/O size to be changed.



### **Obtaining I/O Size Information from the Master Scan List**

When connecting the CX-Integrator to a network that is already operating, for example using OMRON Master Units with fixed allocation, the slave I/O size can be obtained from the master scan list for use in setting.

However, this is possible only with OMRON masters. Also, the slave I/O size cannot be obtained from the slave function of the CS1W-DRM21(-V1) and CJ1W-DRM21.

Use the following procedure to obtain the I/O size from a master scan list.

1. Select the desired slave, then select **View - Property**.
2. Click the **I/O Information** Tab.
3. Click the Get I/O Size from the Scanlist Button.

### **Parameter Auto Update When I/O Size Changed**

The function to automatically update the I/O size registered on the master scan list when the I/O size is changed can be switched ON or OFF.

To automatically update the I/O size registered on the master scan list, select **Tools - DeviceNet tool - Parameter Auto Update when I/O Size Changed**.

When this function is enabled, the  mark will be displayed in the menu. The default is set to not automatically update.

**Note** If the function to automatically update the I/O size is enabled and there is no EDS file, some operations will cause the I/O size in the master scan list to be updated to zero. For this reason, the function to automatically update the I/O size should normally be disabled.

## 6-3 Adding Slaves to the Master

### 6-3-1 Automatic I/O Area Allocation with Registration

## 6-3 Adding Slaves to the Master

### 6-3-1 Automatic I/O Area Allocation with Registration

When a slave is registered to the master, it can automatically be allocated to the memory block set for I/O allocation.

The allocation, for both Out Size and In Size, will be made in the order of registration beginning with the unoccupied area of memory block 1. When memory block 1 is filled, the allocation will be made to memory block 2. Before adding slaves, set the area and range of the allocation memory block.

**Note** The allocated words can be changed later if desired.

### Setting the Allocation Memory Block

1. Select the master, then select **Component - Parameter - Edit**. The Edit Device Parameters Dialog Box will be displayed.
2. Click the **I/O Allocation (OUT)** Tab.

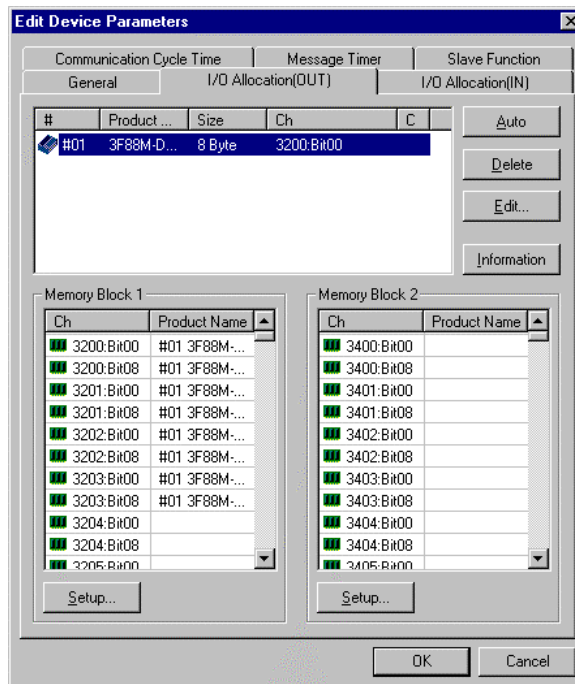

3. Click the **Setup** Button for Memory Block 1.

## 6-3 Adding Slaves to the Master

### 6-3-1 Automatic I/O Area Allocation with Registration

4. Set the area, start word, and the number of words for the block.

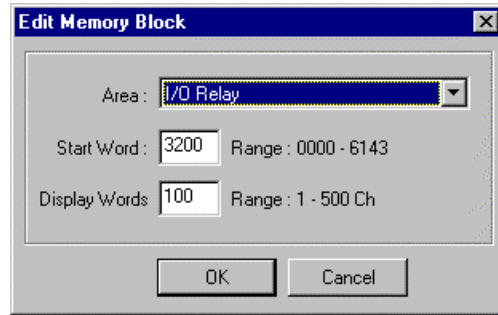

The screenshot shows a dialog box titled "Edit Memory Block". It contains three input fields: "Area" with a dropdown menu showing "I/O Relay", "Start Word" with a text box containing "3200" and a range indicator "Range : 0000 - 6143", and "Display Words" with a text box containing "100" and a range indicator "Range : 1 - 500 Ch". At the bottom of the dialog are two buttons: "OK" and "Cancel".

5. Set Memory Block 2 in the same way.
6. Click the **I/O Allocation (IN)** Tab, and make the memory block settings in the same way as for the **I/O Allocation (OUT)**.

#### Note

- If a block is not to be used, select **Not Used** for the area setting.
- *Display Words* refers to the number of words in the block displayed on the CX-Integrator. This value is not downloaded to the master. If the occupied area of the block is less than 100 words when uploaded, *Display Words* will be set to 100 and displayed as such.

## 6-3 Adding Slaves to the Master

### 6-3-2 Adding Slaves

#### 6-3-2 Adding Slaves

The following three methods are supported for adding slaves.

#### Dragging and Dropping

Select the slave from the Network Configuration Window on the right and drag and drop it on the master icon.

When slaves are registered with the master, I/O words will be automatically allocated to the slaves in the order they are registered.

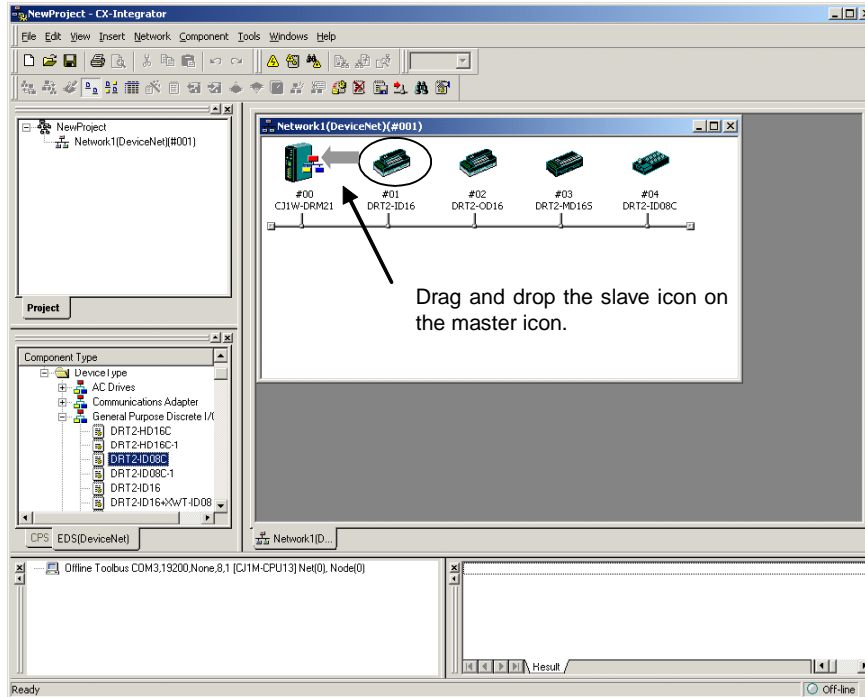

#### After Registration

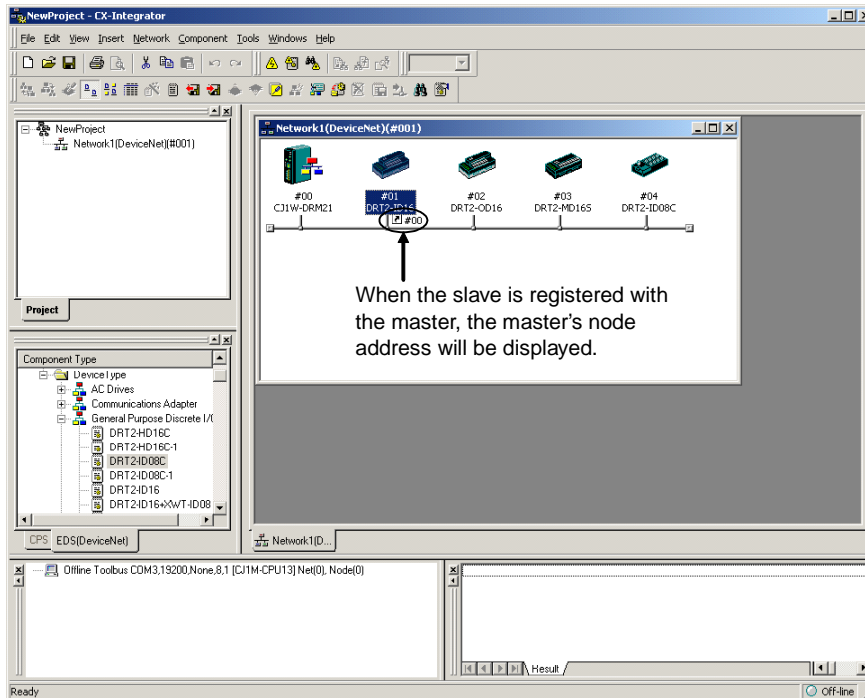

### Master Node Address Displayed after Registration

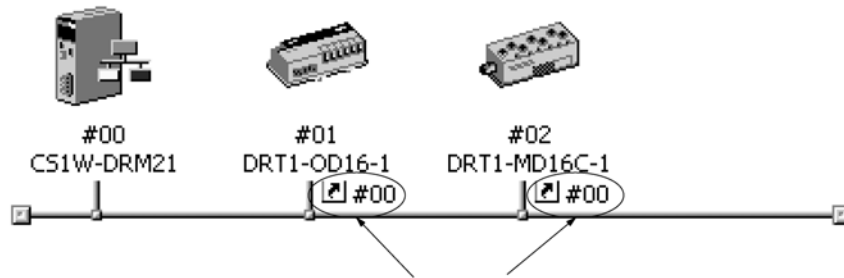

When the slaves are registered, the master's node address will be displayed (00 in the above case) with the prefix # after the symbol .

### Register to Other Device

A slave can also be added by selecting the slave in the Network Configuration Window, clicking the right mouse button, selecting **Register to other Device** or selecting **Component - Register to other Device**, and then selecting the master from the menu. The menu will appear on the right-hand side.

At the time of I/O allocation, the registered slave can be deleted or settings can be made for the registered slave by using the Parameter Wizard or by editing the parameters of the master.

**Note** To select a device from the menu and register it, use the following procedure.

1. Select the device from the Network Configuration Window.
2. Select Component - Register to other Device.  
The following master candidates will be displayed in the **Register to other Device** Menu.

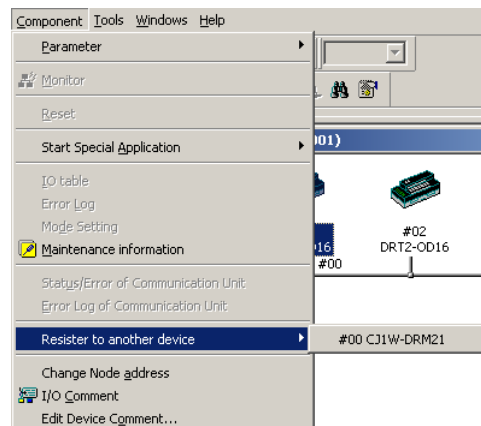

3. Select the device with which the slave is to be registered.  
The slave registered will be automatically added to the scan list of the master and I/O will be allocated.

If the user attempts to register a slave that has already been registered with another device, the following confirmation window will be displayed. By clicking the **Yes** Button, the duplicated registration of the slave will be possible. However, if the registration is duplicated, the slave will only be able to communicate with one device. If the same slave is registered to multiple masters, it will lead to communications errors.

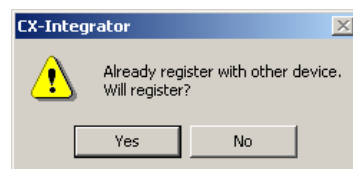

## **6-3 Adding Slaves to the Master**

### **6-3-2 Adding Slaves**

#### **Registering in the Edit Device Parameters Window**

Slaves can be added and I/O areas allocated in the Edit Device Parameters Window. Refer to *6-7 Master Parameter Editing Details (Tab Descriptions)* for details.

## 6-4 Setting Master Properties

This section describes how to set properties for OMRON masters. The Master Unit is right-clicked and **Property** is selected from the popup menu.

### 6-4-1 CS1W-DRM21(-V1) and CJ1W-DRM21

To set the master and slave functions, use the following procedure.

1. Right-click the master from the Network Configuration Window on the right and select **View - Property** from the popup menu. The following dialog box will be displayed.
2. Click the **Unit Function** Tab.

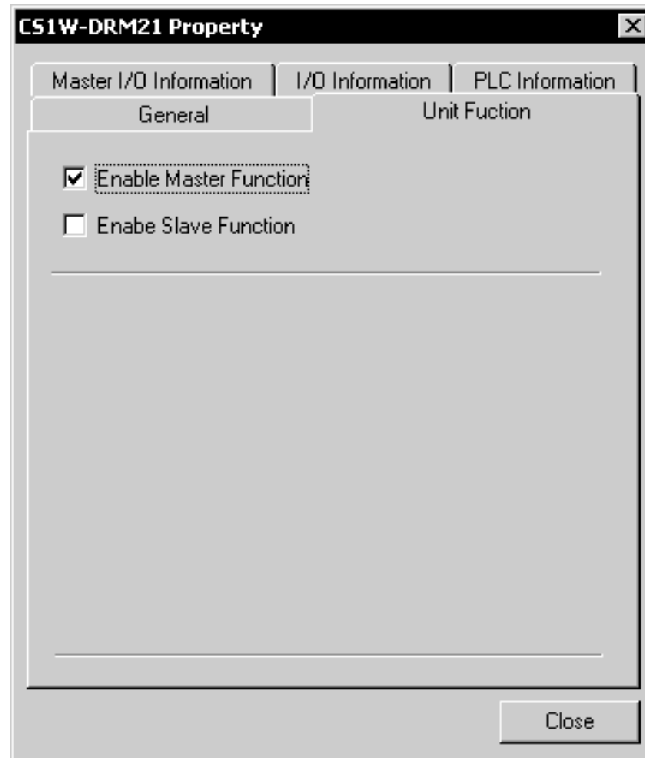

3. Select **Enable Master Function** and/or **Enable Slave Function**.

## 6-4 Setting Master Properties

### 6-4-2 CVM1-DRM21-V1 or C200HW-DRM21-V1

#### 6-4-2 CVM1-DRM21-V1 or C200HW-DRM21-V1

To set the PLC model on which the Unit is mounted, use the following procedure.

1. Right-click the Master Unit in the Network Configuration Window and select **Property** from the popup menu. The following dialog box will be displayed.
2. Click the **PLC Information** Tab.

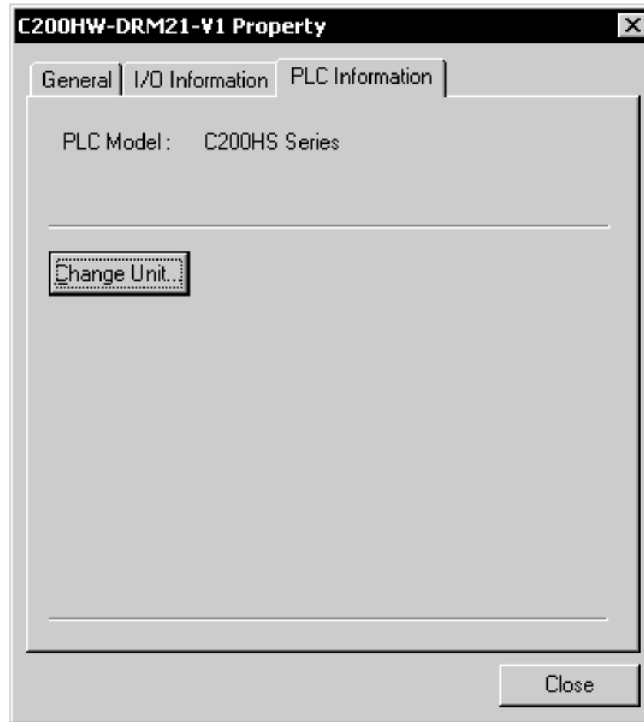

3. Click the **Change Unit** Button.  
The following dialog box will be displayed.

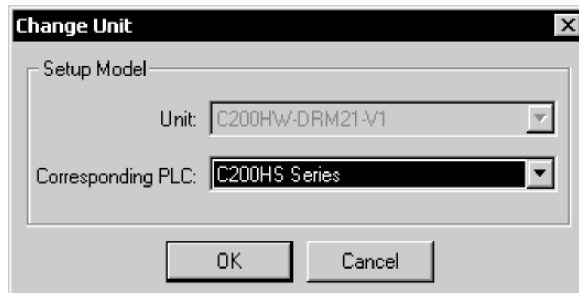

4. Specify the PLC model. Click the **OK** Button.

**Note** When the PLC model is changed, all the settings presently made will be cleared and default values will be set.



## 6-5 Editing Master Parameters

Device parameters are classified into master device parameters and slave device parameters. This section description provides information on how to edit master device parameters.

The master device parameters that can be edited include slave device I/O allocations to the master, communication cycle time settings, and connection settings.

The following two methods can be used to edit parameters for the master.

1) Parameter Wizard

The Parameter Wizard is an interactive interface that makes I/O allocations possible in order of node addresses.

2) Editing Parameters

Parameters can be edited to allocate I/O and make settings as required, including the communication cycle time, connection, and device information check settings.

The CX-Integrator allows settings, such as the following function settings, for the OMRON CS1W-DRM21(-V1) DeviceNet Unit, CJ1W-DRM21 DeviceNet Unit, CVM1-DRM21-V1 DeviceNet Master Unit, and C200HW-DRM21-V1 DeviceNet Master Unit.

When transferring parameters edited for the CVM1-DRM21-V1, C200HW-DRM21-V1, or 3G8F7-DRM21, however, they can be transferred from the CX-Integrator only by going through a CS/CJ-series PLC.

Function	Setting method		CS1W-DRM21 (-V1) or CJ1W-DRM21	C200HW-DRM21-V1 or CVM1-DRM21-V1
	Parameter Wizard (Component - Parameter - Wizard)	Parameter editing (Component - Parameter - Edit)		
I/O Allocations	Parameter Wizard	I/O Allocation (OUT) and I/O Allocation (IN) Tabs	OK	OK
Communication Cycle Time	---	Communication Cycle Time Tab	OK	OK
Connections		Advanced Setup Button in General Tab	OK	No
Device Information Compare		OK	No	
Message Timer		Message Timer Tab	OK	No
Slave Function		Slave Function Tab	OK	No
Startup Remote I/O Communications		General Tab	(See note 1.)	OK
Explicit Message Communications			(See note 2.)	OK

Note 1. The same function can be achieved with the setting to enable/disable the master function.

2. Explicit message communications is possible whether or not registration has been made on the scan list.

**Note** When editing parameters on the CX-Integrator for the CVM1-DRM21-V1, C200HW-DRM21-V1, or 3G8F7-DRM21, download them to the Master Unit by going through a CS/CJ-series PLC.

**Note** Before making device I/O allocations to the master, the device must be added to the Network Configuration Window, regardless of whether or not it has been registered as a slave with the master. Refer to 2-5 *Creating Virtual Network Configurations Offline* for information on creating a virtual network.

## 6-6 Parameter Wizard

### Component - Parameter - Wizard

- The Parameter Wizard is an interactive function making it possible to allocate I/O with ease.
- This function ensures easy I/O allocations in order of node addresses beginning with block 1.

When block 1 is full, the remaining I/O will be allocated to block 2. Each block consists of a maximum of 100 words.

**Note** After I/O allocations are made with the Parameter Wizard, node addresses or I/O allocations can be changed by editing the parameters individually.

The following procedure uses the Parameter Wizard with the CS1W-DRM21(-V1)/CJ1W-DRM21 as an example. The same method can be used for the CVM1-DRM21-V1 and C200HW-DRM21-V1.

Specify the first address of each block (fixed to 100 words in size), the allocation method (i.e., allocation in blocks of words or minimum required number of words), and the registration or deletion of slaves.

**Note**

- To make allocations in excess of 100 words per block, use **Parameter - Edit**.
- To allocate I/O of slave devices to the master with the Parameter Wizard, use the following procedure.

1. Select the master.
2. Select **Component - Parameter - Wizard**.
3. When settings are made with the Parameter Wizard, the present settings will be cleared and default values will be set. The following confirmation dialog box will be displayed. Click the **Yes** Button.

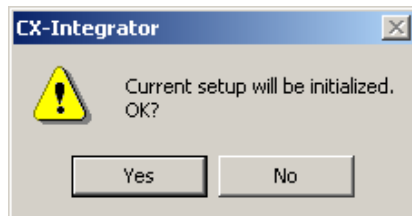

4. The following Scan List Wizard-Set Memory Block's Start Word Dialog Box will be displayed.

Set the memory area to be used and the start word and click the **Next** Button. I/O will be automatically allocated to block 1. When block 1 is full, I/O will be allocated to block 2. Each block consists of a maximum of 100 words.

**Note** It is not possible to go to the next step if there is any duplication between blocks or the first word is not within the permissible set range.

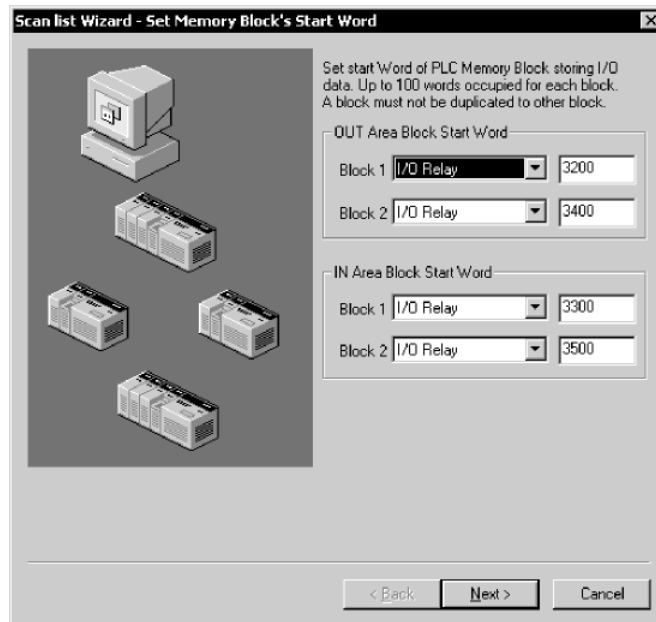

5. The Scan list Wizard-Set How to Allocate I/O Date to PLC Memory Block Dialog Box will be displayed. Specify the allocation method and click the **Next** Button.

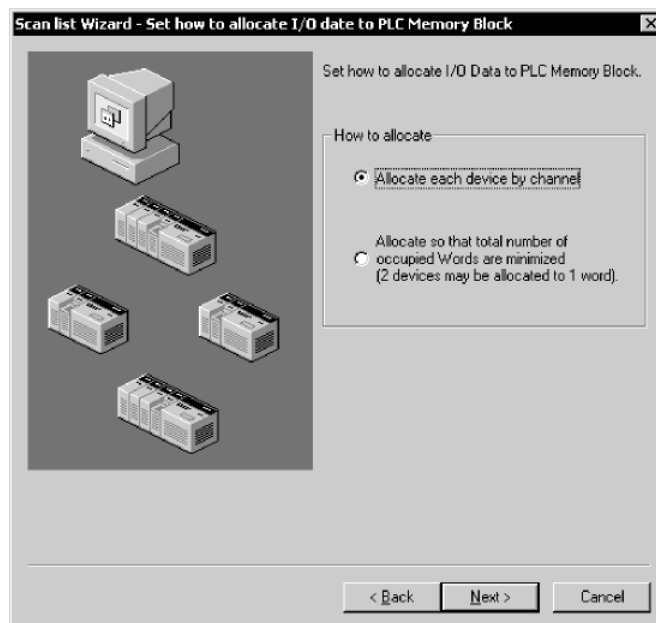

## 6-6 Parameter Wizard

The following two allocation methods are supported.

<p>Allocate each node by word.</p>	<p>Slaves are always allocated memory starting with the seven rightmost bytes in the word. Even slaves that require just one byte of I/O memory will be allocated one word.</p> <p>Example:</p>
<p>Allocate so that total number of allocated words is minimized.</p>	<p>If there are slaves that require just one byte of I/O memory, they are allocated the rightmost seven bits or leftmost seven bits so that the total number of occupied words is minimized.</p> <p>Example:</p>

An allocation example is shown below.

I/O Example:

#00	1 byte
#01	2 bytes
#02	1 bytes
#03	4 bytes
#04	1 byte
#05	1 byte

### Allocation in Units of Words

	High 15 to 8	7 to 0 Low
+0 word		#00
+1 word	#01	
+2 word		#02
+3 word	#03	
+4 word	#03	
+5 word		#04
+6 word		#05

### Allocation with Allocated Words Minimized

	High 15 to 8	7 to 0 Low
+0 word	#02	#00
+1 word	#01	
+2 word	#03	
+3 word	#03	
+4 word	#05	#04

## 6. Slave Registration/Deletion

The following Scan List Wizard - Set Memory Block's Start Word Dialog Box will be displayed.

Specify the slave to be registered with the master and click the **Next** Button.

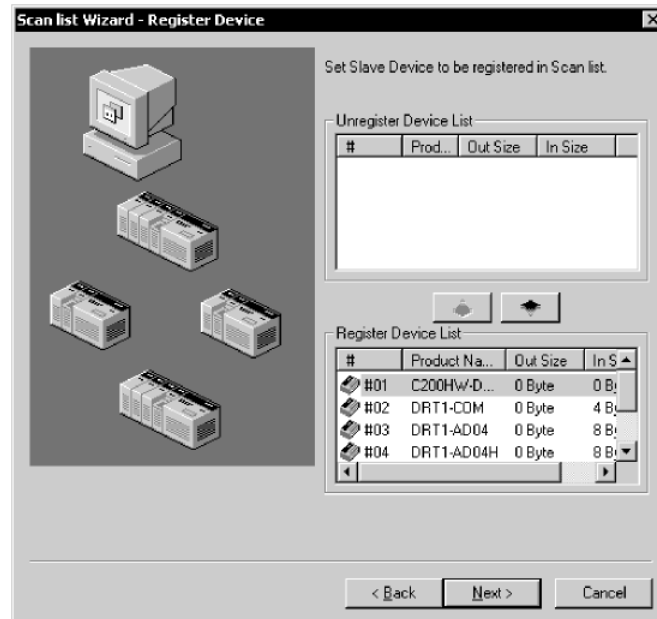

The devices on the network are shown in the Registered Device List.

To cancel the registration of a device, click the following icon: 

The user cannot go to the next step if no devices are registered.

## 7. The following Scan List Wizard-Allocated Result Dialog Box will be displayed after remote I/O allocations have been made as specified.

Click the **Finish** Button if the displayed details are OK. The Parameter Wizard will finish. The user can click the **Back** Button to return to the previous dialog box.

The displayed details will be set as device parameters.

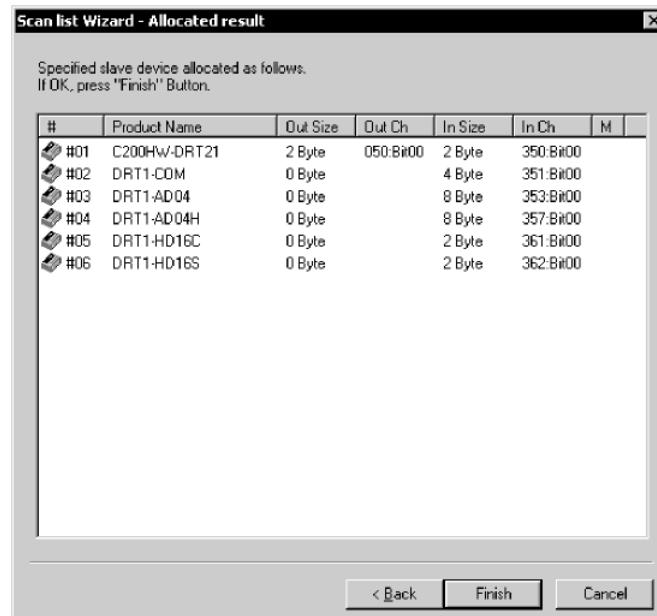

## 6-6 Parameter Wizard

8. If the CX-Integrator is online, the following dialog box will be displayed.

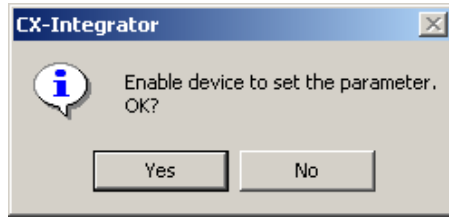

Click the **Yes** Button and edit the master parameters. Remote I/O communications according to the new settings will start.

**Note** Device parameters set with the Parameter Wizard can be edited by individually if necessary.

## 6-7 Master Parameter Editing Details (Tab Descriptions)

### Component - Parameter - Edit

The user can individually edit allocations for remote I/O communications and make advanced settings, such as the communication cycle time and connection settings. Possible setting items vary with the master model.

The following description provides information on editing individual parameters. Refer to *6-8 Manual I/O Allocations* and *6-9 Advanced Settings (Connection, Communication Cycle Time, Slave Function Settings, Etc.)* for further information on editing parameters manually.

To edit the parameters, use the following procedure.

1. Select the device for which parameters are to be edited.
2. Select **Component - Parameter -Edit**.
3. The Edit Device Parameters Dialog Box will be displayed.

#### Note

- If the I/O size of the device displayed in the Network Configuration Window does not coincide with the I/O data size of the device registered with the scan list, the following warning dialog will be displayed along with the Edit Device Parameters Window. In this case, the I/O size in the scan list will take priority.

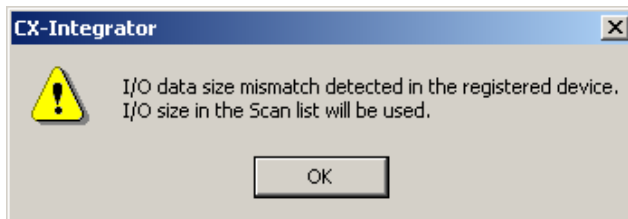

If an EDS file has not been installed in the slave, obtain the EDS file and install it. Also, set the correct I/O size in all slaves that require changes in the I/O size.

- If the slave device registered with the scan list has already been registered with another master, the following warning will be displayed along with the Edit Device Parameters Dialog Box.

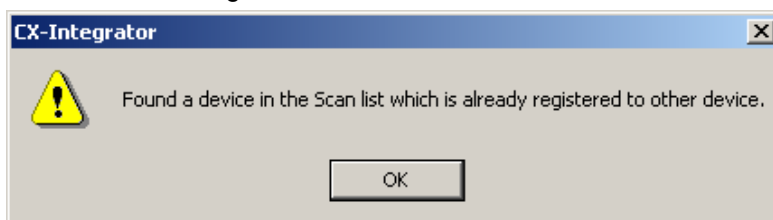

Revise the slaves registered in the scan list.

**6-7 Master Parameter Editing Details (Tab Descriptions)**  
**6-7-1 Edit Device Parameters on CS1W-DRM21(-V1)/CJ1W-DRM21**

**6-7-1 Edit Device Parameters on CS1W-DRM21(-V1)/CJ1W-DRM21**

**Note** When the CS1W-DRM21(-V1)/CJ1W-DRM21 DeviceNet Unit is used, select the device and then select **Component - Property** and turn ON *Enable Master Function* in the Properties Dialog Box.

The following dialog box will be displayed when the CS1W-DRM21(-V1)/CJ1W-DRM21 is selected.

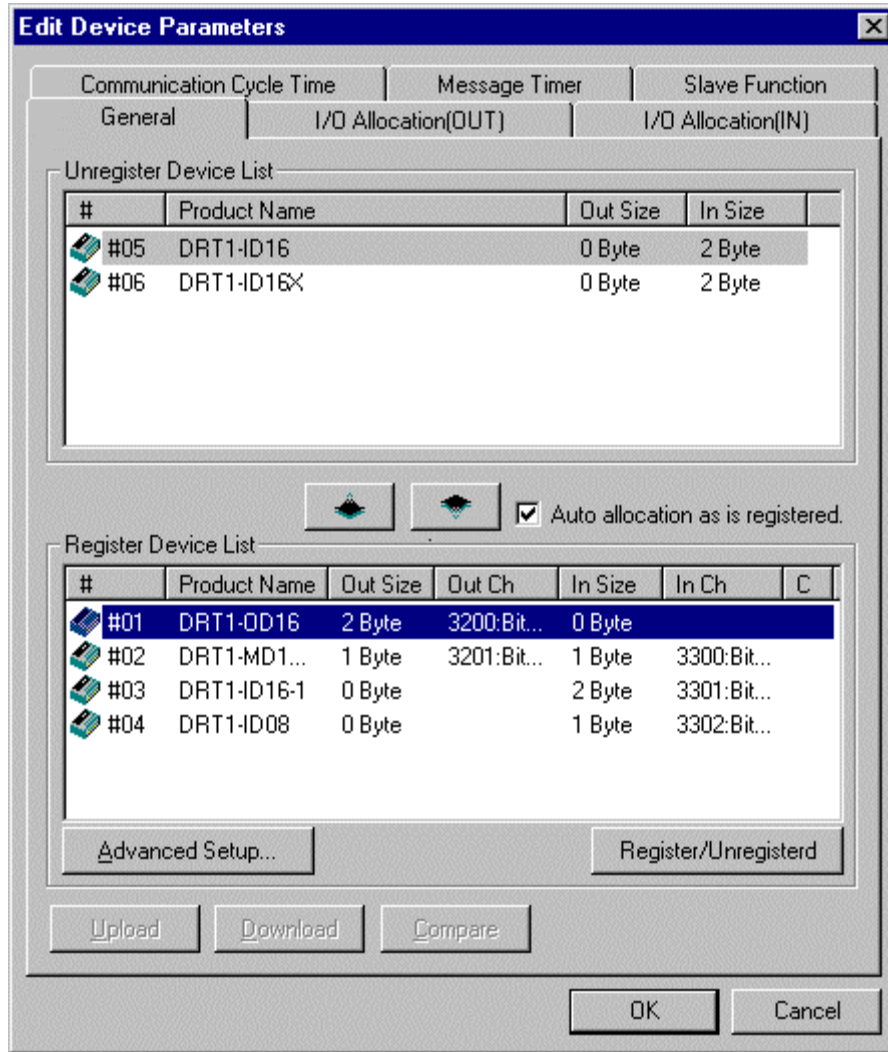

The Edit Device Parameters Dialog Box consists of the following six tab pages.

Tab	Description
General	Registers the device with the scan list and makes I/O allocations automatically.
I/O Allocation (OUT)	Allocates the output data and sets the output memory block for the CPU Unit with the advanced setup function.
I/O Allocation (IN)	Allocates the input data and sets the input memory block in the CPU Unit with the advanced setup function.
Communication Cycle Time	Sets the communication cycle time.
Slave Function	Makes necessary settings that enable the slave function.
Message Timer	Makes monitor timer settings for message communications (both explicit and FINS message communications).





## 6-7 Master Parameter Editing Details (Tab Descriptions)

### 6-7-1 Edit Device Parameters on CS1W-DRM21(-V1)/CJ1W-DRM21

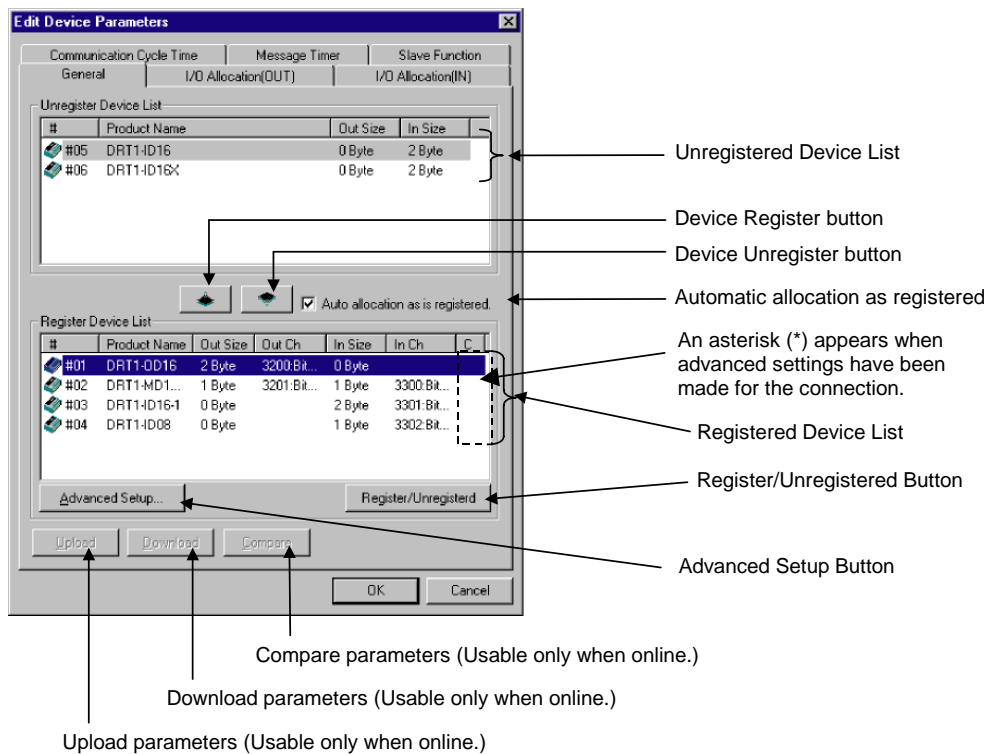
#### General Tab Page of CS1W-DRM21(-V1)/CJ1W-DRM21



Item	Description
Unregistered Device List	Displays unregistered devices. Unregistered devices refer to slaves that are displayed in the Network Configuration Window but have not been registered with a master.
Registered Device List	Displays slaves that are presently registered with a master.
Device Register and Unregister Buttons	 : By pressing this button, the selected device will move from the Unregistered Device List to the Registered Device List.  : By pressing this button, the device will move from the Registered Device List to the Unregistered Device List.
Auto allocation as is registered	Check this box when registering the slaves with the master in the Edit Device Parameters Window so that the slaves will be allocated to an unused area in blocks of words in order of registration.
Register/Unregister Buttons	Click this button to unregister the I/O allocation of the selected slaves or to make the I/O reallocation of the slaves in the order of earlier addresses.
Advanced Setup Button	Click this button to set the connections or display the device information.
Upload	Uploads the parameters of the network device online.
Download	Downloads the parameters to the network device on line.
Compare	Compares the parameters of the selected network device with the parameters stored in the CX-Integrator.

**6-7 Master Parameter Editing Details (Tab Descriptions)**  
**6-7-2 Editing Device Parameters on CVM1-DRM21-V1 and C200HW-DRM21-V1**

**6-7-2 Editing Device Parameters on CVM1-DRM21-V1 and C200HW-DRM21-V1**

The following dialog box will be displayed when the CVM1-DRM21-V1 or C200HW-DRM21-V1 DeviceNet Master Unit is selected.

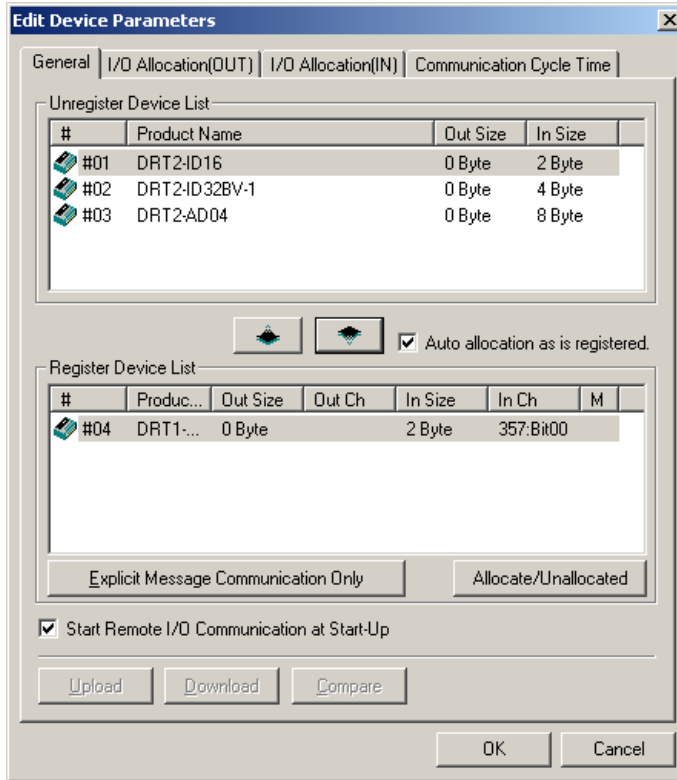

The Edit Device Parameters Dialog Box consists of the following four tab pages.



Tab	Description
General	Registers the device with the scan list and makes I/O allocations automatically.
I/O Allocation (OUT)	Allocates the output data and sets the output memory block the CPU Unit with the advanced setup function.
I/O Allocation (IN)	Allocates the input data and sets the input memory block in the CPU Unit with the advanced setup function.
Communication Cycle Time	Sets the communication cycle time.

## 6-7 Master Parameter Editing Details (Tab Descriptions)

### 6-7-2 Editing Device Parameters on CVM1-DRM21-V1 and C200HW-DRM21-V1

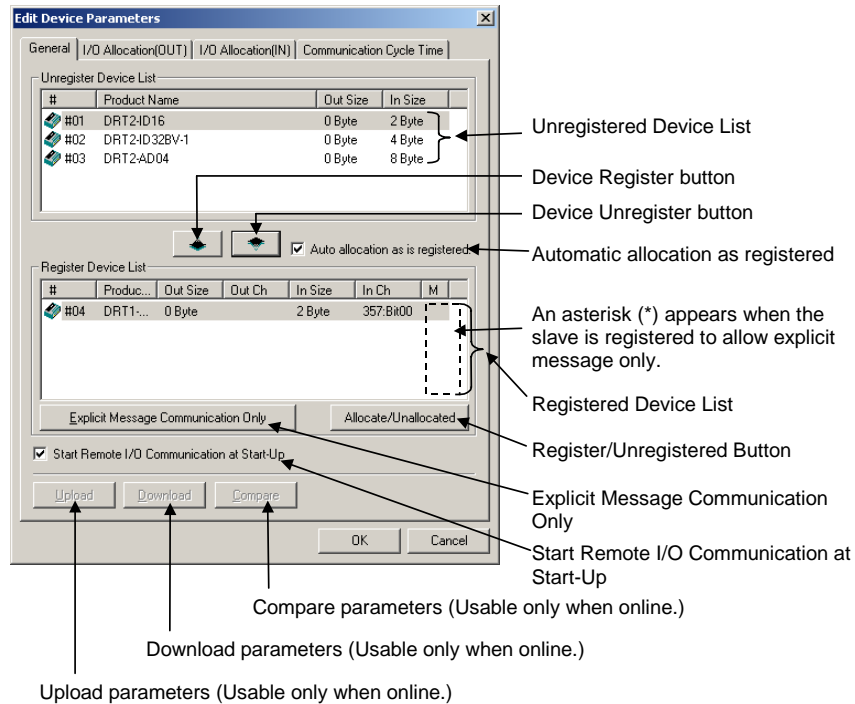
#### General Tab of CVM1-DRM21-V1 or C200HW-DRM21-V1



Item	Description
Unregistered Device List	Displays unregistered devices. Unregistered devices refer to slaves that are displayed in the Network Configuration Window but have not been registered with the master.
Registered Device List	Displays slaves that are presently registered with the master.
Device Register and Unregister Buttons	 : By pressing this button, the selected device will move from the Unregistered Device List to the Registered Device List.  : By pressing this button, the device will move from the Registered Device List to the Unregistered Device List.
Auto allocation as is registered	Check this box when registering the slaves with the master in the Edit Device Parameters Window so that the slaves will be allocated to an unoccupied area in blocks of words in order of registration.
Allocate/Unallocated Button	Click this button to unregister the I/O allocations or to make the I/O reallocations.
Explicit Message Communication Only Button	Check this button to enable explicit message communications (transmission only) without remote I/O communications.
Start Remote I/O Communication at Start-Up	Check this box to enable remote I/O communications automatically when the master starts up.
Upload	Uploads the parameters of the network device online.
Download	Downloads the parameters to the network device on line.
Compare	Compares the parameters of the selected network device with the parameters stored in the CX-Integrator.

## 6-7 Master Parameter Editing Details (Tab Descriptions)

### 6-7-3 Editing Device Parameters on 3G8F7-DRM21 DeviceNet PCI Board Scanner

#### 6-7-3 Editing Device Parameters on 3G8F7-DRM21 DeviceNet PCI Board Scanner

The following dialog box will be displayed when the 3G8F7-DRM21 DeviceNet PCI Board Scanner is selected.

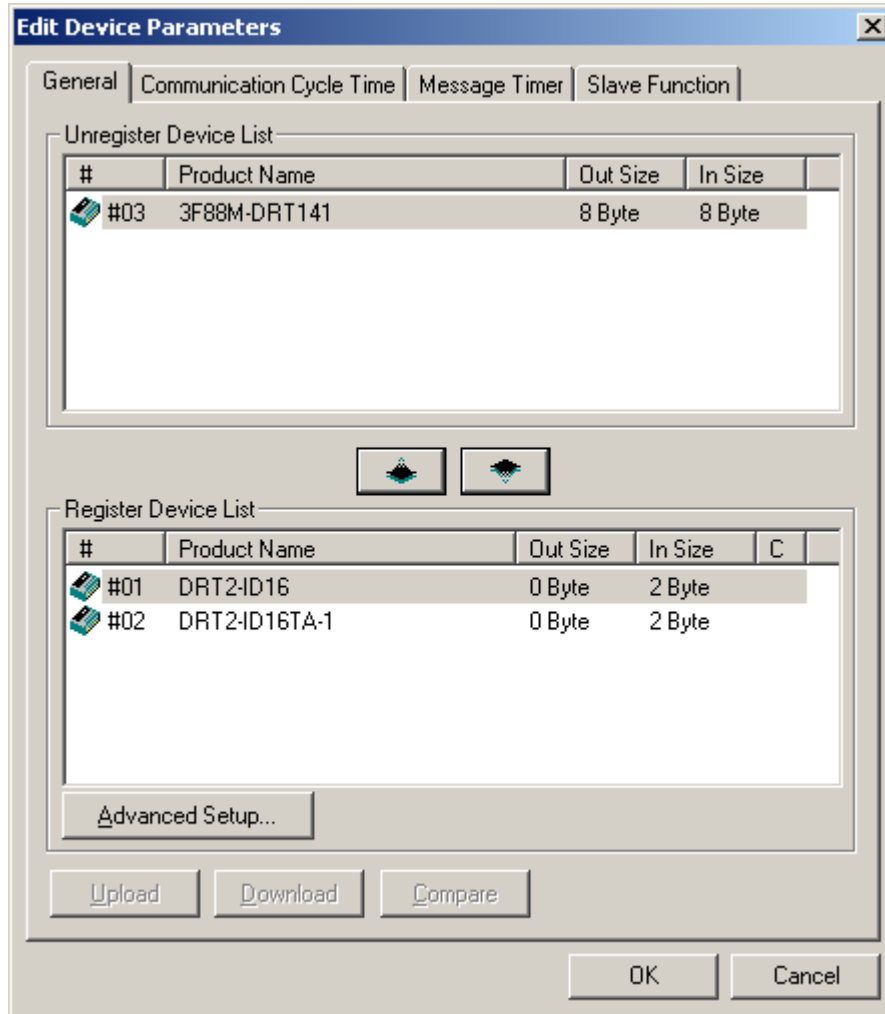



The Edit Device Parameters Dialog Box consists of the following four tab pages.

Tab	Description
General	Registers the device with the scan list and makes I/O allocations automatically.
Communication Cycle Time	Sets the communication cycle time.
Slave Function	Makes necessary settings that enable the slave function.
Message Timer	Makes monitor timer settings for message communications (both explicit and FINS message communications).

**6-7 Master Parameter Editing Details (Tab Descriptions)**  
**6-7-3 Editing Device Parameters on 3G8F7-DRM21 DeviceNet PCI Board Scanner**

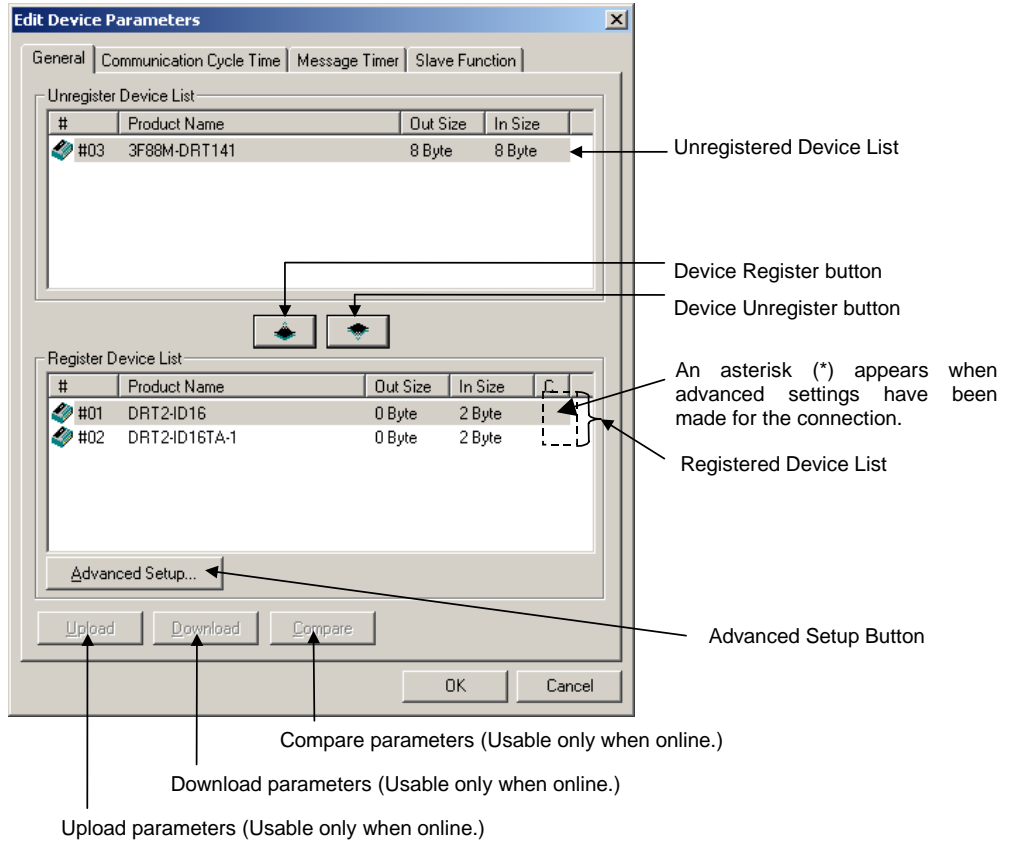
**General Tab of 3G8F7-DRM21**



Item	Description
Unregistered Device List	Displays unregistered devices. Unregistered devices refer to slaves that are displayed in the Network Configuration Window but have not been registered with the master.
Registered Device List	Displays slaves that are presently registered with the master.
Device Register and Unregister Buttons	 : By pressing this button, the selected device will move from the Unregistered Device List to the Registered Device List.  : By pressing this button, the device will move from the Registered Device List to the Unregistered Device List.
Advanced Setup Button	Click this button to set the connections or display the device information.
Upload	Uploads the parameters of the network device online.
Download	Downloads the parameters to the network device on line.
Compare	Compares the parameters of the selected network device with the parameters stored in the CX-Integrator.

## 6-7 Master Parameter Editing Details (Tab Descriptions)



### 6-7-4 Canceling Slave Registration with the Master

#### 6-7-4 Canceling Slave Registration with the Master

##### Component - Parameter - Edit - General Tab - Register/Unregistered (Allocate/Unallocated) Button

Note: This procedure is the same for the CS1W-DRM21(-V1), CJ1W-DRM21, CVM1-DRM21-V1, C200HW-DRM21-V1, and 3G8F7-DRM21.

The General Tab Page is used to register slaves with the master or unregister slaves. To register or unregister a slave, use the following procedure.

1. Select the slave to be registered or unregistered.
2. Click the  Register or  Unregister Button.

An unregistered slave will be displayed in the Unregistered Device List.  
A registered slave will be displayed in the Registered Device List.

#### 6-7-5 Automatic Allocation with Registration

##### Component - Parameter - Edit - General Tab - Auto allocation as is registered - Register/Unregistered (Allocate/Unallocated) Button

Note: This procedure is the same for the CS1W-DRM21(-V1), CJ1W-DRM21, CVM1-DRM21-V1, and C200HW-DRM21-V1.

- If the *Auto allocation as is registered* Box is checked when the slaves are registered with the master in the Edit Device Parameters Dialog Box, the I/O allocation of the slaves will be made in units of words automatically in order of registration. This checkbox will be enabled in the Edit Device Parameters Dialog Box only. The automatic allocation of the slaves will be made in units of words automatically in order of registration beginning with the unoccupied area of block 1 of the corresponding memory block.
- It is possible to unregister the I/O allocation of the selected slaves or to make the I/O reallocation of the slaves in the order of earlier addresses anytime by clicking on Register/Unregistered Button. The advanced setup function (explained later) will not be available if automatic allocation is selected.

## 6-8 Manual I/O Allocations

### Component - Parameter - Edit - I/O Allocation Tab

Manual I/O allocation is possible with no restrictions on node address order or block size 1 or 2.

Note: This procedure is the same for the CS1W-DRM21(-V1), CJ1W-DRM21, CVM1-DRM21-V1, and C200HW-DRM21-V1. In the following setting example, the CS1W-DRM21(-V1) is used.

#### 6-8-1 I/O Allocation Tab Page

Make the following settings on the I/O Allocation Tab Page.

1. I/O allocation of each OUT/IN memory block (1/2) to the I/O memory area of the CPU Unit
2. Click the **I/O Allocation (OUT)** or **I/O Allocation (IN)** Tab. The following dialog box will be displayed.

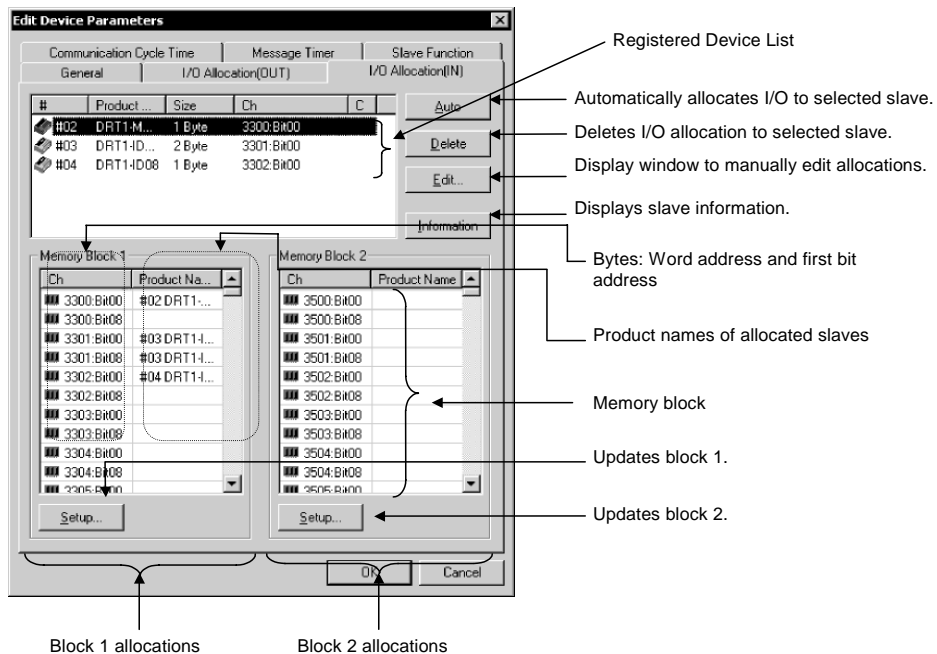

Item	Description
Registered Device List	Only devices with valid output or input data among all devices registered with the General Tab Page will be displayed.
Auto Button	Allocates in units of words the slaves selected from the Registered Device List to an unoccupied area in the order of earlier addresses.
Delete Button	Unregisters the I/O allocations of the selected slaves in the Registered Device List.
Edit Button	Allows manual allocation through the Edit Window.
Information Button	Displays slave information items (i.e., the allocation area and I/O comment data).
Memory Blocks	Displays the allocation status of each slave (product name) of block 1 and block 2.
Ch	Bit address where allocation starts. The first bit address will be displayed after the word address.
Product Name	Block 1 and block 2
Setup Button	Sets the first address and first address size (i.e., the number of words) of block 1 or block 2.

## 6-8 Manual I/O Allocations

### 6-8-2 Changing the First Address of Output/Input Block

#### Allocation Status of Blocks 1 and 2

The block allocation status list displays the words of the CPU Unit and the product names of devices allocated in the respective areas of the CPU Unit.

The start bit and the word address for each device are indicated in the *Ch* column.

Example:

3300:Bit00: Starts with bit 00 (LSB) of word CIO 3300.

3300:Bit08: Starts with bit 08 (MSB) of word CIO 3300.

Ch	Product Name
3300:Bit00	#02 DRT1-MD16C...
3300:Bit08	
3301:Bit00	#03 DRT1-ID16-1

Word address (Example 3300)

First bit address (Bit00)

Example: Allocation starts with bit 00 (LSB) of word CIO 3300.

Product name of slave

Allocated the bytes beginning with bit 08 of word CIO 3300. Therefore, the product name for 3300:Bit08 is left blank.

No words in the CPU Unit will be displayed for any memory block that is not in use.

### 6-8-2 Changing the First Address of Output/Input Block

#### Component - Parameter - Edit - I/O Allocation Tab - Setup Button

To change the output/input block allocation areas in the I/O memory of the CPU Unit, use the following procedure.

1. Click the **Setup** Button of the block to be changed.
2. The following dialog box will be displayed.

Area : I/O Relay

Start Word : 3300 Range : 0000 - 6143

Words : 100 Range : 1 - 500 Ch

OK Cancel



6-8-2 Changing the First Address of Output/Input Block

- Set the area, start word, and the number of words for the block.  
The number of words to be displayed in a block by the CX-Integrator is set in the Words field. For the CS1W-DRM21(-V1) or CJ1W-DRM21, the maximum number of words that can be allocated to one block is 500. For the C200HW-DRM21-V1 and CVM1-DRM21-V1, the maximum number of words that can be allocated to one block is 100.

The ranges that can be set are shown below.

• **CS1W-DRM21(-V1) or CJ1W-DRM21**

PLC model	Data area	Range
CS Series or CJ Series	CIO Area	0000 to 32767
	DM Area	DM 0000 to DM 8191
	Work Area	WR 000 to WR 511
	HR Area	HR 000 to HR 511
	EM Area	EM 00000 to EM 32767

Banks 0 to 12 of the EM area can be used.

• **C200HW-DRM21-V1**

PLC model	Data area	Range
C200HS	IR/SR Area	000 to 511
	HR Area	HR 00 to HR 99
	LR Area	LR 00 to LR 63
	DM Area	DM 0000 to DM 5999
C200HE-CPU11	IR/SR Area	000 to 511
	HR Area	HR 00 to HR 99
	LR Area	LR 00 to LR 63
	DM Area	DM 0000 to DM 4095
C200HX/C200HG/ C200HE(-Z) other than the above	IR/SR Area	000 to 511
	HR Area	HR 00 to HR 99
	LR Area	LR 00 to LR 63
	DM Area	DM 0000 to DM 5999

• **CVM1-DRM21-V1**

PLC model	Data area	Range
CV500,CVM1-CPU01	IR/SR Area	0000 to 2555
	CPU Bus Link Area	G 000 to G 511
	DM Area	DM 0000 to DM 8191
CV Series and CVM1 other than the above	IR/SR Area	0000 to 2555
	CPU Bus Link Area	G 000 to G 511
	DM Area	DM 00000 to DM 24575

**Note**

- *Words* refers to the number of words in the block displayed on the CX-Integrator. This value is not downloaded to the master.
- If the occupied area of the block is less than 100 words when uploaded, *Words* will be set to 100 and displayed as such.

- Click the OK Button. The memory block will be changed by clicking on OK.  
If a device has already been allocated, it will be allocated to a new memory block.  
If an area-over error occurs, however, the allocation of the device will be canceled.  
Reallocate the device, if necessary.

### 6-8-3 Allocating I/O

#### Component - Parameter - Edit - I/O Allocation Tab

The following three methods are supported for I/O allocation.

- 1) Manual Allocation through the Edit Window  
Select the slave from the Registered Device List, click the **Edit** Button and use the Edit Window to manually allocate the slave.
- 2) Drag-and-drop Allocation  
Drag the slave from the Registered Device List and drop the slave at the desired work position in the memory block.
- 3) Automatic Allocation  
Select the slaves from the Registered Device List and click the **Auto** Button. The slaves will be automatically allocated in units of words in the order of earlier addresses. If the user has made connections settings in the **General** Tab Page with the advanced setup function, automatic allocation will not be possible.

Note The I/O data size of devices will be displayed in the *Size* column of the Registered Device List as shown below if connections settings have been made for the devices.

Name	Size	Ch
ProductCode (...)	4, 4 Byte	

To allocate the I/O data on the left-hand side with the mouse, drag and drop the I/O data with the left mouse button. To allocate the I/O data on the right-hand side, drag and drop the I/O data with the right mouse button. If there is only a single connection, use the left mouse button.

## Manual Allocation through the Edit Window

### I/O Allocation Tab - Edit Button

To make allocations through the Edit Window, use the following procedure.

1. Select the device to edit the I/O allocations of the device.
2. Click the **Edit** Button.
3. The following I/O Allocation Dialog Box will be displayed.  
Specify block 1 or block 2, allocation word, start byte (LSB: Low or MSB: High), and the number of allocated bytes.

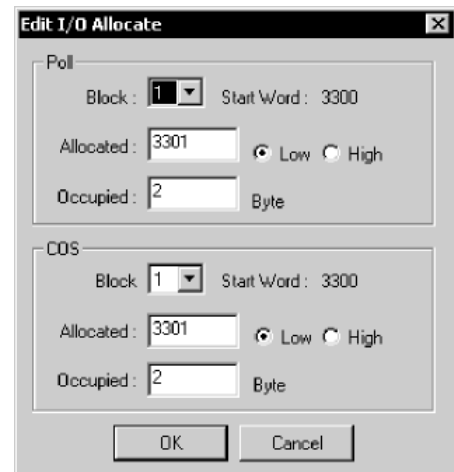
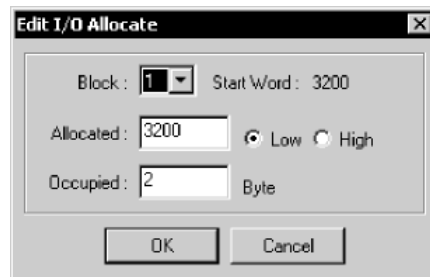

Connections are specified in the General tab with the advanced setup function.

Specify the first word to allocate and the number of allocated words. The MSB (high) or LSB (low) position can be set for the first word to allocate. The user must set the byte position to LSB if the number of bytes allocated is 2 or more.

- **Example: Device with 1 byte allocated in the LSB.**

	High	Low
	15	8 7 0
+0 word		#00
+1 word		
+2 word		

- **Example: Device with 1 byte allocated in the MSB.**

	High	Low
	15	8 7 0
+0 word	#00	
+1 word		
+2 word		

4. Click the **OK** Button to start I/O allocation.

## Drag and Drop

### Drag and Drop on I/O Allocation Tab Page

1. Display the Memory Block List.
2. Select the slave from the Registered Device List.
3. Drag the slave to the first byte of the desired position.

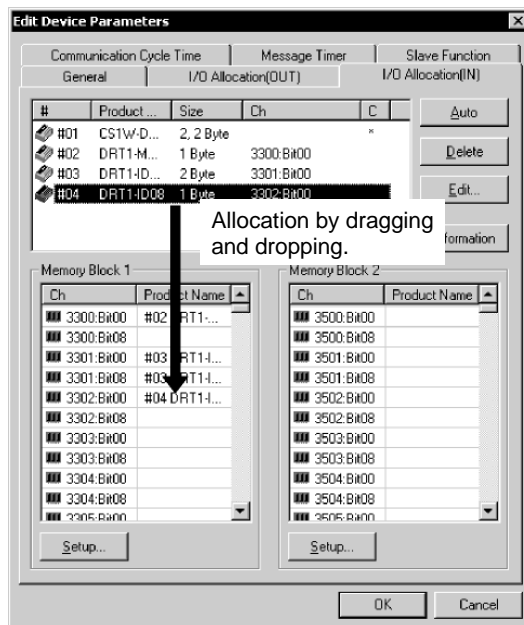

- Memory Block List

In the Memory Block List, the *Ch* column displays each byte address (the word and first bit addresses). The *Product Name* column displays the product name for the slave.

- Registered Device List

The # column of the Registered Device List displays the node address, the *Product Name* column displays the product name of the slave, and the *Size* column displays the number of allocated bytes for the slave. The *Ch* column displays the first byte (the word and first bit addresses) of the slave allocated.

To unregister the allocations of slaves, select the slaves in the Registered Device List, and click the **Delete** Button.

Note To register in units of words the slaves in the order of earlier addresses, select the slaves in the Registered Device List, and click the Auto Button.

## Automatic Allocation

### I/O Allocation Tab - Register/Unregistered (Allocate/Unallocated) Button

Note This procedure is the same for the CS1W-DRM21(-V1), CJ1W-DRM21, CVM1-DRM21-V1, and C200HW-DRM21-V1.

- To allocate in units of words the selected slaves to an unoccupied area in the order of earlier addresses, click the **Auto** Button.
  - To unregister the allocations of the selected slaves, click the **Delete** Button.
- The advanced setup function (to be explained later) is not possible while automatic allocation is specified.

## 6-8-4 Slave Information

### I/O Allocation Tab - Information Button

Device information on registered slaves, such as I/O comments, can be checked with the I/O Allocation Tab Page. The I/O comment is set to the I/O data of a slave by selecting *Edit I/O Comment* from the Device Menu.

To display information on the slave, use the following procedure.

1. Select the device.
2. Click the **Information** Button.  
The following dialog box will be displayed.

#03 C200HW-DRT21 Information

Description : C200HW-DRT21  
MAC ID : #03  
Vendor : OMRON Corporation  
Device Type : Communications Adapter  
Product Code : 51  
Product Name : C200HW-DRT21  
Status : Registered to #02

Poll

OUT Size : 2 Byte

Area	Bit	Comment
3201	Bit00	OUT Comment1
3201	Bit06	OUT Comment2
3201	Bit12	OUT Comment3

IN Size : 2 Byte

Area	Bit	Comment
3301	Bit02	IN Comment1
3301	Bit05	IN Comment2
3301	Bit15	IN Comment3

Close

When the registered device is selected in the above dialog box, the slave information will be refreshed to information on the selected device.

## 6-9 Advanced Settings (Connection, Communication Cycle Time, Slave Function Settings, Etc.)

### 6-9-1 Advanced Settings

## 6-9 Advanced Settings (Connection, Communication Cycle Time, Slave Function Settings, Etc.)

The following description provides information on the connection, device information display and check, communication cycle time, message timer, and slave function settings.

### 6-9-1 Advanced Settings

**Select Component - Parameter - Edit, and click the General Tab. Select the slave and click the Advanced Setup Button.**

Make advanced setup settings (such as device information display/compare and connections settings) for remote I/O communications.

Note: These settings are supported for the CS1W-DRM21(-V1) and CJ1W-DRM21 only.

#### Device Information Display/Compare Settings

##### Device Information Tab Page

The following settings make it possible to display or compare device information on slaves.

Use the following procedure.

1. Select the slave from the Registered Device List.
2. Click the **Advanced Setup** Button.
3. The following dialog box will be displayed.  
Click the **Device Information** Tab.

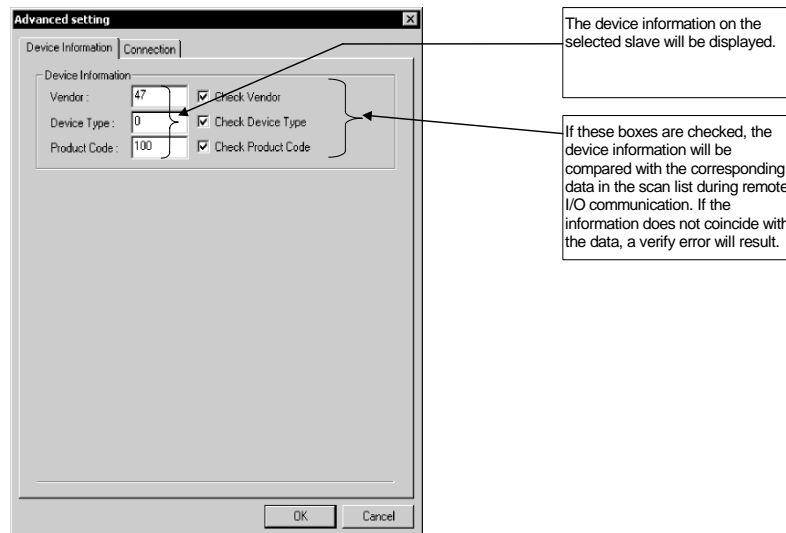

The device information (consisting of vendor, device type, and product code data) on the selected slave is displayed.

By checking the above boxes, the device information will be compared with the corresponding data in the scan list when I/O communication connections are established.

**Connections**

**Connection Tab Page**

When the user specifies the connections for remote I/O communications, up to two connections can be set for each slave.

Use the following procedure.

1. Select the slave in the Registered Device List.
2. Click the **Advanced Setup** Button.
3. The following dialog box will be displayed.  
Click the **Connection** Tab.

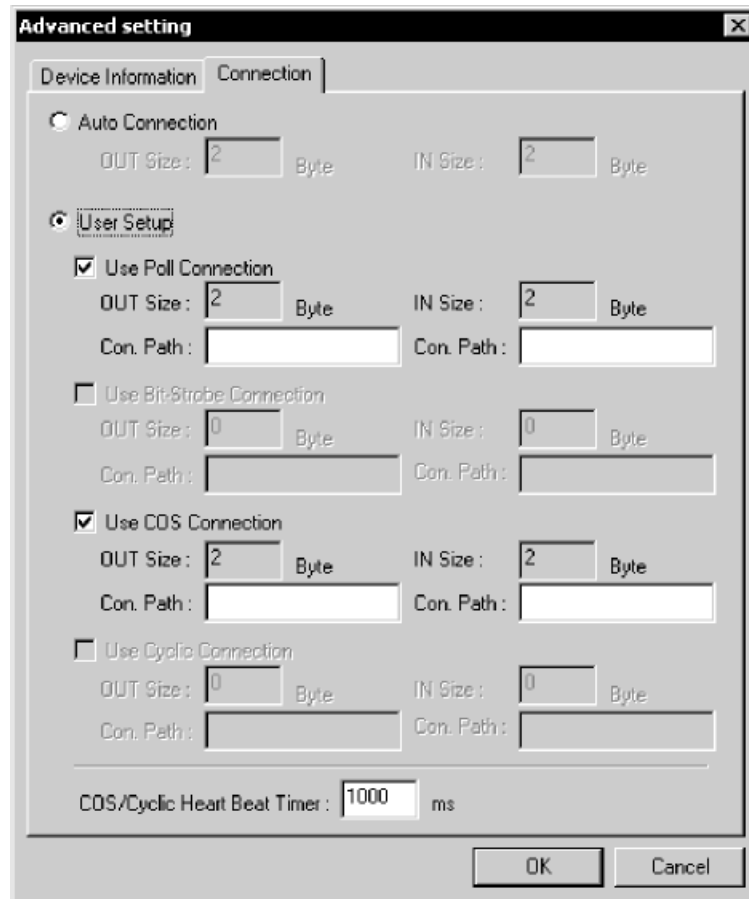

Automatic connections are set by default. To specify the connections, use the following procedures.

1. Select **User Setup**.  
Possible connections are ready for selection.
2. Select the connections.  
Up to two connections can be selected.  
Note Both *COS* and *Cyclic* cannot be specified at the same time.
3. Set the connection path as needed.
4. Set the COS/Cyclic heart beat timer.
5. Click the **OK** Button.

An asterisk (\*) will be displayed in the C column at the right edge of the Registered Device List. If the connections of a device already allocated with I/O are changed, the previous I/O allocations will be canceled. Make the I/O allocations again.

## 6-9 Advanced Settings (Connection, Communication Cycle Time, Slave Function Settings, Etc.)

### 6-9-2 Communication Cycle Time Settings

#### Note

- Both COS and Cyclic settings cannot be made at the same time.
- If *Poll* and *COS* settings or *Poll* and *Cyclic* settings are used in combination, check that the output settings of the both connections are the same.
- The automatic allocation function is not possible for devices if the user already made connections settings for the devices with the advanced setup. 3. Unregister and register the devices so that the automatic allocation function will be available for the devices.

### 6-9-2 Communication Cycle Time Settings

#### Component - Parameter - Edit - Communication Cycle Time Tab

Note: This procedure is the same for the CS1W-DRM21(-V1), CJ1W-DRM21, CVM1-DRM21-V1, and C200HW-DRM21-V1.

It is possible to set the communication cycle time on the Communication Cycle Time Tab Page. Furthermore, it is possible to check the present communication time calculated from the registered device information.

The following dialog box will be displayed by clicking on the Communication Cycle Time Tab.

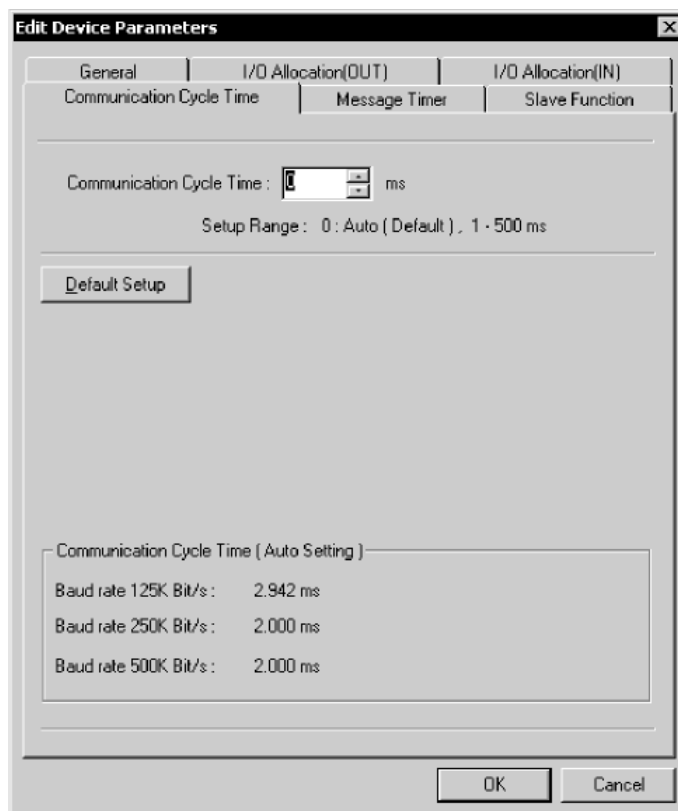

Set the communication cycle time between 1 and 500 ms. To set the communication cycle time automatically, click the **Default Setup** Button or set the communication cycle time to 0 ms.

The communication cycle time set will be automatically calculated and displayed according to the registered device information and the baud rate.



**Note** Communication cycle time refers to the required time of remote I/O communications between the master and a slave. Communication cycle time settings properly made will prevent the fluctuation of the time of remote I/O communications with the slave. Furthermore, by setting the communication cycle time to a larger value, the prolonged processing operation of the slave will not be treated as a communications error. If the actual remote I/O communications time is shorter than the set communication cycle time, the remote I/O communications will keep pace with the communication cycle time. If actual I/O communications take longer than the set communication cycle time, the I/O communications will be continued regardless of the set communication cycle time.

### 6-9-3 Setting Message Timers

#### Component - Parameter - Edit - Message Timer Tab

Note: This procedure is supported by the CS1W-DRM21(-V1) and CJ1W-DRM21 only.

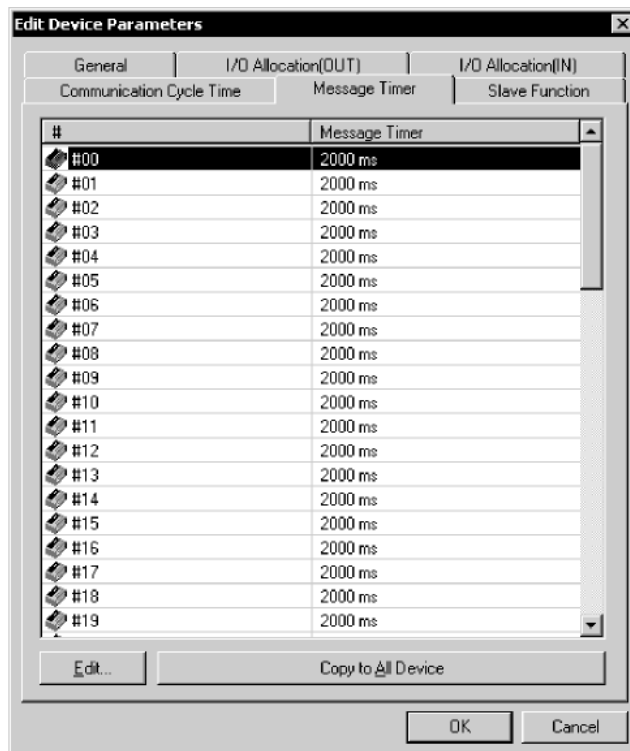

A message timer is by default set to 2 s (2000 ms). They can be set 1-ms increments to between 500 and 30,000 ms.

To change a message timer value, use the following procedure.

1. Double-click the node address (#) or select the node address and click the **Edit** Button. The following dialog box will be displayed.



2. Set the value and click the **OK** Button.

Note To set the same value for all the devices, select the node addresses and click the **Copy to All Device** Button.

## **6-9 Advanced Settings (Connection, Communication Cycle Time, Slave Function Settings, Etc.)**

### **6-9-3 Setting Message Timers**

**Note** The message timer is used to monitor the time of message communications (explicit message communications time and FINS message communications time). The message timer can be set for each destination device independently. If the response of a destination device is slow, the timer value must be set to a larger value. The response may be slow for multilevel FINS message communications. The next message cannot be sent to the same device until the response is returned. The DeviceNet master monitors the time-out period of the message with this timer. The CPU Unit, however, is responsible for monitoring the response time with the CMND, SEND, and RECV instructions. Therefore, it is meaningless if only the timer value or monitor time is changed for the CMND, SEND, RECV instructions. Set the response monitor time with the CMND, SEND, and RECV instructions to a value larger than the timer value. Set both of them to larger values but the value of response monitor time must be still longer than the timer value if a time-out error occurs frequently.

## 6-9-4 Slave Function Settings

### Component - Parameter - Edit - Slave Function Tab

Note: This procedure is supported for the CS1W-DRM21(-V1) and CJ1W-DRM21 only.

The slave function is enabled through settings made in the Slave Function Tab Page.

**Note** To enable the slave function with the CS1W-DRM21(-V1) or CJ1W-DRM21, select the device first, and then select **Device – Property**, and select *Enable slave Function* in the CS1W-DRM21(-V1) or CJ1W-DRM21 Properties Dialog Box.

To set the slave function, use the following procedure.

1. Click the **Slave Function Tab**.

The following dialog box will be displayed.

2. Specify the connections.

Automatic settings are by default set. If the user specifies the connections, click the **User Setup** Button.

3. Set the output and input areas used for remote I/O communications.

Set each area type for *IN* (the slave to the master) and *OUT* (the master to the slave), start words, and allocated sizes.

If the user's connections settings are used, make all connections settings.

Up to two connections can be set.

**Note**

- Both *COS* and *Cyclic* settings cannot be made at the same time.
- If *Poll* and *COS* settings or *Poll* and *Cyclic* settings are used in combination, check that the *OUT* settings of the both connections are the same.

## 6-9 Advanced Settings (Connection, Communication Cycle Time, Slave Function Settings, Etc.)

### 6-9-5 Setting/Canceling Explicit Message Communications

#### 6-9-5 Setting/Canceling Explicit Message Communications

##### Component - Parameter - Edit - General Tab - Explicit Message

##### Communications Box

Note: This procedure is supported for the CVM1-DRM21-V1 and C200HW-DRM21-V1 only.

Specify whether or not to enable explicit message communications (transmissions only) without remote I/O communications. Check the box to enable explicit message communications only.

**Note** For the CS1W-DRM21(-V1) and CJ1W-DRM21, slaves with explicit message communications only do not have to be registered. Explicit message communications is possible regardless of the scan list registration.

#### 6-9-6 Starting Remote I/O Communications

##### Component - Parameter - Edit - General Tab - Start Remote I/O

##### Communication at Start-Up Box

Note: This procedure is supported for the CVM1-DRM21-V1 and C200HW-DRM21-V1 only.

Specify whether or not to enable remote I/O communications automatically. Check the box to start remote I/O communications automatically when the master is started.

**Note** For the CS1W-DRM21(-V1) and CJ1W-DRM21, remote I/O communications upon start-up can be disabled by disabling the master function. Select **Component** then click the **Unit Function** Tab of the Property Window, and remove the check mark from Enable Master Function.

## 6-10 Creating and Editing I/O Comments

### Component - Edit I/O Comment

The CX-Integrator can be used to add comments to I/O data of slaves. The I/O comments can be checked while making I/O allocations to the master.

**Note** No I/O comments can be created or edited for a device if the device is not designed to have I/O data.

To edit I/O comments, use the following procedures.

1. Select the device.
2. Select **Component - Edit I/O Comment** (or select the slave, click the right mouse button, and select **Edit I/O Comment**).

The following dialog box will be displayed.

Area	Bit	Comment
0000	Bit00	OUT Comment1
0000	Bit01	
0000	Bit02	
0000	Bit03	
0000	Bit04	
0000	Bit05	
0000	Bit06	OUT Comment2
0000	Bit07	
0000	Bit08	
0000	Bit09	
0000	Bit10	
0000	Bit11	
0000	Bit12	
0000	Bit13	
0000	Bit14	
0000	Bit15	OUT Comment3

An I/O comment can be created for each connection supported by the device. If areas have been already allocated to the master, they will be displayed.

- Note**
- If an area is not allocated to a master, the display will show 0000, the default area.
  - Edited I/O comments can be exported in the CSV format by selecting **Export and I/O Comment List**. Part of I/O comment data exported in the CSV format can be opened in spreadsheet software and used for CX-Programmer variable tables.

## 6-10 Creating and Editing I/O Comments

3. Select the bit where the I/O comment should be set and press the **Enter** Key (or click the bit position).

Data can be input into the comment area as shown below.

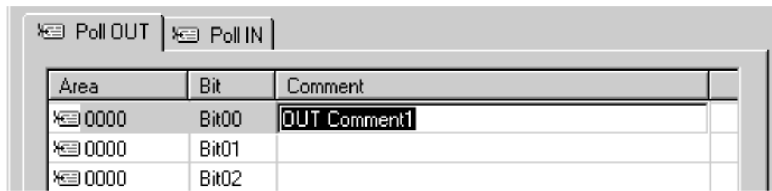

Area	Bit	Comment
%I 0000	Bit00	OUT Comment1
%I 0000	Bit01	
%I 0000	Bit02	

4. Input the comment and press the **Enter** Key.  
To cancel the input, press the **ESC** Key.
5. Set all comments and click the **OK** Button.

## 6-11 Displaying Device Properties

### Component - Property

This section explains device information on network devices.

Device properties are classified into those common to all devices and those inherent to each device.

To display the device properties, use the following procedure.

1. Select the device.
2. Select **Component - Property**.
3. The Property Dialog Box will be displayed.

### 6-11-1 Property Dialog Box Common to All Devices

The following window will be displayed for device properties.



This dialog box has the name of the vendor of the device and the device type.

By clicking the **Change Icon** Button, the icons displayed by the CX-Integrator can be customized.

To change the icon to standard ones, click the **Default Icon** Button.

## 6-11 Displaying Device Properties

### 6-11-2 I/O Information Inherent to Each Slave Device

#### 6-11-2 I/O Information Inherent to Each Slave Device

The following I/O Information Tab Page will be displayed.

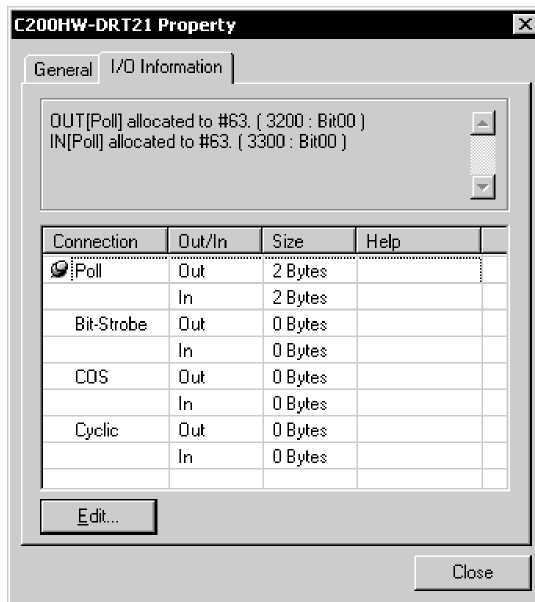

Supported I/O connection information defined by the EDS file will be displayed as slave I/O information properties. If the I/O allocations are made to another master, the I/O allocation information will be displayed together.

The following icon will be displayed next to I/O connection information items registered as default I/O connections in the EDS file.

Connection	Out/In	Size	Help
Poll	Out	2 Bytes	
	In	64 Bytes	
Bit-Strobe	Out	0 Bytes	
	In	0 Bytes	
COS	Out	0 Bytes	
	In	0 Bytes	
Cyclic	Out	0 Bytes	
	In	0 Bytes	

#### Setting I/O Sizes

If there is no EDS file or the slave's I/O size is variable, the I/O size can be changed using the following procedure.

1. Click the **Edit** Button. The Edit I/O Size Dialog Box will be displayed.

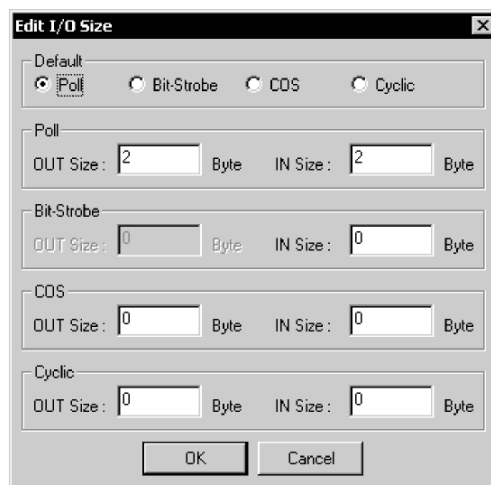

2. Select the default connection type.  
The size of each connection can be set by selecting *Poll*, *Bit-Strobe*, *COS*, or *Cyclic*.



3. Click the **OK** Button.

### **Obtaining I/O Size Information from the Master Scan List**

When connecting the CX-Integrator to a network that is already operating, for example using OMRON Master Units with fixed allocation, the slave I/O size can be obtained from the master scan list for use in setting.

However, this is possible only with OMRON masters. Also, the slave I/O size cannot be obtained from the slave function of the CS1W-DRM21(-V1) or CJ1W-DRM21.

Use the following procedure to obtain the I/O size from a master scan list.

1. Select the desired slave, then select **Component - Property**.
2. Click the **I/O Information** Tab.
3. Click the Get I/O Size from the Scanlist Button.

### **Parameter Auto Update when I/O Size Changed**

The function to automatically update the I/O size registered on the master scan list when the I/O size is changed can be switched ON or OFF.

To automatically update the I/O size registered on the master scan list, select **Tools - DeviceNet tool - Parameter Auto Update When I/O Size Changed**.

When this function is enabled, the  mark will be displayed in the menu. The default is set to not automatically update.

**Note** If the function to automatically update the I/O size is enabled and there is no EDS file, some operations will cause the I/O size in the master scan list to be updated to zero. For this reason, the function to automatically update the I/O size should normally be disabled.

## 6-11 Displaying Device Properties

### 6-11-3 Information for Master

#### 6-11-3 Information for Master

OMRON's CVM1-DRM21-V1, C200HW-DRM21-V1, CS1W-DRM21(-V1) and CJ1W-DRM21 have an Master I/O Information Tab Page and PLC Information Tab Page.

#### **CS1W-DRM21(-V1) and CJ1W-DRM21 DeviceNet Unit**

- Master I/O Information

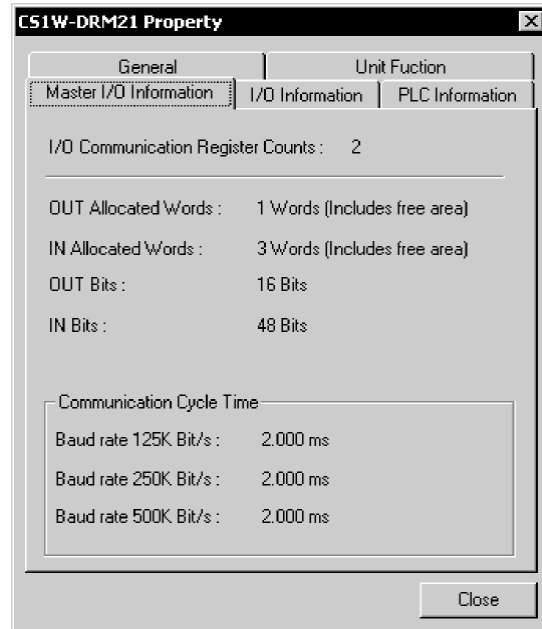

The following master I/O information will be displayed.

Item	Description
I/O Communication Register Counts	The number of devices registered as remote I/O communications devices in the scan list.
OUT/IN Allocated Words	The number of allocated words including the unused words from the first memory block set in the scan list.
OUT/IN Bits	The number of actual I/O bits for remote I/O communications devices.
Communication Cycle Time	The communication cycle time based on the device information in the scan list. If the user has set the communication cycle time, the user's set value will be displayed.

• PLC Information

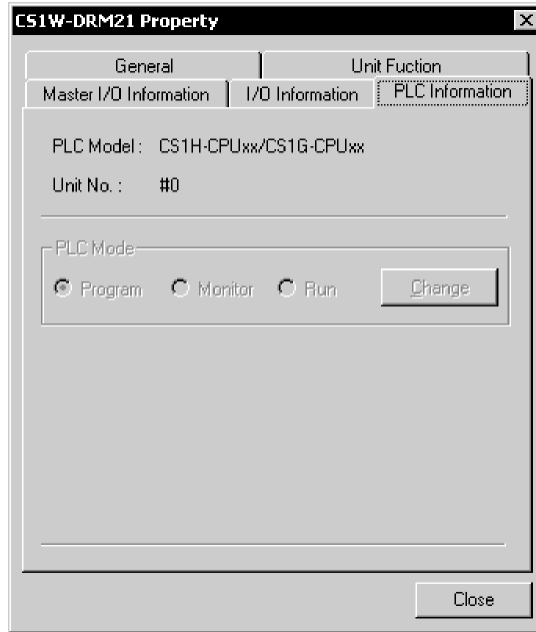

The name of the PLC model in use and the unit number of the master will be displayed as PLC Information. The operating mode of the PLC will be displayed online. To change the PLC mode, click the **Change** Button.

**CVM1-DRM21-V1 and C200HW-DRM21-V1**

• Master I/O Information

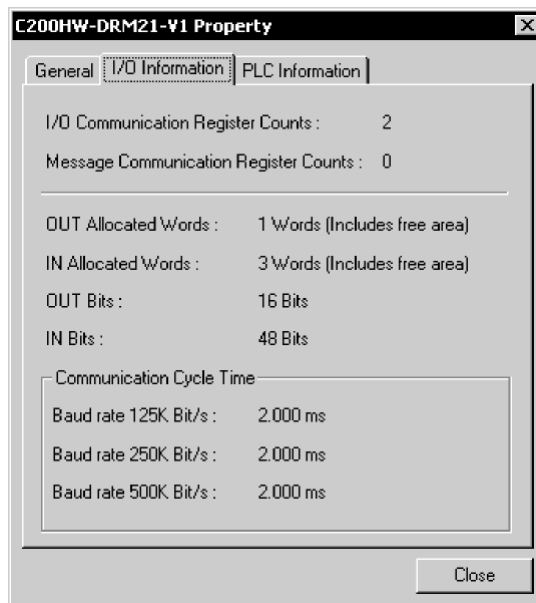

The following master I/O information will be displayed.

Item	Description
I/O Communication Register Counts	The number of devices registered as remote I/O communications devices in the scan list.
Message Communication Register Counts	The number of devices registered as message communications devices with the scan list.
OUT/IN Allocated Words	The number of allocated words including the unused words from the first memory block set in the scan list.
OUT/IN Bits	The number of actual I/O bits for remote I/O communications devices.
Communication Cycle Time	The communication cycle time based on the device information in the scan list. If the user has set the communication cycle time, the user's set value will be displayed.

## 6-11 Displaying Device Properties

### 6-11-3 Information for Master

- PLC Information

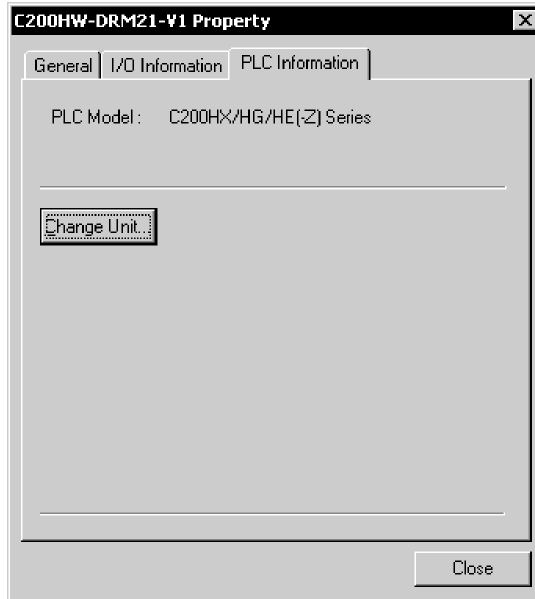

The name of the PLC model in use and the unit number of the master as PLC Information will be displayed. To change the PLC model, click the **Change Unit** Button. If the network configuration is read from the actual network, the PLC model cannot be changed.

### 3G8F7-DRM21

- Master I/O Information

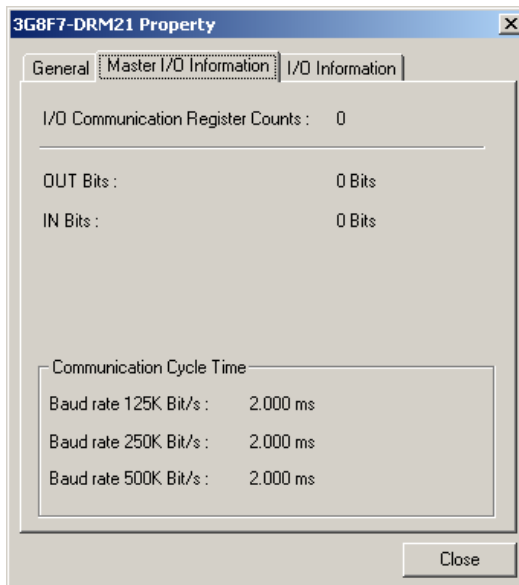

The following master I/O information will be displayed.

Item	Description
I/O Communication Register Counts	The number of devices registered as remote I/O communications devices in the scan list.
OUT/IN Allocated Words	The number of allocated words including the unused words from the first memory block set in the scan list.
OUT/IN Bits	The number of actual I/O bits for remote I/O communications devices.
Communication Cycle Time	The communication cycle time based on the device information in the scan list. If the user has set the communication cycle time, the user's set value will be displayed.

## 6-12 Downloading the Network Configuration/Device Parameters to Devices

This section explains how to write the master and slave parameters that were created on the CX-Integrator to the actual network devices. This process is called downloading.

The following two methods are used to write parameters to network devices.

- 1) Downloading the network configuration
- 2) Downloading parameters for specific devices

### 6-12-1 Downloading the Network Configuration

#### Network - Transfer [PC to Network]

The network configuration download function makes it possible to write and reset the device parameters in the order of node addresses, and enable the new settings.

**Note** When downloading the network configuration, each of the devices is reset. If the Master Unit is reset first, it may cause errors in writing parameters to the subsequent slaves. For that reason, this method (downloading the network configuration) should be used only when the Master Unit has been given the highest address.

To download the network configuration, use the following procedure.

1. Place the CX-Integrator online.
2. Select **Network - Transfer [PC to Network]**.

The following confirmation dialog box will be displayed.

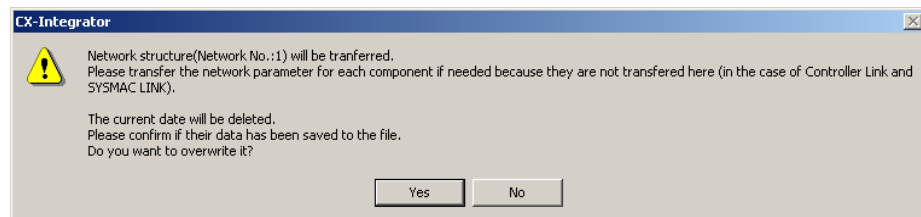

3. Click the **Yes** Button.

The following progress window will be displayed and the downloading of the network configuration will be started.



Note 1. The downloading can be canceled by clicking the **Abort** Button.

2. If an error occurs while the network configuration is downloaded, the following confirmation window will be displayed.

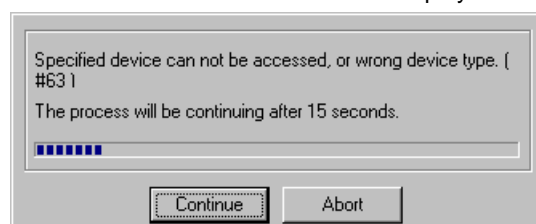

Click the **Continue** Button to continue the process. Click the **Abort** Button to cancel the process.

The downloading of the network configuration will be automatically continued if the user does not click the **Abort** Button for 15 s after the above window is displayed.

## 6-12 Downloading the Network Configuration/Device Parameters to Devices

### 6-12-1 Downloading the Network Configuration

The following window with information on device errors or missing devices will be displayed after the network configuration has been downloaded.

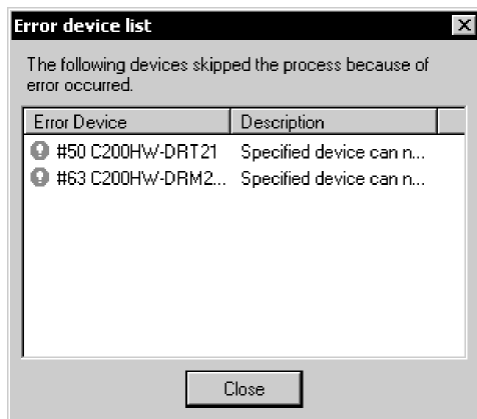

The new settings will be valid when the network configuration is downloaded properly.

#### Note

- Because the devices are reset in order, communications errors will temporarily occur in the master and slaves. For this reason, do not download the network configuration while the master-side PLC (CPU Unit) is operating.
- Parameters cannot be downloaded to the master unless the CPU Unit is in Program Mode. If the message *Device state conflict. Going to change PLC Mode. OK?* is displayed, check the operation mode of the CPU Unit.

## 6-12-2 Downloading Device Parameters

Device parameters are downloaded through the Network Configuration Window or Edit Device Parameters Dialog Box.

- Note**
- Downloaded device parameters will be valid only after the devices are reset unless they are the OMRON CVM1-DRM21-V1, C200HW-DRM21-V1, CS1W-DRM21, or CJ1W-DRM21.
  - The parameters in the CX-Integrator will differ from the actual parameters if the **No** Button is clicked to quit the Edit Device Parameters Dialog Box after the parameters have been downloaded.

### Downloading Parameters through the Edit Device Parameters Dialog Box

#### Component - Parameter - Edit - Download Button

To download the parameters through the Edit Device Parameters Dialog Box, use the following procedure.

1. Place the CX-Integrator online.
2. Select the device.
3. Select **Component - Parameter - Edit**.
4. Click the **Download** Button.

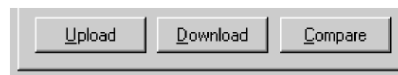

5. The following confirmation dialog box will be displayed.

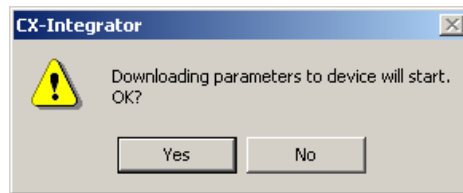

6. Click the **Yes** Button.  
The progress dialog box will be displayed while the parameters are being downloaded.

- Note** When downloading parameters with the Edit Device Parameters Dialog Box, the following dialog box will appear if the operation mode of the CPU Unit is set to anything other than PROGRAM Mode.

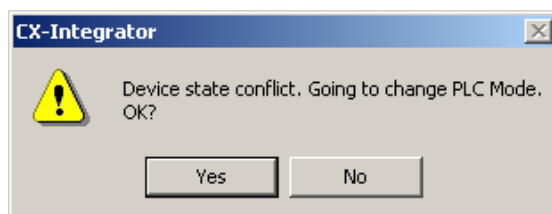

Click the **Yes** Button to change the operation mode of the CPU Unit to PROGRAM Mode and start downloading.

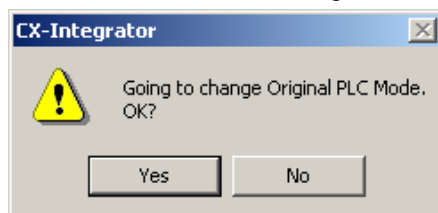

After downloading, this dialog box makes it possible to return to the original operation mode.

### Downloading through the Network Configuration Window

#### Component - Parameter - Download

To download the parameters through the Network Configuration Window, use the following procedure.

1. Place the CX-Integrator online.
2. Select the device or devices. (More than one device can be selected by holding down the Ctrl Key while clicking the devices.)
3. Select **Component - Parameter - Download**.  
The following confirmation dialog box will be displayed.

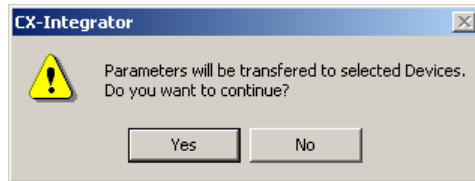

4. Click the **Yes** Button.  
The following progress window will be displayed and the downloading of the parameters will start.



To cancel the downloading, click the **Abort** Button.

The following confirmation window will be displayed if there is an error while the parameters are downloaded.

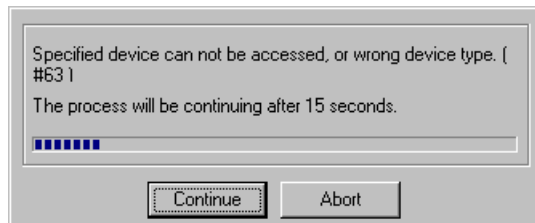

Click the **Continue** Button to continue the process. Click the **Abort** Button to cancel the process.

The downloading of the network configuration will be automatically continued if the user does not click the **Abort** Button for 15 s after the above window is displayed.

The following dialog box with information on device errors or missing devices will be displayed after the parameters have been downloaded.





**Note** Parameters cannot be downloaded to the master through the Network Configuration Window unless the CPU Unit is in Program Mode. If the message *Device state conflict. Going to change PLC Mode. OK?* is displayed, check the operation mode of the CPU Unit.

## 6-12-3 Resetting the Device

### Component - Reset

To enable the new settings, use the following procedure to reset the network device.

1. Place the CX-Integrator online.
2. Select the device in the Network Configuration Window.
3. Select **Device - Reset**.

The following confirmation dialog box will be displayed.

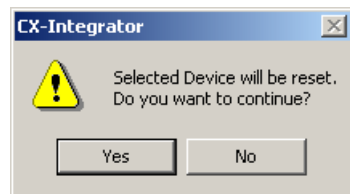

4. Click the **Yes** Button.  
The progress window will be displayed and the devices will be reset.  
The new settings will be valid after the devices have been reset.

**Note** When the devices are reset, communications errors will temporarily occur. For this reason, do not reset the devices while the master-side PLC (CPU Unit) is operating.

## 6-13 Uploading and Verifying Device Parameters

### 6-13-1 Uploading the Network Configuration

## 6-13 Uploading and Verifying Device Parameters

Uploading device parameters refers to writing the parameters from the actual network devices to the virtual network in the CX-Integrator. Verifying device parameters refers to comparing the parameters in the actual network devices with those in the CX-Integrator.

This section explains how to do both of these operations.

**Note** When the network configuration is uploaded, the parameters for each device will all be read.

### 6-13-1 Uploading the Network Configuration

#### Network - Transfer [Network to PLC]

To read the actual network configuration, use the following procedure.

1. While online, right-click the DeviceNet Unit below *TargetPLC* in the Online Connection Information Window and select **Connect** from the popup menu.
2. Right-click the DeviceNet Unit and select **Transfer [Network to PLC]** from the popup menu.

Uploaded devices will be displayed in the Network Configuration Window.

**Note** If the DeviceNet network configuration was being uploaded with the CX-Integrator version 2.1 or higher, and the upload was cancelled or failed, the following dialog box will be displayed the next time that the same network configuration is uploaded. This feature allows you to upload the configuration only for the nodes where the upload failed. (This is the DeviceNet network upload resume function.)

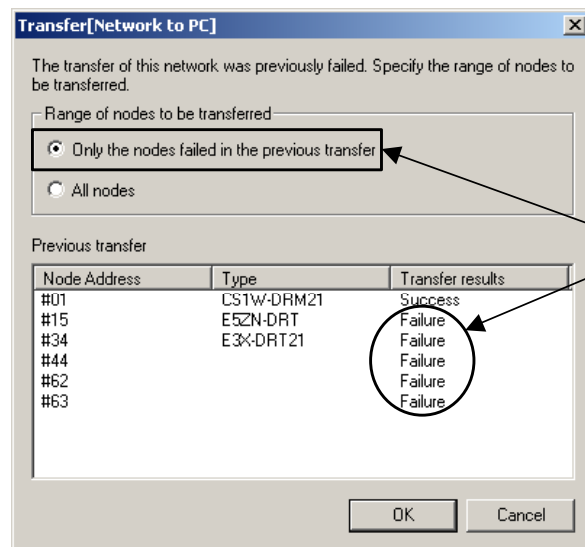

When *Only the nodes failed in the previous transfer* is selected for the transfer method, only the nodes with *Failure* transfer results are transferred.

### 6-13-2 Uploading Device Parameters

The following two methods can be used to read parameters from network devices.

- 1) Reading parameters from the Network Configuration Window
- 2) Reading parameters from the Edit Device Parameters Dialog Box

#### Using Network Configuration Window

##### **Component - Parameter - Upload**

To upload the parameters through the Network Configuration Window, use the following procedure.

## 6-13 Uploading and Verifying Device Parameters

### 6-13-2 Uploading Device Parameters

1. Select the device or devices in the Network Configuration Window. (More than one device can be selected by holding down the Ctrl Key while clicking the devices.)
2. Select **Component - Parameter - Upload**.  
The following confirmation dialog box will be displayed.

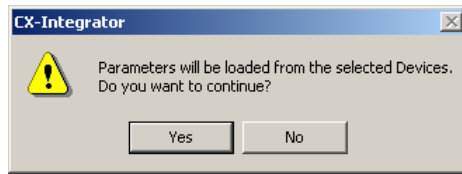

3. Click the **Yes** Button.  
The progress window will be displayed and the parameters will be uploaded.

### Using Parameter Edit Window

#### **Component - Parameter - Edit - Upload Button**

To upload the parameters through the Edit Device Parameters Window, use the following procedure.

1. Select the device from the Network Configuration Window.
2. Select **Component - Parameter - Edit**.
3. Click the **Upload** Button.

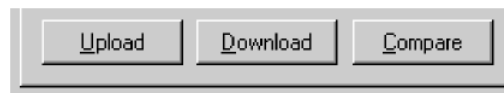

The following confirmation dialog box will be displayed.

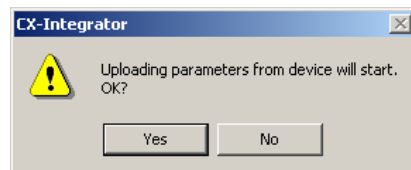

4. Click the **Yes** Button.  
The progress dialog box will be displayed and the parameters will be uploaded.

#### **Note**

- The uploaded parameters will be discarded if the **No** Button is clicked to quit the Edit Device Parameters Dialog Box after the parameters have been uploaded.
- When parameters are uploaded from the Network Configuration Window, an asterisk may be display to the lower left of some devices. This indicates that the I/O size of the device is not consistent with the I/O size in the scan list in the Master Unit. Either select **View - Property**, click the **I/O Information** Tab, click the **Edit** Button, and correct the I/O size, or click the **Get from Scan List** Button and correct the I/O size. If the I/O size registered in the scan list is incorrect, correct the I/O size for the device in the Edit Device Parameter Dialog Box.

## 6-13 Uploading and Verifying Device Parameters

### 6-13-3 Verifying the Network Configuration

#### 6-13-3 Verifying the Network Configuration

Use the following procedure to compare the actual network configuration with the network configuration created on the CX-Integrator.

1. Select the Network Configuration Window to be verified.
2. Select **Network - Compare**.  
The progress window will be displayed and the comparison will begin.
3. If there are any comparison errors, the following dialog box with the details of the errors will be displayed.

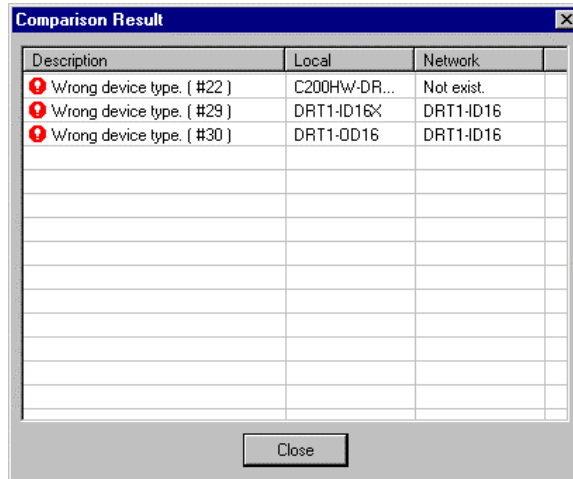

The screenshot shows a dialog box titled "Comparison Result" with a close button in the top right corner. It contains a table with three columns: "Description", "Local", and "Network". The table lists three errors, each preceded by a red circle with a white exclamation mark. The "Close" button is located at the bottom center of the dialog box.

Description	Local	Network
Wrong device type. ( #22 )	C200HW-DR...	Not exist.
Wrong device type. ( #29 )	DRT1-ID16X	DRT1-ID16
Wrong device type. ( #30 )	DRT1-0D16	DRT1-ID16

**Note** This function compares only the network configurations. It does not compare the parameters of each device.



## 6-13 Uploading and Verifying Device Parameters

### 6-13-4 Verifying Device Parameters

#### Using the Edit Device Parameters Dialog Box

##### Component - Parameter - Edit-Compare Button

To compare the parameters through the Edit Device Parameters Dialog Box, use the following procedure.

1. Place the CX-Integrator online.
2. Select the device.
3. Edit **Component - Parameter - Edit**.
4. Click the **Compare** Button.

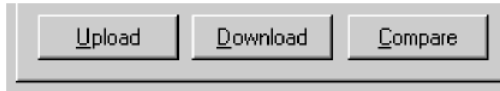

5. The following confirmation dialog box will be displayed.

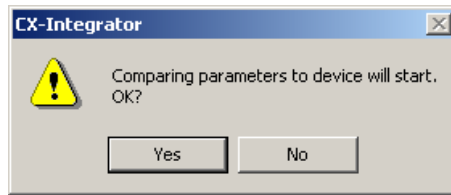

6. Click the **Yes** Button.  
The progress dialog box will be displayed and the comparison results will be displayed.

## 6-14 Monitoring Devices

The following description explains how to use monitor the device or communications.

**Note** The device to be monitored through the Network Configuration Window must exist on the actual network. Before monitoring the status of the monitor, upload the network configuration.

### 6-14-1 Setting Monitor Refresh Timer

#### Tools - DeviceNet tool - Setup Monitor Refresh Timer

Set the interval to refresh the device monitor display. This setting will be applied to the monitoring of any network device.

**Note** If the refresh timer is set to too small a value, the DeviceNet network will be overloaded and the CX-Integrator may experience timeout errors (device access errors).

To set the monitor refresh timer, use the following procedure.

1. Select **Tools - DeviceNet tool - Setup Monitor Refresh Timer**.  
The following dialog box will be displayed.



2. Select the new timer value and click the **OK** Button.  
The set value will be enabled for the next device monitor operation.

## 6-14 Monitoring Devices

### 6-14-2 Monitoring Devices

## 6-14-2 Monitoring Devices

### Component - Monitor

To monitor the device, use the following procedure.

1. Place the CX-Integrator online.
2. Select the device.
3. Select **Component - Monitor**.  
A monitor dialog box for the device will be displayed.

#### **Note**

- A Slave can be monitored only if the slave has parameters that can be monitored in the EDS file.
- Monitor cannot be selected if the device selected has no monitoring function.

4. To quit the monitor function, click the **Close** Button.

### CS1W-DRM21(-V1) or CJ1W-DRM21 DeviceNet Unit

The monitor window for the CS1W-DRM21(-V1) or CJ1W-DRM21 makes it possible to monitor the following items.

<b>Tab</b>	<b>Monitor item</b>
Status	Status of the master and slaves
Unit Status	Status of the functions of the Unit
Communication Cycle Time	Communication cycle time
Error History	Error history



**Status Tab Page**

The Status Tab Page displays the status of the master and slaves in remote I/O communications.

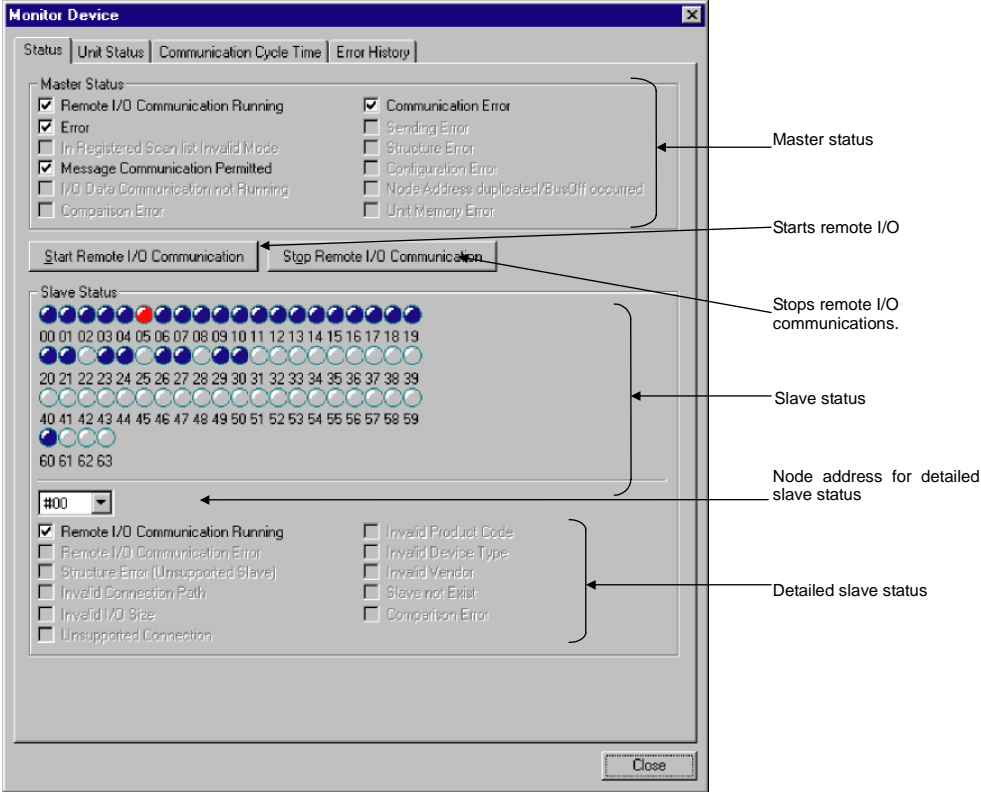

Remote I/O communications between the master and slaves can be started or stopped by clicking the **Start Remote I/O Communication** or **Stop Remote I/O Communication** Button.

The slave status indicators change according to the status of the slaves as shown below.

Indicator	Status
Gray	Device not registered
Green	I/O communications stopped
Blue	In normal communications
Red	Communications error

To monitor the detailed status of another slave device, select the corresponding node address.

## 6-14 Monitoring Devices

### 6-14-2 Monitoring Devices

#### Unit Status Tab Page

The Unit Status Tab Page displays the status of the Unit, master, and slave functions.

The screenshot shows the 'Monitor Device' window with the 'Unit Status' tab selected. The window has a title bar with a close button. Below the title bar are four tabs: 'Status', 'Unit Status', 'Communication Cycle Time', and 'Error History'. The 'Unit Status' tab is active and contains three main sections: 'Unit Status', 'Master Function Status', and 'Slave Function Status'. Each section has a list of checkboxes for various status indicators. Below each section is an 'I/O Allocation Status' label and a 'Configurator Setup' button. The 'Unit Status' section includes 'Online', 'Remote I/O Communication Running', 'Enable Master Function', 'In Registered Scan List Invalid Mode', 'Enable Slave Function', 'Slave Connection Type (Automatic)', 'File Read/Write Error', 'Error History', 'Invalid Message Timer List', 'Routing Table Error', 'Send Time-Out', 'Network Power Error', 'Node Address duplicated', 'BusOff occurred', 'Unit Memory Error', 'Slave Function Error occurred', and 'Master Function Error occurred'. The 'Master Function Status' section includes 'I/O Data Communication Running', 'Failed to set Communication Cycle Time', 'Failed to register/clear Scan List', 'Failed to set Fixed Allocation Area', 'Failed to set User Allocation Area', 'Failed to enable/disable Master Function', 'Remote I/O Refresh Error', 'Invalid Scan List Data', 'Remote I/O Communication Error', 'Structure Error', and 'Comparison Error'. The 'Slave Function Status' section includes 'Remote I/O Communication Running (OUT1/IN1)', 'Remote I/O Communication Running (OUT2/IN2)', 'Connection1 Established', 'Connection2 Established', 'Failed to send COS', 'Failed to set Fixed Allocation Area', 'Failed to set User Allocation Area', 'Failed to enable/disable Slave Function', 'Remote I/O Refresh Error', 'Invalid Setup Data', 'Remote I/O Communication Error (OUT1/IN1)', and 'Remote I/O Communication Error (OUT2/IN2)'. At the bottom right of the window is a 'Close' button.

#### Communication Cycle Time Tab Page

The Communication Cycle Time Tab Page displays the present, maximum, and minimum values of communication cycle time.

The screenshot shows the 'Monitor Device' window with the 'Communication Cycle Time' tab selected. The window has a title bar with a close button. Below the title bar are four tabs: 'Status', 'Unit Status', 'Communication Cycle Time', and 'Error History'. The 'Communication Cycle Time' tab is active and displays three rows of information: 'Current Value : 8 ms', 'Maximum Value : 14 ms', and 'Minimum Value : 8 ms'. Each row has a 'Clear' button to its right. At the bottom right of the window is a 'Close' button.

The maximum or minimum value can be cleared by clicking the **Clear** Button.

**Error History Tab Page**

The Error History Tab Page displays the error history recorded in the master.

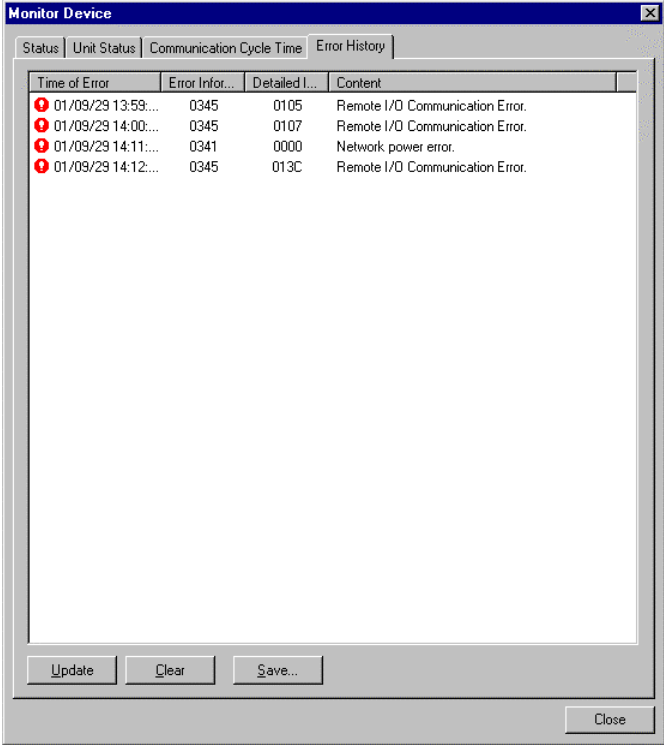

The following error history items will be displayed.

Item	Description
Time of Error	The time the error occurred.
Error Information	Error code
Detailed Information	Detailed error information
Content	Contents of error

To refresh the display, click the **Update** Button.  
 To clear the error history from the master, click the **Clear** Button.  
 To save the file in CSV file format, click the **Save** Button.

**CVM1-DRM21-V1 or C200HW-DRM21-V1**

The monitor dialog box of the CVM1-DRM21-V1 or C200HW-DRM21-V1 makes it possible to monitor the following items.

Tab	Monitor item
Status	Status of the master and slaves
Communication Cycle Time	Communication cycle time
Error history	Error history

## 6-14 Monitoring Devices

### 6-14-2 Monitoring Devices

#### Status Tab Page

The Status Tab Page displays the status of the master and slaves in remote I/O communications.

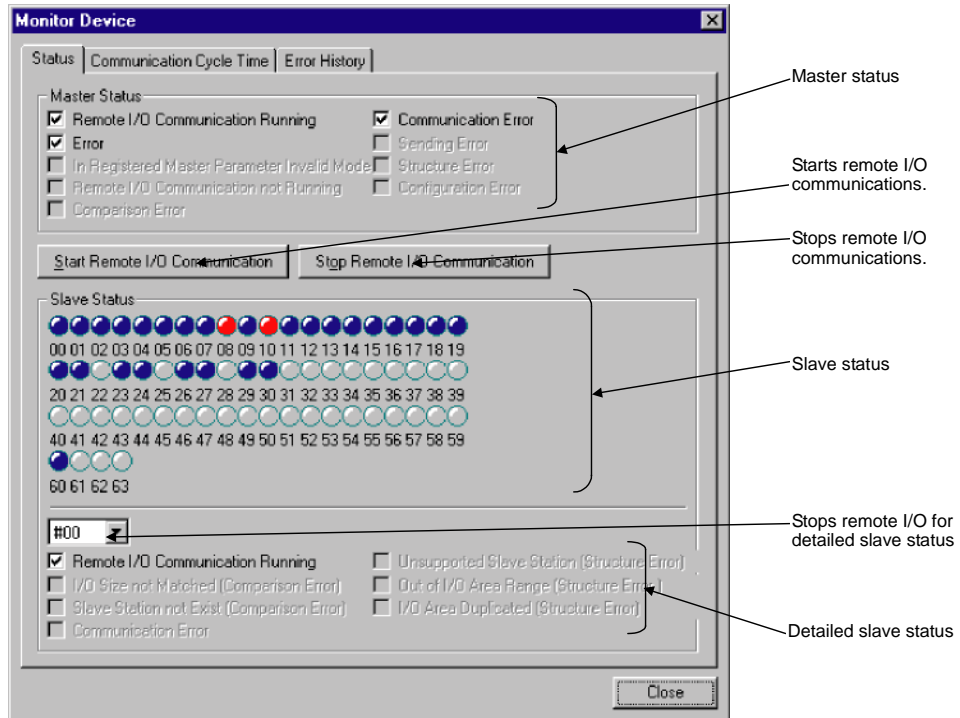

Remote I/O communications between the master and slaves can be started or stopped by clicking the **Start Remote I/O Communication** or **Stop Remote I/O Communication** Button.

The slave status indicators change according to the status of the slave as shown below.

Indicator	Status
Gray	Device not registered
Blue	In normal communications
Red	Communications error

To monitor the detailed status of another slave device, select the corresponding node address.

**Communication Cycle Time Tab Page**

The Communication Cycle Time Tab Page displays the present, maximum, and minimum values of communication cycle time.

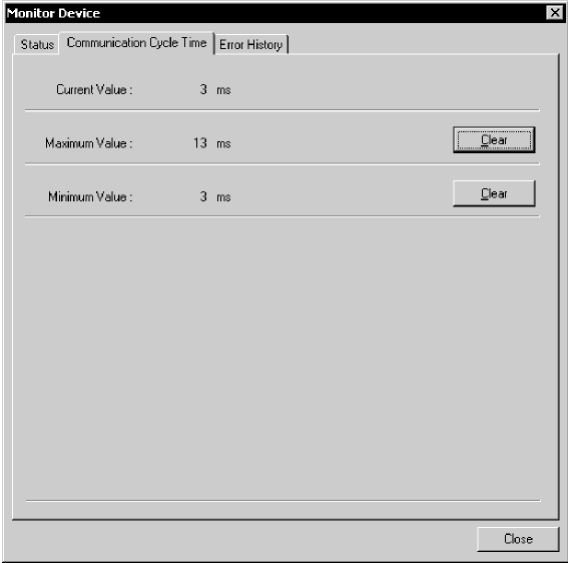

The maximum or minimum value can be cleared by clicking the **Clear** Button.

**Error History Tab Page**

The Error History Tab Page displays the error history recorded in the master.

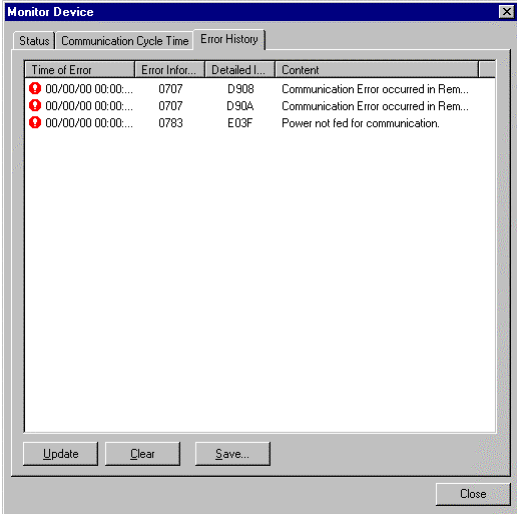

The following error history items will be displayed.

Item	Description
Time of Error	The time the error occurred.
Error Information	Error code
Detailed Information	Detailed error information
Content	Contents of error

To refresh the display, click the **Update** Button.  
 To clear the error history from the master, click the **Clear** Button.  
 To save the file in CSV file format, click the **Save** Button.

## 6-14 Monitoring Devices

### 6-14-2 Monitoring Devices

#### Slaves

Devices can be monitored if the parameters of the devices are specified in EDS files to allow monitoring.

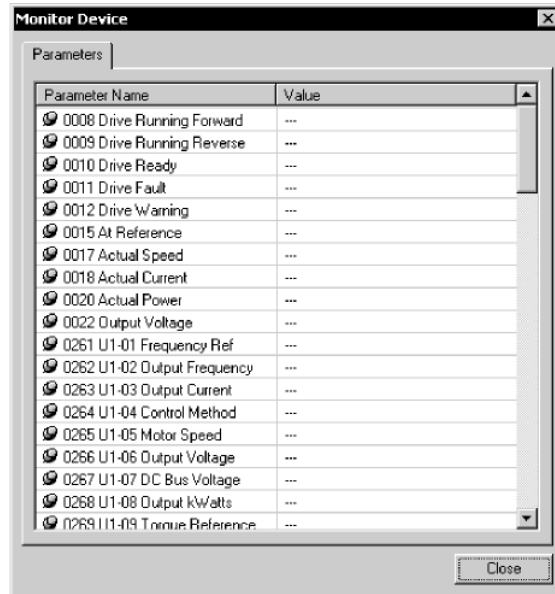

Some OMRON Slaves provide detailed monitoring windows. Refer to the manual for the specific Slave for details.

#### **MULTIPLE I/O TERMINALS**

The monitor window of the DRT1-COM makes it possible to monitor the status and configuration.

The configuration indicates the connected I/O Units. I/O Units with errors will be indicated in red.

#### **Fiber Amplifier Communications Units**

With the E3X-DRT21 Fiber Amplifier Communications Unit, the following window makes it possible to monitor the status of connected sensors.

#### **Smart Slaves: Digital I/O Units**

Unit status and maintenance information can be monitored in the Smart Slave Monitoring Window.

#### **Smart Slaves: Analog I/O Units**

Unit status and maintenance information can be monitored in the Smart Slave Monitoring Window.

#### **E5ZN Temperature Controller DeviceNet Communications Unit**

Unit status and the status of the connected Temperature Controller can be monitored.

## 6-15 Using General-purpose Tools to Set Devices

This section explains how to set the device parameters with no corresponding EDS files or set the node addresses or baud rates through the network.

### 6-15-1 Setting Device Parameters with Class Instances

#### Tools - DeviceNet Tool - Setup Parameters

Device parameters for devices that have no corresponding EDS files can be set by specifying the following items.

- Service code
- Class (object class), instance (class instance) and attribute (instance attribute)

Before setting the device parameters, it is also necessary to obtain the data setting information on attributes other than the above from the manufacturer of the device. Unless all the information is known, the device parameters cannot be set.

Use the following procedure to set the device parameters.

1. Place the CX-Integrator online.
2. Select **Tools - DeviceNet Tool - Setup Parameters**.  
The following dialog box will be displayed.

The screenshot shows the 'Setup Parameters' dialog box. The 'Target Node Address' section has a numeric input field with '0' and a range indicator 'Setup Range 0 - 63'. The 'Service' section has 'Generic' selected and a dropdown menu showing 'Apply Attributes'. The 'Parameter' section has 'Class' set to '0', 'Instance' set to '1', and an empty 'Data' field. A text box next to the 'Parameter' section contains the text: 'All parameters set in HEX format string. Attribute data set in Data field.' At the bottom, there are 'Send' and 'Close' buttons.

3. Set the *Target Node Address* to the node address of the device.

## 6-15 Using General-purpose Tools to Set Devices

### 6-15-1 Setting Device Parameters with Class Instances

4. Designate the service.

There are two ways to designate the service code, using the generic service code defined by DeviceNet or designating it directly. To use the generic service code defined by DeviceNet, check the **Generic** option, then 4. Select the desired service from the drop-down list. To designate the service code directly, check the **Custom** option, then input the service code in a HEX format string.

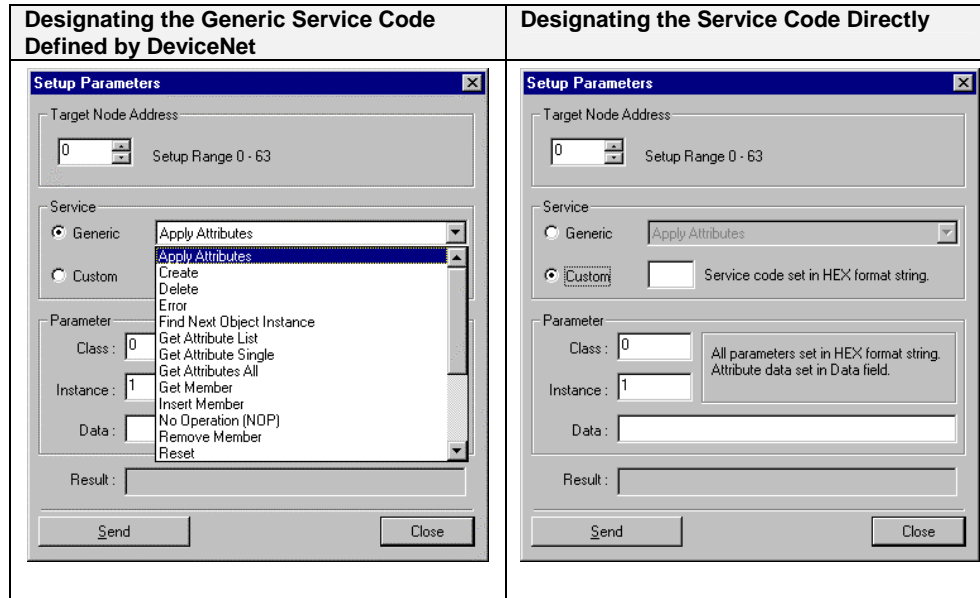

5. Designate the class and instance parameters for reading and writing data.

6. Input the data corresponding to the designated service.

7. After all of the items have been input, click the **Send** Button. The device response will be displayed in the *Result* area.

8. Click the **Close** Button to quit device parameter setting. This completes the device parameter setting.

1. Parameter Reading Example

- 1) Check the **Generic** option in *Service*, then select *Get Attribute Single* from the drop-down list.
- 2) Designate the class and instance of the parameter to be read.
- 3) Input *Data Area* for the *Attribute* of the parameter to be read.
- 4) Click the **Send** Button. The value that was read will be displayed in the *Result* area.

2. Parameter Setting Example

- 1) Check the **Generic** option in *Service*, then select *Set Attribute Single* from the drop-down list.
- 2) Designate the class and instance of the parameter to be set.
- 3) Input *Data Area* for the *Attribute* of the parameter to be set.
- 4) Input the attribute followed by the value to be set for the parameter in the *Data* area.
- 5) Click the **Send** Button.



## 6-16 Optional Functions

The optional functions make it possible to set Expansion Modules in the CX-Integrator for new devices, add DeviceNet device vendors, and add new device types.

### 6-16-1 Installing Expansion Modules

#### Tools - DeviceNet tool - Install Plugin Module

To install the expansion module, use the following procedure.

1. Select **Tools - DeviceNet tool - Install Plugin Module**.  
A window to specify the name of expansion module set file will be displayed.
2. Input the file name and click the **Open** Button.  
The Expansion Module will be added to the CX-Integrator.

### 6-16-2 Adding Vendors and Device Types

#### Option - Edit Configuration File

Use the following procedure to add a new device vendor or device type.

1. Select **Option** and **Edit Configuration File**.
2. Select **Vendor ID/Device Type List**.  
The following dialog box will be displayed.

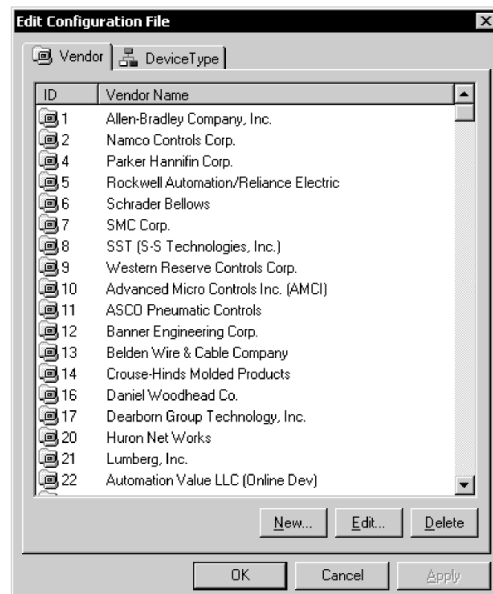

3. To add or modify the vendor information, click on the **Vendor** Tab.  
To add new vendor information, use the following procedure.
  - 1) Click the **New** Button.  
The following dialog box will be displayed.

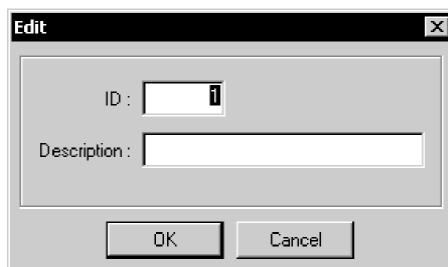

- 2) Input the new vendor ID and vendor name and click the **OK** Button.  
The new vendor will be added to the list.

## 6-16 Optional Functions

### 6-16-2 Adding Vendors and Device Types

To edit existing vendor information, use the following procedure.

- 1) Select the vendor.
- 2) Click the **Edit** Button.

The following dialog box will be displayed.

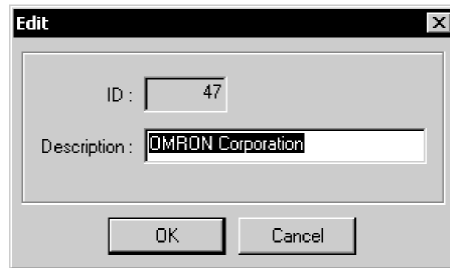

The screenshot shows a standard Windows-style dialog box titled "Edit". It has a close button (X) in the top right corner. The dialog contains two text input fields. The first is labeled "ID:" and contains the number "47". The second is labeled "Description:" and contains the text "OMRON Corporation". At the bottom of the dialog, there are two buttons: "OK" and "Cancel".

- 3) Input the new vendor name and click the **OK** Button.
4. To add or change the device type, click on the **Device Type** Tab.  
The method of adding or changing the device type is the same as that of adding or changing vendor information.
5. When all the settings are completed, click the **OK** Button.

# **Communications**

## **Section 7 CompoNet**

This section describes the basic usage of CompoNet networks and how to set CompoNet parameters.

## 7-1 Overview

### 7-1-1 What Is CompoNet?

## 7-1 Overview

### 7-1-1 What Is CompoNet?

CompoNet feature easy operation and installation in a component-level network connecting PLCs and onsite I/O. The PLC and CompoNet Slave Units cyclically exchange I/O information through a CompoNet Master Unit, refreshing I/O in sync with the PLC execution cycle. Message communications can also be used from host computers or the CPU Unit of the PLC to read and write CompoNet Slave Unit data.

The following CompoNet monitor and settings are set using the CX-Integrator.

- Transferring and comparing network configurations
- Monitoring remote I/O communications status and monitoring slave status
- Transferring and comparing component parameters
- Editing component parameters

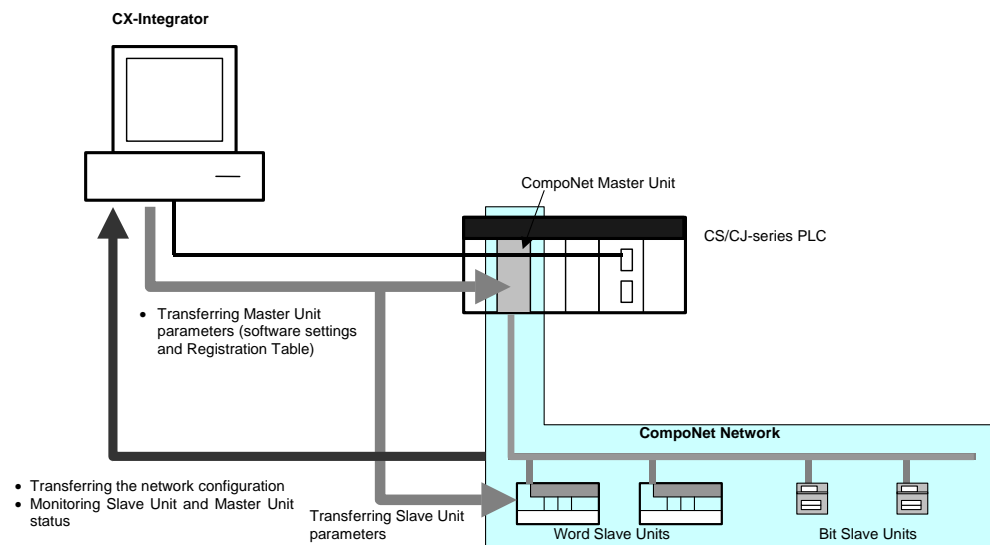

## 7-2 Basic Procedures

### 7-2-1 Basic Procedures

This section describes how to use the CX-Integrator to set up and monitor network components. The network is connected, the power supplies wired, the CompoNet settings configured, and the serial port of the PLC to which the CompoNet Master Unit is mounted is connected to a personal computer. The Unit can then be monitored. The Unit parameter settings may be adjusted as required.

The basic procedures for the CX-Integrator are given below.

Step	Section
<p><b>1. <u>Connect online to the PLC.</u></b></p> <ol style="list-style-type: none"> <li>1) Connect the PLC to which the CompoNet Master Unit is mounted to the computer using a serial or network connection.</li> <li>2) For automatic online connection, select <b>Network - Auto Online</b> from the menu (only supported when using a serial connection). To connect manually, select <b>Network - Communication Settings</b> and set the communications settings, and then select <b>Network - Work Online</b>.</li> </ol>	<p>Refer to 1-4-1 <i>Direct Serial Connections to a PLC</i>.</p> <p>Refer to 2-2-2 <i>Procedures</i>.</p>
↓	
<p><b>2. <u>Connect to the Master Unit.</u></b></p> <p>In the Online Connection Information Window, right-click the CompoNet Master Unit for the network to connect to, and select <b>Connect</b>.</p>	<p>Refer to 7-3-1 <i>Upload the Network Configuration to the Computer</i>.</p>
↓	
<p><b>3. <u>Upload the Network Configuration and Compare It to the Virtual Network Configuration on the Computer</u></b></p> <ol style="list-style-type: none"> <li>1) In the Online Connection Information Window, right-click the CompoNet Master Unit for the network to connect to, and select <b>Transfer [Network to PC]</b>.</li> <li>2) Select the <i>Network structure only</i> option from the <i>Transfer [Network to PC]</i> Dialog Box, and click the <b>Transfer</b> Button.</li> </ol>	<p>Refer to 7-3-1 <i>Upload the Network Configuration to the Computer</i>.</p>
↓	
<p><b>4. <u>Set the optional component parameter settings as necessary.</u></b></p>	<p>Refer to 7-2-2 <i>Optional Settings</i>.</p>
↓	
<p><b>5. <u>Monitor the CompoNet Network.</u></b></p> <ul style="list-style-type: none"> <li>● Monitor slave participation/removal status.</li> <li>● Monitor the Master Unit status and error history.</li> <li>● Check network status.</li> <li>● Monitor slave status.</li> </ul>	<p>Refer to 7-4-2 (<i>Slave Status Tab Page</i>).</p> <p>Refer to 7-4-2 (<i>Unit Status Tab Page and Error History Tab Page</i>).</p> <p>Refer to 7-4-2 (<i>Network Status Tab Page</i>).</p> <p>The information that can be monitored depends on the Unit. Refer to the manual for each Unit for details.</p>

## 7-2 Basic Procedures

### 7-2-2 Optional Settings

#### 7-2-2 Optional Settings

Use the following steps to set the parameters according to the application or network environment.

Step	Section
<b><u>Set and transfer Master Unit parameters.</u></b>	
● Master Unit parameter settings	Refer to 7-6-1 <i>Master Unit Parameter Settings</i> .
● Editing the Registration Table	Refer to 7-6-2 <i>Editing the Registration Table</i> .
● Editing the Software Table	Refer to 7-6-3 <i>Editing the Software Table</i> .
<b><u>Set and transfer Slave parameters.</u></b>	
● Slave Parameter Setting	Refer to 7-7-1 <i>Setting Slave Parameters</i> .

## 7-3 Uploading, Downloading, and Comparing Network Configurations

The configuration of the actual network can be written to a virtual network on the CX-Integrator running on the computer. Network configurations will also be compared. This section describes how to perform each task.

### 7-3-1 Upload the Network Configuration to the Computer

Use the following procedure to read the network configuration information from the network.

1. While online, right-click the Master Unit under the connected PLC in the Online Connection Information Window, and then select **Connect**.
2. Right-click the Master Unit, and then select **Transfer [Network to PC]**. The Transfer [Network to PC] Dialog Box will be displayed.

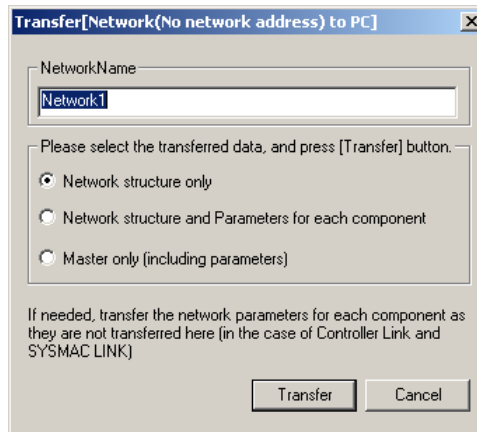

Data	Description
Network structure only	Uploads the network structure to the computer.
Network structure and parameters for each component	Uploads the network configuration and parameters for each component to the computer.
Master only (including parameters)	Uploads the Master Unit and Master Unit parameters on the network configuration to the computer.

**Note** Approximately 15 seconds is required per node to transfer parameters. If the network structure and parameters for each component are selected, up to 100 minutes may be required to complete the transfer.

3. Select the data to be uploaded and click the **Transfer** Button. The network configuration that was sent to the computer will be displayed in the Network Configuration Window.

## 7-3 Uploading, Downloading, and Comparing Network Configurations

### 7-3-2 Comparing Network Configurations

#### 7-3-2 Comparing Network Configurations

Use the following procedure to compare the network configuration of an actual network with the network configuration of a virtual network created with the CX-Integrator.

1. Select the networks to be compared from the Network Configuration Window.
2. Right-click and select **Network – Compare** from the menu.

The progress dialog box will be displayed and the comparison will begin. The comparison results will be displayed in the following dialog box.

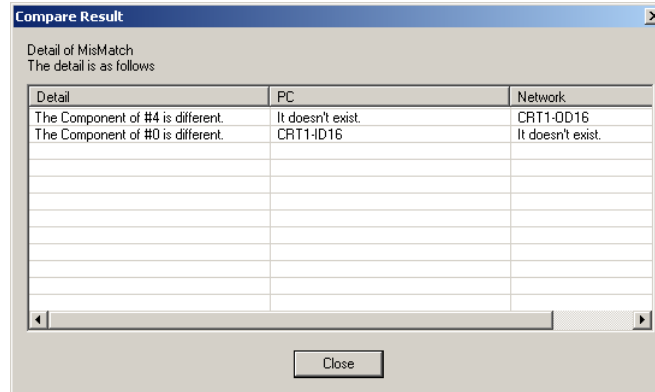

The screenshot shows a dialog box titled "Compare Result" with a close button in the top right corner. Below the title bar, it says "Detail of MisMatch" and "The detail is as follows". A table with three columns: "Detail", "PC", and "Network" is displayed. The table contains two rows of mismatch information. The first row shows "The Component of #4 is different." in the Detail column, "It doesn't exist." in the PC column, and "CRT1-DD16" in the Network column. The second row shows "The Component of #0 is different." in the Detail column, "CRT1-ID16" in the PC column, and "It doesn't exist." in the Network column. There are several empty rows below these. At the bottom of the dialog box is a "Close" button.

Detail	PC	Network
The Component of #4 is different.	It doesn't exist.	CRT1-DD16
The Component of #0 is different.	CRT1-ID16	It doesn't exist.

**Note** This function performs a network configuration comparison; it does not compare individual component parameters.



## 7-4 Component Monitor

The Component Monitor function monitors the CompoNet Network components and communications status. If an error occurs, it quickly identifies the cause and provides the network status.

### 7-4-1 Starting Monitoring

Use the following procedure to monitor components (Master Unit and Slave Units).

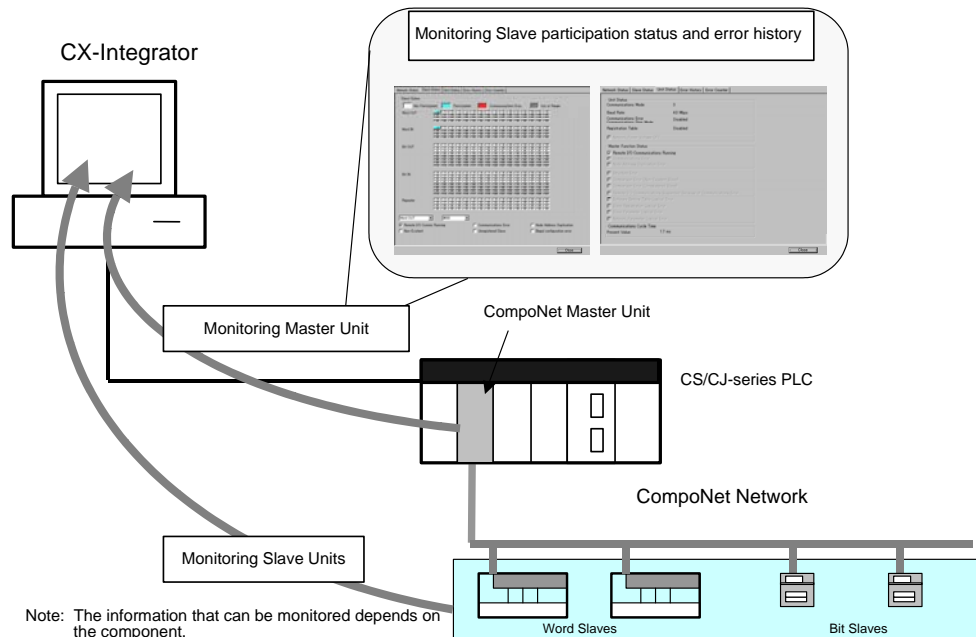

1. With the CX-Integrator online, transfer the network configuration to the computer. Alternatively, the network configuration can be read from a CX-Integrator project file before going online.
2. Right-click the component to monitor in the Network Configuration Window and select **Monitor**.  
Alternatively, select the component to monitor and select **Monitor** from the Component Menu.  
The Component Monitor Window will be displayed.  
Information about the Network Status, Slave Status, Unit Status, Error History, and Error Counter will be displayed in the Monitor Window on the Master Unit.
3. To quit the monitor function, click the **Close** Button.

**Note** The contents of the Monitor Window depends on the component. For information on the contents that can be monitored, refer to the Unit manual.

## 7-4 Component Monitor

### 7-4-2 Master Unit Monitor Window

#### 7-4-2 Master Unit Monitor Window

Various types of monitoring functions are supported to enable quickly isolating errors that occur in connected devices and on the network, and to enable rapid recovery from errors and predictive maintenance.

This section describes the information that can be monitored for OMRON Master Units.

#### Network Status Tab Page

The Network Status Tab Page displays the network configuration information contained in the Master Unit.

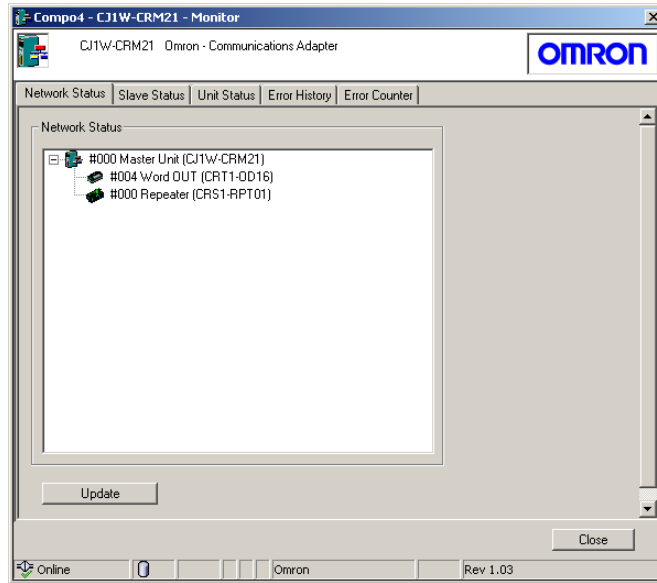

The connected Slave Units, and Repeater Units are shown in the Master Unit tree. Information on each Unit (icon, node address, slave type, and model name) is displayed, and Units with errors are displayed in red. Errors can be checked on the Slave Status Tab Page.

**Slave Status Tab Page**

The Slave Status Tab Page shows the status of Slave Units and Repeater Units connected to the network.

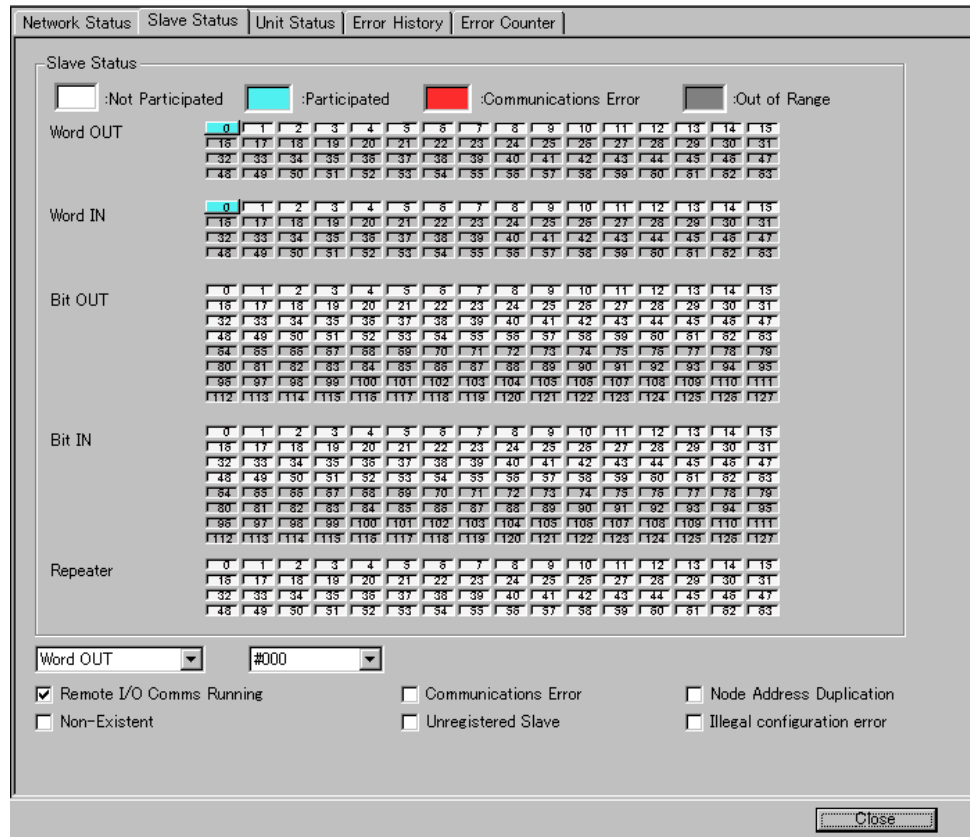

**Network Participation Status of Slave Units and Repeater Units**

Indicator color	Status	Master Unit status and response
Light blue	Operating normally (participating)	Participation Flag is ON and Communications Error Flag is OFF.
Red	Error (left communications)	Participation Flag is ON and Communications Error Flag is ON.
White	Has never joined	Participation Flag is OFF.

## 7-4 Component Monitor

### 7-4-2 Master Unit Monitor Window

#### Individual Slave Status Check

Select the Slave Unit or Repeater Unit from the pull-down menu to check the status. The check box for each applicable status will be selected.

Word OUT	#000
<input checked="" type="checkbox"/> Remote I/O Comms Running	<input type="checkbox"/> Communications Error
<input type="checkbox"/> Non-Existent	<input type="checkbox"/> Unregistered Slave
	<input type="checkbox"/> Node Address Duplication
	<input type="checkbox"/> Illegal configuration error

Status	Description
Remote I/O Comms Running	Communications are operating normally.
Communications Error	A communications error has occurred.
Node Address Duplication	<ul style="list-style-type: none"> <li>The same address has been set for two or more nodes.</li> <li>The same words have been allocated to two or more nodes.</li> <li>A Slave Unit with a different number of bits is participating at a node address of a Slave Unit that left the network.</li> </ul>
Non-Existent	A Unit registered in the registration table is not present on the network.
Unregistered Slave	A Unit not registered in the registration table is participating in the network.
Illegal configuration error	The number of Repeater Unit layers has exceeded 2.

#### Unit Status Tab Page

The Unit Status Tab Page displays the status of Master Unit functions.

Network Status	Slave Status	Unit Status	Error History	Error Counter
<p>Unit Status</p> <p>Communications Mode: 3</p> <p>Baud Rate: 4.0 Mbps</p> <p>Communications Error: Disabled</p> <p>Communications Stop Mode: Disabled</p> <p>Registration Table: Disabled</p> <p><input type="checkbox"/> Network Power Voltage OFF</p>				
<p>Master Function Status</p> <p><input checked="" type="checkbox"/> Remote I/O Communications Running</p> <p><input type="checkbox"/> Communications Error</p> <p><input type="checkbox"/> Node Address Duplication Error</p> <p><input type="checkbox"/> Structure Error</p> <p><input type="checkbox"/> Comparison Error (Non-Existent Slave)</p> <p><input type="checkbox"/> Comparison Error (Unregistered Slave)</p> <p><input type="checkbox"/> Remote I/O Communications Suspended Because of Communications Error</p> <p><input type="checkbox"/> Software Setting Table Logical Error</p> <p><input type="checkbox"/> Slave Registration Logical Error</p> <p><input type="checkbox"/> Slave Parameter Logical Error</p> <p><input type="checkbox"/> Network Parameter Logical Error</p>				
<p>Communications Cycle Time</p> <p>Present Value: 1.7 ms</p>				
<p>Close</p>				

**7-4 Component Monitor**  
**7-4-2 Master Unit Monitor Window**

The check box for each applicable status will be selected.

Name		Description	Value
Unit Status	Communication Mode	Displays the number of the communications mode set on the rotary switch on the front of the Master Unit.	0,1,2,3,8
	Baud Rate	Displays the baud rate set on DIP switch pins SW1 and SW2 on the front of the Master Unit when the Unit power was turned ON.	4 Mbps, 3 Mbps, 1.5 Mbps, 93.75 kbps
	Communications Error Communications Stop Mode	Displays the setting of DIP switch pin SW3 (ESTP) when the power was turned ON. When this pin is ON, a communications error on any slave will cause all remote I/O communications to stop.	Enabled, disabled
	Registration Table	Displays the setting of DIP switch pin SW4 (REGS) on the front of the Master Unit when the power was turned ON. When this pin is ON, only Slave Units that are registered will be able to participate in the network. At the same time, if the node address of the active Slave Unit does not match the node address of a Slave Unit registered in the Registration Table, a comparison error will occur.	Enabled, disabled
	Network Power Voltage OFF	Displays the status of the network power supply.	-
Master Function Status	Remote I/O Communication Running	Remote I/O communications are running.	
	Communications Error	The slave has left the network.	
	Node Address Duplication Error	The address of a Slave Unit attempting to participate in the network is the same as the address of another Slave Unit.	
	Structure Error	The Slave Units and Repeater Units requesting participation on the network have exceeded the maximum allowable number of Repeater layers (2 layers).	
	Comparison Error (Non-Existent Slave)	A Slave Unit was detected that is registered in the Registration Table but did not join the network within the fixed time period from the time that the Unit power was turned ON. The monitoring time is set using the CX-Integrator Software.	
	Comparison Error (Unregistered Slave)	An unregistered slave was detected joining the network.	
	Remote I/O Communications Suspended Because of Communications Error	A communications error was detected while communications were set to be stopped when a communications error occurred.	
	Software Setting Table Logical Error	<ul style="list-style-type: none"> <li>• The mode is set the Software Setting Mode (Mode 8) even though the Software Table is disabled.</li> <li>• The Software Table is corrupted.</li> </ul>	
	Slave Registration Logical Error	<ul style="list-style-type: none"> <li>• The Registration Table is disabled, but the Registration Table Enable Setting (REGS) is turned ON (enabled).</li> <li>• The Registration Table is corrupted.</li> </ul>	
	Slave Parameter Logical Error	The Slave Unit Parameter Table is corrupted.	
	Network Parameter Logical Error	The Network Parameters Table is corrupted.	
Communication Cycle Time	Present Value	Displays the present value of the communications cycle time in milliseconds.	

**7-4 Component Monitor**  
**7-4-2 Master Unit Monitor Window**

**Error History Tab Page**

The Error History Tab Page displays the error history recorded in the Master Unit.

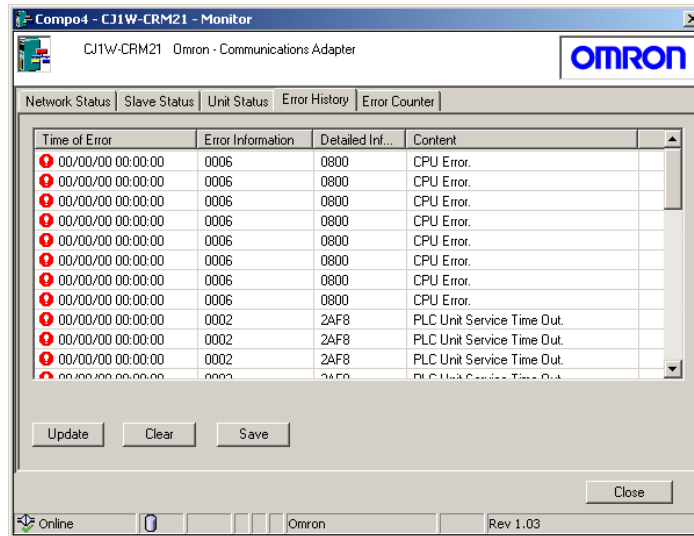

To refresh the display, click the **Update** Button.

To clear the display contents, click the **Clear** Button.

To save the file, click the **Save** Button. The file can be saved in CSV format.

Refer to the Master Unit manual for details on errors.

**Error Counter Tab Page**

The Error Counter Tab Page displays the error counter values recorded in the Master Unit.

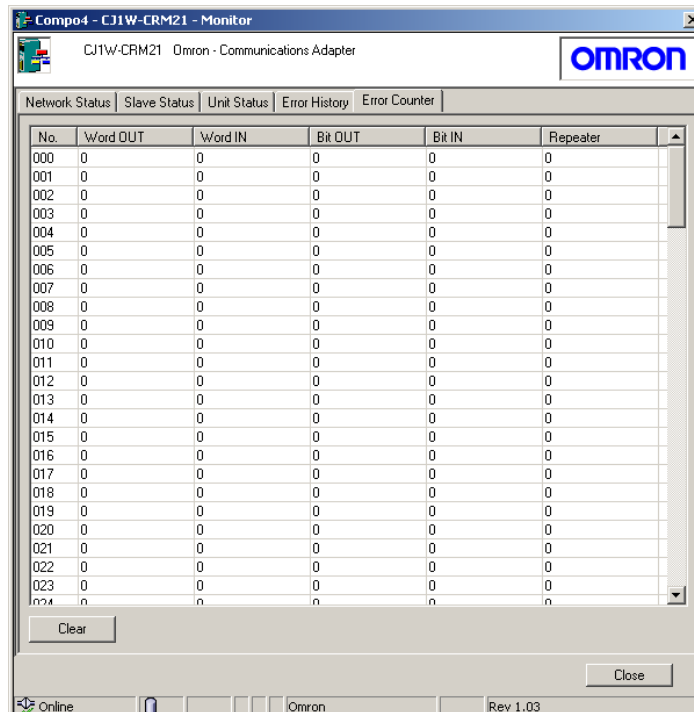

Background color	Details
Red	The Unit has left the network.
Yellow	The Unit is participating in the network, and the error count is one or greater.
White	The Unit is participating in the network, and the error count is 0.

## 7-5 Uploading, Downloading, and Comparing Component Parameters

Components are set up by editing parameters uploaded from the components to the computer and then downloading the edited parameters to the components. This section describes the procedure for uploading, downloading, and comparing component parameters.

- Uploading component parameters to a computer
- Comparing component parameters
- Downloading component parameters to the components

### 7-5-1 Uploading Component Parameters to a Computer

Two methods can be used to upload component parameters from components on the network to the computer.

- Uploading using the Edit Parameter Dialog Box
- Uploading using the Network Configuration Window

#### Uploading Using the Parameter Edit Dialog Box

Use the following procedure to upload parameters using the Parameter Edit Dialog Box.

1. Select the components from which you want to upload parameters from the Network Configuration Window.
2. Right-click and select **Parameter – Edit** from the menu.
3. Click the **Transfer [Unit to PC]** Button located on the General Tab Page for the Master Unit or Slave Unit.

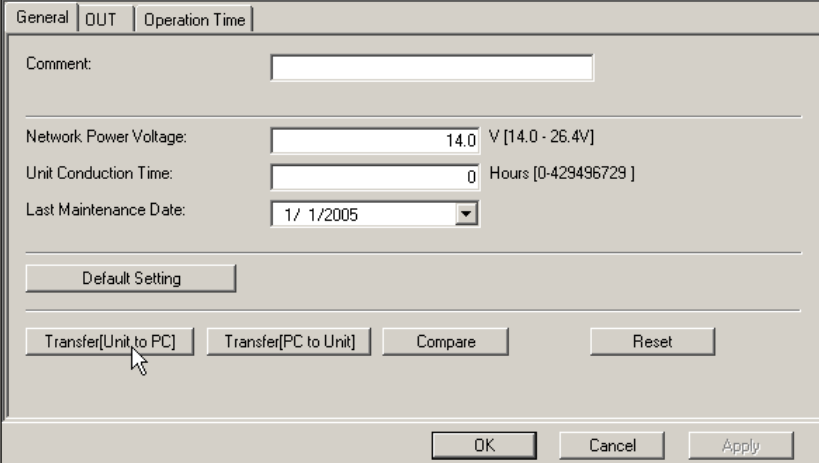

The screenshot shows the 'Parameter Edit Dialog Box' with the 'General' tab selected. The dialog box has a title bar with 'General', 'OUT', and 'Operation Time' tabs. The 'General' tab is active. The dialog contains the following fields and buttons:

- Comment:** A text input field.
- Network Power Voltage:** A numeric input field with the value '14.0' and a unit dropdown set to 'V [14.0 - 26.4V]'. The unit dropdown is currently open.
- Unit Conduction Time:** A numeric input field with the value '0' and a unit dropdown set to 'Hours [0-429496729]'. The unit dropdown is currently open.
- Last Maintenance Date:** A date dropdown menu showing '1/ 1/2005'.
- Buttons:** 'Default Setting', 'Transfer[Unit to PC]', 'Transfer[PC to Unit]', 'Compare', and 'Reset'.
- Bottom Buttons:** 'OK', 'Cancel', and 'Apply'.

If the Master Unit is selected, a confirmation dialog box will be displayed.

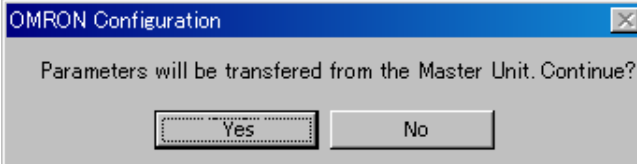

The screenshot shows a confirmation dialog box titled 'OMRON Configuration'. The dialog box contains the following text and buttons:

- Title:** OMRON Configuration
- Text:** Parameters will be transferred from the Master Unit. Continue?
- Buttons:** 'Yes' and 'No'.

## 7-5 Uploading, Downloading, and Comparing Component Parameters

### 7-5-2 Comparing Component Parameters

4. Click the **Yes** Button.

The parameter upload progress dialog box will be displayed, and the parameter upload to the computer will begin.

### Uploading Using the Network Configuration Window

Select the *Network structure and Parameters for each component* Option as the data to be uploaded in 7-3-1 *Uploading the Network Structure to the Computer*. The component parameters will be uploaded to the computer.

### 7-5-2 Comparing Component Parameters

The Parameter Edit Dialog Box is used to compare parameters of components on the network with component parameters that are stored in the CX-Integrator. Use the following procedure to compare parameters.

1. Connect the CX-Integrator online, and then connect it to a CompoNet Network.
2. Select the components to compare from the Network Configuration Window.
3. Right-click and select **Parameter - Edit** from the menu.
4. Click the **Compare** Button located on the General Tab Page for the Master Unit or Slave Unit.

The screenshot shows a dialog box with the following elements:

- Tabbed interface with 'General', 'OUT', and 'Operation Time' tabs.
- 'Comment:' label followed by an empty text input field.
- 'Network Power Voltage:' label followed by a text input field containing '14.0' and a unit label 'V [14.0 - 26.4V]'. A mouse cursor is pointing at the input field.
- 'Unit Conduction Time:' label followed by a text input field containing '0' and a unit label 'Hours [0-429496729]'.
- 'Last Maintenance Date:' label followed by a date selection dropdown menu showing '1/ 1/2005'.
- A 'Default Setting' button.
- A row of four buttons: 'Transfer[Unit to PC]', 'Transfer[PC to Unit]', 'Compare', and 'Reset'. A mouse cursor is pointing at the 'Compare' button.
- A row of three buttons at the bottom: 'OK', 'Cancel', and 'Apply'.

The compare progress dialog box will be displayed, and then the comparison results will be displayed.



### 7-5-3 Downloading the Component Parameters to the Components

Two methods can be used download component parameters from a computer to a component on the network.

- Downloading using the Parameter Edit Dialog Box
- Downloading using the Network Configuration Transfer

#### Downloading Using the Parameter Edit Dialog Box

Use the following procedure to download parameters using the Parameter Edit Dialog Box.

1. Connect the CX-Integrator online.
2. Select the component from which you want to download parameters from the CompoNet Network.
3. Right-click and select **Parameter - Edit** from the menu.
4. Click the **Transfer [PC to Unit]** Button located on the General Tab Page for the Master Unit or Slave Unit.

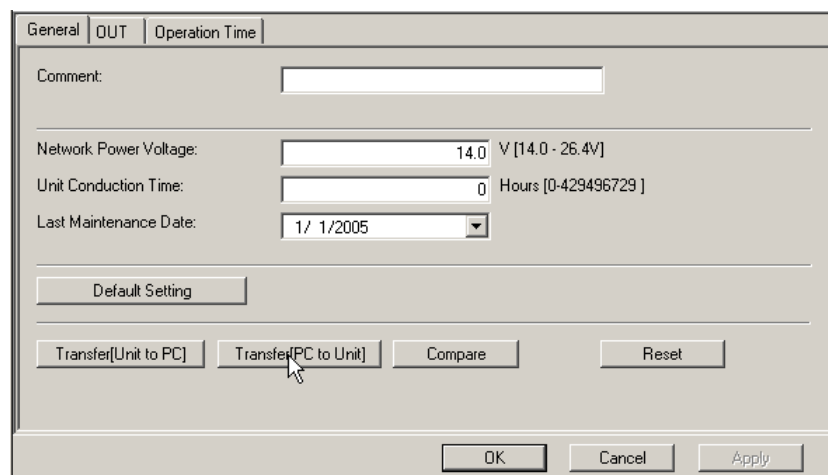

Note: The settings in the Unit will be returned to their default values if the **Default Setting** Button is clicked. Nothing will change in the dialog box, so do not click this button carelessly.

If the Master Unit is selected, a confirmation dialog box will be displayed. (See note.)

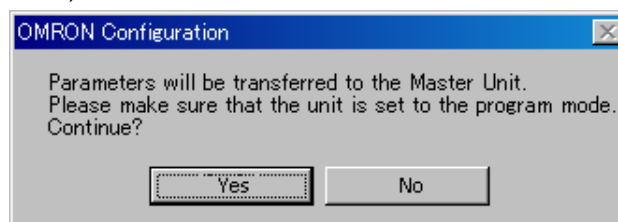

5. Click the **Yes** Button to start the parameter download.

Note: A confirmation dialog box will be displayed if the enable/disable settings for the Registration Table and Software Setting Mode are not the same on the computer and in the actual components. Refer to 7-6 *Editing Master Unit Parameters* and to the manual for the Master Unit for information on the Registration Table and Software Setting Mode.

## 7-5 Uploading, Downloading, and Comparing Component Parameters

### 7-5-3 Downloading the Component Parameters to the Components

#### Downloading the Network Configuration

When the network configuration download is executed, all components will be written to and reset, and the new settings will be enabled.

Use the following procedure to download the network configuration.

1. Connect the CX-Integrator online.
2. Right-click the network in the Work Space Window and select **Connect**.

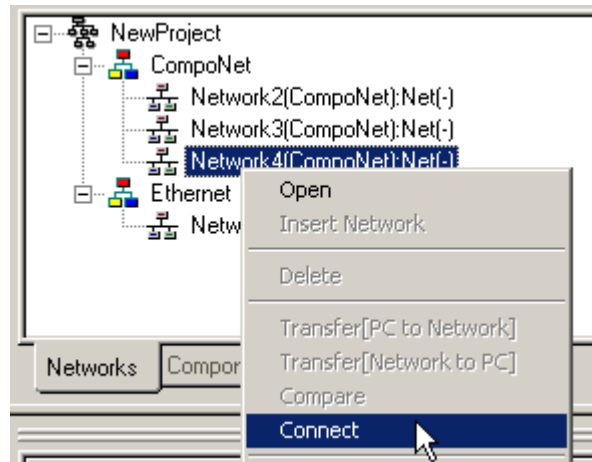

3. Select **Transfer [PC to Network (No network address)]** from the Network Menu.

The Transfer [PC to Network (No network address)] Dialog Box will be displayed.

4. Click the **OK** Button.

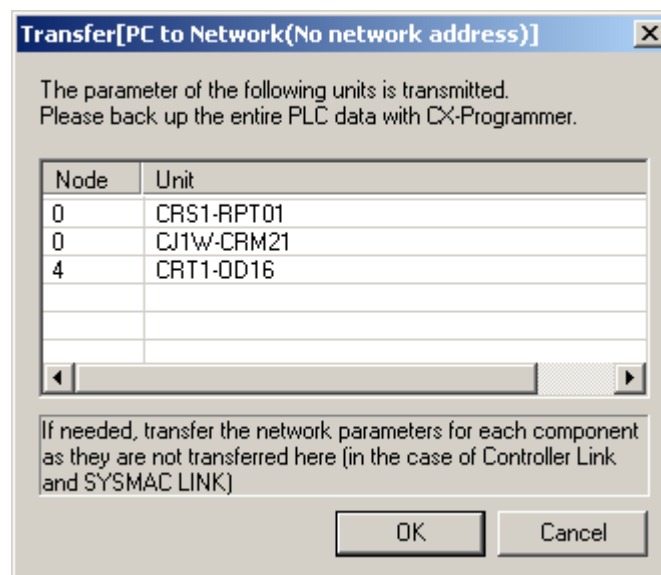

When the download has been completed, a dialog box will be displayed saying so.

5. Click the **OK** Button.

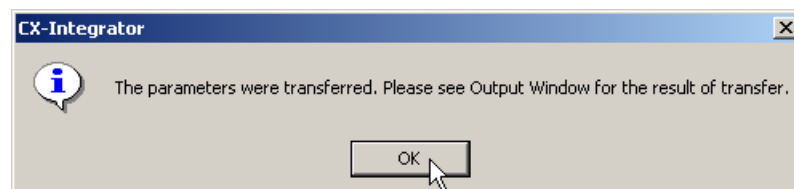

## **7-5-4 Resetting Component**

It may be necessary to reset a component in order to enable the new settings depending on the component. Use the following procedure to reset components.

1. Connect the CX-Integrator online.
2. Select the component on the CompoNet Network to be reset.
3. Right-click and select **Parameter – Edit** from the menu.
4. Click the **Reset** Button (see note) in the Parameter Edit Dialog Box.

**Note:** The **Reset** Button does not appear for components that do not require a reset to enable new settings.

## 7-6 Editing Master Unit Parameters

### 7-6-1 Master Unit Parameter Settings

## 7-6 Editing Master Unit Parameters

Edit Master Unit parameter settings as needed. For details on Unit parameter settings, refer to the Unit manual.

This section describes the setting parameters for an OMRON CompoNet Master Unit.

### 7-6-1 Master Unit Parameter Settings

The settable Master Unit parameters are listed in the following table.

Tab page	Setting	Description
General	Function Choice	Sets communications settings.
	Registration Table	Displays the Registration Table Tab Page.
	Software Setting Table	Displays the Software Setting Table Tab Page.
	Transfer/Compare	Performs uploading, downloading, and comparison of parameters between the computer and components.
Registration Table (See note.)	Unregistered/ Registered Device List	Sets the Slave Units that will join the network.
	Advanced Setting	Sets the conditions for the Slave Units that will join the network.
Software Setting Table (See note.)	Data	User-defined areas can be allocated to the Slave Units and error flags.
	Participation Flag/Communications Error Flag	

**Note:** Displayed only when Registration Table and Software Setting Table are enabled on the General Tab Page.

### Parameter Setting Procedure

1. Connect online to the actual CompoNet Network, and upload the network configuration to the computer. Alternatively, the network configuration can be read from a CX-Integrator project file.
2. From the Network Configuration Window, double-click the Master Unit, or right click it and select **Parameter - Edit** from the menu. (Alternatively, select **Parameter - Edit** from the Component Menu.)

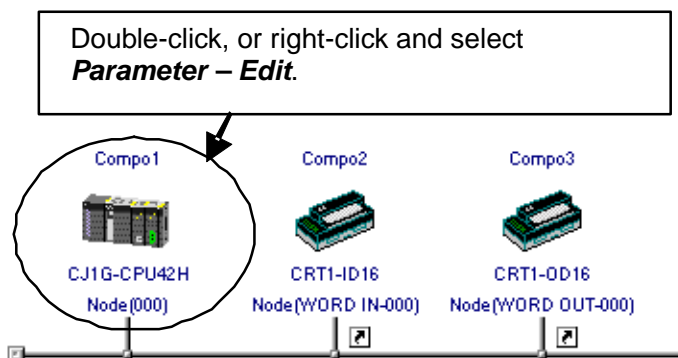

The Master Unit Parameter Settings Dialog Box will be displayed.

The contents of each tab page are shown next. For details on parameter settings, refer to the Master Unit manual.

**General Tab Page**

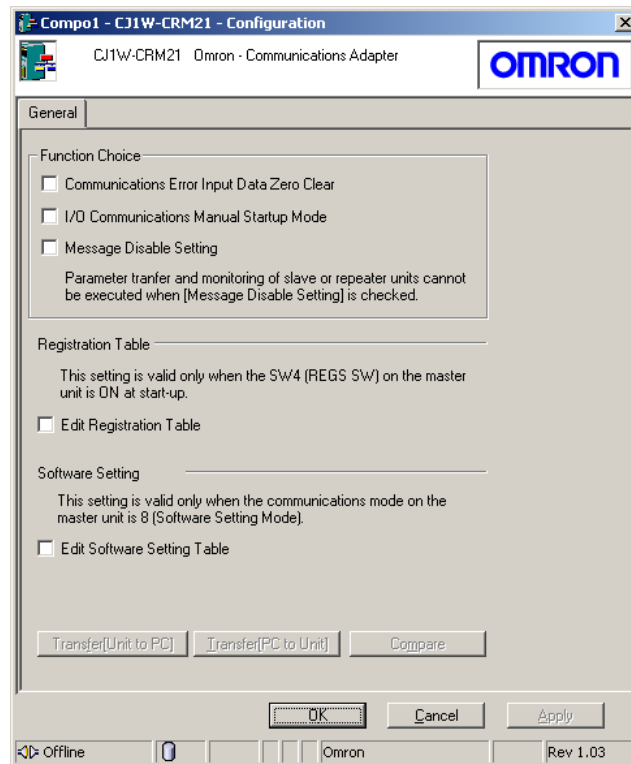

Name		Function
Function Choice	Communications Error Input Data Zero Clear	When this option is selected, all input data for the Slave Unit will be cleared to zeros if a communications error occurs in the Slave Unit. This will prevent operation that is triggered by IN data in Slave Units that have a communication error.
	I/O Communication Manual Startup Mode	When this option is selected, the following will apply. <ul style="list-style-type: none"> <li>• When the Master (PLC) is turned ON, remote I/O communications will not be started.</li> <li>• Remote I/O communications will start when the Remote I/O Communications Start Switch (setting parameter bit 00) is turned ON in memory.</li> </ul>
	Message Disable Setting	When this option is selected, the following functions will be disabled. <ul style="list-style-type: none"> <li>• Sending explicit messages to Slave Units.</li> <li>• Receiving explicit messages from the CPU Unit at the Master Unit.</li> </ul>
Registration Table	Edit Registration Table	When this option is selected, the Registration Table Tab Page will be displayed.
Software Setting	Edit Software Setting Table	When this option is selected, the Software Setting Table Tab Page will be displayed.
Transfer[Unit to PC]		Parameters from components on the network will be uploaded to the CX-Integrator.
Transfer[PC to Unit]		Parameters set with the CX-Integrator will be downloaded to the components on the network.
Compare		Compares the parameters set with the CX-Integrator with the settings of the component parameters on the network.

## 7-6 Editing Master Unit Parameters

### 7-6-1 Master Unit Parameter Settings

#### Registration Table Tab Page

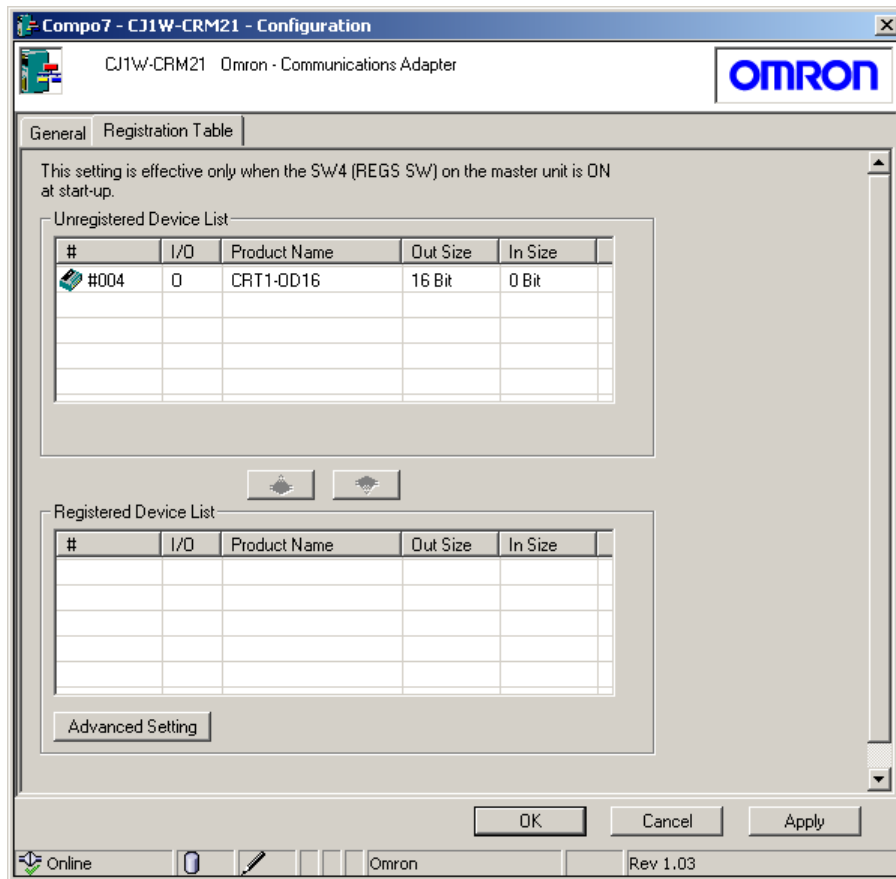

Name	Function
Unregistered Device List	<p>Displays the Slave Units that are not participating in the network and are not registered.</p> <ul style="list-style-type: none"> <li>• While connected to the network online, if the network configuration has been uploaded to the computer, all unregistered Slave Units connected to the network will be displayed. (If only the Master Unit data has been uploaded to the computer while connected to the network, no Slave Units will be displayed.)</li> <li>• When online, in cases other than those given above, all Slave Units in the current project will be displayed.</li> </ul>
Registered Device List	<p>Displays all registered Units participating in the network.</p> <ul style="list-style-type: none"> <li>• If <b>Transfer [Unit to PC]</b> is executed while connected to the network online, all Slave Units registered in the Master Unit Registration Table will be displayed.</li> <li>• When online, in cases other than those given above, no Slave Units will be displayed.</li> </ul>
Advanced Setting	<p>Displays the Advanced Setting Dialog Box. Used to set the status of Slave Units participating in the network.</p>

Advanced Setting Dialog Box

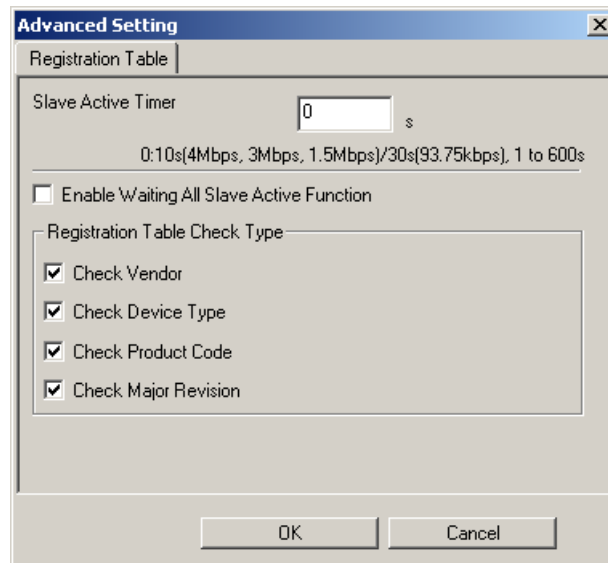

Name	Function
Slave Active Timer	Sets the time to detect that registered Slave Units are participating in the network, starting from the time that the power is turned ON or the Remote I/O Communications Start Switch is turned ON. This setting is set when changing the default setting. If the <i>Enable Waiting All Slave Active Function</i> Check Box is also selected, this setting will be disabled.
Enable Waiting All Slave Active Function	When this option is selected, all registered Slave Units will start remote I/O communications after joining the network.
Registration Table Check Type	Used to select the items to be checked from the Registration Table data.

**7-6 Editing Master Unit Parameters**  
**7-6-1 Master Unit Parameter Settings**

**Software Setting Table Tab Page**

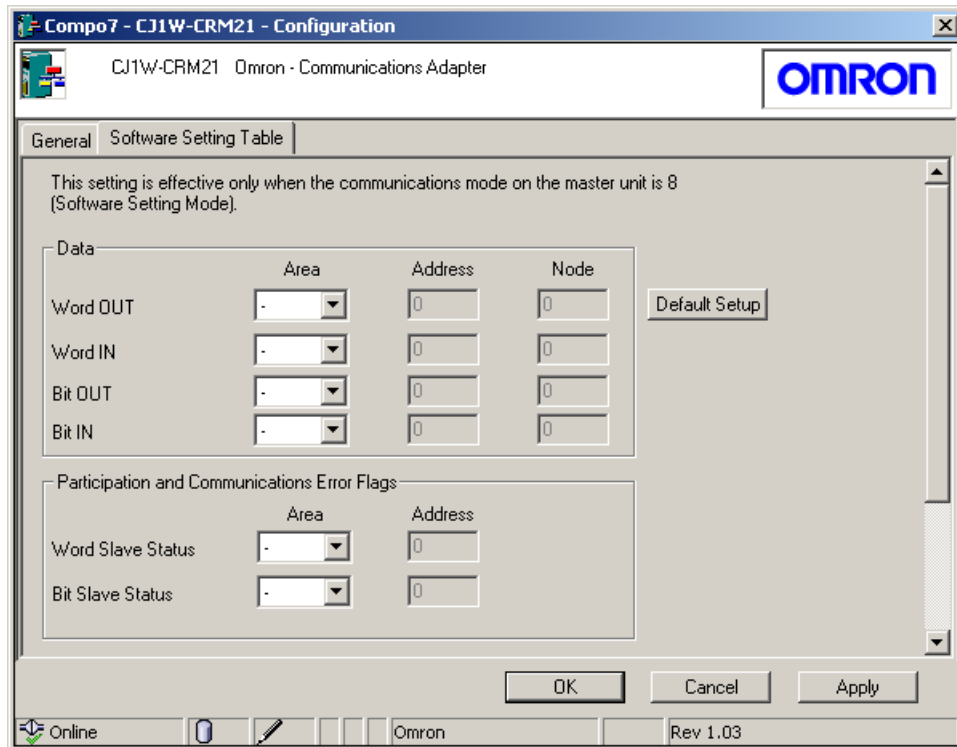

Name		Function
Data	Word OUT	Used to set the memory areas from which words will be allocated to the Slave Units. You can select from the CIO, WR, HR, and DM Areas. Also used to set the addresses of the first words to allocate and the numbers of nodes to which words will be allocated.
	Word IN	
	Bit OUT	
	Bit IN	
Participation and Communications Error Flags	Word Slave Status	Used to set the memory areas from which words will be allocated to the Error Flags. You can select from the CIO, WR, HR, and DM Areas. Also used to set the address of the first word to allocate.
	Bit Slave Status	
Default Setup		Returns the set values to their default settings.



## 7-6-2 Editing the Registration Table

The Registration Table sets the relationship between the node addresses and Slave Units. The Registration Table is used in the following cases.

- When comparing the Slave Units that are participating in the network and the Slave Units that have been set up.
- When an unregistered Slave Unit or a Slave Unit with a different node address or model must not be permitted to participate in the network.

Edit the Registration Table using CX-Integrator, and download it to the Master Unit.

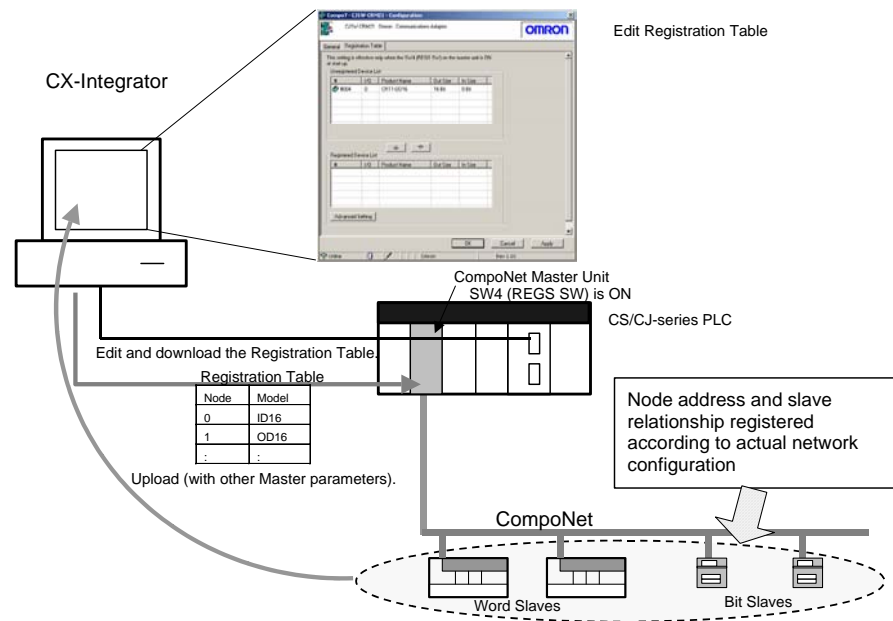

1. Turn ON the REGS (Registration Table Enable Setting) switch on the front of the Master Unit.
2. Turn ON the power to the CompoNet Unit and computer.
3. Start the CX-Integrator and connect online.
4. Right-click the **Master Unit** Icon in the Network Configuration Window and select **Parameter - Edit**. The Master Unit's Parameter Dialog Box will be displayed.

## 7-6 Editing Master Unit Parameters

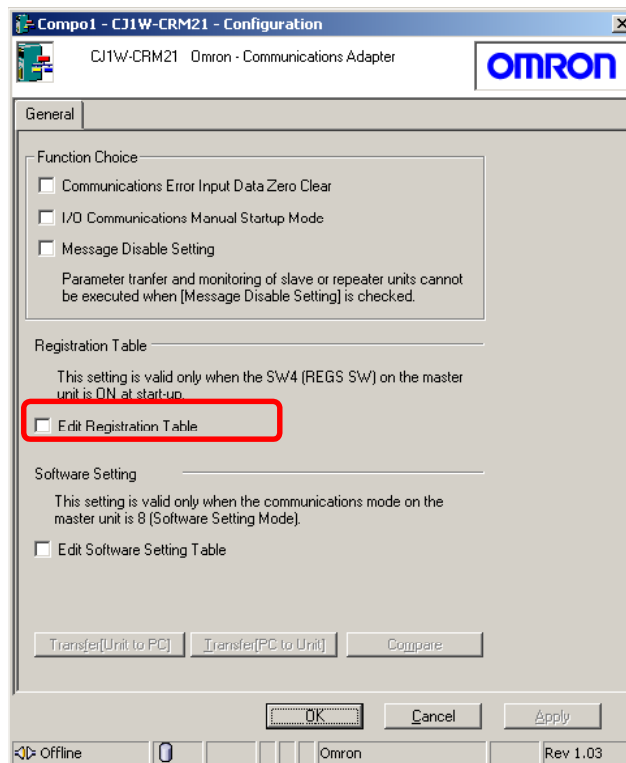

### 7-6-2 Editing the Registration Table

5. Select the *Edit the Registration Table* Check Box on the General Tab Page.

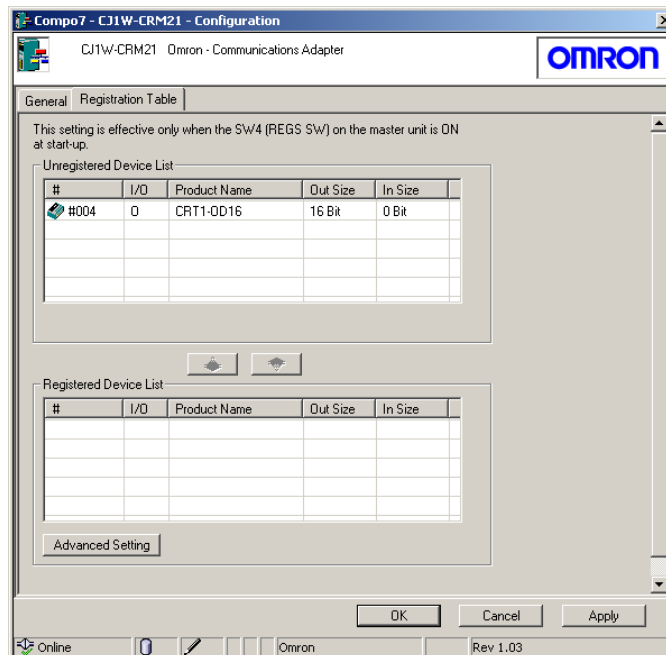

The Registration Table Tab Page will be displayed, and the Slave Units in the Network Configuration Window will be displayed in the Unregistered Device List.



6. Select the Slave Units to register from the Unregistered Device List and click the **Down Arrow** Button (  ). The Slave Units will be registered in order of node address, and then displayed in the Registered Device List.  
To unregister a Slave Unit, select the Slave Unit to be unregistered from the Registered Device List, and click the **Up Arrow** Button (  ). Slave Units that have been unregistered will be displayed in the Unregistered Device List.
7. Click the **Apply** Button. The Registration Table will be saved.
8. Click the **Transfer [PC to Unit]** Button on the General Tab Page for the Master Unit to download the settings to the components.

### Setting the Slave Active Timer and Enabling Waiting for All Slaves

The Slave Active Timer and Enable Waiting All Slave Active Function are set to control operation when a slave joins the network. The Slave Active Timer, Enable Waiting All Slave Active Function, and Registration Table Check Type are set as follows:

1. Turn ON the REGS switch on the front of the Master Unit.
2. Turn ON the CompoNet Unit and computer.
3. Start the CX-Integrator and connect online.
4. Right-click the **Master Unit** Icon in the Network Configuration Window and select **Parameter - Edit**. The Master Unit's Parameter Dialog Box will be displayed.
5. Select the *Edit the Registration Table* Check Box on the General Tab Page. The Registration Table Tab Page will be displayed.
6. Click the **Advanced Setting** Button. The Advanced Setting Dialog Box will be displayed.

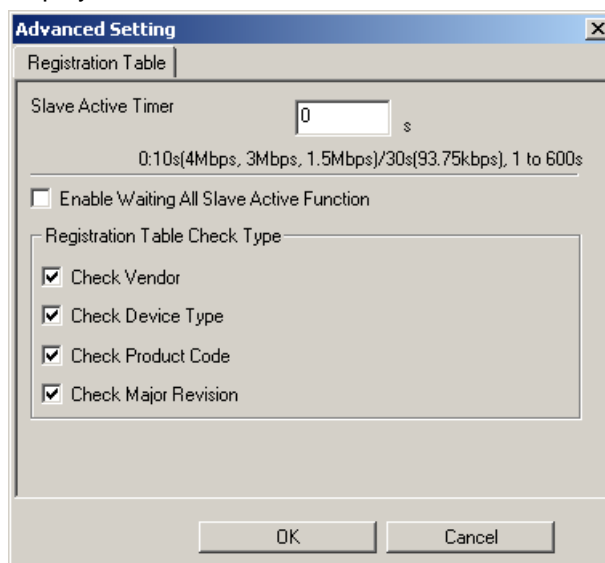

7. Adjust the settings.  
For information on settings, refer to the Registration Table Tab Page in 7-6-1 *Master Unit Parameter Settings*.
8. Click the **OK** Button. The Advanced Setting Dialog Box will close.
9. Click the **OK** Button. The settings will be saved.

### 7-6-3 Editing the Software Setting Table

The CompoNet Master Unit has 5 communications modes. When using communications modes 0 to 3, the CompoNet Unit IN/OUT information is allocated in the Special I/O Unit Area. When using communications mode 8 (Software Setting Mode), the CompoNet Unit IN/OUT information can be allocated in the CIO, DM, WR, and HR Areas, in addition to the Special I/O Unit Area.

The Software Setting Table is used in the following situations.

- When allocating words in an area other than the Special I/O Unit Area to Slave Units
- When setting the number of words allocated, e.g., when words after those allocated to the Slave Units will be used for another purpose.

In the Software Setting Mode, memory is allocated to each Word Unit and Bit Unit for the Word IN/OUT Areas, Bit IN/OUT Areas, Participation Flags, and Communications Error Flags.

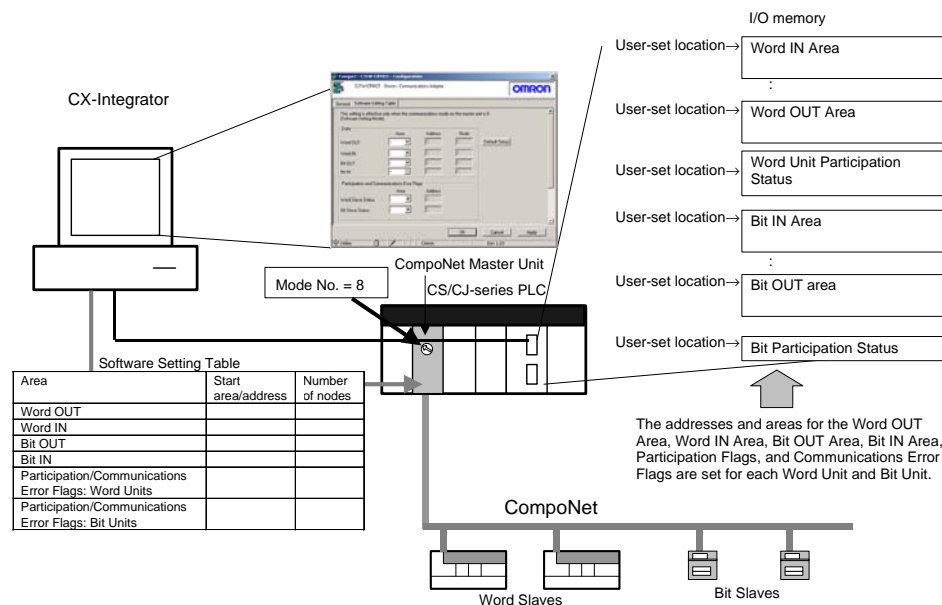

1. Set the communications mode to No. 8 (see note) by using the rotary switch on the front of the Master Unit.
- Note:** The Software Setting cannot be set in any communications mode other than No. 8.
2. Turn ON the CompoNet Unit and computer.
  3. Start the CX-Integrator, create the I/O tables, and then connect online to the CompoNet Network.
  4. Right-click the **Master Unit** Icon in the Network Configuration Window and select **Parameter - Edit**. The Master Unit's Parameter Dialog Box will be displayed.

## 7-6 Editing Master Unit Parameters

### 7-6-3 Editing the Software Setting Table

- Select the *Edit the Registration Table* Check Box on the General Tab Page. The Registration Table Tab Page will be displayed.

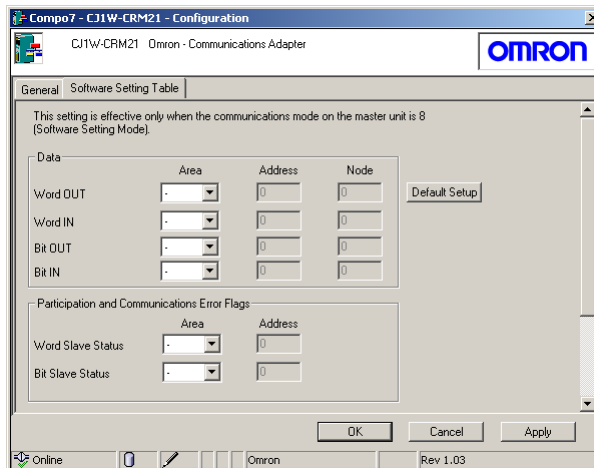

- Set the memory area, first address, and number of nodes for each area.



The start location is specified by setting the CPU Unit memory area and the address of the first word. The number of nodes to which to allocate words is specified to give the size of the area.

Area	CPU Unit memory area	Address (allocated start address for each area)	Number of nodes (number of node addresses to which to allocate memory)
Word OUT	CIO, DM, WR, or HR Area	User-set address. Set for each area.	64 max.
Word IN			64 max.
Bit OUT			128 max.
Bit IN			128 max.

The allocated start location for the status is as follows:

Participation and Communications Error Flags	CPU Unit memory area	Address (allocated start address for each area)	Allocated contents
Word Slave Status	CIO, DM, WR, or HR Area	User-set address. Set for each area.	Word slave status (1 word), Setting parameter (1 word), Participation Flags, and Communications Error Flags (16 words)
Bit Slave Status			Bit Slave Participation Flags and Communications Error Flags (32 words)

- Click the **Apply** Button. The settings will be saved.
- Click the **Transfer [PC to Unit]** Button on the General Tab Page for the Master Unit. The settings will be downloaded to the Master Unit.

## 7-7 Editing Slave Parameters

By editing Slave Unit parameters, the Slave Unit operating time (bit I/O interval) can be set, and Unit and bit comments can be input.

### 7-7-1 Setting Slave Parameters

Use the following procedure to edit Slave Unit parameters.

1. With the CX-Integrator online, transfer the network configuration to the computer. Alternatively, the network configurations can be read from the CX-Integrator project file.
2. From the Network Configuration Window, double-click the Master Unit, or right-click it and select **Parameter - Edit** from the menu. (Alternatively, select **Parameter - Edit** from the Component Menu.)

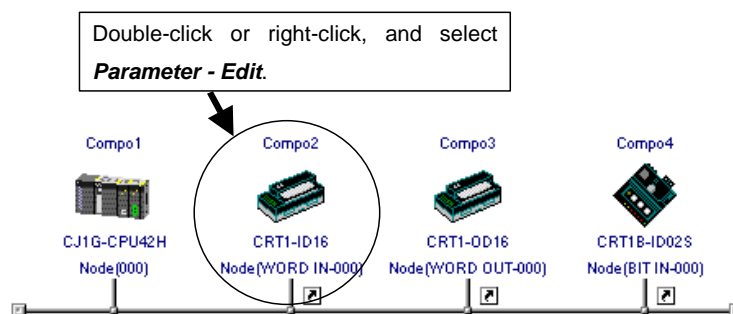

The Slave Parameter Dialog Box will be displayed.  
Example: CRT1-ID16

Example: CRT1-OD16 Omron - General Purpose Discrete I/O

General | OUT | Operation Time

Comment:

Network Power Voltage:  V [14.0 - 26.4V]

Unit Conduction Time:  Hours [0-429496729 ]

Last Maintenance Date:

Default Setting

Transfer[Unit to PC] Transfer[PC to Unit] Compare Reset

OK Cancel Apply

Online  Omron Rev 1.01

The slave parameters depend on the Unit. For parameter descriptions and setting instructions, refer to the Slave Unit manual.

## 7-7-2 Checking the Slave I/O Size

Use the following procedure to check the slave I/O size.

1. Right-click the **Slave** Icon in the Network Configuration Window and select **Additional Functions - Property**.
2. The Property Dialog Box will be displayed.

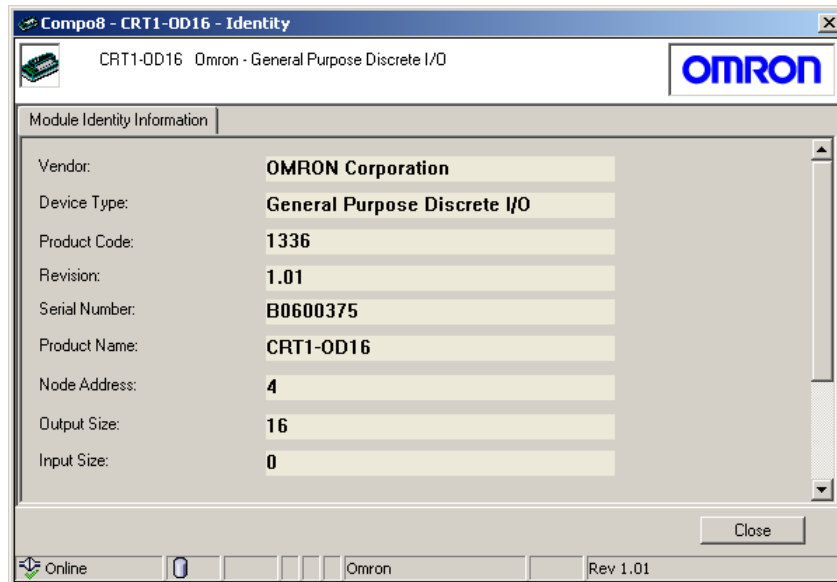

The input size and output size can be checked in this dialog box.

## 7-8 Other CompoNet Functions

### 7-8-1 Additional Functions

The CompoNet Master Unit and Slave Unit have unique display and setting functions. These additional functions are selected from the pop-up menu that is accessed by right-clicking a component icon displayed in the Network Configuration Window.

Example: The additional functions that are displayed when right-clicking on an OMRON Master Unit are shown in the following table.

Function Name	Description
Property	Displays the component information.
Reset	Reset the components.
Channel Allocation	Displays the I/O allocation status.

The additional functions depend on the Unit. Functions that cannot be selected are grayed out in the menu, and cannot be selected. For details, refer to the Unit manual.

Use the following procedure to display component information.

1. Select the component for which you want to display information.
2. Right-click the component icon and select **Additional Functions – Property** from the menu. The component information will be displayed.

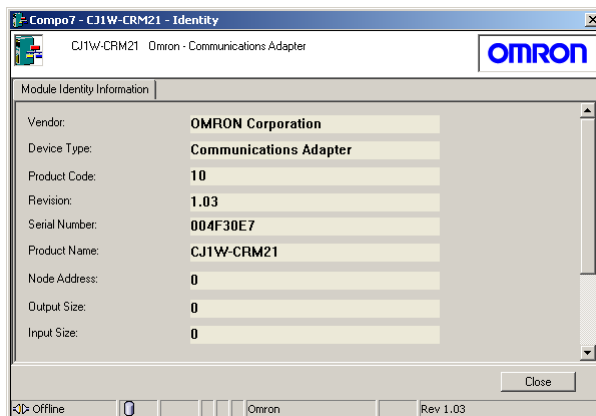



## 7-8-2 Installing Expansion Modules

When a new model of CompoNet Unit is released, the new component can be used by installing an expansion module for the CX-Integrator that supports the new component. There are two methods to install expansion modules depending on the format of the information file for the new component.

- DTM installation
- EDS file installation

**Note:** The DTM (Device Type Manager) is add-in software that uses FDT/DTM technology, an open standard for field networks.

**Note:** When using Windows Vista or Windows 7, refer to *Appendix 3*. It provides precautions when installing Expansion Modules.

For information on how to obtain expansion modules, refer to the applicable Unit manual.

### Installing the DTM

The DTM software is used to install component information to the CX-Integrator. Use the following procedure to install the DTM.

1. Start the DTM Installer.
2. Follow the instructions in the dialog box that is displayed to continue the installation.
3. Start the CX-Integrator. If the CX-Integrator is already running, select **Update DTM Catalog** from the Tools Menu.

Installation complete.

The new component is displayed on the DTM (CompoNet) Tab Page component list.

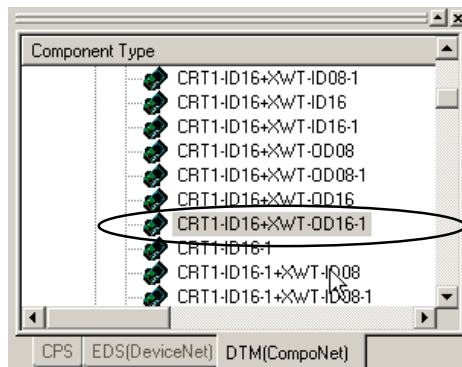

### EDS File Installation

An EDS file contains the new component information. Use the following procedure to install the EDS file.

1. Select **Tools – EDS file – Install EDS**.
2. Select the EDS file provided by the vendor of the new Unit.
3. Click the **Open** Button. The EDS file will be installed.  
After the installation has been completed, the new component will be displayed in the tree of the component list on the DTM (CompoNet) Tab Page.

**7-8 Other CompoNet Functions**  
**7-8-2 Installing Expansion Modules**

# **Communications**

## **Section 8 CompoWay/F**

This section explains the settings and operations specific to the CompoWay/F system.

# 8-1 CompoWay/F System Configuration

## 8-1-1 Overview

The CompoWay/F communications configuration (including slave parameters) can be uploaded using any one of the following three system configurations.

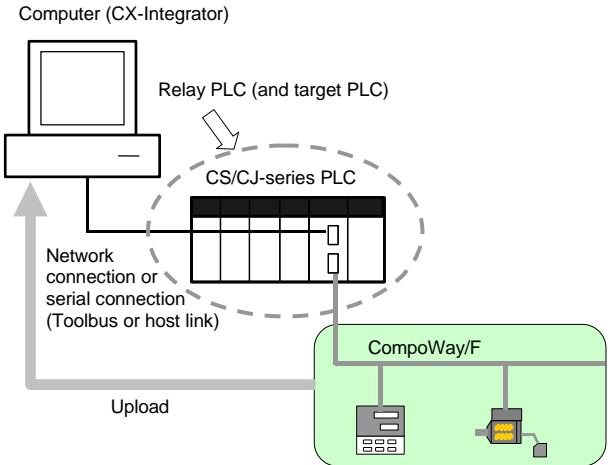
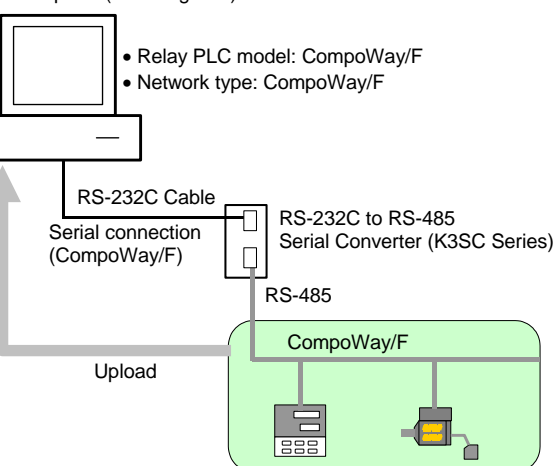
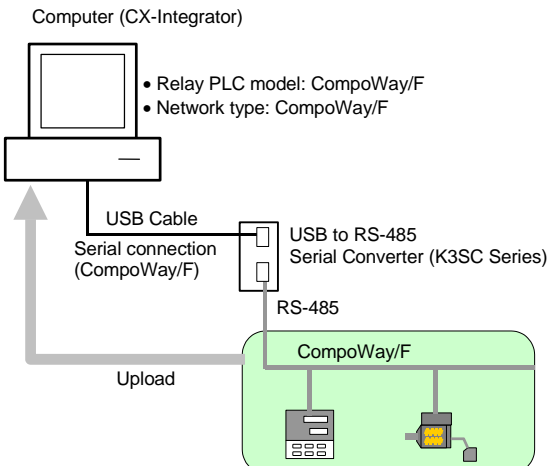
CompoWay/F Slaves that are uploaded	Communications configuration
1) CompoWay/F Slaves connected to a CS/CJ-series PLC (CPU Unit or Serial Communication Board/Unit) or serial port C on the Controller Section of an NSJ-series NSJ Controller	 <p>Computer (CX-Integrator)</p> <p>Relay PLC (and target PLC)</p> <p>CS/CJ-series PLC</p> <p>Network connection or serial connection (Toolbus or host link)</p> <p>CompoWay/F</p> <p>Upload</p>
2) CompoWay/F Slaves directly connected to a computer (CX-Integrator)	 <p>Computer (CX-Integrator)</p> <ul style="list-style-type: none"> <li>• Relay PLC model: CompoWay/F</li> <li>• Network type: CompoWay/F</li> </ul> <p>RS-232C Cable</p> <p>Serial connection (CompoWay/F)</p> <p>RS-232C to RS-485 Serial Converter (K3SC Series)</p> <p>RS-485</p> <p>CompoWay/F</p> <p>Upload</p>
3) CompoWay/F Slaves directly connected to a computer (CX-Integrator) by a USB cable	 <p>Computer (CX-Integrator)</p> <ul style="list-style-type: none"> <li>• Relay PLC model: CompoWay/F</li> <li>• Network type: CompoWay/F</li> </ul> <p>USB Cable</p> <p>Serial connection (CompoWay/F)</p> <p>USB to RS-485 Serial Converter (K3SC Series)</p> <p>RS-485</p> <p>CompoWay/F</p> <p>Upload</p>

## 8-2 CompoWay/F Slaves Connected to a PLC

### 8-2-1 Communications with CompoWay/F Slaves through a PLC

Use the following procedures to transfer network information of CompoWay/F Slaves connected to a serial port of a CS/CJ-series CPU Unit or Serial Communications Board/Unit, or serial port C on the Controller Section of an NSJ-series NSJ Controller.

Example: In the following example, an E5CN Temperature Controller is connected to port 1 (RS-422/RS-485 port) of a CJ1W-SCU41-V1 Serial Communications Unit with the CompoWay/F protocol.

#### Before Connecting by CompoWay/F Protocol

Before connecting by the CompoWay/F protocol, edit the CJ1W-SCU41-V1 Unit's parameters to set the serial port 1 *Serial communications mode* to **Serial Gateway**.

1. Right-click the Serial Communications Unit in the I/O table and select **Unit Setup**. The Edit Parameters Dialog Box will be displayed.

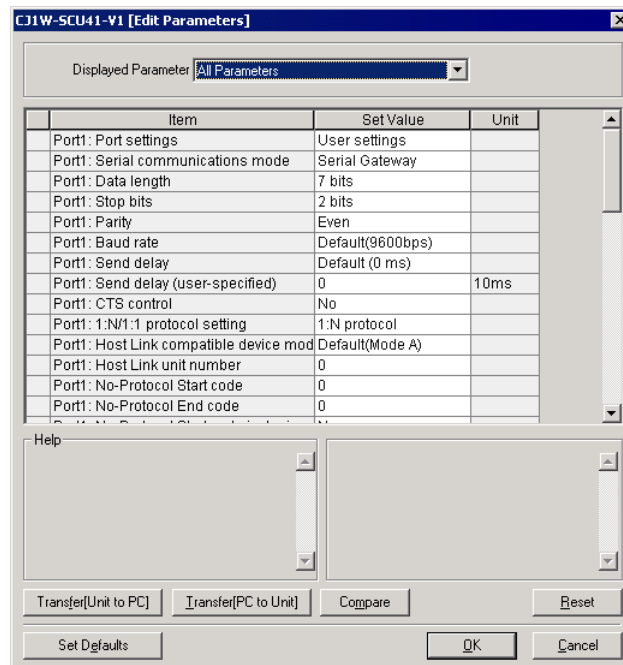

2. Set the *Port 1: Port settings* set value to **User settings**.
3. Set the *Port 1: Serial communications mode* set value to **Serial Gateway**.

Example: Unit settings for a Serial Communications Unit/Board

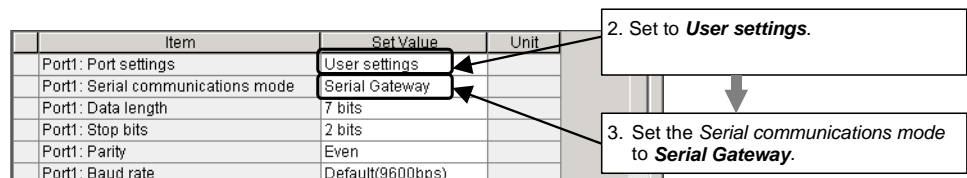

**Uploading the CompoWay/F Network Configuration**

1. With the CX-Integrator online, right-click the Serial Communications Unit under the target PLC in the Online Connection Information Window and select **Connect**.

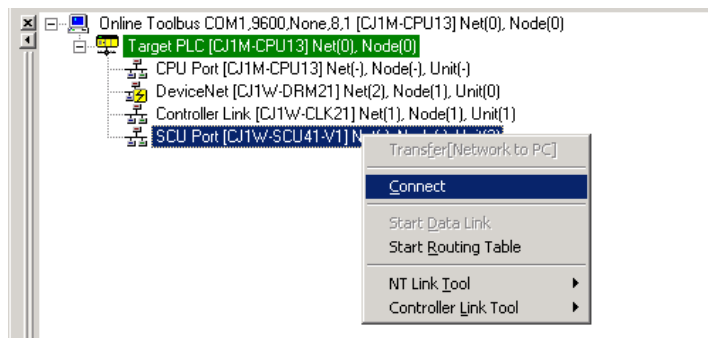

2. A dialog box will be displayed to select one of the Serial Communications Unit's serial ports. Select **PORT1** (RS-422A/RS-485 port) and click the **OK** Button.

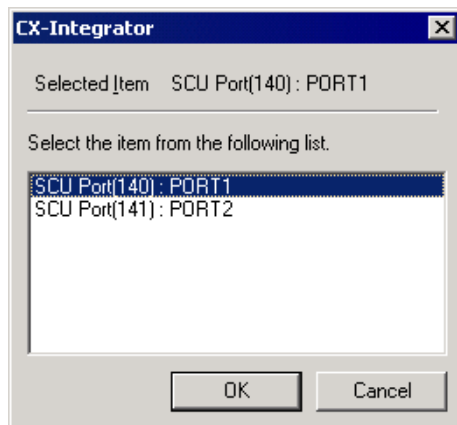

3. A dialog box will be displayed to select the communications protocol. Select **CompoWayF** as the Port 1 (RS-422A/RS-485 port) protocol and click the **OK** Button.

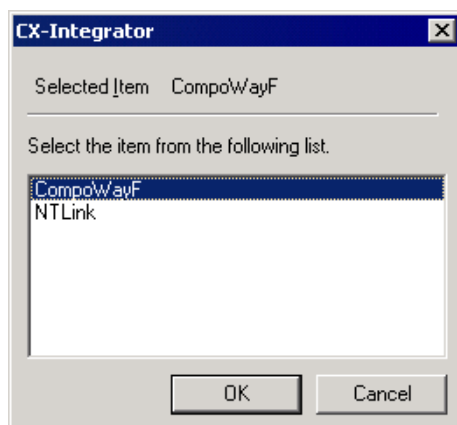

Note: The CompoWay/F protocol communications will be enabled when **CompoWayF** is selected in the dialog box above and **Serial Gateway** is selected for port 1 in the Serial Communications Unit's Unit parameters.

4. The  icon will be displayed next to the Serial Communications Unit to indicate that the Serial Communications Unit's serial port (port 1) can be accessed through CompoWay/F protocol communications.

## 8-2 CompoWay/F Slaves Connected to a PLC

### 8-2-1 Communications with CompoWay/F Slaves through a PLC

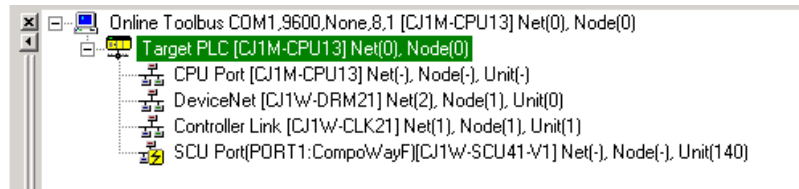

- Right-click the Serial Communications Unit in the Online Connection Information Window and select **Transfer [Network to PC]**.

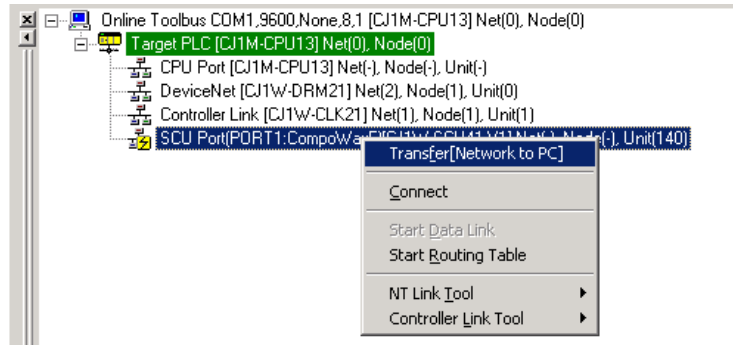

- The following confirmation dialog box will be displayed. Click the **Yes** Button.

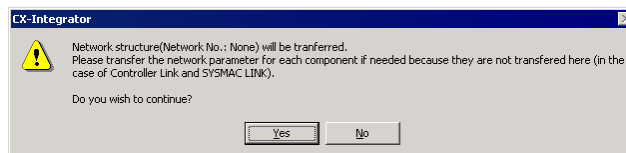

- The Compoway/F Finding node settings Dialog Box will be displayed.

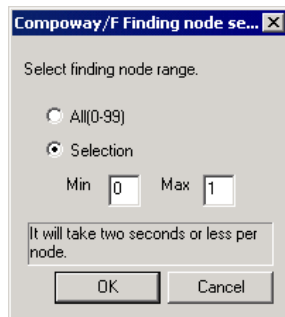

If the CompoWay/F Slave node's node address is unknown:

Select the *All (0-99)* Option.

If the CompoWay/F Slave node's node address is known:

Select the *Selection* Option and set the minimum and maximum addresses for the CompoWay/F Slave node address range.

**Note** If you already know the range of node addresses set for the CompoWay/F Slaves, select the *Selection* Option, specify the node address search range (finding node range), and transfer the node parameters.

The search will take about 20 seconds for each node that is not actually connected, so it will take about 35 minutes for the transfer to be completed if the *All(0-99)* Option is selected. For the same reason, the transfer will take longer if the *Selection* Option is selected and the maximum node address is higher than the node address of the nodes actually connected.

**8-2 CompoWay/F Slaves Connected to a PLC**  
**8-2-1 Communications with CompoWay/F Slaves through a PLC**

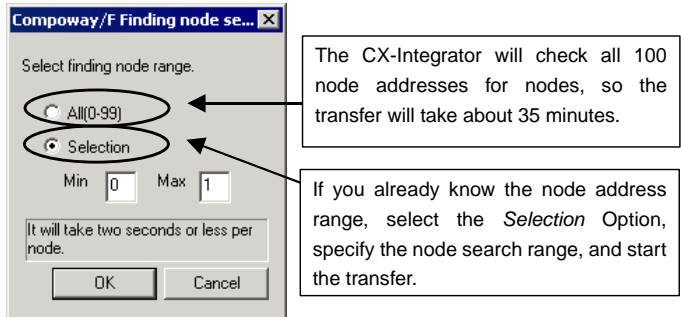

The CompoWay/F Slave upload starts when the **OK** Button is clicked.

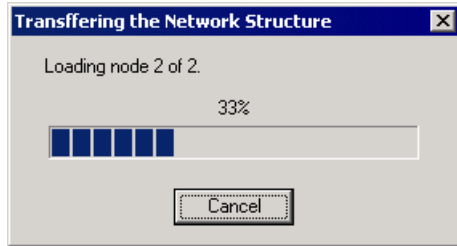

8. The following dialog box will be displayed when the CompoWay/F Slave transfer is completed.  
Click the **OK** Button.

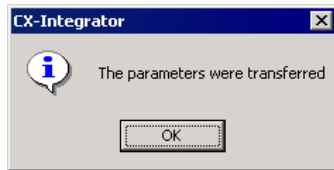

The following dialog box will be displayed if no CompoWay/F Slaves could be found.  
Click the **OK** Button.



9. A CompoWay/F Slave (such as a Temperature Controller) connected directly to the CPU Unit's built-in RS-232C serial port is displayed in the Network Configuration Window along with a PLC.  
At the same time, a new CompoWay/F network is added in the Workspace Window.



## 8-2 CompoWay/F Slaves Connected to a PLC

### 8-2-1 Communications with CompoWay/F Slaves through a PLC

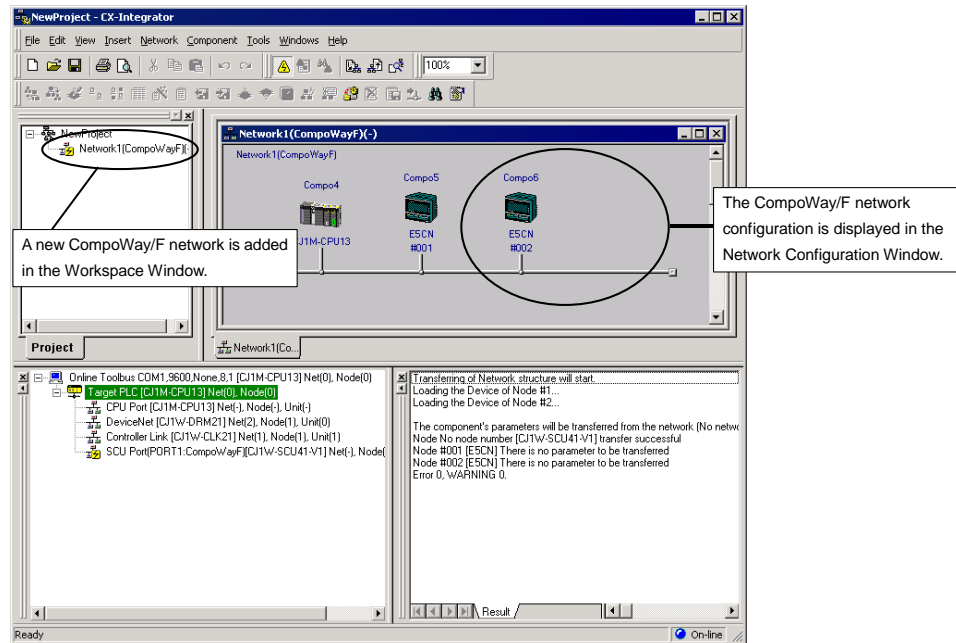

Note: With CX-Integrator 2.1 or higher, the network address of the CompoWay/F network will be displayed when uploading the CompoWay/F network if it is registered in the PLC's routing tables (uploaded CompoWay/F network address display function).

## 8-2 CompoWay/F Slaves Connected to a PLC

### 8-2-2 Setting the CompoWay/F Slave's Parameters

#### 8-2-2 Setting the CompoWay/F Slave's Parameters

The following procedure applies to a CompoWay/F Slave that is connected to a PLC. Use this procedure to set the parameters of the CompoWay/F Slave after the node's parameters have been uploaded to the computer (CX-Integrator).

##### Temperature Controller

1. Right-click the icon of the Temperature Controller (an E5CN in this example) in the Network Configuration Window and select **Start Special Application – Start with Settings Inherited**.

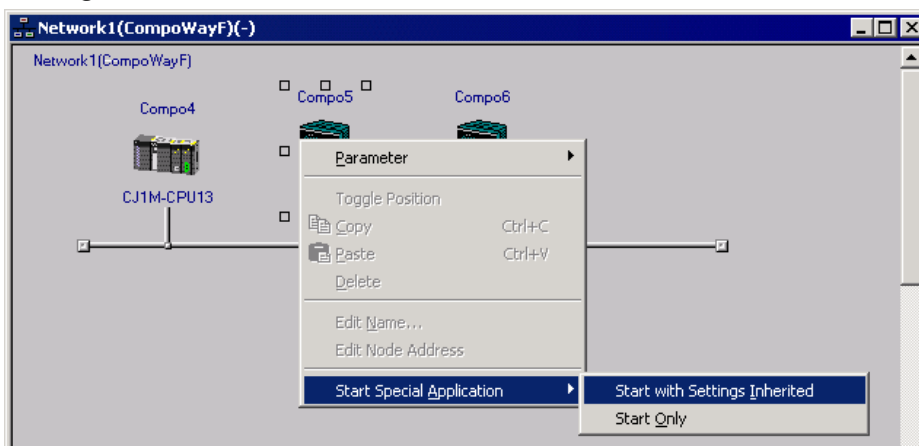

2. The CX-Thermo application will receive the Temperature Controller model number and start. After the parameter settings are completed, download the set values to the E5CN.

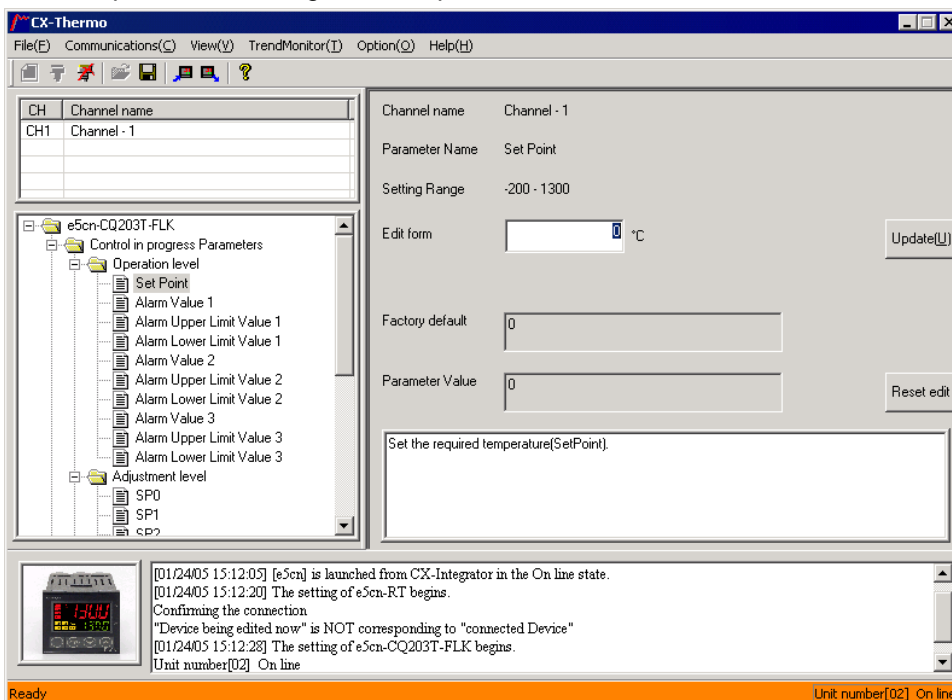

## 8-2 CompoWay/F Slaves Connected to a PLC

### 8-2-2 Setting the CompoWay/F Slave's Parameters

**Note** When a K3SC Serial Converter is connected to the PLC's RS-232C port and a Temperature Controller is connected to the K3SC by RS-485, make an RS-232C cable with the following wiring to connect the PLC's RS-232C port to the K32-23209 Attachment Adapter.

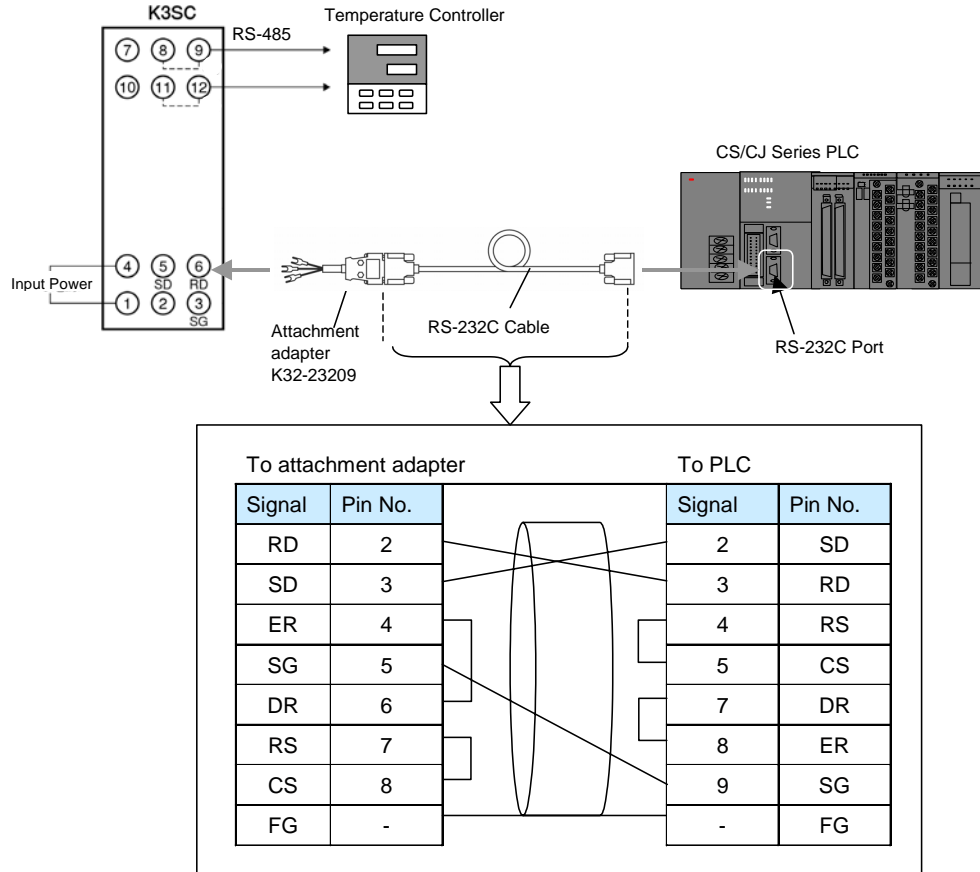

### Procedure for Smart Sensors

1. Right-click Smart Sensor in the Network Configuration Window and select **Parameter – Edit**.
2. The Edit Parameters Dialog Box will be displayed.  
After setting the parameters, select **Transfer [PC to Unit]** to download the settings to the Smart Sensor.

## 8-3 CompoWay/F Slaves Connected to a Computer

Use the following procedures to transfer network information of CompoWay/F Slaves connected directly to the computer (CX-Integrator) without going through a PLC.

### 8-3-1 Reading from Slaves Connected to the Computer

1. Select **Network – Communication Settings** from the menu bar.  
The Change PLC Dialog Box will be displayed.

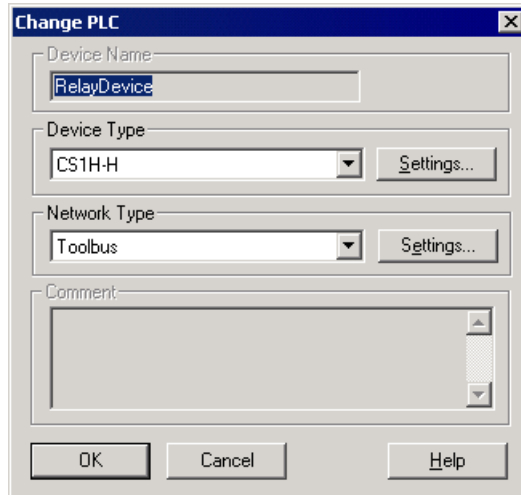

2. Select **CompoWay/F Device** from the Device Type List.

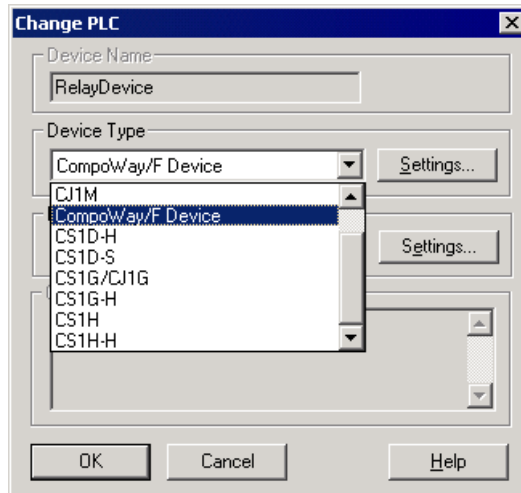

Click the **Settings** Button and select the Driver Tab to display the Network Settings.

## 8-3 CompoWay/F Slaves Connected to a Computer

### 8-3-1 Reading from Slaves Connected to the Computer

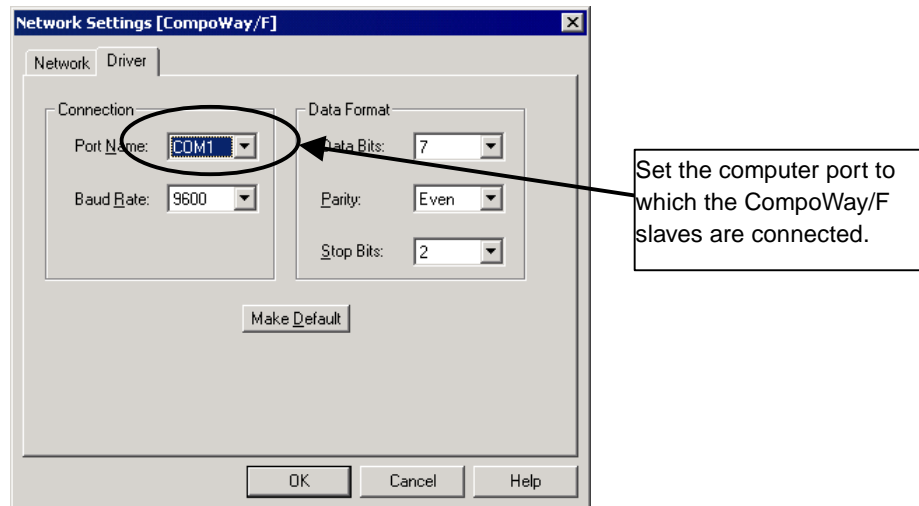

After completing the network settings, click the **OK** Button.

3. Select **Network – Work Online** from the menu bar.  
(CompoWay/F Slaves cannot be connected online by selecting **Auto Online**, so be sure to select **Work Online**.)

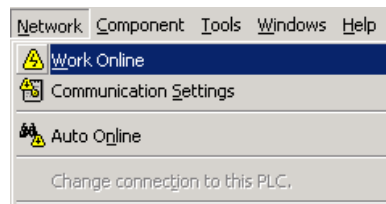

4. When the CompoWay/F Slave is connected online, the Slave will be displayed in the Online Connection Information Window. Right-click the CompoWay/F Slave and select **Transfer [Network to PC]**.

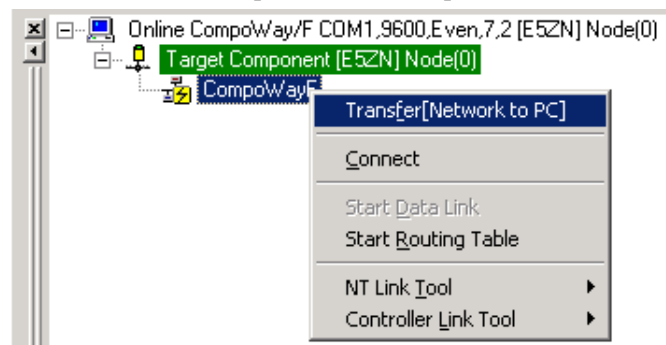

5. The following confirmation dialog box will be displayed.  
Click the **Yes** Button.

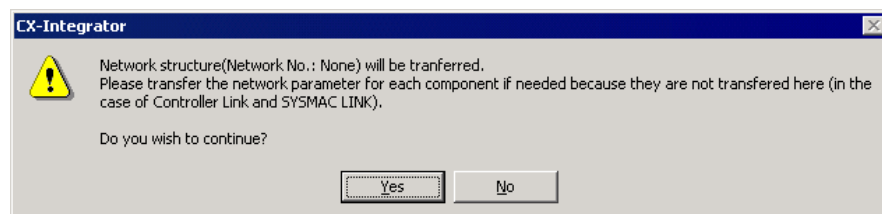

**8-3 CompoWay/F Slaves Connected to a Computer**  
**8-3-1 Reading from Slaves Connected to the Computer**

6. The Compoway/F Finding node settings Dialog Box will be displayed.

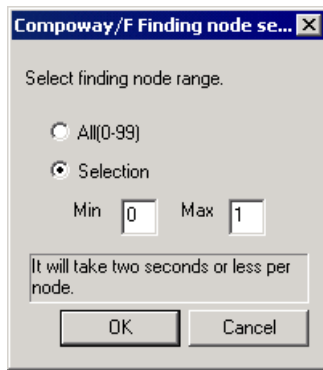

If the CompoWay/F Slave node's node address is unknown:

Select the *All (0-99)* Option.

If the CompoWay/F Slave node's node address is known:

Select the *Selection* Option and set the CompoWay/F Slave's node address.

The CompoWay/F Slave upload starts when the **OK** Button is clicked.

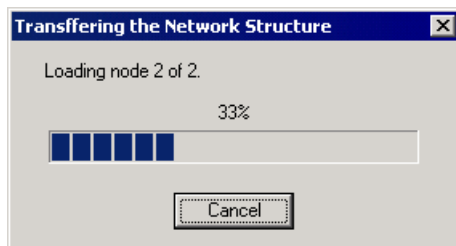

7. The following dialog box will be displayed when the CompoWay/F Slave transfer is completed.

Click the **OK** Button.

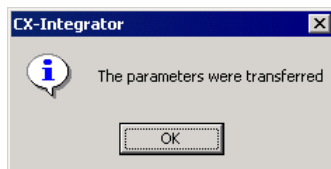

The following dialog box will be displayed if no CompoWay/F Slaves could be found.

Click the **OK** Button.

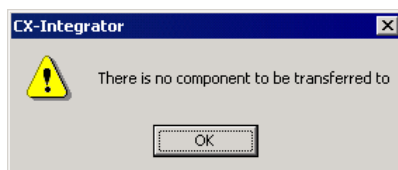

8. The CompoWay/F Slave connected directly to the computer (CX-Integrator) is displayed in the Network Configuration Window. The CompoWay/F network is also added in the Workspace Window.

Example: Connecting an E5ZN Temperature Controller

Right-click the E5ZN Temperature Controller in the Network Configuration Window and select **Start Special Application – Start with Settings Inherited**.

## 8-3 CompoWay/F Slaves Connected to a Computer

### 8-3-1 Reading from Slaves Connected to the Computer

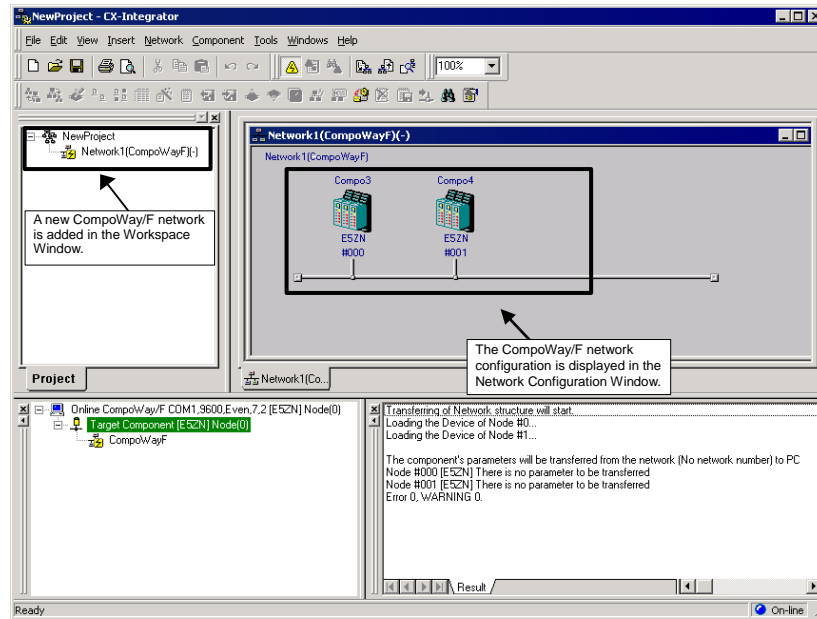

The CX-Thermo application will receive the Temperature Controller model number and start. After the parameter settings are completed, download the set values to the E5ZN.

Refer to the CX-Thermo Help function for details on setting parameters and downloading parameter settings to components.

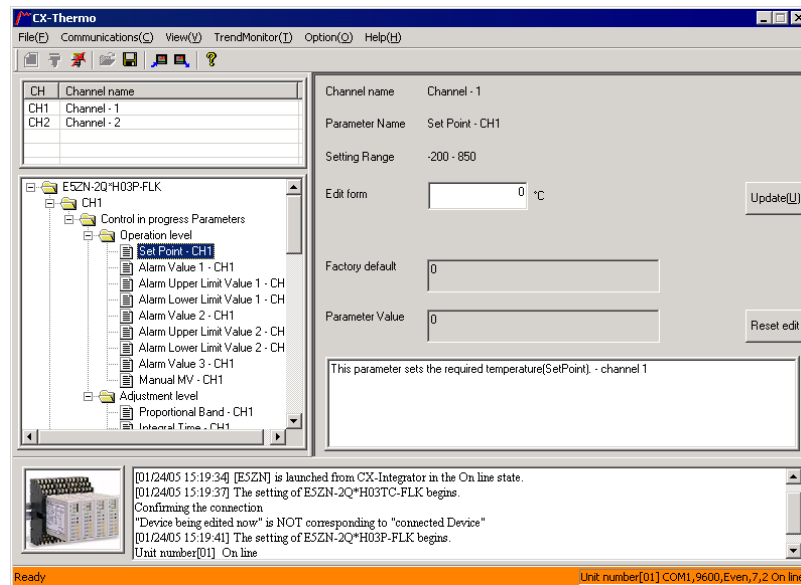

#### Note

- When connecting the computer and CompoWay/F Slave, use a K3SC Serial Converter to convert between the computer's RS-232C communications and the CompoWay/F Slave's RS-485 communications.

**8-3 CompoWay/F Slaves Connected to a Computer**  
**8-3-1 Reading from Slaves Connected to the Computer**

**Applicable Serial Converter:**

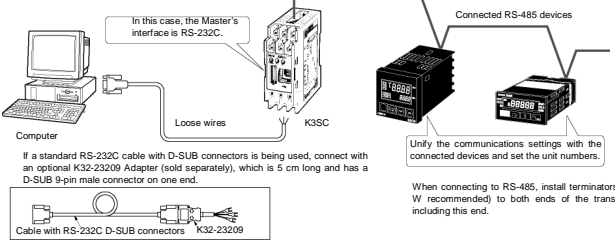
RS-232C to RS-485 Adapter	General-purpose RS-232C cable
<p>K3SC Serial Converter (Set RS-232C in the Master.)</p>	<p>Standard RS-232C cable (D-SUB 9-pin female on both ends) + K32-23209 Attachment Adapter (D-SUB 9-pin male on one end, fork terminals on the other end)</p>  <p>In this case, the Master's interface is RS-232C.</p> <p>Computer</p> <p>Loose wires</p> <p>K3SC</p> <p>Connected RS-485 devices</p> <p>Unify the communications settings with the connected devices and set the unit numbers.</p> <p>When connecting to RS-485, install terminators (120 Ω, 1/2 W recommended) to both ends of the transmission line, including this end.</p> <p>If a standard RS-232C cable with D-SUB connectors is being used, connect with an optional K32-23209 Adapter (sold separately), which is 5 cm long and has a D-SUB 9-pin male connector on one end.</p> <p>Cable with RS-232C D-SUB connectors K32-23209</p>



# **Communications**

## **Section 9 NT Links**

This section explains the settings and operations specific to the NT Link system.

## 9-1 NT Link Connection Auto-detect Function

### 9-1-1 Overview

## 9-1 NT Link Connection Auto-detect Function

### 9-1-1 Overview

When an NS-series PT is serially connected to a CS/CJ-series PLC through NT Link, the PT's communications settings (NT Link baud rate and the PT's maximum unit number setting) can be detected automatically. The PLC's serial port settings are automatically adjusted to match the detected PT communications settings and provide an automatic connection between the PT and PLC (NT Link Auto Online Setting function).

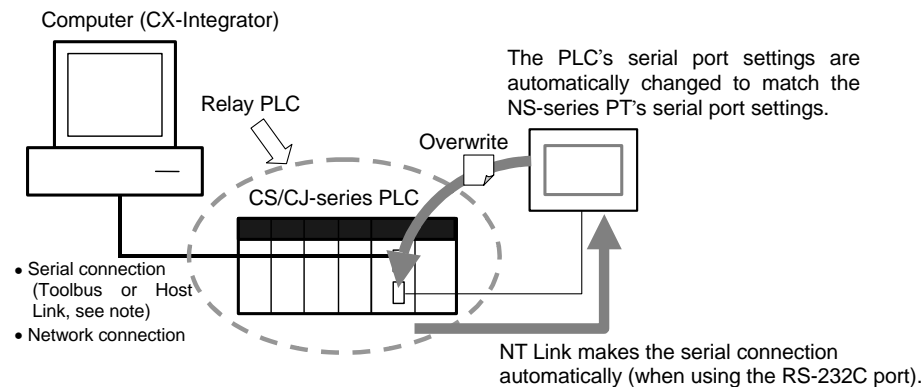

Note: The PLC's serial port settings will be as follows after the automatic connection is established:

- Serial communications mode = NT Link (1:N)
- Port baud rate = NS-series PT's baud rate setting
- Max. unit number in NT Link mode = Connected NS-series PT's setting (Except when the PT's maximum unit number setting is 0, the PLC's setting is 1.)

### 9-1-2 Procedure

The following example demonstrates the operation of the NT Link Connection Auto-detect Function when an NS-series PT is connected to the built-in RS-232C port of a CS/CJ-series PLC's CPU Unit.

1. With the CX-Integrator online, right-click the CPU port listed below the target PLC in the Online Information Window and select **Connect** from the pop-up menu.

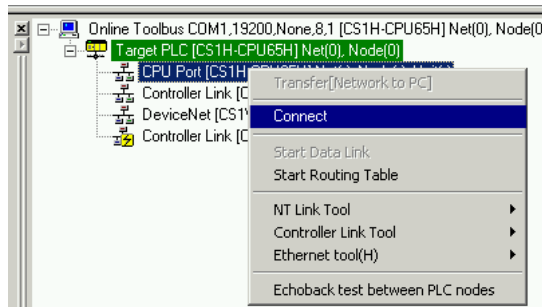

2. A dialog box will be displayed to select one of the CPU Unit's serial ports. Select **Serial Port** (the RS-232C port) and click the **OK** Button.

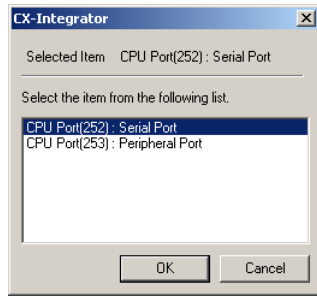

3. A dialog box will be displayed to select the communications protocol. Select **NTLink** and click the **OK** Button.

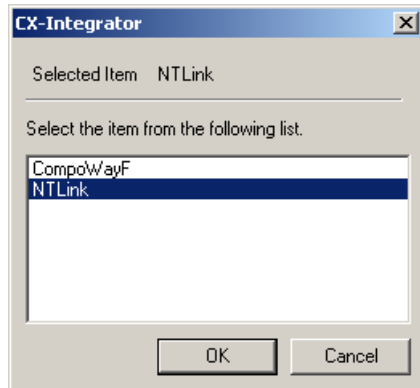

4. The  icon will be displayed next to the CPU Unit's RS-232C port to indicate that the port can be accessed with NT Link protocol.

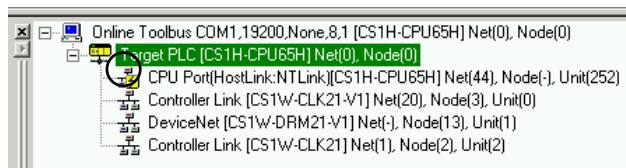

5. Right-click the CPU Unit in the Online Information Window and select **NT Link Tool – NTLink Auto Online Setting**.

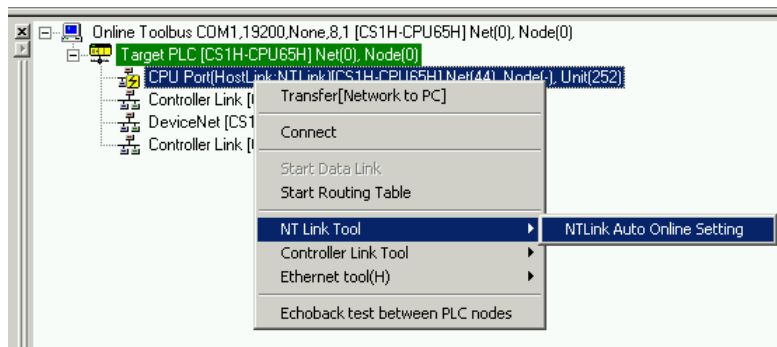

**Note** If the PLC is operating, the following warning dialog box will be displayed. Check the system to be sure that it is safe to change the PLC's operating mode to PROGRAM mode and click the **Yes** Button. If the mode is changed to PROGRAM mode, the PLC will stop operating so be sure that it is all right for the PLC to stop operating.

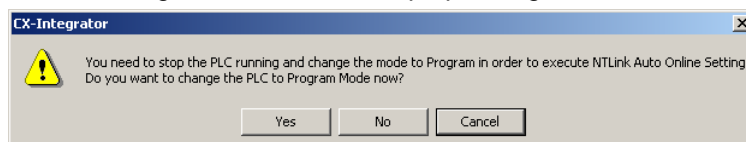

**9-1 NT Link Connection Auto-detect Function**  
**9-1-2 Procedure**

6. The following warning dialog box will be displayed.  
If you click the **OK** Button, the CPU Unit's RS-232C port's communications settings will be overwritten. Verify that the CPU Unit's RS-232C port is not communicating and then click the **OK** Button.

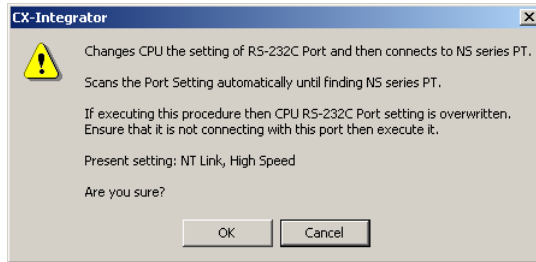

7. The following dialog box will be displayed when an NS-series PT is connected to the CPU Unit's RS-232C port.  
Verify that the pin 5 of the CPU Unit's DIP switch is OFF and then click the **OK** Button.

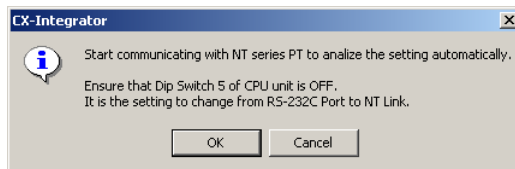

8. The NT Link Connection Auto-detect Function will be executed.  
The following dialog box will be displayed to show the progress of the automatic connection operation.

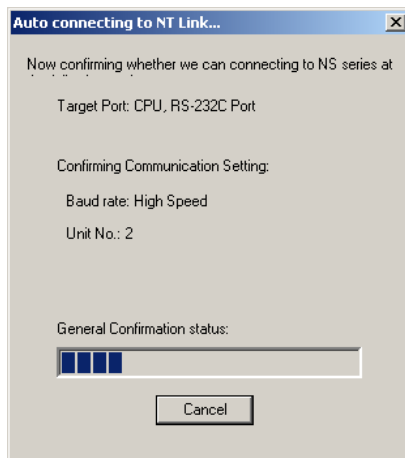

9. The following dialog box will be displayed if the connection with the PT is established automatically.  
Click the **OK** Button.

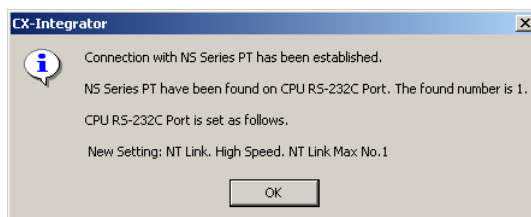

**9-1 NT Link Connection Auto-detect Function**  
**9-1-2 Procedure**

10. If the PLC's operating mode was changed from RUN mode, the following dialog box will be displayed to switch from PROGRAM mode back to RUN mode. To return to RUN mode, click the **Yes** Button.

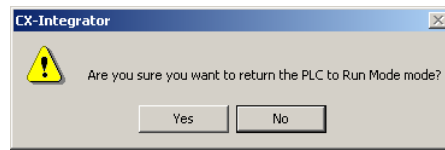

11. The following dialog box will be displayed. To transfer the network configuration to the computer, click the **OK** Button.

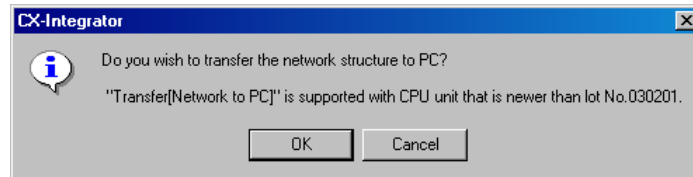

12. The Network Transfer Dialog Box will be displayed. Execute the transfer according to the dialog box.

## 9-2 Transferring Screen Data through the PLC

### 9-2-1 Overview

## 9-2 Transferring Screen Data through the PLC

### 9-2-1 Overview

The CX-Designer can be started from an NS-series PT in the Network Configuration Window and created screen data can be transferred through a CS/CJ-series PLC (see note) to a serially connected NT-series PT.

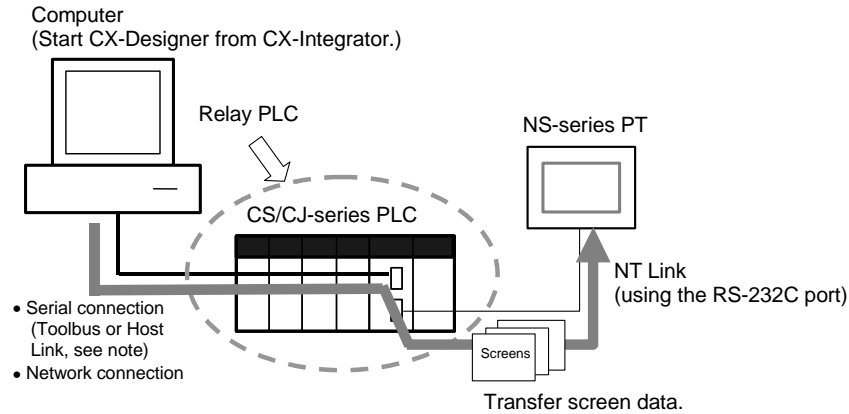

Note: Since the RS-232C port is used by the PT, the peripheral port must be used to make a direct serial connection to the computer.

Note: In order to transfer screen data through the PLC, the PLC must be a CS/CJ-series PLC with a CPU lot number of 030201 (manufactured February 1, 2003) or later. In addition, the CPU Unit must be a CS1G-H, CS1H-H, CS1D-S, CJ1M, CJ1G-H, or CJ1H-H. (The screen data cannot be transferred through a CS1D-H).

### 9-2-2 Procedure

The following example demonstrates how to transfer screen data through the CPU Unit's serial port.

1. Select **Network – Work Online** or **Network – Auto Online** from the menu bar. In this case, **Auto Online** has been selected.

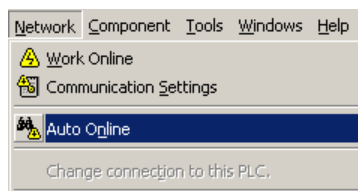

2. The Select Serial Port Dialog Box will be displayed. Select the desired computer communications port from the pull-down menu and click the **OK** Button.

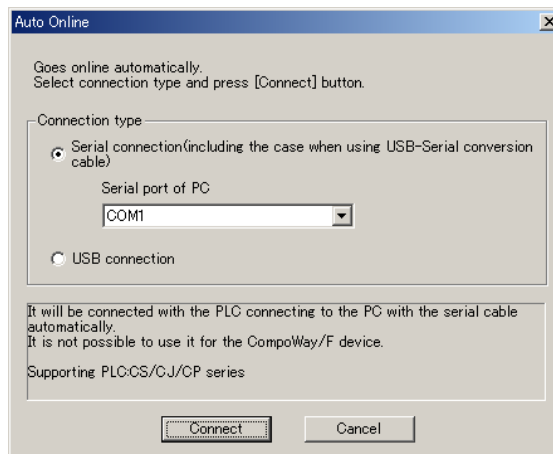

## 9-2 Transferring Screen Data through the PLC

### 9-2-2 Procedure

- The PLC will be connected online to the computer and the PLC's rack configuration will be displayed in the Online Information Window. Right-click the CPU port and select **Connect** from the pop-up menu.

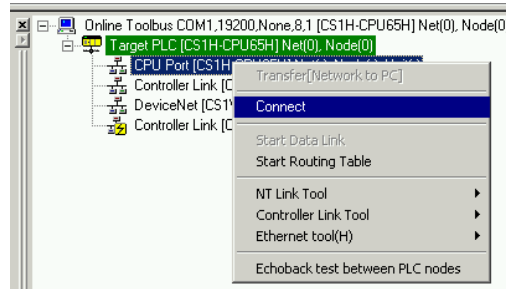

- A dialog box will be displayed to select the CPU Unit's serial port. Select **Serial Port** (the RS-232C port) and click the **OK** Button.

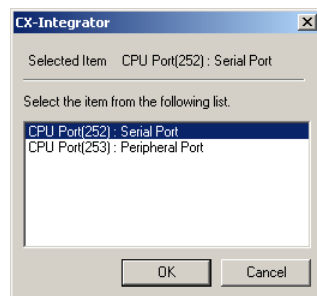

- The  icon will be displayed next to the CPU Unit's RS-232C port to indicate that the port can be accessed with NT Link protocol.

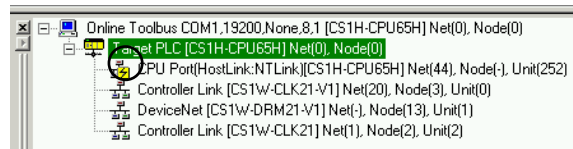

- Right-click the CPU Unit in the Online Information Window and select **Transfer [Network to PC]**.

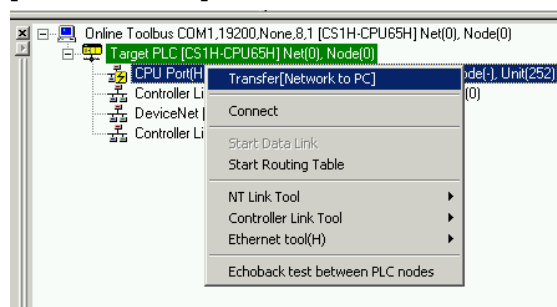

- The following dialog box will be displayed to confirm the transfer. Click the **Yes** Button to transfer the network configuration of the NT Link network connected to the CPU Unit's built-in RS-232C port.

## 9-2 Transferring Screen Data through the PLC Procedure

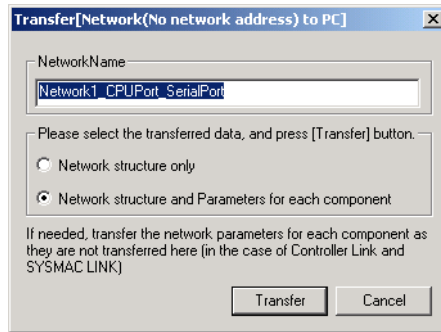

8. The following dialog box will be displayed when the transfer is completed. Click the **OK** Button.



**Note** The following conditions must be satisfied in order to correctly transfer the network configuration.

- The CS/CJ-series CPU Unit must be of Lot No. 030201 (Feb. 1 2003) or later.
- The NS-series PT system version must be 6.0 or later.

If the lot number for the CPU Unit to be connected is too old, or if the PT version is too old, the following message will be displayed.

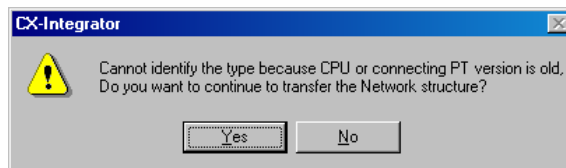

IF this occurs, the network configuration will not be correctly transferred, the NS-series PT will display Unknown-HMI, and the special application will not start (in a following step below). Start the CX-Designer separately and make the settings.

9. The NS-series PT connected directly to the CPU Unit's built-in RS-232C serial port will be displayed in the Network Configuration Window along with one PLC. (The Network Configuration Window's background will be gray to indicate that the CX-Integrator is online.)  
At the same time, the NT Link will be added in the Workspace Window.



## 9-2 Transferring Screen Data through the PLC

### 9-2-2 Procedure

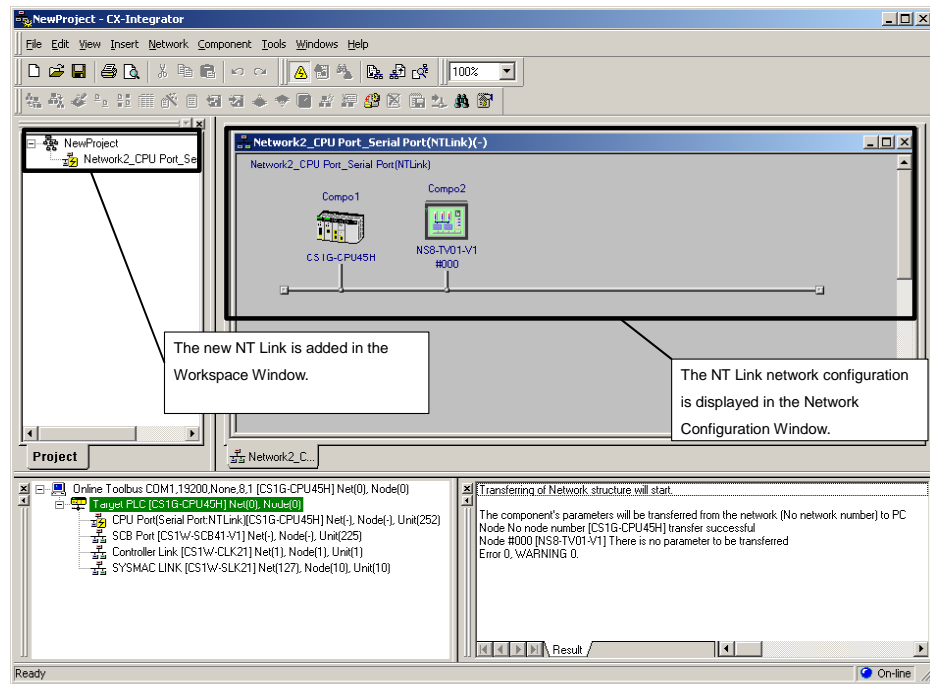

10. Right-click the icon of the NS-series PT in the Network Configuration Window and select **Start Special Application – Start with Settings Inherited**.

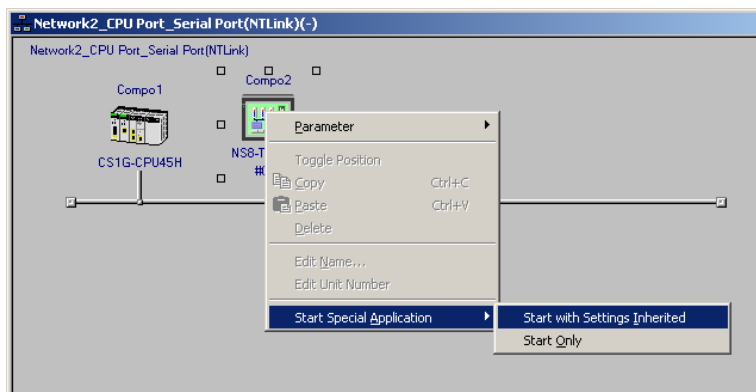

CX-Designer will start and a dialog box will be displayed for selecting the project.

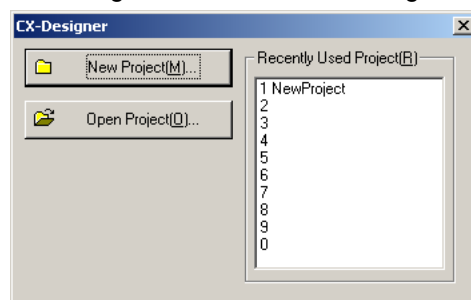

11. Click the **New Project** Button. The NS-series PT model and version will be inherited, and the New Project Dialog Box will be displayed.

## 9-2 Transferring Screen Data through the PLC Procedure

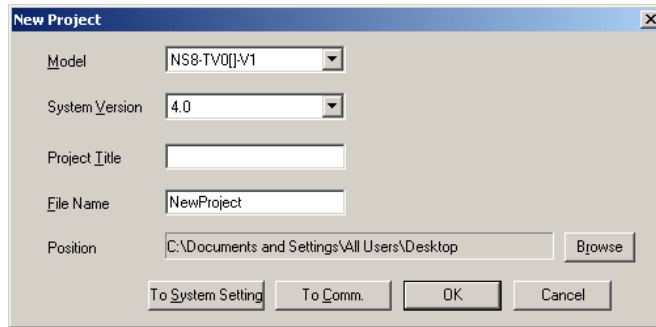

12. Click the **OK** Button to create the new screen data. The created screen data will be created in a project file (.ipp extension) for transfer to the NS-series PT.
13. To transfer the screen data to the NS-series PT, select either **Quick Transfer [To PT]** or **Transfer [To PT]** from the PT menu. The following dialog box will be displayed for confirmation.

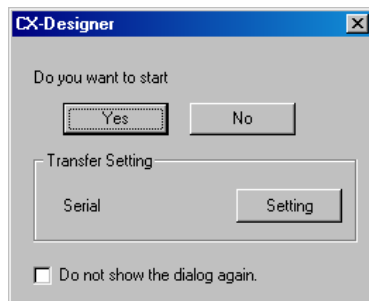

For details on the transfer method, refer to the *CX-Designer User's Manual* (Cat. No. V099).

The following flowchart outlines the procedure up to the screen data transfer.

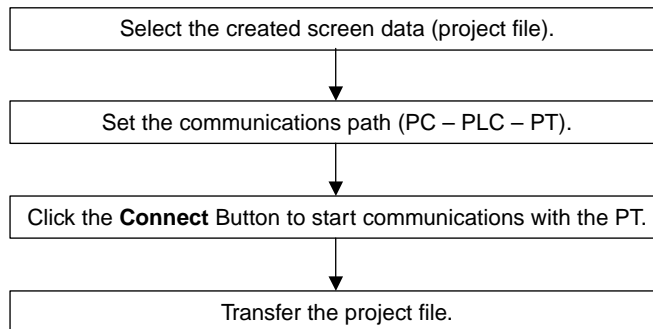

# **Communications**

## **Section 10 Network Testing**

This section explains the operations of the following network test tools:

Controller Link Network Diagnostic Tool

Echoback test between nodes (Ethernet, Controller Link, SYSMAC LINK, DeviceNet)

Ethernet ping test

## 10-1 Controller Link Network Diagnostic Tool

### 10-1-1 Diagnostic Functions and Flowcharts

# 10-1 Controller Link Network Diagnostic Tool

## 10-1-1 Diagnostic Functions and Flowcharts

### Introduction

The Controller Link Network Diagnostic Tool can perform a variety of diagnostic operations, such as checking the operating status of a Controller Link network made up of computers and CS/CJ-series, CVM1/CV-series, and C-series nodes, checking for errors in the node settings, and collecting all of the nodes' error status and error log information.

### Diagnosis Functions

Diagnosis function	Description	Page
Network Status	<ul style="list-style-type: none"><li>• Displays a list of the nodes participating in the specified network.</li><li>• Diagnoses the operating status of the CPU Units and Controller Link Units/Boards and displays information on any errors that have occurred.</li></ul>	10-10-5
Node Settings	<ul style="list-style-type: none"><li>• Reads the settings (e.g., DM Parameter Area settings) for all nodes participating in the specified network and diagnoses the integrity of the overall network.</li><li>• Diagnostic results are displayed in three levels: <i>Errors</i>, <i>Warnings</i>, and <i>Information</i>.</li></ul>	10-10-11
Disconnections	<ul style="list-style-type: none"><li>• For optical ring networks in token ring mode, displays all nodes in the specified network in the order they are physically connected.</li><li>• If the cable has been disconnected, the locations of disconnections are displayed.</li><li>• Displays a list of the disconnection counters measuring each node: Number of node/network separations, number of network disconnections, etc.</li></ul>	10-10-14
Transmission Status	<ul style="list-style-type: none"><li>• Displays the transmission status counters for all nodes in the specified network.</li></ul>	10-10-17
Node Status	<ul style="list-style-type: none"><li>• Displays the current error status and error log for the specified node (CPU Unit or Controller Link Unit/Board).</li></ul>	10-10-18
Collecting Error Logs	<ul style="list-style-type: none"><li>• Collects the error status and error logs for all nodes in the specified network and saves them to a file.</li></ul>	10-10-21

# 10-1 Controller Link Network Diagnostic Tool

## 10-1-1 Diagnostic Functions and Flowcharts

### Operational Flowchart

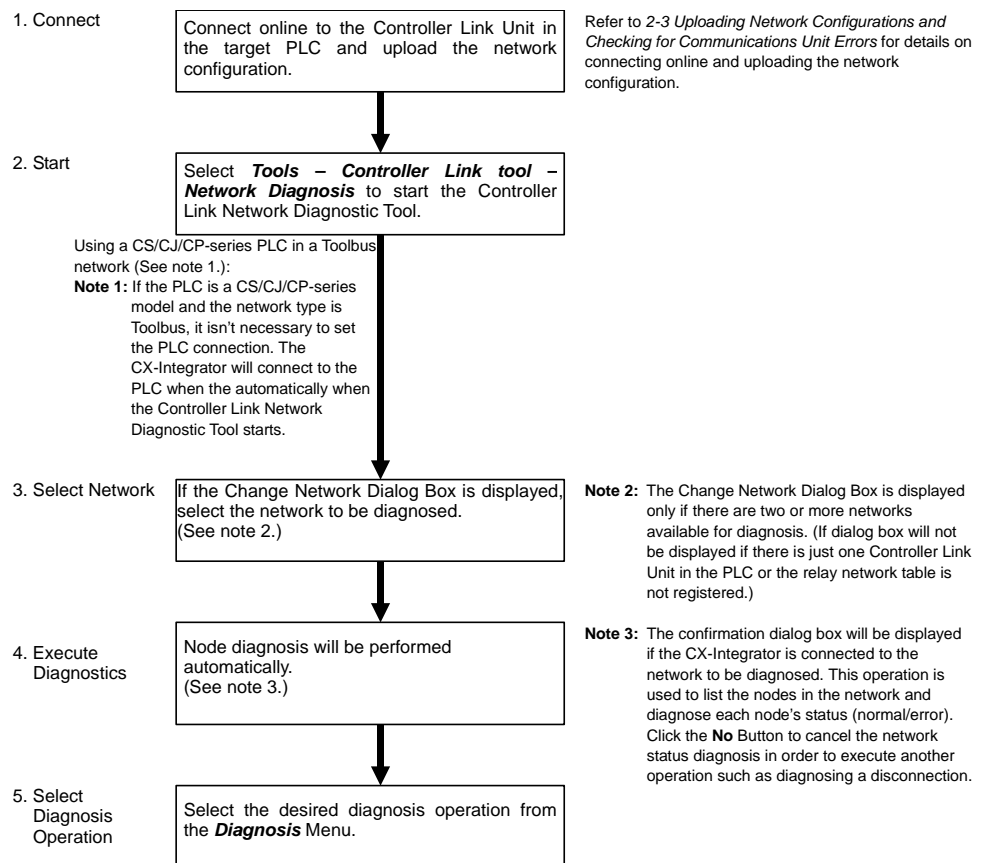

**10-1 Controller Link Network Diagnostic Tool**  
**10-1-1 Diagnostic Functions and Flowcharts**

**Components of the Network Diagnosis Tool Window**

This section describes the various components of the Controller Link Network Diagnostic Tool Window.

**Main Window**

**Component Names and Functions**

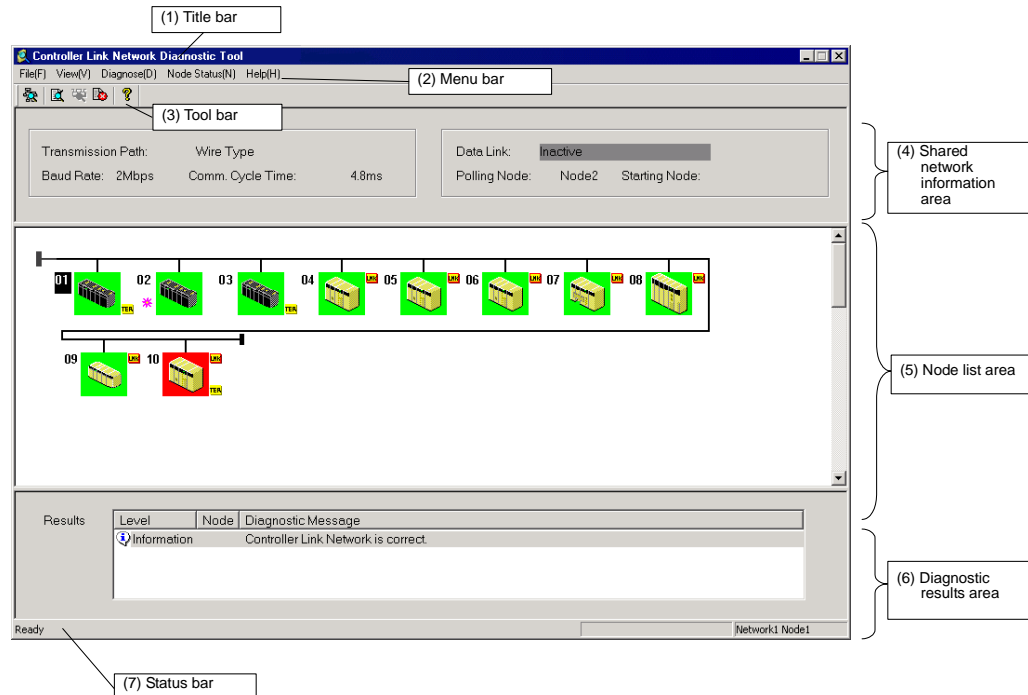

Name	Function
(1) Title bar	Displays the file name when a node file is selected.
(2) Menu bar	Use to select a menu.
(3) Tool bar	Select a function by clicking an icon.
(4) Shared network information area	Displays shared Controller Link network information, such as the transmission path and communications cycle time.
(5) Node list area	Displays the node configuration of the Controller Link network, which was read by executing the network status diagnosis operation. The node status is indicated by the color of its bitmap icon.
(6) Diagnostic results area	Displays the results of the network status diagnosis. Double-click an item to view detailed results.
(7) Status bar	Displays information such as the network address and node address of the node to which the Controller Link Network Diagnostic Tool is connected.

## 10-1-2 Diagnosing Network Status

### Description of Network Status

A list of the nodes participating in the specified network is displayed to show the network status. The operating status of the CPU Unit or Controller Link Unit/Board is diagnosed and information on any detected errors is displayed.

Diagnosis item	Description
Network participation status	Displays the nodes participating in the network using node icons. If a node file has been selected, any differences between the nodes registered in the file and the actual nodes will be displayed.
Current Controller Link Unit errors	<p>Displays errors that have occurred in the Controller Link Unit. The node icons for nodes with errors are displayed with a red background. Diagnosis is performed for the following errors.</p> <ul style="list-style-type: none"> <li>•Data link table errors</li> <li>•Routing table errors</li> <li>•Network parameter errors</li> <li>•Network parameter mismatches</li> <li>•CPU Unit PLC Setup errors</li> <li>•Model errors</li> <li>•Fatal data link errors</li> <li>•EEPROM write errors</li> </ul>
Current CPU Unit errors	<p>Displays errors that have occurred in the CPU Unit. The node icons for nodes with errors are displayed with a red background. Diagnosis is performed for the following errors.</p> <ul style="list-style-type: none"> <li>•Memory errors</li> <li>•I/O bus errors</li> <li>•System errors (FALS)</li> <li>•Program errors</li> <li>•Duplicate number errors</li> <li>•CPU bus errors</li> <li>•Too many I/O points</li> <li>•I/O setting errors</li> <li>•Cycle time too long errors</li> <li>•Fatal Inner Board errors</li> <li>•System errors (FAL)</li> <li>•JMP errors</li> <li>•Indirect DM BCD errors</li> <li>•I/O verification errors</li> <li>•Special I/O Unit errors</li> <li>•CPU Bus Unit errors</li> <li>•SYSMAC BUS/2 errors</li> <li>•SYSMAC BUS errors</li> <li>•Battery errors</li> <li>•CPU Bus Unit setting errors</li> <li>•Momentary power interruption errors</li> <li>•Remove I/O errors</li> <li>•Special Unit errors</li> <li>•PLC Link errors</li> <li>•Host Link errors</li> <li>•Cycle time errors</li> <li>•Special I/O Unit setting errors</li> <li>•Inner Board errors</li> <li>•PLC Setup errors</li> <li>•Basic I/O Unit errors</li> <li>•Interrupt task errors</li> <li>•Duplex errors</li> </ul>

## 10-1 Controller Link Network Diagnostic Tool

### 10-1-2 Diagnosing Network Status

#### Diagnosing Network Status

1. Check that the CX-Integrator is online with the PLC connected through Controller Link and select **Tools – Controller Link tool – Network Diagnosis**.

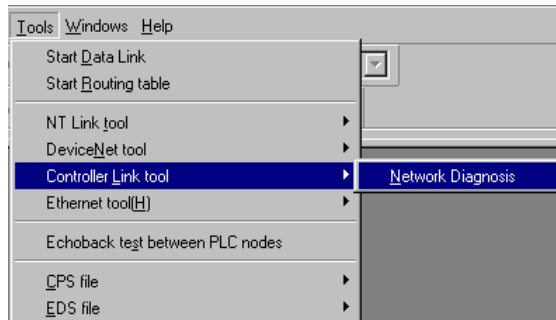

2. The Select Network Dialog Box will be displayed. Select the desired network in the list and click the **OK** Button.

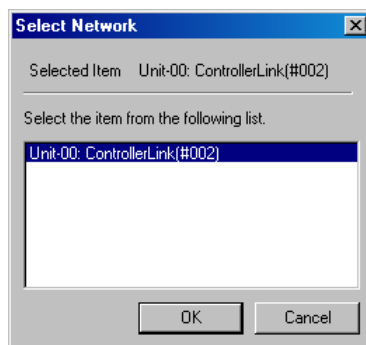

3. Network diagnosis will begin on the selected network. The Controller Link Network Diagnosis Software will start and the network nodes and diagnostic results will be displayed. If the relevant network exists in the project workspace, the node configuration information (network name, node name, branching) will be inherited.

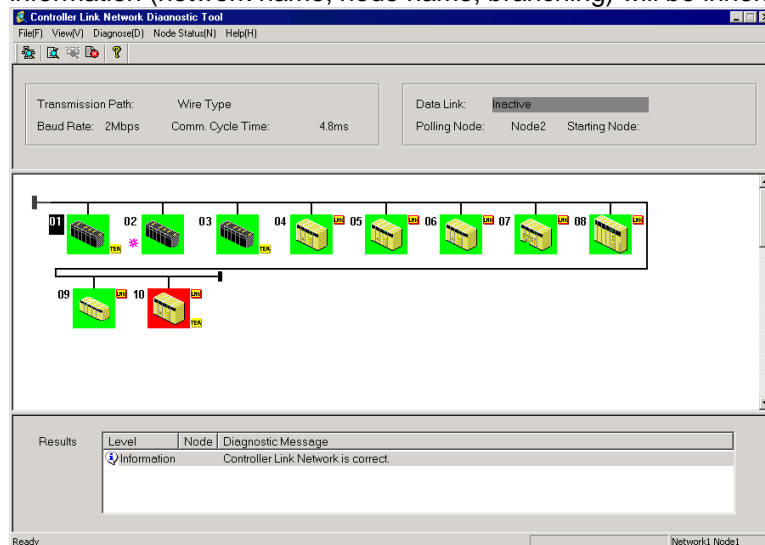



**Network Status Diagnosis Example**

The following window shows the results of an example network status diagnosis.

**Network Configuration on CX-Integrator**

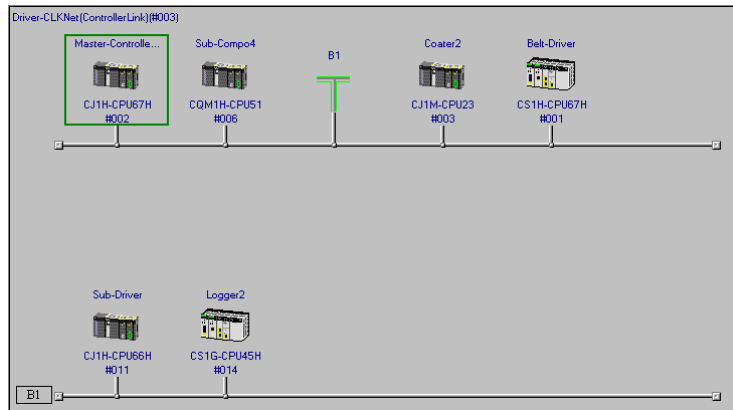

**Network Status Diagnosis Results**

**Controller Link Network Diagnostic Tool**

Transmission Path: Wire Type: Data Link: **Inactive**  
 Baud Rate: 2Mbps Comm. Cycle Time: 3.1ms Polling Node: Node1 Starting Node:

**Data link is stopped.**

**An error has occurred at node 4. (The background is red.)**

**The Units from the Repeater Unit onwards do not exist in the network. There may be a disconnection.**

Results	Level	Node	Diagnostic Message
Error	3		FINS end code error(8A1BH) occurred.
Information	11		This node is not in the network.
Information	14		This node is not in the network.

**The error contents are displayed here. Double-click to display details.**

In the network status list, T-branches that are input offline are displayed as Repeater Units. Main lines and branch lines can be distinguished, and line disconnections in front of Repeater Units can be easily determined. Up to two hierarchies are supported by CLK Repeater Units. If three or more T-branch hierarchies are entered, the following message will be displayed and operation will stop.

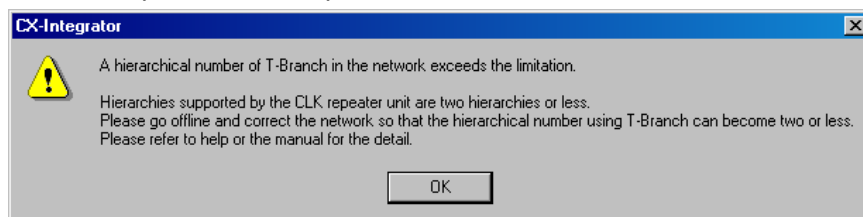

## 10-1 Controller Link Network Diagnostic Tool

### 10-1-2 Diagnosing Network Status

Correct the network so that there are no more than two hierarchies using T-branches, and then restart the Diagnostic Tool. For details, refer to the *Controller Link Repeater Unit Operation Manual*.

- The background of the node icon will be displayed in red when there are errors in a Controller Link Unit or CPU Unit.
- Information on errors at nodes will be displayed in the diagnosis results area.

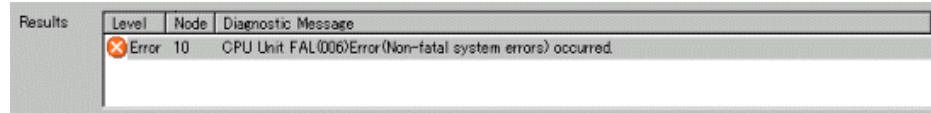

- Errors shown in the diagnosis results area can be double-clicked to display details on the error. (Details on the error can also be displayed by double-clicking node icons with red backgrounds.)

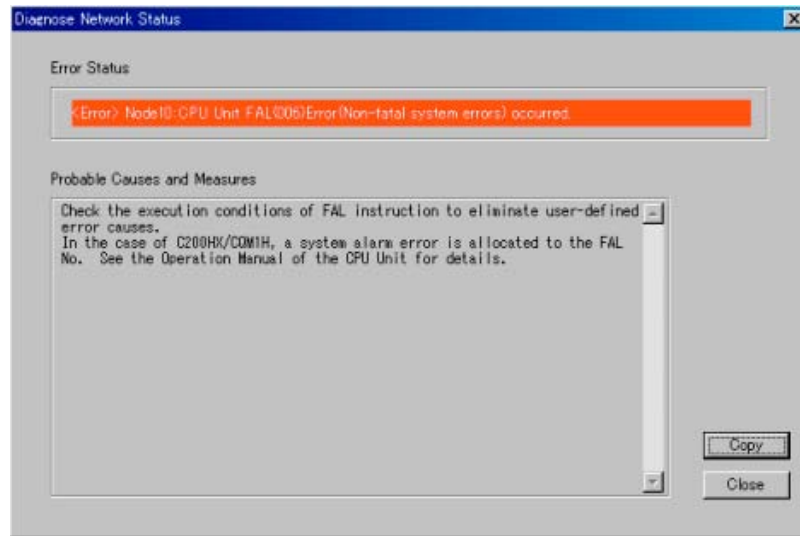

**Note** Errors shown in the diagnosis results area can be double-clicked to display details on the error. When this is done, the contents of the Auxiliary Area or AR and SR Areas are automatically read from the CPU Unit and stored in a file. The file is stored as required in a log file in the folder where the CX-Integrator is installed. The file is in CSV (text) format.

File names consist of the node address and the time from the PLC.

PLC model	Read area
CS Series	Auxiliary Area, A000 to A959
CJ Series	Auxiliary Area, A000 to A959
CVM1/CV Series	Auxiliary Area, A000 to A511
C200HX/HG/HE	AR Area, AR 00 to AR 27 SR Area, SR 236 to SR 289
CQM1H Series	AR Area, AR 00 to AR 27 SR Area, SR 190 to SR 243
Computers (or NS-series Programmable Terminals, Open Network Controllers, etc.)	Cannot be read.

The Auxiliary Area and AR/SR Areas contain details on error status, the time when the power was turned ON to the PLC, etc. This file can be used later for analysis.

**Node Icons**

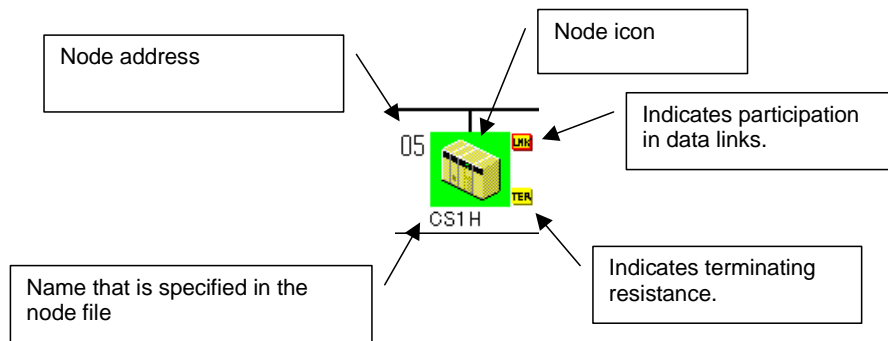

**Displayed Icons**

The icon that is displayed depends on the model of the PLC, as shown below.

Node icon	Model
	CS Series
	CJ Series
	CVM1/CV Series
	C200HX/HG/HE
	CQM1H Series
	Computers (or NS-series Programmable Terminals, Open Network Controllers, etc.)

**Note** A computer will be displayed when a Controller Link node is a Controller Link Support Board.





 will be displayed when the PLC model cannot be determined (e.g., for NS-series Programmable Terminals, Open Network Controllers, etc.)

## 10-1 Controller Link Network Diagnostic Tool

### 10-1-2 Diagnosing Network Status

#### Node Icon Background Colors

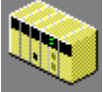
The background color of a node icon will change depending on the status of the Controller Link Unit/Board. The meanings of these colors are described in the following table.

Node icon	Background color	Meaning
	Green	The node is participating in the network and no errors have occurred in the Controller Link Unit or CPU Unit.
	Red	The node is participating in the network but an error has occurred in the Controller Link Unit or CPU Unit.
	Gray	The node is registered in the node file but is not participating in the network.
	Blue	The node is not registered in the node file but is participating in the network.

#### Note

- With the Controller Link Network Diagnostic Tool, the nodes connected to a network can be registered in a node file. If a node file is selected, the nodes registered in the file will be compared to the nodes actually participating in the network and differences will be displayed using the background colors (blue or gray) of the node icons.
- The error status, error log, or unit profile for a Controller Link Unit or CPU Unit can be displayed from a node icon. Right-click the node icon and select an item from the popup menu.

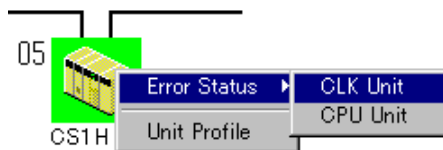

- Refer to *CPU Unit* on page 10-20 for the displays for error status, error logs, and unit profiles.

#### Updating the Diagnosis Results Display

Use the following procedure to update the diagnosis results display. This is enabled at times such as when the terminator settings for the Unit are changed after a network status diagnosis.

1. Either select **View – Update of Node Diagnosis Display** or double-click the Update of Node Diagnosis Display icon.

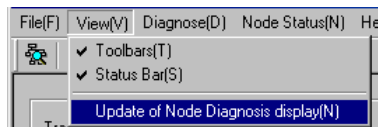

2. The display will be updated. To execute a network status diagnosis for a different network, exit the Diagnosis Tool and restart it from the CX-Integrator.

## 10-1-3 Diagnosing Node Settings

### Diagnosis Items

The settings of all nodes participating in the specified network are read and the integrity of the overall network is diagnosed. The results of diagnosis are displayed in three levels: Error, warning, and information.

Diagnosis item	Description
Integrity of settings in the DM parameter area	<p>The settings in the DM parameter area of the Controller Link Unit are read and displayed.</p> <p>The integrity of the overall Controller Link network is checked.</p> <p>The following DM Area parameter settings are diagnosed.</p> <ul style="list-style-type: none"> <li>• Polling unit/pollled unit settings</li> <li>• CPU Bus Unit system settings initialization specifications (EEPROM clear specification)</li> <li>• Designation of 62 nodes for Wired Units</li> <li>• Data link status storage formats</li> <li>• Data link mode specifications</li> <li>• Data link startup switches</li> <li>• Transmission path types</li> <li>• Routing table enable/disable specifications</li> </ul>
Status of terminating resistance switches	The settings of the terminating resistance switches are diagnosed for Wired Controller Link Units/Boards.
External power supply status	The status of external power supply is diagnosed for Optical-ring Controller Link Units/Boards.

**Note**

- Different Units support different settings in the DM parameter area. Check the Operation Manual for the Unit for details.  
For the Controller Link Support Board, the settings are made in the FinsGateway driver properties. Refer to the *Operation Manual* for the Support Board for details.
- The status of the terminating resistance cannot be diagnosed for the following Controller Link Units/Boards. Visually confirm the settings for these Units/Boards.

Item	Units/Boards
Units for which the terminating resistance cannot be read	C200HW-CLK21 Controller Link Unit (for C200HX/HG/HE PLCs) CVM1-CLK21 Controller Link Unit (for CVM1/CV-series PLCs) 3G8F5-CLK21 ISA Bus Controller Link Support Board

### Diagnosing Node Settings

Select **Diagnose – Node Settings** from the Main Menu.

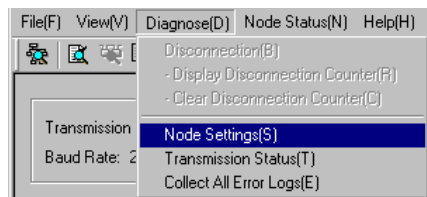

# 10-1 Controller Link Network Diagnostic Tool

## 10-1-3 Diagnosing Node Settings

### Node Settings Diagnosis Example

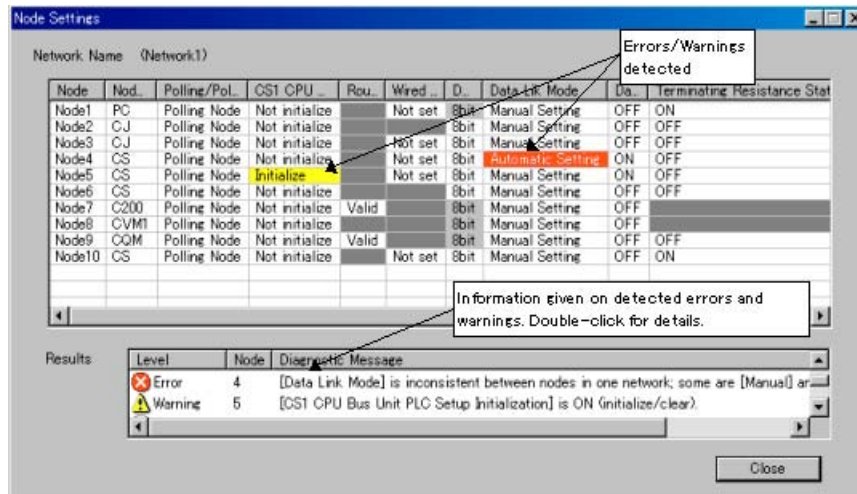

- The settings for each node are displayed in a table.
- The results of diagnosing the integrity of the overall network are displayed at the bottom. The results of diagnosis are displayed in three levels, as described in the following table.

Level	Meaning
Error	Indicates problems in the overall integrity of the network. Locations causing errors are displayed in red. Example: The data link mode is set to both user-set links and automatically set links in the nodes for which the data link startup switch is ON.
Warning	Indicates settings that may be appropriate for some applications but which have a high possibility of being errors (setting mistakes or unset items). Locations causing warnings are displayed in yellow. Example: There are no nodes with the data link startup switch set to ON.
Information	Indicates information on items that may be appropriate for some applications. Example: The Routing Table Enable Bit is ON for C-series PLCs.

- Details will be displayed if the displayed result is double-clicked.

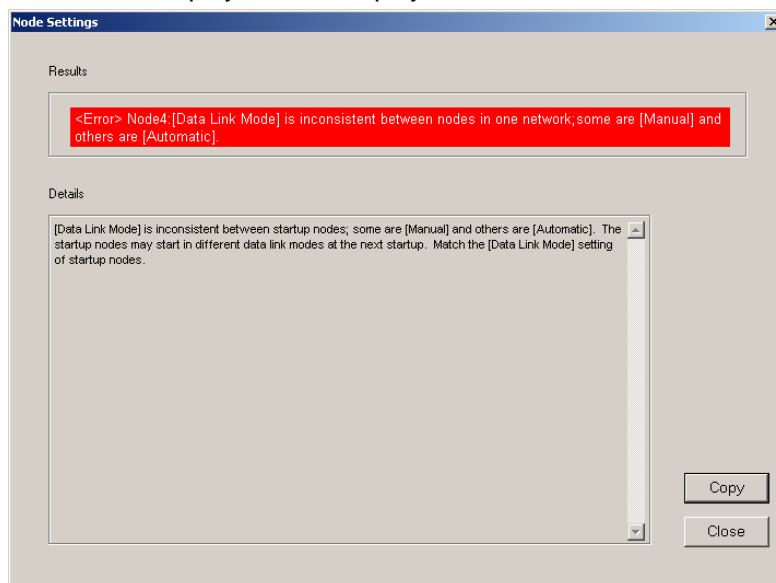

## 10-1 Controller Link Network Diagnostic Tool

### 10-1-3 Diagnosing Node Settings

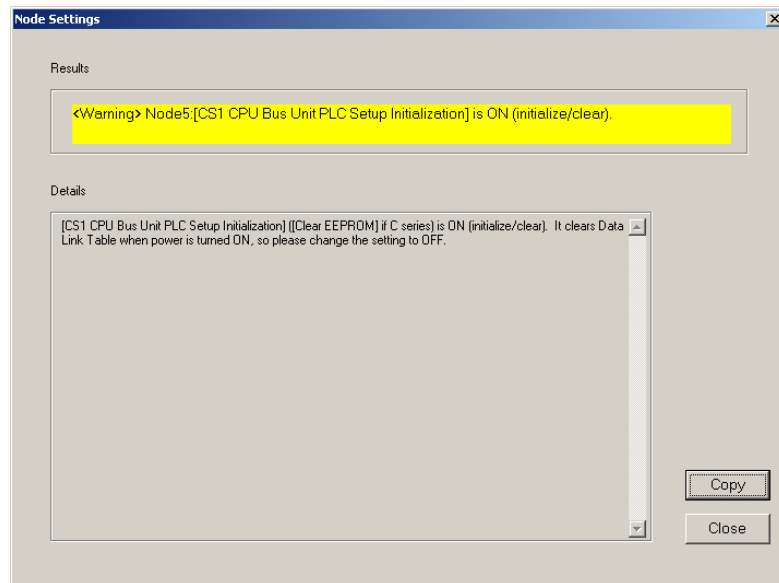

- Check the details for all error and warning items in the results of diagnosis. Use the Programming Devices, such as the CX-Programmer and Data Link Table Setting Tool, to correct the settings.
- Check all the information items to be sure that the settings are intentional. Use the Programming Devices, such as the CX-Programmer and Data Link Table Setting Tool, to correct any settings that are not suitable.
- Select **Diagnose – Node Settings** from the Main Menu to diagnose the node settings again.

**Note** The status of the terminating resistance cannot be diagnosed for all nodes in networks containing the following Controller Link Units/Boards. Visually confirm the settings for these Units/Boards.

Item	Units/Boards
Units for which the terminating resistance cannot be read	C200HW-CLK21 Controller Link Unit (for C200HX/HG/HE PLCs) CVM1-CLK21 Controller Link Unit (for CVM1/CV-series PLCs) 3G8F5-CLK21 ISA Bus Controller Link Support Board CS1W-RPT01/02/03 Repeater Unit

- The Controller Link Network Diagnostic Tool cannot determine the order that nodes are connected in Wired Networks. To enable diagnosis to see if the terminating resistance is ON only at the ends the network, edit the node file so the nodes appear in the actual order in which they are physically connected.

**Note** • Any items not supported for a particular model will be grayed out on the display.  
• If an item cannot be read from a node, the entire line for that node will be grayed out on the display.

## 10-1 Controller Link Network Diagnostic Tool

### 10-1-4 Diagnosing Disconnections

#### 10-1-4 Diagnosing Disconnections

##### Disconnection Diagnosis

All nodes participating in the specified network are displayed in the order they are physically connected. If the cable has been disconnected, the locations of disconnections are displayed.

Disconnection diagnosis can be used only for Optical-ring Units/Boards in token ring mode.

Diagnosis item	Description
Order that nodes are connected	Displays nodes in the order that nodes are connected. Connections between node to communications ports SL and SL2 are displayed.
Network disconnection status	The network is diagnosed to detect any disconnections. If there are any disconnections, the locations of them are displayed.
Disconnection Counter	Disconnection counters that measure each Controller Link Unit are displayed.

##### **Note**

- Disconnection diagnosis will not be performed for a network that has not normally reached ring status after starting the network.
- Disconnection diagnosis will not be performed for an Optical-ring Network in token bus mode.
- Disconnections cannot be displayed for Wired Networks.

##### Diagnosing Disconnections

Select **Diagnose – Disconnection** from the Main Menu, or click the icon.

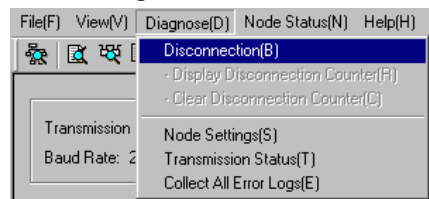



**Disconnection Results Example**

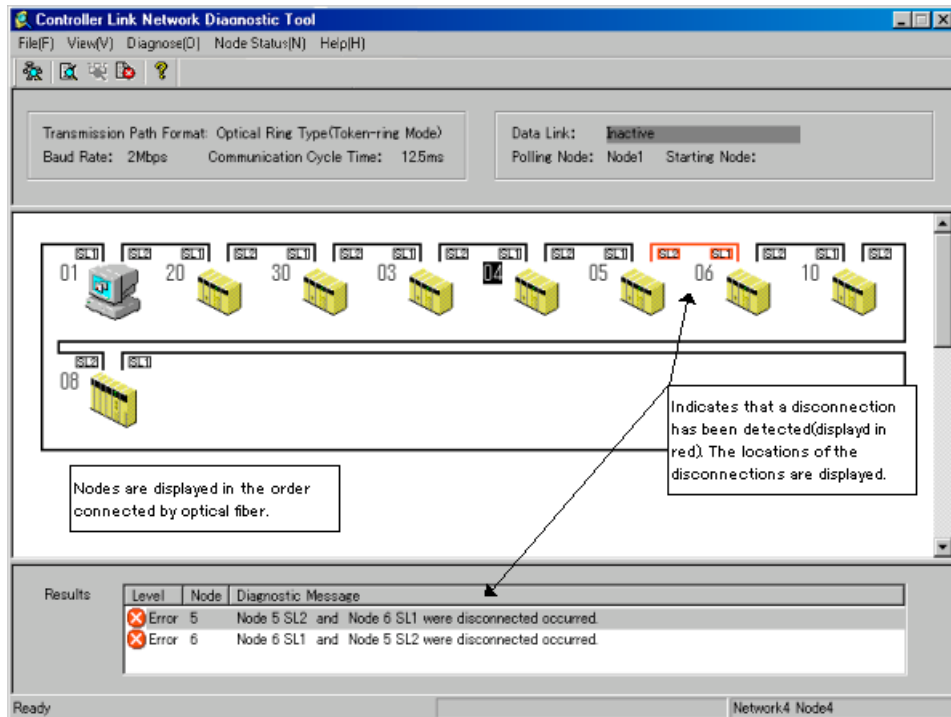

- Nodes are display in the order they are physically connected in the network.
- The results of disconnection diagnosis are display in the results area. Any disconnections that are detected are displayed in red.
- Select **Diagnose – Disconnection** to display the disconnection diagnosis results again.

**Note** The node display for disconnection diagnosis does not display errors that have occurred at the nodes (i.e., in Controller Link Units and CPU Units). If there are errors, the following message box will be displayed.

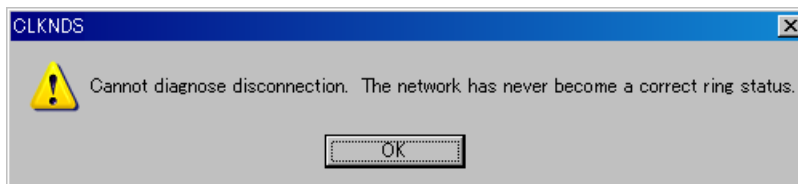

Use the network status diagnosis to diagnose errors at the nodes (i.e., in Controller Link Units and CPU Units).

## 10-1 Controller Link Network Diagnostic Tool

### 10-1-4 Diagnosing Disconnections

#### Disconnection Counters

Disconnection counters, which measure disconnections at each node, can be displayed by diagnosing disconnections.

#### Displaying Disconnection Counters

Select **Diagnose – Display disconnection counter** from the Main Menu.

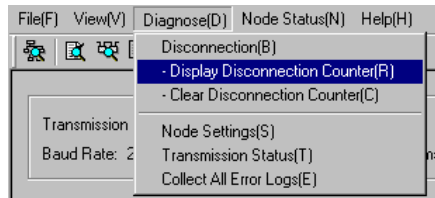

#### Disconnection Counter Display

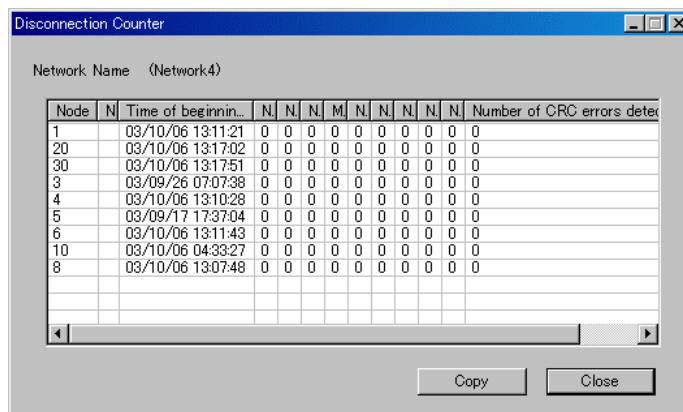

- The disconnection counters that measure disconnections at each node are displayed.
- The following counter items are displayed.

Item	Description
Time of beginning disconnection data recording	Displays the time that recording disconnection information was started. This will be the time the power supply was turned ON to the node, the time the Unit at the node was restarted, or the time the disconnection counters were cleared.
Number of node/network separations	Displays the number of times the local node was separated from the network.
Number of network disconnections	Displays the number of disconnections detected on the network.
Number of local node disconnections	Displays the number of disconnections detected for the local node.
Maximum number of consecutive disconnect cycles	Displays the number of communications cycles over which a disconnection continued. Use this information to determine if a disconnection was momentary or continuous.
Number of frame drop-outs (SL1, SL2)	Displays the number of times a data frame received at another communications port was not received at all at the local communications port. Dropouts are counted when the communications line is completely disconnected.
Number of frame brakes detected (SL1, SL2)	Displays the number of times only a carrier was detected at the local communications port for a data frame received at another communications port. Brakes are counted when the optical cable is damaged, when end surface processing is faulty, for contact faults, or whenever else transmissions are unstable.
Number of CRC errors detected (SL1, SL2)	Displays the number of CRC errors and Manchester errors. These errors are counted when the optical cable is damaged, when end surface processing is faulty, for contact faults, or whenever else transmissions are unstable.

- Click the **Copy** Button to copy the data for the disconnection counters to the clipboard. The data on the clipboard will be in CSV (text) format.
- The data on the clipboard can be pasted to an editor, word processor, or

## 10-1 Controller Link Network Diagnostic Tool

### 10-1-5 Diagnosing Transmission Status

spreadsheet software.

- To clear the counters, select **Diagnose – Clear Disconnection Counter** from the Main Menu.
- The counter information inside the Controller Link Unit/Board at each node will be cleared and the *Time of beginning disconnection data recording* will be set to the time the counters were cleared.

**Note** The *Time of beginning disconnection data recording* is the time that recording disconnection information was started. This will be the time the power supply was turned ON to the node, the time the Unit at the node was restarted, or the time the disconnection counters were cleared.

## 10-1-5 Diagnosing Transmission Status

### Transmission Status Diagnosis

The transmission status counters for all nodes participating in the specified network can be displayed.

### Diagnosing Transmission Status

Select **Diagnose – Transmission Status** from the Main Menu.

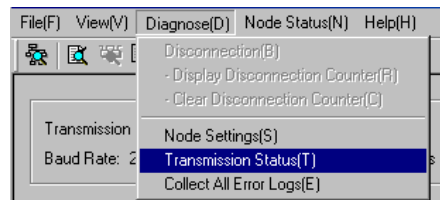

### Transmission Status Results Example

Transmission Status								
Network Name (Network1)								
Node	Node Name	Num.	Num.	Num.	Num.	Num.	Num.	Number of active node chages
1	PC	2	18	9	0	0	1	23
2	CJ	2	0	0	0	0	1	25
3	CJ	2	9	0	0	0	1	26
4	CS	0	0	0	0	0	0	4
5	CS	0	0	0	0	0	0	1
6	CS	0	0	0	0	0	0	1
7	C200	2	9	0	0	0	1	209
8	CVM1	0	0	0	0	0	0	108
9	CQM	2	9	0	0	0	1	30
10	CS	0	0	0	0	0	0	2

- The transmission status counters, which measure transmissions for each node, are displayed.
- The following counter items are displayed.

Item	Description
Number of CRC errors	Displays the number of CRC errors. CRC errors are counted for transmission errors, including those caused by cable faults, contact faults, incorrect terminating resistance settings, etc.
Number of token re-sends	Displays the number of times a failure occurred in passing the token to the next node. Token resends are counted for transmission errors, including those caused by cable faults, contact faults, incorrect terminating resistance settings, etc.
Number of token returns	Displays the number of times that the token was returned to the polling node because of continuous failures even when the token was resent. Token returns are counted for transmission errors, including those caused by cable faults, contact faults, incorrect terminating resistance settings, etc.
Number of token timeouts	Displays the number of times the token did not return to the local node even after a specified period of time.
Number of polling timeouts	Displays the number of times the local node was not polled even after a specified period of time.

## 10-1 Controller Link Network Diagnostic Tool

### 10-1-6 Node Status

Item	Description
Number of controller changes	Displays the number of times that the polling node was changed. Polling node changes are counted when the power supply is turned OFF to the polling node, but can also be counted when transmission path errors occur.
Number of active node changes	Displays the number of times the number of nodes participating in the network increased or decreased. Active node changes are also counted when the power supply is turned ON to a node and the node joins the network. They can also be counted when transmission path errors occur (even if the power supply is not turned OFF and ON).

- Click the **Copy** Button to copy the data for the transmission status counters to the clipboard. The data on the clipboard will be in CSV (text) format. The data on the clipboard can be pasted to an editor, word processor, or spreadsheet software.

#### Note

- The values of the transmission status counters are counted from the time the power is turned ON to a Controller Link Unit/Board or the Unit/Board is reset. The counters will not count past 255.
- The transmission status counters cannot be cleared directly.
- For the following Controller Link Units/Boards, the *number of active node changes* counter is invalid.
  - C200HW-CLK21
  - CVM1-CLK21
  - 3G8F5-CLK21
  - 3G8F6-CLK21
  - NS-CLK21

#### Note

The various transmission status counters cannot be used alone to determine transmission path errors. Use them as guidelines for checking the transmission status of the network.

## 10-1-6 Node Status

### Node Status Diagnosis

- Current errors and the error log can be displayed for a specified node (Controller Link Unit/Board or CPU Unit).
- The model of the specified node (Controller Link Unit/Board or CPU Unit) can also be displayed.

### Controller Link Unit

#### Displaying Error Status and Error Log

1. Select **Node Status – CLK Unit Error Log /Error Status** from the Main Menu.

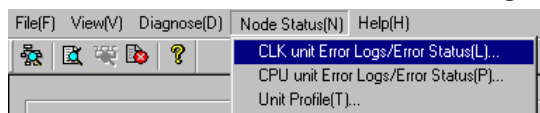

2. A list of the nodes currently participating in the network will be displayed. Select the node to read and click the **OK** Button.

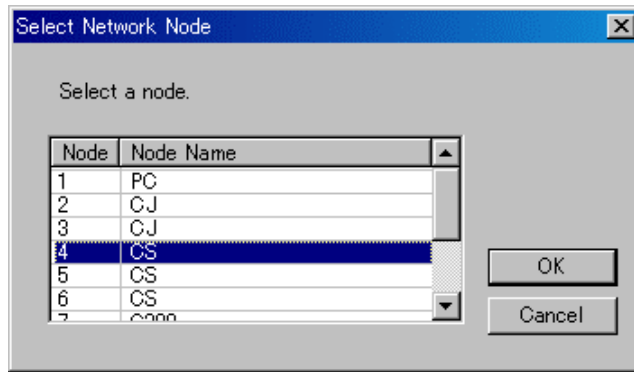

**Error Status/Error Log Display Example**

- Click the **Error** Tab to display the current errors.

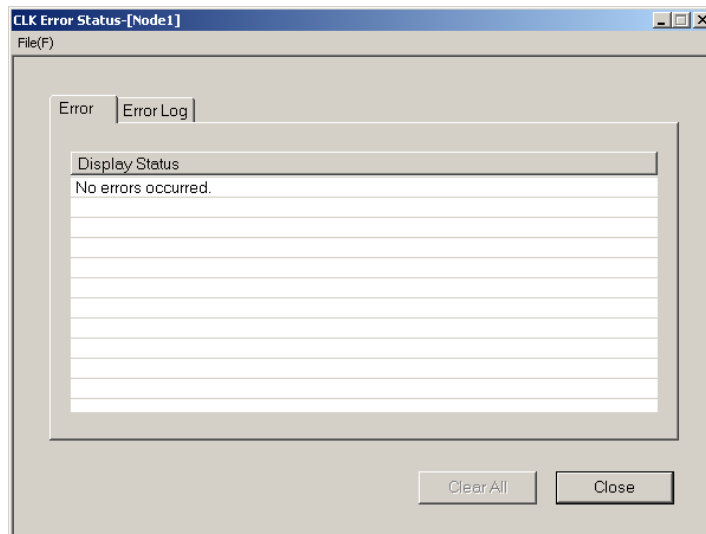

- Click the **Error Log** Tab to display a log of errors that occurred in the past.

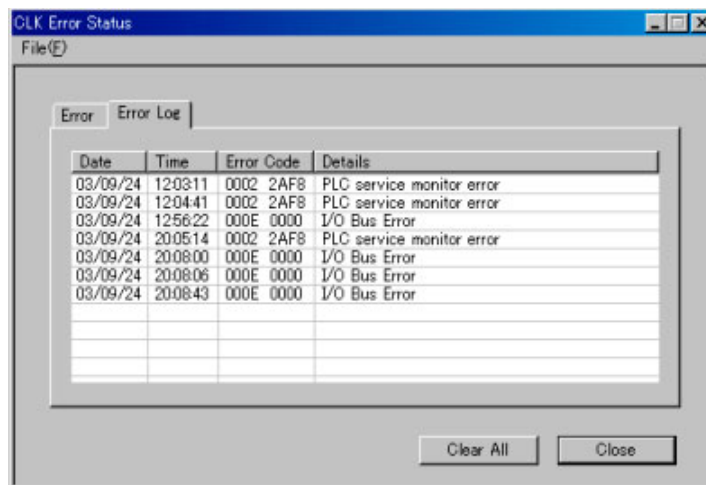

- Select **File – Save** to save the error status and error log in a file. The data will be saved in CSV (text) format.
- Click the **Clear All** Button to clear the error log from the Controller Link Unit/Board.

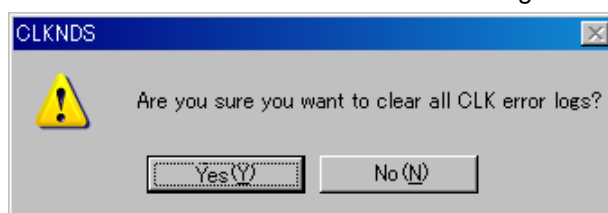

**CPU Unit**

**Displaying Error Status/Error Log**

Select **Node Status – CPU Unit Error Log/Error Status** from the Main Menu.

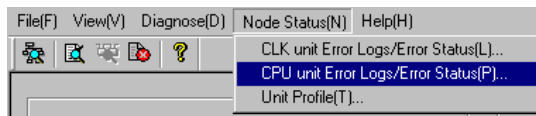

**Error Status/Error Log Display Example**

- Click the **Error** Tab to display the current errors.

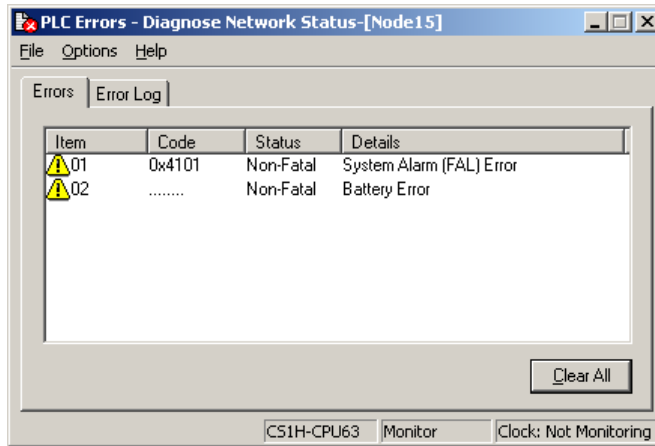

- Click the **Error Log** Tab to display a log of the errors that occurred in the past.

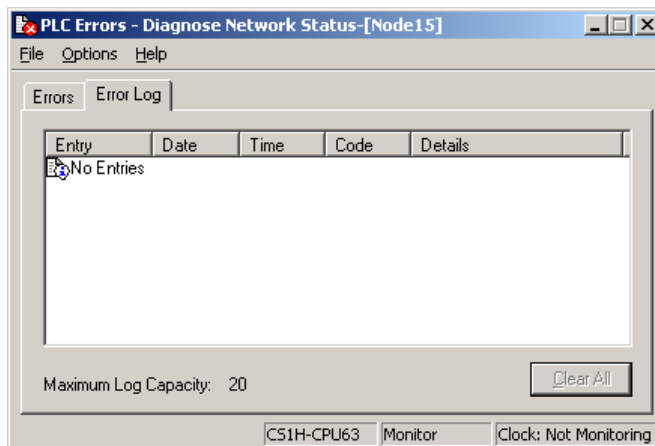

- Click the **Clear All** Button to clear the error log from the CPU Unit.

## Displaying Model Numbers

### Displaying Model Numbers

Select **Node Status – Unit Profile** from the Main Menu.

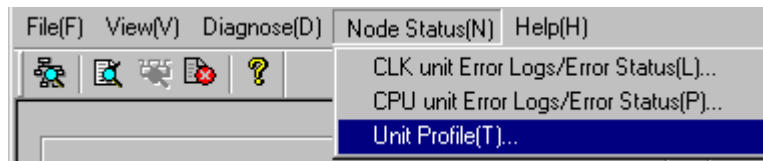

### Model Display Example

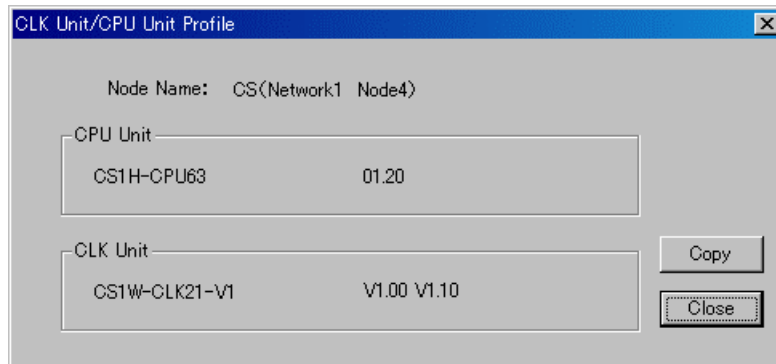

Click the **Copy** Button to copy the model number data to the clipboard. The data on the clipboard will be in CSV (text) format.

## 10-1-7 Collecting Error Logs

### Collecting Error Logs

- The error status and error logs for all nodes on the specified network can be collected and stored in one file.
- This function enables sending files collected on remote systems as email attachments for later analysis.

### Collect Error Logs

Select **Diagnose – Collect All Error Logs** from the Main Menu, or click the icon.

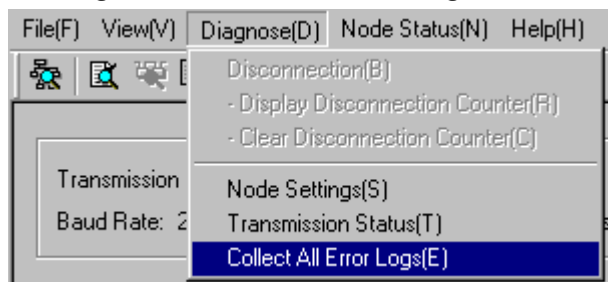

The following display will appear while data is being collected.

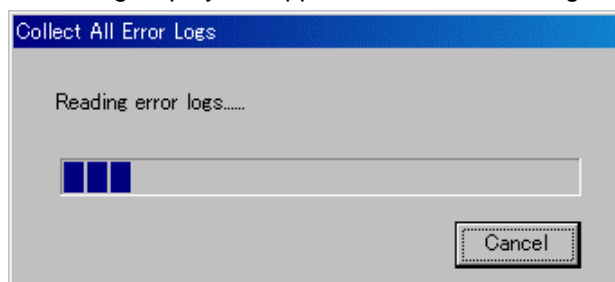

The data in the file will be in CSV (text) format. The data can be edited using an editor, word processor, or spreadsheet software.

## 10-2 Echoback Test between Nodes

### 10-2-1 Overview

## 10-2 Echoback Test between Nodes

### 10-2-1 Overview

The Internode Echoback Test between PLC Nodes tool is used to execute echoback tests between specified networks and nodes and the CX-Integrator. Echoback tests can be executed for Ethernet, Controller Link, SYSMAC LINK, or DeviceNet networks.

A specified data length (unit: bytes) is sent to a specified network and node. The data is sent back as is (echoback), and the results are compared. If the data agrees, it is judged a success. If not, it is judged a failure. This allows the communications load conditions between the computer and specified nodes to be tested.

### 10-2-2 Start Methods

Either of the following two methods can be used to start an echoback test:

Method 1: While online, open the Online Connection Information Window, right-click the target PLC or Unit, and select **Echoback test between PLC nodes** from the pop-up menu.

Method 2: While online, select **Tools - Echoback test between PLC nodes**.

### 10-2-3 PLC Internode Echoback Test Dialog Box

The various items in the PLC Internode Echoback Test Dialog Box are explained below.

Field	Item	Contents
Target	Network	Input the network address. Range: 1 to 127.
	Node	Input the node address. Range: 1 to 254.
Test Configuration	Data Length	Input the number of bytes of data to be sent between nodes. Range: 1 to 256.
	Times to Repeat	Input the number of times to repeat the test. Range: 1 to 255.
	Frequency is not specified	Check this item to repeat the tests limitlessly.
	Response wait time	Input the time to wait for the echo request packet. Range: 1 to 30.
Connection	Network	Displays the target network address.
	Node	Displays the target node address.
	Model	Displays the target model.
Status		Displays the online status.
Test Results	Elapsed time	Displays the time elapsed for the test.
	Tests run	Displays the number of times the test has been run.



## 10-2 Echoback Test between Nodes

### 10-2-4 Executing an Echoback Test between Nodes

Field	Item	Contents
Test Results	Success	Displays the number of test successes. If set for "Frequency is not specified," a "-" is displayed.
	Failure	Displays the number of test failures. The test is ended when 1,000 failures is reached.
Response time	Max (ms)	Displays the maximum response time.
	Min (ms)	Displays the minimum response time.
	Average (ms)	Displays the average response time. If set for "Frequency is not specified," the display shows the average for the last ten times.

### 10-2-4 Executing an Echoback Test between Nodes

1. While online, open the Online Connection Information Window, right-click the target PLC or Unit, and select **Echoback test between PLC nodes** from the pop-up menu.

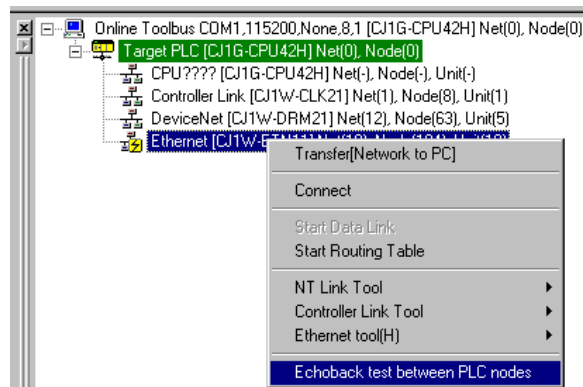

The PLC Internode Echoback Test Dialog Box will be displayed.

2. Input (or confirm) the target item, and click the **Connect** Button.

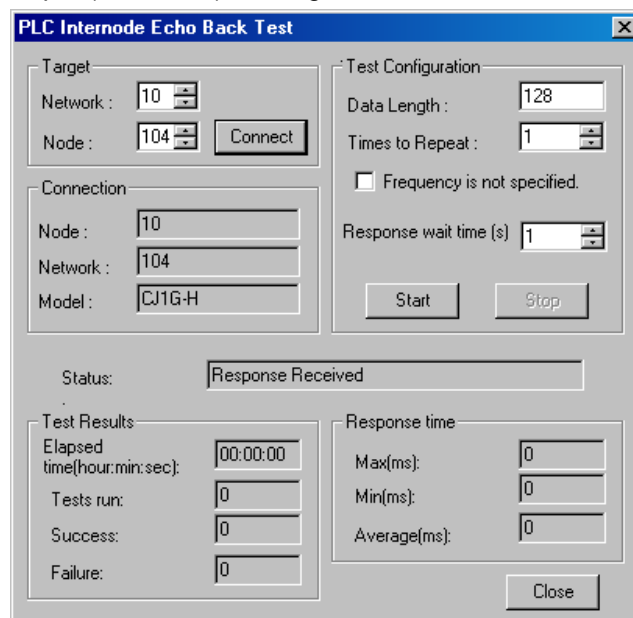

The connection results will be displayed.

## 10-2 Echoback Test between Nodes

### 10-2-4 Executing an Echoback Test between Nodes

3. Input (or confirm) the test configuration, and click the **Start** Button. The test results and response time will be displayed.

The screenshot shows a software dialog box titled "PLC Internode Echo Back Test". It is divided into several sections:

- Target:** Network: 10, Node: 104, with a "Connect" button.
- Connection:** Node: 10, Network: 104, Model: CJ1G-H.
- Test Configuration:** Data Length: 128, Times to Repeat: 100, an unchecked checkbox for "Frequency is not specified.", and Response wait time (s): 1. It includes "Start" and "Stop" buttons.
- Status:** A text field containing "Response Received".
- Test Results:** Elapsed time(hour.min.sec): 00:00:04, Tests run: 100, Success: 100, Failure: 0.
- Response time:** Max(ms): 130, Min(ms): 40, Average(ms): 48. It includes a "Close" button.

4. To stop testing, click the **Stop** Button.

## 10-3 Ethernet Ping Test

### 10-3-1 Overview

By executing a ping command in Ethernet, it is possible to determine whether a remote PLC is connected to the Ethernet network, and whether its setting as an Ethernet node (i.e., its IP address) is correct. Ethernet is the only network in which this test can be executed.

### 10-3-2 Start Methods

Either of the following two methods can be used to start an Ethernet ping test:

Method 1: While online, open the Online Connection Information Window, right-click the target Unit, and select **Ethernet tool – Ping test** from the pop-up menu.

Method 2: While online, select **Tools - Ethernet tool – Ping test**.

### 10-3-3 Ping Test Dialog Box

The various items in the Ping Test Dialog Box are explained below.

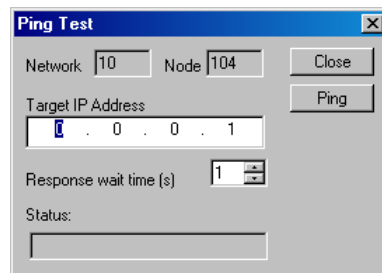

Input	Contents
Target IP address	Input the target IP address.
Response wait time	Input the time to wait for the echo request packet. Range: 1 to 30.

Item	Contents
Network	Displays the network address.
Node	Displays the node address.
Status	Displays the test result (success or failure).

**10-3 Ethernet Ping Test**  
**10-3-4 Executing a Ping Test**

**10-3-4 Executing a Ping Test**

1. While online, open the Online Connection Information Window, right-click the target Unit, and select **Ethernet tool – Ping test** from the pop-up menu. The Ping Test Dialog Box will be displayed.

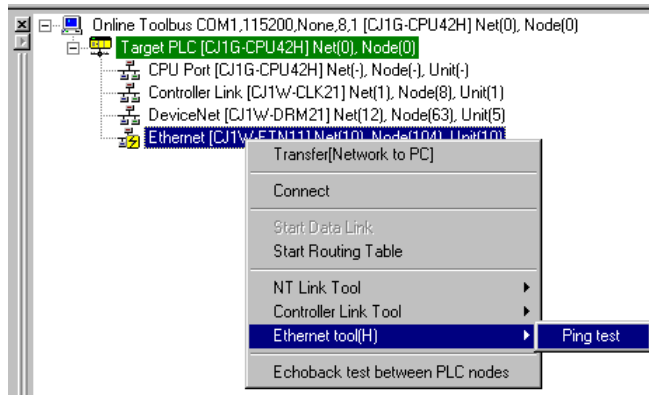

2. Input the target IP address, and click the **Ping** Button.

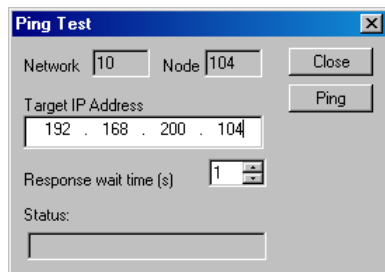

3. The result will be displayed in the *Status* field.

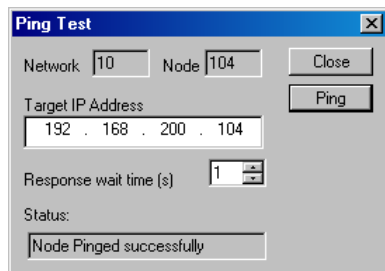

# Appendices

**A-1 CPS File Management**  
**A-1-1 Description of CPS Files**

# A-1 CPS File Management

This section explains the EDS file management functions of the CX-Integrator

## A-1-1 Description of CPS Files

### CPS File Overview

CPS is an abbreviation of *Component and network Profile Sheet*, which contain the definitions of CS/CJ-series Units and Components required in the CX-One applications. The definitions are provided in CPS file format (XML file format). CX-One applications use the information in these CPS files to recognize the CS/CJ-series Units. The CPS files are also used to create the Special I/O Unit and CPU Bus Unit settings.

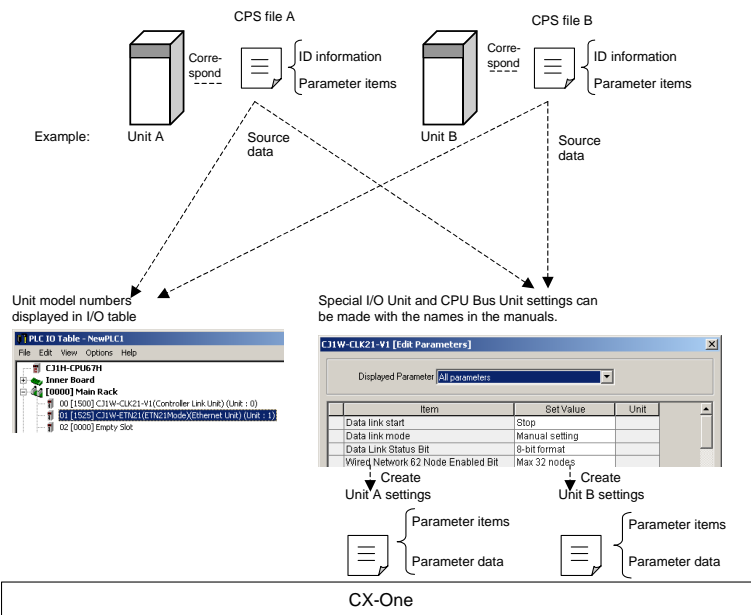

CPS files contain the following CS/CJ-series Unit and component information.

- ID information (Model number, product name, Unit type, Unit version, etc.)
- Parameter items (Offset address, parameter name, and setting range or selections)

The following diagram shows an example CPS file in XML format.

```
<?xml version="1.0" encoding="UTF-8" ?>
<!DOCTYPE Cps (View Source for full doctype...)
- <CPS Name="Z_000001" FormatRevision="1.0" Revision="1" Type="CPS1" DeType="Component" Comment=""
- <Component Name="Z_000002" ModelName="CJ1H-CPU67H" VenderName="OMRON Corporation" MajorVer="3"
MinorVer="0" CompoType="PLCUnit" EquipmentType="BuildingBlock" CategoryType="PLC" ProductName="CPU Unit"
Spec: IO Bits: 2560, User Program Memory: 250KSteps, Data Memory: 448Kwords
(0x:32Kwords,4M:32Kwords x 16banks)
- <Communication Name="Z_000003" DisplayName="CPU Port" RoutingType="Hub"
- <CommIF Name="Z_000004" PhysicalPortType="Peripheral" MachineNumberingType="PeripheralOfPLC"
- <AttachableNetworkName Name="Z_000005" NetworkName="CompoWayP"
- <NetworkSubType Name="Z_000006" Type="Client" />
- <AttachableNetworkName
- <AttachableNetworkName Name="Z_000007" NetworkName="NTLink"
- <NetworkSubType Name="Z_000008" Type="Client" />
- <AttachableNetworkName
- <CommIF
- <CommIF Name="Z_000009" PhysicalPortType="HostLink" MachineNumberingType="HostLinkOfPLC"
- <AttachableNetworkName Name="Z_000010" NetworkName="CompoWayP"
- <NetworkSubType Name="Z_000011" Type="Client" />
- <AttachableNetworkName
- <AttachableNetworkName Name="Z_000012" NetworkName="NTLink"
- <NetworkSubType Name="Z_000013" Type="Client" />
- <AttachableNetworkName
- <CommIF
- </Communications>
- <CompoNotificationInfo Name="Z_000014"
- <ReadControllerInfo Name="Z_000015" SourceData="FINS0501" DestinationData="CJ1H_CPU67H" />
- <UnitProfileInfo Name="Z_000016" SourceData="CPU" DestinationData="0x801C" />
- <ProfileInfo Name="Z_000017" SourceData="NotNotified" DestinationData="" />
- <CompoNotificationInfo
- <CXServerDeviceInfo Name="Z_000018" DeviceName="CJ1H-H" CPUType="CPU67" />
- <BuildingBlockInfo Name="Z_000019" RepresentCompo="Yes"
- <PLCUnitInfo Name="Z_000020" Series="CJ" UnitType="CPUUnit" BusType="CS1" EnableChangeOnline="No"
- <CurrentConsumption Name="Z_000021" InverterLogic="990" Relays="0" Services="0" />
- <Width Name="Z_000022" Length="62" />
- <CPUUnitInfo Name="Z_000023" MaxNumOfBaseUnits="3" MaxNumOfTotalIOBits="2560"
GatewayNumber="0" MaxSIOUUnitNumber="95" MaxCPUUnitNumber="15" MaxNumOfRM="0" />
- <PLCUnitInfo
- <BuildingBlockInfo
- <StatusInfo Name="Z_000024"
- <RunModes Name="Z_000025"
- <RunMode Name="R_Program" DisplayName="Program" />
- <RunMode Name="R_Monitor" DisplayName="Monitor" />
- <RunMode Name="R_Run" DisplayName="Run" />
- <StatusInfo
- <ResetCommandInfo Name="Z_000026"
- <ResetTarget Name="Z_000027" ResetType="No" />
- </ResetCommandInfo
```

## **Installing CPS Files**

1. Select **Tools – CPS File – Install** from the menu bar.

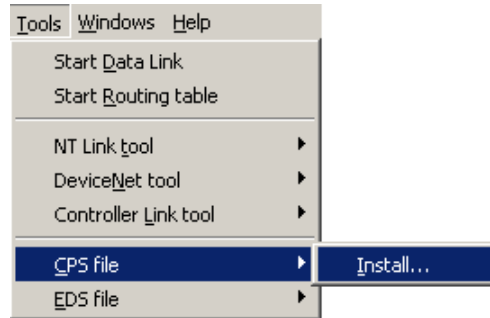

2. The Install CPS files Dialog Box will be displayed.  
Select the CPS file to install and click the **Open** Button.  
More than one file can be selected and installed at the same time.

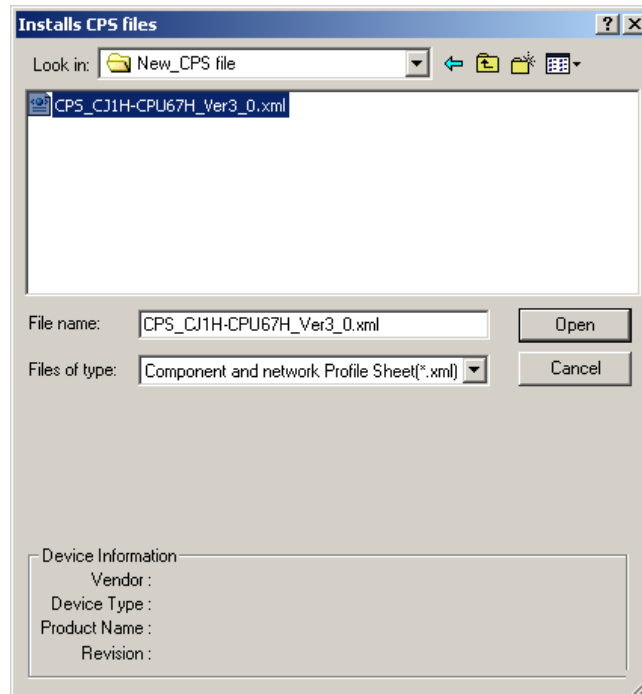

3. The following dialog box will be displayed if the corresponding icon for the specified Unit/component does not exist in the folder where the CPS file will be installed.

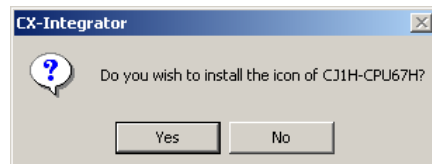

Click the **Yes** Button to install the icon.

The CPS file will be installed in the following directory:

Program Files\Common Files\Omron\Profiles\CPSFiles

4. The following dialog box will be displayed, completing the installation.

## A-1 CPS File Management

### A-1-1 Description of CPS Files

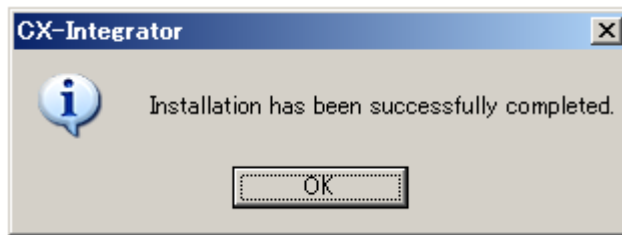

**Note** When using Windows Vista or Windows 7, restart CX-Integrator using the following procedure before installing CPS files (i.e., start CX-Integrator using *Run as Administrator*).

1. End all copies of the CX-Integrator that are currently running.
2. Go to **Programs – OMRON – CX-One** and then **right-click CX-Integrator** on the Windows Start Menu.
3. Select **Run as Administrator** from the pop-up menu. The CX-Integrator will start. Install the CPS file using the normal procedure after the CX-Integrator starts.

If CPS files are installed without running the CX-Integrator as administrator, the following restrictions will apply to functionality even though the CPS files will be installed normally. (These restrictions are imposed by the virtual store functionality of the OS.)

If another user logs in, the CPS files will need to be installed again.

The CPS files will not be automatically updated.



## A-2 EDS File Management

This section explains the EDS file management functions of the CX-Integrator.

### A-2-1 Installing EDS Files

#### Tools - EDS File - Install

The CX-Integrator will support new devices if proper EDS files are installed. To install the EDS file, use the following procedure.

1. Select **EDS File** and **Install**.  
The following window will be displayed.

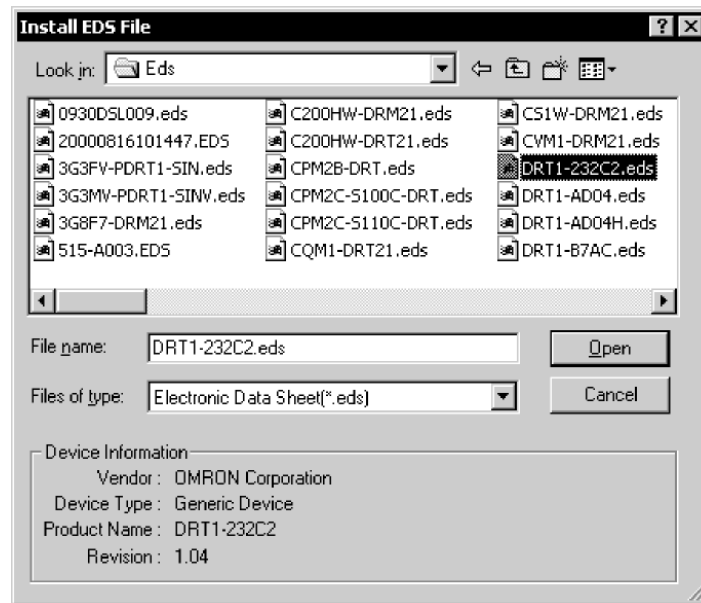

The device information will be displayed on the bottom of the window when the EDS file is selected.

2. Select the EDS file to be installed and click the **Open** Button.  
The EDS file will be added to the Hardware List.  
If the EDS file already exists, the new EDS file will overwrite the previous one.  
If the EDS files are different to each other in version, the new EDS file will be added to the Hardware List as shown below.

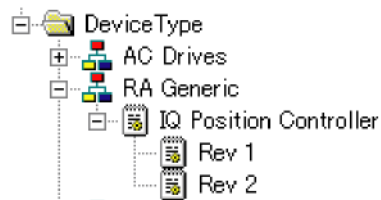

**Note:** When using Windows Vista or Windows 7, refer to *Appendix 3*. It provides precautions when installing Expansion Modules.

## A-2 EDS File Management

### A-2-2 Creating EDS Files

#### A-2-2 Creating EDS Files

##### Tools - EDS File - Create

The EDS files are required by the CX-Integrator to create a network configuration. To create an EDS file, use the following procedure.

1. Select **EDS File** and **Create**.

The following window will be displayed.

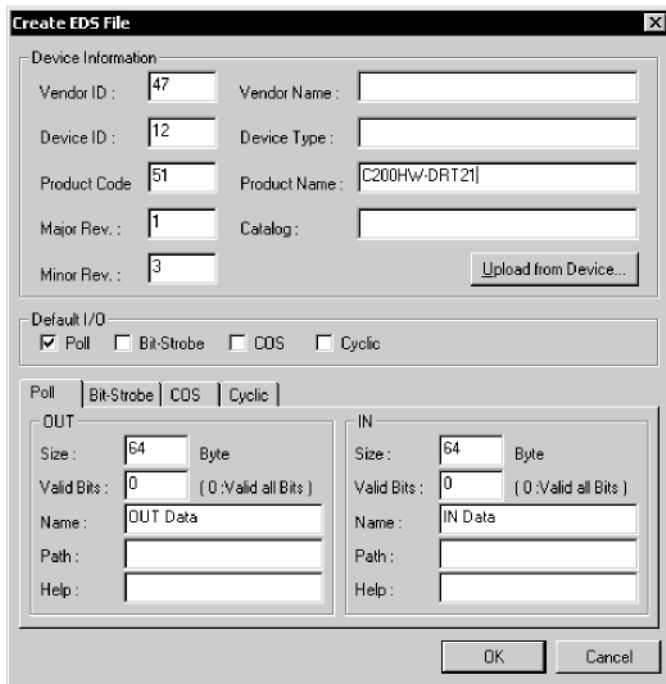

2. Set the device information and I/O information.  
The device information can be obtained from the device on the network if the network is online.
3. To read the information, click the **Upload from Device** Button. The following window will be displayed.

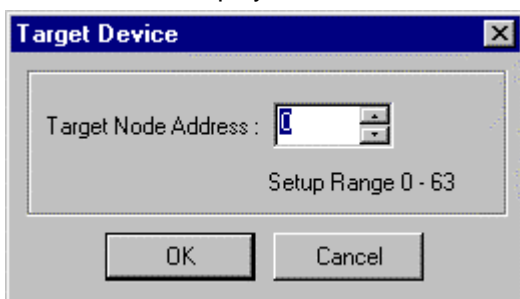

4. Set the node address of the device and click the **OK** Button.  
For the I/O connections and I/O size of the device, refer to the operation manual of the device.
5. Click the **OK** Button.  
The device will be added to the Hardware List.

**Note** Device parameters cannot be set with the EDS file creation function of the CX-Integrator. Obtain a proper EDS file from the manufacturer of the device to make device parameter settings for the device.

## A-2-3 Deleting EDS Files

### Tools - EDS File - Delete

To delete the EDS file, use the following procedure.

1. Select the device from the Hardware List.
2. Select **EDS File** and **Delete**.  
The following confirmation window will be displayed.



3. Click the **Yes** Button.  
The device will be deleted from the Hardware List together with the EDS file.

## A-2-4 Saving EDS Files

### Tools - EDS File - Save

To save the EDS file, use the following procedure.

1. Select the device from the Hardware List.
2. Select **EDS file** and **Save**.  
The following window will be displayed to specify the name of the folder where the EDS file will be saved and the name of the EDS file.

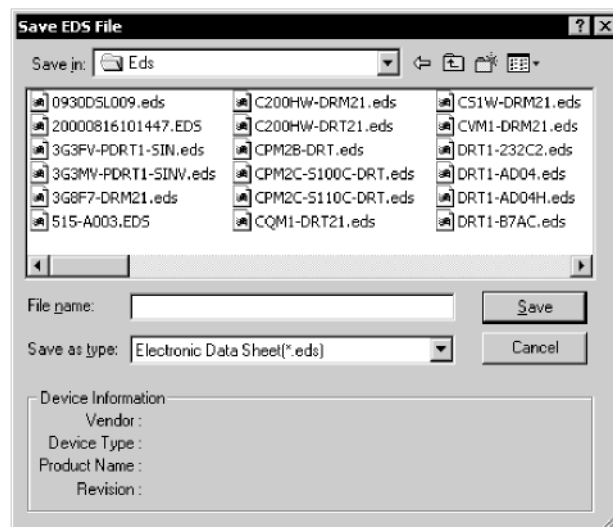

3. Input the folder and file names and click the **Save** Button The EDS file will be saved.

## A-2 EDS File Management

### A-2-5 Searching EDS Files

#### A-2-5 Searching EDS Files

##### Tools - EDS File - Search

To search the device (EDS file) displayed in the Hardware List, use the following procedure.

1. Select the EDS File and Search.  
The following window will be displayed.



2. Input the character string and click the **Find Next** Button.  
The cursor will move to the position of the corresponding device closest to the present cursor.

3. To quit the search operation, click the **Cancel** Button.

##### **Note**

- The device will be found if it is located below the present cursor position.
- Select *Hardware* in the Hardware List before using the above procedure to search all the devices.

#### A-2-6 Displaying EDS File Properties

##### Tools - EDS File - Property

To display the properties of the EDS file, use the following procedure.

1. Select the hardware (device) from the Hardware List.
2. Select **EDS File** and **Property**.  
The following window will be displayed.



The time and date of the creation of the EDS file will be displayed along with device information on the file.

## A-3 Precautions When Using Windows Vista or Windows 7

To perform any of the following operations with the CX-Integrator, start the CX-Integrator by using **Run as administrator**.

1. Installing EDS files  
Tools – EDS File – Install
2. Installing DeviceNet Expansion Modules  
Tools – DeviceNet tool – Install Plugin Module
3. Updating DTM catalogs  
Tools – Update DTM Catalog

If the above operations are performed after starting the CX-Integrator with the normal method, the results of the above operations will not be applied for other user accounts due to the effects of user management by Windows security.

Use the following procedure to start the CX-Integrator using Run as Administrator.

1. Right-click **CX-Integrator** on the Windows Start Menu.
2. Select Run as Administrator from the pop-up menu.

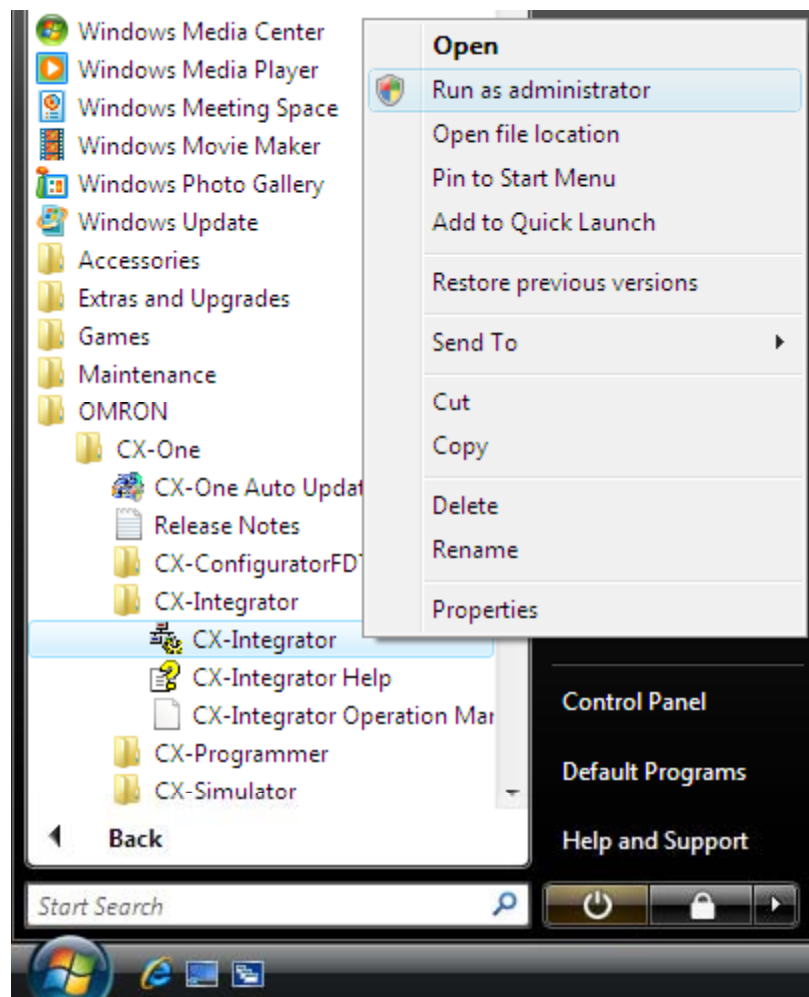

***A-3 Precautions When Using Windows Vista or Windows 7***

# Revision History

---

A manual revision code appears as a suffix to the catalog number on the cover of the manual.

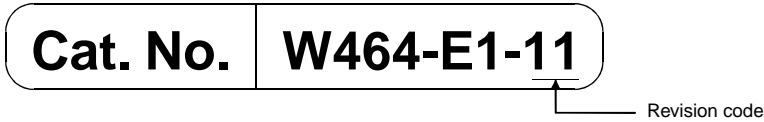

The following table outlines the changes made to the manual during each revision. Page numbers refer to the previous version.

Revision code	Date	Revised content
01	July 2006	Original production.
02	July 2007	Revisions and changes associated with upgrade to CX-Integrator version 2.1.
03	February 2008	Revisions and changes associated with upgrade to CX-Integrator version 2.2.
04	June 2008	Revisions and changes associated with upgrade to CX-Integrator version 2.3.
05	February 2009	Revisions and changes associated with upgrade to CX-Integrator version 2.33
06	December 2009	Revisions and changes associated with upgrade to CX-Integrator version 2.4
07	February 2010	Revisions associated with support for CJ2M CPU Units.
08	October 2010	Revisions associated with correction of wrong descriptions.
09	July 2011	Revisions and changes associated with support for the NJ Series.
10	January 2012	Revisions and changes associated with support for the NJ-series NJ301 CPU Units.
11	April 2012	Revisions and changes associated with support for CP1L-E CPU Units.







**OMRON Corporation Industrial Automation Company**  
Tokyo, JAPAN

Contact: [www.ia.omron.com](http://www.ia.omron.com)

**Regional Headquarters**

**OMRON EUROPE B.V.**

Wegalaan 67-69-2132 JD Hoofddorp  
The Netherlands

Tel: (31)2356-81-300/Fax: (31)2356-81-388

**OMRON ASIA PACIFIC PTE. LTD.**

No. 438A Alexandra Road # 05-05/08 (Lobby 2),  
Alexandra Technopark,  
Singapore 119967

Tel: (65) 6835-3011/Fax: (65) 6835-2711

**OMRON ELECTRONICS LLC**

One Commerce Drive Schaumburg,  
IL 60173-5302 U.S.A.

Tel: (1) 847-843-7900/Fax: (1) 847-843-7787

**OMRON (CHINA) CO., LTD.**

Room 2211, Bank of China Tower,  
200 Yin Cheng Zhong Road,  
PuDong New Area, Shanghai, 200120, China

Tel: (86) 21-5037-2222/Fax: (86) 21-5037-2200

**Authorized Distributor:**

© OMRON Corporation 2006 All Rights Reserved.  
In the interest of product improvement,  
specifications are subject to change without notice.

**Cat. No. W464-E1-11**

Printed in Japan  
0412