

Machine Automation Controller

NX-series

Analog I/O Units

User's Manual

NX-AD□□□□

NX-DA□□□□

NX-TS□□□□

Analog I/O Units

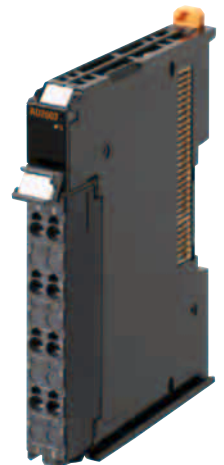

W522-E1-03

© OMRON, 2013

All rights reserved. No part of this publication may be reproduced, stored in a retrieval system, or transmitted, in any form, or by any means, mechanical, electronic, photocopying, recording, or otherwise, without the prior written permission of OMRON.

No patent liability is assumed with respect to the use of the information contained herein. Moreover, because OMRON is constantly striving to improve its high-quality products, the information contained in this manual is subject to change without notice. Every precaution has been taken in the preparation of this manual. Nevertheless, OMRON assumes no responsibility for errors or omissions. Neither is any liability assumed for damages resulting from the use of the information contained in this publication.

Trademarks

- Sysmac and SYSMAC are trademarks or registered trademarks of OMRON Corporation in Japan and other countries for OMRON factory automation products.
- Windows, Windows 98, Windows XP, Windows Vista, and Windows 7 are registered trademarks of Microsoft Corporation in the USA and other countries.
- EtherCAT® is registered trademark and patented technology, licensed by Beckhoff Automation GmbH, Germany.
- Safety over EtherCAT® is registered trademark and patented technology, licensed by Beckhoff Automation GmbH, Germany.
- ODVA, CIP, CompoNet, DeviceNet, and EtherNet/IP are trademarks of ODVA.
- The SD and SDHC logos are trademarks of SD-3C, LLC. 

Other company names and product names in this document are the trademarks or registered trademarks of their respective companies.

Introduction

Thank you for purchasing a NX-series Analog I/O Unit.

This manual contains information that is necessary to use the NX-series Analog I/O Unit. Please read this manual and make sure you understand the functionality and performance of the NX-series Analog I/O Unit before you attempt to use it in a control system.

Keep this manual in a safe place where it will be available for reference during operation.

Intended Audience

This manual is intended for the following personnel, who must also have knowledge of electrical systems (an electrical engineer or the equivalent).

- Personnel in charge of introducing FA systems.
- Personnel in charge of designing FA systems.
- Personnel in charge of installing and maintaining FA systems.
- Personnel in charge of managing FA systems and facilities.

For programming, this manual is intended for personnel who understand the programming language specifications in international standard IEC 61131-3 or Japanese standard JIS B3503.

Applicable Products

This manual covers the following product.

- NX-series Analog I/O Unit
NX-AD□□□□ / DA□□□□ / TS□□□□

CONTENTS

Introduction	1
Intended Audience.....	1
Applicable Products.....	1
Relevant Manuals	8
Manual Structure	10
Page Structure and Icons	10
Special Information	11
Precaution on Terminology	11
Terms and Conditions Agreement	12
Read and understand this Manual.....	12
Warranty, Limitations of Liability	12
Application Considerations	13
Disclaimers	13
Safety Precautions	14
Definition of Precautionary Information.....	14
Symbols.....	14
Warnings.....	15
Cautions.....	16
Precautions for Safe Use	18
Precautions for Correct Use.....	22
Regulations and Standards	23
Conformance to EC Directives	23
Conformance Requirement to EC Directives.....	24
Conformance to UL and CSA Standards	24
Conformance to Shipbuilding Standards	24
Conformance to KC Standards	25
Software Licenses and Copyrights	25
Unit Versions	26
Unit Versions.....	26
Unit Versions and Sysmac Studio Versions.....	28
Unit Version Notation	28
Related Manuals	29
Terminology	32
Revision History	34
Sections in this Manual	35

Section 1 Features and System Configuration

1-1 Features and Types of Analog I/O Units.....	1-2
1-1-1 Analog I/O Unit Features.....	1-2
1-1-2 Analog I/O Unit Types	1-2
1-2 System Configuration of Slave Terminals.....	1-3
1-2-1 Overview	1-3

1-2-2	System Configuration	1-3
1-3	Model List.....	1-5
1-3-1	Model Notation.....	1-5
1-3-2	Analog Input Units	1-7
1-3-3	Analog Output Units.....	1-9
1-3-4	Temperature Input Units	1-10
1-4	List of Functions.....	1-11
1-4-1	Analog Input Units	1-11
1-4-2	Analog Output Units.....	1-12
1-4-3	Temperature Input Units	1-13
1-5	Support Software.....	1-14
1-5-1	Applicable Support Software	1-14

Section 2 Specifications

2-1	General Specifications.....	2-2
2-2	Individual Specifications	2-3

Section 3 Part Names and Functions

3-1	Part Names.....	3-2
3-1-1	Screwless Clamping Terminal Block Type	3-2
3-2	Indicators	3-9
3-2-1	TS Indicator	3-10

Section 4 Installation and Wiring

4-1	Installing NX Units.....	4-2
4-1-1	Installing NX Units	4-2
4-1-2	Attaching Markers.....	4-4
4-1-3	Removing NX Units	4-5
4-1-4	Installation Orientation	4-7
4-2	Wiring the Power Supply to the Slave Terminal	4-8
4-2-1	Power Supply Types.....	4-8
4-2-2	Supplying Each Power Supply and Wiring	4-9
4-2-3	Calculating the Total Current Consumption from I/O Power Supply	4-11
4-2-4	Power Supply-related Units for the NX-series	4-12
4-3	Wiring the Terminals	4-15
4-3-1	Wiring to the Screwless Clamping Terminal Block.....	4-15
4-3-2	Checking the Wiring.....	4-33
4-4	Wiring Examples.....	4-34
4-4-1	Wiring the Analog Input Units	4-34
4-4-2	Wiring the Analog Output Units	4-36
4-4-3	Wiring the Temperature Input Units	4-37
4-4-4	Precautions when Using Common Power Supply for Input Devices of Analog Input Units.....	4-38

Section 5 I/O Refreshing

5-1	I/O Refreshing for Slave Terminals	5-2
5-1-1	I/O Refreshing from CPU Unit to Slave Terminal.....	5-2
5-2	I/O Refreshing Methods	5-3
5-2-1	Types of I/O Refreshing Methods	5-3
5-2-2	Setting the I/O Refreshing Methods.....	5-3

5-2-3	Selecting NX Units	5-4
5-2-4	Free-Run Refreshing.....	5-4
5-2-5	Synchronous Input Refreshing.....	5-9
5-2-6	Synchronous Output Refreshing.....	5-13

Section 6 Analog Input Units

6-1	Types of Analog Input Units	6-2
6-2	Input Range and Converted Values	6-4
6-3	Specifications of I/O Data	6-6
6-3-1	Allocable I/O Data	6-6
6-4	List of Settings.....	6-8
6-5	Function	6-12
6-5-1	List of Analog Input Unit Functions	6-12
6-5-2	Selecting Channel To Use.....	6-13
6-5-3	Moving Average	6-19
6-5-4	Input Disconnection Detection	6-27
6-5-5	Over Range/Under Range Detection	6-28
6-5-6	User Calibration	6-29

Section 7 Analog Output Units

7-1	Types of Analog Output Units	7-2
7-2	Output Range and Output Set Values.....	7-3
7-3	Specifications of I/O Data	7-5
7-3-1	Allocable I/O Data	7-5
7-4	List of Settings.....	7-6
7-5	Functions	7-9
7-5-1	List of Analog Output Unit Functions.....	7-9
7-5-2	Selecting Channel To Use.....	7-10
7-5-3	Load Rejection Output Setting	7-15
7-5-4	Over Range/Under Range Detection	7-21
7-5-5	User Calibration	7-22

Section 8 Temperature Input Units

8-1	Types of Temperature Input Units.....	8-2
8-2	Input Types and Input Ranges.....	8-3
8-2-1	Corresponding Input Types and Input Ranges.....	8-3
8-2-2	Setting Methods	8-5
8-3	Specifications of I/O Data	8-9
8-3-1	Allocable I/O Data	8-9
8-4	List of Settings.....	8-14
8-5	Functions	8-20
8-5-1	List of Temperature Input Unit Functions	8-20
8-5-2	Function Block Diagram	8-21
8-5-3	Selecting Channel To Use.....	8-22
8-5-4	Moving Average	8-27
8-5-5	Sensor Disconnection Detection	8-32
8-5-6	Over Range/Under Range Detection	8-33
8-5-7	Cold Junction Compensation Enable/Disable Setting.....	8-34
8-5-8	Temperature Unit (°C/°F) Setting	8-39
8-5-9	Input Correction.....	8-44

8-5-10	Decimal Point Position Setting.....	8-51
8-6	Measured Values Used When an Error Occurs	8-57

Section 9 Troubleshooting

9-1	How to Check for Errors	9-2
9-2	Checking for Errors with the Indicators	9-3
9-3	Checking for Errors and Troubleshooting on the Sysmac Studio.....	9-6
9-3-1	Checking for Errors from the Sysmac Studio.....	9-6
9-3-2	Event Codes and Corrections for Errors.....	9-9
9-3-3	Meaning of Error.....	9-16
9-3-4	Error Descriptions of Analog Input Units and Analog Output Units	9-17
9-3-5	Error Descriptions of Temperature Input Units.....	9-37
9-4	Resetting Errors	9-47
9-5	Troubles Specific To Each Type of NX Units.....	9-48
9-5-1	Analog I/O Units (Common).....	9-48
9-5-2	Analog Input Units	9-48
9-5-3	Analog Output Units.....	9-49
9-5-4	Temperature Input Units	9-49
9-6	Troubleshooting Flowchart	9-50

Section 10 Inspection and Maintenance

10-1	Cleaning and Inspection	10-2
10-1-1	Cleaning.....	10-2
10-1-2	Periodic Inspection	10-2
10-2	Maintenance Procedures	10-5
10-2-1	Backing Up Data.....	10-5
10-2-2	Replacement Procedure for NX Units.....	10-6

Appendices

A-1	Data Sheet	A-2
A-1-1	Model List	A-2
A-1-2	Analog Input Units	A-5
A-1-3	Analog Output Units.....	A-24
A-1-4	Temperature Input Units	A-37
A-2	Dimensions	A-56
A-2-1	Screwless Clamping Terminal Block Type	A-56
A-3	List of NX Objects.....	A-58
A-3-1	Format of Object Descriptions	A-58
A-3-2	Analog Input Units	A-59
A-3-3	Analog Output Units.....	A-68
A-3-4	Temperature Input Units	A-73
A-4	List of Terminal Block Models.....	A-94
A-4-1	Model Notation.....	A-94
A-4-2	List of Terminal Block Models	A-94
A-5	Version Information.....	A-95
A-5-1	Relationship between the Unit Versions of Each Unit and the EtherCAT Coupler Units, CPU Units, and Sysmac Studio Versions	A-95
A-5-2	Functions That Were Added or Changed for Each Unit Version	A-97

Index

Relevant Manuals

To use the Analog I/O Unit, you must refer to the manuals for all related products.

Read all of the manuals that are relevant to your system configuration and application before you use the NX-series Analog I/O Unit.

Most operations are performed from the Sysmac Studio Automation Software. Refer to the *Sysmac Studio Version 1 Operation Manual* (Cat. No. W504) for information on the Sysmac Studio.

	NJ Series						NX Series					All Units
							Communications Coupler Unit	NX Units				
	NJ-series CPU Unit Hardware User's Manual	NJ-series CPU Unit Software User's Manual	NJ-series CPU Unit Motion Control User's Manual	NJ-series CPU Unit Built-in EtherCAT Port User's Manual	NJ-series Troubleshooting Manual	NX-series EtherCAT Coupler Unit User's Manual	NX-series Digital I/O Units User's Manual	NX-series Analog I/O Units User's Manual	NX-series System Units User's Manual	NX-series Position Interface Units User's Manual	NX-series Safety Control Unit User's Manual	
Learning about the NX-series Units												
Specifications						●	●	●	●	●	●	
Functionality						●	●	●	●	●	●	
Application procedures						●	●	●	●	●	●	
Learning about Slave Terminals						●						
Slave Terminal specifications						●						
System configuration						●						
Rules on building systems						●						
Slave Terminal application procedures						●						
Slave Terminal installation procedures						●						
Support Software connection procedures						●						
Procedure to estimate Slave Terminal performance						●						
Procedures for using safety control systems with Slave Terminals											●	
Procedures for estimating performance of safety control systems with Slave Terminals											●	

	NX Series											
	NJ Series					Commu- nications Coupler Unit	NX Units					All Units
	NJ-series CPU Unit Hardware User's Manual	NJ-series CPU Unit Software User's Manual	NJ-series CPU Unit Motion Control User's Manual	NJ-series CPU Unit Built-in EtherCAT Port User's Manual	NJ-series Troubleshooting Manual	NX-series EtherCAT Coupler Unit User's Manual	NX-series Digital I/O Units User's Manual	NX-series Analog I/O Units User's Manual	NX-series System Units User's Manual	NX-series Position Interface Units User's Manual	NX-series Safety Control Unit User's Manual	NX-series Data Reference Manual
Using NX-series Units with NJ-series Controllers												
Using a Slave Terminal connected to the built-in EtherCAT port on an NJ-series CPU Unit	●	●		●		●						
Procedures for performing motion control with Position Interface Units			●						●			
Troubleshooting												
Managing errors for the overall NJ-series Controller					●							
Troubleshooting Slave Terminals and Communications Coupler Units						●						
Troubleshooting NX Units							●	●	●	●	●	
Performing Unit maintenance						●	●	●	●	●	●	
Referencing data lists for NX Unit power consumptions, weights, etc.												●

Manual Structure

Page Structure and Icons

The following page structure and icons are used in this manual.

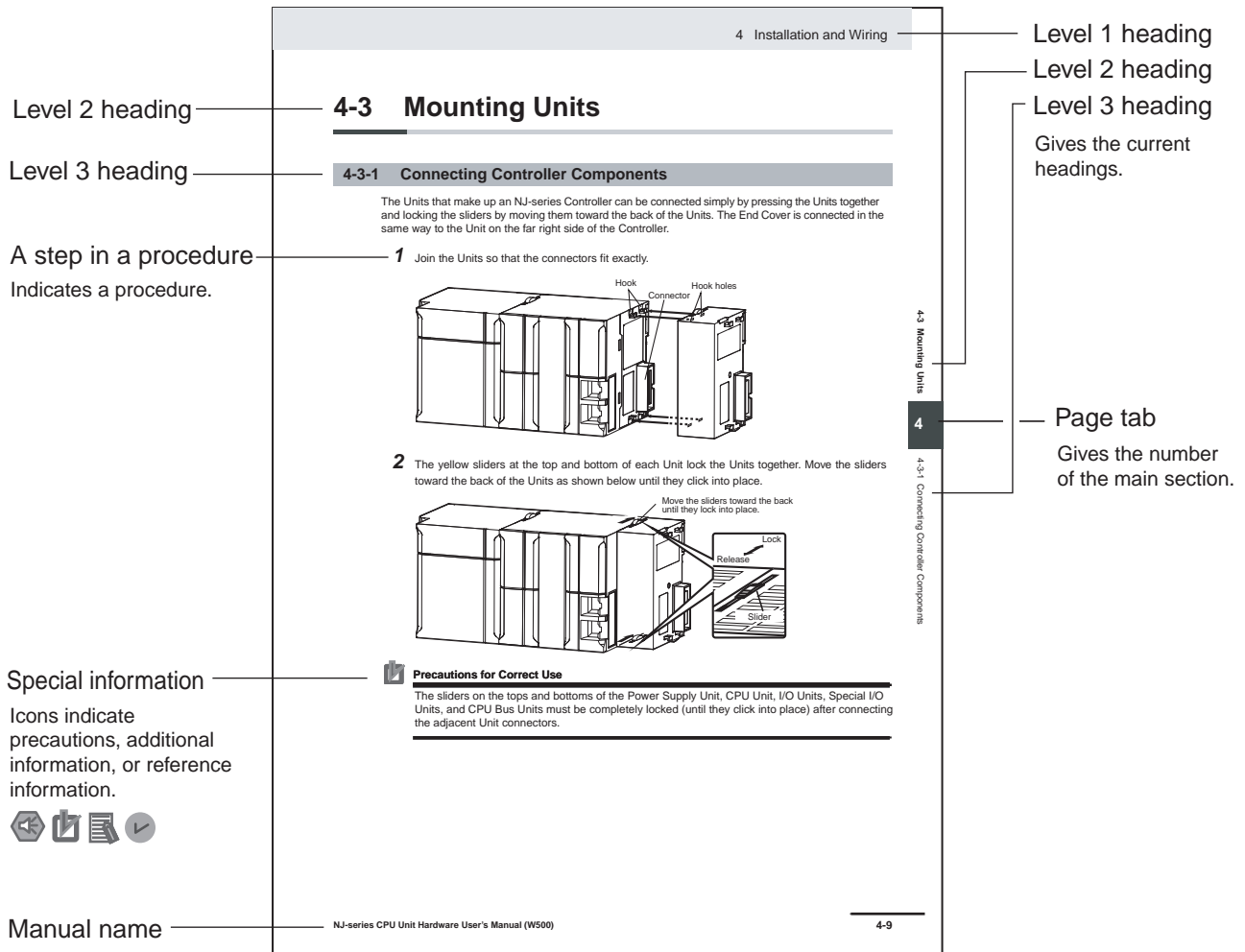

Note This illustration is provided only as a sample. It may not literally appear in this manual.

Special Information

Special information in this manual is classified as follows:



Precautions for Safe Use

Precautions on what to do and what not to do to ensure safe usage of the product.



Precautions for Correct Use

Precautions on what to do and what not to do to ensure proper operation and performance.



Additional Information

Additional information to read as required.

This information is provided to increase understanding or make operation easier.



Version Information

Information on differences in specifications and functionality for CPU Units and EtherCAT Coupler Units with different unit versions and for different versions of the Sysmac Studio is given.

Note References are provided to more detailed or related information.

Precaution on Terminology

- In this manual, “download” refers to transferring data from the Sysmac Studio to the physical Controller and “upload” refers to transferring data from the physical Controller to the Sysmac Studio. For the Sysmac Studio, synchronization is used to both upload and download data. Here, “synchronize” means to automatically compare the data for the Sysmac Studio on the computer with the data in the physical Controller and transfer the data in the direction that is specified by the user.
- In this manual, the directions in relation to the Units are given in the following figure, which shows upright installation.

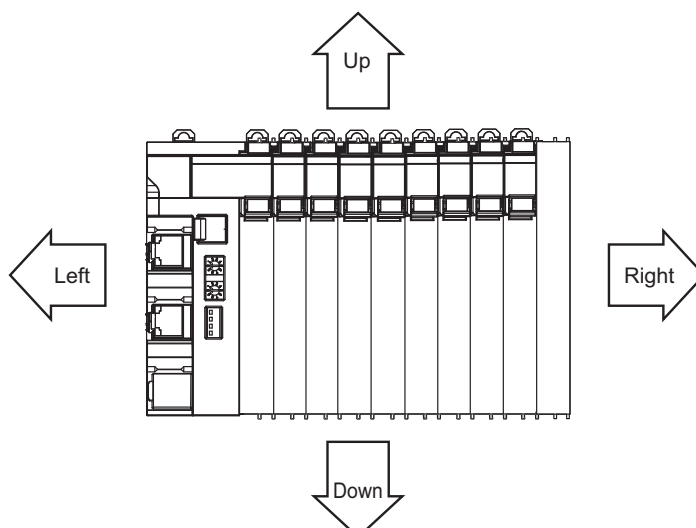

Terms and Conditions Agreement

Read and understand this Manual

Please read and understand this catalog before purchasing the products. Please consult your OMRON representative if you have any questions or comments.

Warranty, Limitations of Liability

Warranties

● Exclusive Warranty

Omron's exclusive warranty is that the Products will be free from defects in materials and workmanship for a period of twelve months from the date of sale by Omron (or such other period expressed in writing by Omron). Omron disclaims all other warranties, express or implied.

● Limitations

OMRON MAKES NO WARRANTY OR REPRESENTATION, EXPRESS OR IMPLIED, ABOUT NON-INFRINGEMENT, MERCHANTABILITY OR FITNESS FOR A PARTICULAR PURPOSE OF THE PRODUCTS. BUYER ACKNOWLEDGES THAT IT ALONE HAS DETERMINED THAT THE PRODUCTS WILL SUITABLY MEET THE REQUIREMENTS OF THEIR INTENDED USE.

Omron further disclaims all warranties and responsibility of any type for claims or expenses based on infringement by the Products or otherwise of any intellectual property right.

● Buyer Remedy

Omron's sole obligation hereunder shall be, at Omron's election, to (i) replace (in the form originally shipped with Buyer responsible for labor charges for removal or replacement thereof) the non-complying Product, (ii) repair the non-complying Product, or (iii) repay or credit Buyer an amount equal to the purchase price of the non-complying Product; provided that in no event shall Omron be responsible for warranty, repair, indemnity or any other claims or expenses regarding the Products unless Omron's analysis confirms that the Products were properly handled, stored, installed and maintained and not subject to contamination, abuse, misuse or inappropriate modification. Return of any Products by Buyer must be approved in writing by Omron before shipment. Omron Companies shall not be liable for the suitability or unsuitability or the results from the use of Products in combination with any electrical or electronic components, circuits, system assemblies or any other materials or substances or environments. Any advice, recommendations or information given orally or in writing, are not to be construed as an amendment or addition to the above warranty.

See <http://www.omron.com/global/> or contact your Omron representative for published information.

Limitation on Liability; Etc

OMRON COMPANIES SHALL NOT BE LIABLE FOR SPECIAL, INDIRECT, INCIDENTAL, OR CONSEQUENTIAL DAMAGES, LOSS OF PROFITS OR PRODUCTION OR COMMERCIAL LOSS IN ANY WAY CONNECTED WITH THE PRODUCTS, WHETHER SUCH CLAIM IS BASED IN CONTRACT, WARRANTY, NEGLIGENCE OR STRICT LIABILITY.

Further, in no event shall liability of Omron Companies exceed the individual price of the Product on which liability is asserted.

Application Considerations

Suitability of Use

Omron Companies shall not be responsible for conformity with any standards, codes or regulations which apply to the combination of the Product in the Buyer's application or use of the Product. At Buyer's request, Omron will provide applicable third party certification documents identifying ratings and limitations of use which apply to the Product. This information by itself is not sufficient for a complete determination of the suitability of the Product in combination with the end product, machine, system, or other application or use. Buyer shall be solely responsible for determining appropriateness of the particular Product with respect to Buyer's application, product or system. Buyer shall take application responsibility in all cases.

NEVER USE THE PRODUCT FOR AN APPLICATION INVOLVING SERIOUS RISK TO LIFE OR PROPERTY WITHOUT ENSURING THAT THE SYSTEM AS A WHOLE HAS BEEN DESIGNED TO ADDRESS THE RISKS, AND THAT THE OMRON PRODUCT(S) IS PROPERLY RATED AND INSTALLED FOR THE INTENDED USE WITHIN THE OVERALL EQUIPMENT OR SYSTEM.

Programmable Products

Omron Companies shall not be responsible for the user's programming of a programmable Product, or any consequence thereof.

Disclaimers

Performance Data

Data presented in Omron Company websites, catalogs and other materials is provided as a guide for the user in determining suitability and does not constitute a warranty. It may represent the result of Omron's test conditions, and the user must correlate it to actual application requirements. Actual performance is subject to the Omron's Warranty and Limitations of Liability.

Change in Specifications

Product specifications and accessories may be changed at any time based on improvements and other reasons. It is our practice to change part numbers when published ratings or features are changed, or when significant construction changes are made. However, some specifications of the Product may be changed without any notice. When in doubt, special part numbers may be assigned to fix or establish key specifications for your application. Please consult with your Omron's representative at any time to confirm actual specifications of purchased Product.

Errors and Omissions

Information presented by Omron Companies has been checked and is believed to be accurate; however, no responsibility is assumed for clerical, typographical or proofreading errors or omissions.



Safety Precautions

Definition of Precautionary Information





The following notation is used in this manual to provide precautions required to ensure safe usage of an NX-series Analog I/O Unit.

The safety precautions that are provided are extremely important to safety. Always read and heed the information provided in all safety precautions.

The following notation is used.

 WARNING	Indicates a potentially hazardous situation which, if not avoided, could result in death or serious injury. Additionally, there may be severe property damage.
 Caution	Indicates a potentially hazardous situation which, if not avoided, may result in minor or moderate injury, or property damage.

Symbols

	The circle and slash symbol indicates operations that you must not do. The specific operation is shown in the circle and explained in text. This example indicates prohibiting disassembly.
	The triangle symbol indicates precautions (including warnings). The specific operation is shown in the triangle and explained in text. This example indicates a precaution for electric shock.
	The triangle symbol indicates precautions (including warnings). The specific operation is shown in the triangle and explained in text. This example indicates a general precaution.
	The filled circle symbol indicates operations that you must do. The specific operation is shown in the circle and explained in text. This example shows a general precaution for something that you must do.

Warnings

WARNING

During Power Supply

Do not touch the terminal section while power is ON.
Electric shock may occur.



Do not attempt to take any Unit apart.

In particular, high-voltage parts are present in Units that supply power while power is supplied or immediately after power is turned OFF. Touching any of these parts may result in electric shock. There are sharp parts inside the Unit that may cause injury.



Fail-safe Measures

Provide safety measures in external circuits to ensure safety in the system if an abnormality occurs due to malfunction of the CPU Unit, other Units, or slaves or due to other external factors affecting operation.



Not doing so may result in serious accidents due to incorrect operation.

Emergency stop circuits, interlock circuits, limit circuits, and similar safety measures must be provided in external control circuits.



The CPU Unit will turn OFF all outputs from Basic Output Units in the following cases. The remote I/O slaves will operate according to the settings in the slaves.

- If a power supply error occurs.
- If the power supply connection becomes faulty.
- If a CPU watchdog timer error or CPU reset occurs.
- If a Controller error in the major fault level occurs.
- While the CPU Unit is on standby until RUN mode is entered after the power is turned ON



External safety measures must be provided to ensure safe operation of the system in such cases.

The outputs may remain ON or OFF due to deposition or burning of the output relays or destruction of the output transistors. As a countermeasure for such problems, external safety measures must be provided to ensure safe operation of the system.



If external power supplies for slaves or other devices are overloaded or short-circuited, the voltage will drop, outputs will turn OFF, and the system may be unable to read inputs. Provide external safety measures in control with monitoring of external power supply voltage as required so that the system operates safely in such a case.



You must take fail-safe measures to ensure safety in the event of incorrect, missing, or abnormal signals caused by broken signal lines, momentary power interruptions, or other causes.



Not doing so may result in serious accidents due to incorrect operation.

Voltage and Current Inputs

Make sure that the voltages and currents that are input to the Units and slaves are within the specified ranges.

Inputting voltages or currents that are outside of the specified ranges may cause accidents or fire.



Transferring

Always confirm safety at the destination node before you transfer Unit configuration information, parameters, settings, or other data from tools such as the Sysmac Studio.

The devices or machines may operate unexpectedly, regardless of the operating mode of the Controller.



Cautions

Caution

Wiring

When you connect a computer or other peripheral device to a Communications Coupler Unit that has a non-isolated DC power supply, either ground the 0-V side of the external power supply (i.e. Unit power supply) or do not ground it at all.

If the peripheral devices are grounded incorrectly, the external power supply (i.e. Unit power supply) may be short-circuited.

Never ground the 24-V side of the power supply, as shown in the following figure.

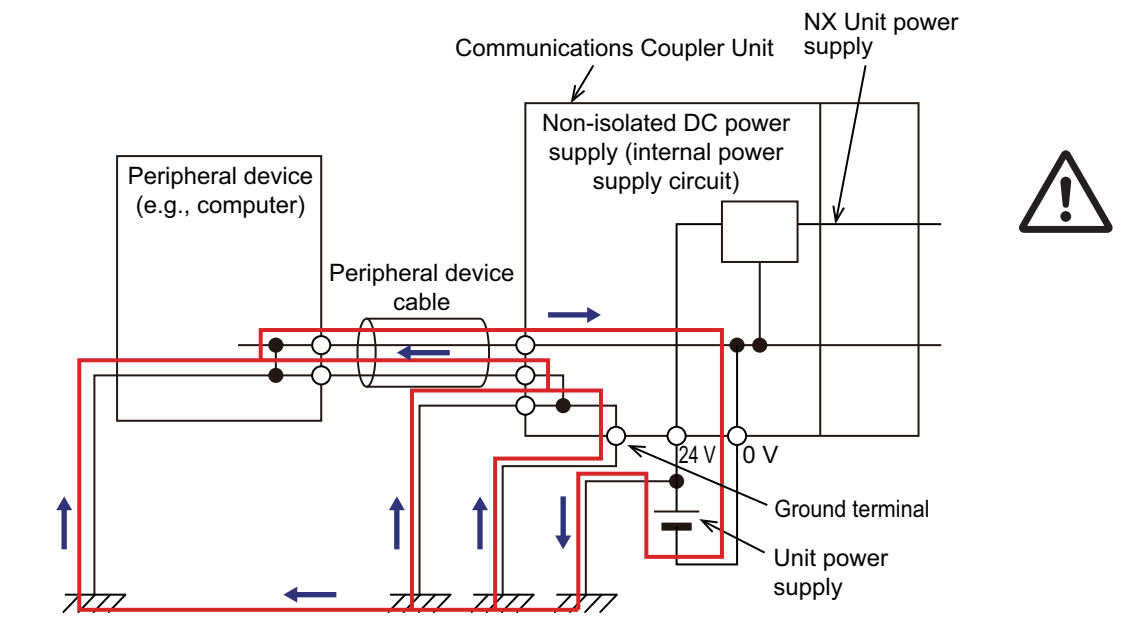

Online Editing

Execute online editing only after confirming that no adverse effects will be caused by deviations in the timing of I/O. If you perform online editing, the task execution time may exceed the task period, I/O may not be refreshed with external devices, input signals may not be read, and output timing may change.



Precautions for Safe Use

Transporting

- When transporting any Unit, use the special packing box for it. Also, do not subject the Unit to excessive vibration or shock during transportation.
- Do not drop any Unit or subject it to abnormal vibration or shock. Doing so may result in Unit malfunction or burning.

Mounting

- Mount terminal blocks and connectors only after checking the mounting location carefully.
- Be sure that the terminal blocks, expansion cables, and other items with locking devices are properly locked into place.

Installation

- Do not apply labels or tape to the Unit. When the Unit is installed or removed, adhesive or scraps may adhere to the pins in the NX bus connector, which may result in malfunctions.
- Do not write on the Communications Coupler Unit or an NX Unit with ink within the restricted region that is shown in the following figure. Also do not get this area dirty. When the Unit is installed or removed, ink or dirt may adhere to the pins in the NX bus connector, which may result in malfunctions in the Slave Terminal.

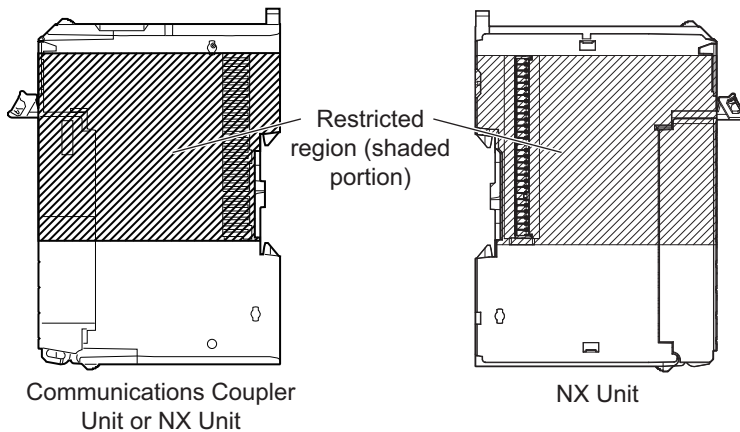

- For the installation orientations in the following figure, support the cables, e.g., with a duct, so that the End Plate on the bottom is not subjected to the weight of the cables. The weight of the cables may cause the bottom End Plate to slide downward so that the Slave Terminal is no longer secured to the DIN Track, which may result in malfunctions.

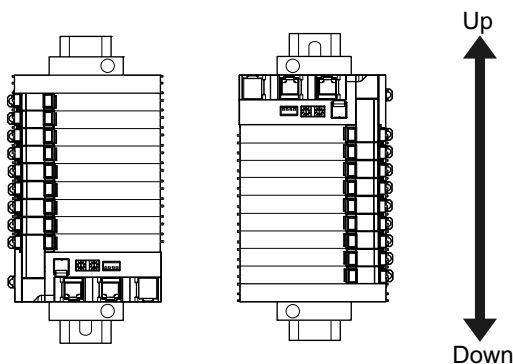

Wiring

- Double-check all switches and other settings and double-check all wiring to make sure that they are correct before turning ON the power supply.
Use the correct wiring parts and tools when you wire the system.
- Do not pull on the cables or bend the cables beyond their natural limit. Also, do not place heavy objects on top of the cables or other wiring lines. Doing so may break the cable.
- When wiring or installing the Units, do not allow metal fragments to enter the Units.
- Do not press the flat-blade screwdriver straight into the release holes on a screwless clamping terminal block. Doing so may damage the terminal block.

NG

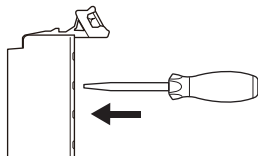

OK

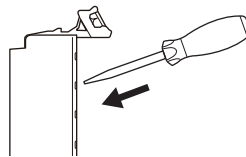

- When you insert a flat-blade screwdriver into a release hole on a screwless clamping terminal block, press it down with a force of 30N or less. Applying excessive force may damage the terminal block.
- Do not incline or twist the flat-blade screwdriver while it is in a release hole on a screwless clamping terminal block. Doing so may damage the terminal block.

NG

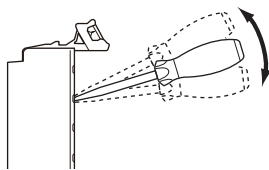

NG

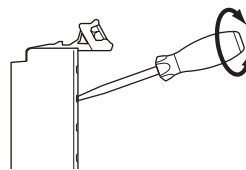

Power Supply Design

- Use all Units within the I/O power supply ranges that are given in the specifications.
- Supply sufficient power according to the contents of this manual.
- Use the power supply voltage that is specified in this manual.
- Do not apply voltages that exceed the rated value to any Input Unit.
- Do not apply voltages or connect loads to the Output Units or slaves in excess of the maximum ratings.
- Inrush current occurs when the power supply is turned ON. When selecting fuses or breakers for external circuits, consider their fusing and detection characteristics as well as the above precautions and allow sufficient margin in shut-off performance.
- Install external breakers and take other safety measures against short-circuiting and overcurrents in external wiring.

Turning ON the Power Supply

- When you set the Operating Mode at Startup, confirm that no adverse effect will occur in the system.

Actual Operation

- Before you start operation, always register the NX Units that are connected to the Communications Coupler Unit in the host communications master as the Unit Configuration Information.

- Check the user program, data, and parameter settings for proper execution before you use them for actual operation.
- If you change the fail-soft operation setting, the output status when the error occurs may also change. Confirm safety before you change the fail-soft operation setting.
- If you use fail-soft operation, write programming to determine whether Unit I/O data is valid. Without such programming, the user program cannot distinguish between Units for which I/O refreshing is continued and Units for which I/O refreshing is stopped.

Turning OFF the Power Supply

- Do not disconnect the cable or turn OFF the power supply to the Controller or a Slave Terminal when downloading data or the user program from Sysmac Studio.
- Always turn OFF the external power supply to the Units before attempting any of the following.
 - Mounting or removing an NX Unit, Communications Coupler Unit, or CPU Unit
 - Assembling Units
 - Setting DIP switches or rotary switches
 - Connecting or wiring cables
 - Attaching or removing terminal blocks or connectors

Units that supply power continue to supply power to the Units for up to several seconds after the power supply is turned OFF. The PWR indicator remains lit as long as power is supplied. Confirm that the PWR indicator is not lit before you perform any of the above.

Operation

- Confirm that the controlled system will not be adversely affected before you perform any of the following operations.
 - Changing the operating mode of the CPU Unit (including changing the setting of the Operating Mode at Startup)
 - Changing the user program or settings
 - Changing set values or present values
 - Forced refreshing
- Always sufficiently check the safety at the connected devices before you change the settings of an EtherCAT slave or Special Unit.

General Communications

- Do not exceed the ranges that are given in the specifications for the communications distance and number of connected Units.

EtherCAT Communications

- Make sure that the communications distance, number of nodes connected, and method of connection for EtherCAT are within specifications.
 - Do not connect EtherCAT Coupler Units to EtherNet/IP, a standard in-house LAN, or other networks. An overload may cause the network to fail or malfunction.
- Malfunctions or unexpected operation may occur for some combinations of EtherCAT revisions of the master and slaves. If you disable the revision check in the network settings, check the slave revision settings in the master and the actual slave revisions, and then make sure that functionality is compatible in the manuals or other references. You can check the slave versions in the settings from the Sysmac Studio and you can check the actual slave revisions from the Sysmac Studio or on slave nameplates.
- After you transfer the user program, the CPU Unit is restarted and communications with the EtherCAT slaves are cut off. During that period, the slave outputs behave according to the slave settings.

The time that communications are cut off depends on the EtherCAT network configuration. Before you transfer the user program, confirm that the system will not be adversely affected.

- EtherCAT communications are not always established immediately after the power supply is turned ON. Use the system-defined variables in the user program to confirm that communications are established before attempting control operations.
- If frames sent to EtherCAT slaves are lost due to noise or other causes, slave I/O data is not communicated, and the intended operation is sometimes not achieved. Perform the following processing if noise countermeasures are necessary.

Program the *_EC_InDataInvalid* (Input Data Disable) system-defined variable as an interlock condition in the user program.

Set the *PDO communications consecutive timeout detection count* setting in the EtherCAT master to at least 2.

Refer to the *NJ-series CPU Unit Built-in EtherCAT Port User's Manual* (Cat. No. W505) for details.

- When an EtherCAT slave is disconnected, communications will stop and control of the outputs will be lost not only for the disconnected slave, but for all slaves connected after it. Confirm that the system will not be adversely affected before you disconnect a slave.
- If you disconnect the cable from an EtherCAT slave to disconnect it from the network, any current communications frames may be lost. If frames are lost, slave I/O data is not communicated, and the intended operation is sometimes not achieved. Perform the following processing for a slave that needs to be replaced.

Program the *_EC_InDataInvalid* (Input Data Disable) system-defined variable as an interlock condition in the user program.

Set the *PDO communications consecutive timeout detection count* setting in the EtherCAT master to at least 2.

Refer to the *NJ-series CPU Unit Built-in EtherCAT Port User's Manual* (Cat. No. W505) for details.

Unit Replacement

- When you replace a Unit, start operation only after you transfer the settings and variables that are required for operation to the new Unit.

Disposal

- Dispose of the product according to local ordinances as they apply.

When Temperature Input Units are Used

- When you use Temperature Input Units that have cold junction sensors, do not remove the cold junction sensors. If the cold junction sensors are removed, you cannot measure the temperature correctly regardless of the cold junction compensation enable/disable setting.
- Use the cold junction sensor that is mounted on Temperature Input Unit when it is delivered. A combination of the Unit, connection circuits and cold junction sensor that is provided was calibrated independently. If you use the cold junction sensor for another Temperature Input Unit or replace the cold junction sensors among multiple Temperature Input Units, the temperature cannot be measured correctly.

Precautions for Correct Use

Storage, Mounting, and Wiring

- Follow the instructions in this manual to correctly perform installation.
- Do not operate or store the Units in the following locations. Doing so may result in malfunction, in operation stopping, or in burning.
 - Locations subject to direct sunlight
 - Locations subject to temperatures or humidity outside the range specified in the specifications
 - Locations subject to condensation as the result of severe changes in temperature
 - Locations subject to corrosive or flammable gases
 - Locations subject to dust (especially iron dust) or salts
 - Locations subject to exposure to water, oil, or chemicals
 - Locations subject to shock or vibration
- Take appropriate and sufficient countermeasures during installation in the following locations.
 - Locations subject to strong, high-frequency noise
 - Locations subject to static electricity or other forms of noise
 - Locations subject to strong electromagnetic fields
 - Locations subject to possible exposure to radioactivity
 - Locations close to power lines
- Before touching a Unit, be sure to first touch a grounded metallic object in order to discharge any static build-up.
- Use the rated power supply voltage for the Units that supply power. Take appropriate measures to ensure that the specified power with the rated voltage and frequency is supplied in places where the power supply is unstable.
- Install the Units away from sources of heat and ensure proper ventilation. Not doing so may result in malfunction, in operation stopping, or in burning.
- Do not allow foreign matter to enter the openings in the Unit. Doing so may result in Unit burning, electric shock, or failure.
- Use the EtherCAT connection methods and applicable cables that are specified in this manual and in the *NJ-series CPU Unit Built-in EtherCAT Port User's Manual* (Cat. No. W505). Otherwise, communications may be faulty.

Actual Operation

- If you change the event level of an error, the output status when the error occurs may also change. Confirm safety before you change an event level.

Turning OFF the Power Supply

- Do not turn OFF the power supply while data is being transferred.
- Do not turn OFF the power supply while parameters are being written to the Communications Coupler Unit or NX Units.

EtherCAT Communications

- Do not disconnect the EtherCAT communications cables during operation. The outputs will become unstable. However, for the built-in EtherCAT port on the NJ-series CPU Unit, it is OK to disconnect the communications cable from an EtherCAT Slave Terminal that has been disconnected from communications in the software.

Regulations and Standards

Conformance to EC Directives

Applicable Directives

- EMC Directives
- Low Voltage Directive

Concepts

● EMC Directives

OMRON devices that comply with EC Directives also conform to the related EMC standards so that they can be more easily built into other devices or the overall machine. The actual products have been checked for conformity to EMC standards.*1

Whether the products conform to the standards in the system used by the customer, however, must be checked by the customer. EMC-related performance of the OMRON devices that comply with EC Directives will vary depending on the configuration, wiring, and other conditions of the equipment or control panel on which the OMRON devices are installed. The customer must, therefore, perform the final check to confirm that devices and the overall machine conform to EMC standards.

- *1. Applicable EMC (Electromagnetic Compatibility) standards are as follows:
 EMS (Electromagnetic Susceptibility): EN 61131-2
 EMI (Electromagnetic Interference): EN 61131-2 (Radiated emission: 10-m regulations).

● Low Voltage Directive

Always ensure that devices operating at voltages of 50 to 1,000 VAC and 75 to 1,500 VDC meet the required safety standards. The applicable directive is EN 61131-2.

● Conformance to EC Directives

The NX-series Units comply with EC Directives. To ensure that the machine or device in which the NX-series Units are used complies with EC Directives, the following precautions must be observed.

- The NX-series Units must be installed within a control panel.
- You must use reinforced insulation or double insulation for the DC power supplies that are connected as the Unit power supplies and I/O power supplies for the NX-series Units.
 We recommend that you use the OMRON S8JX-series Power Supplies. EMC standard compliance was confirmed for the recommended Power Supplies.
- NX-series Units that comply with EC Directives also conform to the Common Emission Standard (EN 61131-2). Radiated emission characteristics (10-m regulations) may vary depending on the configuration of the control panel used, other devices connected to the control panel, wiring, and other conditions.
 You must therefore confirm that the overall machine or equipment in which the NX-series Units are used complies with EC Directives.
- You must use power supplies with an output hold time of 10 ms or longer for the DC power supplies that are connected as the Unit power supplies and I/O power supplies for the NX-series Units.
- This is a Class A product (for industrial environments). In a residential environment, it may cause radio interference. If radio interference occurs, the user may be required to take appropriate measures.

Conformance Requirement to EC Directives

The immunity test conditions for NX series Analog I/O Units are as follows.

Unit Type	Conversion time	Overall accuracy
Analog Input Units	250 μ s/point	+3% / -6%
	10 μ s/point	+6% / -6%
Analog Output Units	250 μ s/point	+4% / -4%
	10 μ s/point	+4.5% / -4.5%
Temperature Input Units	250 ms/Unit	+5% / -5%
	10 ms/Unit	
	60 ms/Unit	

Use a shield wire (2 conductors, twisted wire) or a shield wire (3 conductors) to connect the Analog Input Units and Analog Output Units. The compatibility was confirmed in a condition that the shield wire was not connected.

Conformance to UL and CSA Standards

Some NX-series products comply with UL and CSA standards. If you use an NX-series product that complies with UL or CSA standards and the machinery or system in which you use the NX-series product must also comply with the standards, refer to the *Instruction Sheet* that is provided with the product. The *Instruction Sheet* provides the application conditions for complying with the standards.

Conformance to Shipbuilding Standards

Some NX-series products comply with shipbuilding standards. If you use an NX-series product that complies with shipbuilding standards and the machinery or system in which you use the NX-series product must also comply with the standards, consult with your OMRON representative. Application conditions are defined according to the installation location. Application may not be possible for some installation locations.

Usage Conditions for NK and LR Shipbuilding Standards

● Usage Conditions for Locations Other Than the Bridge or Decks

- The EtherCAT Coupler Unit must be installed within a control panel.
- Gaps in the door to the control panel must be completely filled or covered with gaskets or other material.

● Usage Conditions for the Bridge (Certified only by Nippon Kaiji Kyokai (Class NK))

- The EtherCAT Coupler Unit must be installed within a control panel.
- Gaps in the door to the control panel must be completely filled or covered with gaskets or other material.
- The following noise filter must be connected to the power supply line.

Name	Manufacturer	Model
Noise filter	Cosel Co., Ltd.	TAH-06-683

Conformance to KC Standards

Observe the following precaution if you use NX-series Units in Korea.

A 급 기기 (업무용 방송통신기자재)
이 기기는 업무용(A 급) 전자파적합기기로서 판매자
또는 사용자는 이 점을 주의하시기 바라며, 가정외의
지역에서 사용하는 것을 목적으로 합니다.

Class A Device (Broadcasting Communications Device for Office Use)

This device obtained EMC registration for office use (Class A), and it is intended to be used in places other than homes.

Sellers and/or users need to take note of this.

Software Licenses and Copyrights

This product incorporates certain third party software. The license and copyright information associated with this software is available at http://www.fa.omron.co.jp/nj_info_e/.

Unit Versions

This section describes the notation that is used for unit versions, the confirmation method for unit versions, and the relationship between unit versions and Sysmac Studio versions.

Unit Versions

A “unit version” has been introduced to manage the Units in the NX Series according to differences in functionality accompanying Unit upgrades.

Notation of Unit Versions on Products

The unit version is given with the Unit specifications on the side of the Unit or in the notched area.

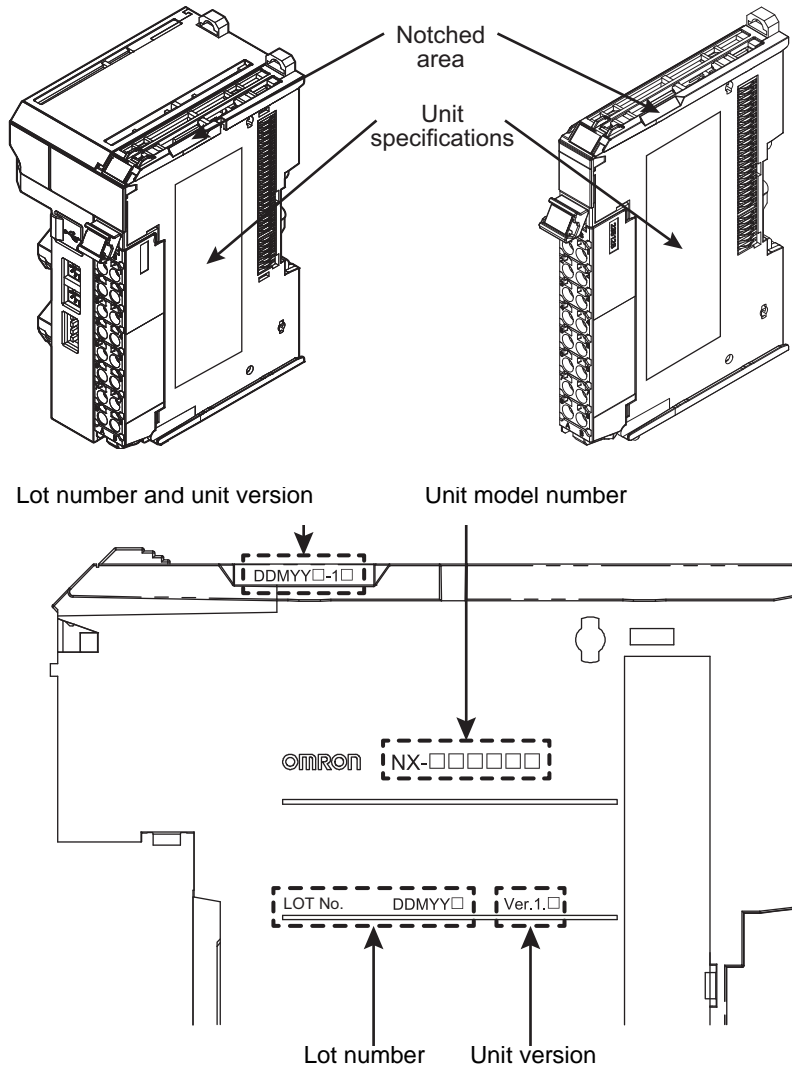

The following information is provided in the Unit specifications on the Unit.

Name	Function
Unit model number	Gives the model of the Unit.
Unit version	Gives the unit version of the Unit.
Lot number	Gives the lot number of the Unit. DDMY□: Lot number, □: Used by OMRON. “M” gives the month (1 to 9: January to September, X: October, Y: November, Z: December)

The following information is provided in the notched area on the Unit.

Name	Function
Lot number and unit version	<p>Gives the lot number and unit version of the Unit.</p> <ul style="list-style-type: none"> DDMY□□: Lot number, □□: Used by OMRON. “M” gives the month (1 to 9: January to September, X: October, Y: November, Z: December) 1□□: Unit version <p>The decimal portion of the unit version is omitted. (It is provided in the Unit specifications.)</p>

Confirming Unit Versions with the Sysmac Studio

You can use the Unit Production Information on the Sysmac Studio to check the unit versions EtherCAT Coupler Unit and NX Units.

- 1 Double-click **EtherCAT** under **Configurations and Setup** in the Multiview Explorer, and then double-click the EtherCAT Coupler Unit. Or, right-click the EtherCAT Coupler Unit and select **Edit** from the menu.

The Edit Slave Terminal Configuration Tab Page is displayed.

You can also display the Edit Slave Terminal Configuration Tab Page with any of the following operations.

Double-click **EtherCAT** under **Configurations and Setup** in the Multiview Explorer, right-click the EtherCAT Coupler Unit in the EtherCAT Configuration Edit Tab Page, and select **Edit Slave Terminal Configuration**.

Or, select the EtherCAT Coupler Unit on the EtherCAT Configuration Edit Tab Page click the **Edit Slave Terminal Configuration** Button.

- 2 Go online.
- 3 Right-click the EtherCAT Coupler Unit and select **Display Production Information** from the menu.

The Production Information Dialog Box is displayed.

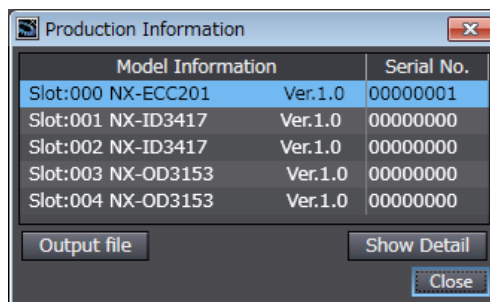

Simple Display

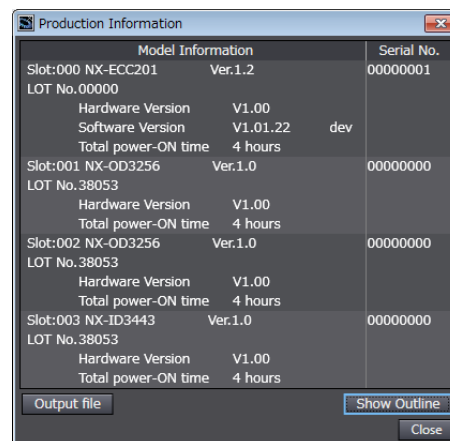

Detailed Display

In this example, “Ver.1.0” is displayed next to the Unit model.

The following items are displayed.

- Slot number
- Unit model number
- Unit version
- Serial number
- Lot number

- Hardware version
- Software version
- Total power-ON time

The software version is displayed only for Units that contain software.



Version Information

The total power-ON time is provided by function to monitor the total power-ON time. The function to monitor the total power-ON time was added for a version upgrade. Refer to the *EtherCAT Coupler Unit User's Manual* (Cat. No. W519-E1-03 or later) for the versions that support monitoring the total power-ON time.

Unit Versions and Sysmac Studio Versions

The functions that are supported depend on the unit version of the Unit. The version of Sysmac Studio that supports the functions that were added for an upgrade is also required to use those functions.

Refer to *A-5 Version Information* on page A-95 for the functions that are supported by each unit version.

Unit Version Notation

In this User's Manual, unit versions are specified as shown in the following table.

Unit version in Unit specifications on the product	Notation in this manual	Remarks
Unit version 1.0 or later	Ver. 1.□ or later	Unless unit versions are specified, the information in this manual applies to all unit versions.

Related Manuals

The following manuals are related to the NJ-series Controllers. Use these manuals for reference.

Manual name	Cat. No.	Model numbers	Application	Description
NX-series Analog I/O Units User's Manual	W522	NX-AD□□□□ NX-DA□□□□ NX-TS□□□□	Learning how to use NX-series Analog I/O Units and Temperature Input Units	The hardware, setup methods, and functions of the NX-series Analog I/O Units and Temperature Input Units are described.
NX-series Data Reference Manual	W525	NX-□□□□□□	Referencing lists of the data that is required to configure systems with NX-series Units	Lists of the power consumptions, weights, and other NX Unit data that is required to configure systems with NX-series Units are provided.
NX-series Digital I/O Units User's Manual	W521	NX-ID□□□□ NX-IA□□□□ NX-OC□□□□ NX-OD□□□□	Learning how to use NX-series Digital I/O Units	The hardware, setup methods, and functions of the NX-series Digital I/O Units are described.
NX-series System Units User's Manual	W523	NX-PD1□□□ NX-PF0□□□ NX-PC0□□□ NX-TBX01	Learning how to use NX-series System Units	The hardware and functions of the NX-series System Units are described.
NX-series Position Interface Units User's Manual	W524	NX-EC0□□□ NX-ECS□□□ NX-PG0□□□	Learning how to use NX-series Position Interface Units	The hardware, setup methods, and functions of the NX-series Incremental Encoder Input Units, SSI Input Units, and Pulse Output Unit are described.
NX-series Safety Control Unit User's Manual	Z930	NX-SL□□□□ NX-SI□□□□ NX-SO□□□□	Learning how to use NX-series Safety Control Units	The hardware, setup methods, and functions of the NX-series Safety Control Units are described.
NX-series Safety Control Unit Instructions Reference Manual	Z931	NX-SL□□□□	Learning about the specifications of instructions for the Safety CPU Unit.	The instructions for the Safety CPU Unit are described. When programming, use this manual together with the <i>NX-series Safety Control Unit User's Manual</i> (Cat. No. Z930).
Sysmac Studio Version 1 Operation Manual	W504	SYSMAC-SE2□□□	Learning about the operating procedures and functions of the Sysmac Studio.	Describes the operating procedures of the Sysmac Studio.
NJ-series Troubleshooting Manual	W503	NJ501-□□□□ NJ301-□□□□	Learning about the errors that may be detected in an NJ-series Controller.	Concepts on managing errors that may be detected in an NJ-series Controller and information on individual errors are described. Use this manual together with the <i>NJ-series CPU Unit Hardware User's Manual</i> (Cat. No. W500) and <i>NJ-series CPU Unit Software User's Manual</i> (Cat. No. W501).

Manual name	Cat. No.	Model numbers	Application	Description
NX-series EtherCAT® Coupler Unit User's Manual	W519	NX-ECC201 NX-ECC202	Learning how to use an NX-series EtherCAT Coupler Unit and EtherCAT Slave Terminals	The following items are described: the overall system and configuration methods of an EtherCAT Slave Terminal (which consists of an NX-series EtherCAT Coupler Unit and NX Units), and information on hardware, setup, and functions to set up, control, and monitor NX Units through EtherCAT.
NJ-series CPU Unit Hardware User's Manual	W500	NJ501-□□□□ NJ301-□□□□	Learning the basic specifications of the NJ-series CPU Units, including introductory information, designing, installation, and maintenance. Mainly hardware information is provided.	An introduction to the entire NJ-series system is provided along with the following information on the CPU Unit. <ul style="list-style-type: none"> • Features and system configuration • Overview • Part names and functions • General specifications • Installation and wiring • Maintenance and Inspection Use this manual together with the <i>NJ-series CPU Unit Software User's Manual</i> (Cat. No. W501).
NJ-series CPU Unit Software User's Manual	W501	NJ501-□□□□ NJ301-□□□□	Learning how to program and set up an NJ-series CPU Unit. Mainly software information is provided.	The following information is provided on an NJ-series CPU Unit. <ul style="list-style-type: none"> • CPU Unit operation • CPU Unit features • Initial settings • Programming based on IEC 61131-3 language specifications Use this manual together with the <i>NJ-series CPU Unit Hardware User's Manual</i> (Cat. No. W500).
NJ-series CPU Unit Built-in EtherCAT® Port User's Manual	W505	NJ501-□□□□ NJ301-□□□□	Using the built-in EtherCAT port on an NJ-series CPU Unit.	Information on the built-in EtherCAT port is provided. This manual provides an introduction and provides information on the configuration, features, and setup. Use this manual together with the <i>NJ-series CPU Unit Hardware User's Manual</i> (Cat. No. W500) and <i>NJ-series CPU Unit Software User's Manual</i> (Cat. No. W501).
NJ-series CPU Unit Motion Control User's Manual	W507	NJ501-□□□□ NJ301-□□□□	Learning about motion control settings and programming concepts.	The settings and operation of the CPU Unit and programming concepts for motion control are described. When programming, use this manual together with the <i>NJ-series CPU Unit Hardware User's Manual</i> (Cat. No. W500) and <i>NJ-series CPU Unit Software User's Manual</i> (Cat. No. W501).

Manual name	Cat. No.	Model numbers	Application	Description
NJ-series Instructions Reference Manual	W502	NJ501-□□□□ NJ301-□□□□	Learning detailed specifications on the basic instructions of an NJ-series CPU Unit.	The instructions in the instruction set (IEC 61131-3 specifications) are described. When programming, use this manual together with the <i>NJ-series CPU Unit Hardware User's Manual</i> (Cat. No. W500) and <i>NJ-series CPU Unit Software User's Manual</i> (Cat. No. W501).
NJ-series Motion Control Instructions Reference Manual	W508	NJ501-□□□□ NJ301-□□□□	Learning about the specifications of the motion control instructions.	The motion control instructions are described. When programming, use this manual together with the <i>NJ-series CPU Unit Hardware User's Manual</i> (Cat. No. W500), <i>NJ-series CPU Unit Software User's Manual</i> (Cat. No. W501) and <i>NJ-series CPU Unit Motion Control User's Manual</i> (Cat. No. W507).

Terminology

Term	Abbreviation	Description
application layer status, AL status	---	Status for indicating information on errors that occur in an application on a slave.
CAN application protocol over EtherCAT	CoE	A CAN application protocol service implemented on EtherCAT.
CAN in Automation	CiA	CiA is the international users' and manufacturers' group that develops and supports higher-layer protocols.
Communications Coupler Units	---	The generic name of an interface unit for remote I/O communications on a network between NX Units and a host network master.
DC time	---	EtherCAT slaves that support distributed clock synchronization have a clock that is shared by all slaves in the network. The time that is based on this distributed clock is called the DC time.
device profile	---	A collection of device dependent information and functionality providing consistency between similar devices of the same device type.
device variable	---	A variable in the NJ-series CPU Unit to which process data on an EtherCAT slave is allocated. Slave process data is accessed by directly reading and writing device variables from user applications on the NJ-series CPU Unit.
distributed clock	DC	Clock distribution mechanism used to synchronize EtherCAT slaves and the EtherCAT master.
EtherCAT slave controller	ESC	A controller for EtherCAT slave communications.
EtherCAT slave information	ESI	An XML file that contains setting information for an EtherCAT slave.
EtherCAT state machine	ESM	An EtherCAT communications state machine.
EtherCAT Technology Group	ETG	The ETG is a global organization in which OEM, end users, and technology providers join forces to support and promote the further technology development.
I/O map settings	---	Settings that assign variables to I/O ports. Assignment information between I/O ports and variables.
I/O port	---	A logical interface that is used by the CPU Unit to exchange data with an external device (slave or Unit).
I/O refreshing	---	Cyclic data exchange with external devices that is performed with predetermined memory addresses.
index	---	Address of an object within an application process.
network configuration information	---	The EtherCAT network configuration information held by the EtherCAT master.
NX bus	---	The NX-series internal bus.
object	---	An abstract representation of a particular component within a device, which consists of data, parameters, and methods.
object dictionary	OD	Data structure that contains description of data type objects, communication objects and application objects.
Operational	---	A state in EtherCAT communications where SDO communications and I/O are possible.
PDO communications	---	An acronym for process data communications.
Pre-Operational	---	A state in EtherCAT communications where only SDO communications are possible with the slaves, i.e., no I/O can be performed.
primary periodic task	---	The task with the highest priority.
process data	---	Collection of application objects designated to be downloaded cyclically or acyclically for the purpose of measurement and control.
process data communications	---	One type of EtherCAT communications in which process data objects (PDOs) are used to exchange information cyclically and in realtime. This is also called PDO communications.

Term	Abbreviation	Description
process data object	PDO	A structure that describes the mappings of parameters that have one or more process data entities.
receive PDO	RxPDO	A process data object received by an EtherCAT slave.
Safe-Operational	---	A state in EtherCAT communications where only SDO communications and reading input data from slaves are possible. Outputs from slaves are not performed.
SDO communications	---	One type of EtherCAT communications in which service data objects (SDOs) are used to transmit information whenever required.
service data object	SDO	CoE asynchronous mailbox communications where all objects in the object dictionary can be read and written.
Slave Information Interface	SII	Slave information that is stored in non-volatile memory in the slave.
Slave Terminal	---	A building-block remote I/O terminal to which a Communications Coupler Unit and NX Units are mounted
subindex	---	Sub-address of an object within the object dictionary.
Sync0	---	A signal that gives the interrupt timing based on the distributed clock (DC) in EtherCAT communications. The slaves execute controls according to this interrupt timing.
Sync Manager	SM	Collection of control elements to coordinate access to concurrently used objects.
task period	---	The interval at which the primary periodic task or a periodic task is executed.
transmit PDO	TxPDO	A process data object sent from an EtherCAT slave.

Revision History

A manual revision code appears as a suffix to the catalog number on the front and back covers of the manual.

Cat. No.	W522-E1-03
-----------------	-------------------

↑
Revision code

Revision code	Date	Revised content
01	April 2013	Original production
02	June 2013	Corrected mistakes
03	September 2013	<ul style="list-style-type: none"> • Made changes accompanying release to unit version 1.1 of the Temperature Input Units. • Added information on the NX-TS□□02/TS□□04. • Corrected mistakes.

Sections in this Manual

1	Features and System Configuration	10	Inspection and Maintenance	1	10
2	Specifications	A	Appendices	2	A
3	Part Names and Functions	I	Index	3	I
4	Installation and Wiring			4	
5	I/O Refreshing			5	
6	Analog Input Units			6	
7	Analog Output Units			7	
8	Temperature Input Units			8	
9	Troubleshooting			9	

1

Features and System Configuration

This section describes NX system configuration and the types of Analog I/O Units.

1-1	Features and Types of Analog I/O Units	1-2
1-1-1	Analog I/O Unit Features	1-2
1-1-2	Analog I/O Unit Types	1-2
1-2	System Configuration of Slave Terminals	1-3
1-2-1	Overview	1-3
1-2-2	System Configuration	1-3
1-3	Model List	1-5
1-3-1	Model Notation	1-5
1-3-2	Analog Input Units	1-7
1-3-3	Analog Output Units	1-9
1-3-4	Temperature Input Units	1-10
1-4	List of Functions	1-11
1-4-1	Analog Input Units	1-11
1-4-2	Analog Output Units	1-12
1-4-3	Temperature Input Units	1-13
1-5	Support Software	1-14
1-5-1	Applicable Support Software	1-14

1-1 Features and Types of Analog I/O Units

This section describes features and types of Analog I/O Units.

1-1-1 Analog I/O Unit Features

The Analog I/O Units are NX Units to process inputs and outputs of analog signals.

The NX-series Analog I/O Units have the following features.

Synchronous I/O with Refresh Cycle of the NX Bus

When the EtherCAT Coupler Unit is used together with NX Units that support synchronous I/O refreshing, the I/O control of multiple NX Units can be synchronized at the time to synchronize with the refresh cycle of the NX bus.

This provides an accurate I/O control because it suppresses jitter in the I/O timing of multiple NX Units.

Simple I/O Wiring with a Screwless Clamping Terminal Block

The terminal block is a screwless clamping terminal block.

You can connect the wires simply by pushing the ferrules into the terminals. The amount of wiring work is reduced without requiring the use of screws.

1-1-2 Analog I/O Unit Types

The types of Analog I/O Units are as follows.

Type	Purpose
Analog Input Units	These are Units with functionality to convert analog input signals to digital values.
Analog Output Units	These are Units with functionality to convert output set values set by a user program etc. to analog signals.
Temperature Input Units	These are Units with functionality to process temperature sensor inputs. There are thermocouple input and resistance thermometer input types.

Refer to *1-3 Model List* on page 1-5 for details on Analog I/O Unit models and *1-4 List of Functions* on page 1-11 for details on their functions.

1-2 System Configuration of Slave Terminals

1-2-1 Overview

The Slave Terminal is a building-block remote I/O slave that is created by mounting a group of NX Units to a Communications Coupler Unit.

The NX Units can be flexibly combined with a Communications Coupler Unit to achieve the optimum remote I/O slave for the application with less wiring, less work, and less space.

1-2-2 System Configuration

The following figure shows an example of the system configuration when an EtherCAT Coupler Unit is used as a Communications Coupler Unit.

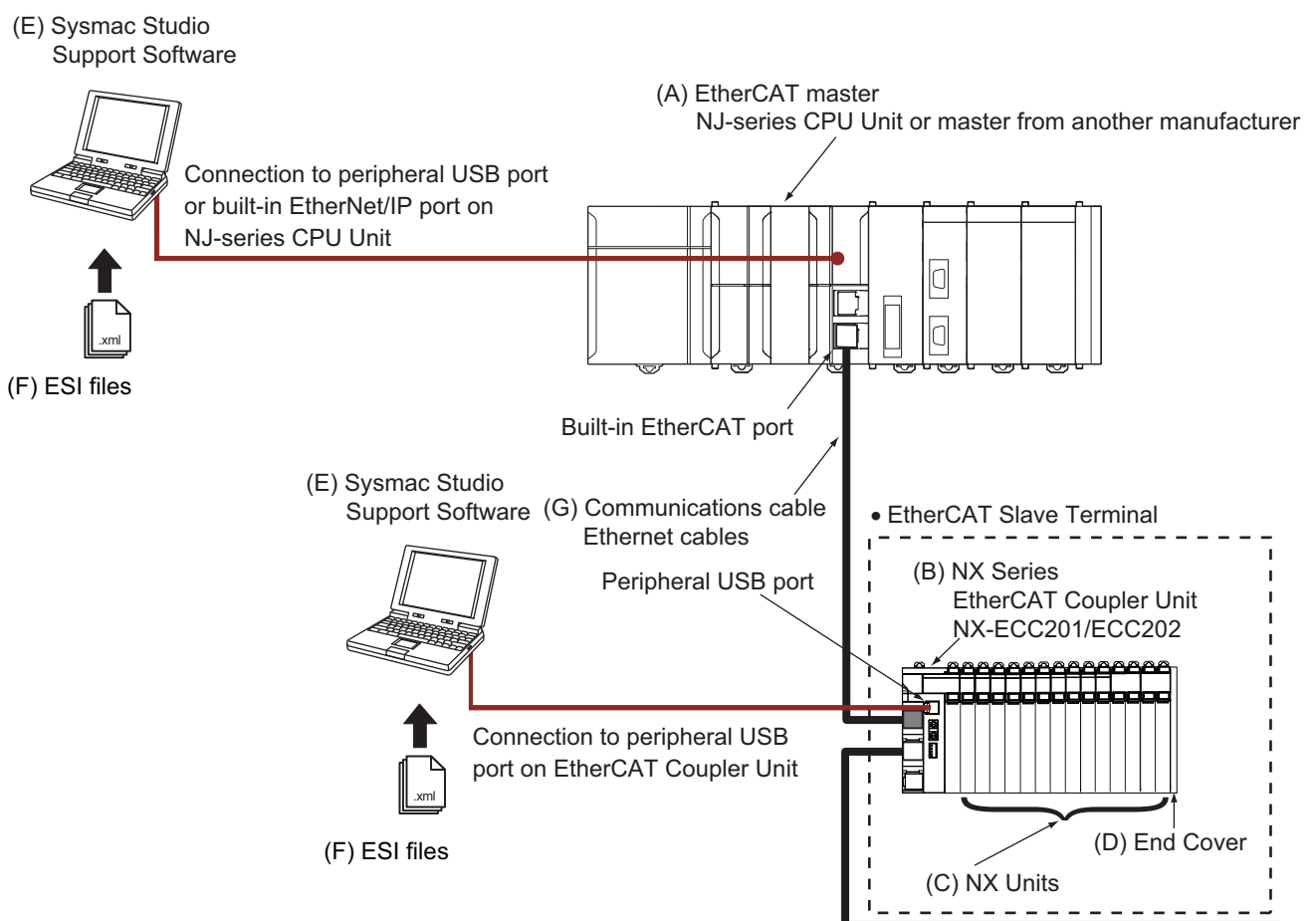

Letter	Item	Description
(A)	EtherCAT master *1	The EtherCAT master manages the network, monitors the status of slaves, and exchanges I/O data with slaves.
(B)	EtherCAT Coupler Unit	<p>The EtherCAT Coupler Unit serves as an interface for process data communications on the EtherCAT network between the NX Units and the EtherCAT master.</p> <p>The I/O data for the NX Units is accumulated in the EtherCAT Coupler Unit and then all of the data is exchanged with the EtherCAT master at the same time.</p> <p>The EtherCAT Coupler Unit can also perform message communications (SDO communications) with the EtherCAT master.</p>
(C)	NX Units	<p>The NX Units perform I/O processing with connected external devices.</p> <p>The NX Units perform process data communications with the EtherCAT master through the EtherCAT Coupler Unit.</p>
(D)	End Cover	The End Cover is attached to the end of the Slave Terminal.
(E)	Sysmac Studio Support Software	<p>The Sysmac Studio runs on a personal computer and it is used to configure the EtherCAT network and EtherCAT Slave Terminal, and to program, monitor, and troubleshoot the Controllers.</p> <p>You can connect the computer, in which the Sysmac Studio is installed, to the peripheral USB port or built-in EtherNet/IP port on an NJ-series CPU Unit to set up the EtherCAT Slave Terminal. Or you can connect it to the peripheral USB port on the EtherCAT Coupler Unit to set up the EtherCAT Slave Terminal.</p>
(F)	ESI (EtherCAT Slave Information) file	<p>The ESI file contains information that is unique to the EtherCAT Slave Terminal in XML format. You can load the ESI file into the Sysmac Studio to easily allocate Slave Terminal process data and configure other settings.</p> <p>The ESI files for OMRON EtherCAT slaves are already installed in the Sysmac Studio. You can update the Sysmac Studio to get the ESI files for the most recent models.</p>
(G)	Communications cable	Use a double-shielded cable with aluminum tape and braiding of Ethernet category 5 (100Base-TX) or higher, and use straight wiring.

*1. An EtherCAT Slave Terminal cannot be connected to any of the OMRON CJ1W-NC□81/□82 Position Control Units even though they can operate as EtherCAT masters.

1-3 Model List

1-3-1 Model Notation

The Analog I/O Unit models are assigned based on the following rules.

NX - □□□□□□

Unit type _____
 AD : Analog input
 DA : Analog output
 TS : Temperature input

Number of points _____
 2 : 2 points
 3 : 4 points
 4 : 8 points

I/O type (signal range and sensor type) _____

Number	AD/DA	TS
1	–	Thermocouple
2	4 to 20 mA	Resistance thermometer
6	-10 to +10 V	–

Other specifications _____
 Refer to *Other specifications* on the next page.

Other Specifications

● Analog Input Units

Number	Resolution	Conversion time	Input method	I/O refreshing method	
				Free-Run refreshing ^{*1} only	Switching Synchronous I/O refreshing ^{*2} and Free-Run refreshing
03	1/8000	250 μ s/point	Single-ended	Yes	–
04	1/8000	250 μ s/point	Differential	Yes	–
08	1/30000	10 μ s/point	Differential	–	Yes

*1. Free-Run refreshing

*2. Synchronous I/O refreshing

● Analog Output Units

Number	Resolution	Conversion time	I/O refreshing method	
			Free-Run refreshing ^{*1} only	Switching Synchronous I/O refreshing ^{*2} and Free-Run refreshing
03	1/8000	250 μ s/point	Yes	–
05	1/30000	10 μ s/point	–	Yes

*1. Free-Run refreshing

*2. Synchronous I/O refreshing

● Temperature Input Units

Number	Conversion time	Resolution	I/O refreshing method	
			Free-Run refreshing ^{*1} only	Switching Synchronous I/O refreshing ^{*2} and Free-Run refreshing
01	250 ms/Unit	0.1°C max. ^{*3}	Yes	–
02	10 ms/Unit	0.01°C max.	Yes	–
04	60 ms/Unit	0.001°C max.	Yes	–

*1. Free-Run refreshing

*2. Synchronous I/O refreshing

*3. The resolution is 0.2°C max. when the input type is R, S, or W.

Refer to *Section 5 I/O Refreshing* for details on the I/O refreshing method.

1-3-2 Analog Input Units

This section shows the specifications for Analog Input Units.

Refer to *A-1-2 Analog Input Units* on page A-5 for details on the specifications of individual Analog Input Units.

Analog Input Units (Screwless Clamping Terminal Block, 12 mm Width)

Model	Number of points	Input range	Resolution	Input method	I/O refreshing method	Conversion time	Reference
NX-AD2203	2 points	4 to 20 mA	1/8000	Single-ended	Free-Run refreshing	250 μ s/point	P. A-6
NX-AD2204							P. A-7
NX-AD2208			1/30000	Differential	Switching Synchronous I/O refreshing and Free-Run refreshing	10 μ s/point	P. A-8
NX-AD2603		-10 to +10 V	1/8000	Single-ended	Free-Run refreshing	250 μ s/point	P. A-9
NX-AD2604							P. A-10
NX-AD2608			1/30000	Differential	Switching Synchronous I/O refreshing and Free-Run refreshing	10 μ s/point	P. A-11
NX-AD3203	4 points	4 to 20 mA	1/8000	Single-ended	Free-Run refreshing	250 μ s/point	P. A-12
NX-AD3204							P. A-13
NX-AD3208			1/30000	Differential	Switching Synchronous I/O refreshing and Free-Run refreshing	10 μ s/point	P. A-14
NX-AD3603		-10 to +10 V	1/8000	Single-ended	Free-Run refreshing	250 μ s/point	P. A-15
NX-AD3604							P. A-16
NX-AD3608			1/30000	Differential	Switching Synchronous I/O refreshing and Free-Run refreshing	10 μ s/point	P. A-17

Model	Number of points	Input range	Resolution	Input method	I/O refreshing method	Conversion time	Reference
NX-AD4203	8 points	4 to 20 mA	1/8000	Single-ended	Free-Run refreshing	250 μs/point	P. A-18
NX-AD4204							P. A-19
NX-AD4208			1/30000	Differential	Switching Synchronous I/O refreshing and Free-Run refreshing	10 μs/point	P. A-20
NX-AD4603		-10 to +10 V	1/8000	Single-ended	Free-Run refreshing	250 μs/point	P. A-21
NX-AD4604							P. A-22
NX-AD4608			1/30000	Differential	Switching Synchronous I/O refreshing and Free-Run refreshing	10 μs/point	P. A-23

1-3-3 Analog Output Units

This section shows the specifications for Analog Output Units.

Refer to *A-1-3 Analog Output Units* on page A-24 for details on the specifications of individual Analog Output Units.

Analog Output Units (Screwless Clamping Terminal Block, 12 mm Width)

Model	Number of points	Output range	Resolution	I/O refreshing method	Conversion time	Reference
NX-DA2203	2 points	4 to 20 mA	1/8000	Free-Run refreshing	250 μ s/point	P. A-25
NX-DA2205			1/30000	Switching Synchronous I/O refreshing and Free-Run refreshing	10 μ s/point	P. A-27
NX-DA2603	2 points	-10 to +10 V	1/8000	Free-Run refreshing	250 μ s/point	P. A-29
NX-DA2605			1/30000	Switching Synchronous I/O refreshing and Free-Run refreshing	10 μ s/point	P. A-30
NX-DA3203	4 points	4 to 20 mA	1/8000	Free-Run refreshing	250 μ s/point	P. A-31
NX-DA3205			1/30000	Switching Synchronous I/O refreshing and Free-Run refreshing	10 μ s/point	P. A-33
NX-DA3603		-10 to +10 V	1/8000	Free-Run refreshing	250 μ s/point	P. A-35
NX-DA3605			1/30000	Switching Synchronous I/O refreshing and Free-Run refreshing	10 μ s/point	P. A-36

1-3-4 Temperature Input Units

This section shows the specifications for Temperature Input Units.

Refer to *A-1-4 Temperature Input Units* on page A-37 for details on the specifications of individual Analog Input Units.

Temperature Input Units (Screwless Clamping Terminal Block, 12 mm Width)

Model	Number of points	Input type	Conversion time	Resolution	I/O refreshing method	Reference
NX-TS2101	2 points	Thermocouple	250 ms/Unit	0.1°C max. ^{*1}	Free-Run refreshing	P. A-40
NX-TS2102			10 ms/Unit	0.01°C max.		P. A-41
NX-TS2104			60 ms/Unit	0.001°C max.		P. A-42
NX-TS2201		Resistance thermometer (Pt100/Pt1000, three-wire) ^{*2}	250 ms/Unit	0.1°C max.		P. A-43
NX-TS2202			10 ms/Unit	0.01°C max.		P. A-44
NX-TS2204			60 ms/Unit	0.001°C max.		P. A-45

*1. The resolution is 0.2°C max. when the input type is R, S, or W.

*2. The NX-TS2202 only supports Pt100 three-wire sensor.

Temperature Input Units (Screwless Clamping Terminal Block, 24 mm Width)

Model	Number of points	Input type	Conversion time	Resolution	I/O refreshing method	Reference
NX-TS3101	4 points	Thermocouple	250 ms/Unit	0.1°C max. ^{*1}	Free-Run refreshing	P. A-46
NX-TS3102			10 ms/Unit	0.01°C max.		P. A-47
NX-TS3104			60 ms/Unit	0.001°C max.		P. A-48
NX-TS3201		Resistance thermometer (Pt100/Pt1000, three-wire) ^{*2}	250 ms/Unit	0.1°C max.		P. A-49
NX-TS3202			10 ms/Unit	0.01°C max.		P. A-50
NX-TS3204			60 ms/Unit	0.001°C max.		P. A-51

*1. The resolution is 0.2°C max. when the input type is R, S, or W.

*2. The NX-TS3202 only supports Pt100 three-wire sensor.

1-4 List of Functions

This section provides an overview of functions that Analog I/O Units have.

Refer to the specifications of each model in *A-1 Data Sheet* on page A-2 for details on the functions.

1-4-1 Analog Input Units

Function name	Description	Reference
Free-Run Refreshing	With this I/O refreshing method, the refresh cycle of the NX bus and the I/O refresh cycles of the NX Units are asynchronous.	<i>5-2-4 Free-Run Refreshing</i> on page 5-4
Synchronous I/O Refreshing	With this I/O refreshing method, the timing to read inputs or to refresh outputs is synchronous on a fixed interval between more than one NX Unit on more than one Slave Terminal.	<i>5-2-5 Synchronous Input Refreshing</i> on page 5-9
Selecting Channel To Use	This function omits the conversion processing for unused inputs. It is used to reduce the conversion cycle for its own Unit.	<i>6-5-2 Selecting Channel To Use</i> on page 6-13
Moving Average	This function uses the average value of inputs of the set time as the converted value. When the input value fluctuates frequently due to noises, averaging can be used to obtain a stable converted value. This function can be used only for Free-Run refreshing.	<i>6-5-3 Moving Average</i> on page 6-19
Input Disconnection Detection	This function detects disconnections of the analog input signal lines. It can be used only for models with an input range of 4 to 20 mA.	<i>6-5-4 Input Disconnection Detection</i> on page 6-27
Over Range/Under Range Detection	This function detects when the input signal exceeds the range for which conversion is possible.	<i>6-5-5 Over Range/Under Range Detection</i> on page 6-28
User Calibration	This function corrects offsets in the converted values that occur due to the deterioration of the NX Units and calibrate the Units.	<i>6-5-6 User Calibration</i> on page 6-29

1-4-2 Analog Output Units

Function name	Description	Reference
Free-Run Refreshing	With this I/O refreshing method, the refresh cycle of the NX bus and the I/O refresh cycles of the NX Units are asynchronous.	<i>5-2-4 Free-Run Refreshing</i> on page 5-4
Synchronous I/O Refreshing	With this I/O refreshing method, the timing to read inputs or to refresh outputs is synchronous on a fixed interval between more than one NX Unit on more than one Slave Terminal.	<i>5-2-6 Synchronous Output Refreshing</i> on page 5-13
Selecting Channel To Use	This function omits the conversion processing for unused inputs. It is used to reduce the conversion cycle for its own Unit.	<i>7-5-2 Selecting Channel To Use</i> on page 7-10
Load Rejection Output Setting	A function that performs the preset output operation when the Analog Output Unit cannot receive output data due to a host error on the Communications Coupler Unit or an error on the NX bus.	<i>7-5-3 Load Rejection Output Setting</i> on page 7-15
Over Range/Under Range Detection	This function detects when the output set value exceeds the range for which conversion is possible.	<i>7-5-4 Over Range/Under Range Detection</i> on page 7-21
User Calibration	This function corrects offsets in the converted values that occur due to the deterioration of the NX Units and calibrate the Units.	<i>7-5-5 User Calibration</i> on page 7-22

1-4-3 Temperature Input Units

Function name	Description	Reference
Free-Run Refreshing	With this I/O refreshing method, the refresh cycle of the NX bus and the I/O refresh cycles of the NX Units are asynchronous.	5-2-4 <i>Free-Run Refreshing</i> on page 5-4
Selecting Channel To Use	This function disables errors in unused channels. The conversion time for its own Unit will not be shortened even if errors are disabled.	8-5-3 <i>Selecting Channel To Use</i> on page 8-22
Moving Average	This function uses the average value of inputs of the set time as the measured value. When the input value fluctuates frequently due to noises, averaging can be used to obtain a stable measured value.	8-5-4 <i>Moving Average</i> on page 8-27
Sensor Disconnection Detection	This function detects disconnections of sensors that are connected to the input terminals.	8-5-5 <i>Sensor Disconnection Detection</i> on page 8-32
Over Range/Under Range Detection	This function detects when the measured value exceeds the range for which temperature conversion is possible.	8-5-6 <i>Over Range/Under Range Detection</i> on page 8-33
Cold Junction Compensation Enable/Disable Setting	This function enables or disables the cold junction compensation for thermocouple inputs. Enable this function normally.	8-5-7 <i>Cold Junction Compensation Enable/Disable Setting</i> on page 8-34
Temperature Unit Setting (°C/°F)	This function sets °C (celsius) or °F (fahrenheit) as the temperature unit for measured values.	8-5-8 <i>Temperature Unit (°C/°F) Setting</i> on page 8-39
Input Correction	This function corrects measured values. It is used when there is a noticeable variation from values measured with other gauges. One-point correction and two-point correction methods are provided.	8-5-9 <i>Input Correction</i> on page 8-44
Decimal Point Position Setting	This function sets the number of digits which is displayed after the decimal point when measured values are INT and DINT data.	8-5-10 <i>Decimal Point Position Setting</i> on page 8-51

1-5 Support Software

The following table shows the Support Software that can perform the settings of the Slave Terminal.

1-5-1 Applicable Support Software

Support Software	Version
Sysmac Studio	Ver. 1.06 or higher

Note Refer to *A-5 Version Information* on page A-95 for information on the versions that are supported for each NX Unit model.

Refer to the user's manual of the Communications Coupler Unit for details on connections.



Specifications

This section describes the general specifications and individual specifications of Analog I/O Units.

2-1	General Specifications	2-2
2-2	Individual Specifications	2-3

2-1 General Specifications

General specifications of Analog I/O Units are shown below.

Item		Specification
Enclosure		Mounted in a panel
Grounding methods		Ground of 100 Ω or less
Operating environment	Ambient operating temperature	0 to 55°C
	Ambient operating humidity	10 to 95% RH (with no icing or condensation)
	Atmosphere	Must be free from corrosive gases.
	Ambient storage temperature	-25 to 70°C (with no icing or condensation)
	Altitude	2,000 m max.
	Pollution degree	Pollution degree 2 or less: Conforms to JIS B3502 and IEC 61131-2.
	Noise immunity	Conforms to IEC61000-4-4, 2 kV (power supply line)
	Overvoltage category	Category II: Conforms to JIS B3502 and IEC 61131-2.
	EMC immunity level	Zone B
	Vibration resistance	Conforms to IEC60068-2-6. 5 to 8.4 Hz with amplitude of 3.5 mm, 8.4 to 150 Hz, acceleration of 9.8 m/s ² 100 min each in X, Y, and Z directions (10 sweeps of 10 min each = 100 min total)
	Shock resistance	Conforms to IEC60068-2-27, 147 m/s ² , 3 times each in X, Y, and Z directions
	Insulation resistance	*1
Dielectric strength	*1	
Applicable standards*2		cULus: Listed (UL508), ANSI/ISA 12.12.01, EC: EN61131-2, C-Tick, KC: KC Registration, NK, LR

*1. Varies with NX Unit Models. Refer to *A-1 Data Sheet* on page A-2 for the specifications of individual NX Units.

*2. Refer to the OMRON website (www.ia.omron.com) or ask your OMRON representative for the most recent applicable standards for each model.

2-2 Individual Specifications

Refer to *A-1 Data Sheet* on page A-2 for the specifications of individual Analog I/O Units.

3

Part Names and Functions

This section describes the names and functions of the Analog I/O Unit parts.

3-1 Part Names	3-2
3-1-1 Screwless Clamping Terminal Block Type	3-2
3-2 Indicators	3-9
3-2-1 TS Indicator	3-10

3-1 Part Names

This section describes the names and functions of the Analog I/O Unit parts.

3-1-1 Screwless Clamping Terminal Block Type

NX Units Other Than Thermocouple Temperature Input Unit

- 12 mm Width

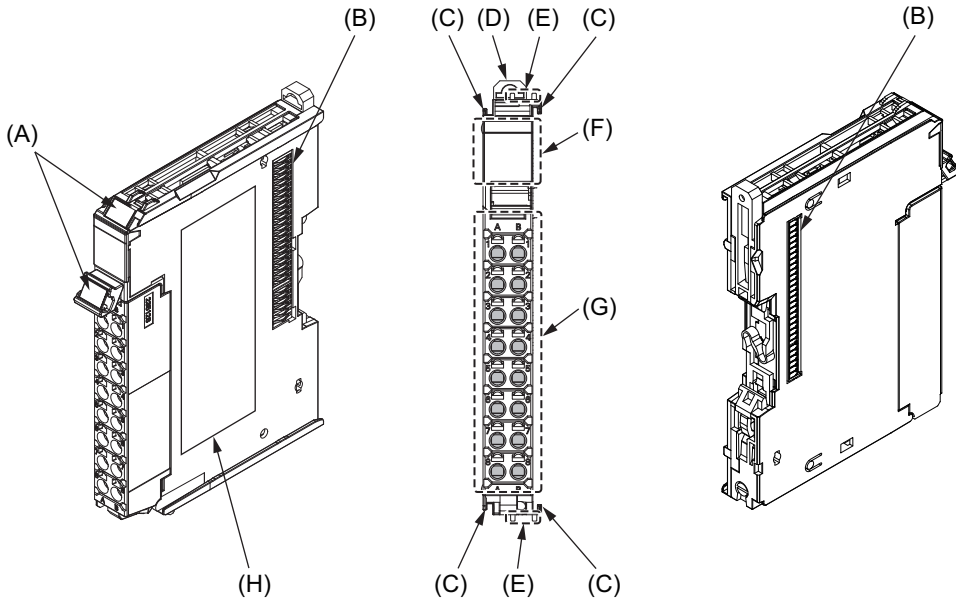

- 24 mm Width

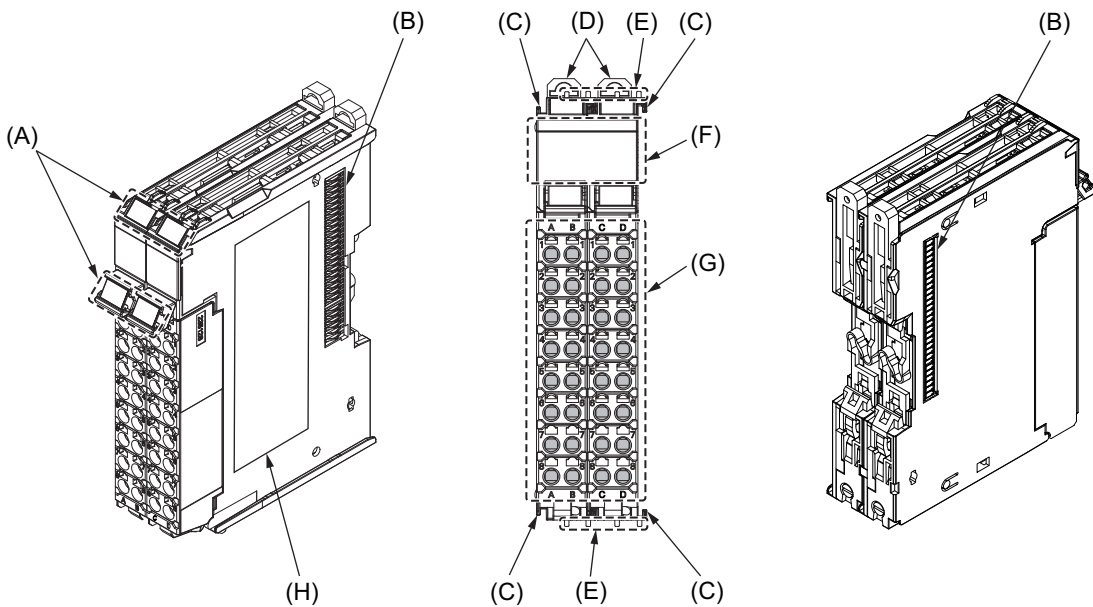

Letter	Name	Function
(A)	Marker attachment locations	The locations where markers are attached. The markers made by OMRON are installed for the factory setting. Commercially available markers can also be installed. Refer to <i>4-1-2 Attaching Markers</i> on page 4-4
(B)	NX bus connector	This connector is used to connect each Unit.
(C)	Unit hookup guides	These guides are used to connect two Units.
(D)	DIN Track mounting hooks	These hooks are used to mount the NX Unit to a DIN Track.
(E)	Protrusions for removing the Unit	The protrusions to hold when removing the Unit.
(F)	Indicators	The indicators show the current operating status of the Unit. Refer to <i>3-2 Indicators</i> on page 3-9
(G)	Terminal block	The terminal block is used to connect external devices. The number of terminals depends on the type of Unit.
(H)	Unit specifications	The specifications of the Unit are given.

Thermocouple Temperature Input Units

● 12 mm Width

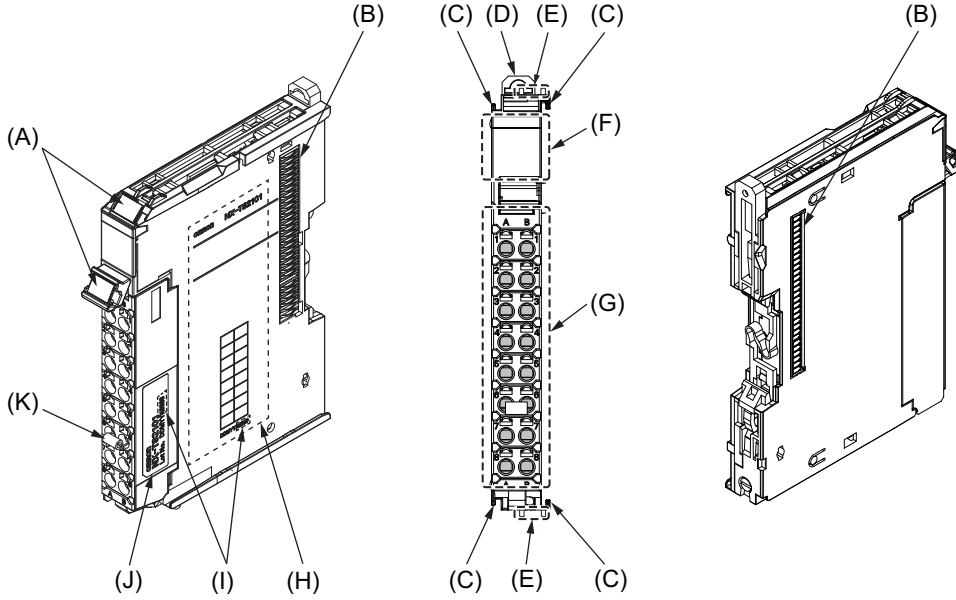

● 24 mm Width

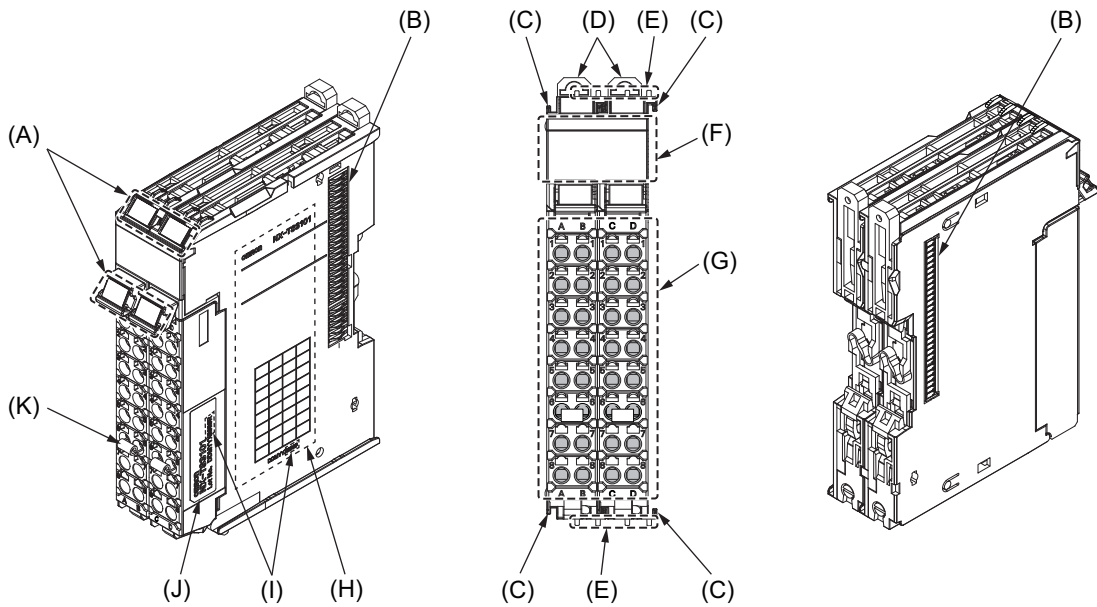

Letter	Name	Function
(A)	Marker attachment locations	The locations where markers are attached. The markers made by OMRON are installed for the factory setting. Commercially available markers can also be installed. Refer to <i>4-1-2 Attaching Markers</i> on page 4-4
(B)	NX bus connector	This connector is used to connect each Unit.
(C)	Unit hookup guides	These guides are used to connect two Units.
(D)	DIN Track mounting hooks	These hooks are used to mount the NX Unit to a DIN Track.
(E)	Protrusions for removing the Unit	The protrusions to hold when removing the Unit.
(F)	Indicators	The indicators show the current operating status of the Unit. Refer to <i>3-2 Indicators</i> on page 3-9
(G)	Terminal block	The terminal block is used to connected external devices. The number of terminals depends on the type of Unit.
(H)	Unit specifications	The specifications of the Unit are given.
(I)	Calibration control number	The calibration control number is used to guarantee overall accuracy. The overall accuracy is guaranteed by using the terminal block and the Unit as a set that have the same calibration control number. Refer to <i>Precaution for Installing Temperature Input Units (Thermocouple Input Type)</i> on page 4-27
(J)	Calibration control number label	The label attached on the terminal block with a calibration control number written on it. With 24 mm wide models, the labels are attached on both left and right terminal blocks. "L" or "R" is appended at the end of the calibration control number to identify left or right.
(K)	Cold junction sensor	This sensor is used to perform the cold junction compensation. The sensors are mounted on both left and right terminal blocks for models with 24 mm width.

Terminal Blocks

There are two models of Screwless Clamping Terminal Blocks: NX-TB□□□2 and NX-TB□□□1. Each model has three types of terminal blocks: 8-terminal type, 12-terminal type, and 16-terminal type.

● NX-TB□□□2

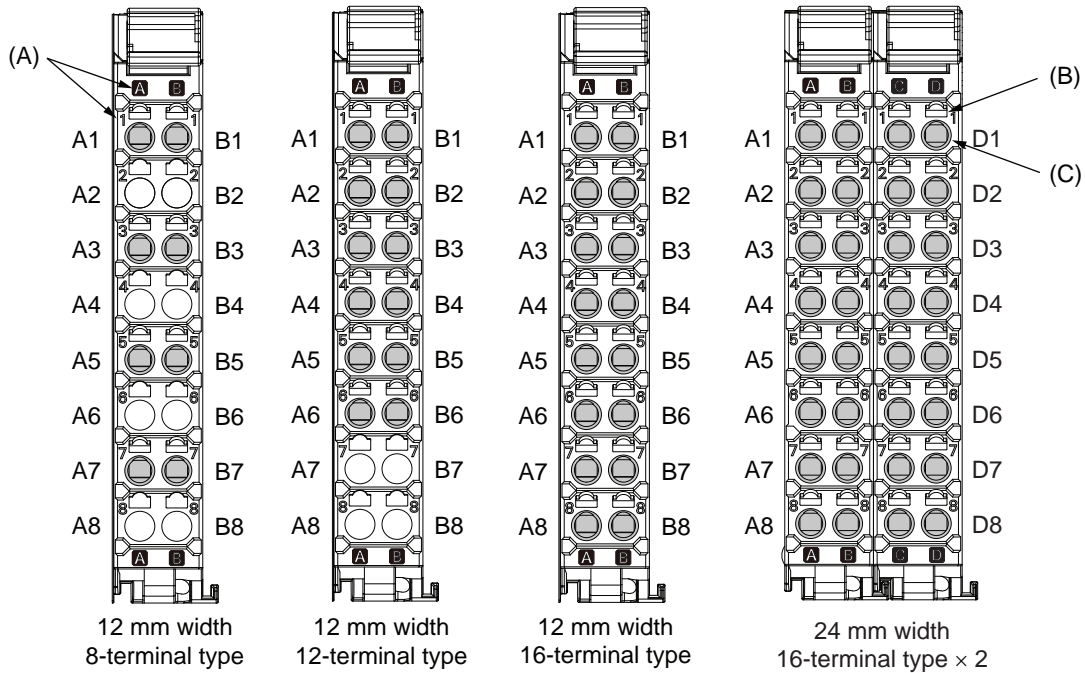

● NX-TB□□□1

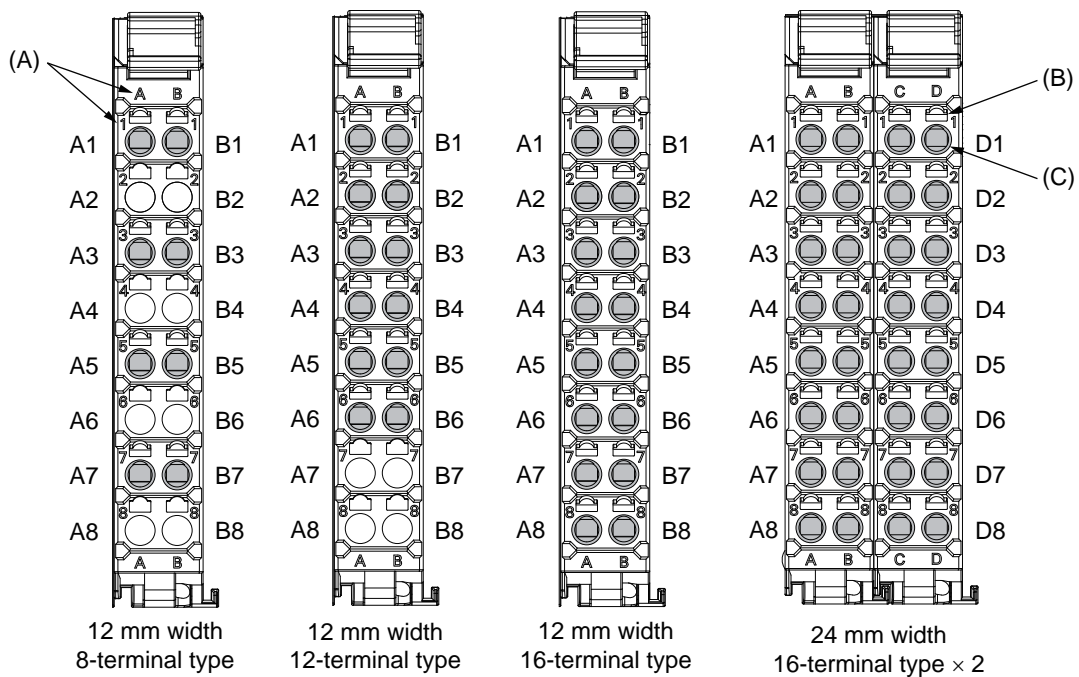

Letter	Name	Function
(A)	Terminal number indications	Terminal numbers for which A to D indicate the column, and 1 to 8 indicate the line are displayed. The terminal number is a combination of column and line, i.e. A1 to A8 and B1 to B8. For models of 24 mm width, A1 to A8 and B1 to B8 are terminal number of the left terminal block, C1 to C8 and D1 to D8 are terminal numbers of the right terminal block. The terminal number indications are the same regardless of the number of terminals on the terminal block.
(B)	Release holes	Insert a flat-blade screwdriver into these holes to connect and remove the wires.
(C)	Terminal holes	The wires are inserted into these holes.

The NX-TB□□□2 and NX-TB□□□1 Terminal Blocks have different terminal current capacities. The NX-TB□□□2 has 10 A and NX-TB□□□1 has 4 A.

To differentiate between the two models of Terminal Blocks, use the terminal number column indications. The Terminal Block with white letters on a dark background is the NX-TB□□□2.

You can mount either NX-TB□□□1 or NX-TB□□□2 Terminal Blocks to the Units that the current capacity specification of the terminals is 4 A or less.

You can only mount the NX-TB□□□2 Terminal Block to the Units that the current capacity specification of the terminals is greater than 4 A.



Additional Information

- Each Analog I/O Unit is compatible with only one of three types of terminal blocks. You cannot use a terminal block with a number of terminals that differs from the specifications for a particular Unit.
- The 8-terminal type and 12-terminal type do not have terminal holes and release holes for following terminal numbers.

8-terminal type: A2, A4, A6, A8, B2, B4, B6, and B8

12-terminal type: A7, A8, B7, and B8

● Applicable Terminal Blocks for Each Unit Model

The following indicates the Terminal Blocks that are applicable to each Unit.

Unit model number	Terminal Block				
	Model	Number of terminals	Ground terminal	Current capacity	
NX-AD2□□□	NX-TBA081	8	Not provided	4 A	
	NX-TBA082			10 A	
NX-AD3□□□	NX-TBA121	12		4 A	
	NX-TBA122			10 A	
NX-AD4□□□	NX-TBA161	16		4 A	
	NX-TBA162			10 A	
NX-DA2□□□	NX-TBA081	8		4 A	
	NX-TBA082			10 A	
NX-DA3□□□	NX-TBA121	12		4 A	
	NX-TBA122			10 A	
NX-TS21□□	You cannot replace the Terminal Blocks.				
NX-TS31□□	Refer to <i>Precaution for Installing Temperature Input Units (Thermocouple Input Type)</i> on page 4-27.				
NX-TS22□□	NX-TBA161	16		Not provided	4 A
	NX-TBA162				10 A
NX-TS32□□	NX-TBA161	16	4 A		
	NX-TBB161		10 A		
	NX-TBA162				
	NX-TBB162				



Precautions for Correct Use

You can mount either NX-TB□□□1 or NX-TB□□□2 Terminal Blocks to the Units that the current capacity specification of the terminals is 4 A or less.

However, even if you mount the NX-TB□□□2 Terminal Block, the current specification does not change because the current capacity specification of the terminals on the Units is 4 A or less.

Refer to *A-4 List of Terminal Block Models* on page A-94 for information on the models of Terminal Blocks.

3-2 Indicators

There are the indicators to show the current operating status of the Unit or the signal I/O status on the Analog I/O Units.

The following indicator patterns are available depending on width of the Unit.

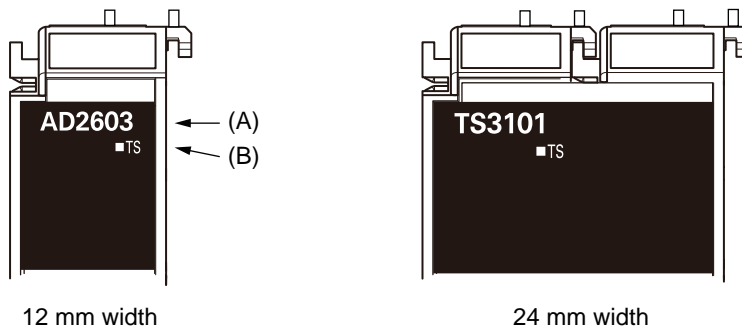

Let-ter	Name	Function
(A)	Model number indications	<p>The model numbers of the NX Unit are displayed. (Example) "AD2603" in the case of NX-AD2603</p> <p>The NX Units are separated in the following color depending on the type of inputs and outputs.</p> <ul style="list-style-type: none"> • Analog Input Unit/Temperature Input Unit: Orange • Analog Output Unit: Yellow
(B)	TS indicator	The indicator shows the current operating status of the NX Unit.



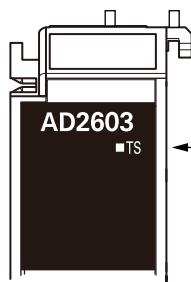

The following section describes the specifications of the TS indicator.

3-2-1 TS Indicator



This indicator shows the current status of the Analog I/O Unit and its communication status with the Communications Coupler Unit.

The meanings of light statuses are described as follows:

Color	Status	Description
Green		Lit The Unit is operating normally. The Unit is ready for I/O refreshing.
		Flashing at 2-s intervals. <ul style="list-style-type: none"> • Initializing • Restarting is in progress for the Unit. • Downloading
Red		Lit A hardware failure, WDT error, or other fatal error that is common to all I/O Units occurred.
		Flashing at 1-s intervals. A communications error or other NX bus-related error that is common to all I/O Units occurred.
-		Not lit <ul style="list-style-type: none"> • No Unit power supply • Restarting is in progress for the Slave Terminal. • Waiting for initialization to start

4

Installation and Wiring

This section describes how to install the NX Units, the types of power supplies used in the Slave Terminal, their wiring methods, and how to wire the NX Units.

4-1	Installing NX Units	4-2
4-1-1	Installing NX Units	4-2
4-1-2	Attaching Markers	4-4
4-1-3	Removing NX Units	4-5
4-1-4	Installation Orientation	4-7
4-2	Wiring the Power Supply to the Slave Terminal	4-8
4-2-1	Power Supply Types	4-8
4-2-2	Supplying Each Power Supply and Wiring	4-9
4-2-3	Calculating the Total Current Consumption from I/O Power Supply	4-11
4-2-4	Power Supply-related Units for the NX-series	4-12
4-3	Wiring the Terminals	4-15
4-3-1	Wiring to the Screwless Clamping Terminal Block	4-15
4-3-2	Checking the Wiring	4-33
4-4	Wiring Examples	4-34
4-4-1	Wiring the Analog Input Units	4-34
4-4-2	Wiring the Analog Output Units	4-36
4-4-3	Wiring the Temperature Input Units	4-37
4-4-4	Precautions when Using Common Power Supply for Input Devices of Analog Input Units	4-38

4-1 Installing NX Units

This section describes how to install NX Units.

Refer to the user's manual of the Communications Coupler Unit for information on preparations of installation and installation in a control panel.

4-1-1 Installing NX Units

This section describes how to mount two NX Units to each other.

Always turn OFF the power supply before you mount NX Units.

Always mount NX Units one at a time. If you attempt to mount multiple NX Units that are already connected together, the connections between the NX Units may separate from each other and fall.



Precautions for Correct Use

- Do not apply labels or tape on the NX Units. When the Unit is installed or removed, adhesive or scrap may adhere to the pins of the NX bus connector, which may cause malfunctions.
- Do not write with ink or soil within the prohibited region that is shown in the following figure. When the Unit is installed or removed, ink or dirt may adhere to the pins of the NX bus connector, which may cause malfunctions in the Slave Terminal.

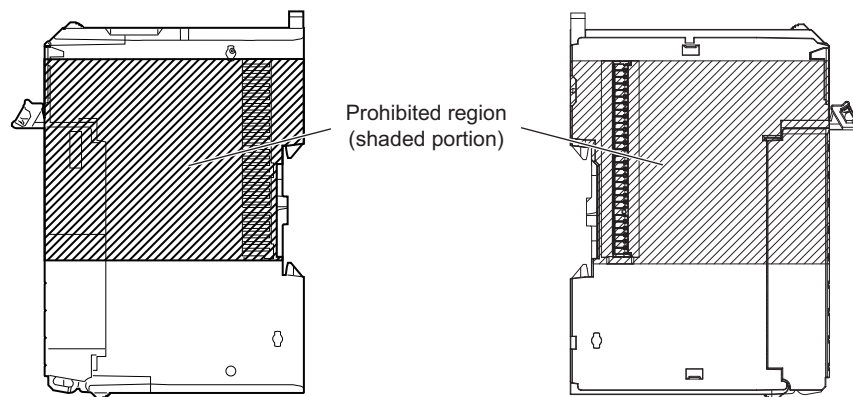

Precautions for Correct Use

- When you install an NX Unit, do not touch or bump the pins in the NX bus connector.
- When you handle an NX Unit, be careful not to apply any stress to the pins in the NX bus connector. If you install an NX Unit and turns ON the power supply when the pins in the NX bus connector are deformed, a contact defect may cause malfunctions.

- 1 From the front of the previously mounted NX Unit, engage the Unit hookup guides on a new Unit with the Unit hookup guides on the previously mounted NX Unit.

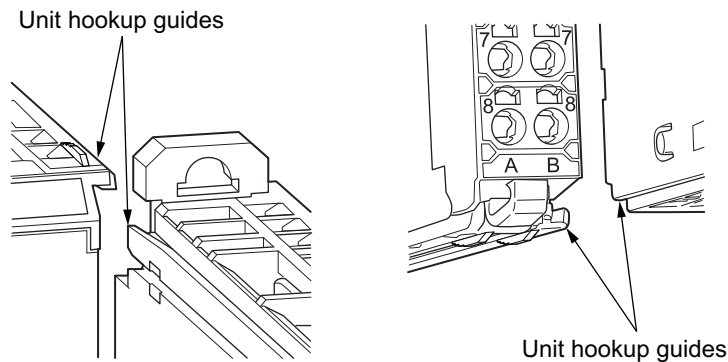

- 2 Slide the NX Unit in on the hookup guides.

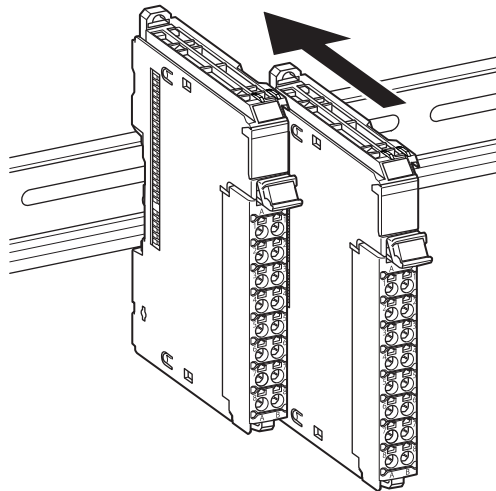

- 3 Press the NX Unit with a certain amount of force against the DIN Track until you hear the DIN Track mounting hook lock into place.

When you mount the NX Unit, it is not necessary to release the DIN track mounting hook on the NX Unit.

After you mount the NX Unit, make sure that it is locked to the DIN Track.



Additional Information

- Normally, it is not necessary to release the DIN track mounting hook when you mount the NX Unit. However, if you mount the NX Unit on a DIN Track that is not a recommended DIN Track, the DIN track mounting hook may not lock correctly. If that happens, first unlock the DIN track mounting hook, mount the NX Unit to the DIN Track, then lock the DIN track mounting hook.
- Refer to the user's manual of the Communications Coupler Unit for information on how to mount the Communications Coupler Unit, and how to mount the NX Unit to the Communications Coupler Unit.

4-1-2 Attaching Markers

Markers can be attached to the NX Units and terminal blocks on NX Units to identify them.

The plastic markers made by OMRON are installed for the factory setting. The ID information can be written on them.

Commercially available markers can also be installed.

Replace the markers made by OMRON if you use commercially available markers now.

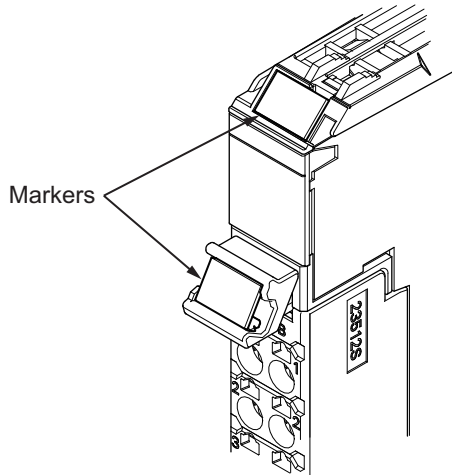

● Installation Method

Insert the protrusions on the markers into the marker attachment locations on the NX Units and terminal blocks on NX Units.

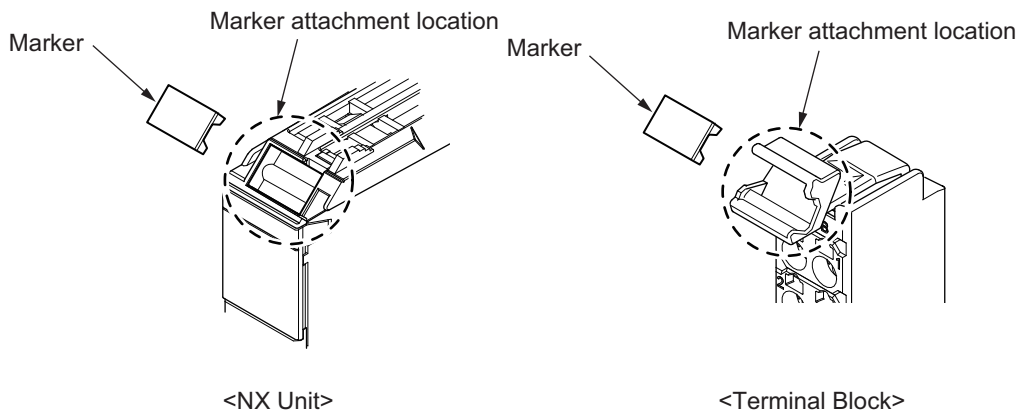

● Commercially Available Markers

Commercially available markers are made of plastic and can be printed on with a special printer. To use commercially available markers, purchase the following products.

Product name	Model number	
	Manufactured by Phoenix Contact	Manufactured by Weidmuller
Markers	UC1-TMF8	DEK 5/8
Special marker printer	UM EN BLUEMARK X1	PrintJet PRO

The markers made by OMRON cannot be printed on with commercially available special printers.

4-1-3 Removing NX Units



Precautions for Safe Use

Always turn OFF the Unit power supply and I/O power supply before you remove the NX Unit.

- 1 Use a flat-blade screwdriver to pull up the DIN Track mounting hook on the Unit to remove.

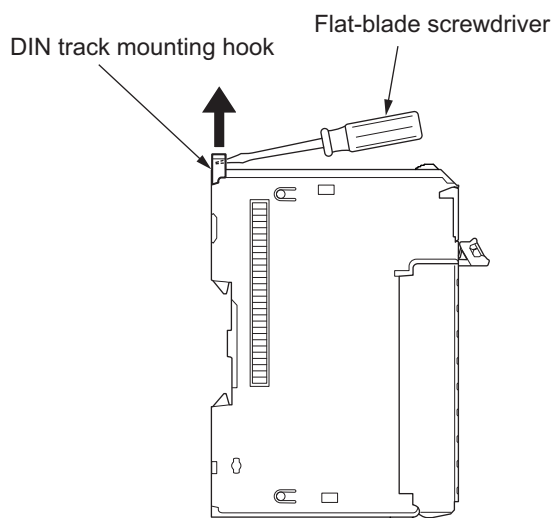

- 2** Put your fingers on the protrusions for removing multiple NX Units including the Unit to be removed, then pull out straight forward to remove.

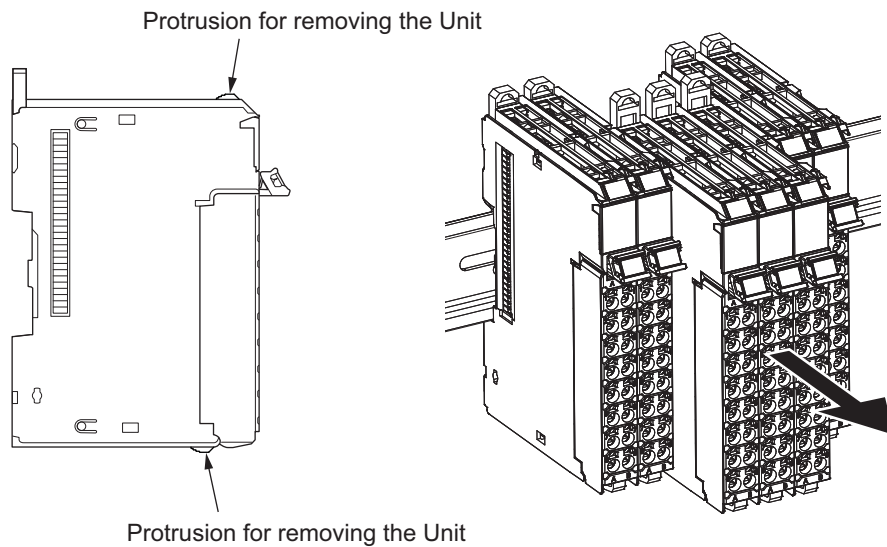

Precautions for Correct Use

- When removing an NX Unit, remove multiple Units together which include the one you want to remove. If you attempt to remove only one Unit, it is stuck and hard to pull out.
 - Do not unlock the DIN track mounting hooks on all of the NX Units at the same time. If you unlock the DIN Track mounting hooks on all of the NX Units at the same time, all of the Units may come off.
-

4-1-4 Installation Orientation

Orientation is possible in the following six directions.

(A) is the upright orientation and (B) to (F) are other orientations.

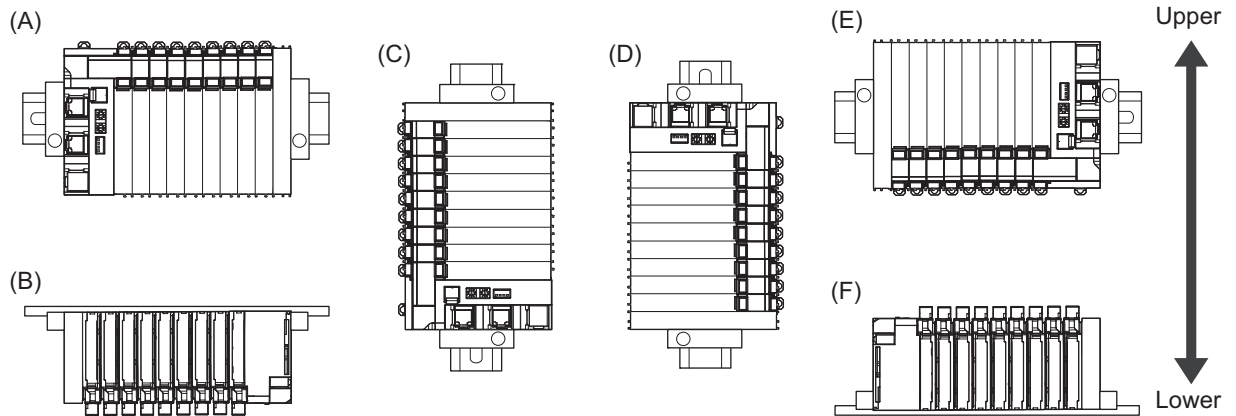

However, there are restrictions on the installation orientation and restrictions to the specifications that can result from the Communications Coupler Units and NX Units that are used.

Refer to the user's manuals for the Communications Coupler Units, NX Units and System Units that you will use for details on restrictions.



Precautions for Safe Use

For installation orientations (C) and (D) in the above figure, support the cables, e.g., with a duct, so that the End Plate on the bottom is not subjected to the weight of the cables. The weight of the cables may cause the bottom End Plate to slide downward so that the Slave Terminal is no longer secured to the DIN Track, which may cause malfunctions.

4-2 Wiring the Power Supply to the Slave Terminal

This section describes how to supply power to the Slave Terminal and wiring.

4-2-1 Power Supply Types

There are the following two types of power supplies that supply power to the Slave Terminal.

Power supply name	Description
Unit power supply	<p>This is the power supply for generating the NX Unit power supply required for the Slave Terminal to operate.</p> <p>This is connected to the Unit power supply terminal on the Communications Coupler Unit or on the Additional NX Unit Power Supply Unit.</p> <p>The internal power supply circuit in the Communications Coupler Unit or the Additional NX Unit Power Supply Unit generates the NX Unit power supply from the Unit power supply.</p> <p>The internal circuits of the Communications Coupler Unit and NX Units operate by the NX Unit power supply.</p> <p>The NX Unit power supply is supplied to the NX Units in the Slave Terminal through the NX bus connectors.</p>
I/O power supply	<p>This power supply is used for driving the I/O circuits of the NX Units and for the connected external devices.</p> <p>This is connected to the I/O power supply terminal on the Communications Coupler Unit or the Additional I/O Power Supply Unit.</p> <p>The I/O power supply is supplied to the NX Units from the I/O power supply terminals and through the NX bus connectors.</p>

4-2-2 Supplying Each Power Supply and Wiring

The supply method for each power supply to the NX Units is as follows.

Power supply name	Description
NX Unit power supply	This power is supplied to the NX Units through the NX bus connectors by connecting a Unit power supply to the Unit power supply terminals on the Communications Coupler Unit or Additional NX Unit Power Supply Units.
I/O power supply	<p>This power is supplied by one of the following two methods.</p> <p>Refer to <i>A-1 Data Sheet</i> on page A-2 for the supply method of each NX Unit.</p> <ul style="list-style-type: none"> • Supply from the NX bus This power is supplied through the NX bus connectors by connecting an I/O power supply to the I/O power supply terminals on the Communications Coupler Unit or Additional I/O Power Supply Units. • Supply from external source This power is supplied to the Units from an external source. I/O power is supplied by connecting an I/O power supply to the I/O power supply terminals on the Units.

The following are wiring diagrams (examples) for each power supply.

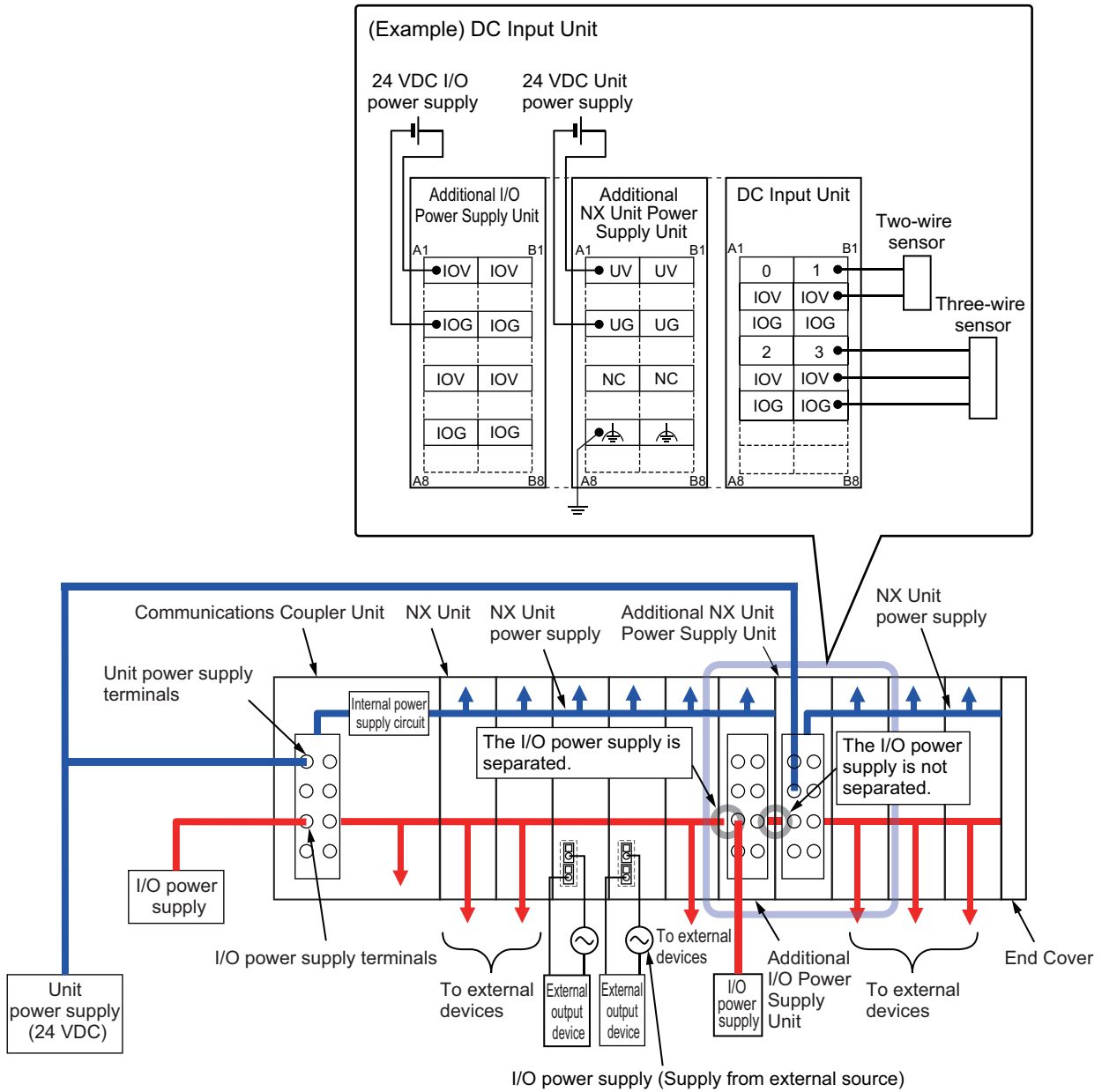

Precautions for Correct Use

Always use separate power supplies for the Unit power supply and the I/O power supply. If you supply power from the same power supply, noise may cause malfunctions.



Additional Information

Refer to the user's manual for the Communications Coupler Unit on design for power supply to the Slave Terminal.

4-2-3 Calculating the Total Current Consumption from I/O Power Supply

The total current consumption of I/O power supplied from the NX bus must be within the range of the maximum I/O power supply current of the Communications Coupler Unit or the Additional I/O Power Supply Unit.

To confirm this and to calculate the I/O power supply capacity, calculate the total current consumption from I/O power supply from the NX bus.

The total current consumption from I/O power supply from the NX bus is the total sum of current consumption from I/O power supply of the NX Unit that supplies the I/O power from the NX bus, the current of each applicable I/O circuit, and current consumption of any connected external devices.

Note that the current consumption from I/O power supply indicated in the data sheet for each Unit type does not include the load current of any external connection load and current consumption of any connected external devices.

The total current consumption from I/O power supply of the Analog I/O Units is calculated as follows.

- **Total Current Consumption from I/O Power Supply of the Analog Input Units**
= (Current consumption from I/O power supply of the Analog Input Units) + (Total current consumption of connected external devices)
- **Total Current Consumption from I/O Power Supply of the Analog Output Units**
= (Current consumption from I/O power supply of the Analog Output Units) + (Total current consumption of connected external devices)

Refer to *A-1 Data Sheet* on page A-2 for the current consumption from I/O power supply for each Analog I/O Unit model.

4-2-4 Power Supply-related Units for the NX-series

A Communications Coupler Unit supplies the NX Unit power supply and I/O power supply to the NX Units in the Slave Terminal.

There are the following types of NX-series power supply-related Units other than Communications Coupler Units.

Refer to the *NX-series System Unit User's Manual* (Cat. No. W523) for details on NX-series power supply-related Units.

Refer to NX-series catalogs or OMRON websites, or ask your OMRON representative for information on the most recent lineup of NX Units.

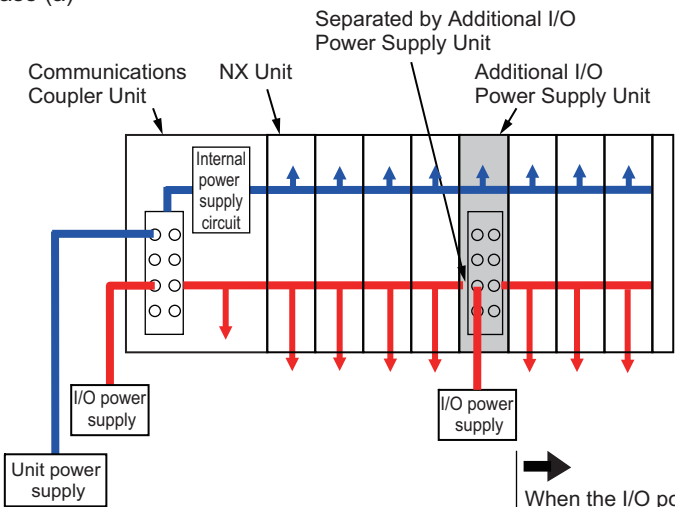
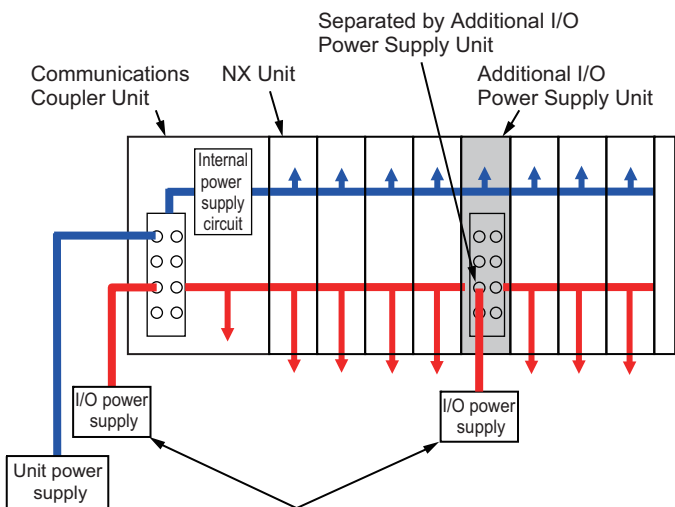

Unit name	Function
<p>Additional NX Unit Power Supply Unit</p>	<p>This NX Unit provides NX Unit power supply.</p> <p>This NX Unit is used when the total power consumption of the NX Units in the Slave Terminal exceeds the NX Unit power supply capacity of the Communications Coupler Unit.</p> <div style="text-align: center;"> <p>The diagram illustrates the power supply configuration. On the left, a 'Unit power supply' is connected to the 'Unit power supply terminals' of a 'Communications Coupler Unit'. This unit provides power to the first 'NX Unit' and an 'Additional NX Unit Power Supply Unit'. The 'Additional NX Unit Power Supply Unit' has its own 'I/O power supply' connected to the 'NX Unit on the left through the NX bus connector'. The 'Additional NX Unit Power Supply Unit' provides power to the remaining 'NX Units'. Dashed arrows indicate that the total power consumption from the NX Unit power supply is within the capacity of both the Communications Coupler Unit and the Additional NX Unit Power Supply Unit.</p> </div> <p>The I/O power supply for the Additional NX Unit Power Supply Unit is connected to the NX Unit on the left through the NX bus connector.</p>

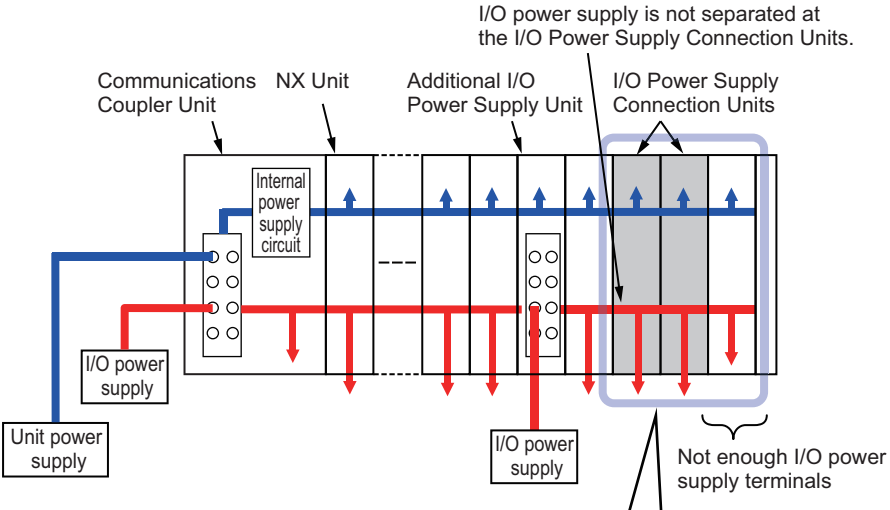
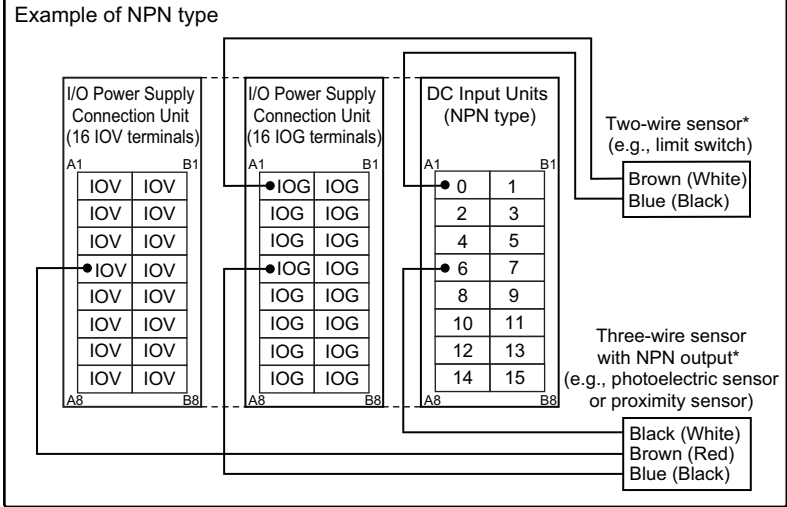
Unit name	Function
<p>Additional I/O Power Supply Unit</p>	<p>This NX Unit provides additional I/O power supply. Use this NX Unit in the following cases.</p> <p>(a) When the I/O power supply capacity is insufficient</p> <ul style="list-style-type: none"> • When the total current consumption for the I/O power supply exceeds the maximum current of I/O power supply of the Communications Coupler Unit • When a voltage drop in the I/O power supply causes the voltage of the I/O power supply to go below the voltage specifications of the I/O circuits or connected external devices <p>(b) Separating the I/O power supply</p> <ul style="list-style-type: none"> • When connected external devices have different I/O power supply voltages • When separating the power supply systems <p>Case (a)</p>  <p>Separated by Additional I/O Power Supply Unit</p> <p>Communications Coupler Unit NX Unit Additional I/O Power Supply Unit</p> <p>Internal power supply circuit</p> <p>I/O power supply I/O power supply</p> <p>Unit power supply</p> <p>When the I/O power supply becomes the following states for the subsequent NX Units.</p> <ul style="list-style-type: none"> - When it exceeds the maximum current of I/O power supply - When it goes below the voltage specifications of the connected external devices <p>Case (b)</p>  <p>Separated by Additional I/O Power Supply Unit</p> <p>Communications Coupler Unit NX Unit Additional I/O Power Supply Unit</p> <p>Internal power supply circuit</p> <p>I/O power supply I/O power supply</p> <p>Unit power supply</p> <ul style="list-style-type: none"> - When different I/O power supply voltage are used. - When separating the power supply systems. <p>The NX Unit power supply of the Additional I/O Power Supply Unit is connected to the NX Unit on the left through the NX bus connector.</p>

Unit name	Function
<p>I/O Power Supply Connection Unit</p>	<p>This NX Unit is used when there are not enough I/O power supply terminals for the connected external devices that are connected to NX Units such as Digital I/O Units and Analog I/O Units.</p>  <p>I/O power supply is not separated at the I/O Power Supply Connection Units.</p> <p>Communications Coupler Unit NX Unit Additional I/O Power Supply Unit I/O Power Supply Connection Units</p> <p>Internal power supply circuit</p> <p>I/O power supply</p> <p>Unit power supply</p> <p>I/O power supply</p> <p>Not enough I/O power supply terminals</p> <p>Example of NPN type</p>  <p>I/O Power Supply Connection Unit (16 IOV terminals)</p> <p>I/O Power Supply Connection Unit (16 IOG terminals)</p> <p>DC Input Units (NPN type)</p> <p>Two-wire sensor* (e.g., limit switch)</p> <p>Brown (White) Blue (Black)</p> <p>Three-wire sensor with NPN output* (e.g., photoelectric sensor or proximity sensor)</p> <p>Black (White) Brown (Red) Blue (Black)</p> <p>* Wire colors have been changed according to revisions in the JIS standards for photoelectric and proximity sensors. The colors in parentheses are the wire colors prior to the revisions.</p>

4-3 Wiring the Terminals

This section describes how to wire the terminals on the Analog I/O Units.

 WARNING	
	<p>Make sure that the voltages and currents that are input to the Units and slaves are within the specified ranges.</p> <p>Inputting voltages or currents that are outside of the specified ranges may cause accidents or fire.</p>

4-3-1 Wiring to the Screwless Clamping Terminal Block

This section describes how to connect wires to the screwless clamping terminal block, the installation and removing methods, and functions for preventing incorrect attachment.

You can connect ferrules that are attached to the twisted wires to the screwless clamping terminal block. You can also connect the twisted wires or the solid wires to the screwless clamping terminal block. If you connect the ferrules, all you need to do to connect the wires is to insert the ferrules into the terminal holes.

Wiring Terminals

The terminals to be wired are as follows.

- I/O power supply terminals
- I/O terminals

Applicable Wires

The wires that you can connect to the screwless clamping terminal block are twisted wires, solid wires, and ferrules that are attached to the twisted wires. The following section describes the dimensions and processed methods for applicable wires.

● Dimensions of Wires Connected to the Terminal Block

The dimensions of wires that you can connect into the terminal holes of the screwless clamping terminal block are as in the figure below.

Process the applicable wires that are specified in the following description to apply the dimensions.

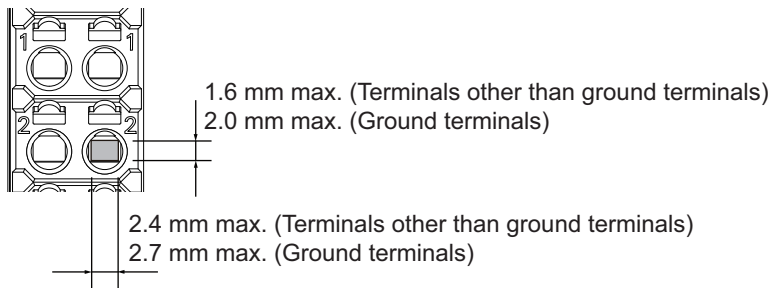

● Using Ferrules

If you use ferrules, attach the twisted wires to them.

Observe the application instructions for your ferrules for the wire stripping length when attaching ferrules.

Always use one-pin ferrules. Do not use two-pin ferrules.

The applicable ferrules, wires, and crimping tools are listed in the following table.

Terminal types	Manufacturer	Ferrule model	Applicable wire (mm ² (AWG))	Crimping tool
Terminals other than ground terminals	Phoenix Contact	AI0,34-8	0.34 (#22)	Phoenix Contact (The figure in parentheses is the applicable wire size.) CRIMPFOX 6 (0.25 to 6 mm ² , AWG24 to 10)
		AI0,5-8	0.5 (#20)	
		AI0,5-10		
		AI0,75-8	0.75 (#18)	
		AI0,75-10		
		AI1,0-8	1.0 (#18)	
		AI1,0-10		
		AI1,5-8	1.5 (#16)	
Ground terminals		AI2,5-10	2.0 *1	
Terminals other than ground terminals	Weidmuller	H0.14/12	0.14 (#26)	Weidmuller (The figure in parentheses is the applicable wire size.) PZ6 Roto (0.14 to 6 mm ² , AWG26 to 10)
		H0.25/12	0.25 (#24)	
		H0.34/12	0.34 (#22)	
		H0.5/14	0.5 (#20)	
		H0.5/16		
		H0.75/14	0.75 (#18)	
		H0.75/16		
		H1.0/14	1.0 (#18)	
		H1.0/16		
		H1.5/14	1.5 (#16)	
		H1.5/16		

*1. Some AWG14 wires exceed 2.0 mm² and cannot be used in the screwless clamping terminal block.

When you use any ferrules other than those in the above table, crimp them to the twisted wires so that the following processed dimensions are achieved.

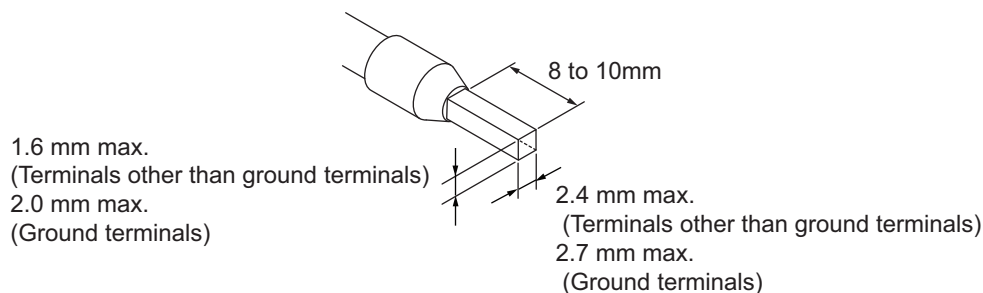

● **Using Twisted Wires/Solid Wires**

If you use the twisted wires or the solid wires, the applicable wire range and conductor length (stripping length) are as follows.

Terminal types	Applicable wire range	Conductor length (stripping length)
Ground terminals*1	2.0 mm ²	9 to 10 mm
Terminals other than ground terminals	0.08 to 1.5 mm ² AWG28 to 16	8 to 10 mm

*1. When you use the NX-TB□□□1 Terminal Block, use twisted wires to connect the ground terminal. Do not use solid wires.

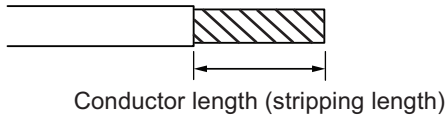

Precautions for Correct Use

- Use cables with suitable wire sizes for the carrying current. There are also restrictions on the current due to the ambient temperature. Refer to the manuals for the cables and use the cables correctly for the operating environment.
- For twisted wires, strip the sheath and twist the conductor portion. Do not unravel or bend the conductor portion of twisted wires or solid wires.

NG

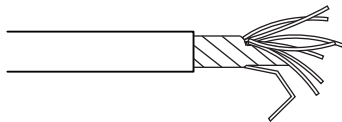

Unravel wires

NG

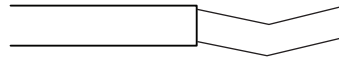

Bend wires

Connecting/Removing Wires

This section describes how to connect and remove wires.

● Terminal Block Parts and Names

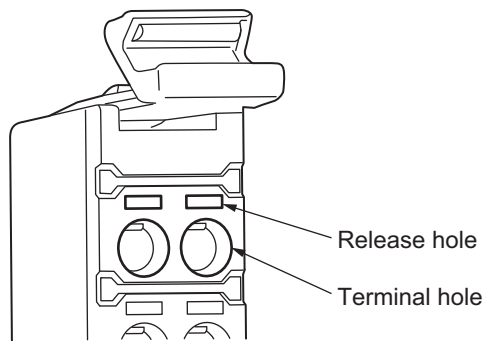

● Required Tools

Use a flat-blade screwdriver to connect and remove wires.

Use the following flat-blade screwdriver.

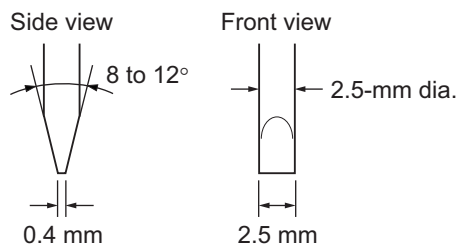

Recommended screwdriver

Model	Manufacturer
SZF 0-0,4×2,5	Phoenix Contact

● Connecting Ferrules

Insert the ferrule straight into the terminal hole.

It is not necessary to press a flat-blade screwdriver into the release hole.

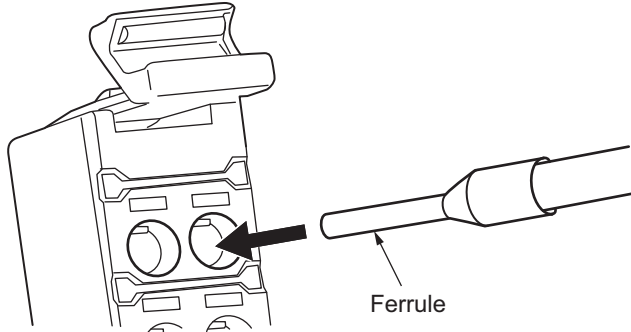

After you make a connection, make sure that the ferrule is securely connected to the terminal block.

● Connecting Twisted Wires/Solid Wires

Use the following procedure to connect the twisted wires or solid wires to the terminal block.

- 1** Press the a flat-blade screwdriver diagonally into the release hole.
Press at an angle of 10° to 15°.

If you press in the screwdriver correctly, you will feel the spring in the release hole.

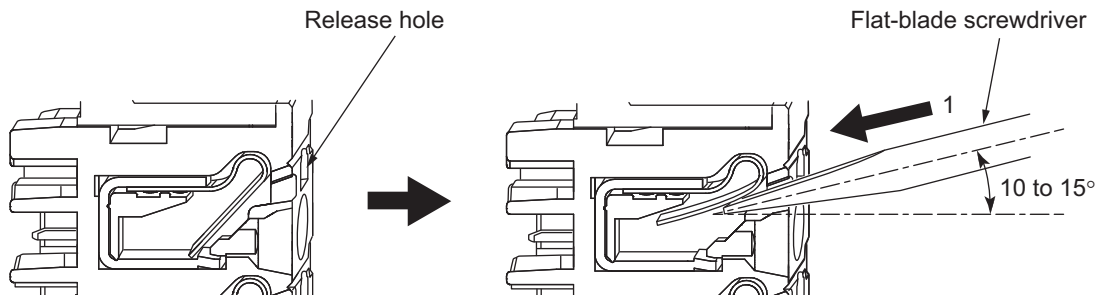

- 2** Leave the flat-blade screwdriver pressed into the release hole and insert the twisted wire or the solid wire into the terminal hole.

Insert the twisted wire or the solid wire until the stripped portion is no longer visible to prevent shorting.

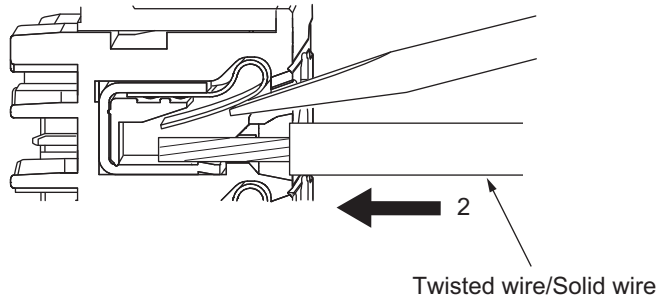

- 3** Remove the flat-blade screwdriver from the release hole.

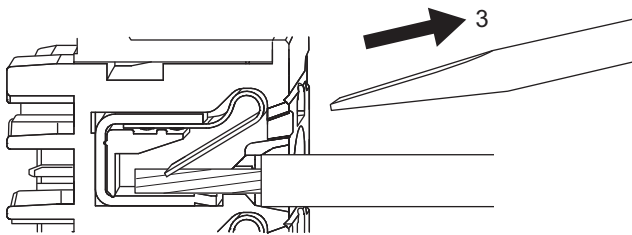

After you make a connection, make sure that the twisted wire or the solid wire is securely connected to the terminal block.



Precautions for Safe Use

- Do not press the flat-blade screwdriver straight into the release hole. Doing so may break the terminal block.

NG

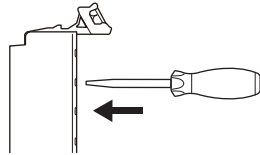

OK

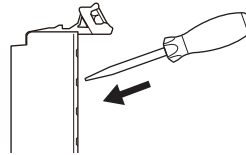

- When you insert a flat-blade screwdriver into a release hole, press it down with a force of 30 N max. Applying excessive force may damage the terminal block.
- Do not tilt or twist the flat-blade screwdriver while it is pressed into the release hole. Doing so may break the terminal block.

NG

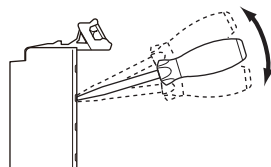

NG

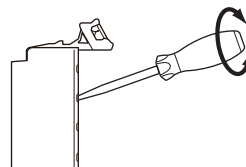

- Make sure that all wiring is correct.
 - Do not bend the cable forcibly. Doing so may sever the cable.
-

● Removing Wires

Use the following procedure to remove the wires from the terminal block.

The removal method is the same for ferrules, twisted wires, and solid wires.

- 1** Press the flat-blade screwdriver diagonally into the release hole.
Press at an angle of 10° to 15°.
If you press in the screwdriver correctly, you will feel the spring in the release hole.

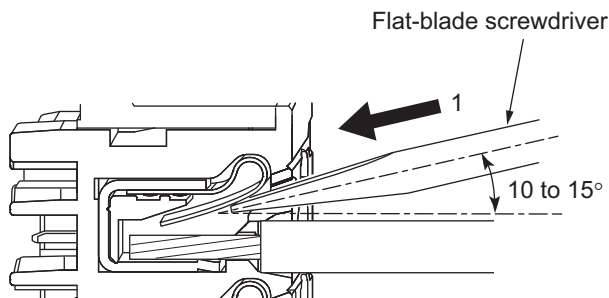

- 2** Leave the flat-blade screwdriver pressed into the release hole and pull out the wire.

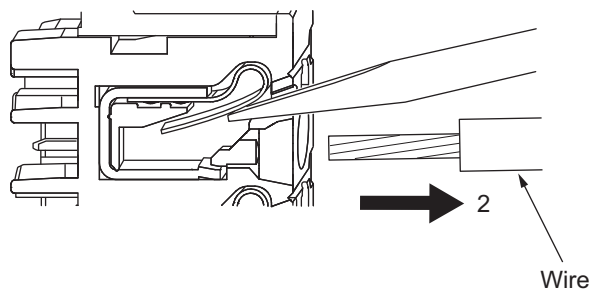

- 3** Remove the flat-blade screwdriver from the release hole.

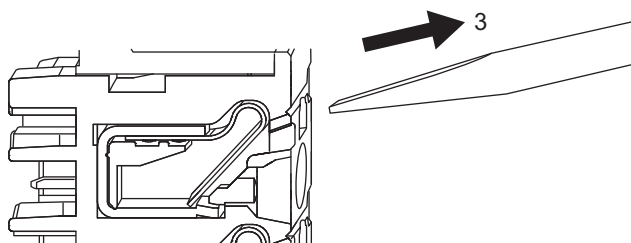



Precautions for Safe Use

- Do not press the flat-blade screwdriver straight into the release hole. Doing so may break the terminal block.

NG

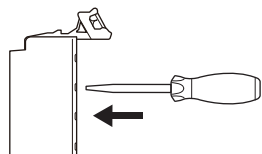

OK

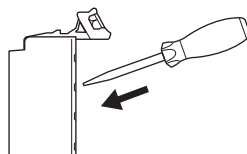

- When you insert a flat-blade screwdriver into a release hole, press it down with a force of 30 N max. Applying excessive force may damage the terminal block.
- Do not tilt or twist the flat-blade screwdriver while it is pressed into the release hole. Doing so may break the terminal block.

NG

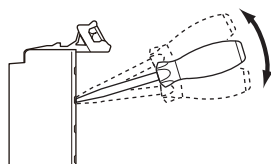

NG

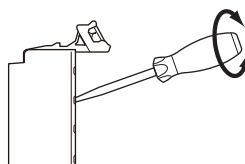

- Make sure that all wiring is correct.
- Do not bend the cable forcibly. Doing so may sever the cable.

Removing a Terminal Block

- 1 Press the lock lever on the terminal block and pull out the top of the terminal block to remove it.

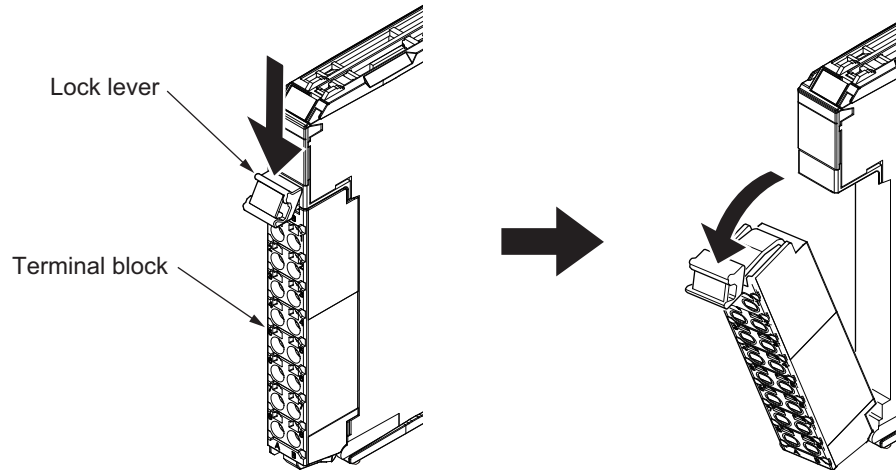

Attaching a Terminal Block

- 1 Place the terminal block hook on the guide at the bottom of the NX Unit and press in on the top of the terminal block to attach it.

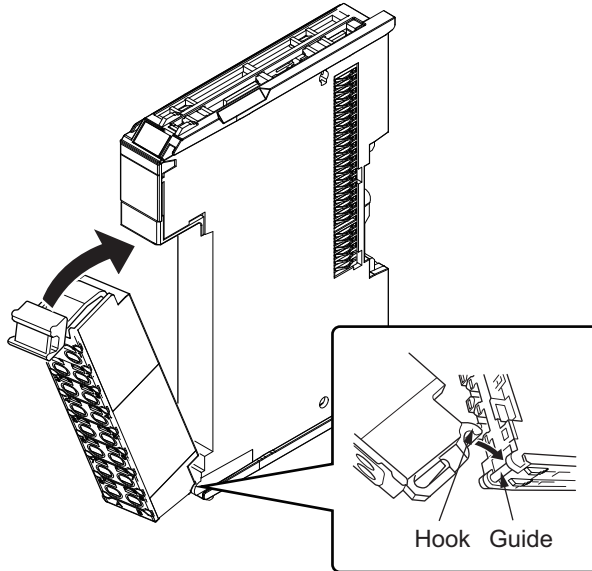

Mount a Terminal Block that is applicable to each Unit model.

Refer to *Applicable Terminal Blocks for Each Unit Model* on page 3-8 for the applicable Terminal Blocks.

Precaution for Installing Temperature Input Units (Thermocouple Input Type)

On a Thermocouple Temperature Input Unit, a cold junction sensor is mounted to the terminal block. The overall accuracy is guaranteed for the set of that comprises a cold junction sensor mounted on the terminal block and a Unit that has the same calibration control number.

Be sure to use the terminal block and the Unit with the same calibration control number together.

There is a label with the calibration control number on the terminal block as shown in the figure below, and the calibration control number is printed on the Unit side.

● 12 mm Width

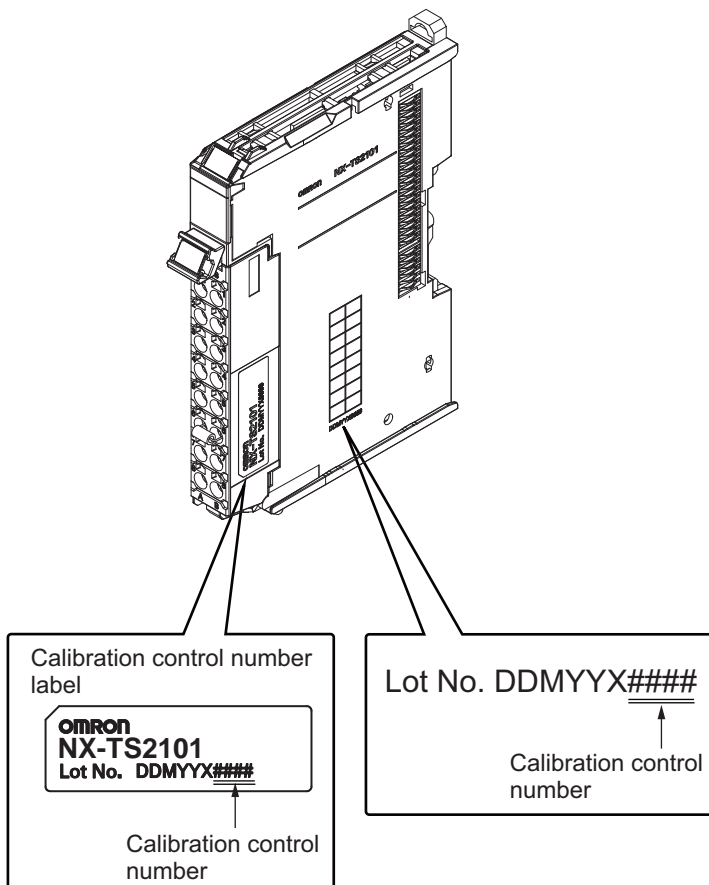

● 24 mm Width

The left and right terminal blocks have the same calibration control number. In order to distinguish these two terminal blocks, each terminal block has either "L" (left side) or "R" (right side) appended at the end as shown in the figure below.

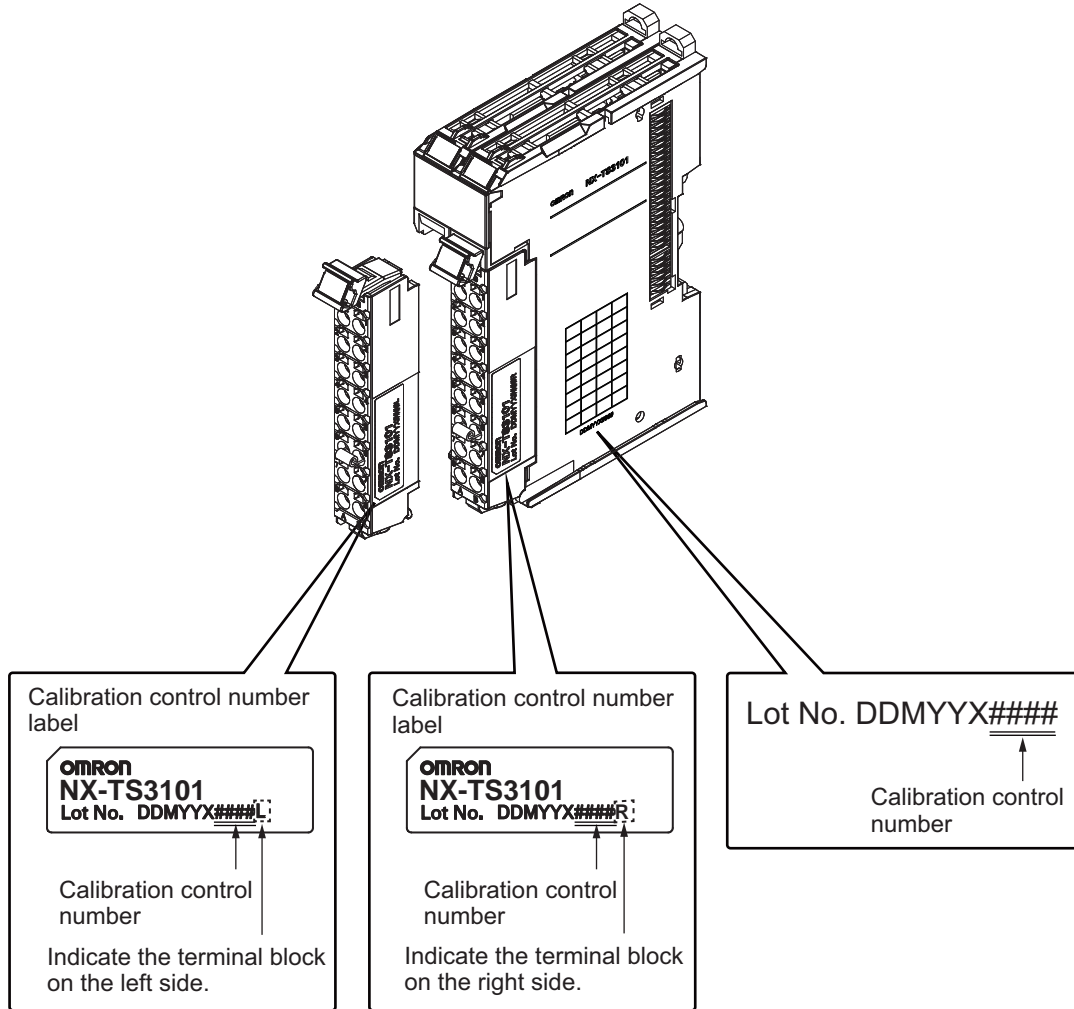

Make sure to return the terminal block and the Temperature Input Unit together for repair.

Preventing Incorrect Attachment of Terminal Blocks

In order to prevent unintentionally installing the wrong terminal block, you can limit the combination of a Unit and a terminal block.

Insert three Coding Pins (NX-AUX02) into three of the six incorrect attachment prevention holes on the Unit and on the terminal block. Insert these pins into positions so that they do not interfere with each other when the Unit and terminal block are connected to each other.

You can use these pins to create a combination in which the wrong terminal block cannot be attached because the pin patterns do not match.

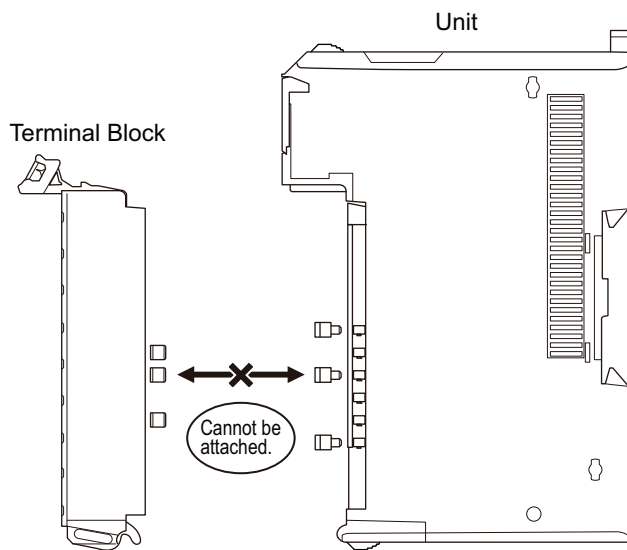

● **Types of Coding Pins**

There are two types of Coding Pins, both with their own unique shape: one for terminal blocks and one for Units.

Three pins come with each runner.

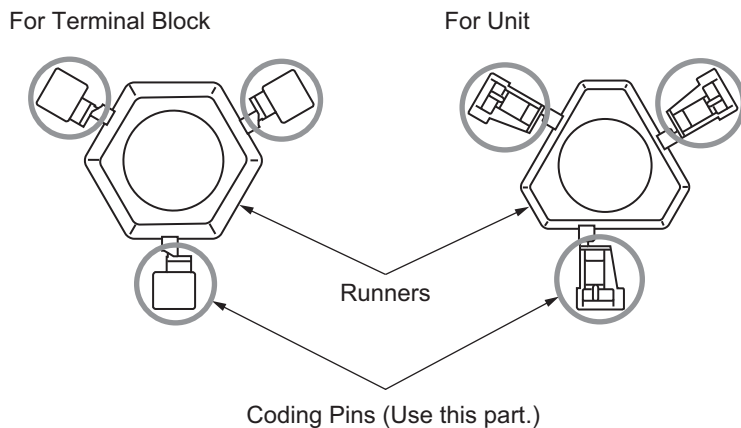

Use the following Coding Pins.

Name	Model	Specification
Coding Pin	NX-AUX02	For 10 Units (Terminal Block: 30 pins, Unit: 30 pins)

● Insertion Locations and Patterns of Coding Pins

Insert three Coding Pins of each on the terminal block and on the Unit at the positions designated by the numbers 1 through 6 in the figure below.

As shown in the following table, there are 20 unique pin patterns that can be used.

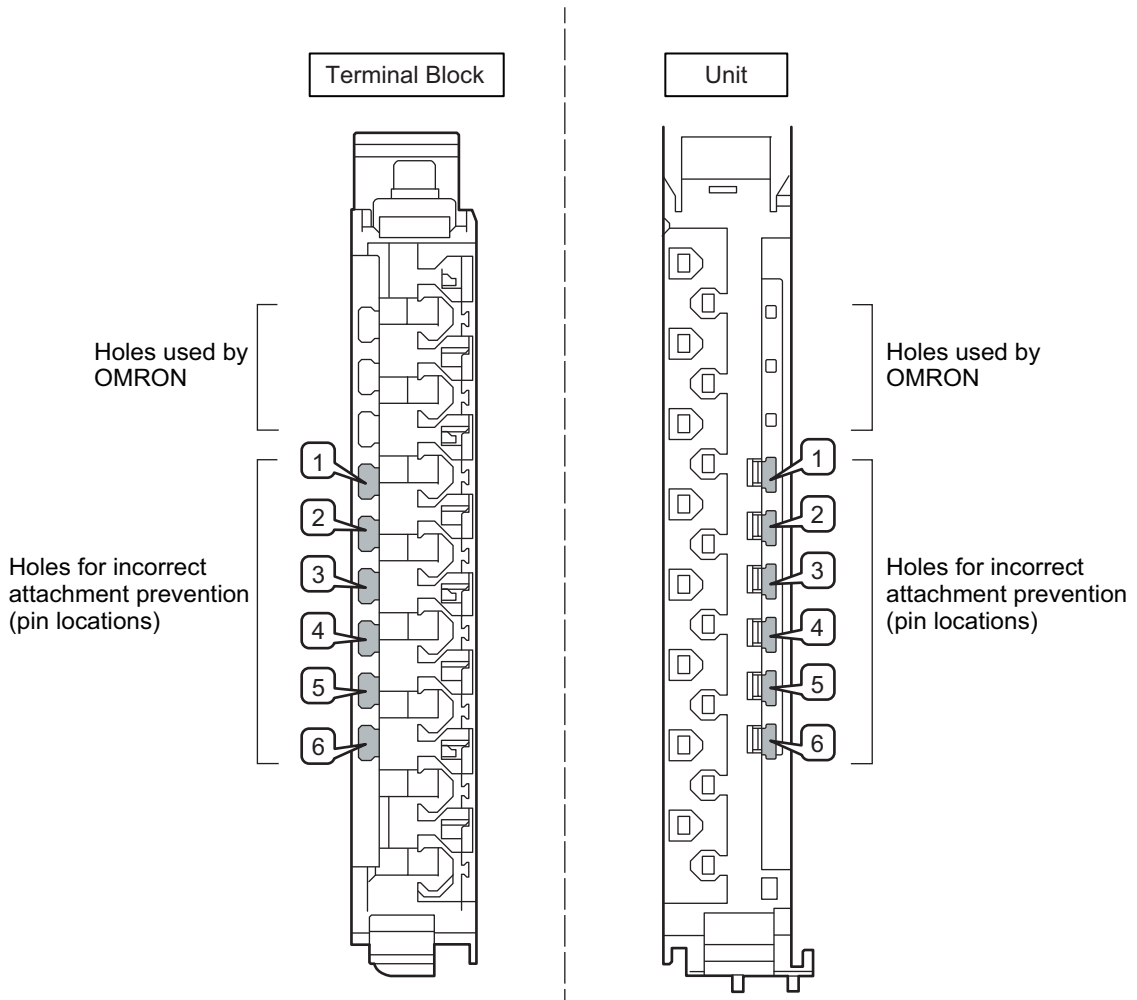

○: Pin inserted

Pattern	Pin locations for Terminal Block						Pin locations for Unit					
	1	2	3	4	5	6	1	2	3	4	5	6
No.1	○	○	○							○	○	○
No.2	○	○		○					○		○	○
No.3	○	○			○				○	○		○
No.4	○	○				○			○	○	○	
No.5	○		○	○				○			○	○
No.6	○		○		○			○		○		○
No.7	○		○			○		○		○	○	
No.8	○			○	○			○	○	○		○
No.9	○			○		○		○	○		○	
No.10	○				○	○		○	○	○		
No.11		○	○	○			○				○	○
No.12		○	○		○		○			○		○
No.13		○	○			○	○			○	○	
No.14		○		○	○		○		○		○	
No.15			○	○	○	○	○			○		○
No.16		○			○	○	○		○	○		
No.17			○	○	○		○	○				○
No.18			○	○		○	○	○			○	
No.19			○		○	○	○	○		○		
No.20				○	○	○	○	○	○			

To make the maximum of 20 patterns, purchase two sets of NX-AUX02 Pins. (One set for 10 Units.)



Precautions for Correct Use

- OMRON uses the holes other than No. 1 to 6 in the figure on the previous page. If you insert a Coding Pin into one of the holes used by OMRON on the terminal block side, this makes it impossible to mount the terminal block on a Unit.
- Do not use Coding Pins that have been attached and removed.

● **Inserting the Coding Pins**

- 1** Hold the pins by the runner and insert a pin into one of the incorrect attachment prevention holes on the terminal block or on the Unit.

Terminal Block

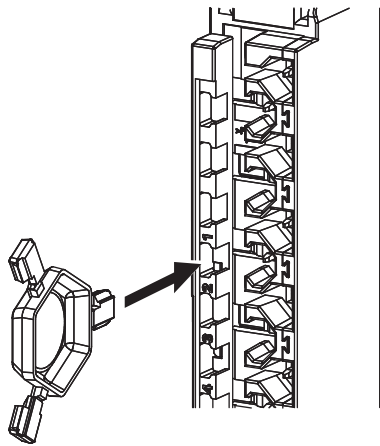

Unit

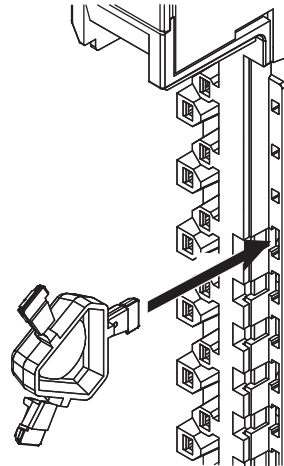

- 2** Rotate the runner to break off the Coding Pins.

Terminal Block

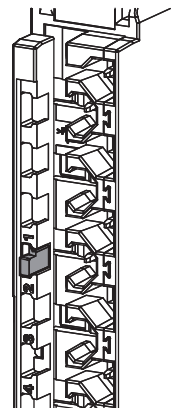
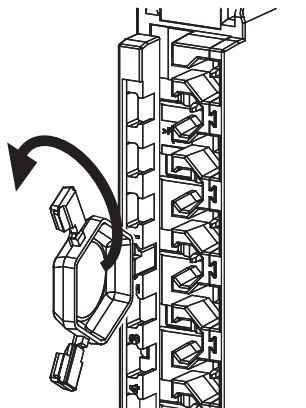

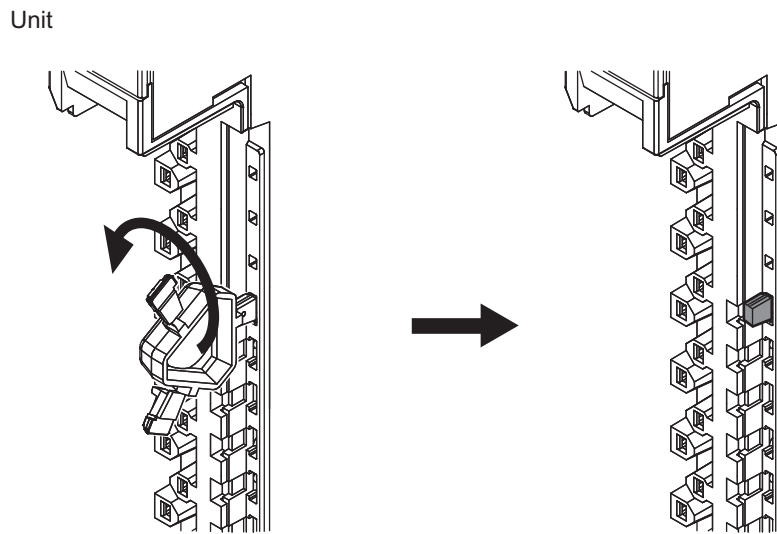

4-3-2 Checking the Wiring

Check the wiring from the I/O Map or Watch Tab Page of the Sysmac Studio.

For Input Units, you can turn ON/OFF the inputs from external devices that are connected to the target Units and monitor the results.

For Output Units, you can refresh the I/O outputs of the target Units with the specified values by forced refreshing, and check the operation of the connected external devices.

If you use the I/O Map, you can also monitor and perform forced refreshing even if does not define the variables and create the algorithms. Therefore, you can easily check the wiring.

Also, if you use I/O checking, you can check the wiring by connecting the computer in which the Sysmac Studio is installed to the peripheral USB port on the EtherCAT Coupler Unit. Therefore, you can check the wiring in conditions such as the following.

- When you want to check the wiring in advance even though the CPU Unit is temporarily unavailable, such as when commissioning the equipment
- When you want to check the wiring in advance even though the wiring of the EtherCAT network is not completed, such as when commissioning the equipment
- When you want to check the wiring when the CPU Unit and an EtherCAT Slave Terminal have some distance from each other
- When more than one EtherCAT Slave Terminal is used and more than one person wants to check the wiring at the same time

Refer to the *EtherCAT Coupler Unit User's Manual* (Cat. No. W519-E1-03 or later) for details on I/O checking.

Refer to the *Sysmac Studio Version 1 Operation Manual* (Cat. No. W504) for details on monitoring and forced refreshing operations.

4-4 Wiring Examples

This section gives some wiring examples for the Analog I/O Units and precautions for wiring.

4-4-1 Wiring the Analog Input Units

● Wiring Example 1 (Input method: Single-ended input)

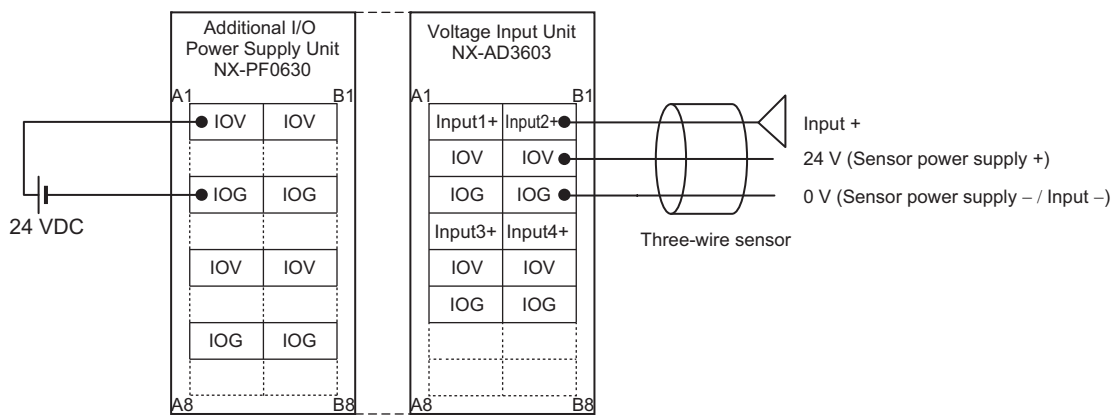

● Wiring Example 2 (Input method: Differential input)

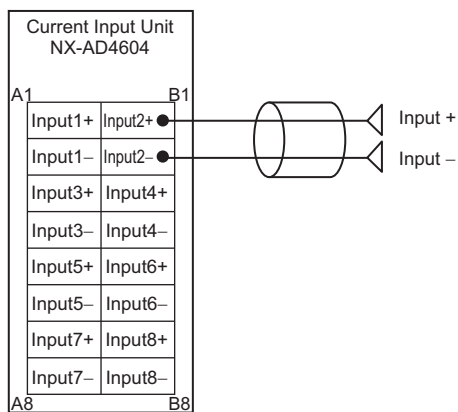

It is not necessary to connect the shield normally. However, if noise affects the Unit, ground the end of the shield on the Input Unit side. In this case, do not connect the end of the shield anywhere on output device.

You can use the NX-TBX01 Shield Connection Unit to ground more than one shield.

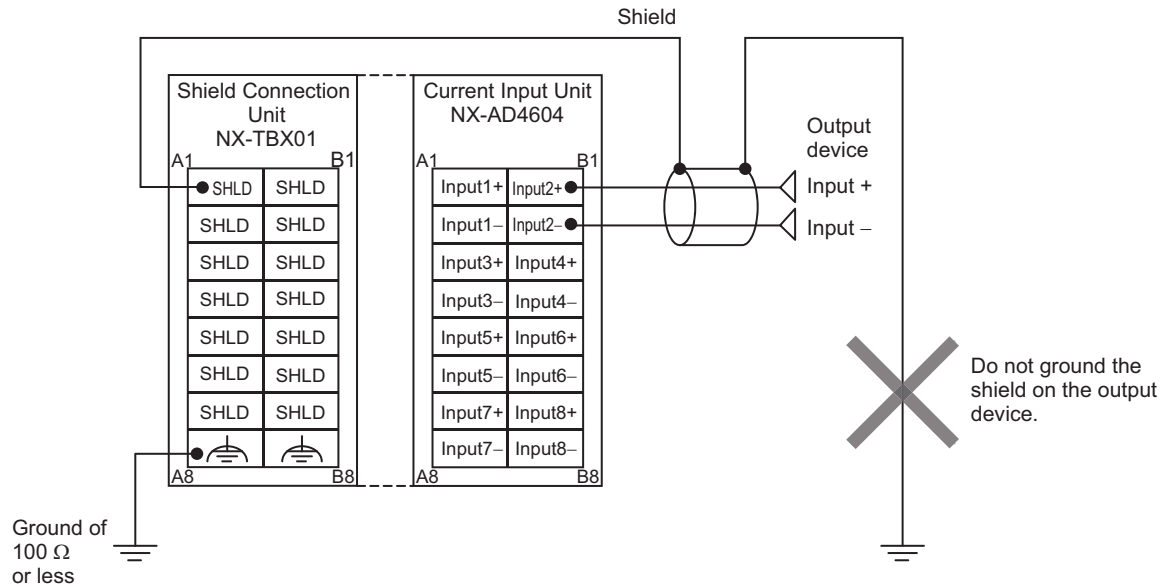

Precautions for Correct Use

To ensure this NX Unit is kept in the best operating condition, observe the following points when wiring to avoid the effects of the noise.

- Use a shield wire (2 conductors, twisted wire) or a shield wire (3 conductors) as the input connection line for each input. Use the shield without connecting to anything normally.
- Wire the input connection lines and power lines (e.g., AC power supply lines or power lines) separately. Do not place such lines in the same duct.
- Insert a noise filter into the power supply input section if noise comes from power supply lines when using the same power supply to power an electrical welder or an electric discharge machine, or there is a high-frequency source nearby.

4-4-2 Wiring the Analog Output Units

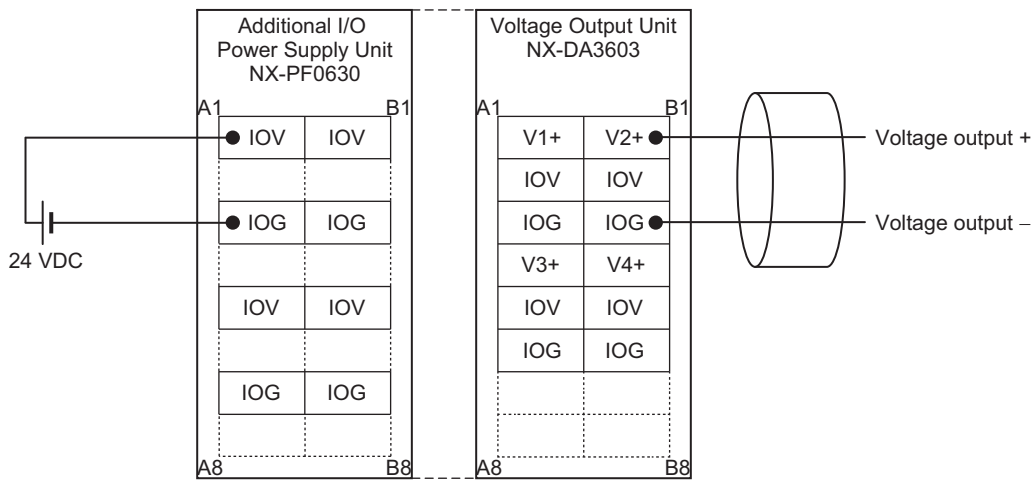

Precautions for Correct Use

To ensure this NX Unit is kept in the best operating condition, observe the following points when wiring to avoid the effects of the noise.

- Use a shield wire (2 conductors, twisted wire) or a shield wire (3 conductors) as the input connection line for each output. Connect the shield according to the specifications of the input device.
- Wire the output connection lines and power lines (e.g., AC power supply lines or power lines) separately. Do not place such lines in the same duct.
- Insert a noise filter into the power supply input section if noise comes from power supply lines when using the same power supply to power an electrical welder or an electric discharge machine, or there is a high-frequency source nearby.

4-4-3 Wiring the Temperature Input Units

● Wiring Example 1

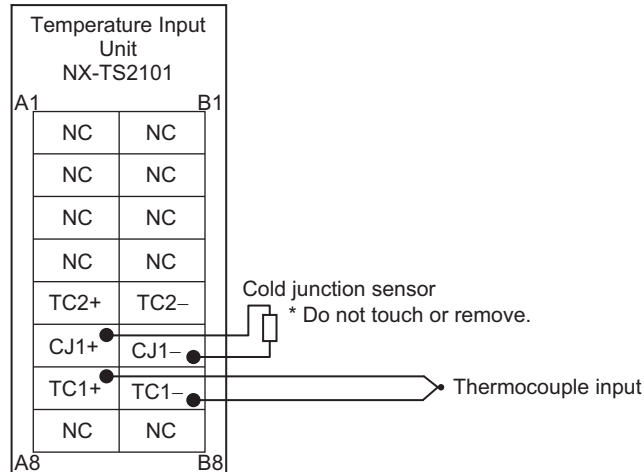

● Wiring Example 2

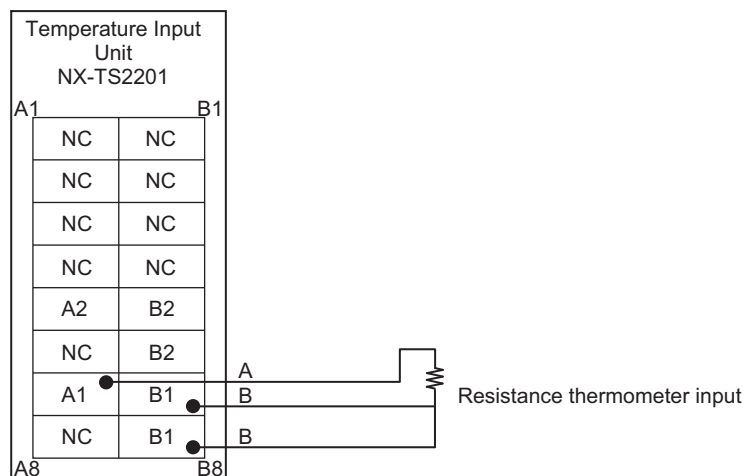

Precautions for Correct Use

- To ensure this NX Unit is kept in the best operating condition, observe the following points when wiring to avoid the effects of the noise.
 - Wire the sensor connection lines and power lines (e.g., AC power supply lines or power lines) separately. Do not place such lines in the same duct.
 - Insert a noise filter into the power supply input section if noise comes from power supply lines when using the same power supply to power an electrical welder or an electric discharge machine, or there is a high-frequency source nearby.
- Do not touch a cold junction sensor that is mounted to the terminal block on a Thermocouple Temperature Input Unit. The temperature may not be measured correctly and the cold junction sensor may be disconnected.

4-4-4 Precautions when Using Common Power Supply for Input Devices of Analog Input Units

If you use Analog Input Units that take differential input, when more than one input device is using the same power supply, and voltage input is being supplied, a disconnection will occur as follows.

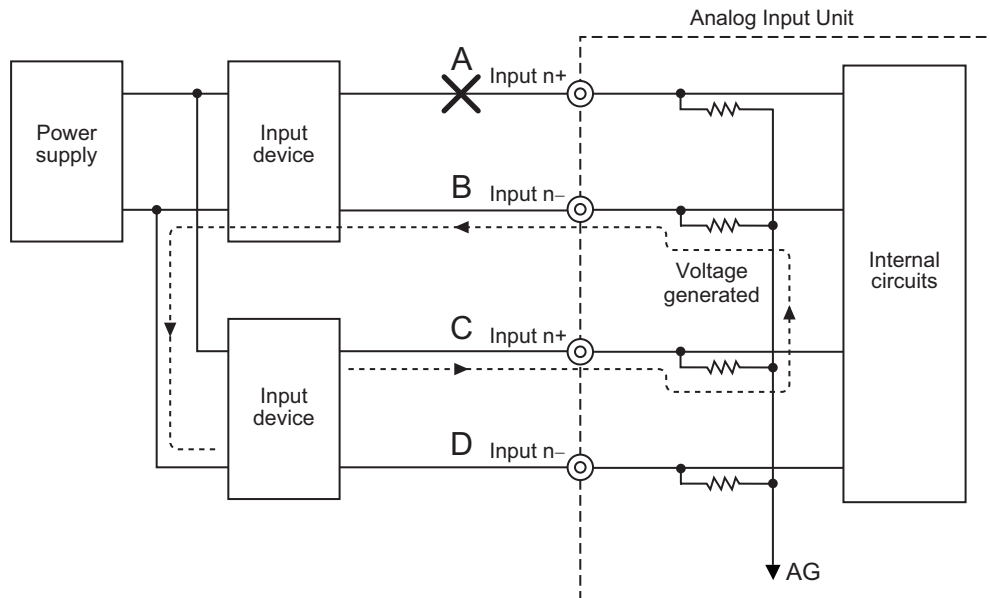

If a disconnection occurs in section A in the figure above, unwanted voltage paths occur as indicated by the arrow. As a result, about 1/3 to 1/2 of the voltage between C and D, which is normally connected, is generated between A and B. The same applies when B is disconnected.

When this kind of voltage is generated, disconnection detection may not work.

When voltage input is being supplied, either set up the input devices so that they are not using the same power supply, or use isolators for each input.

This does not apply when current input is being supplied.

5

I/O Refreshing

This section describes the types and functions of I/O refreshing for the NX Units.

5-1	I/O Refreshing for Slave Terminals	5-2
5-1-1	I/O Refreshing from CPU Unit to Slave Terminal	5-2
5-2	I/O Refreshing Methods	5-3
5-2-1	Types of I/O Refreshing Methods	5-3
5-2-2	Setting the I/O Refreshing Methods	5-3
5-2-3	Selecting NX Units	5-4
5-2-4	Free-Run Refreshing	5-4
5-2-5	Synchronous Input Refreshing	5-9
5-2-6	Synchronous Output Refreshing	5-13

5-1 I/O Refreshing for Slave Terminals

This section describes I/O refreshing for NX-series Slave Terminals.

5-1-1 I/O Refreshing from CPU Unit to Slave Terminal

The CPU Unit cyclically performs I/O refreshing with the Slave Terminal through the Communications Master and Communications Coupler Units.

There are the following four cycles that affect I/O refresh operations between the NX Unit on a Slave Terminal and the CPU Unit.

- (a) Cycle time of the CPU Unit
- (b) Communications cycle of the host network
- (c) Refresh cycle of the NX bus
- (d) Refresh cycle of each NX Unit

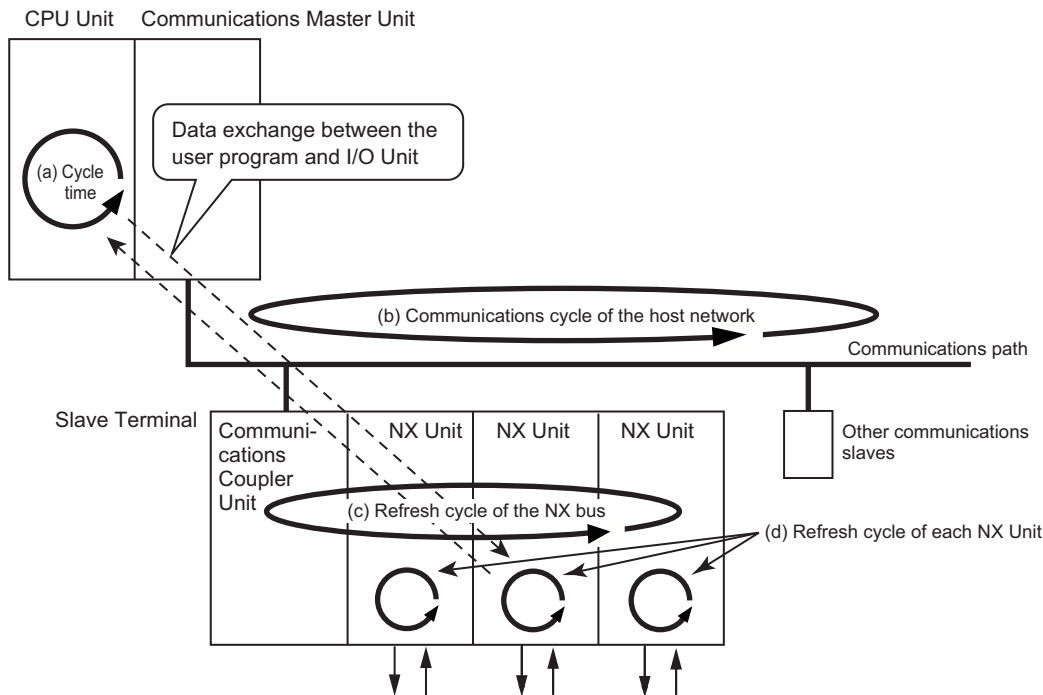

The cycle time of the CPU Unit and communications cycle of the host network and the I/O refresh cycle of the NX bus are determined by the CPU Unit types and the communications types.

The following shows the operation of I/O refreshing when the built-in EtherCAT port on the NJ-series CPU Unit is used for communications with an EtherCAT Slave Terminal.

- The process data communications cycle in item (b) and the refresh cycle of the NX bus in item (c) are automatically synchronized with the primary period of the CPU Unit in item (a).
- The refresh cycle of each NX Unit in item (d) depends on the I/O refreshing method which is given below.

*1. This applies when the distributed clock is enabled in the EtherCAT Coupler Unit.

5-2 I/O Refreshing Methods

This section describes I/O refreshing methods for the NX Units.

5-2-1 Types of I/O Refreshing Methods

When an EtherCAT Coupler Unit is connected to the built-in EtherCAT port on the NJ-series CPU Unit, the I/O refreshing methods that you can use between the EtherCAT Coupler Unit and the NX Units are as follows.

I/O refreshing method name	Outline of operation
Free-Run refreshing	With this I/O refreshing method, the refresh cycle of the NX bus and the I/O refresh cycles of the NX Units are asynchronous.
Synchronous I/O refreshing	With this I/O refreshing method, the timing to read inputs or to refresh outputs is synchronous on a fixed interval between more than one NX Unit on more than one Slave Terminal.

Since the EtherCAT Coupler Unit can execute all I/O refreshing methods at the same time, you can use NX Units with different I/O refreshing methods together in the EtherCAT Slave Terminal.

5-2-2 Setting the I/O Refreshing Methods

The I/O refreshing method between the EtherCAT Coupler Unit and each NX Unit is determined by whether the distributed clock is enabled or disabled in the EtherCAT Coupler Unit.

Distributed clock enable/disable setting in the EtherCAT Coupler Unit	NX Units that support only Free-Run refreshing	NX Units that support both Free-Run refreshing and synchronous I/O refreshing
Enabled (DC Mode)	Free-Run refreshing	Synchronous I/O refreshing
Disabled (Free-Run Mode)	Free-Run refreshing	Free-Run refreshing



Additional Information

- The Temperature Input Units only support Free-Run refreshing.
- The EtherCAT Slave Terminals with enabled distributed clocks and all EtherCAT slaves that support DC synchronization execute I/O processing based on Sync0 that is shared on the EtherCAT network. However, since the specifications and performance for the timing to read inputs or to refresh outputs for EtherCAT slaves and NX Units are different, the timing to read inputs or to refresh outputs is not simultaneous. Refer to the manuals for the EtherCAT slaves for information on the timing to read inputs or to refresh outputs in EtherCAT slaves.

5-2-3 Selecting NX Units

The I/O refreshing methods that you can use depend on the model of the NX Unit. After you decide on which I/O refreshing method to use, select the NX Units.

5-2-4 Free-Run Refreshing

With this I/O refreshing method, the refresh cycle of the NX bus and I/O refresh cycles of the NX Units are asynchronous.

Analog I/O Units read inputs or refresh outputs at the time of I/O refreshing.

This method is used when it is not necessary to be aware of factors such as the I/O timing jitter and the concurrency of the timing to read inputs and refresh outputs between the NX Units.

Description of Operation

- You can connect the following NX Units to the Slave Terminal to use this method.
The NX Units that support Free-Run refreshing
- The Communications Coupler Unit performs I/O refreshing for NX Units in order. (Refer to (a) in the figure below.)
- The NX Units read inputs or refresh outputs at the time of I/O refreshing. (Refer to (b) in the figure below.)
- The Communications Coupler Unit can read the most recent input value at the I/O refreshing and the NX Units can control with the most recent output value at the I/O refreshing. However, since I/O refreshing is performed in order, timing to read inputs or to refresh outputs for each NX Unit in the Slave Terminal does not occur at the same time. (Refer to (c) in the figure below.)
- The interval of I/O refreshing varies with the processing conditions of the Communications Coupler Unit or the host communications master. Therefore, the interval of the timing to read inputs or to refresh outputs for NX Unit is not always the same. (Refer to (d) in the figure below.)

● **Inputs**

- The Analog Input Units repeatedly performs AD conversion in the order of inputs for which the used channels are set to enable. AD conversion is not synchronized with I/O refreshing of the NX bus.
- At the time of I/O refreshing, the Communications Coupler Unit reads the converted values from the NX Unit for one Unit that AD conversion is complete before the timing to read inputs.

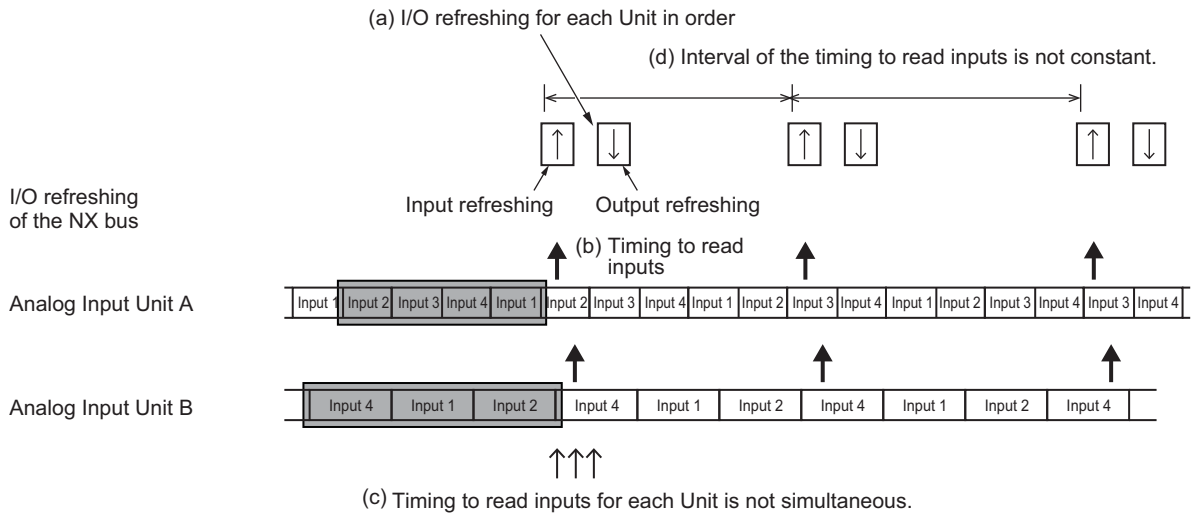

● **Outputs**

- The Analog Output Units repeatedly performs DA conversion in the order of outputs for which the used channels are set to enable. The outputs are refreshed once per DA conversion cycle for one Unit when DA conversion of the last output is complete. The refreshing is not synchronized with I/O refreshing of the NX bus.
- At the time of I/O refreshing, the Analog Output Units perform DA conversion with the refreshed output set values from the outputs before the start of conversion.

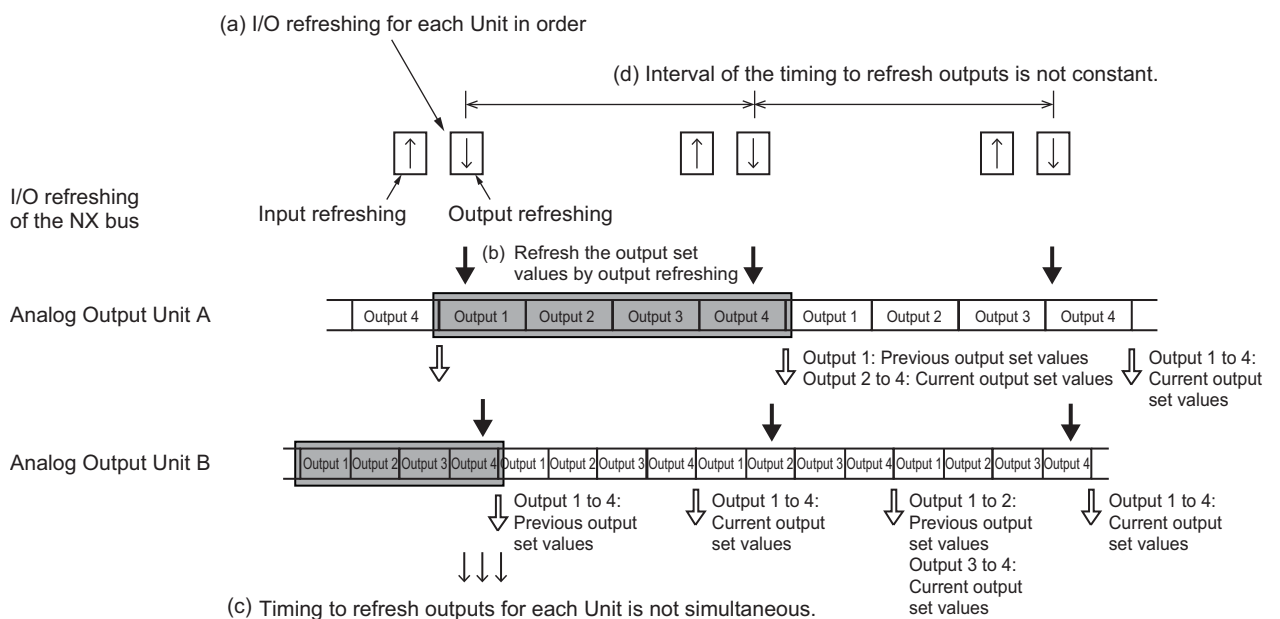

Settings

Enable the distributed clock in the EtherCAT slave parameters on the EtherCAT Coupler Unit that is added to the EtherCAT network configuration and add the NX Units that support Free-Run refreshing to the NX Unit configuration.

Or disable the distributed clock in the EtherCAT slave parameters and add NX Units that support either Free-Run refreshing or synchronous I/O refreshing to the NX Unit configuration.

I/O Port

● Analog Input Units

This uses the I/O ports of the input values.

Two-point Input Units

I/O port name	Type	R/W	Name	Description	Default value
Ch1 Analog Input Value	INT	RO	Ch1 Analog Input Value	The input value for Ch1.	0
Ch2 Analog Input Value	INT	RO	Ch2 Analog Input Value	The input value for Ch2.	0

Four-point Input Units

I/O port name	Type	R/W	Name	Description	Default value
Ch1 Analog Input Value	INT	RO	Ch1 Analog Input Value	The input value for Ch1.	0
Ch2 Analog Input Value	INT	RO	Ch2 Analog Input Value	The input value for Ch2.	0
Ch3 Analog Input Value	INT	RO	Ch3 Analog Input Value	The input value for Ch3.	0
Ch4 Analog Input Value	INT	RO	Ch4 Analog Input Value	The input value for Ch4.	0

Eight-point Input Units

I/O port name	Type	R/W	Name	Description	Default value
Ch1 Analog Input Value	INT	RO	Ch1 Analog Input Value	The input value for Ch1.	0
Ch2 Analog Input Value	INT	RO	Ch2 Analog Input Value	The input value for Ch2.	0
Ch3 Analog Input Value	INT	RO	Ch3 Analog Input Value	The input value for Ch3.	0
Ch4 Analog Input Value	INT	RO	Ch4 Analog Input Value	The input value for Ch4.	0
Ch5 Analog Input Value	INT	RO	Ch5 Analog Input Value	The input value for Ch5.	0
Ch6 Analog Input Value	INT	RO	Ch6 Analog Input Value	The input value for Ch6.	0
Ch7 Analog Input Value	INT	RO	Ch7 Analog Input Value	The input value for Ch7.	0
Ch8 Analog Input Value	INT	RO	Ch8 Analog Input Value	The input value for Ch8.	0

- **Analog Output Units**

This uses the I/O ports of the output set values.

Two-point Output Units

I/O port name	Type	R/W	Name	Description	Default value
Ch1 Analog Output Value	INT	RW	Ch1 Analog Output Value	The output set value for Ch1.	0
Ch2 Analog Output Value	INT	RW	Ch2 Analog Output Value	The output set value for Ch2.	0

Four-point Output Units

I/O port name	Type	R/W	Name	Description	Default value
Ch1 Analog Output Value	INT	RW	Ch1 Analog Output Value	The output set value for Ch1.	0
Ch2 Analog Output Value	INT	RW	Ch2 Analog Output Value	The output set value for Ch2.	0
Ch3 Analog Output Value	INT	RW	Ch3 Analog Output Value	The output set value for Ch3.	0
Ch4 Analog Output Value	INT	RW	Ch4 Analog Output Value	The output set value for Ch4.	0

● Temperature Input Units

This uses the I/O ports of the input values.

Two-point Input Units

I/O port name	Type	R/W	Name	Description	Default value
Ch1 Measured Value INT	INT	RO	Ch1 Measured Value INT	Analog input measured value (INT) for Ch1.	0
Ch2 Measured Value INT	INT	RO	Ch2 Measured Value INT	Analog input measured value (INT) for Ch2.	0
Ch1 Measured Value DINT	DINT	RO	Ch1 Measured Value DINT	Analog input measured value (DINT) for Ch1.	0
Ch2 Measured Value DINT	DINT	RO	Ch2 Measured Value DINT	Analog input measured value (DINT) for Ch2.	0
Ch1 Measured Value REAL	REAL	RO	Ch1 Measured Value REAL	Analog input measured value (REAL) for Ch1.	0
Ch2 Measured Value REAL	REAL	RO	Ch2 Measured Value REAL	Analog input measured value (REAL) for Ch2.	0

Four-point Input Units

I/O port name	Type	R/W	Name	Description	Default value
Ch1 Measured Value INT	INT	RO	Ch1 Measured Value INT	Analog input measured value (INT) for Ch1.	0
Ch2 Measured Value INT	INT	RO	Ch2 Measured Value INT	Analog input measured value (INT) for Ch2.	0
Ch3 Measured Value INT	INT	RO	Ch3 Measured Value INT	Analog input measured value (INT) for Ch3.	0
Ch4 Measured Value INT	INT	RO	Ch4 Measured Value INT	Analog input measured value (INT) for Ch4.	0
Ch1 Measured Value DINT	DINT	RO	Ch1 Measured Value DINT	Analog input measured value (DINT) for Ch1.	0
Ch2 Measured Value DINT	DINT	RO	Ch2 Measured Value DINT	Analog input measured value (DINT) for Ch2.	0
Ch3 Measured Value DINT	DINT	RO	Ch3 Measured Value DINT	Analog input measured value (DINT) for Ch3.	0
Ch4 Measured Value DINT	DINT	RO	Ch4 Measured Value DINT	Analog input measured value (DINT) for Ch4.	0
Ch1 Measured Value REAL	REAL	RO	Ch1 Measured Value REAL	Analog input measured value (REAL) for Ch1.	0
Ch2 Measured Value REAL	REAL	RO	Ch2 Measured Value REAL	Analog input measured value (REAL) for Ch2.	0
Ch3 Measured Value REAL	REAL	RO	Ch3 Measured Value REAL	Analog input measured value (REAL) for Ch3.	0
Ch4 Measured Value REAL	REAL	RO	Ch4 Measured Value REAL	Analog input measured value (REAL) for Ch4.	0

5-2-5 Synchronous Input Refreshing

With this I/O refreshing method, the timing to read inputs is synchronized on a fixed interval between more than one NX Unit on the Slave Terminal.

This method is used when the problem such as input timing jitter or offset of timing to read inputs between more than one NX Unit happens.

Description of Operation

- This method is used when you connect the NX Units that support synchronous I/O refreshing to the EtherCAT Coupler Unit that is connected to the built-in EtherCAT port on the NJ-series CPU Unit.
- All Digital Input Units and Analog Input Units that operate with synchronous input refreshing in the Slave Terminal read their inputs at the same time at a fixed interval based on Sync0. (Refer to (a) in the figure below.)
- The Analog Input Units perform AD conversion once for each refresh cycle of the NX bus in order to obtain the AD converted values of all inputs for which the used channels are set to enable at the time to read inputs.
AD conversion is performed in order from the lowest channel number, so that the timing to convert is different for each input.
- The Communications Coupler Unit reads the input values that are latched at the time to read inputs at immediate I/O refreshing. (Refer to (b) in the figure below.)
- The interval of I/O refreshing varies with the processing conditions of the Communications Coupler Unit or the host communications master. (Refer to (c) in the figure below.) The timing to read inputs will be at a fixed interval. (Refer to (d) in the figure below.)
- The Sync0, the timing to read inputs and the maximum NX bus I/O refresh cycle of the Slave Terminals are automatically calculated by the Sysmac Studio according to the input refresh cycle of the NX Units in the Slave Terminals when the Slave Terminals are configured and set up.

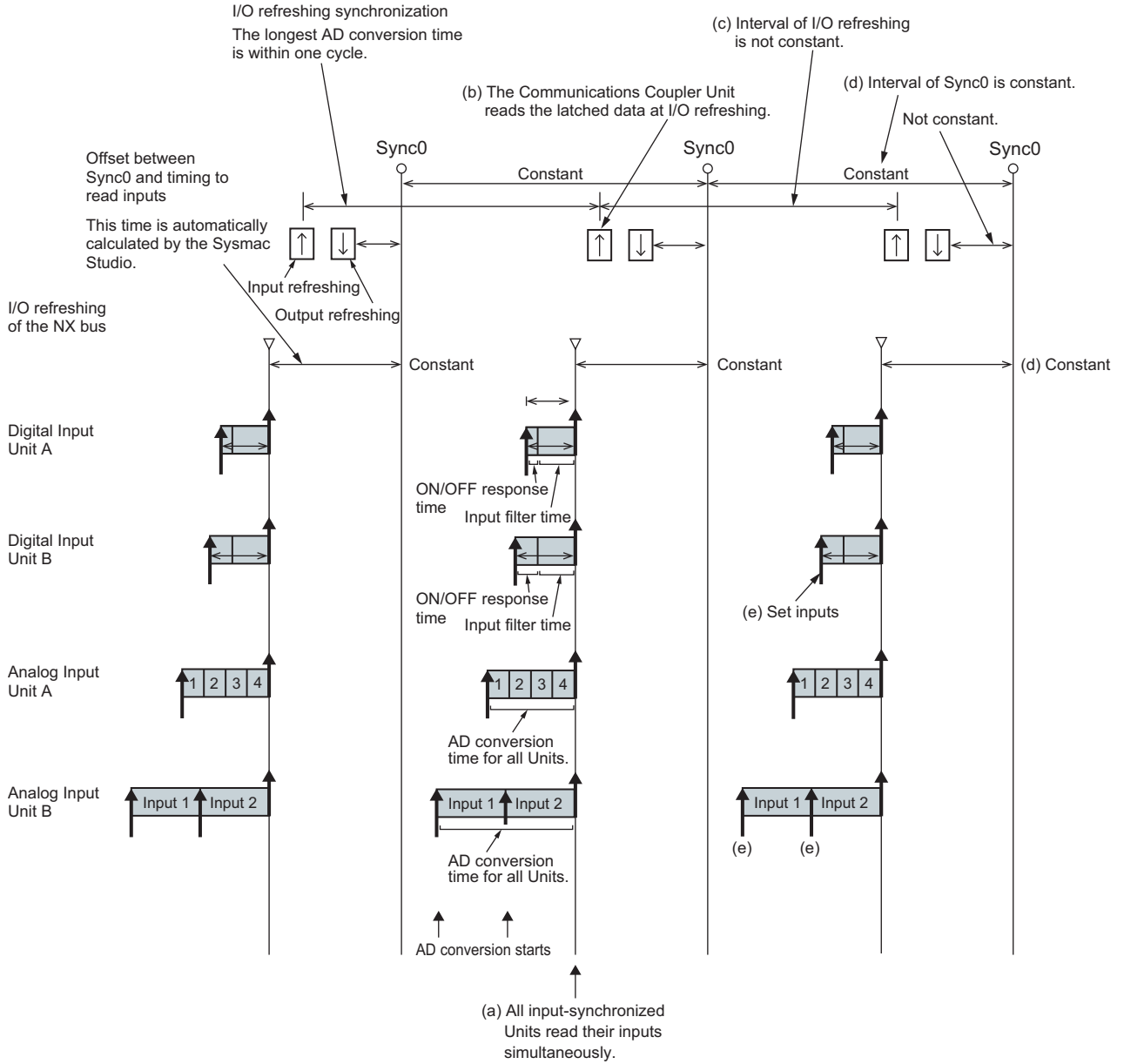

Settings

Set the following items.

● Adding to the NX Unit Configuration

Enable the distributed clock in the EtherCAT slave parameters on the EtherCAT Coupler Unit that is added to the EtherCAT network configuration and add the NX Units that support synchronous I/O refreshing to the NX Unit configuration.

● Setting the Task Period

Set the task period of the primary periodic task.

With the primary periodic task in Configurations and Setup - Task Settings, select the task period in the Period/Execution Conditions from the list.

At this time, set the primary period to a task period in which the value that is greater than the I/O refresh cycle of the NX bus that is calculated by the Sysmac Studio.

A warning is given if you set the primary period to a task period in which the value that is smaller than the I/O refresh cycle of the NX bus that is calculated by the Sysmac Studio.

Refer to the *NX-series EtherCAT Coupler Unit User's Manual* (Cat. No. W519) for a warning on the task periods.

I/O Port

This uses the I/O ports of the input values.

● Two-point Input Units

I/O port name	Type	R/W	Name	Description	Default value
Ch1 Analog Input Value	INT	RO	Ch1 Analog Input Value	The input value for Ch1.	0
Ch2 Analog Input Value	INT	RO	Ch2 Analog Input Value	The input value for Ch2.	0

● Four-point Input Units

I/O port name	Type	R/W	Name	Description	Default value
Ch1 Analog Input Value	INT	RO	Ch1 Analog Input Value	The input value for Ch1.	0
Ch2 Analog Input Value	INT	RO	Ch2 Analog Input Value	The input value for Ch2.	0
Ch3 Analog Input Value	INT	RO	Ch3 Analog Input Value	The input value for Ch3.	0
Ch4 Analog Input Value	INT	RO	Ch4 Analog Input Value	The input value for Ch4.	0

● Eight-point Input Units

I/O port name	Type	R/W	Name	Description	Default value
Ch1 Analog Input Value	INT	RO	Ch1 Analog Input Value	The input value for Ch1.	0
Ch2 Analog Input Value	INT	RO	Ch2 Analog Input Value	The input value for Ch2.	0
Ch3 Analog Input Value	INT	RO	Ch3 Analog Input Value	The input value for Ch3.	0
Ch4 Analog Input Value	INT	RO	Ch4 Analog Input Value	The input value for Ch4.	0
Ch5 Analog Input Value	INT	RO	Ch5 Analog Input Value	The input value for Ch5.	0
Ch6 Analog Input Value	INT	RO	Ch6 Analog Input Value	The input value for Ch6.	0
Ch7 Analog Input Value	INT	RO	Ch7 Analog Input Value	The input value for Ch7.	0
Ch8 Analog Input Value	INT	RO	Ch8 Analog Input Value	The input value for Ch8.	0

5-2-6 Synchronous Output Refreshing

With this I/O refreshing method, the timing to refresh outputs is synchronized on a fixed interval between more than one NX Unit on the Slave Terminal.

This method is used when the problem such as input timing jitter or offset of timing to refresh outputs between more than one NX Unit happens.

Description of Operation

- This method is used when you connect the NX Units that support synchronous I/O refreshing to the EtherCAT Coupler Unit, that is connected to the built-in EtherCAT port on the NJ-series CPU Unit.
- All Digital Input Units and Analog Input Units that operate with synchronous output refreshing in the Slave Terminal refresh their outputs at the same time at a fixed interval bases on Sync0. (Refer to (a) in the figure below.)
- The Communication Coupler Unit refreshes the output values at I/O refreshing. (Refer to (b) in the figure below.)
- The Analog Output Units perform DA conversion with the output set values that are refreshed once for each refresh cycle of the NX bus in order to output the DA converted values of all outputs for which the used channels are set to enable at the time to refresh outputs.
- The interval of I/O refreshing varies with the processing conditions of the Communications Coupler Unit or the host communications master. (Refer to (c) in the figure below.) The timing to refresh outputs will be at a fixed interval. (Refer to (d) in the figure below.)
- The Sync0, the timing to refresh outputs and the maximum NX bus I/O refresh cycle of the Slave Terminals are automatically calculated by the Sysmac Studio according to the output refresh cycle of the NX Units in the Slave Terminals when the Slave Terminals are configured and set up.
- The ON/OFF response time is needed from the timing to refresh outputs until setting the output status of external terminals on the NX Units. (Refer to (e) in the figure below.)

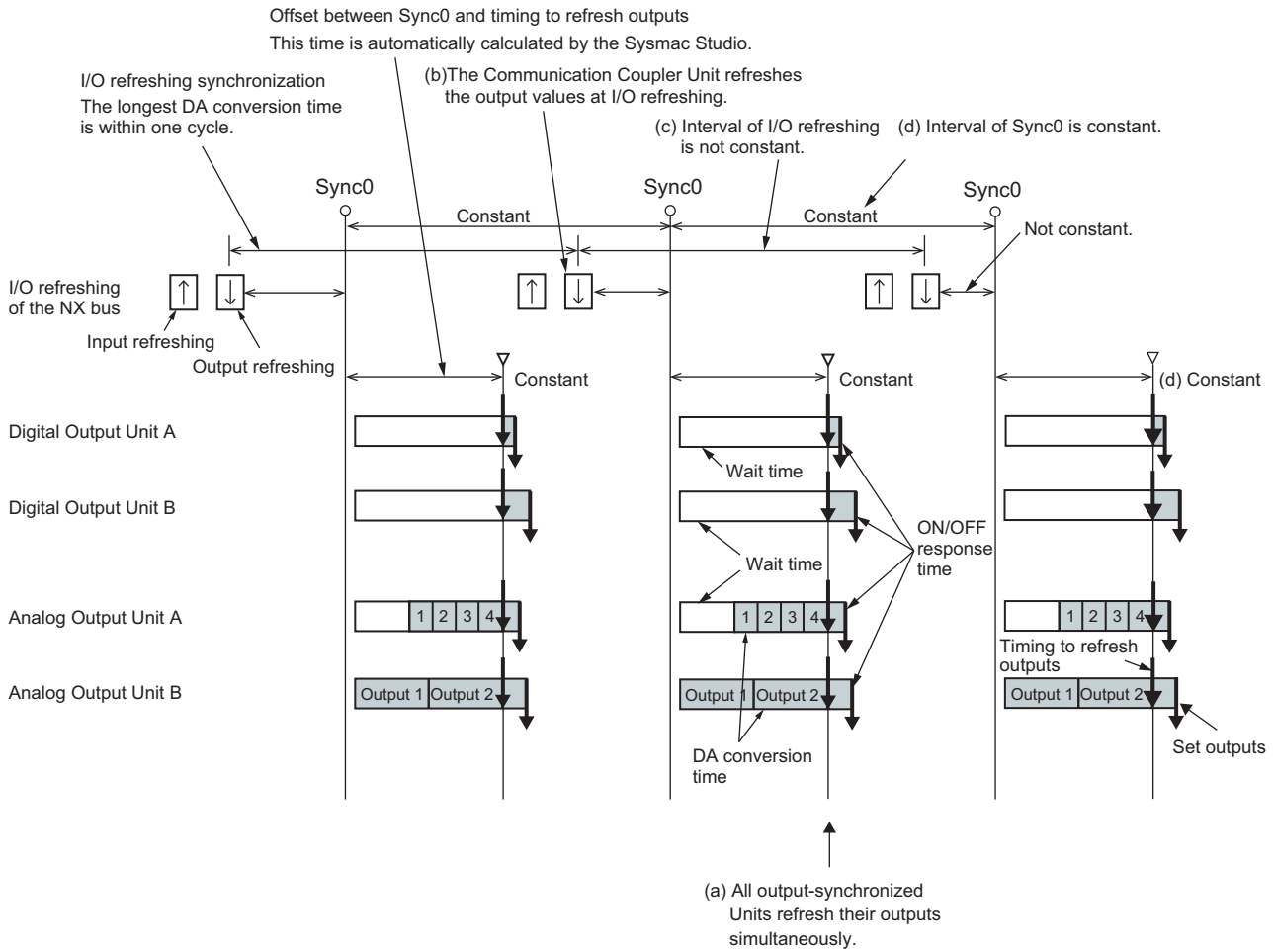

Settings

Set the following items.

- **Adding to the NX Unit Configuration**

Enable the distributed clock in the EtherCAT slave parameters on the EtherCAT Coupler Unit that is added to the EtherCAT network configuration and add the NX Units that support synchronous I/O refreshing to the NX Unit configuration.

- **Setting the Task Period**

Set the task period of the primary periodic task.

With the primary periodic task in Configurations and Setup - Task Settings, select the task period in the Period/Execution Conditions from the list.

At this time, set the primary period to a task period in which the value that is greater than the I/O refresh cycle of the NX bus that is calculated by the Sysmac Studio.

A warning is given if you set the primary period to a task period in which the value that is smaller than the I/O refresh cycle of the NX bus that is calculated by the Sysmac Studio.

Refer to the *NX-series EtherCAT Coupler Unit User's Manual* (Cat. No. W519) for a warning on the task periods.

I/O Port

This uses the I/O ports of the output set values.

- **Two-point Output Units**

I/O port name	Type	R/W	Name	Description	Default value
Ch1 Analog Output Value	INT	RW	Ch1 Analog Output Value	The output set value for Ch1.	0
Ch2 Analog Output Value	INT	RW	Ch2 Analog Output Value	The output set value for Ch2.	0

● Four-point Output Units

I/O port name	Type	R/W	Name	Description	Default value
Ch1 Analog Output Value	INT	RW	Ch1 Analog Output Value	The output set value for Ch1.	0
Ch2 Analog Output Value	INT	RW	Ch2 Analog Output Value	The output set value for Ch2.	0
Ch3 Analog Output Value	INT	RW	Ch3 Analog Output Value	The output set value for Ch3.	0
Ch4 Analog Output Value	INT	RW	Ch4 Analog Output Value	The output set value for Ch4.	0

6

Analog Input Units

This section describes the types and functions of Analog Input Units.

6-1	Types of Analog Input Units	6-2
6-2	Input Range and Converted Values	6-4
6-3	Specifications of I/O Data	6-6
6-3-1	Allocable I/O Data	6-6
6-4	List of Settings	6-8
6-5	Function	6-12
6-5-1	List of Analog Input Unit Functions	6-12
6-5-2	Selecting Channel To Use	6-13
6-5-3	Moving Average	6-19
6-5-4	Input Disconnection Detection	6-27
6-5-5	Over Range/Under Range Detection	6-28
6-5-6	User Calibration	6-29

6-1 Types of Analog Input Units

Analog Input Units are the NX Units with functionality to convert analog input signals such as -10 to +10 V and 4 to 20 mA to digital values.

The Analog Input Unit types are described below.

Analog Input Units (Screwless Clamping Terminal Block, 12 mm Width)

Model	Number of points	Input range	Resolution	Input method	I/O refreshing method	Conversion time	Reference
NX-AD2203	2 points	4 to 20 mA	1/8000	Single-ended	Free-Run refreshing	250 μ s/point	P. A-6
NX-AD2204							P. A-7
NX-AD2208			1/30000	Differential	Switching Synchronous I/O refreshing and Free-Run refreshing	10 μ s/point	P. A-8
NX-AD2603			-10 to +10 V	1/8000	Single-ended	Free-Run refreshing	250 μ s/point
NX-AD2604		P. A-10					
NX-AD2608	1/30000	Differential		Switching Synchronous I/O refreshing and Free-Run refreshing	10 μ s/point	P. A-11	
NX-AD3203	4 points	4 to 20 mA		1/8000	Single-ended	Free-Run refreshing	250 μ s/point
NX-AD3204					P. A-13		
NX-AD3208			1/30000	Differential	Switching Synchronous I/O refreshing and Free-Run refreshing	10 μ s/point	P. A-14
NX-AD3603			-10 to +10 V	1/8000	Single-ended	Free-Run refreshing	250 μ s/point
NX-AD3604		P. A-16					
NX-AD3608	1/30000	Differential		Switching Synchronous I/O refreshing and Free-Run refreshing	10 μ s/point	P. A-17	

Model	Number of points	Input range	Resolution	Input method	I/O refreshing method	Conversion time	Reference
NX-AD4203	8 points	4 to 20 mA	1/8000	Single-ended	Free-Run refreshing	250 μ s/point	P. A-18
NX-AD4204							P. A-19
NX-AD4208			1/30000	Differential	Switching Synchronous I/O refreshing and Free-Run refreshing	10 μ s/point	P. A-20
NX-AD4603		-10 to +10 V	1/8000	Single-ended	Free-Run refreshing	250 μ s/point	P. A-21
NX-AD4604							P. A-22
NX-AD4608			1/30000	Differential	Switching Synchronous I/O refreshing and Free-Run refreshing	10 μ s/point	P. A-23

6-2 Input Range and Converted Values

Input analog signals are converted to digital values according to the input range shown below.

If the input range exceeds the value range for which conversion is possible, the converted value fixed at the upper or lower limit.

Input Range: -10 to +10 V

● 1/8000 Resolution

A voltage of -10 to +10 V is converted to a signed integer value (-4000 to +4000).

The input voltage range for which conversion is possible is -11 to +11 V and here the converted value is a signed integer value (-4400 to +4400).

There is no disconnection detection function.

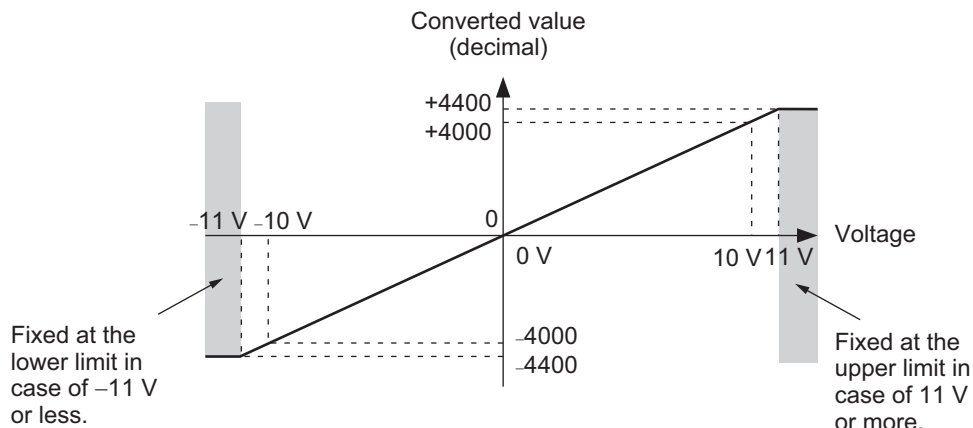

● 1/30000 Resolution

A voltage of -10 to +10 V is converted to a signed integer value (-15000 to +15000).

The input voltage range for which conversion is possible is -11 to +11 V and here the converted value is a signed integer value (-16500 to +16500).

There is no disconnection detection function.

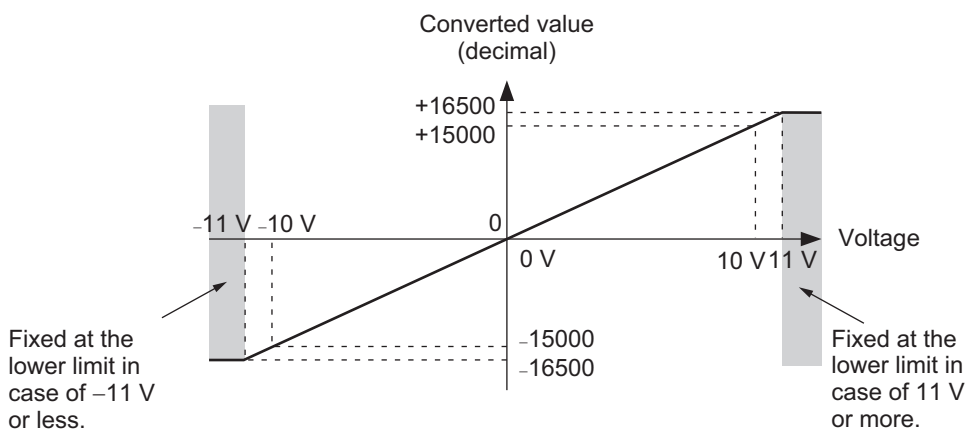

Input Range: 4 to 20 mA

● 1/8000 Resolution

A currents of 4 to 20 mA is converted to a signed integer value (0 to 8000).

The input current range for which conversion is possible is 3.2 to 20.8 mA and here the converted value is a signed integer value (-400 to +8400).

If the input value falls below the input range such as for a disconnection, and the input current is less than 1.2 mA, the disconnection detection function activates and the converted value is 32767.

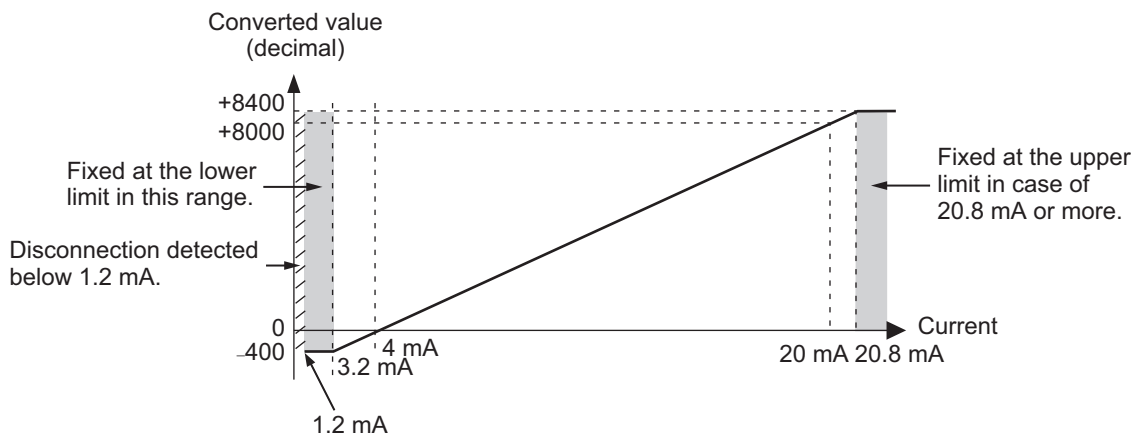

● 1/30000 Resolution

A currents of 4 to 20 mA is converted to a signed integer value (0 to 30000).

The input current range for which conversion is possible is 3.2 to 20.8 mA and here the converted value is a signed integer value (-1500 to +31500).

If the input value falls below the input range such as for a disconnection, and the input current is less than 1.2 mA, the disconnection detection function activates and the converted value is 32767.

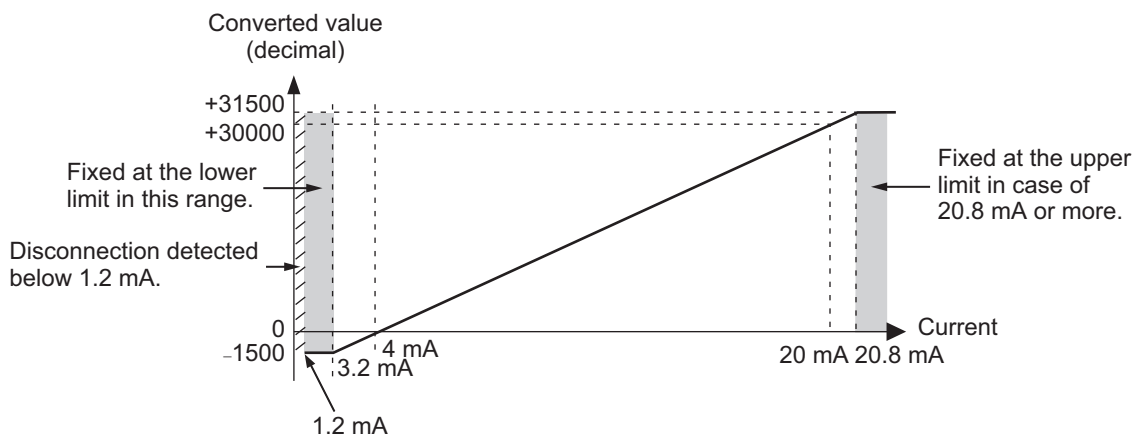

6-3 Specifications of I/O Data

This section describes the I/O data for the Analog Input Units.

6-3-1 Allocable I/O Data

This section describes the allocable I/O data in the Analog Input Unit.

An I/O entry mapping is assigned to the I/O allocation settings for the Analog Input Unit.

A specific I/O entry is assigned to the I/O entry mapping for each NX Unit model. These allocations are fixed, so you cannot add others or change them.

An I/O entry means the I/O data described in this section. An I/O entry mapping means a collection of I/O entries.

To assign the I/O allocation information of the EtherCAT Slave Terminal to an NJ-series CPU Unit, use the I/O ports for the allocated I/O data.

● Two-point Input Units

Data name	Description	Data type	Default value	I/O port name	Index	Sub-index
Ch1 Analog Input Value	Value of analog input 1	INT	0	Ch1 Analog Input Value	6000 hex	01 hex
Ch2 Analog Input Value	Value of analog input 2	INT	0	Ch2 Analog Input Value		02 hex

● Four-point Input Units

Data name	Description	Data type	Default value	I/O port name	Index	Sub-index
Ch1 Analog Input Value	Value of analog input 1	INT	0	Ch1 Analog Input Value	6000 hex	01 hex
Ch2 Analog Input Value	Value of analog input 2	INT	0	Ch2 Analog Input Value		02 hex
Ch3 Analog Input Value	Value of analog input 3	INT	0	Ch3 Analog Input Value		03 hex
Ch4 Analog Input Value	Value of analog input 4	INT	0	Ch4 Analog Input Value		04 hex

● Eight-point Input Units

Data name	Description	Data type	Default value	I/O port name	Index	Subindex
Ch1 Analog Input Value	Value of analog input 1	INT	0	Ch1 Analog Input Value	6000 hex	01 hex
Ch2 Analog Input Value	Value of analog input 2	INT	0	Ch2 Analog Input Value		02 hex
Ch3 Analog Input Value	Value of analog input 3	INT	0	Ch3 Analog Input Value		03 hex
Ch4 Analog Input Value	Value of analog input 4	INT	0	Ch4 Analog Input Value		04 hex
Ch5 Analog Input Value	Value of analog input 5	INT	0	Ch5 Analog Input Value		05 hex
Ch6 Analog Input Value	Value of analog input 6	INT	0	Ch6 Analog Input Value		06 hex
Ch7 Analog Input Value	Value of analog input 7	INT	0	Ch7 Analog Input Value		07 hex
Ch8 Analog Input Value	Value of analog input 8	INT	0	Ch8 Analog Input Value		08 hex

6-4 List of Settings

The followings are the setting descriptions, setting ranges, and default values of the functions that can be used in the Analog Input Units.

The settings are reflected after the Unit is restarted.



Precautions for Safe Use

The Unit is required to restart after the transfer of Unit operation settings on the Sysmac Studio is completed. Always sufficiently check the safety at the connected devices before you transfer the Unit operation settings.

● Two-point Input Units

Setting name	Description	Default value	Setting range	Unit	Index	Sub-index	Reference
Ch1 Enable/Disable	Set to enable or disable the channel.	TRUE	TRUE or FALSE	–	5002 hex	01 hex	P. 6-13
Ch2 Enable/Disable	FALSE: Disable TRUE: Enable	TRUE	TRUE or FALSE	–		02 hex	
Ch1 Range Setting	Set the range.	*1	*1	–	5003 hex	01 hex	P. 6-4
Ch2 Range Setting	0: 4 to 20 mA 1: 0 to 10 V 2: -10 to +10 V 3: 0 to 5 V 4: 1 to 5 V 5: 0 to 20 mA	*1	*1	–		02 hex	
Ch1 Input Moving Average Time	Set the time to process moving average.	0	*2	μs	5004 hex	01 hex	P. 6-19
Ch2 Input Moving Average Time		0	*2	μs		02 hex	

*1. The default value and setting range of Ch□ Range Setting depend on the model. The default value and setting range for each NX Unit are as follows.

NX Units	Default value	Setting range
NX-AD2203/AD2204/AD2208	0	0
NX-AD2603/AD2604/AD2608	2	2

*2. The setting range of Ch□ Input Moving Average Time depends on the model. The setting range for each model is as follows.

NX Units	Setting range
NX-AD2203/AD2204/AD2603/AD2604	0 to 32000
NX-AD2208/AD2608	0 to 640

● Four-point Input Units

Setting name	Description	Default value	Setting range	Unit	Index	Subindex	Reference
Ch1 Enable/Disable	Set to enable or disable the channel. FALSE: Disable TRUE: Enable	TRUE	TRUE or FALSE	–	5002 hex	01 hex	P. 6-13
Ch2 Enable/Disable		TRUE	TRUE or FALSE	–		02 hex	
Ch3 Enable/Disable		TRUE	TRUE or FALSE	–		03 hex	
Ch4 Enable/Disable		TRUE	TRUE or FALSE	–		04 hex	
Ch1 Range Setting	Set the range. 0: 4 to 20 mA 1: 0 to 10 V 2: -10 to +10 V 3: 0 to 5 V 4: 1 to 5 V 5: 0 to 20 mA	*1	*1	–	5003 hex	01 hex	P. 6-4
Ch2 Range Setting		*1	*1	–		02 hex	
Ch3 Range Setting		*1	*1	–		03 hex	
Ch4 Range Setting		*1	*1	–		04 hex	
Ch1 Input Moving Average Time	Set the time to process moving average.	0	*2	μs	5004 hex	01 hex	P. 6-19
Ch2 Input Moving Average Time		0	*2	μs		02 hex	
Ch3 Input Moving Average Time		0	*2	μs		03 hex	
Ch4 Input Moving Average Time		0	*2	μs		04 hex	

*1. The default value and setting range of Ch□ Range Setting depend on the model. The default value and setting range for each NX Unit are as follows.

NX Units	Default value	Setting range
NX-AD3203/AD3204/AD3208	0	0
NX-AD3603/AD3604/AD3608	2	2

*2. The setting range of Ch□ Input Moving Average Time depends on the model. The setting range for each model is as follows.

NX Units	Setting range
NX-AD3203/AD3204/AD3603/AD3604	0 to 32000
NX-AD3208/3608	0 to 640

● Eight-point Input Units

Setting name	Description	Default value	Setting range	Unit	Index	Sub-index	Reference
Ch1 Enable/Disable	Set to enable or disable the channel. FALSE: Disable TRUE: Enable	TRUE	TRUE or FALSE	–	5002 hex	01 hex	P. 6-13
Ch2 Enable/Disable		TRUE	TRUE or FALSE	–		02 hex	
Ch3 Enable/Disable		TRUE	TRUE or FALSE	–		03 hex	
Ch4 Enable/Disable		TRUE	TRUE or FALSE	–		04 hex	
Ch5 Enable/Disable		TRUE	TRUE or FALSE	–		05 hex	
Ch6 Enable/Disable		TRUE	TRUE or FALSE	–		06 hex	
Ch7 Enable/Disable		TRUE	TRUE or FALSE	–		07 hex	
Ch8 Enable/Disable		TRUE	TRUE or FALSE	–		08 hex	
Ch1 Range Setting	Set the range. 0: 4 to 20 mA 1: 0 to 10 V 2: -10 to +10 V 3: 0 to 5 V 4: 1 to 5 V 5: 0 to 20 mA	*1	*1	–	5003 hex	01 hex	P. 6-4
Ch2 Range Setting		*1	*1	–		02 hex	
Ch3 Range Setting		*1	*1	–		03 hex	
Ch4 Range Setting		*1	*1	–		04 hex	
Ch5 Range Setting		*1	*1	–		05 hex	
Ch6 Range Setting		*1	*1	–		06 hex	
Ch7 Range Setting		*1	*1	–		07 hex	
Ch8 Range Setting		*1	*1	–		08 hex	
Ch1 Input Moving Average Time	Set the time to process moving average.	0	*2	μs	5004 hex	01 hex	P. 6-19
Ch2 Input Moving Average Time		0	*2	μs		02 hex	
Ch3 Input Moving Average Time		0	*2	μs		03 hex	
Ch4 Input Moving Average Time		0	*2	μs		04 hex	
Ch5 Input Moving Average Time		0	*2	μs		05 hex	
Ch6 Input Moving Average Time		0	*2	μs		06 hex	
Ch7 Input Moving Average Time		0	*2	μs		07 hex	
Ch8 Input Moving Average Time		0	*2	μs		08 hex	

*1. The default value and setting range of Ch□ Range Setting depend on the model. The default value and setting range for each NX Unit are as follows.

NX Units	Default value	Setting range
NX-AD4203/AD4204/AD4208	0	0
NX-AD4603/AD4604/AD4608	2	2

- *2. The setting range of Ch□ Input Moving Average Time depends on the model. The setting range for each model is as follows.

NX Units	Setting range
NX-AD4203/AD4204/AD4603/AD4604	0 to 32000
NX-AD4208/4608	0 to 640

6-5 Function

This section describes the Analog Input Unit functions.

Refer to the specifications of each model in *A-1 Data Sheet* on page A-2 for details on the functions.

6-5-1 List of Analog Input Unit Functions

Function name	Description	Reference
Free-Run Refreshing	With this I/O refreshing method, the refresh cycle of the NX bus and the I/O refresh cycles of the NX Units are asynchronous.	5-2-4 <i>Free-Run Refreshing</i> on page 5-4
Synchronous I/O Refreshing	With this I/O refreshing method, the timing to read inputs or to refresh outputs is synchronous on a fixed interval between more than one NX Unit on more than one Slave Terminal.	5-2-5 <i>Synchronous Input Refreshing</i> on page 5-9
Selecting Channel To Use	This function omits the conversion processing for unused inputs. It is used to reduce the conversion cycle for its own Unit.	6-5-2 <i>Selecting Channel To Use</i> on page 6-13
Moving Average	This function uses the average value of inputs of the set time as the converted value. When the input value fluctuates frequently due to noises, averaging can be used to obtain a stable converted value. This function can be used only for Free-Run refreshing.	6-5-3 <i>Moving Average</i> on page 6-19
Input Disconnection Detection	This function detects disconnections of the analog input signal lines. It can be used only for models with an input range of 4 to 20 mA.	6-5-4 <i>Input Disconnection Detection</i> on page 6-27
Over Range/Under Range Detection	This function detects when the input signal exceeds the range for which conversion is possible.	6-5-5 <i>Over Range/Under Range Detection</i> on page 6-28
User Calibration	This function corrects offsets in the converted values that occur due to the deterioration of the NX Units and calibrate the Units.	6-5-6 <i>User Calibration</i> on page 6-29

6-5-2 Selecting Channel To Use

Purpose

This function skips the conversion processing and error detection processing for unused inputs, and shortens the conversion time.

Details on the Function

Normally in this Unit, the input signals for the number of input points are converted in sequence. The setting can be changed, so that unused inputs are not converted.

By reducing the number of conversion points, the conversion time is shortened.

Whether the channel is enabled or disabled is settable for each input.

However, set the Ch□ Enable/Disable parameter to *Enable* for at least one channel for a Unit.

If you disabled all channels for a Unit, an NX Unit Initialization Error event (event code: 84C10000 hex) occurs.

Refer to the *EtherCAT Coupler Unit User's Manual* (Cat. No. W519) for details on events.

● Two-point Input Units

Setting name	Description	Default value	Unit
Ch1 Enable/Disable	Set to enable or disable the channel.	TRUE	–
Ch2 Enable/Disable		TRUE	–
	FALSE: Disable TRUE: Enable		

● Four-point Input Units

Setting name	Description	Default value	Unit
Ch1 Enable/Disable	Set to enable or disable the channel.	TRUE	–
Ch2 Enable/Disable		TRUE	–
Ch3 Enable/Disable		TRUE	–
Ch4 Enable/Disable		TRUE	–
	FALSE: Disable TRUE: Enable		

● Eight-point Input Units

Setting name	Description	Default value	Unit
Ch1 Enable/Disable	Set to enable or disable the channel.	TRUE	–
Ch2 Enable/Disable		TRUE	–
Ch3 Enable/Disable		TRUE	–
Ch4 Enable/Disable		TRUE	–
Ch5 Enable/Disable		TRUE	–
Ch6 Enable/Disable		TRUE	–
Ch7 Enable/Disable		TRUE	–
Ch8 Enable/Disable		TRUE	–

Target NX Units

All Analog Input Units

Setting Method

● Use the Sysmac Studio

- 1 Use any of the following methods to display the Edit Unit Operation Settings Tab Page on the Edit Slave Terminal Configuration Tab Page.

Double-click the NX Unit.

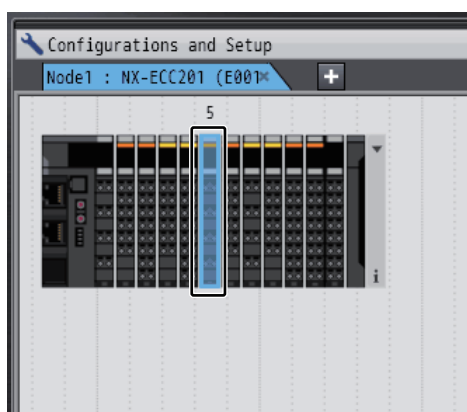

Right-click the NX Unit, then select *Edit Unit Operation Settings* from the menu.

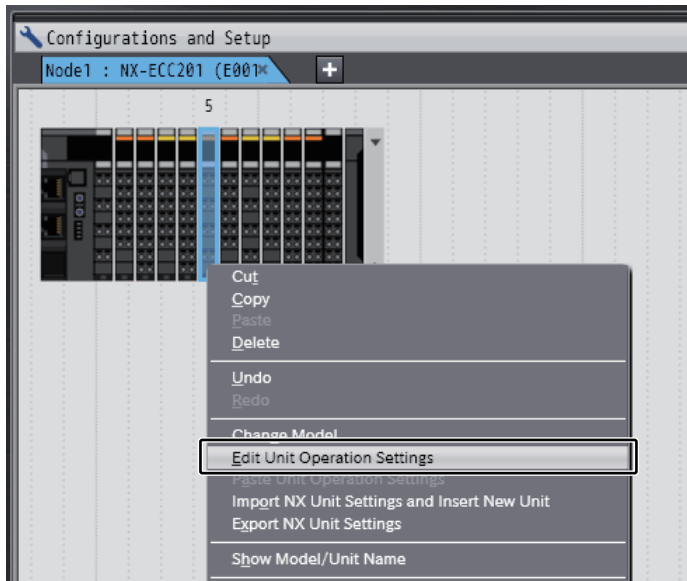

Select the NX Unit, then click the **Edit Unit Operation Settings** Button.

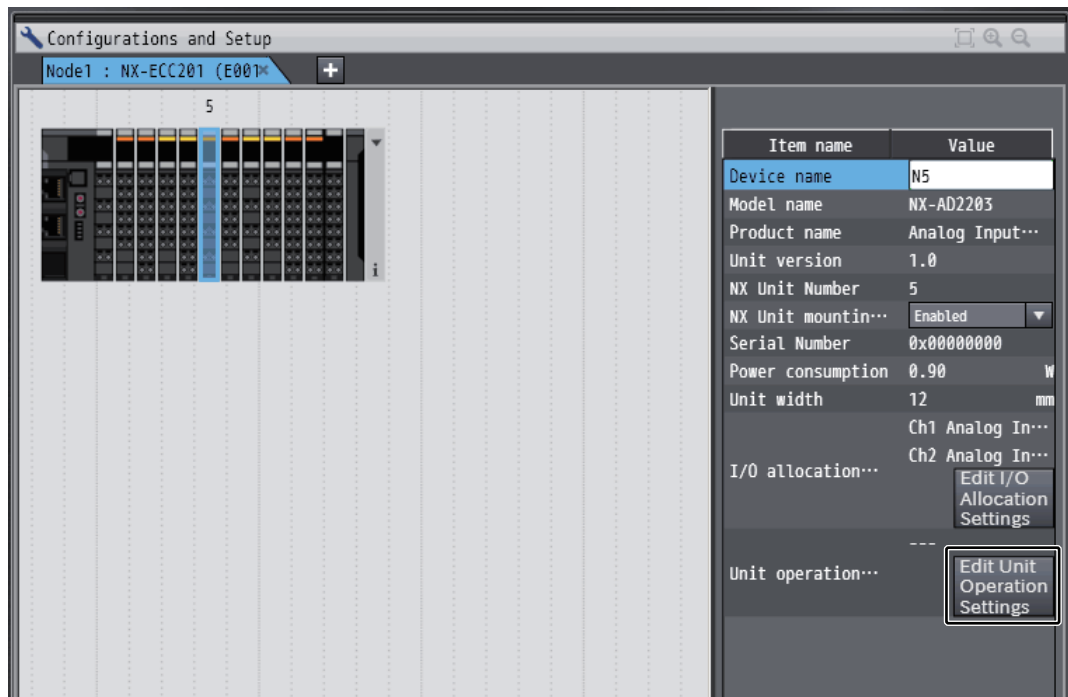

The Edit Unit Operation Settings Tab Page is displayed.

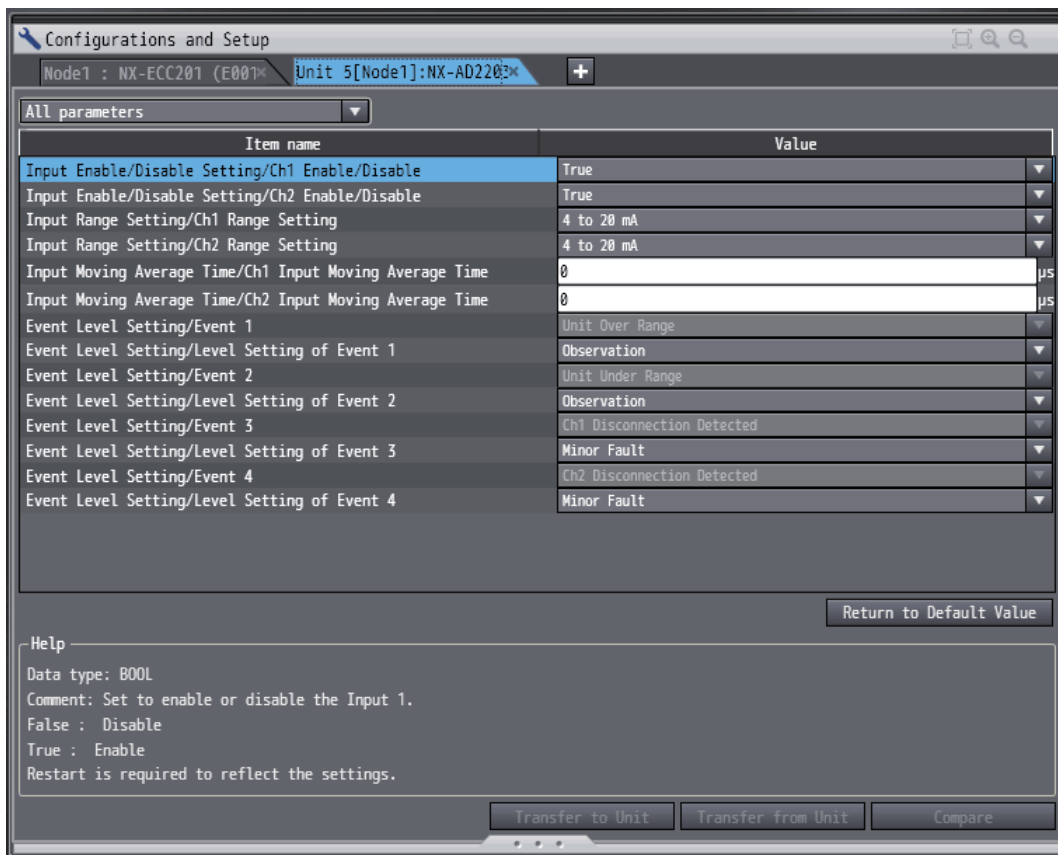

- 2 Select *True* (Enable) or *False* (Disable) from the list of Input Enable/Disable Setting for which the channel you want to set.

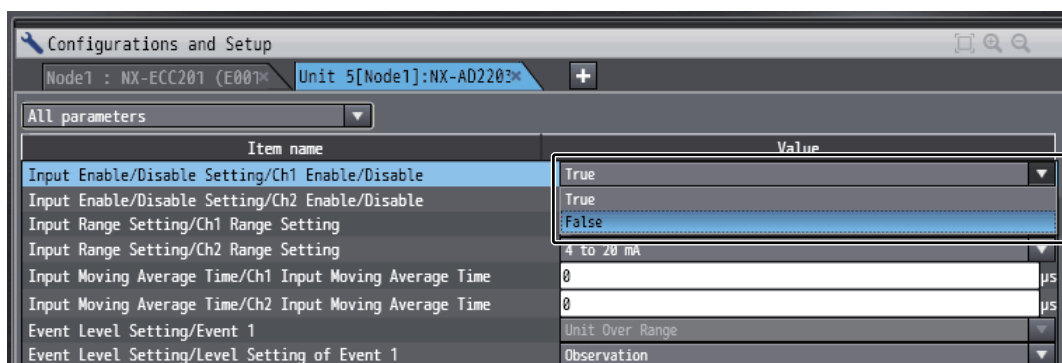



Additional Information

- Click a list button on the tab page to display the item in the Edit Unit Operation Settings Tab Page.

Example:

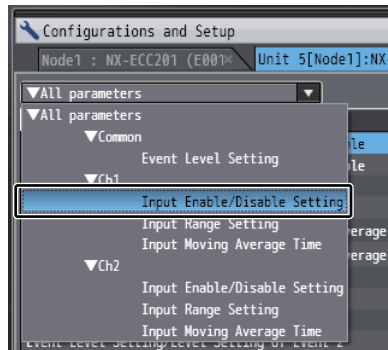

Select Input Enable/Disable Setting under Ch1

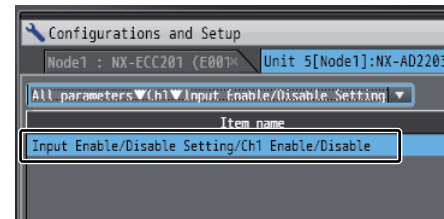

Only Input Enable/Disable Setting under Ch1 is displayed

- If you set a value different from the default value, the Value on the Sysmac Studio is displayed in a different color.
- You can click the **Return to Default Value** Button to return all set values on the Sysmac Studio to the default values.
- Help for the settings is displayed at the bottom of the Edit Unit Operation Settings Tab Page.

3 Click the **Transfer to Unit** Button.

The settings are transferred from the Sysmac Studio to the NX Unit.

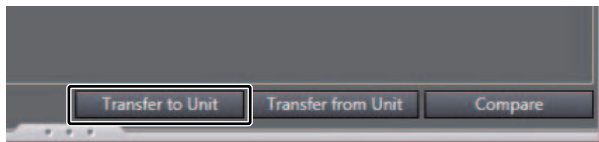

The settings are reflected after the Unit is restarted.



Precautions for Safe Use

The Unit is required to restart after the transfer of Unit operation settings on the Sysmac Studio is completed. Always sufficiently check the safety at the connected devices before you transfer the Unit operation settings.

Calculating Conversion Time

The conversion time per unit according to the number of available conversion channels is as follows.

Number of available conversion channels	Conversion time per unit (μs)	
	Conversion time: 250 $\mu\text{s}/\text{point}$	Conversion time: 10 $\mu\text{s}/\text{point}$
1 channel	250	10
2 channels	500	20
3 channels	750	30
4 channels	1000	40
5 channels	1250	50
6 channels	1500	60
7 channels	1750	70
8 channels	2000	80

6-5-3 Moving Average

Purpose

This function averages the inputs if they fluctuate minutely due to noise and so on as shown in the figure below, and obtains smooth input values.

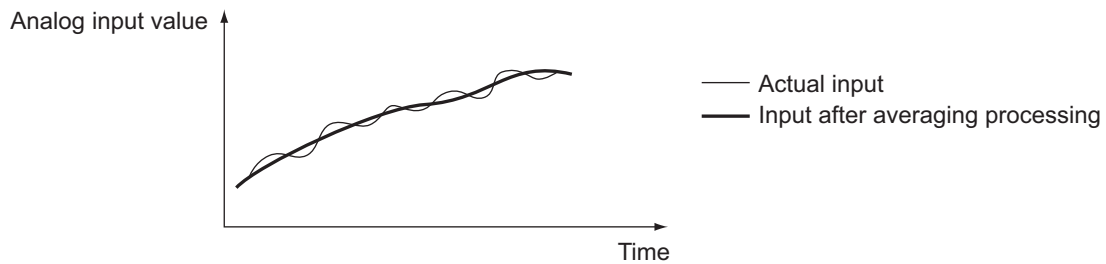

Details on the Function

For the inputs for which the used channels are set to enable, the average value (moving average) of analog inputs is calculated for a maximum of 32000 μs (conversion time: 250 $\mu\text{s}/\text{point}$) or 640 μs (conversion time: 10 $\mu\text{s}/\text{point}$) and it is used as the converted value.

However, if the Analog Input Unit is set to operate with synchronous I/O refreshing, the moving average function does not operate regardless of the set value of the input moving average time.

The processing contents in the Unit are shown below as an example, in which an NX Unit with a conversion time of 250 $\mu\text{s}/\text{point}$ is used, 4 points are enabled and the input moving average time is set to 4000 μs .

At the initial calculation, the initial data is stored in all moving average buffers to perform the moving average processing.

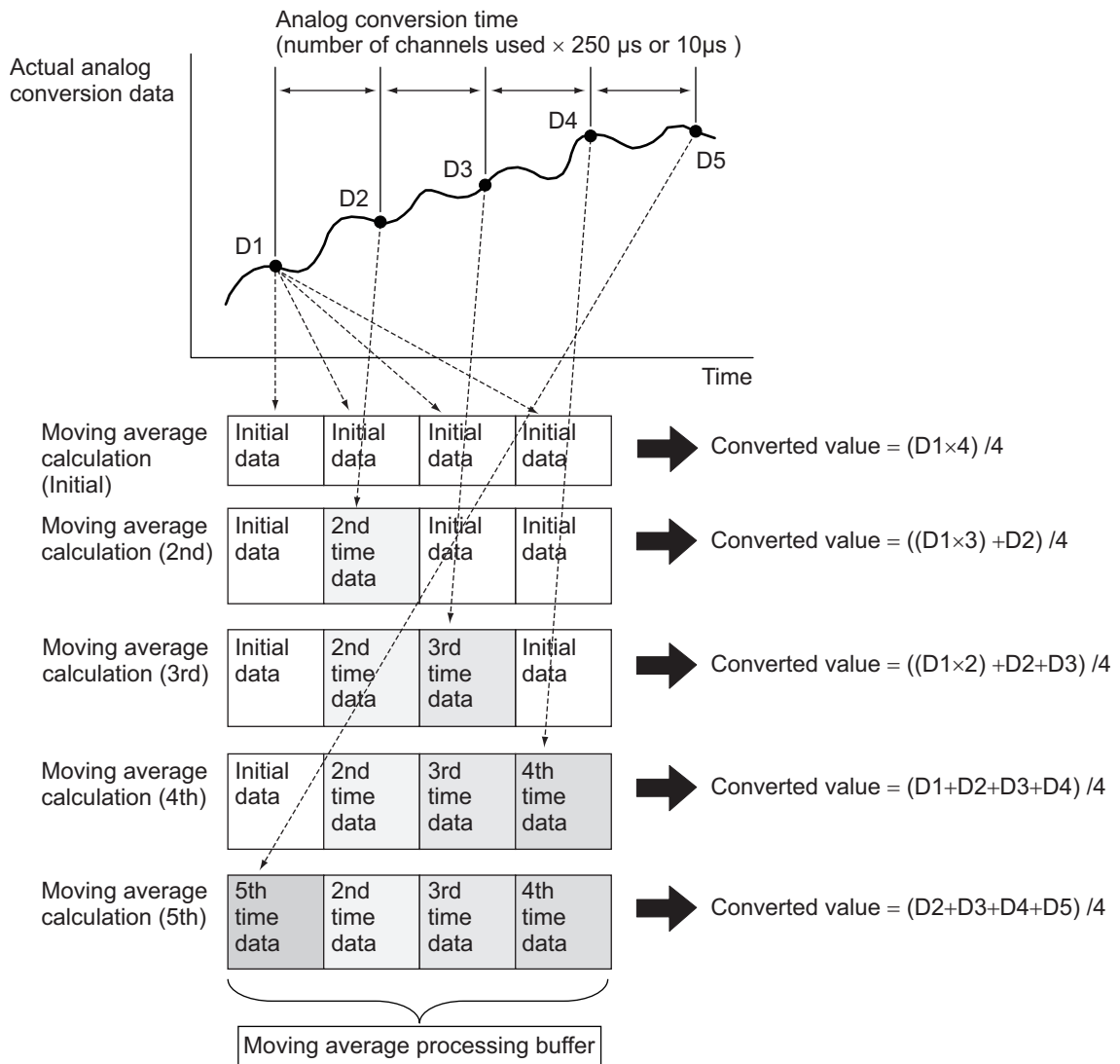

The settings are made by the "input moving average time (μs)".

The input moving average time can be set for each input.

The input moving average time is:

The number of data items for which the moving average is processed x analog conversion time (number of channels used x 250 μs)

Note that if 0 is set, the moving average processing is not performed.

[Setting example of input moving average time]

When the number of channels used is to be set to 4 and the number of sampling data items to 4:

Input moving average time = $4 \times (4 \times 250 \mu s) = 4000 \mu s$ (set value: 4000)

● Two-point Input Units

Setting name	Description	Default value	Setting range	Unit
Ch1 Input Moving Average Time	Set the time to process moving average.	0	*1	μs
Ch2 Input Moving Average Time		0	*1	μs

*1. The setting range of Ch□ Input Moving Average Time depends on the model. The setting range for each model is as follows.

NX Units	Setting range
NX-AD2203/AD2204/AD2603/AD2604	0 to 32000
NX-AD2208/AD2608	0 to 640

● Four-point Input Units

Setting name	Description	Default value	Setting range	Unit
Ch1 Input Moving Average Time	Set the time to process moving average.	0	*1	μs
Ch2 Input Moving Average Time		0	*1	μs
Ch3 Input Moving Average Time		0	*1	μs
Ch4 Input Moving Average Time		0	*1	μs

*1. The setting range of Ch□ Input Moving Average Time depends on the model. The setting range for each model is as follows.

NX Units	Setting range
NX-AD3203/AD3204/AD3603/AD3604	0 to 32000
NX-AD3208/AD3608	0 to 640

● Eight-point Input Units

Setting name	Description	Default value	Setting range	Unit
Ch1 Input Moving Average Time	Set the time to process moving average.	0	*1	μs
Ch2 Input Moving Average Time		0	*1	μs
Ch3 Input Moving Average Time		0	*1	μs
Ch4 Input Moving Average Time		0	*1	μs
Ch5 Input Moving Average Time		0	*1	μs
Ch6 Input Moving Average Time		0	*1	μs
Ch7 Input Moving Average Time		0	*1	μs
Ch8 Input Moving Average Time		0	*1	μs

*1. The setting range of Ch□ Input Moving Average Time depends on the model. The setting range for each model is as follows.

NX Units	Setting range
NX-AD4203/AD4204/AD4603/AD4604	0 to 32000
NX-AD4208/AD4608	0 to 640

Target NX Units

All Analog Input Units

Setting Method

- Use the Sysmac Studio

- 1 Use any of the following methods to display the Edit Unit Operation Settings Tab Page on the Edit Slave Terminal Configuration Tab Page.

Double-click the NX Unit.

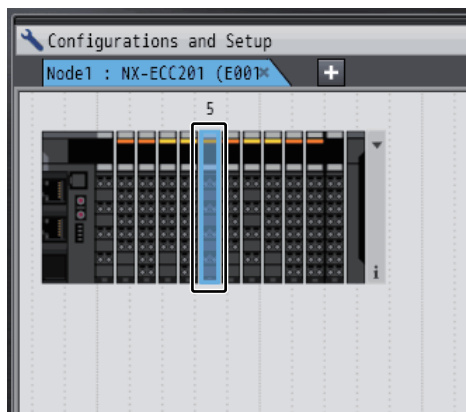

Right-click the NX Unit, then select *Edit Unit Operation Settings* from the menu.

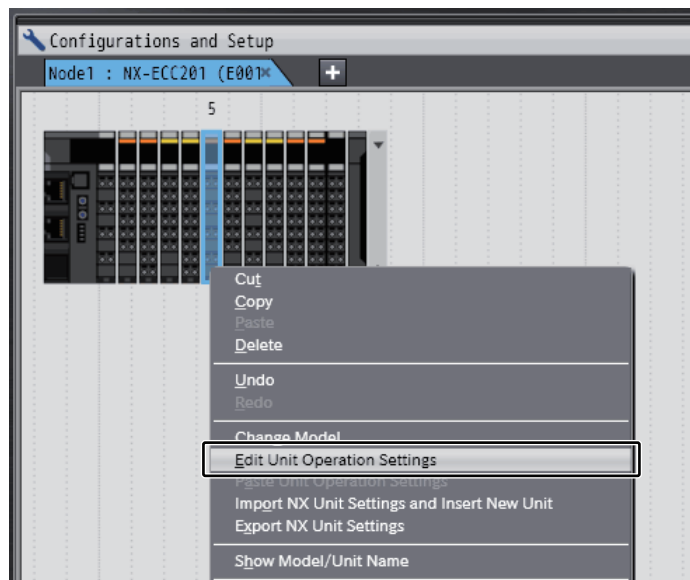

Select the NX Unit, then click the **Edit Unit Operation Settings** Button.

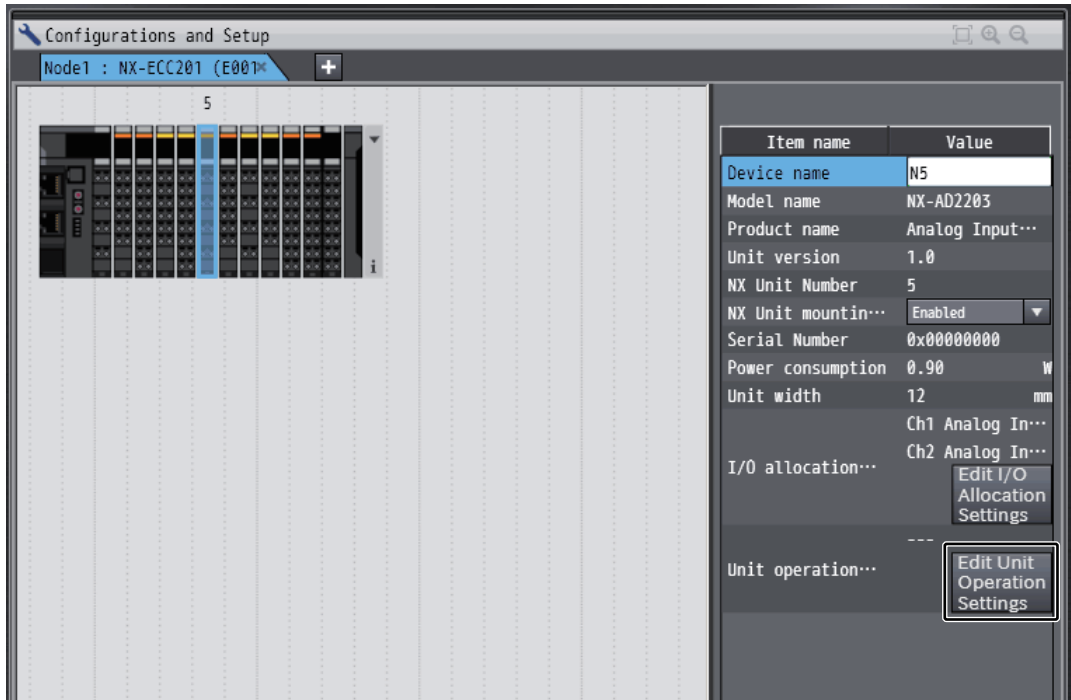

The Edit Unit Operation Settings Tab Page is displayed.

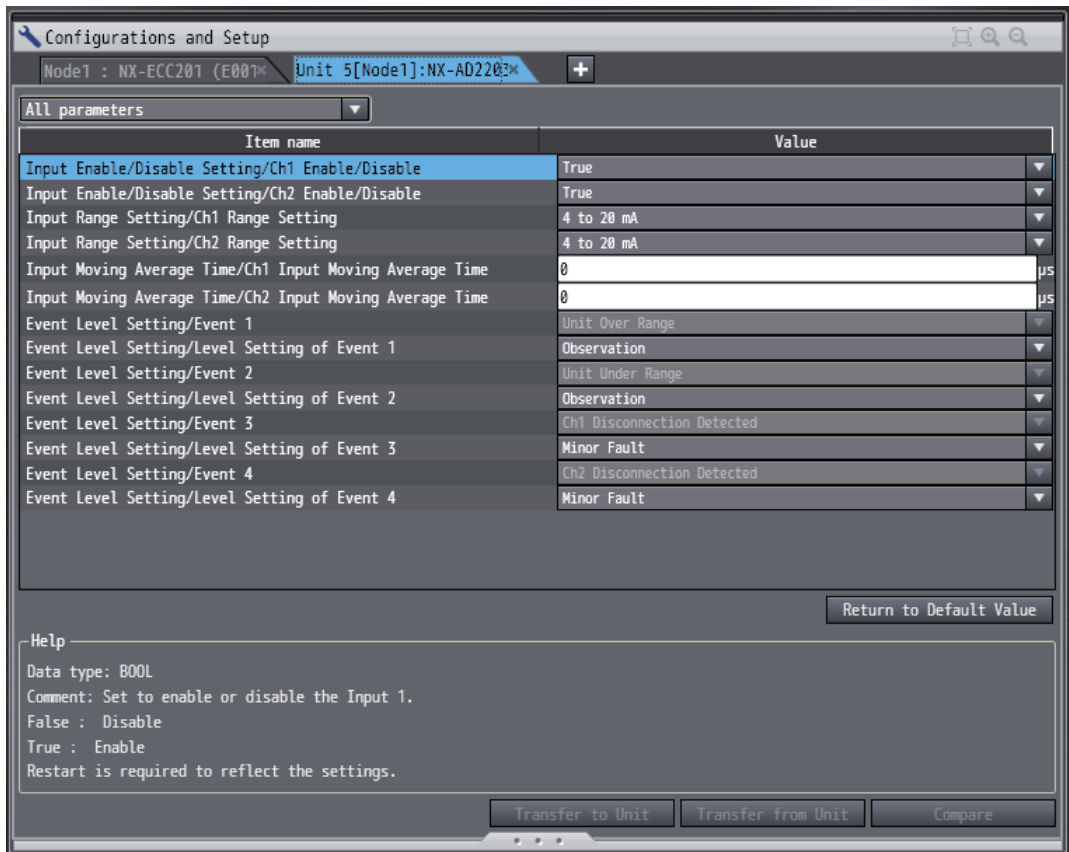

- 2 Enter the time to process moving average (0 to 32000 or 0 to 640 μ s) in the text box of Input Moving Average Time for the channel you want to set.

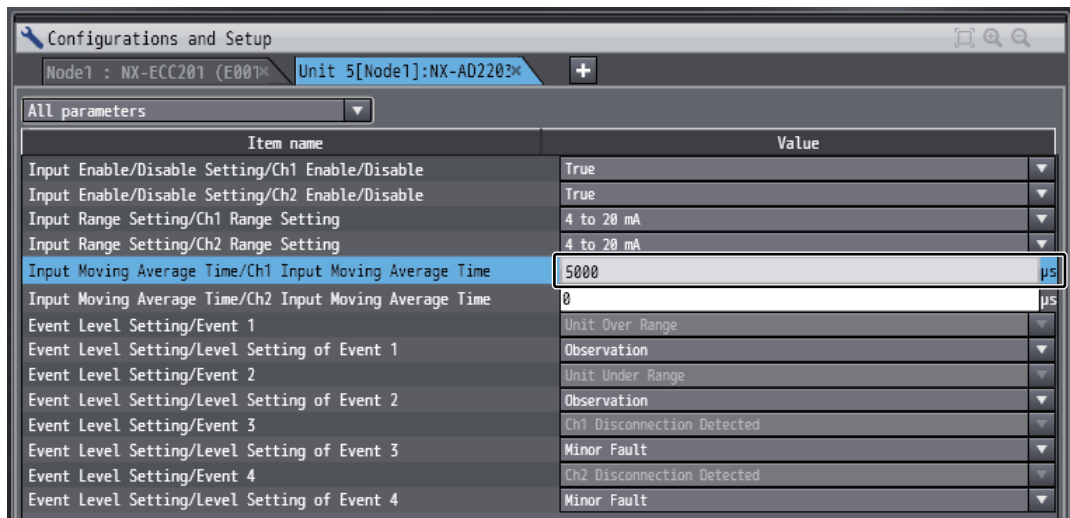

Additional Information

- Click a list button on the tab page to display the item in the Edit Unit Operation Settings Tab Page.

Example:

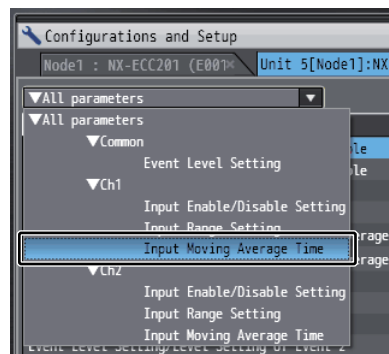

Select Input Moving Average Time under Ch1

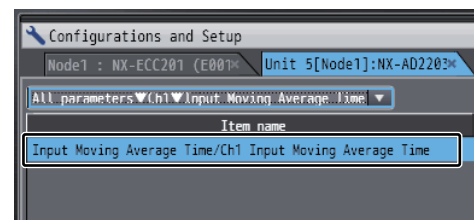

Only Input Moving Average Time under Ch1 is displayed

- If you set a value different from the default value, the Value on the Sysmac Studio is displayed in a different color.
- You can click the **Return to Default Value** Button to return all set values on the Sysmac Studio to the default values.
- Help for the settings is displayed at the bottom of the Edit Unit Operation Settings Tab Page.

3 Click the **Transfer to Unit** Button.

The settings are transferred from the Sysmac Studio to the NX Unit.



The settings are reflected after the Unit is restarted.



Precautions for Safe Use

The Unit is required to restart after the transfer of Unit operation settings on the Sysmac Studio is completed. Always sufficiently check the safety at the connected devices before you transfer the Unit operation settings.

6-5-4 Input Disconnection Detection

Purpose

This function detects disconnections of the analog input signal lines. However, it is only available when the input range is 4 to 20 mA.

Details on the Function

- If any analog input signal line (current inputs) of the inputs that are enabled by the selecting channel to use function is disconnected, or the input current is less than 1.2 mA, the converted value is 32767. At this time, the Disconnection Detection Status turns ON and an Unit I/O Disconnection Detected for Channel□ event (event code: 65030000 hex to 65A00000 hex) occurs.
- If the input returns to the conversion range again, the value becomes the normal converted value. When the cause of the error is removed and the error is reset, the Disconnection Detection Status turns OFF.
- Refer to *A-3 List of NX Objects* on page A-58 for details on status and *9-3-2 Event Codes and Corrections for Errors* on page 9-9 for details on events.

Target NX Units

Analog Input Units with the input range of 4 to 20 mA

Setting Method

No setting is required.

6-5-5 Over Range/Under Range Detection

Purpose

This function detects when the input signal exceeds the range for which conversion is possible.

Details on the Function

- If the input signal exceeds the upper limit of the conversion range, the converted value is fixed at the upper limit. At this time, the Over Range Status turns ON and an Unit Over Range for Channel□ event (event code: 64F00000 to 64F70000 hex) occurs.
- If the input signal falls below the lower limit of the conversion range, the converted value is fixed at the lower limit. At this time, the Under Range Status turns ON and an Unit Under Range for Channel□ event (event code: 64F80000 to 64FF0000 hex) occurs.
- When the input signal returns to the conversion range, the fixing is cancelled and the value becomes the normal converted value. When the cause of the error is removed and the error is reset, the Over Range/Under Range Status turns OFF.
- Refer to *A-3 List of NX Objects* on page A-58 for details on status and *9-3-2 Event Codes and Corrections for Errors* on page 9-9 for details on events.

Target NX Units

All Analog Input Units

Setting Method

No setting is required.

6-5-6 User Calibration

Purpose

This function corrects offsets in the converted values that occur due to the deterioration of the NX Units and calibrate the Units again.

You can use this function to calibrate the equipment that requires the periodic calibration.

Details on the Function

This function corrects the converted values of input voltages and input currents at 2 points, 0% and 100%, as shown in the figure below.

The calibration result is saved in the NX Unit.

● Calibration Example 1

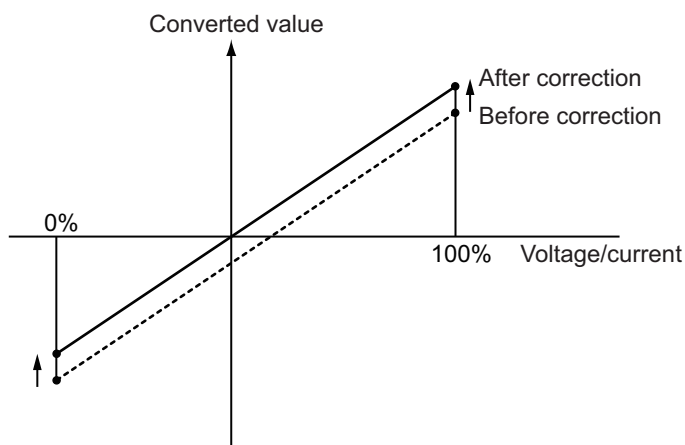

● Calibration Example 2

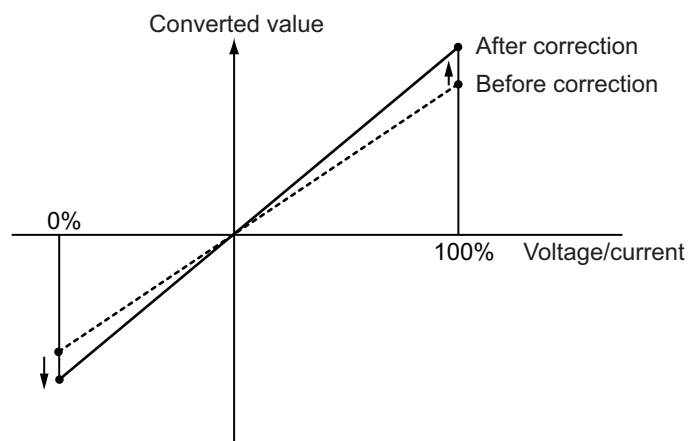

● Correctable Range

The correctable range is -5 to 5% of the input full scale.

The correctable range for each input range is as follows.

Input range	Correctable range	
	0%	100%
-10 to +10 V	-11 to -9.0 V	9.0 to 11 V
4 to 20 mA	3.2 to 4.8 mA	19.2 to 20.8 mA

Target NX Units

All Analog Input Units

Setting Method

● Use the Sysmac Studio

- 1 Right-click the NX Unit, then select *User Calibration* from the menu.

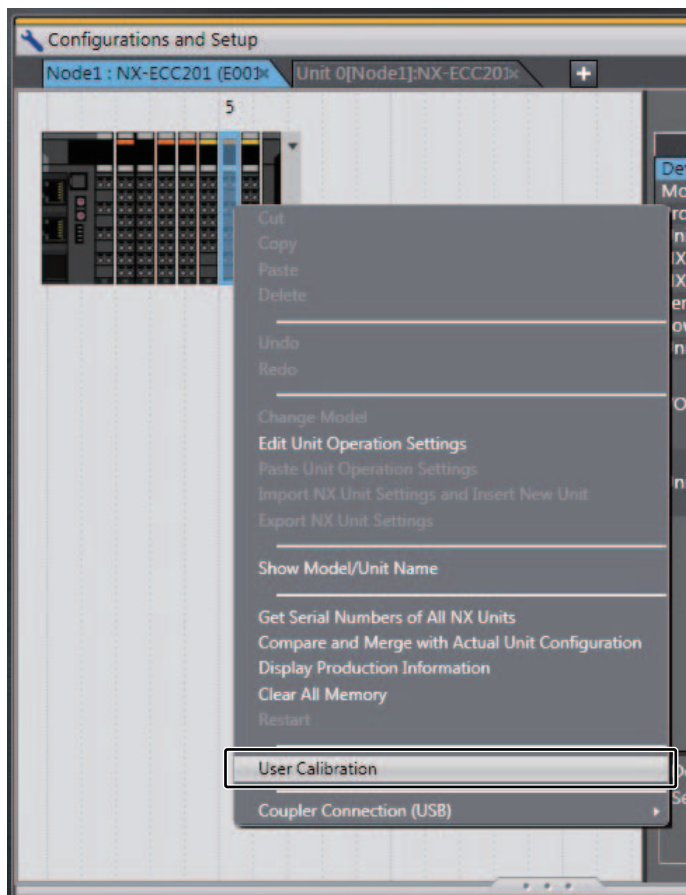

- 2** Select the channel you want to calibrate from Channel.

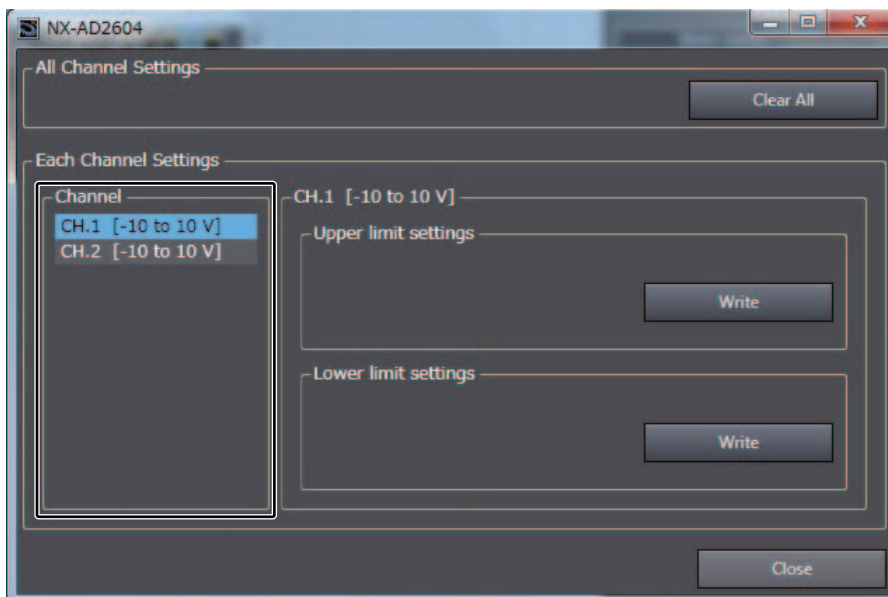

- 3** Enter the voltage or current corresponding to upper limit (100%) to the Unit terminal, then click the **Write** Button under Upper limit settings.

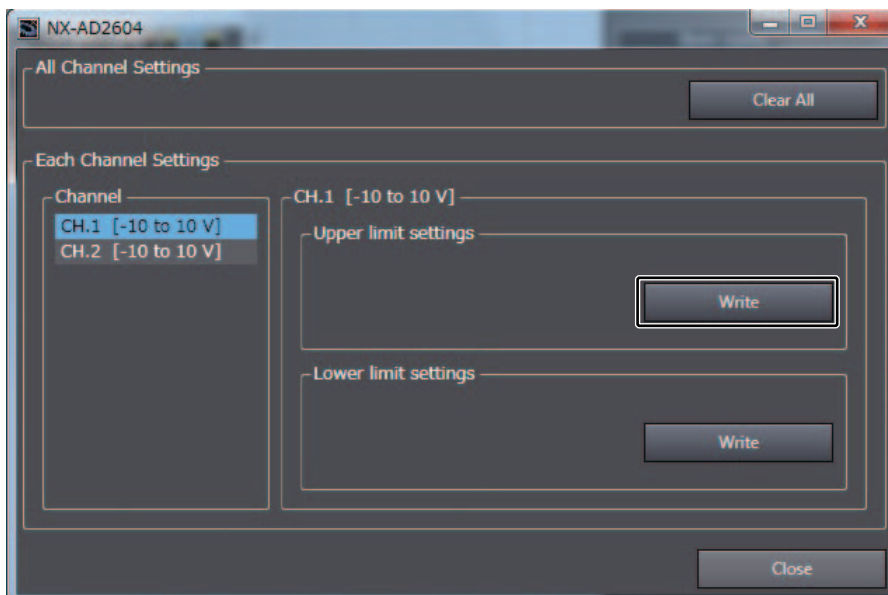

- 4** Click the **Yes** Button on the confirmation message.

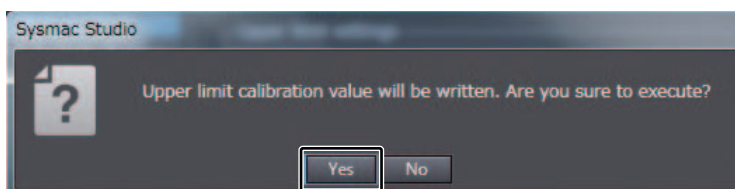

When the writing is completed successfully, the following message is displayed. Click the **OK** Button.

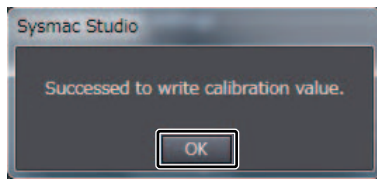

- 5** Enter the voltage or current corresponding to lower limit (0%) to the Unit terminal, then click the **Write** Button under Lower limit settings.

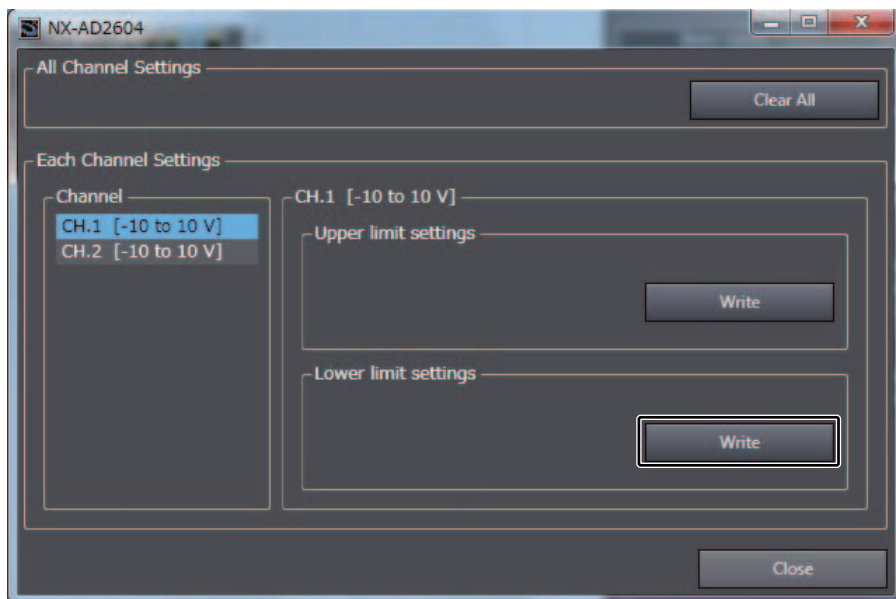

- 6** Click the **Yes** Button on the confirmation message.

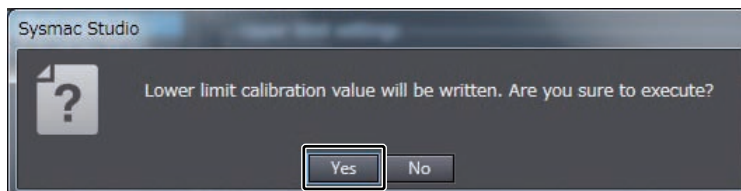

When the writing is completed successfully, the following message is displayed. Click the **OK** Button.

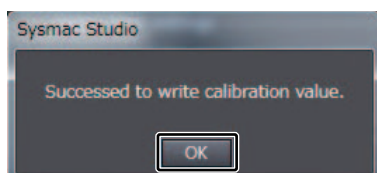



Additional Information

- A new calibration value is reflected immediately after you write it.
- When you write a calibration value, if the voltage or current that is input to the Unit terminal is outside the correctable range, the following message will be displayed and calibration will fail.

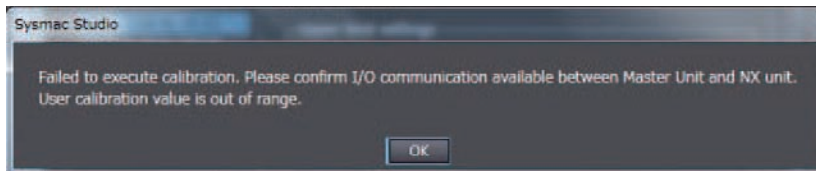

- **Reset the Calibration Value to the Default**

You can reset the calibration value to the default.

- 1 Right-click the NX Unit, then select *User Calibration* from the menu.

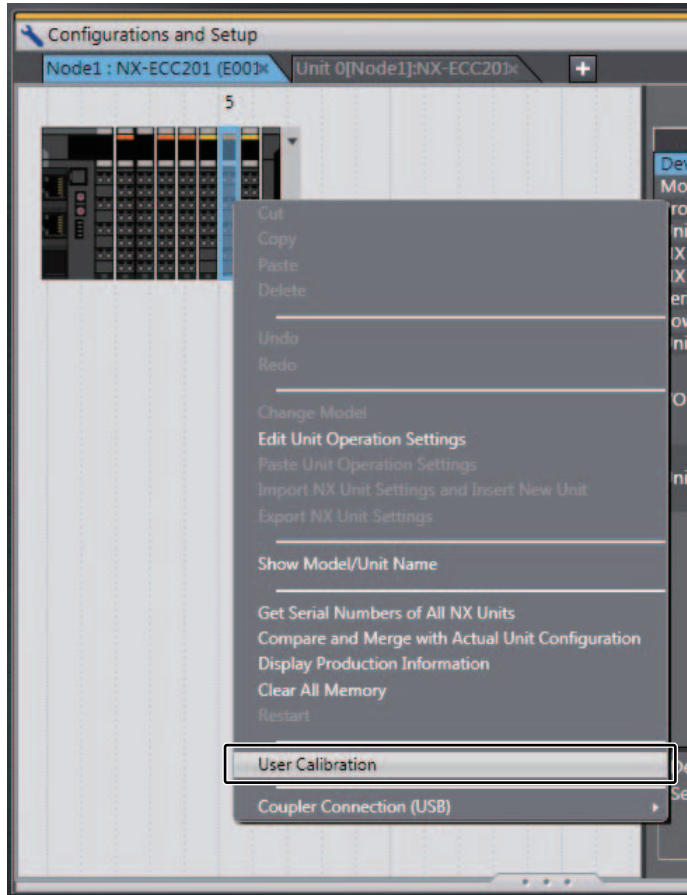

- 2 Click the **Clear All** Button under All Channel Settings.

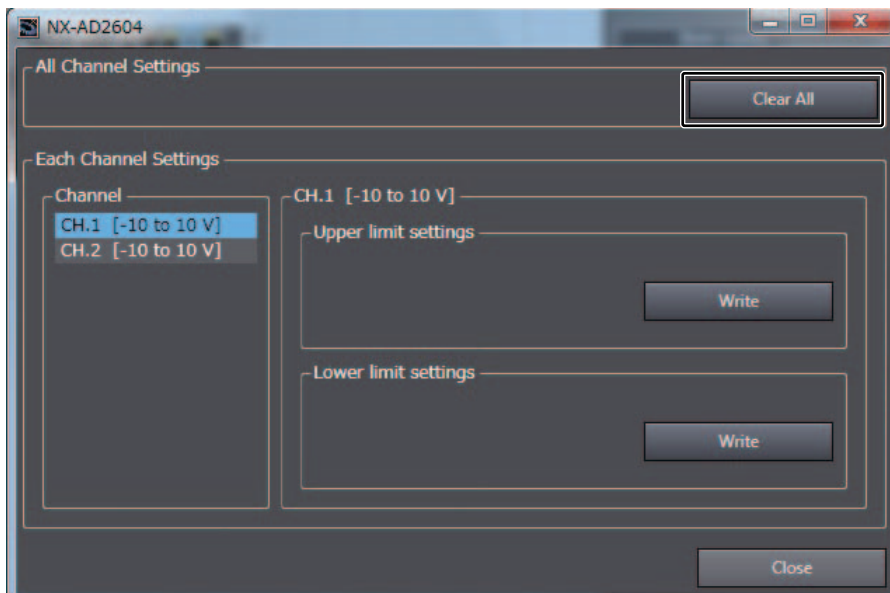

- 3 Click the **Yes** Button on the confirmation message.

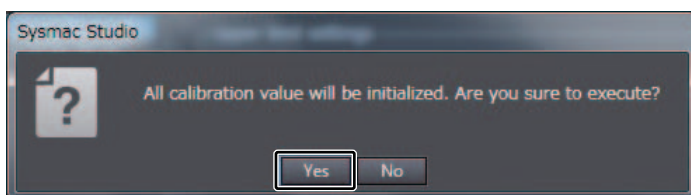

When the writing is completed successfully, the following message is displayed. Click the **OK** Button.

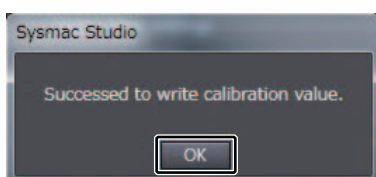

7

Analog Output Units

This section describes the types and functions of Analog Output Units.

7-1	Types of Analog Output Units	7-2
7-2	Output Range and Output Set Values	7-3
7-3	Specifications of I/O Data	7-5
7-3-1	Allocable I/O Data	7-5
7-4	List of Settings	7-6
7-5	Functions	7-9
7-5-1	List of Analog Output Unit Functions	7-9
7-5-2	Selecting Channel To Use	7-10
7-5-3	Load Rejection Output Setting	7-15
7-5-4	Over Range/Under Range Detection	7-21
7-5-5	User Calibration	7-22

7-1 Types of Analog Output Units

Analog Output Units are the NX Units with functionality to convert output set values set by the user program to analog signals such as -10 to 10 V and 4 to 20 mA.

The Analog Output Unit types are described below.

Analog Output Units (Screwless Clamping Terminal Block, 12 mm Width)

Model	Number of points	Output range	Resolution	I/O refreshing method	Conversion time	Reference
NX-DA2203	2 points	4 to 20 mA	1/8000	Free-Run refreshing	250 μ s/point	P. A-25
NX-DA2205			1/30000	Switching Synchronous I/O refreshing and Free-Run refreshing	μ s/point	P. A-27
NX-DA2603		-10 to +10 V	1/8000	Free-Run refreshing	250 μ s/point	P. A-29
NX-DA2605			1/30000	Switching Synchronous I/O refreshing and Free-Run refreshing	10 μ s/point	P. A-30
NX-DA3203	4 points	4 to 20 mA	1/8000	Free-Run refreshing	250 μ s/point	P. A-31
NX-DA3205			1/30000	Switching Synchronous I/O refreshing and Free-Run refreshing	10 μ s/point	P. A-33
NX-DA3603		-10 to +10 V	1/8000	Free-Run refreshing	250 μ s/point	P. A-35
NX-DA3605			1/30000	Switching Synchronous I/O refreshing and Free-Run refreshing	10 μ s/point	P. A-36

7-2 Output Range and Output Set Values

Output set values set by the user program are converted to analog signals according to the output range shown below.

If the output set value exceeds the value range for which conversion is possible, the analog value fixed at the upper or lower limit.

Output Range: -10 to +10 V

● 1/8000 Resolution

The output set values of the signed integer (-4000 to +4000) is converted to voltage from -10 to +10 V and output.

The output set value range for which conversion is possible is the signed integer (-4400 to +4400) and for this case the output voltage becomes from -11 to +11 V.

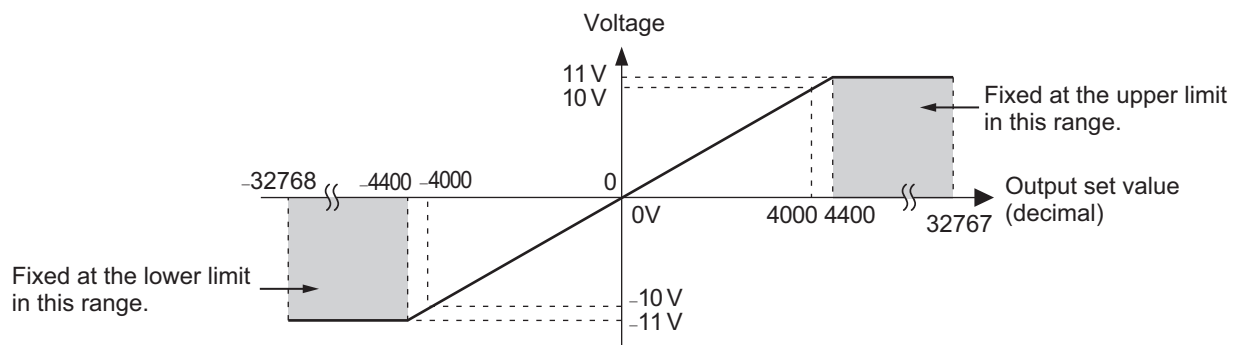

● 1/30000 Resolution

The output set values of the signed integer (-15000 to +15000) is converted to voltage from -10 to +10 V and output.

The output set value range for which conversion is possible is the signed integer (-16500 to +16500) and for this case the output voltage becomes from -11 to +11 V.

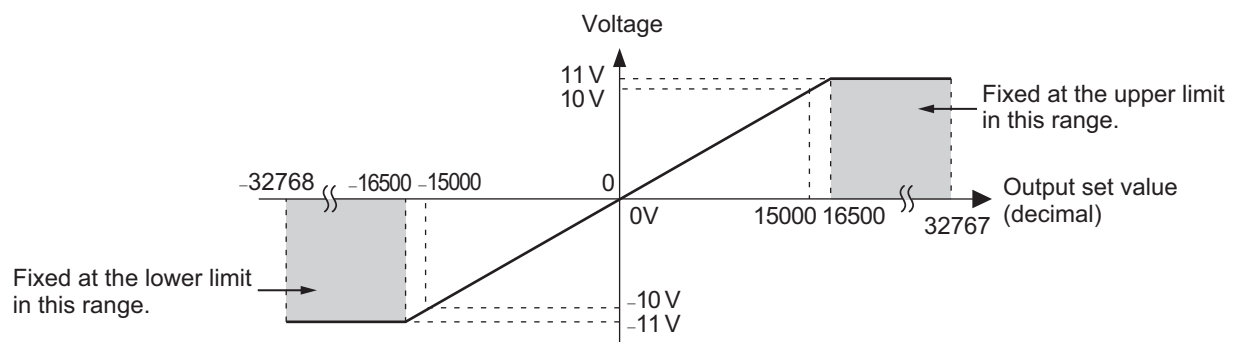

Output Range: 4 to 20 mA

● 1/8000 Resolution

The output set values of the signed integer value (0 to 8000) are converted to currents from 4 to 20 mA and output.

The output set value range for which conversion is possible is the signed integer (-400 to +8400) and for this case the output voltage becomes from 3.2 to 20.8 mA.

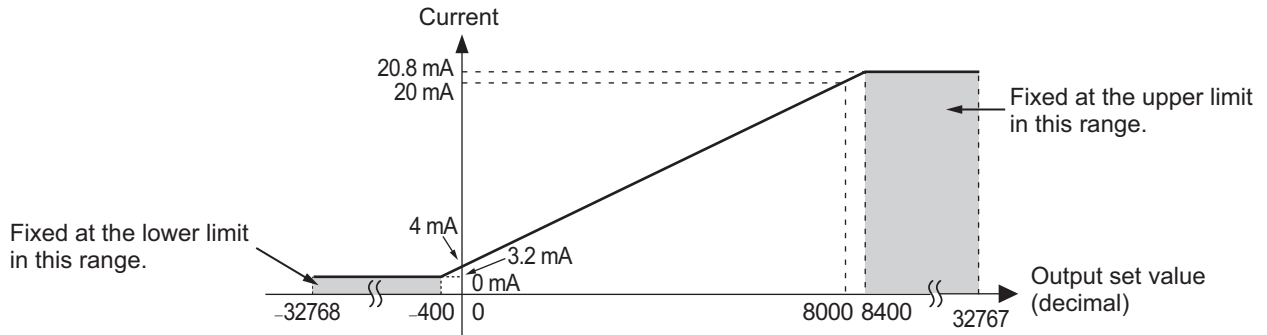

● 1/30000 Resolution

The output set values of the signed integer (0 to 30000) is converted to current from 4 to 20 mA and output.

The output set value range for which conversion is possible is the signed integer (-1500 to +31500) and for this case the output voltage becomes from 3.2 to 20.8 mA.

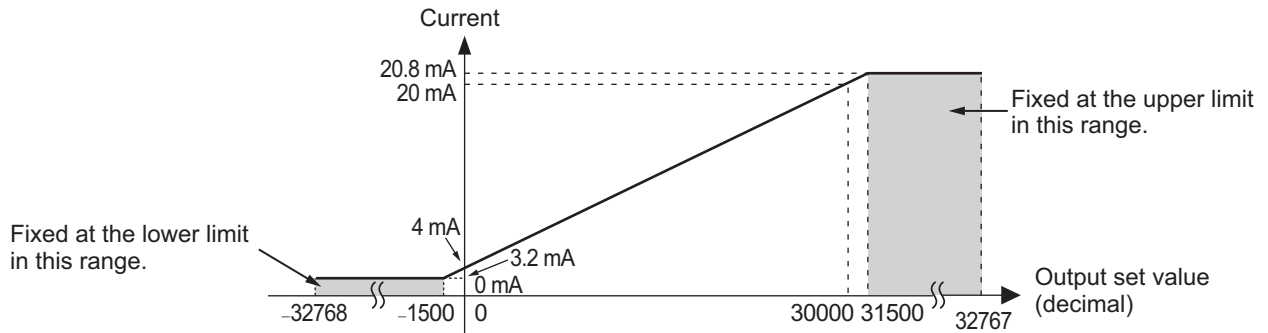

7-3 Specifications of I/O Data

This section describes the I/O data for the Analog Output Units.

7-3-1 Allocable I/O Data

This section describes the allocable I/O data in the Analog Output Unit.

An I/O entry mapping is assigned to the I/O allocation settings for the Analog Output Unit.

A specific I/O entry is assigned to the I/O entry mapping for each NX Unit model. These allocations are fixed, so you cannot add others or change them.

An I/O entry means the I/O data described in this section. An I/O entry mapping means a collection of I/O entries.

To assign the I/O allocation information of the EtherCAT Slave Terminal to an NJ-series CPU Unit, use the I/O ports for the allocated I/O data.

● Two-point Output Units

Data name	Description	Data type	Default value	I/O port name	Index	Sub-index
Ch1 Analog Output Value	Value of analog output Ch1	INT	0	Ch1 Analog Output Value	7000 hex	01 hex
Ch2 Analog Output Value	Value of analog output Ch2	INT	0	Ch2 Analog Output Value		02 hex

● Four-point Output Units

Data name	Description	Data type	Default value	I/O port name	Index	Sub-index
Ch1 Analog Output Value	Value of analog output Ch1	INT	0	Ch1 Analog Output Value	7000 hex	01 hex
Ch2 Analog Output Value	Value of analog output Ch2	INT	0	Ch2 Analog Output Value		02 hex
Ch3 Analog Output Value	Value of analog output Ch3	INT	0	Ch3 Analog Output Value		03 hex
Ch4 Analog Output Value	Value of analog output Ch4	INT	0	Ch4 Analog Output Value		04 hex

7-4 List of Settings

The followings are the setting descriptions, setting ranges, and default values of the functions that can be used in the Analog Output Units.

The settings are reflected after the Unit is restarted.



Precautions for Safe Use

The Unit is required to restart after the transfer of Unit operation settings on the Sysmac Studio is completed. Always sufficiently check the safety at the connected devices before you transfer the Unit operation settings.

● Two-point Output Units

Setting name	Description	Default value	Setting range	Unit	Index	Sub-index	Reference
Ch1 Enable/Disable	Set to enable or disable the channel.	TRUE	TRUE or FALSE	–	5010 hex	01 hex	P. 7-10
Ch2 Enable/Disable	FALSE: Disable TRUE: Enable	TRUE	TRUE or FALSE	–		02 hex	
Ch1 Range Setting	Set the range.	*1	*1	–	5011 hex	01 hex	P. 7-3
Ch2 Range Setting	0: 4 to 20 mA 1: 0 to 10 V 2: -10 to +10 V 3: 0 to 5 V 4: 1 to 5 V 5: 0 to 20 mA	*1	*1	–		02 hex	
Ch1 Hold Value Setting	Set the value to output at load OFF.	4	0 to 4 *2	–	5012 hex	01 hex	P. 7-15
Ch1 User-specified Value Setting	Set the value to output when the Load OFF Output Setting is set to output the user specified value.	0	-32768 to 32767	–		02 hex	
Ch2 Hold Value Setting	Set the value to output at load OFF.	4	0 to 4 *2	–		03 hex	
Ch2 User-specified Value Setting	Set the value to output when the Load OFF Output Setting is set to output the user specified value.	0	-32768 to 32767	–		04 hex	

*1. The default value and setting range of Ch□ Range Setting depend on the model. The default value and setting range for each NX Unit are as follows.

NX Units	Default value	Setting range
NX-DA2203/DA2205	0	0
NX-DA2603/DA2605	2	2

*2. The descriptions of Ch□ Hold Value Setting are as follows.

Set value	Setting description
0	Hold Last State
1	Low Limit
2	High Limit
3	User Count
4	Zero Count

● Four-point Output Units

Setting name	Description	Default value	Setting range	Unit	Index	Sub-index	Reference
Ch1 Enable/Disable	Set to enable or disable the channel. FALSE: Disable TRUE: Enable	TRUE	TRUE or FALSE	–	5010 hex	01 hex	P. 7-10
Ch2 Enable/Disable		TRUE	TRUE or FALSE	–		02 hex	
Ch3 Enable/Disable		TRUE	TRUE or FALSE	–		03 hex	
Ch4 Enable/Disable		TRUE	TRUE or FALSE	–		04 hex	
Ch1 Range Setting	Set the range. 0: 4 to 20 mA 1: 0 to 10 V 2: -10 to +10 V 3: 0 to 5 V 4: 1 to 5 V 5: 0 to 20 mA	*1	*1	–	5011 hex	01 hex	P. 7-3
Ch2 Range Setting		*1	*1	–		02 hex	
Ch3 Range Setting		*1	*1	–		03 hex	
Ch4 Range Setting		*1	*1	–		04 hex	
Ch1 Hold Value Setting	Set the value to output at load OFF.	4	0 to 4 *2	–	5012 hex	01 hex	P. 7-15
Ch1 User-specified Value Setting	Set the value to output when the Load OFF Output Setting is set to output the user specified value.	0	-32768 to 32767	–		02 hex	
Ch2 Hold Value Setting	Set the value to output at load OFF.	4	0 to 4 *2	–		03 hex	
Ch2 User-specified Value Setting	Set the value to output when the Load OFF Output Setting is set to output the user specified value.	0	-32768 to 32767	–		04 hex	
Ch3 Hold Value Setting	Set the value to output at load OFF.	4	0 to 4 *2	–	5012 hex	05 hex	P. 7-15
Ch3 User-specified Value Setting	Set the value to output when the Load OFF Output Setting is set to output the user specified value.	0	-32768 to 32767	–		06 hex	
Ch4 Hold Value Setting	Set the value to output at load OFF.	4	0 to 4 *2	–		07 hex	
Ch4 User-specified Value Setting	Set the value to output when the Load OFF Output Setting is set to output the user specified value.	0	-32768 to 32767	–		08 hex	

- *1. The default value and setting range of Ch□ Range Setting depend on the model. The default value and setting range for each NX Unit are as follows.

NX Units	Default value	Setting range
NX-DA3203/DA3205	0	0
NX-DA3603/DA3605	2	2

- *2. The descriptions of Ch□ Hold Value Setting are as follows.

Set value	Setting description
0	Hold Last State
1	Low Limit
2	High Limit
3	User Count
4	Zero Count

7-5 Functions

This section describes the Analog Output Unit functions.

Refer to the specifications of each model in *A-1 Data Sheet* on page A-2 for details on the functions.

7-5-1 List of Analog Output Unit Functions

Function name	Description	Reference
Free-Run Refreshing	With this I/O refreshing method, the refresh cycle of the NX bus and the I/O refresh cycles of the NX Units are asynchronous.	5-2-4 <i>Free-Run Refreshing</i> on page 5-4
Synchronous I/O Refreshing	With this I/O refreshing method, the timing to read inputs or to refresh outputs is synchronous on a fixed interval between more than one NX Unit on more than one Slave Terminal.	5-2-6 <i>Synchronous Output Refreshing</i> on page 5-13
Selecting Channel To Use	This function omits the conversion processing for unused inputs. It is used to reduce the conversion cycle for its own Unit.	7-5-2 <i>Selecting Channel To Use</i> on page 7-10
Load Rejection Output Setting	A function that performs the preset output operation when the Analog Output Unit cannot receive output data due to a host error on the Communications Coupler Unit or an error on the NX bus.	7-5-3 <i>Load Rejection Output Setting</i> on page 7-15
Over Range/Under Range Detection	This function detects when the output set value exceeds the range for which conversion is possible.	7-5-4 <i>Over Range/Under Range Detection</i> on page 7-21
User Calibration	This function corrects offsets in the converted values that occur due to the deterioration of the NX Units and calibrate the Units.	7-5-5 <i>User Calibration</i> on page 7-22

7-5-2 Selecting Channel To Use

Purpose

This function skips the conversion processing and error detection processing for unused outputs, and shortens the conversion time.

Details on the Function

Normally in this Unit, the output set values for the number of input points mounted are converted in sequence. The setting can be changed so that unused outputs are not converted.

By reducing the number of conversion points, the conversion time is shortened.

Whether the channel is enabled or disabled is settable for each output.

However, set the Ch□ Enable/Disable parameter to *Enable* for at least one channel for a Unit.

If you disabled all channels for a Unit, an NX Unit Initialization Error event (event code: 84C10000 hex) occurs.

Refer to the *EtherCAT Coupler Unit User's Manual* (Cat. No. W519) for details on events.

● Two-point Output Units

Setting name	Description	Default value	Unit
Ch1 Enable/Disable	Set to enable or disable the channel.	TRUE	–
Ch2 Enable/Disable		TRUE	–
	FALSE: Disable TRUE: Enable		

● Four-point Output Units

Setting name	Description	Default value	Unit
Ch1 Enable/Disable	Set to enable or disable the channel.	TRUE	–
Ch2 Enable/Disable		TRUE	–
Ch3 Enable/Disable		TRUE	–
Ch4 Enable/Disable		TRUE	–
	FALSE: Disable TRUE: Enable		

Target NX Units

All Analog Output Units

Setting Method

- Use the Sysmac Studio

- 1 Use any of the following methods to display the Edit Unit Operation Settings Tab Page on the Edit Slave Terminal Configuration Tab Page.

Double-click the NX Unit.

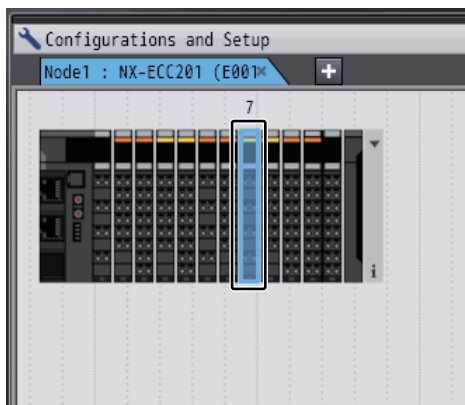

Right-click the NX Unit, then select *Edit Unit Operation Settings* from the menu.

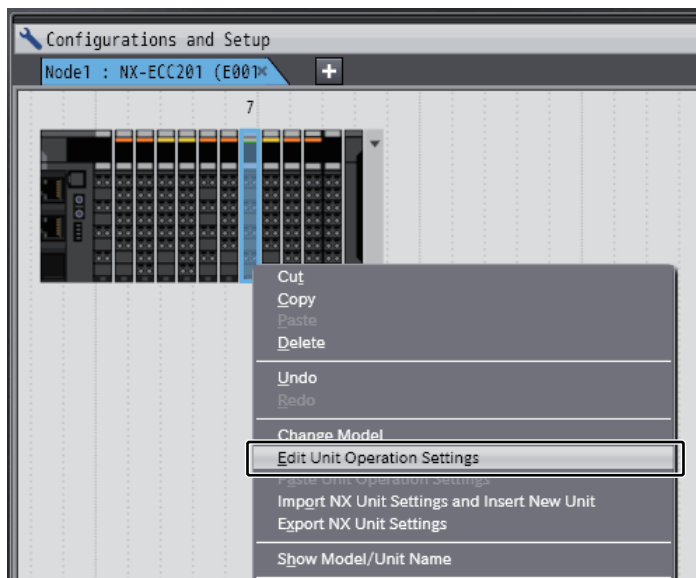

Select the NX Unit, then click the **Edit Unit Operation Settings** Button.

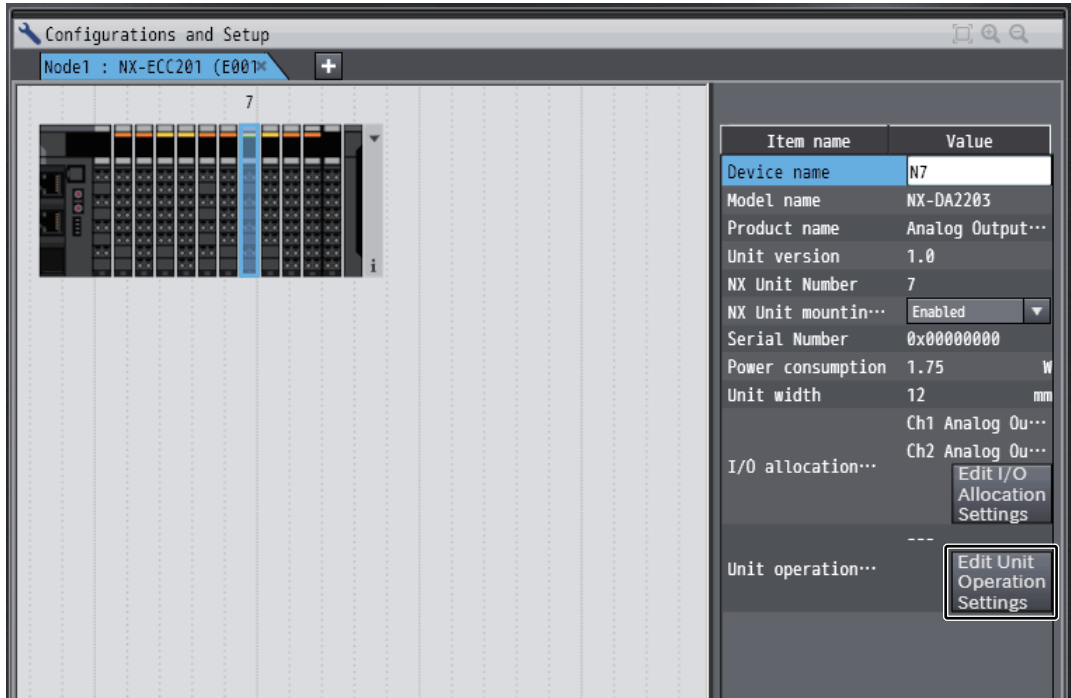

The Edit Unit Operation Settings Tab Page is displayed.

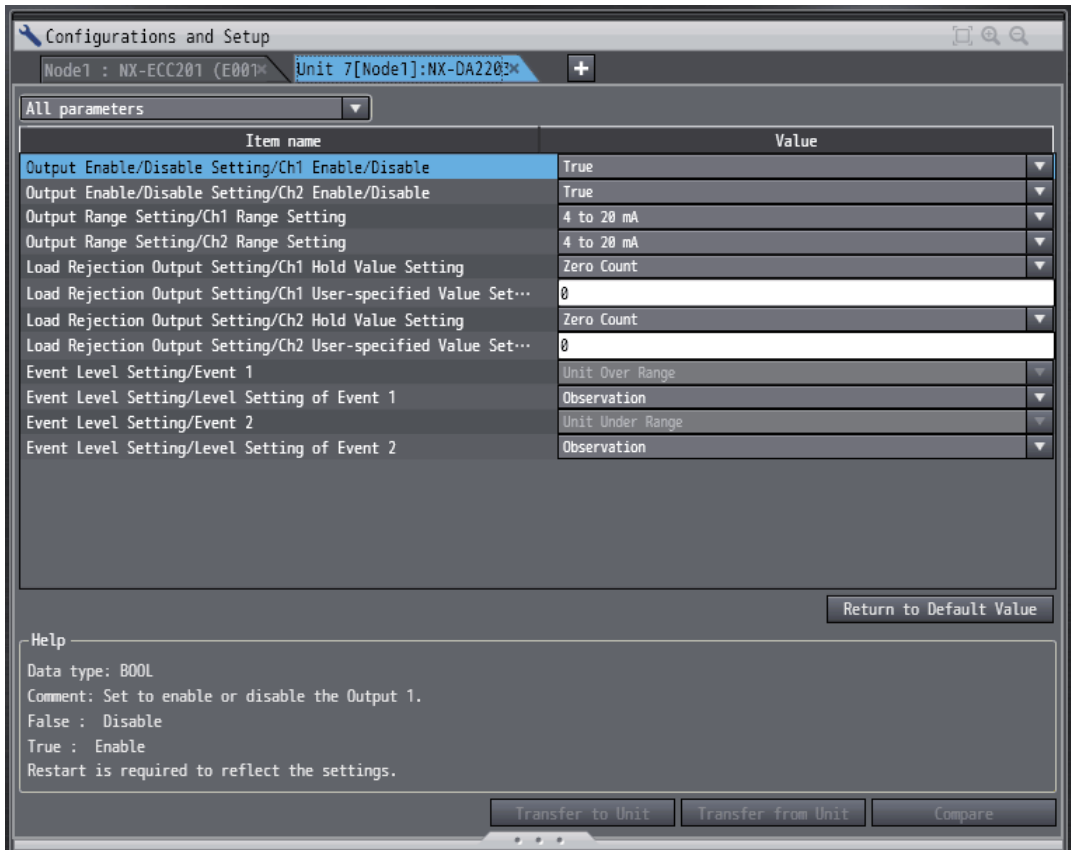

- 2 Select *True* (Enable) or *False* (Disable) from the list of Output Enable/Disable Setting for which the channel you want to set.

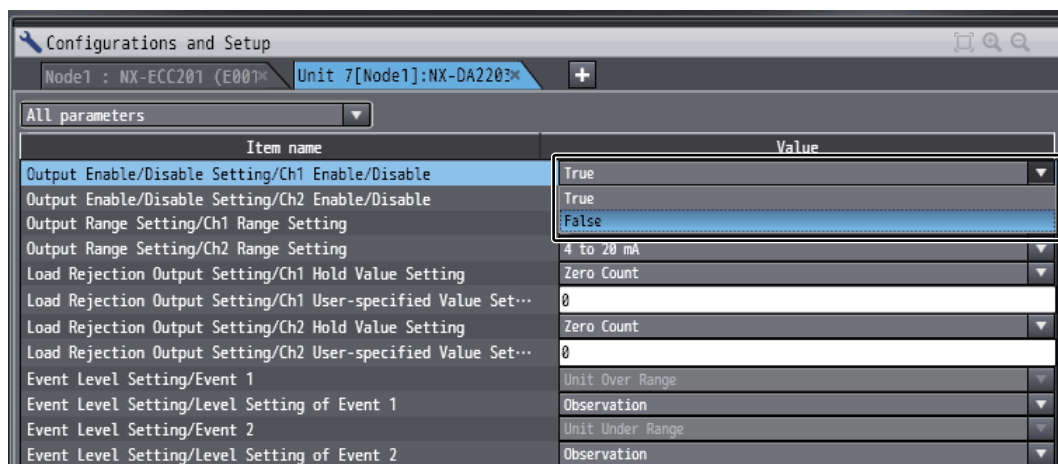

Additional Information

- Click a list button on the tab page to display the item in the Edit Unit Operation Settings Tab Page.

Example:

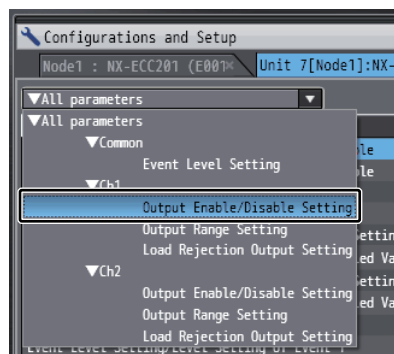

Select Output Enable/Disable Setting under Ch1

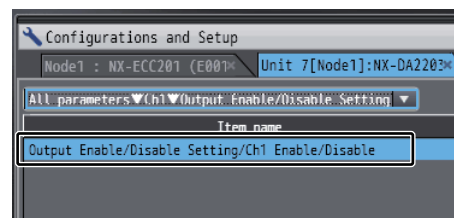

Only Output Enable/Disable Setting under Ch1 is displayed

- If you set a value different from the default value, the Value on the Sysmac Studio is displayed in a different color.
- You can click the **Return to Default Value** Button to return all set values on the Sysmac Studio to the default values.
- Help for the settings is displayed at the bottom of the Edit Unit Operation Settings Tab Page.

3 Click the **Transfer to Unit** Button.

The settings are transferred from the Sysmac Studio to the NX Unit.

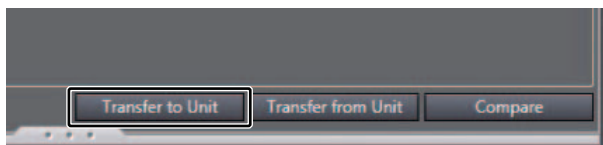

The settings are reflected after the Unit is restarted.



Precautions for Safe Use

The Unit is required to restart after the transfer of Unit operation settings on the Sysmac Studio is completed. Always sufficiently check the safety at the connected devices before you transfer the Unit operation settings.

Calculating Conversion Time

The conversion time per Unit according to the number of available conversion channels is as follows.

Number of available conversion channels	Conversion time per unit (μs)	
	Conversion time: 250 μs/point	Conversion time: 10 μs/point
1 channel	250	10
2 channels	500	20
3 channels	750	30
4 channels	1000	40
5 channels	1250	50
6 channels	1500	60
7 channels	1750	70
8 channels	2000	80

7-5-3 Load Rejection Output Setting

Purpose

This function set the output value when Analog Output Units cannot receive the output set value from the Communications Coupler Unit due to a host error on the Communications Coupler Unit or an error on the NX bus.

Details on the Function

Set the output value from any of the following for each output when an error occurs.

Setting description	Meaning	Set value	
		Output range -10 to +10 V	Output range 4 to 20 mA
Hold Last State	Hold and output the value immediately before the error occurred.	Hold	Hold
Low Limit	Output the lower limit of each output range.	-11 V	3.2 mA
High Limit	Output the upper limit of each output range	11 V	20.8 mA
User Count	Output the user-specified value.	User specified value	User specified value
Zero Count	Output the analog value if the output set value of each output range is 0 (default).	0 V	4 mA

● Two-point Output Units

Setting name	Description	Default value	Unit
Ch1 Hold Value Setting	Set the value to output at load OFF. *1	4	—
Ch1 User-specified Value Setting	Set the value to output when the Load OFF Output Setting is set to output the user specified value.	0	—
Ch2 Hold Value Setting	Set the value to output at load OFF. *1	4	—
Ch2 User-specified Value Setting	Set the value to output when the Load OFF Output Setting is set to output the user specified value.	0	—

*1. The descriptions of Ch□ Hold Value Setting are as follows.

Set value	Setting description
0	Hold Last State
1	Low Limit
2	High Limit
3	User Count
4	Zero Count

● Four-point Output Units

Setting name	Description	Default value	Unit
Ch1 Hold Value Setting	Set the value to output at load OFF. *1	4	–
Ch1 User-specified Value Setting	Set the value to output when the Load OFF Output Setting is set to output the user specified value.	0	–
Ch2 Hold Value Setting	Set the value to output at load OFF. *1	4	–
Ch2 User-specified Value Setting	Set the value to output when the Load OFF Output Setting is set to output the user specified value.	0	–
Ch3 Hold Value Setting	Set the value to output at load OFF. *1	4	–
Ch3 User-specified Value Setting	Set the value to output when the Load OFF Output Setting is set to output the user specified value.	0	–
Ch4 Hold Value Setting	Set the value to output at load OFF. *1	4	–
Ch4 User-specified Value Setting	Set the value to output when the Load OFF Output Setting is set to output the user specified value.	0	–

*1. The descriptions of Ch□ Hold Value Setting are as follows.

Set value	Setting description
0	Hold Last State
1	Low Limit
2	High Limit
3	User Count
4	Zero Count

Target NX Units

All Analog Output Units

Setting Method

- Use the Sysmac Studio

- 1 Use any of the following methods to display the Edit Unit Operation Settings Tab Page on the Edit Slave Terminal Configuration Tab Page.

Double-click the NX Unit.

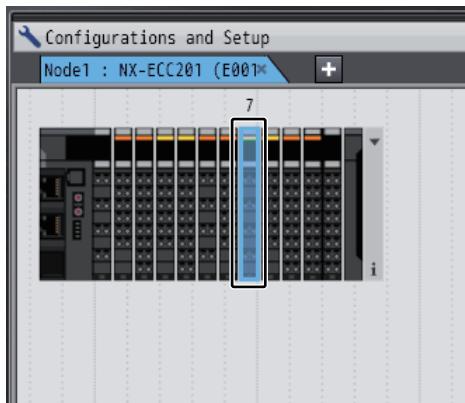

Right-click the NX Unit, then select *Edit Unit Operation Settings* from the menu.

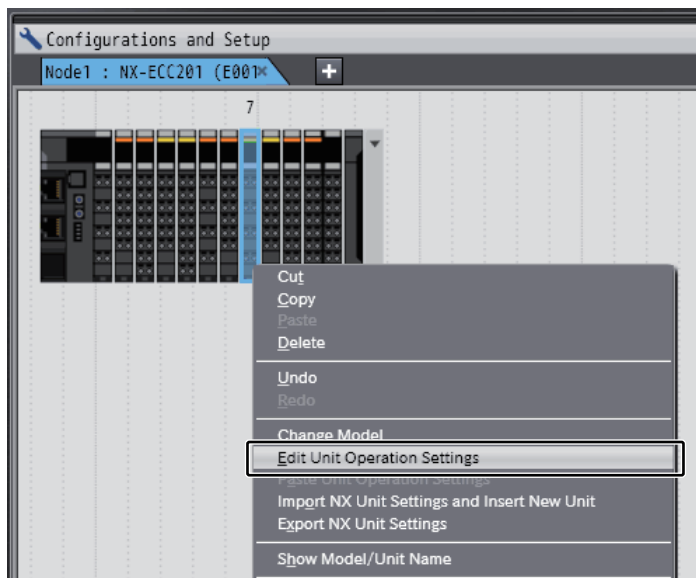

Select the NX Unit, then click the **Edit Unit Operation Settings** Button.

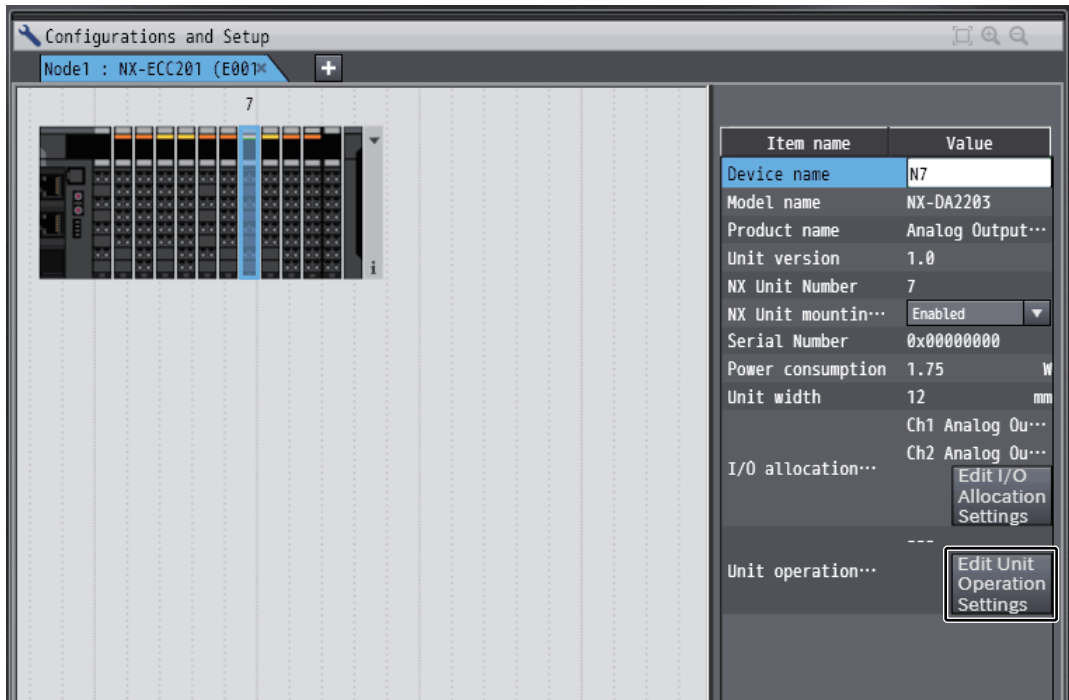

The Edit Unit Operation Settings Tab Page is displayed.

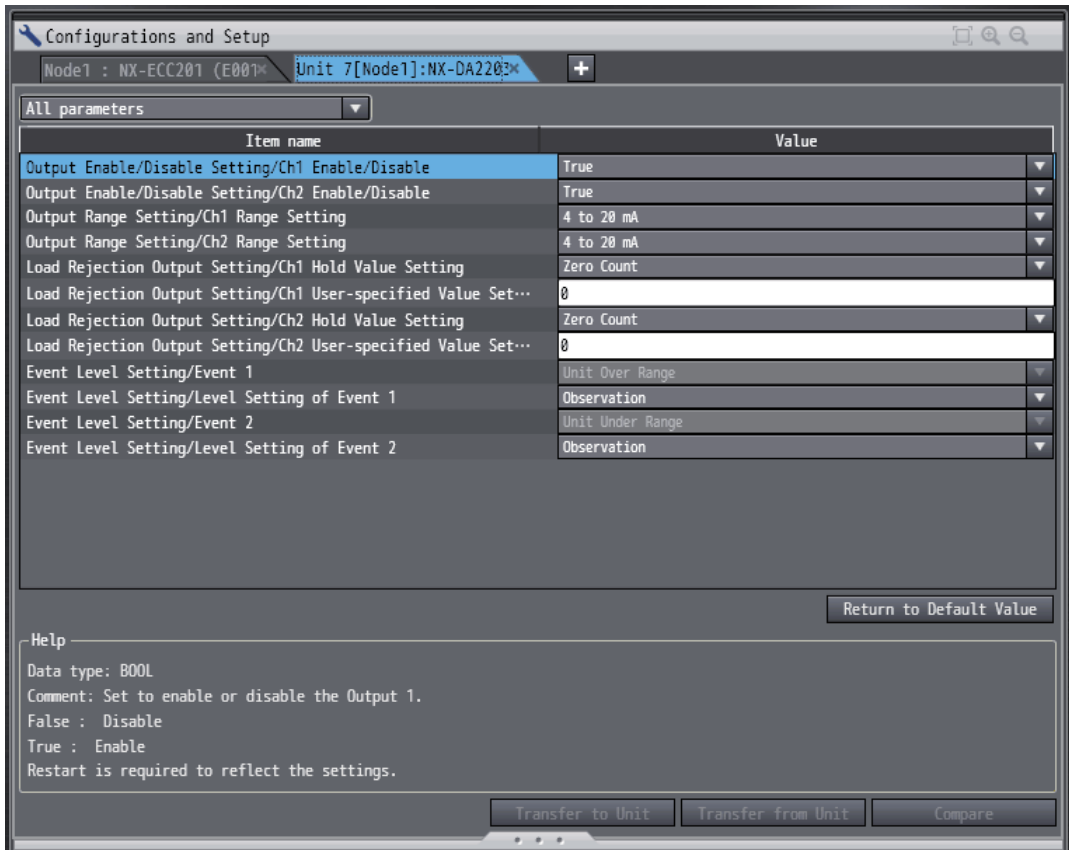

- 2 Select the output from the list of Load Rejection Output Setting for which the channel you want to set.

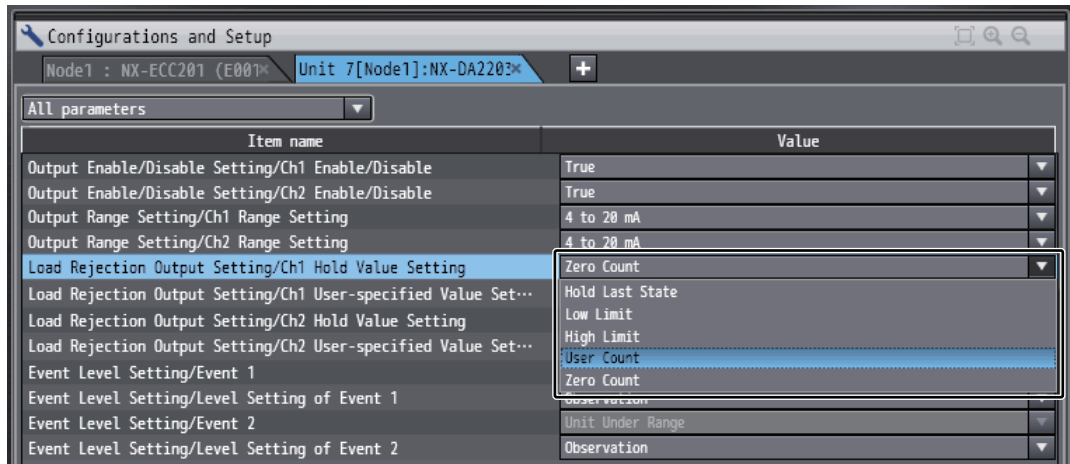

Additional Information

- Click a list button on the tab page to display the item in the Edit Unit Operation Settings Tab Page.

Example:

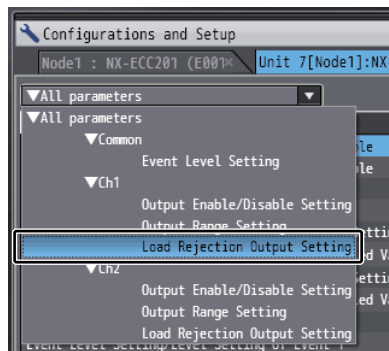

Select Load Rejection Output Setting under Ch1

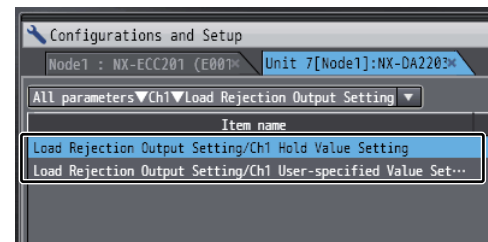

Only Load Rejection Output Setting under Ch1 is displayed

- If you set a value different from the default value, the Value on the Sysmac Studio is displayed in a different color.
- You can click the **Return to Default Value** Button to return all set values on the Sysmac Studio to the default values.
- Help for the settings is displayed at the bottom of the Edit Unit Operation Settings Tab Page.

If you select *User Count*, enter an analog output value (-32768 to 32767) in the text box of Ch□ User-specified Value Setting.

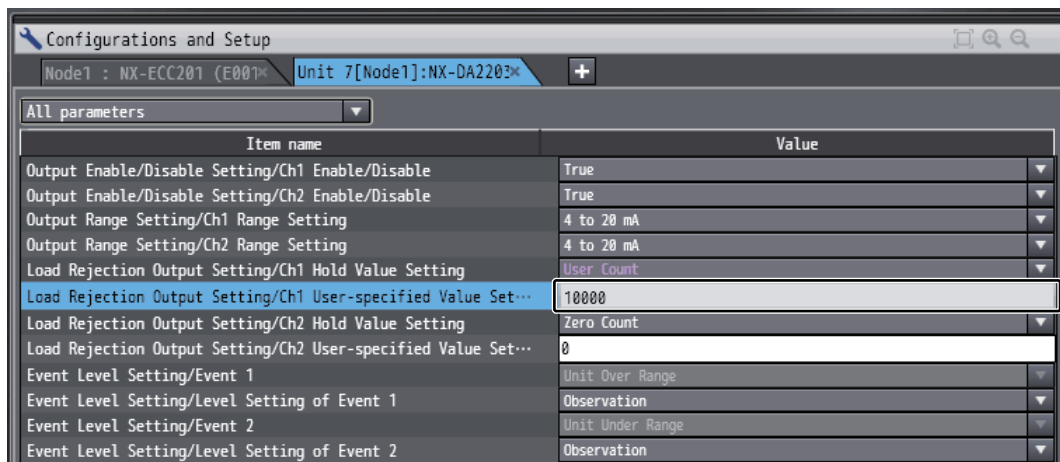

Additional Information

This set value is invalid except for User Count.

3 Click the **Transfer to Unit** Button.

The settings are transferred from the Sysmac Studio to the NX Unit.

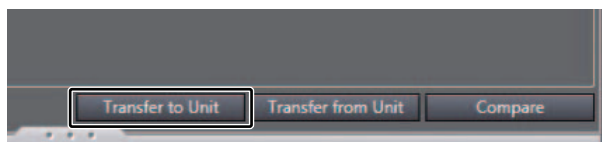

The settings are reflected after the Unit is restarted.



Precautions for Safe Use

The Unit is required to restart after the transfer of Unit operation settings on the Sysmac Studio is completed. Always sufficiently check the safety at the connected devices before you transfer the Unit operation settings.

7-5-4 Over Range/Under Range Detection

Purpose

This function detects when the output set value exceeds the range for which conversion is possible.

Details on the Function

- If the output set value exceeds the upper limit of the conversion range, the converted value is fixed at the upper limit. At this time, the Over Range Status turns ON and an Unit Over Range for Channel□ event (event code: 64F00000 to 64F70000 hex) occurs.
- If the output set value falls below the lower limit of the conversion range, the converted value is fixed at the lower limit. At this time, the Under Range Status turns ON and an Unit Under Range for Channel□ event (event code: 64F80000 to 64FF0000 hex) occurs.
- When the output set value returns to the conversion range, the fixing is cancelled and the value becomes the normal converted value. When the cause of the error is removed and the error is reset, the Over Range/Under Range Status turns OFF.
- Refer to *A-3 List of NX Objects* on page A-58 for details on status and *9-3-2 Event Codes and Corrections for Errors* on page 9-9 for details on events.

Target NX Units

All Analog Output Units

Setting Method

No setting is required.

7-5-5 User Calibration

Purpose

This function corrects offsets in the output voltages and output currents that occur due to the deterioration of the NX Units and calibrate the Units again.

You can use this function to calibrate the equipment that requires the periodic calibration.

Details on the Function

This function corrects the converted values of output voltages and output currents at 2 points, 0% and 100%, as shown in the figure below.

The calibration result is saved in the NX Unit.

● Calibration Example 1

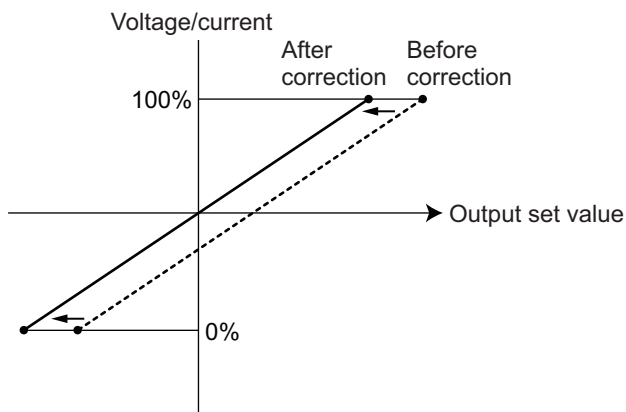

● Calibration Example 2

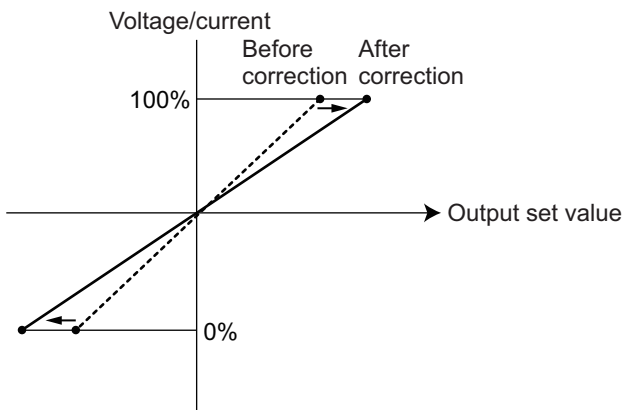

● Correctable Range

The correctable range is -5 to +5% of the output full scale.

The correctable range for each output range is as follows.

Output range	Correctable range	
	0%	100%
-10 to +10 V	-11 to -9.0 V	9.0 to 11 V
4 to 20 mA	3.2 to 4.8 mA	19.2 to 20.8 mA

Target NX Units

All Analog Output Units

Setting Method

● Use the Sysmac Studio

- 1 Right-click the NX Unit, then select *User Calibration* from the menu.

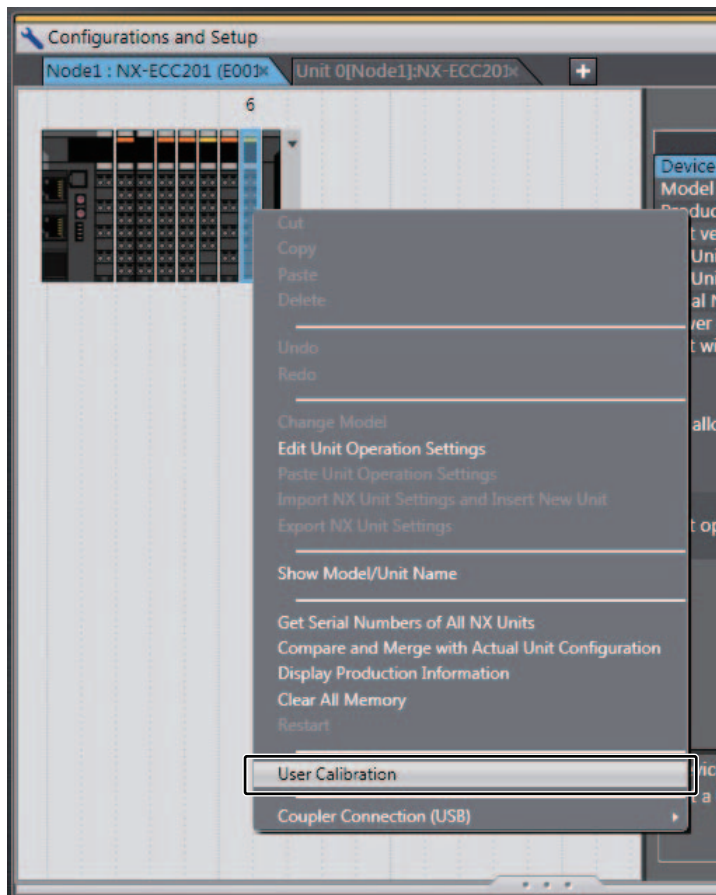

- 2 Select the channel you want to calibrate from Channel.

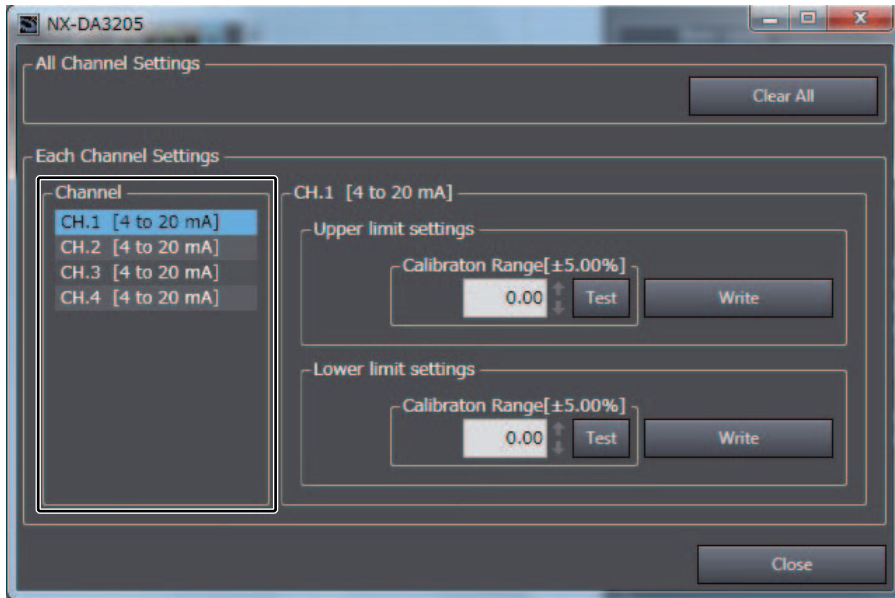

- 3 Set the minimum value (0%) of Output Unit as the output set value for the channel you want to calibrate.
- 4 Change the value of Calibration Range under Lower limit settings to calibrate the value of an analog signal that is output from the terminal.

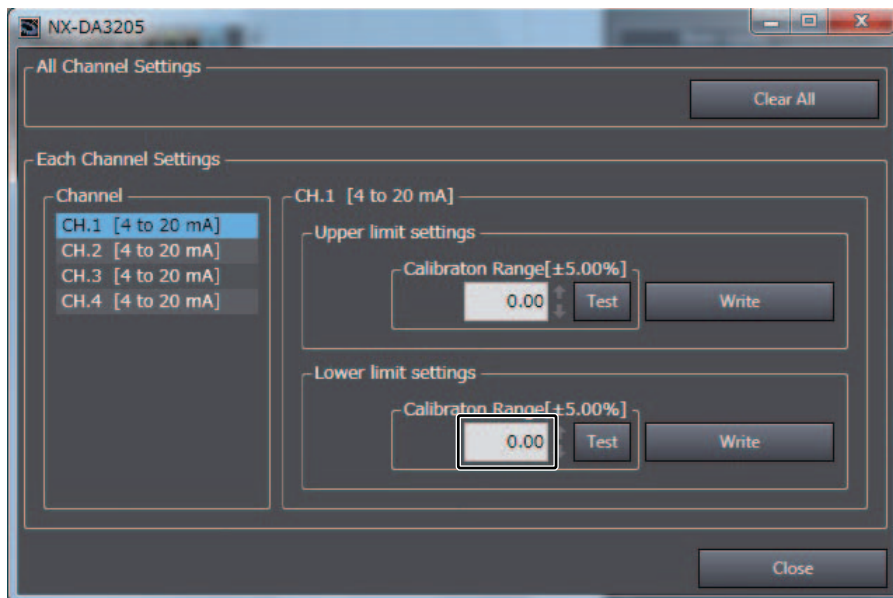

- 5 Click the **Test** Button to output the value of an analog signal that was calibrated in Procedure 4.

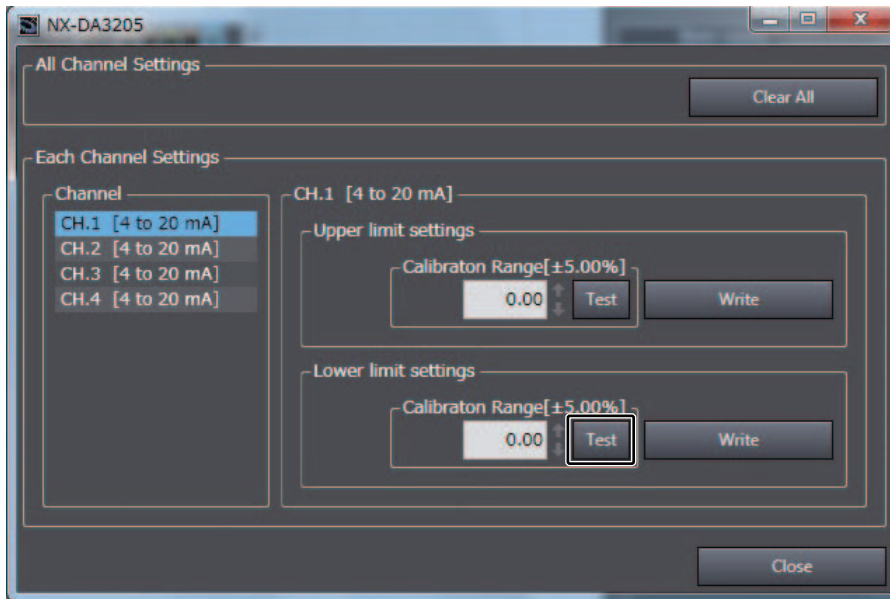

Make the calibration to correctly output the value of 0% analog signal from the terminal.

- 6 After you complete the calibration, click the **Write** Button under Lower limit settings.

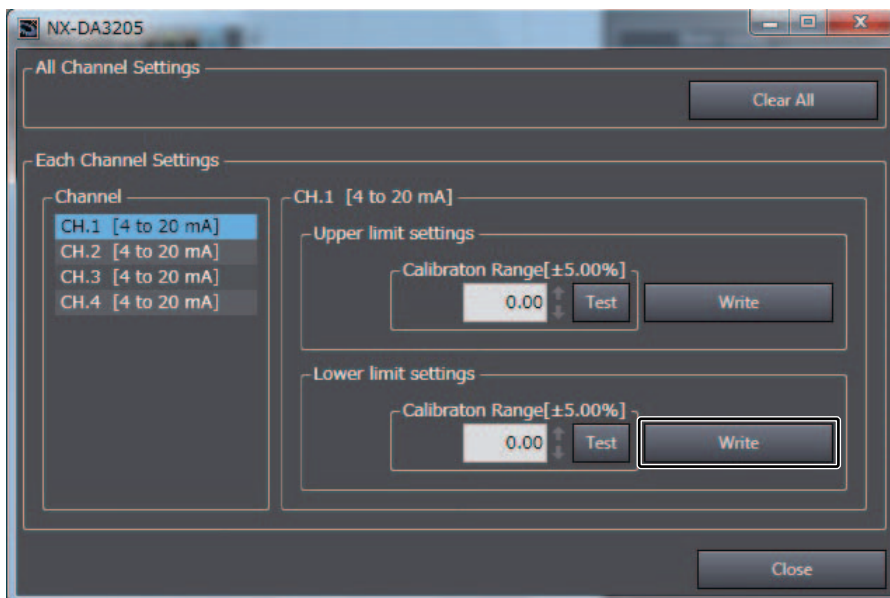

- 7 Click the **Yes** Button on the confirmation message.

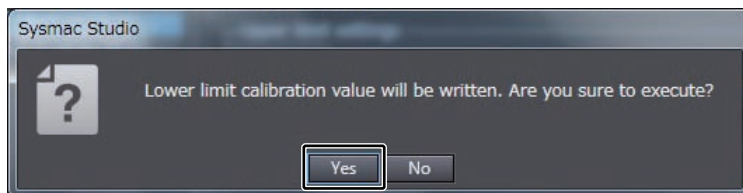

When the writing is completed successfully, the following message is displayed. Click the **OK** Button.

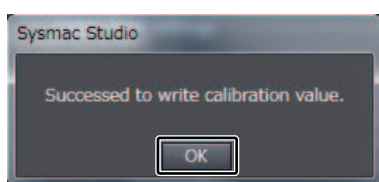

- 8 Set the maximum value (100%) of Output Unit as the output set value for the channel you want to calibrate.
- 9 Change the value of Calibration Range under Upper limit settings to calibrate the value of an analog signal that is output from the terminal.

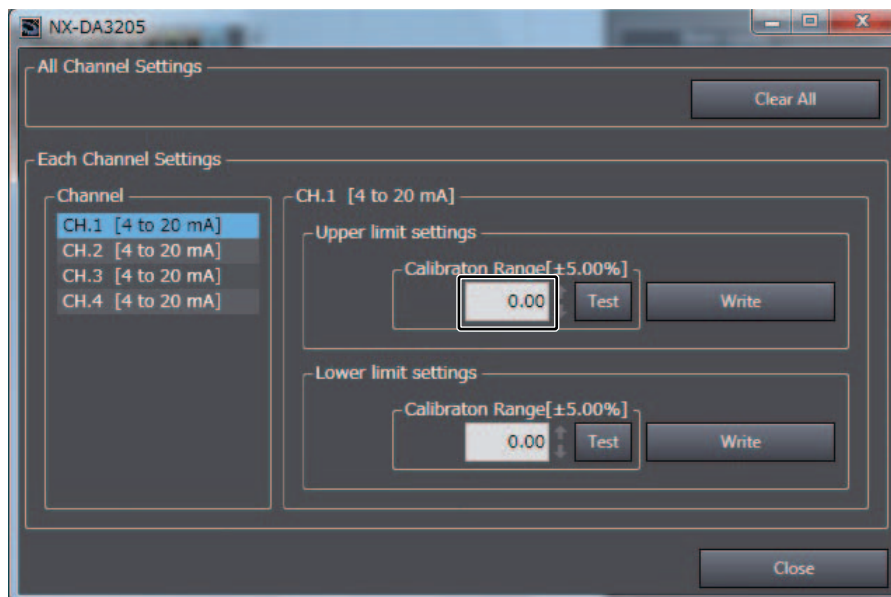

- 10** Click the **Test** Button to output the value of an analog signal that was calibrated in Procedure 9.

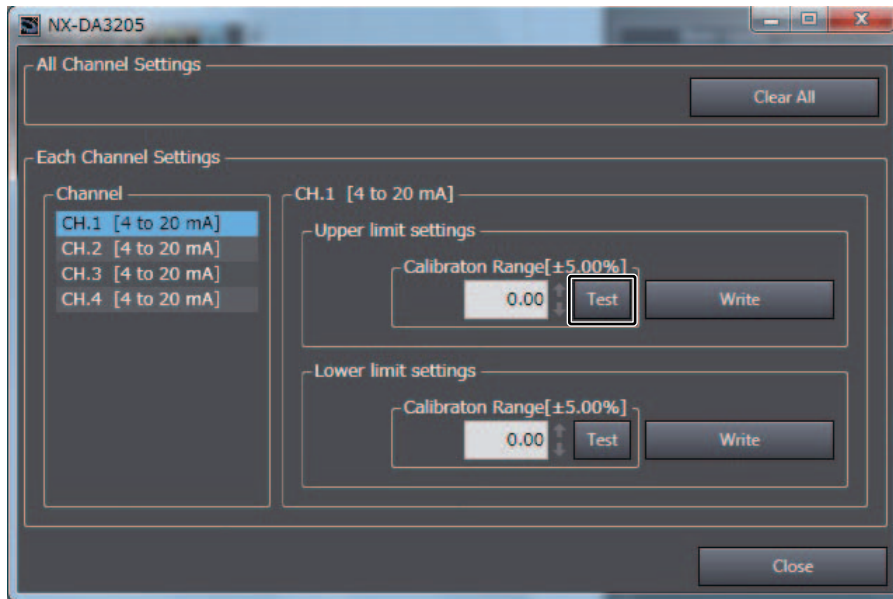

Make the calibration to correctly output the value of 100% analog signal from the terminal.

- 11** After you complete the calibration, click the **Write** Button under Upper limit settings.

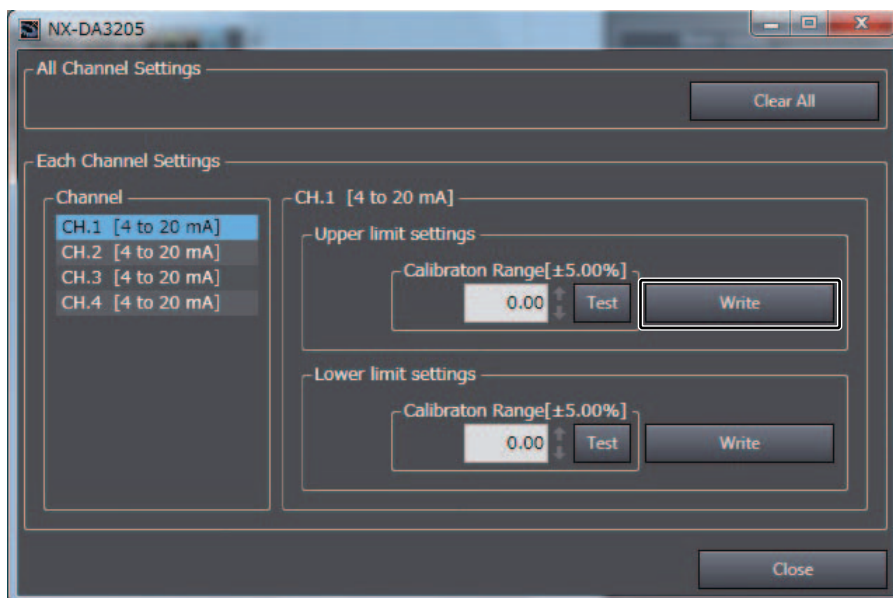

12 Click the **Yes** Button on the confirmation message.

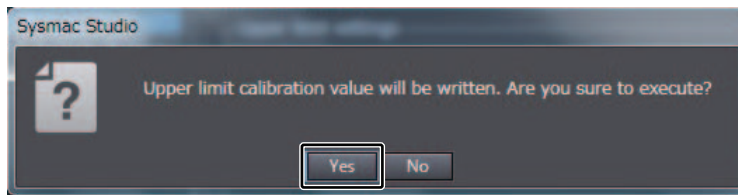

When the writing is completed successfully, the following message is displayed. Click the **OK** Button.

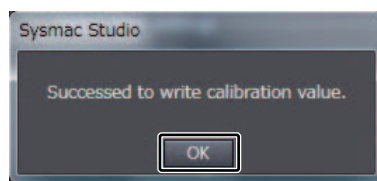

Additional Information

For the upper limit calibration value and lower limit calibration value, you cannot write the calibration value on the Unit if only click the **Test** Button. To write the calibration value, click the **Write** Button.

- **Reset the Calibration Value to the Default**

You can reset the calibration value to the default.

- 1 Right-click the NX Unit, then select *User Calibration* from the menu.

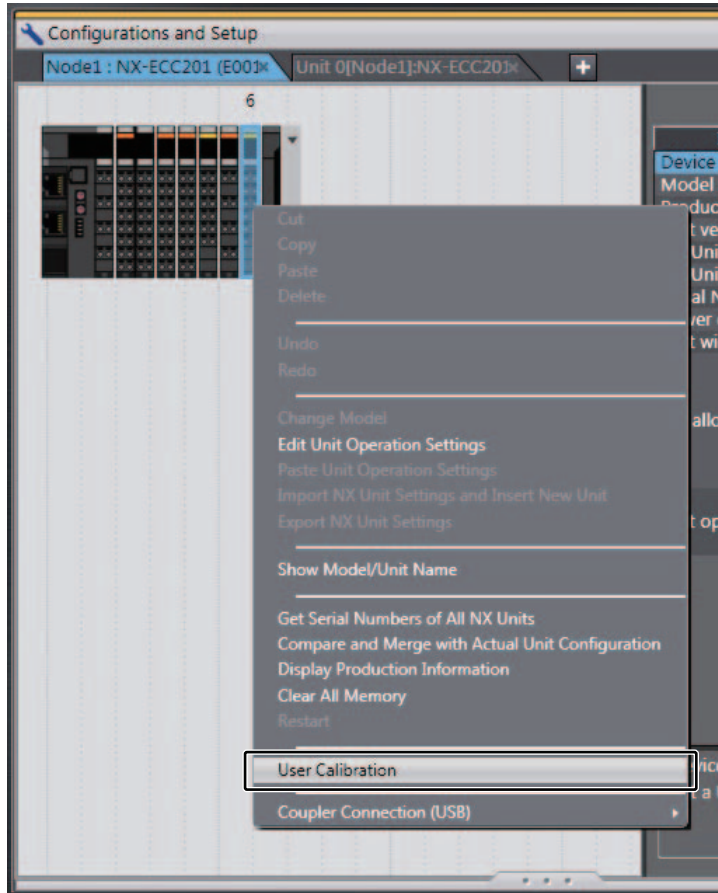

- 2 Click the **Clear All** Button under All Channel Settings.

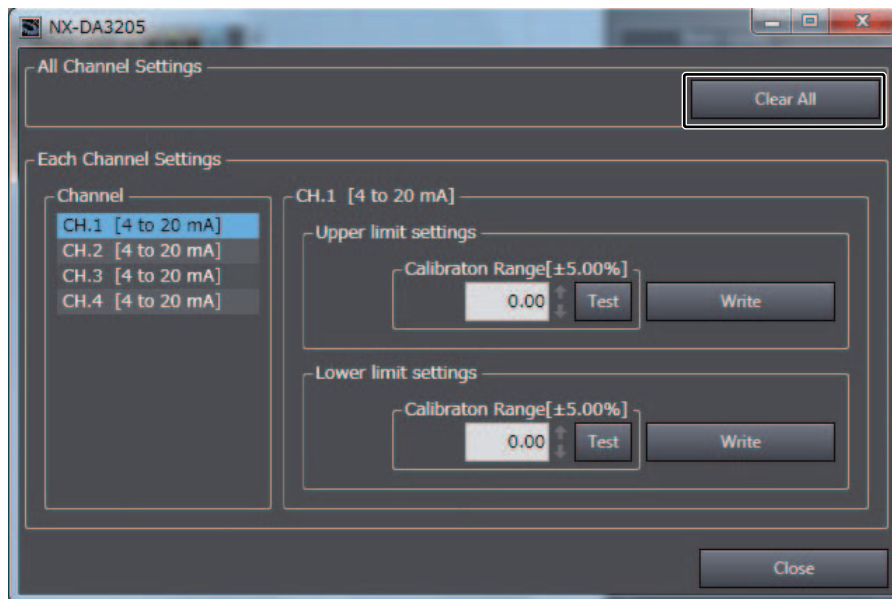

- 3 Click the **Yes** Button on the confirmation message.

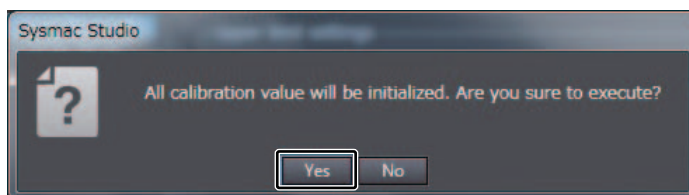

When the writing is completed successfully, the following message is displayed. Click the **OK** Button.

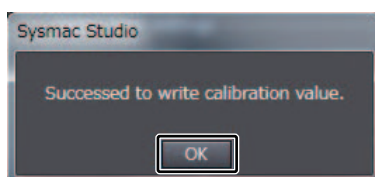

8

Temperature Input Units

This section describes the types and functions of Temperature Input Units.

8-1	Types of Temperature Input Units	8-2
8-2	Input Types and Input Ranges	8-3
8-2-1	Corresponding Input Types and Input Ranges	8-3
8-2-2	Setting Methods	8-5
8-3	Specifications of I/O Data	8-9
8-3-1	Allocable I/O Data	8-9
8-4	List of Settings	8-14
8-5	Functions	8-20
8-5-1	List of Temperature Input Unit Functions	8-20
8-5-2	Function Block Diagram	8-21
8-5-3	Selecting Channel To Use	8-22
8-5-4	Moving Average	8-27
8-5-5	Sensor Disconnection Detection	8-32
8-5-6	Over Range/Under Range Detection	8-33
8-5-7	Cold Junction Compensation Enable/Disable Setting	8-34
8-5-8	Temperature Unit (°C/°F) Setting	8-39
8-5-9	Input Correction	8-44
8-5-10	Decimal Point Position Setting	8-51
8-6	Measured Values Used When an Error Occurs	8-57

8-1 Types of Temperature Input Units

Temperature Input Units are NX Units with functionality to process inputs of the temperature sensors.

There are thermocouple input and resistance thermometer input types.

This section describes the types of Temperature Input Units.

Temperature Input Units (Screwless Clamping Terminal Block, 12 mm Width)

Model	Number of points	Input type	Conversion time	Resolution	I/O refreshing method	Reference
NX-TS2101	2 points	Thermocouple	250 ms/Unit	0.1°C max. ^{*1}	Free-Run refreshing	P. A-40
NX-TS2102			10 ms/Unit	0.01°C max.		P. A-41
NX-TS2104			60 ms/Unit	0.001°C max.		P. A-42
NX-TS2201		Resistance thermometer (Pt100/Pt1000, three-wire) ^{*2}	250 ms/Unit	0.1°C max.		P. A-43
NX-TS2202			10 ms/Unit	0.01°C max.		P. A-44
NX-TS2204			60 ms/Unit	0.001°C max.		P. A-45

*1. The resolution is 0.2°C max. when the input type is R, S, or W.

*2. The NX-TS2202 only supports Pt100 three-wire sensor.

Temperature Input Units (Screwless Clamping Terminal Block, 24 mm Width)

Model	Number of points	Input type	Conversion time	Resolution	I/O refreshing method	Reference
NX-TS3101	4 points	Thermocouple	250 ms/Unit	0.1°C max. ^{*1}	Free-Run refreshing	P. A-46
NX-TS3102			10 ms/Unit	0.01°C max.		P. A-47
NX-TS3104			60 ms/Unit	0.001°C max.		P. A-48
NX-TS3201		Resistance thermometer (Pt100/Pt1000, three-wire) ^{*2}	250 ms/Unit	0.1°C max.		P. A-49
NX-TS3202			10 ms/Unit	0.01°C max.		P. A-50
NX-TS3204			60 ms/Unit	0.001°C		P. A-51

*1. The resolution is 0.2°C max. when the input type is R, S, or W.

*2. The NX-TS3202 only supports Pt100 three-wire sensor.

8-2 Input Types and Input Ranges

This section describes input types and setting methods of Temperature Input Units.

8-2-1 Corresponding Input Types and Input Ranges

The following table shows the corresponding input types, input ranges and convertible temperature ranges.

The convertible temperature ranges are increased by $\pm 20^{\circ}\text{C}$ for each input range.

The reference accuracy and temperature coefficient are guaranteed when the measured value is within the input range.

● Thermocouple Type

Input type ^{*1}	Input range	Convertible temperature range	Settable NX Units		
			Conversion time: 250 ms Resolution: 0.1°C max. ^{*2}	Conversion time: 10 ms Resolution: 0.01°C max.	Conversion time: 60 ms Resolution: 0.001°C max.
			NX-TS2101 NX-TS3101	NX-TS2102 NX-TS3102	NX-TS2104 NX-TS3104
K	-200 to 1300°C	-220 to 1320°C	Yes	Yes	Yes
K	-20 to 600°C (High Resolution)	-40 to 620°C	No	Yes	Yes
J	-200 to 1200°C	-220 to 1220°C	Yes	Yes	Yes
J	-20 to 600°C (High Resolution)	-40 to 620°C	No	Yes	Yes
T	-200 to 400°C	-220 to 420°C	Yes	Yes	Yes
E	-200 to 1000°C	-220 to 1020°C	Yes	Yes	Yes
L	-200 to 900°C	-220 to 920°C	Yes	Yes	Yes
U	-200 to 600°C	-220 to 620°C	Yes	Yes	Yes
N	-200 to 1300°C	-220 to 1320°C	Yes	Yes	Yes
R	-50 to 1700°C	-70 to 1720°C	Yes	Yes	Yes
S	-50 to 1700°C	-70 to 1720°C	Yes	Yes	Yes
B	0 to 1800°C	-20 to 1820°C	Yes	No	No
W	0 to 2300°C	-20 to 2320°C	Yes	Yes	Yes
PL II	0 to 1300°C	-20 to 1320°C	Yes	Yes	Yes

*1. If there are more than one input ranges for the same input type, the one with narrower input range has higher resolution.

*2. The resolution is 0.2°C max. when the input type is R, S, or W.

● Resistance Thermometer Type

Input type	Input range	Convertible temperature range	Settable NX Units		
			Conversion time: 250 ms Resolution: 0.1°C max.	Conversion time: 10 ms Resolution: 0.01°C max.	Conversion time: 60 ms Resolution: 0.001°C max.
			NX-TS2201 NX-TS3201	NX-TS2202 NX-TS3202	NX-TS2204 NX-TS3204
Pt100	-200 to 850°C	-220 to 870°C	Yes	Yes	Yes
Pt1000	-200 to 850°C	-220 to 870°C	Yes	No	Yes



Additional Information

- The decimal point position of INT and DINT measured values can be set from 0°C/°F, 0.1°C/°F or 0.01°C/°F. Refer to *8-5-10 Decimal Point Position Setting* on page 8-51.
- To convert the temperature unit from Celsius to Fahrenheit, use the following equation.
Fahrenheit temperature (°F) = Celsius temperature (°C) x 1.8 + 32
- Regardless of the measured value data type, treat any measured value digits that exceed the specified resolution as reference values. The same is true if the data type is an integer type and a large number of digits are set for display with the decimal point position setting.

8-2-2 Setting Methods

The methods for setting the input type and input range are as follows.

Use the Sysmac Studio

- 1 Use any of the following methods to display the Edit Unit Operation Settings Tab Page on the Edit Slave Terminal Configuration Tab Page.

Double-click the NX Unit.

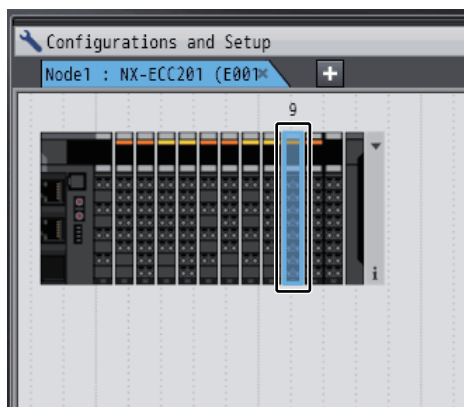

Right-click the NX Unit, then select *Edit Unit Operation Settings* from the menu.

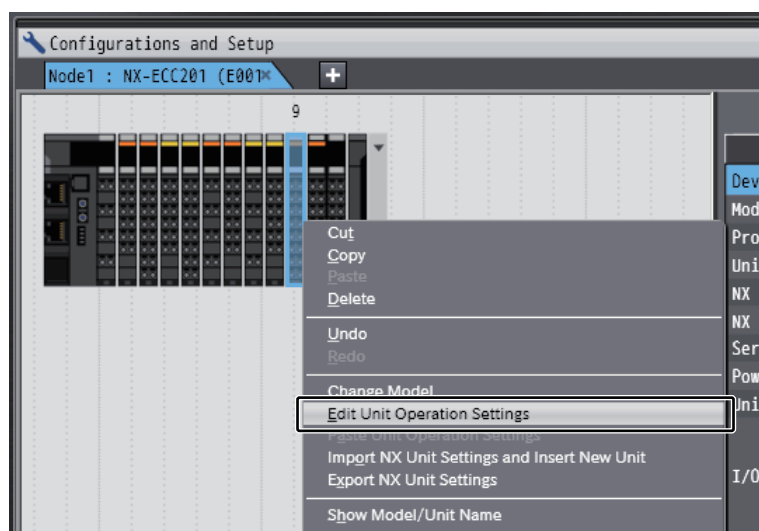

Select the NX Unit, then click the **Edit Unit Operation Settings** Button.

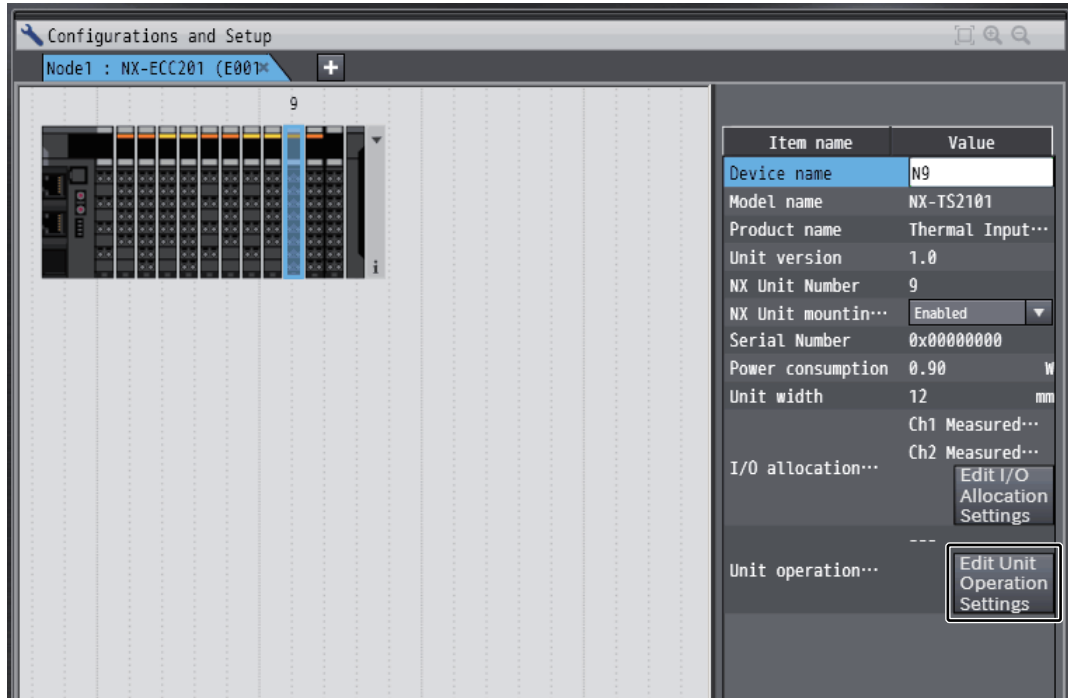

The Edit Unit Operation Settings Tab Page is displayed.

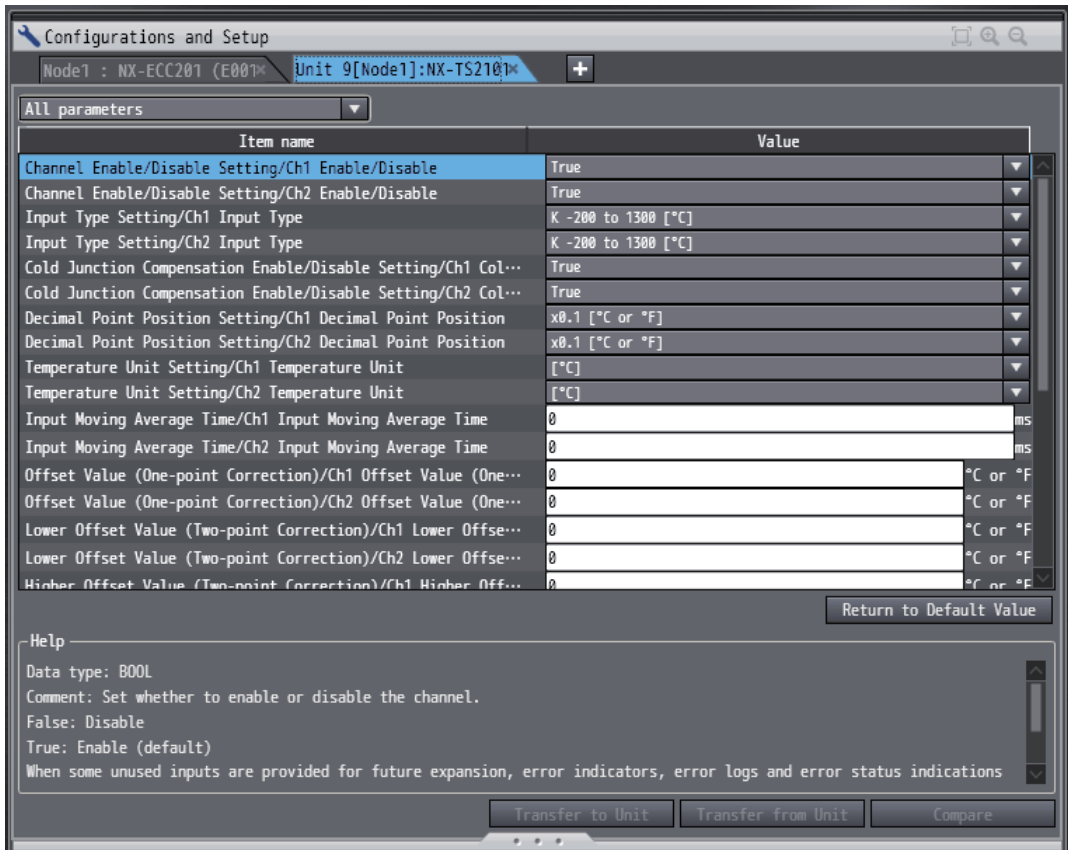

- 2 Select the input type from the list of Input Type Setting for which the channel you want to set.

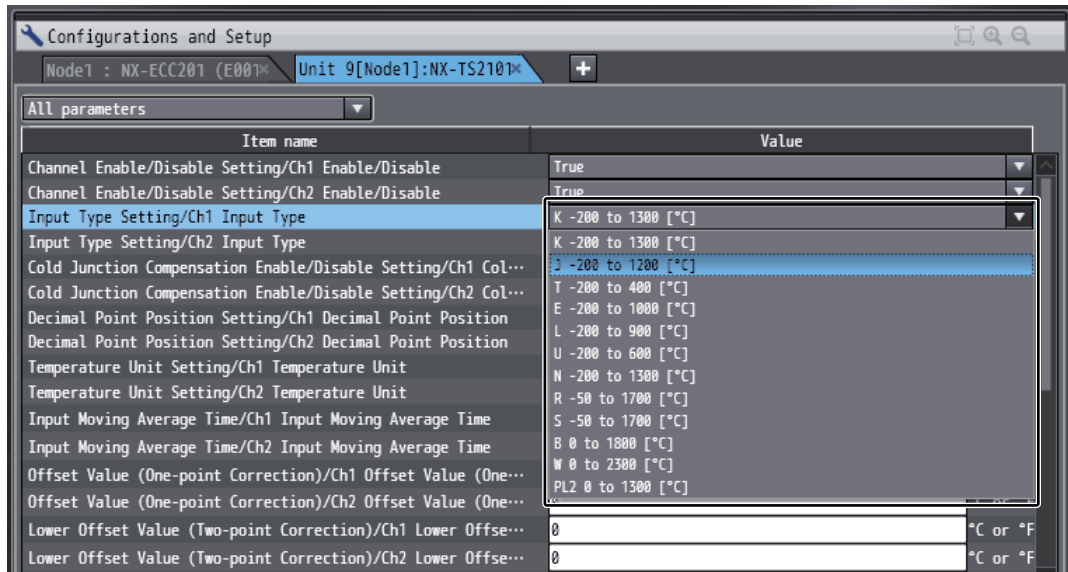

Additional Information

- Click a list button on the tab page to display the item in the Edit Unit Operation Settings Tab Page.

Example:

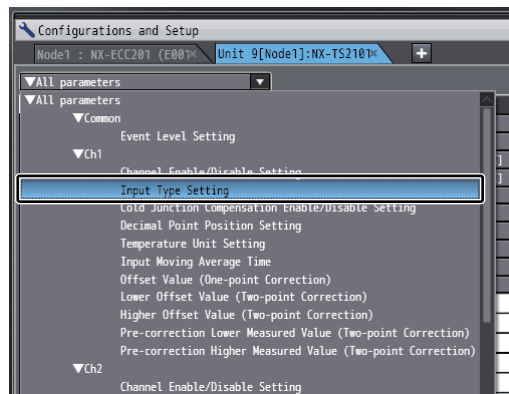

Select Input Type Setting under Ch1

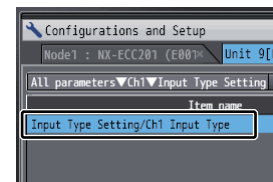

Only Input Type Setting under Ch1 is displayed

- If you set a value different from the default value, the Value on the Sysmac Studio is displayed in a different color.
- You can click the **Return to Default Value** Button to return all set values on the Sysmac Studio to the default values.
- Help for the settings is displayed at the bottom of the Edit Unit Operation Settings Tab Page.

3 Click the **Transfer to Unit** Button.

The settings are transferred from the Sysmac Studio to the NX Unit.

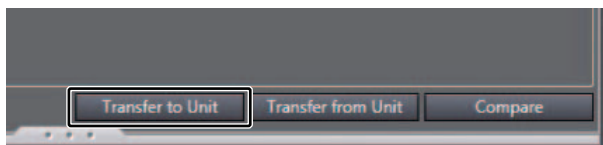

The settings are reflected after the Unit is restarted.



Precautions for Safe Use

The Unit is required to restart after the transfer of Unit operation settings on the Sysmac Studio is completed. Always sufficiently check the safety at the connected devices before you transfer the Unit operation settings.

8-3 Specifications of I/O Data

This section describes the I/O data for Temperature Input Units.

8-3-1 Allocable I/O Data

This section describes the allocable I/O data in the Temperature Input Units.

An I/O entry mapping is assigned to the I/O allocation settings for Temperature Input Unit.

A specific I/O entry is assigned to the I/O entry mapping for each NX Unit model.

These allocations are fixed, so you cannot add others or change them.

In the factory settings, only the following data is assigned to an I/O entry mapping.

- NX-TS□□01/TS□□02: Ch□ Measured Value INT
- NX-TS□□04: Ch□ Measured Value REAL

An I/O entry means the I/O data described in this section. An I/O entry mapping means a collection of I/O entries.

To assign the I/O allocation information of the EtherCAT Slave Terminal to an NJ-series CPU Unit, use the I/O ports for the allocated I/O data.

You can use the Read NX Unit Object instruction or the Write NX Unit Object instruction to access data that is not assigned as I/O. You use index numbers with these instructions.

Refer to the *NJ-series Instructions Reference Manual* (Cat. No. W502-E1-07 or later) for details on the Read NX Unit Object instruction or the Write NX Unit Object instruction.

● Two-point Input Units

Data name	Description	Data type	Default value	I/O port name	Index	Sub-index
Ch1 Status	Aggregated status data for Ch1. *1	WORD	0000 hex	Ch1 Status	6000 hex	01 hex
Ch2 Status	Aggregated status data for Ch2. *2	WORD	0000 hex	Ch2 Status		2 hex
Ch1 Measured Value INT	Analog input measured value (INT) for Ch1.	INT	0	Ch1 Measured Value INT	6001 hex	01 hex
Ch2 Measured Value INT	Analog input measured value (INT) for Ch2.	INT	0	Ch2 Measured Value INT		02 hex
Ch1 Measured Value DINT	Analog input measured value (DINT) for Ch1.	DINT	0	Ch1 Measured Value DINT	6002 hex	01 hex
Ch2 Measured Value DINT	Analog input measured value (DINT) for Ch2.	DINT	0	Ch2 Measured Value DINT		02 hex

Data name	Description	Data type	Default value	I/O port name	Index	Sub-index
Ch1 Measured Value REAL	Analog input measured value (REAL) for Ch1.	REAL	0	Ch1 Measured Value REAL	6003 hex	01 hex
Ch2 Measured Value REAL	Analog input measured value (REAL) for Ch2.	REAL	0	Ch2 Measured Value REAL		02 hex

*1. The following table gives the detailed status for Ch1.

Bit	Data name	Description	Data type	I/O port name
0	Ch1 Sensor Disconnected Error	Sensor disconnected error	BOOL	Ch1 Sensor Disconnected Error
1	Ch1 Over Range	Measured value over range	BOOL	Ch1 Over Range
2	Ch1 Under Range	Measured value under range	BOOL	Ch1 Under Range
3	Ch1 Cold Junction Error	Cold junction error	BOOL	Ch1 Cold Junction Error
4	Ch1 AD Converter Error	AD conversion error	BOOL	Ch1 AD Converter Error
5 to 16	Reserved	–	–	–

*2. The following table gives the detailed status for Ch2.

Bit	Data name	Description	Data type	I/O port name
0	Ch2 Sensor Disconnected Error	Sensor disconnected error	BOOL	Ch2 Sensor Disconnected Error
1	Ch2 Over Range	Measured value over range	BOOL	Ch2 Over Range
2	Ch2 Under Range	Measured value under range	BOOL	Ch2 Under Range
3	Ch2 Cold Junction Error	Cold junction error	BOOL	Ch2 Cold Junction Error
4	Ch2 AD Converter Error	AD conversion error	BOOL	Ch2 AD Converter Error
5 to 16	Reserved	–	–	–

● Four-point Input Units

Data name	Description	Data type	Default value	I/O port name	Index	Subindex
Ch1 Status	Aggregated status data for Ch1. *1	WORD	0000 hex	Ch1 Status	6000 hex	01 hex
Ch2 Status	Aggregated status data for Ch2. *2	WORD	0000 hex	Ch2 Status		02 hex
Ch3 Status	Aggregated status data for Ch3. *1	WORD	0000 hex	Ch3 Status		3 hex
Ch4 Status	Aggregated status data for Ch4. *2	WORD	0000 hex	Ch4 Status		4 hex
Ch1 Measured Value INT	Analog input measured value (INT) for Ch1	INT	0	Ch1 Measured Value INT	6001 hex	01 hex
Ch2 Measured Value INT	Analog input measured value (INT) for Ch2	INT	0	Ch2 Measured Value INT		02 hex
Ch3 Measured Value INT	Analog input measured value (INT) for Ch3	INT	0	Ch3 Measured Value INT		03 hex
Ch4 Measured Value INT	Analog input measured value (INT) for Ch4	INT	0	Ch4 Measured Value INT		04 hex
Ch1 Measured Value DINT	Analog input measured value (DINT) for Ch1	DINT	0	Ch1 Measured Value DINT	6002 hex	01 hex
Ch2 Measured Value DINT	Analog input measured value (DINT) for Ch2	DINT	0	Ch2 Measured Value DINT		02 hex
Ch3 Measured Value DINT	Analog input measured value (DINT) for Ch3	DINT	0	Ch3 Measured Value DINT		03 hex
Ch4 Measured Value DINT	Analog input measured value (DINT) for Ch4	DINT	0	Ch4 Measured Value DINT		04 hex
Ch1 Measured Value REAL	Analog input measured value (REAL) for Ch1	REAL	0	Ch1 Measured Value REAL	6003 hex	01 hex
Ch2 Measured Value REAL	Analog input measured value (REAL) for Ch2	REAL	0	Ch2 Measured Value REAL		02 hex
Ch3 Measured Value REAL	Analog input measured value (REAL) for Ch3	REAL	0	Ch3 Measured Value REAL		03 hex
Ch4 Measured Value REAL	Analog input measured value (REAL) for Ch4	REAL	0	Ch4 Measured Value REAL		04 hex

*1. The following table gives the detailed status for Ch1.

Bit	Data name	Description	Data type	I/O port name
0	Ch1 Sensor Disconnected Error	Sensor disconnected error	BOOL	Ch1 Sensor Disconnected Error
1	Ch1 Over Range	Measured value over range	BOOL	Ch1 Over Range
2	Ch1 Under Range	Measured value under range	BOOL	Ch1 Under Range
3	Ch1 Cold Junction Error	Cold junction error	BOOL	Ch1 Cold Junction Error
4	Ch1 AD Converter Error	AD conversion error	BOOL	Ch1 AD Converter Error
5 to 16	Reserved	–	–	–

*2. The following table gives the detailed status for Ch2.

Bit	Data name	Description	Data type	I/O port name
0	Ch2 Sensor Disconnected Error	Sensor disconnected error	BOOL	Ch2 Sensor Disconnected Error
1	Ch2 Over Range	Measured value over range	BOOL	Ch2 Over Range
2	Ch2 Under Range	Measured value under range	BOOL	Ch2 Under Range
3	Ch2 Cold Junction Error	Cold junction error	BOOL	Ch2 Cold Junction Error
4	Ch2 AD Converter Error	AD conversion error	BOOL	Ch2 AD Converter Error
5 to 16	Reserved	–	–	–

*3. The following table gives the detailed status for Ch3.

Bit	Data name	Description	Data type	I/O port name
0	Ch3 Sensor Disconnected Error	Sensor disconnected error	BOOL	Ch3 Sensor Disconnected Error
1	Ch3 Over Range	Measured value over range	BOOL	Ch3 Over Range
2	Ch3 Under Range	Measured value under range	BOOL	Ch3 Under Range
3	Ch3 Cold Junction Error	Cold junction error	BOOL	Ch3 Cold Junction Error
4	Ch3 AD Converter Error	AD conversion error	BOOL	Ch3 AD Converter Error
5 to 16	Reserved	–	–	–

*4. The following table gives the detailed status for Ch4.

Bit	Data name	Description	Data type	I/O port name
0	Ch4 Sensor Disconnected Error	Sensor disconnected error	BOOL	Ch4 Sensor Disconnected Error
1	Ch4 Over Range	Measured value over range	BOOL	Ch4 Over Range
2	Ch4 Under Range	Measured value under range	BOOL	Ch4 Under Range
3	Ch4 Cold Junction Error	Cold junction error	BOOL	Ch4 Cold Junction Error
4	Ch4 AD Converter Error	AD conversion error	BOOL	Ch4 AD Converter Error
5 to 16	Reserved	–	–	–

8-4 List of Settings

The followings are the setting descriptions, setting ranges, and default values of the functions that can be used in the Temperature Input Units.

If settings have been changed, restart the NX Unit.

The settings are reflected after the Unit is restarted.



Precautions for Safe Use

The Unit is required to restart after the transfer of Unit operation settings on the Sysmac Studio is completed. Always sufficiently check the safety at the connected devices before you transfer the Unit operation settings.

● Two-point Input Units

Setting name	Description	Default value	Setting range	Unit	Index	Subindex	Reference
Ch1 Enable/Disable	Set to enable or disable the channel.*1	TRUE	TRUE or FALSE	–	5000 hex	01 hex	P. 8-22
Ch2 Enable/Disable		TRUE	TRUE or FALSE	–		02 hex	
Ch1 Input Type	Set the sensor to be connected to the channel and its range. *1	*1	*1	–	5001 hex	01 hex	P. 8-3
Ch2 Input Type				–		02 hex	

*1. The meaning of the set value, default value and data range for Ch□ Input Type are as follows.

Meanings of the set values for Ch□ Input Type

Set value	Meaning
15	K –200 to 1300°C
16	K –20 to 600°C (High Resolution)
17	J –200 to 1200°C
18	J –20 to 600°C (High Resolution)
19	T –200 to 400°C
20	E –200 to 1000°C
21	L –200 to 900°C
22	U –200 to 600°C
23	N –200 to 1300°C
24	R –50 to 1700°C
25	S –50 to 1700°C
26	B 0 to 1800°C
27	W 0 to 2300°C
28	PL II 0 to 1300°C
0	Pt100 (3wire) –200 to 850°C
7	Pt1000 (3wire) –200 to 850°C

Default value and data range for Ch□ Input Type

- NX-TS21□□

NX Units	Default value	Data range
NX-TS2101	15	15, 17, 19 to 28
NX-TS2102/TS2104	15	15 to 28

- NX-TS22□□

NX Units	Default value	Data range
NX-TS2201/TS2204	0	0, 7
NX-TS2202	0	0

Setting name	Description	Default value	Setting range	Unit	Index	Sub-index	Reference
Ch1 Input Moving Average Time	Set the time to process moving average.	0	*1	ms	5005 hex	01 hex	P. 8-27
Ch2 Input moving Average Time		0	*1	ms		02 hex	
Ch1 Cold Junction Compensation Enable/Disable	Set to enable or disable the cold junction compensation for the thermocouple input. FALSE: Disable TRUE: Enable	TRUE	TRUE or FALSE	–	5002 hex	01 hex	P. 8-34
Ch2 Cold Junction Compensation Enable/Disable		TRUE	TRUE or FALSE	–		02 hex	
Ch1 Temperature Unit	Set the temperature unit for the channel analog input measured value. 0: °C 1: °F	0	0/1	–	5004 hex	01 hex	P. 8-39
Ch2 Temperature Unit		0	0/1	–		02 hex	
Ch1 Offset Value (One-point Correction)	Set the offset value to correct the one point of the channel analog input measured value.	0	-400 to 5000	°C or °F	5010 hex	01 hex	P. 8-44
Ch2 Offset Value (One-point Correction)		0	-400 to 5000			02 hex	
Ch1 Lower Offset Value (Two-point Correction)	Set the offset value (lower) to be used for the two-point correction of the channel analog input measured value.	0	-400 to 5000	°C or °F	5011 hex	01 hex	
Ch2 Lower Offset Value (Two-point Correction)		0	-400 to 5000			02 hex	
Ch1 Higher Offset Value (Two-point Correction)	Set the offset value (upper) to be used for the two-point correction of the channel analog input measured value.	0	-400 to 5000	°C or °F	5012 hex	01 hex	
Ch2 Higher Offset Value (Two-point Correction)		0	-400 to 5000			02 hex	
Ch1 Pre-correction Lower Measured Value (Two-point Correction)	Set the pre-correction measured value (lower) to be used for the two-point correction of the channel analog input measured value.	0	-400 to 5000	°C or °F	5013 hex	01 hex	
Ch2 Pre-correction Lower Measured Value (Two-point Correction)		0	-400 to 5000			02 hex	

Setting name	Description	Default value	Setting range	Unit	Index	Sub-index	Reference
Ch1 Pre-correction Higher Measured Value (Two-point Correction)	Set the pre-correction measured value (upper) to be used for the two-point correction of the channel analog input measured value.	0	-400 to 5000	°C or °F	5014 hex	01 hex	P. 8-44
Ch2 Pre-correction Higher Measured Value (Two-point Correction)		0	-400 to 5000			02 hex	
Ch1 Decimal Point Position	Set the decimal point position for the channel analog input measured value (INT and DINT). 0: ×1 °C or °F 1: ×0.1 °C or °F 2: ×0.01 °C or °F	1	0/1/2	–	5003 hex	01 hex	P. 8-51
Ch2 Decimal Point Position		1	0/1/2			02 hex	

*1. The data range of Ch□ Input Moving Average Time depends on the model. The descriptions for each model are as below.

NX Units	Data range
NX-TS2□01	0 to 32000
NX-TS2□02	0 to 1280
NX-TS2□04	0 to 7680

● Four-point Input Units

Setting name	Description	Default value	Setting range	Unit	Index	Subindex	Reference
Ch1 Enable/Disable	Set to enable or disable the channel.*1 FALSE: Disable TRUE: Enable	TRUE	TRUE or FALSE	–	5000 hex	01 hex	P. 8-22
Ch2 Enable/Disable		TRUE	TRUE or FALSE	–		02 hex	
Ch3 Enable/Disable		TRUE	TRUE or FALSE	–		03 hex	
Ch4 Enable/Disable		TRUE	TRUE or FALSE	–		04 hex	
Ch1 Input Type	Set the sensor to be connected to the channel and its range.*1	*1	*1	–	5001 hex	01 hex	P. 8-3
Ch2 Input Type				–		02 hex	
Ch3 Input Type				–		03 hex	
Ch4 Input Type				–		04 hex	

*1. The meaning of the set value, default value and data range for Ch□ Input Type are as follows.
Meanings of the set values for Ch□ Input Type

Set value	Meaning
15	K –200 to 1300°C
16	K –20 to 600°C (High Resolution)
17	J –200 to 1200°C
18	J –20 to 600°C (High Resolution)
19	T –200 to 400°C
20	E –200 to 1000°C
21	L –200 to 900°C
22	U –200 to 600°C
23	N –200 to 1300°C
24	R –50 to 1700°C
25	S –50 to 1700°C
26	B 0 to 1800°C
27	W 0 to 2300°C
28	PL II 0 to 1300°C
0	Pt100 (3wire) –200 to 850°C
7	Pt1000 (3wire) –200 to 850°C

Default value and data range for Ch□ Input Type

• NX-TS31□□

NX Units	Default value	Data range
NX-TS3101	15	15, 17, 19 to 28
NX-TS3102/3104	15	15 to 28

• NX-TS32□□

NX Units	Default value	Data range
NX-TS3201/3204	0	0, 7
NX-TS3202	0	0

Setting name	Description	Default value	Setting range	Unit	Index	Sub-index	Reference
Ch1 Input Moving Average Time	Set the time to process moving average.	0	*1	ms	5005 hex	01 hex	P. 8-27
Ch2 Input Moving Average Time		0	*1	ms		02 hex	
Ch3 Input Moving Average Time		0	*1	ms		03 hex	
Ch4 Input Moving Average Time		0	*1	ms		04 hex	
Ch1 Cold Junction Compensation Enable/Disable	Set to enable or disable the cold junction compensation for the thermocouple input. FALSE: Disable TRUE: Enable	TRUE	TRUE or FALSE	–	5002 hex	01 hex	P. 8-34
Ch2 Cold Junction Compensation Enable/Disable		TRUE	TRUE or FALSE	–		02 hex	
Ch3 Cold Junction Compensation Enable/Disable		TRUE	TRUE or FALSE	–		03 hex	
Ch4 Cold Junction Compensation Enable/Disable		TRUE	TRUE or FALSE	–		04 hex	
Ch1 Temperature Unit	Set the temperature unit for the channel analog input measured value.	0	0/1	–	5004 hex	01 hex	P. 8-39
Ch2 Temperature Unit		0	0/1	–		02 hex	
Ch3 Temperature Unit		0	0/1	–		03 hex	
Ch4 Temperature Unit		0: °C 1: °F	0	0/1		–	
Ch1 Offset Value (One-point Correction)	Set the offset value to correct the one point of the channel analog input measured value.	0	-400 to 5000	°C or °F	5010 hex	01 hex	P. 8-44
Ch2 Offset Value (One-point Correction)		0	-400 to 5000			02 hex	
Ch3 Offset Value (One-point Correction)		0	-400 to 5000			03 hex	
Ch4 Offset Value (One-point Correction)		0	-400 to 5000			04 hex	
Ch1 Lower Offset Value (Two-point Correction)	Set the offset value (lower) to be used for the two-point correction of the channel analog input measured value.	0	-400 to 5000	°C or °F	5011 hex	01 hex	P. 8-44
Ch2 Lower Offset Value (Two-point Correction)		0	-400 to 5000			02 hex	
Ch3 Lower Offset Value (Two-point Correction)		0	-400 to 5000			03 hex	
Ch4 Lower Offset Value (Two-point Correction)		0	-400 to 5000			04 hex	
Ch1 Higher Offset Value (Two-point Correction)	Set the offset value (upper) to be used for the two-point correction of the channel analog input measured value.	0	-400 to 5000	°C or °F	5012 hex	01 hex	
Ch2 Higher Offset Value (Two-point Correction)		0	-400 to 5000			02 hex	
Ch3 Higher Offset Value (Two-point Correction)		0	-400 to 5000			03 hex	
Ch4 Higher Offset Value (Two-point Correction)		0	-400 to 5000			04 hex	

Setting name	Description	Default value	Setting range	Unit	Index	Subindex	Reference
Ch1 Pre-correction Lower Measured Value (Two-point Correction)	Set the pre-correction measured value (lower) to be used for the two-point correction of the channel analog input measured value.	0	-400 to 5000	°C or °F	5013 hex	01 hex	P. 8-44
Ch2 Pre-correction Lower Measured Value (Two-point Correction)		0	-400 to 5000			02 hex	
Ch3 Pre-correction Lower Measured Value (Two-point Correction)		0	-400 to 5000			03 hex	
Ch4 Pre-correction Lower Measured Value (Two-point Correction)		0	-400 to 5000			04 hex	
Ch1 Pre-correction Higher Measured Value (Two-point Correction)	Set the pre-correction measured value (upper) to be used for the two-point correction of the channel analog input measured value.	0	-400 to 5000	°C or °F	5014 hex	01 hex	
Ch2 Pre-correction Higher Measured Value (Two-point Correction)		0	-400 to 5000			02 hex	
Ch3 Pre-correction Higher Measured Value (Two-point Correction)		0	-400 to 5000			03 hex	
Ch4 Pre-correction Higher Measured Value (Two-point Correction)		0	-400 to 5000			04 hex	
Ch1 Decimal Point Position	Set the decimal point position for the channel analog input measured value (INT and DINT). 0: ×1 °C or °F 1: ×0.1 °C or °F 2: ×0.01 °C or °F	1	0 to 2	–	5003 hex	01 hex	P. 8-51
Ch2 Decimal Point Position		1	0 to 2	–		02 hex	
Ch3 Decimal Point Position		1	0 to 2	–		03 hex	
Ch4 Decimal Point Position		1	0 to 2	–		04 hex	

*1. The data range of Ch□ Input Moving Average Time depends on the model. The descriptions for each model are as below.

NX Units	Data range
NX-TS3□01	0 to 32000
NX-TS3□02	0 to 1280
NX-TS3□04	0 to 7680

8-5 Functions

This section describes the Temperature Input Unit functions.

Refer to the specifications of each model in *A-1 Data Sheet* on page A-2 for details on the functions.

8-5-1 List of Temperature Input Unit Functions

Function name	Meaning	Reference
Free-Run Refreshing	With this I/O refreshing method, the refresh cycle of the NX bus and the I/O refresh cycles of the NX Units are asynchronous.	<i>5-2-4 Free-Run Refreshing</i> on page 5-4
Selecting Channel To Use	This function disables errors in unused channels. The conversion time for its own Unit will not be shortened even if errors are disabled.	<i>8-5-3 Selecting Channel To Use</i> on page 8-22
Moving Average	This function uses the average value of inputs of the set time as the measured value. When the input value fluctuates frequently due to noises, averaging can be used to obtain a stable measured value.	<i>8-5-4 Moving Average</i> on page 8-27
Sensor Disconnection Detection	This function detects disconnections of sensors that are connected to the input terminals.	<i>8-5-5 Sensor Disconnection Detection</i> on page 8-32
Over Range/Under Range Detection	This function detects when the measured value exceeds the range for which temperature conversion is possible.	<i>8-5-6 Over Range/Under Range Detection</i> on page 8-33
Cold Junction Compensation Enable/Disable Setting	This function enables or disables the cold junction compensation for thermocouple inputs. Enable this function normally.	<i>8-5-7 Cold Junction Compensation Enable/Disable Setting</i> on page 8-34
Temperature Unit Setting (°C/°F)	This function sets °C (celsius) or °F (fahrenheit) as the temperature unit for measured values.	<i>8-5-8 Temperature Unit (°C/°F) Setting</i> on page 8-39
Input Correction	This function corrects measured values. It is used when there is a noticeable variation from values measured with other gauges. One-point correction and two-point correction methods are provided.	<i>8-5-9 Input Correction</i> on page 8-44
Decimal Point Position Setting	This function sets the number of digits which is displayed after the decimal point when measured values are INT and DINT data.	<i>8-5-10 Decimal Point Position Setting</i> on page 8-51

8-5-2 Function Block Diagram

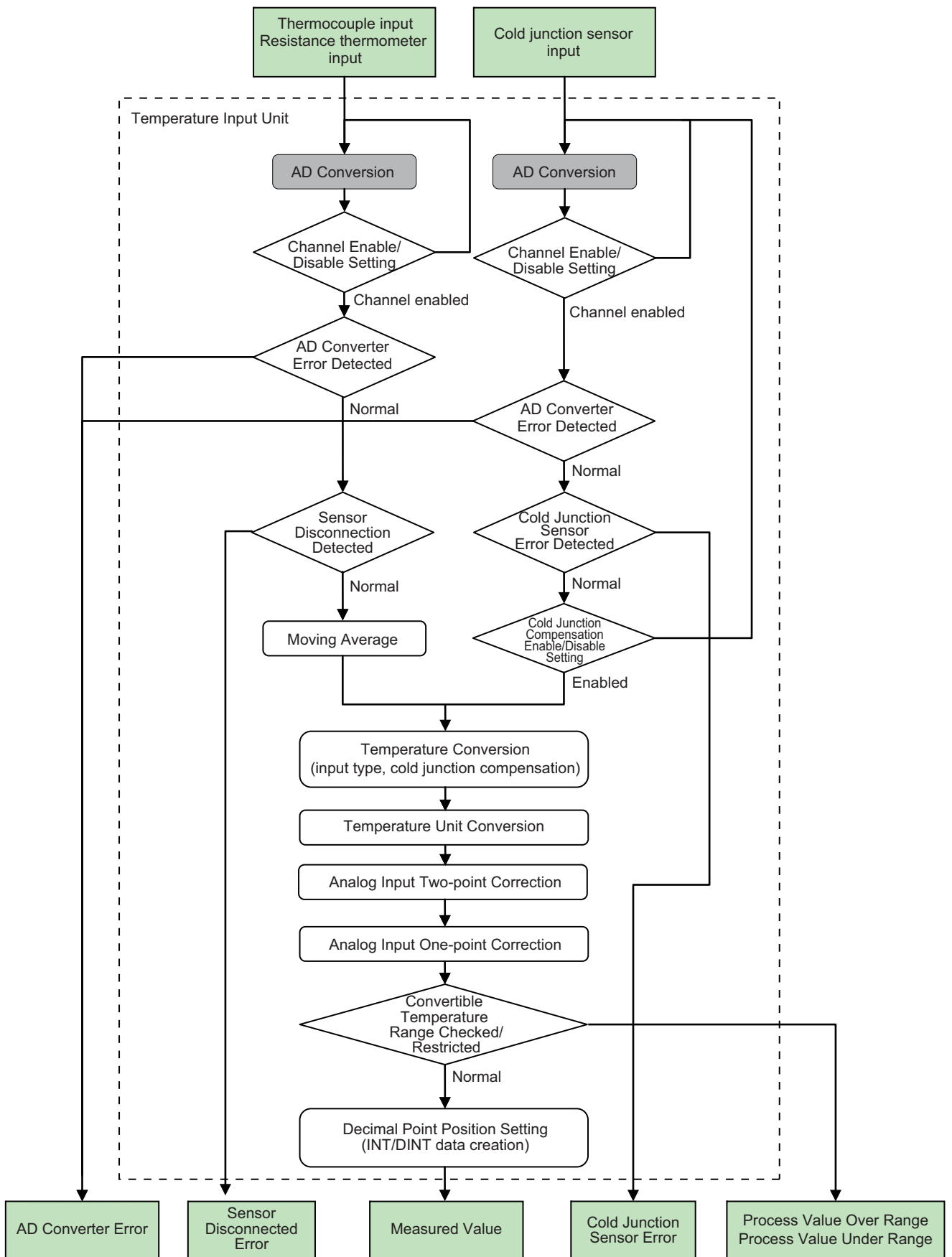

8-5-3 Selecting Channel To Use

Purpose

This function is used to avoid errors in unused channels.

Details on the Function

This function disables measured value math operation and error detection processing for unused channels.

However, the conversion time of its own Unit will not be shortened even if the channels are disabled.

The measured value and status for the disabled channels are fixed to 0 after the power is reset.

The data are fixed to 0 are as follows.

- Status of each channel
- Measured value

● Two-point Input Units

Setting name	Description	Default value	Unit
Ch1 Enable/Disable	Set to enable or disable the channel. *1	TRUE	–
Ch2 Enable/Disable		TRUE	–
	FALSE: Disable TRUE: Enable		

*1. If an unused channel for expansion exists, it is possible to avoid errors on that channel.

● Four-point Input Units

Setting name	Description	Default value	Unit
Ch1 Enable/Disable	Set to enable or disable the channel. *1	TRUE	–
Ch2 Enable/Disable		TRUE	–
Ch3 Enable/Disable		TRUE	–
Ch4 Enable/Disable		TRUE	–
	FALSE: Disable TRUE: Enable		

*1. If an unused channel for expansion exists, it is possible to avoid errors on that channel.

Target NX Units

All Temperature Input Units

Setting Method

- Use the Sysmac Studio

- 1 Use any of the following methods to display the Edit Unit Operation Settings Tab Page on the Edit Slave Terminal Configuration Tab Page.

Double-click the NX Unit.

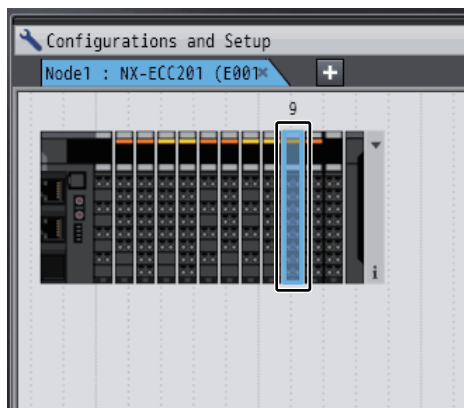

Right-click the NX Unit, then select *Edit Unit Operation Settings* from the menu.

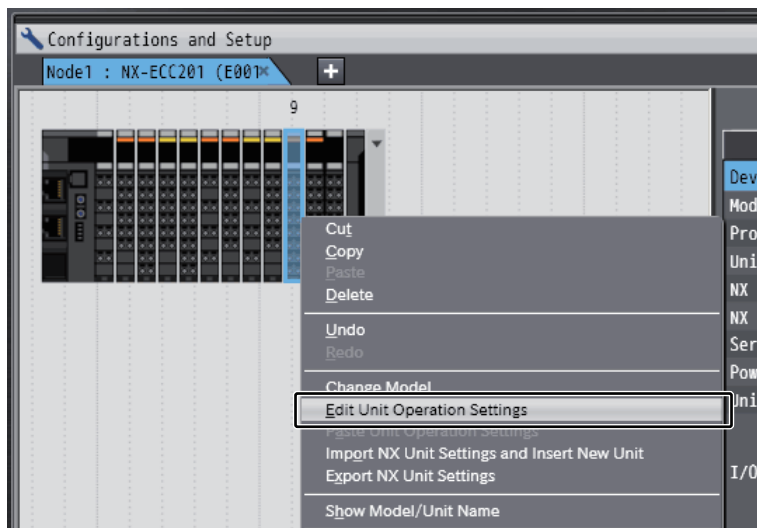

Select the NX Unit, then click the **Edit Unit Operation Settings** Button.

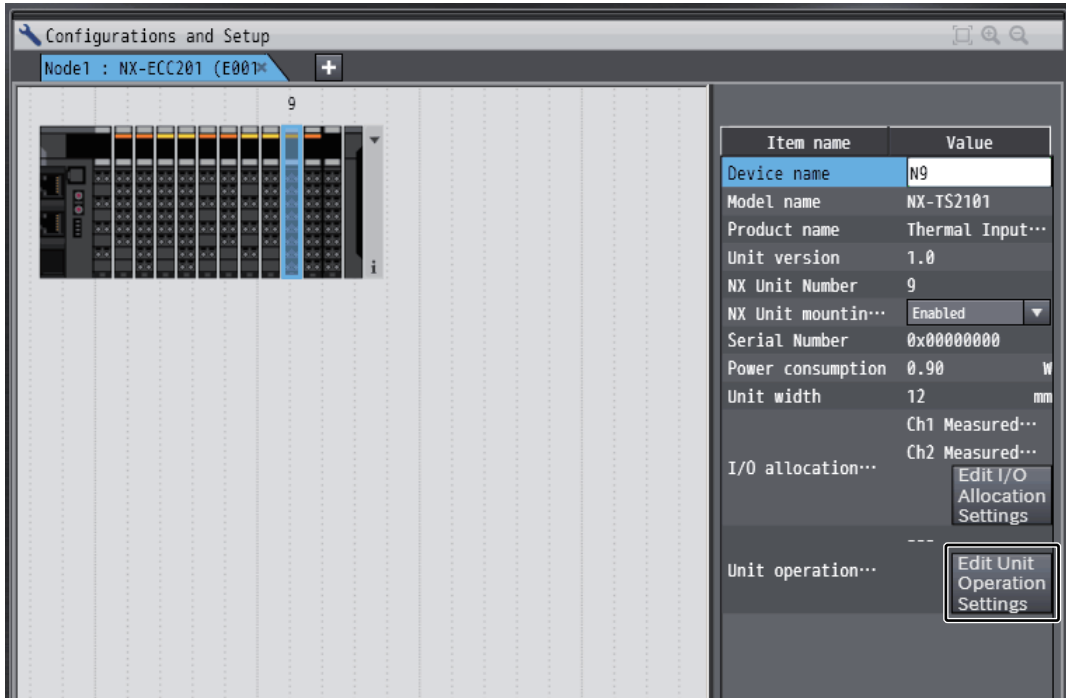

The Edit Unit Operation Settings Tab Page is displayed.

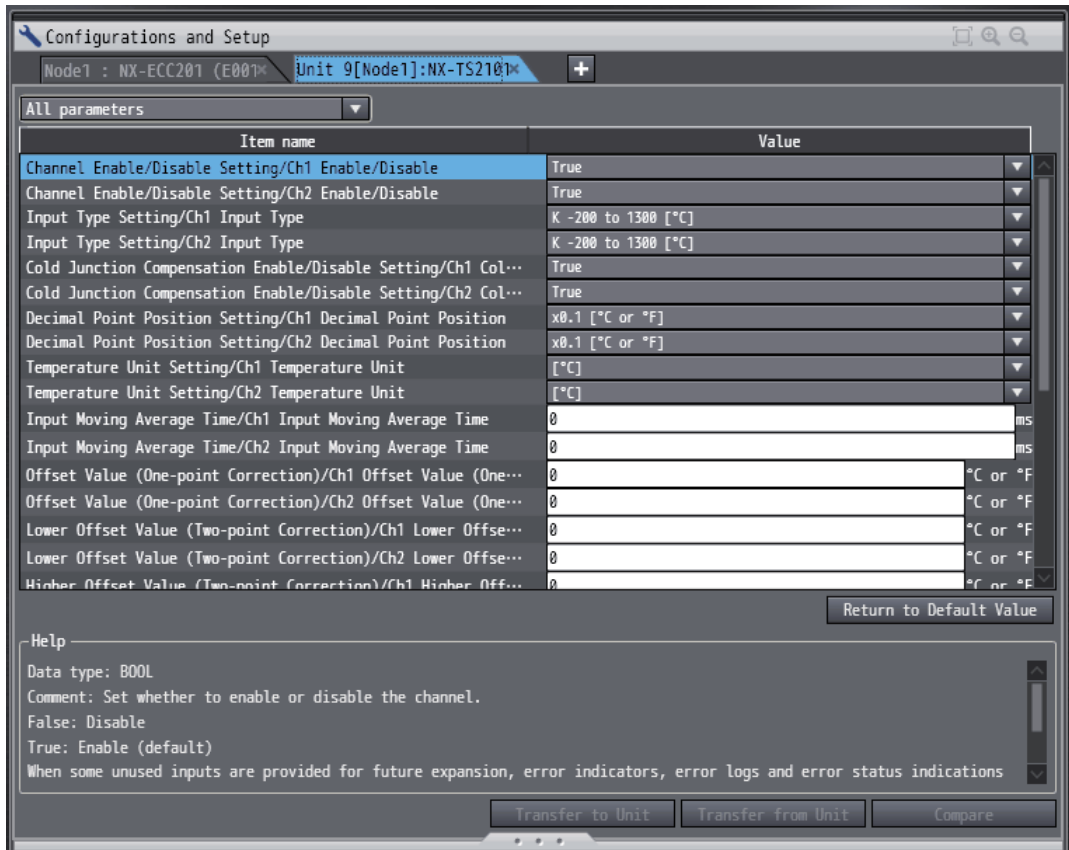

- 2 Select *True* (Enable) or *False* (Disable) from the list of Channel Enable/Disable Setting for which the channel you want to set.

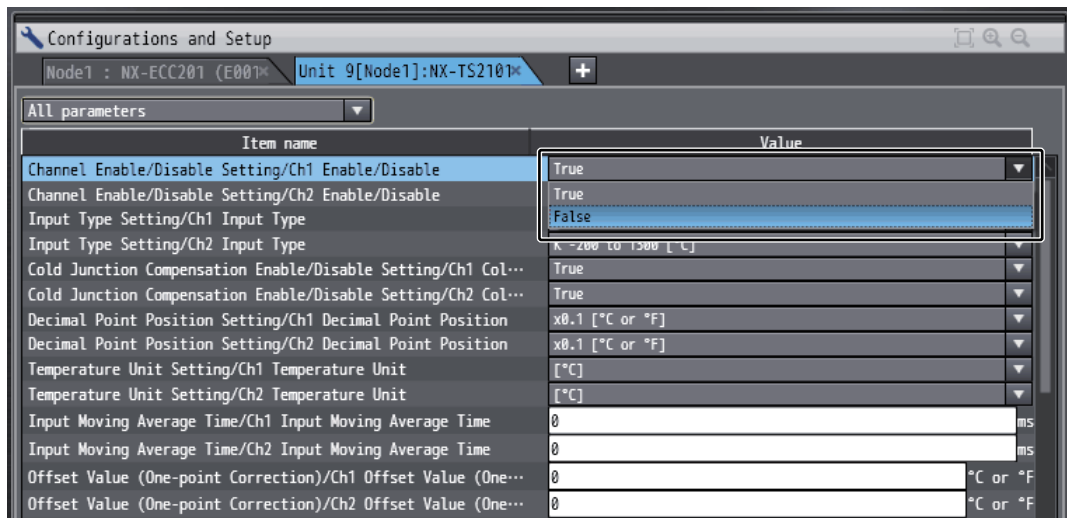

Additional Information

- Click a list button on the tab page to display the item in the Edit Unit Operation Settings Tab Page.

Example:

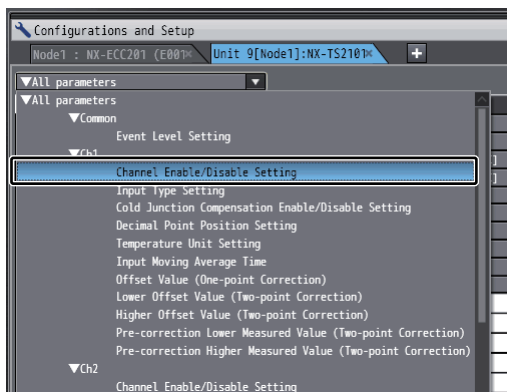

Select Channel Enable/Disable Setting under Ch1

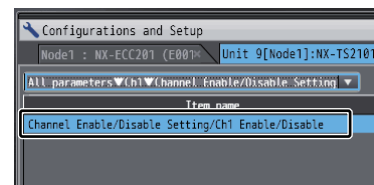

Only Channel Enable/Disable Setting under Ch1 is displayed

- If you set a value different from the default value, the Value on the Sysmac Studio is displayed in a different color.
- You can click the **Return to Default Value** Button to return all set values on the Sysmac Studio to the default values.
- Help for the settings is displayed at the bottom of the Edit Unit Operation Settings Tab Page.

3 Click the **Transfer to Unit** Button.

The settings are transferred from the Sysmac Studio to the NX Unit.

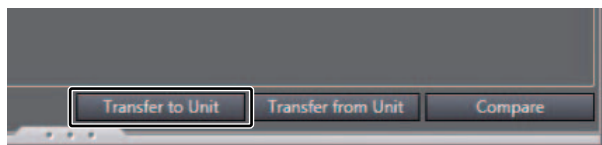

The settings are reflected after the Unit is restarted.



Precautions for Safe Use

The Unit is required to restart after the transfer of Unit operation settings on the Sysmac Studio is completed. Always sufficiently check the safety at the connected devices before you transfer the Unit operation settings.

8-5-4 Moving Average

Purpose

The measured value can be filtered in order to eliminate fluctuations due to noise or sharp changes.

Details on the Function

- The moving average of the past inputs of the set time is calculated and used as the measured value.
- The moving average processing is not performed if it is set to 0 ms.
- If an error that the measurement value used when an error occurs is detected, the moving average processing is not performed. The value becomes the measured value immediately when an error occurs. (Refer to 8-6 *Measured Values Used When an Error Occurs* on page 8-57.)
- When turns ON the power and recovers from the error that the measurement value is used when an error occurs (Refer to 8-6 *Measured Values Used When an Error Occurs* on page 8-57), the past input values are cleared and the input values at the recovery are stored in the moving average buffer.



Additional Information

The input moving average time setting is rounded up in units of conversion time. For example, if the input moving average time of channels is set to 12 ms in the NX Unit with a conversion time of 10 ms, internally, the input moving average time is set to 20 ms and the processing is performed by averaging the last one input and the latest input.

● Two-point Input Units

Setting name	Description	Default value	Setting range	Unit
Ch1 Input Moving Average Time	Set the time to process moving average.	0	*1	ms
Ch2 Input Moving Average Time		0	*1	ms

*1. The data range of Ch□ Input Moving Average Time depends on the model. The descriptions for each model are as below.

NX Units	Data range
NX-TS2□ 01	0 to 32000
NX-TS2□ 02	0 to 1280
NX-TS2□ 04	0 to 7680

● Four-point Input Units

Setting name	Description	Default value	Setting range	Unit
Ch1 Input Moving Average Time	Set the time to process moving average.	0	*1	ms
Ch2 Input Moving Average Time		0	*1	ms
Ch3 Input Moving Average Time		0	*1	ms
Ch4 Input Moving Average Time		0	*1	ms

*1. The data range of Ch□ Input Moving Average Time depends on the model. The descriptions for each model are as below.

NX Units	Data range
NX-TS3□01	0 to 32000
NX-TS3□02	0 to 1280
NX-TS3□04	0 to 7680

Target NX Units

All Temperature Input Units

Setting Method

● Use the Sysmac Studio

- 1 Use any of the following methods to display the Edit Unit Operation Settings Tab Page on the Edit Slave Terminal Configuration Tab Page.

Double-click the NX Unit.

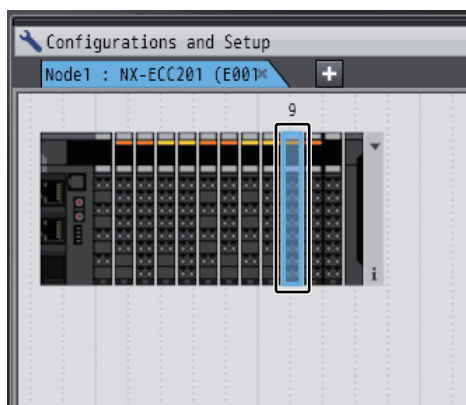

Right-click the NX Unit, then select *Edit Unit Operation Settings* from the menu.

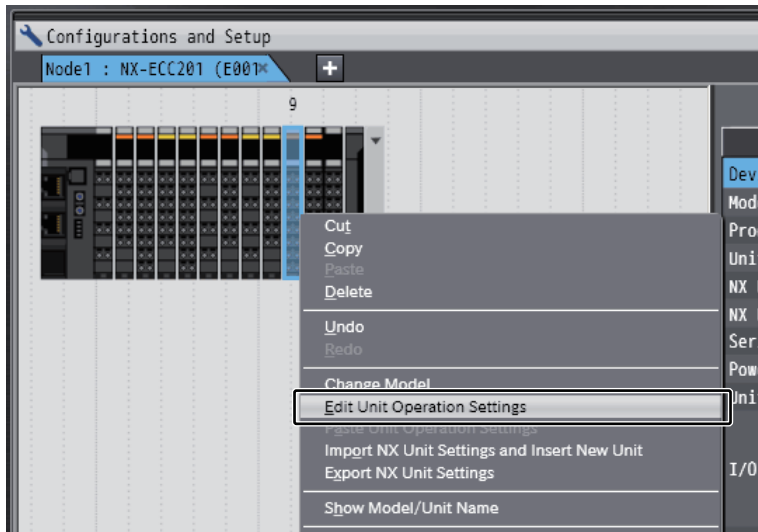

Select the NX Unit, then click the **Edit Unit Operation Settings** Button.

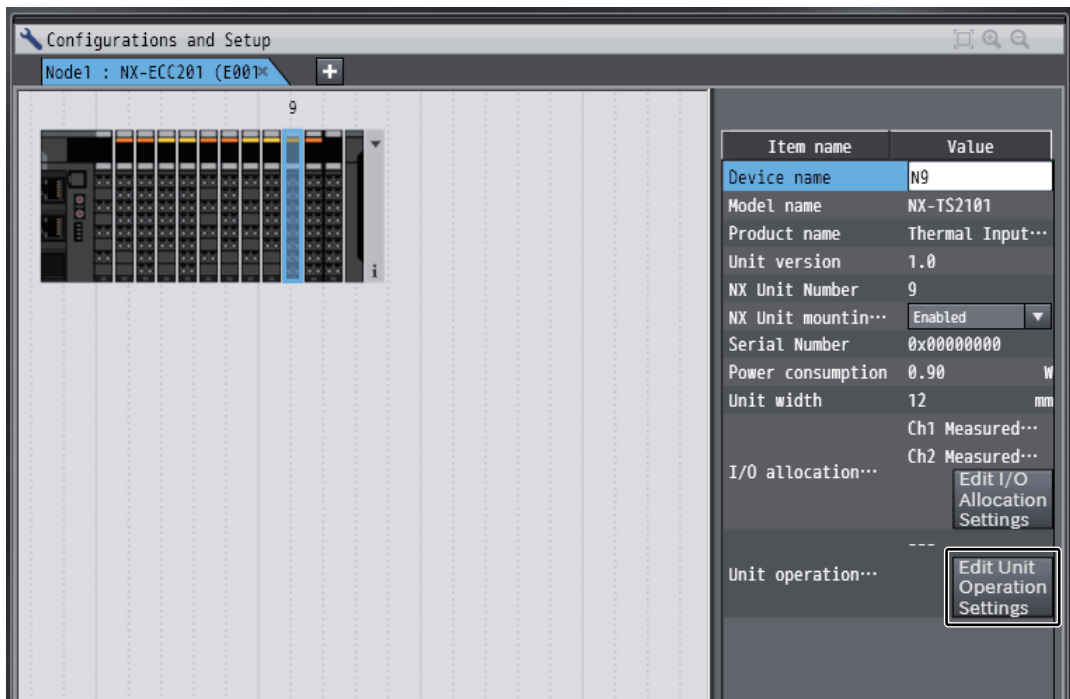

The Edit Unit Operation Settings Tab Page is displayed.

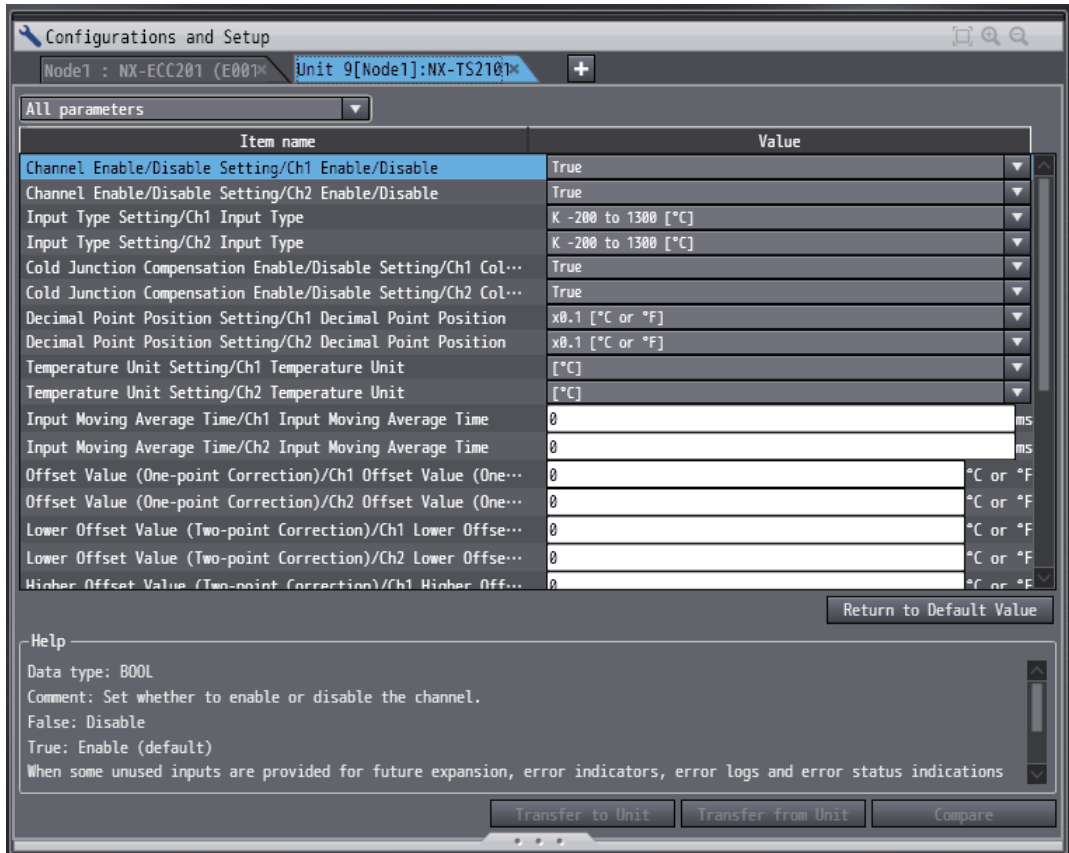

- 2 Enter the time to process moving average (0 to 32000 ms) in the text box of Input Moving Average Time for the channel you want to set.

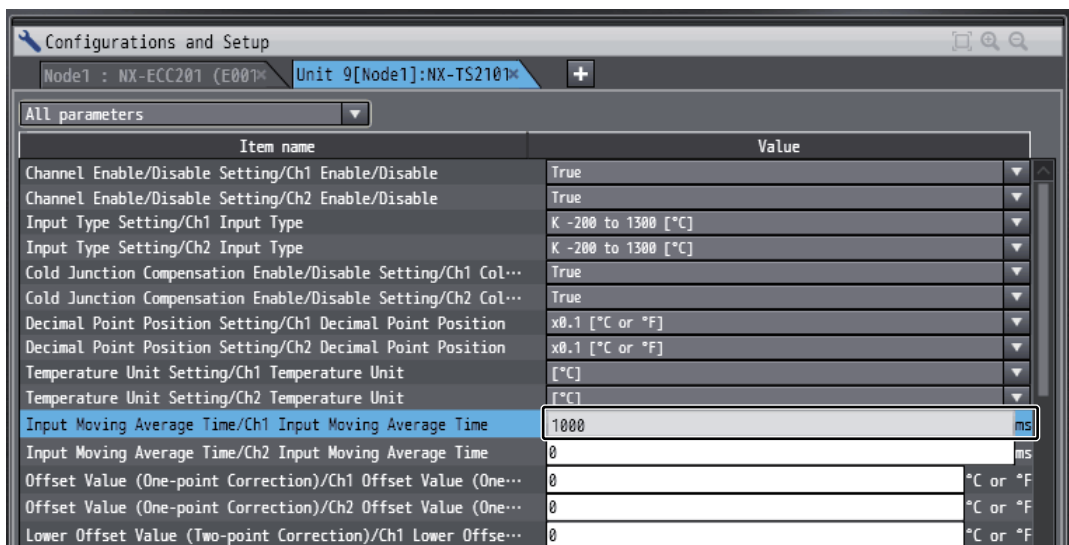



Additional Information

- Click a list button on the tab page to display the item in the Edit Unit Operation Settings Tab Page.

Example:

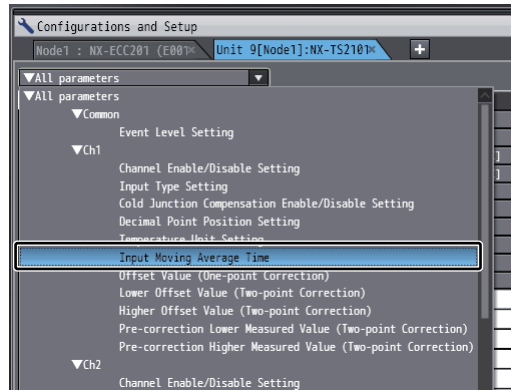

Select Input Moving Average Time under Ch1

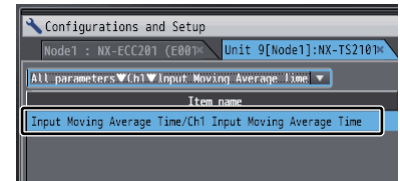

Only Input Moving Average Time under Ch1 is displayed

- If you set a value different from the default value, the Value on the Sysmac Studio is displayed in a different color.
- You can click the **Return to Default Value** Button to return all set values on the Sysmac Studio to the default values.
- Help for the settings is displayed at the bottom of the Edit Unit Operation Settings Tab Page.

3 Click the **Transfer to Unit** Button.

The settings are transferred from the Sysmac Studio to the NX Unit.

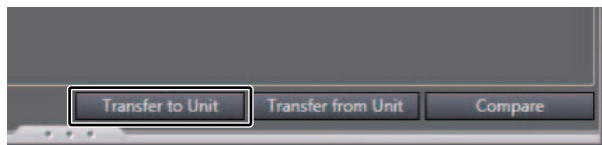

The settings are reflected after the Unit is restarted.



Precautions for Safe Use

The Unit is required to restart after the transfer of Unit operation settings on the Sysmac Studio is completed. Always sufficiently check the safety at the connected devices before you transfer the Unit operation settings.

8-5-5 Sensor Disconnection Detection

Purpose

This function detects disconnections of thermocouple sensors and resistance thermometer sensors.

Details on the Function

- If a sensor is disconnected (including sensor is not connected and incorrect wiring), the value becomes the measured value when an error occurs. (Refer to *8-6 Measured Values Used When an Error Occurs* on page 8-57.) At this time, the Sensor Disconnected Error Status turns ON and a Sensor Disconnected Error event (event code: 65100000 hex) occurs.
- When the cause of the sensor disconnection is removed, the value becomes the normal measured value. When the cause of the error is removed and the error is reset, the Sensor Disconnected Error Status turns OFF.
- If the moving average is enabled, the disconnection detection is performed to the input value before the moving average processing.
- Refer to *A-3 List of NX Objects* on page A-58 for details on status and *9-3-2 Event Codes and Corrections for Errors* on page 9-9 for details on events.



Additional Information

When a Sensor Disconnected Error event occurs, a Process Value Over Range event may also occur.

Target NX Units

All Temperature Input Units

Setting Method

No setting is required.

8-5-6 Over Range/Under Range Detection

Purpose

This function detects when the measured value exceeds the range for which temperature conversion is possible.

Details on the Function

- If the input exceeds the upper limit of the convertible temperature range, the measured value is fixed at the upper limit. At this time, the Over Range Status turns ON and a Process Value Over Range event (event code: 65110000 hex) occurs.
- If the input falls below the lower limit of the convertible temperature range, the measured value is fixed at the lower limit. At this time, the Under Range Status turns ON and a Process Value Under Range event (event code: 65120000 hex) occurs.
- When the input returns to the convertible temperature range, the fixing is cancelled and the value becomes the normal measured value. When the cause of the error is removed and the error is reset, the Over Range/Under Range Status turns OFF.
- Refer to *A-3 List of NX Objects* on page A-58 for details on status and *9-3-2 Event Codes and Corrections for Errors* on page 9-9 for details on events.

Target NX Units

All Temperature Input Units

Setting Method

No setting is required.

8-5-7 Cold Junction Compensation Enable/Disable Setting

Purpose

This function enables or disables the cold junction compensation using cold junction sensors that are mounted on thermocouple input terminal blocks.

Enable this function normally.

Regardless of the cold junction compensation enable/disable setting, do not remove the cold junction sensors that are mounted on the terminal blocks when they are delivered.

Details on the Function

● If Cold Junction Compensation is Enable

The measured value is the value with cold junction compensation using the cold junction sensor that is mounted on the terminal block.

● If Cold Junction Compensation is Disable

The measured value is the value without the cold junction compensation using the cold junction sensor that is mounted on the terminal block.

● Cold Junction Sensor Error Detected

- If a cold junction sensor is disconnected, the measured value for channels of the corresponding sensor becomes the measured value when an error occurs. (Refer to *8-6 Measured Values Used When an Error Occurs* on page 8-57.) At this time, the Cold Junction Sensor Error status turns ON.
- When the cause of the cold junction sensor error is removed, the value becomes the normal measured value. When the cause of the error is removed and the error is reset, the Cold Junction Sensor Error Status turns OFF.
- Refer to *A-3 List of NX Objects* on page A-58 for details on the status.

● Two-point Input Units

Setting name	Description	Default value	Setting range	Unit
Ch1 Cold Junction Compensation Enable/Disable	Set to enable or disable the cold junction compensation for the thermocouple input.	TRUE	TRUE or FALSE	—
Ch2 Cold Junction Compensation Enable/Disable	FALSE: Disable TRUE: Enable	TRUE	TRUE or FALSE	—

● Four-point Input Units

Setting name	Description	Default value	Setting range	Unit
Ch1 Cold Junction Compensation Enable/Disable	Set to enable or disable the cold junction compensation for the thermocouple input. FALSE: Disable TRUE: Enable	TRUE	TRUE or FALSE	–
Ch2 Cold Junction Compensation Enable/Disable		TRUE	TRUE or FALSE	–
Ch3 Cold Junction Compensation Enable/Disable		TRUE	TRUE or FALSE	–
Ch4 Cold Junction Compensation Enable/Disable		TRUE	TRUE or FALSE	–

Target NX Units

Thermocouple Temperature Input Units

Setting Method

● Use the Sysmac Studio

- 1 Use any of the following methods to display the Edit Unit Operation Settings Tab Page on the Edit Slave Terminal Configuration Tab Page.

Double-click the NX Unit.

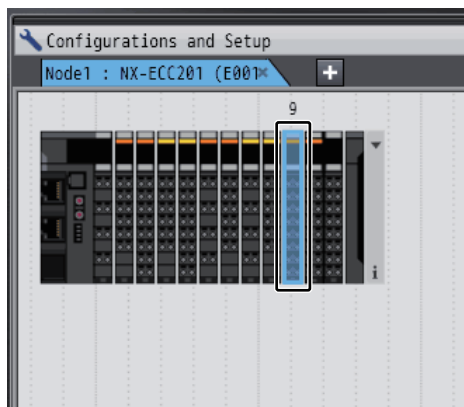

Right-click the NX Unit, then select *Edit Unit Operation Settings* from the menu.

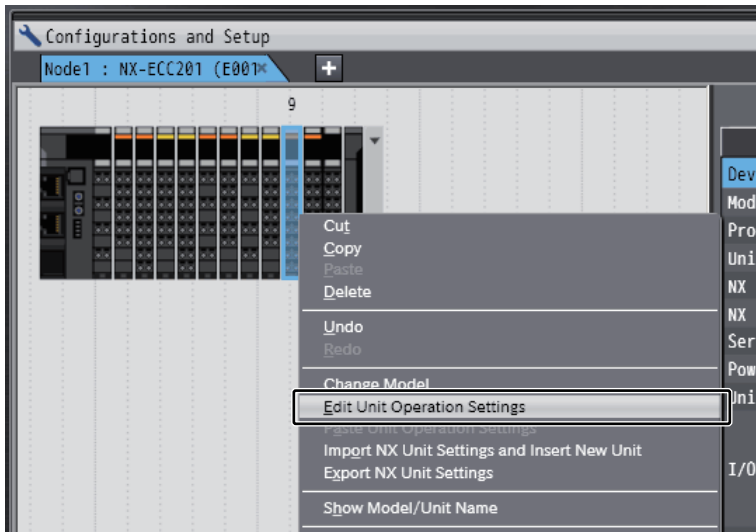

Select the NX Unit, then click the **Edit Unit Operation Settings** Button.

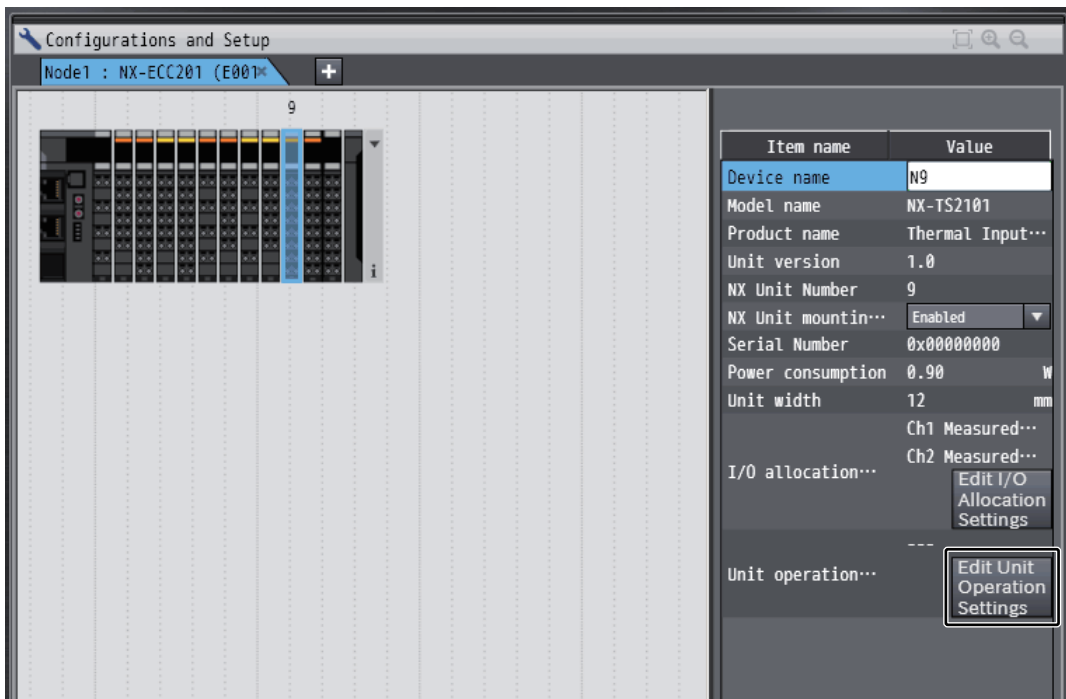

The Edit Unit Operation Settings Tab Page is displayed.

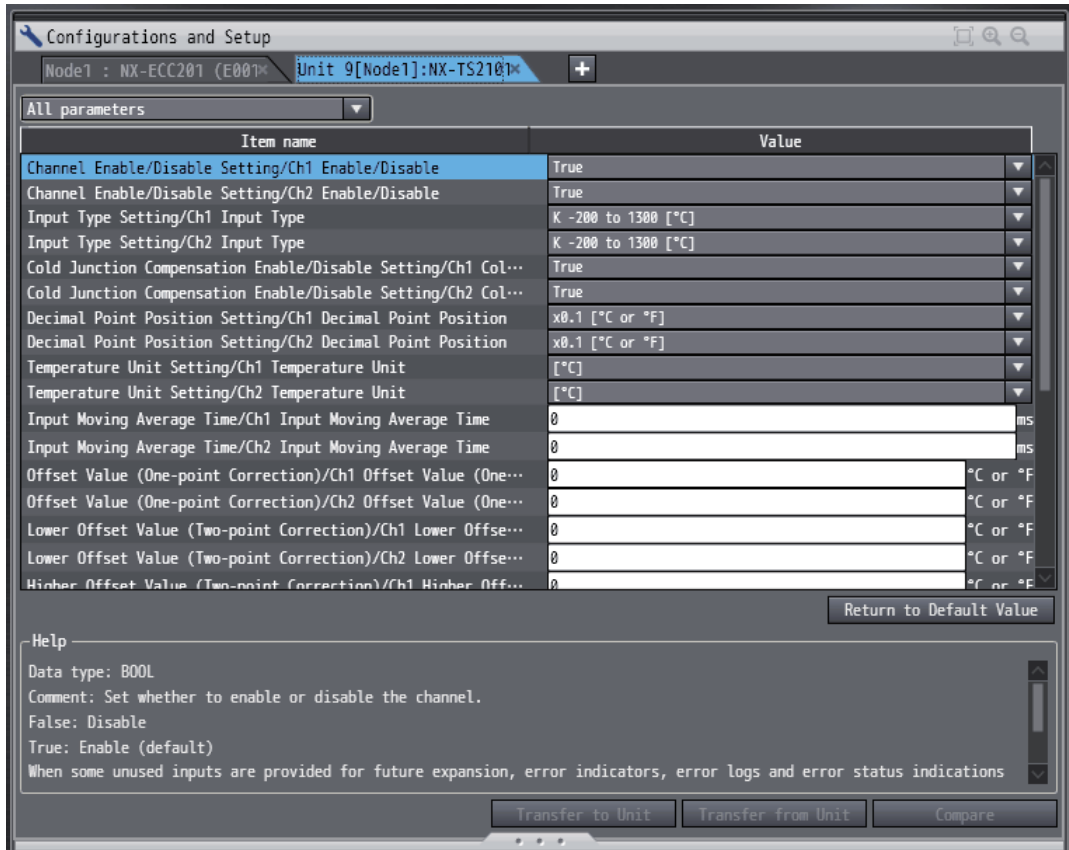

- 2 Select *True* (Enable) or *False* (Disable) from the list of Cold Junction Compensation Enable/Disable Setting for which the channel you want to set.

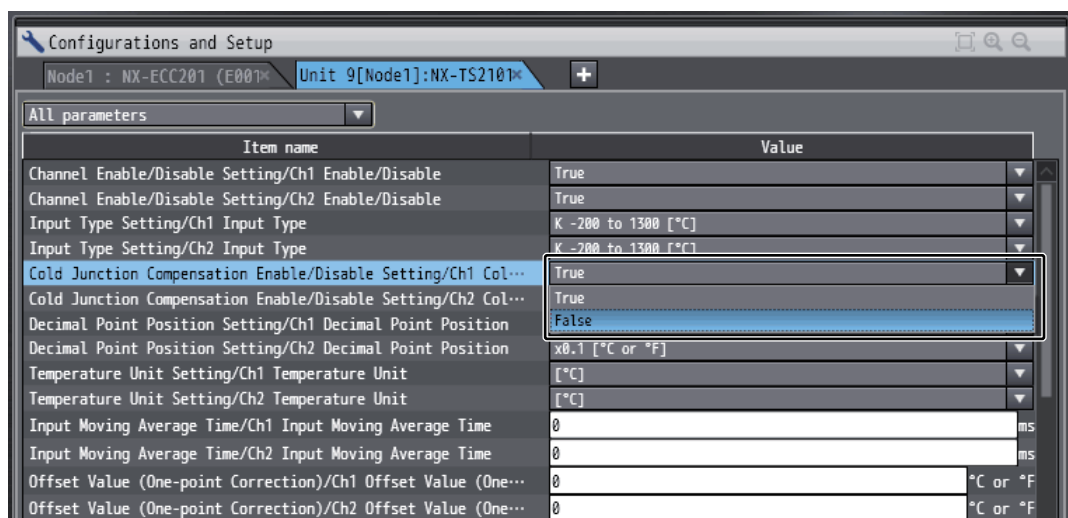



Additional Information

- Click a list button on the tab page to display the item in the Edit Unit Operation Settings Tab Page.

Example:

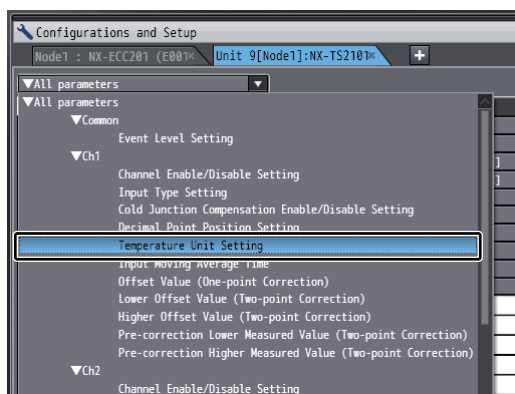

Select Temperature Unit Setting under Ch1

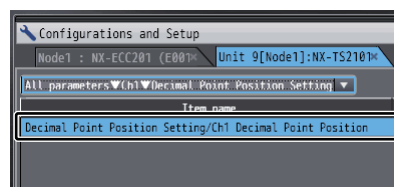

Only Temperature Unit Setting under Ch1 is displayed

- If you set a value different from the default value, the Value on the Sysmac Studio is displayed in a different color.
- You can click the **Return to Default Value** Button to return all set values on the Sysmac Studio to the default values.
- Help for the settings is displayed at the bottom of the Edit Unit Operation Settings Tab Page.

3 Click the **Transfer to Unit** Button.

The settings are transferred from the Sysmac Studio to the NX Unit.

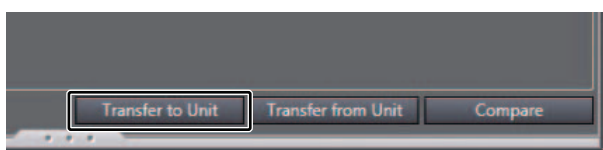

The settings are reflected after the Unit is restarted.



Precautions for Safe Use

The Unit is required to restart after the transfer of Unit operation settings on the Sysmac Studio is completed. Always sufficiently check the safety at the connected devices before you transfer the Unit operation settings.

8-5-8 Temperature Unit (°C/°F) Setting

Purpose

This function sets °C (celsius) or °F (fahrenheit) as the temperature unit for measured values.

Details on the Function

Measured values are treated as °C of REAL data inside the Temperature Input Unit. Therefore, if °F is set, measured values are converted with the following equation.

$$\text{Measured value (°F)} = \text{Measured value (°C)} \times 1.8 + 32$$

● Two-point Input Units

Setting name	Description	Default value	Setting range	Unit
Ch1 Temperature Unit	Set the temperature unit for the channel analog input measured value. 0: °C 1: °F	0	0/1	–
Ch2 Temperature Unit		0	0/1	–

● Four-point Input Units

Setting name	Description	Default value	Setting range	Unit
Ch1 Temperature Unit	Set the temperature unit for the channel analog input measured value. 0: °C 1: °F	0	0/1	–
Ch2 Temperature Unit		0	0/1	–
Ch3 Temperature Unit		0	0/1	–
Ch4 Temperature Unit		0	0/1	–

Target NX Units

All Temperature Input Units

Setting Method

- Use the Sysmac Studio

- 1 Use any of the following methods to display the Edit Unit Operation Settings Tab Page on the Edit Slave Terminal Configuration Tab Page.

Double-click the NX Unit.

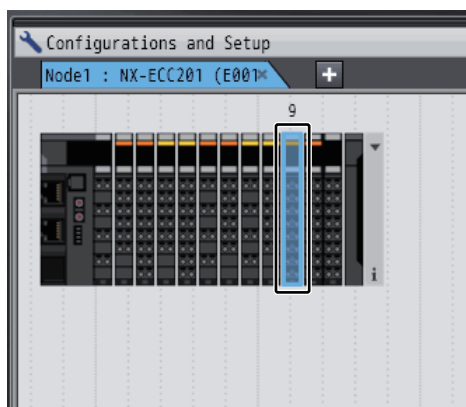

Right-click the NX Unit, then select *Edit Unit Operation Settings* from the menu.

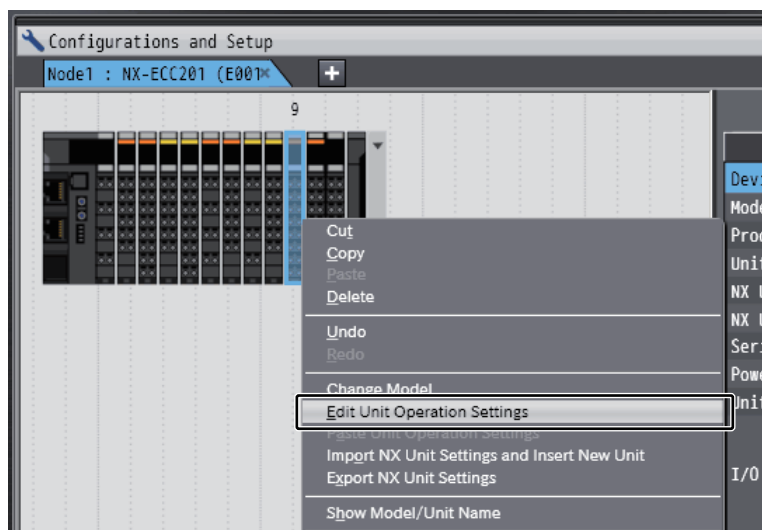

Select the NX Unit, then click the **Edit Unit Operation Settings** Button.

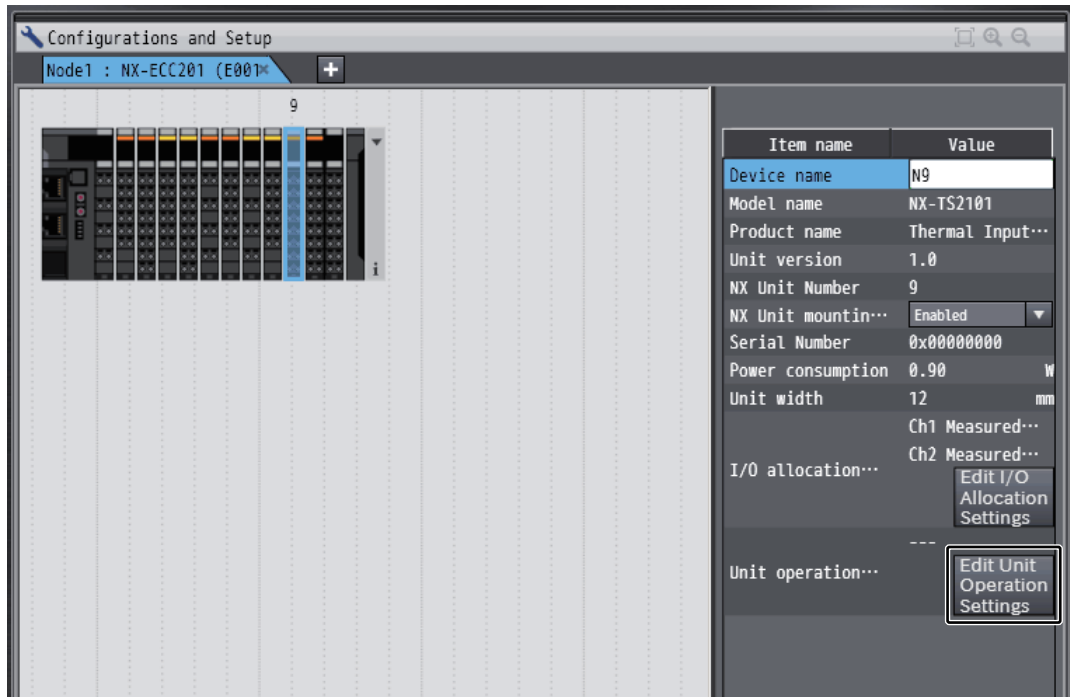

The Edit Unit Operation Settings Tab Page is displayed.

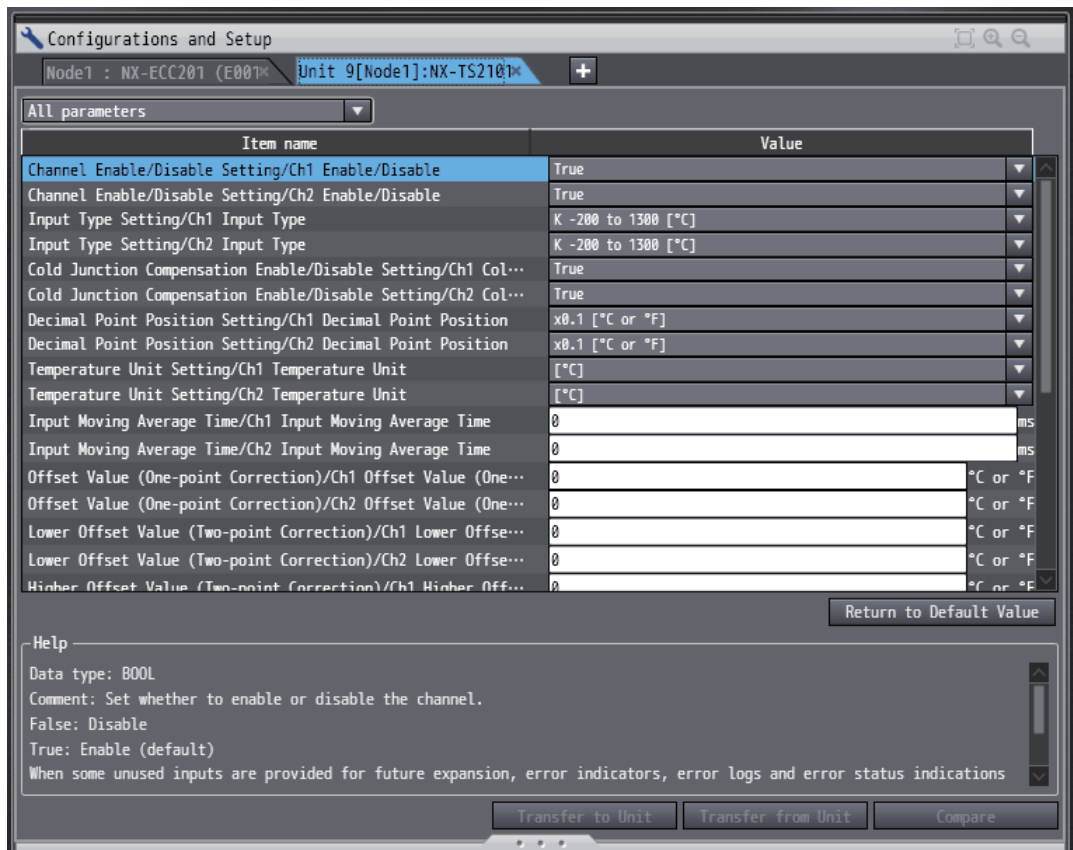

- 2 Select [$^{\circ}\text{C}$] or [$^{\circ}\text{F}$] from the list of Temperature Unit Setting for which the channel you want to set.

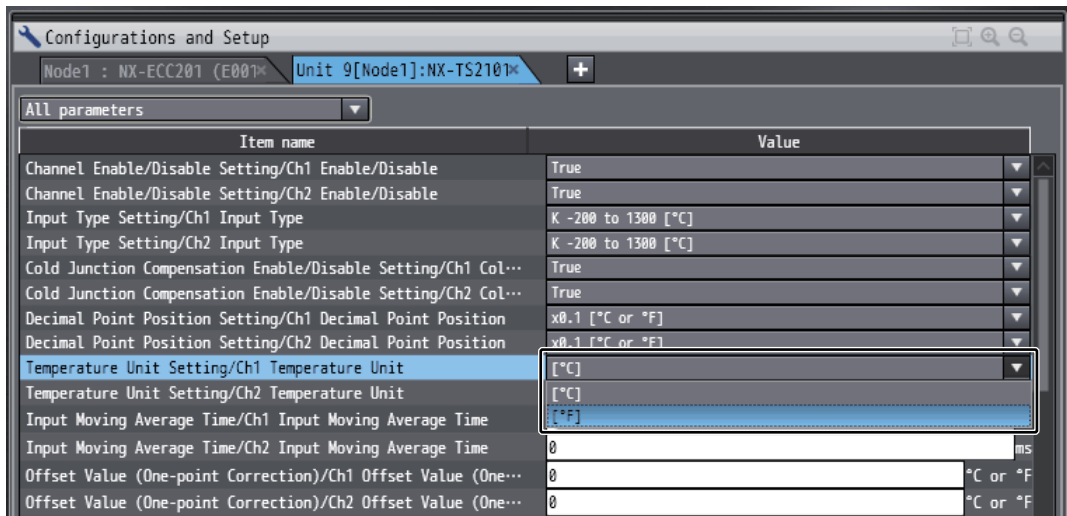

Additional Information

- Click a list button on the tab page to display the item in the Edit Unit Operation Settings Tab Page.

Example:

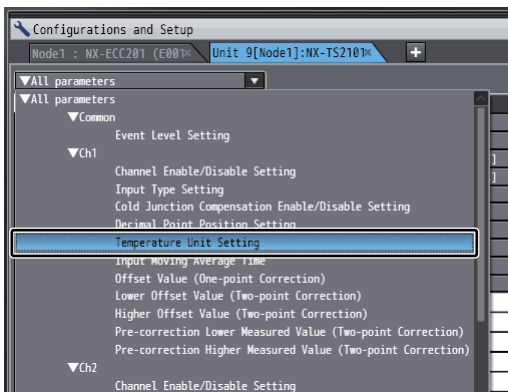

Select Temperature Unit Setting under Ch1

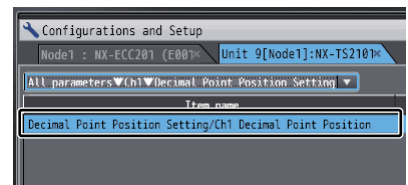

Only Temperature Unit Setting under Ch1 is displayed

- If you set a value different from the default value, the Value on the Sysmac Studio is displayed in a different color.
- You can click the **Return to Default Value** Button to return all set values on the Sysmac Studio to the default values.
- Help for the settings is displayed at the bottom of the Edit Unit Operation Settings Tab Page.

3 Click the **Transfer to Unit** Button.

The settings are transferred from the Sysmac Studio to the NX Unit.

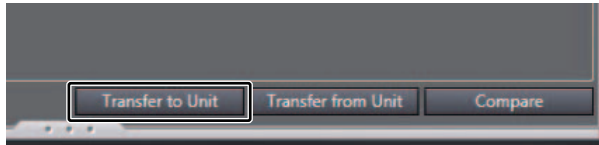

The settings are reflected after the Unit is restarted.

**Precautions for Safe Use**

The Unit is required to restart after the transfer of Unit operation settings on the Sysmac Studio is completed. Always sufficiently check the safety at the connected devices before you transfer the Unit operation settings.

8-5-9 Input Correction

Purpose

This function corrects measured values.

It is used when there is a noticeable variation from values measured with other gauges.

Details on the Function

One-point correction and two-point correction methods are provided.

Whether or not measured values are corrected, the convertible temperature range is the same.

● One-point Correction

For all points in the sensor's measurable range, the offset value of measured values is shifted.

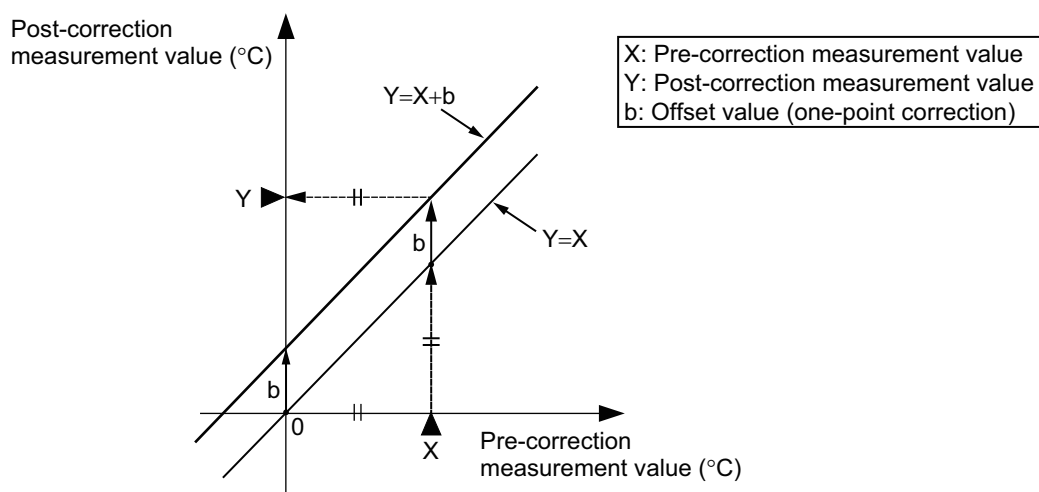

For example, if you want to increase the measured value by 1.2°C, set 1.2 for b (offset value (one-point correction)). This increases the measured values at all points by 1.2°C.

Set offset values using the Sysmac Studio.

Refer to *Setting Method* on page 8-47 for details.

● Two-point Correction

Perform linear correction by setting the correction value at X_L within the measurement range (pre-correction lower measured value (two-point correction)) in b_L (lower offset value (two-point correction)) and the correction value at X_H (pre-correction higher measured value (two-point correction)) in b_H (higher offset value (two-point correction)).

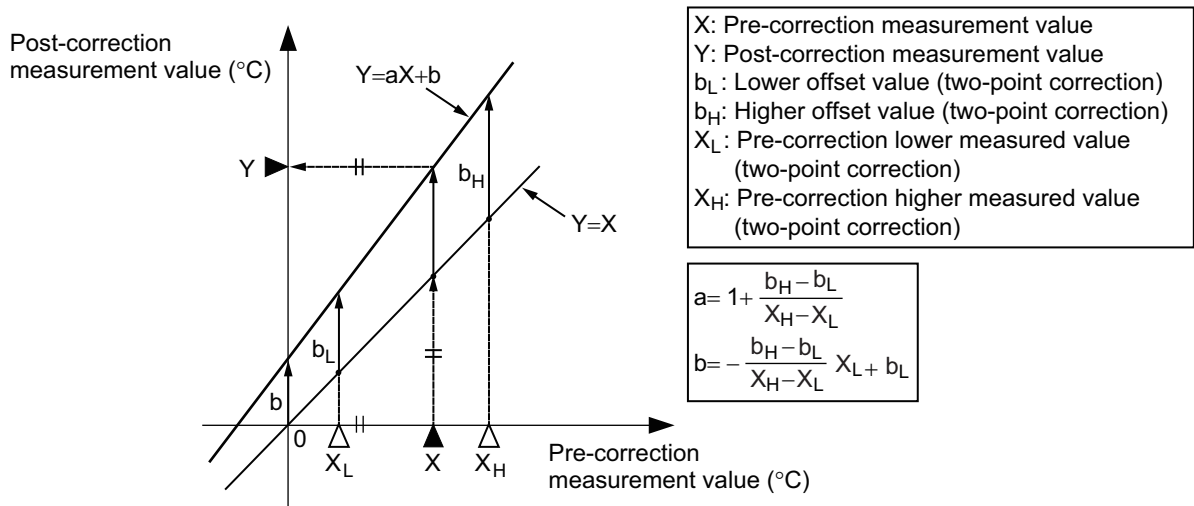

Additional Information

To perform the two-point correction, set the value so that the difference between the values X_H and X_L is larger than 0.1 (°C or °F).

When you do not perform the two-point correction, set the values for both X_H and X_L to 0 or use the same value.

● Example of Two-point Correction

The method for performing two-point correction of Temperature Input Units using a calibration device is shown below.



Precautions for Correct Use

Regardless of the cold junction compensation enable/disable setting, do not remove the cold junction sensors that are mounted on the terminal blocks when they are delivered.

- 1 Use the Sysmac Studio to set the following contents for the Temperature Input Unit, then turn OFF the power supply.

- Ch□ Cold Junction Compensation Enable/Disable: Disable
- Ch□ Offset Value (One-point Correction): 0.0 (°C)
- Ch□ Lower Offset Value (Two-point Correction): 0.0 (°C)
- Ch□ Higher Offset Value (Two-point Correction): 0.0 (°C)
- Ch□ Input Type: Sensor used

Refer to *Setting Method* on page 8-47 for details on how to set offset values.

- 2** Connect the calibration devices below to the Temperature Input Unit.

Model	Calibration device
NX-TS□1□□	Voltage generator
NX-TS□2□□	Variable resistor

- 3** Turn ON the power supply to the Temperature Input Unit, then wait the following warm-up period.

Model	Warm-up period (minutes)
NX-TS□1□□	30
NX-TS□2□□	5

- 4** Enter the signal ^{*1} corresponding to the lower limit of the measurement temperature from the calibration device and check the Ch□ Measured Value.

- 5** Enter the signal ^{*1} corresponding to the upper limit of the measurement temperature from the calibration device and check the Ch□ Measured Value.

- 6** Use Sysmac Studio to set the following contents for the Temperature Input Unit.

- Use the Ch□ Measured Value checked in Procedure 4.
 - Ch□ Pre-correction Lower Measured Value (Two-point Correction): lower limit of the measurement temperature
 - Ch□ Lower Offset Value (Two-point Correction): lower limit of the measurement temperature - Ch□ Measured Value
- Use the Ch□ Measured Value checked in Procedure 5.
 - Ch□ Pre-correction Higher Measured Value (Two-point Correction): upper limit of the measurement temperature
 - Ch□ Higher Offset Value (Two-point Correction): upper limit of the measurement temperature - Ch□ Measured Value

Refer to *Setting Method* on page 8-47 for details on how to set pre-correction measurement values and offset values.

- 7** Use the Sysmac Studio to set the following contents for the Temperature Input Unit, then turn OFF the power supply.

- Ch□ Cold Junction Compensation Enable/Disable: Enable

However, this operation does not need when the cold junction compensation is disabled.

- 8** Disconnect the calibration device from the Temperature Input Unit and connect the temperature sensor.

*1. The values of reference thermal electromotive force listed in JIS C1602-1995.

Target NX Units

All Temperature Input Units

Setting Method

This section describes how to set offset values and pre-correction measurement values.

- **Use the Sysmac Studio**

- 1** Use any of the following methods to display the Edit Unit Operation Settings Tab Page on the Edit Slave Terminal Configuration Tab Page.

Double-click the NX Unit.

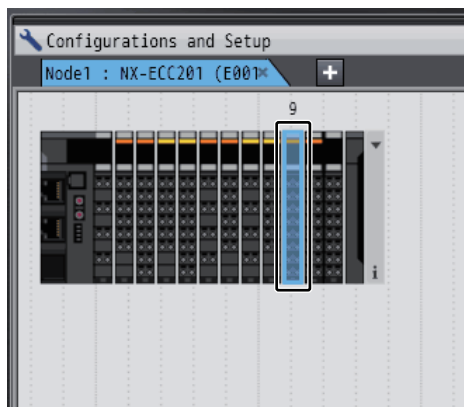

Right-click the NX Unit, then select *Edit Unit Operation Settings* from the menu.

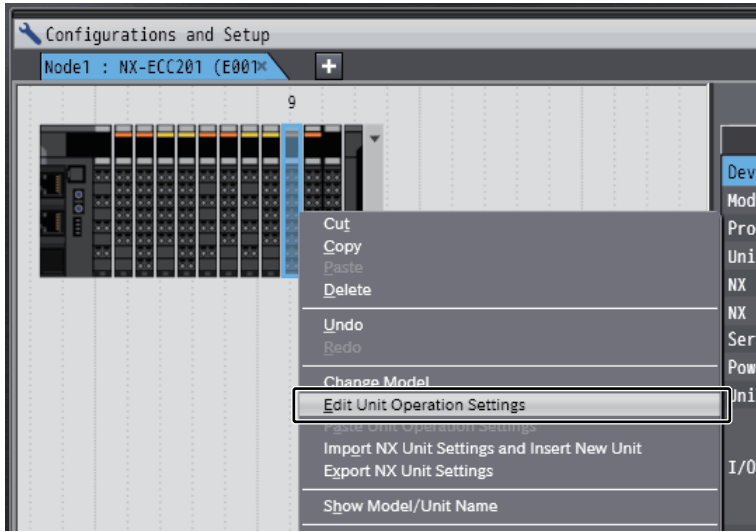

Select the NX Unit, then click the **Edit Unit Operation Settings** Button.

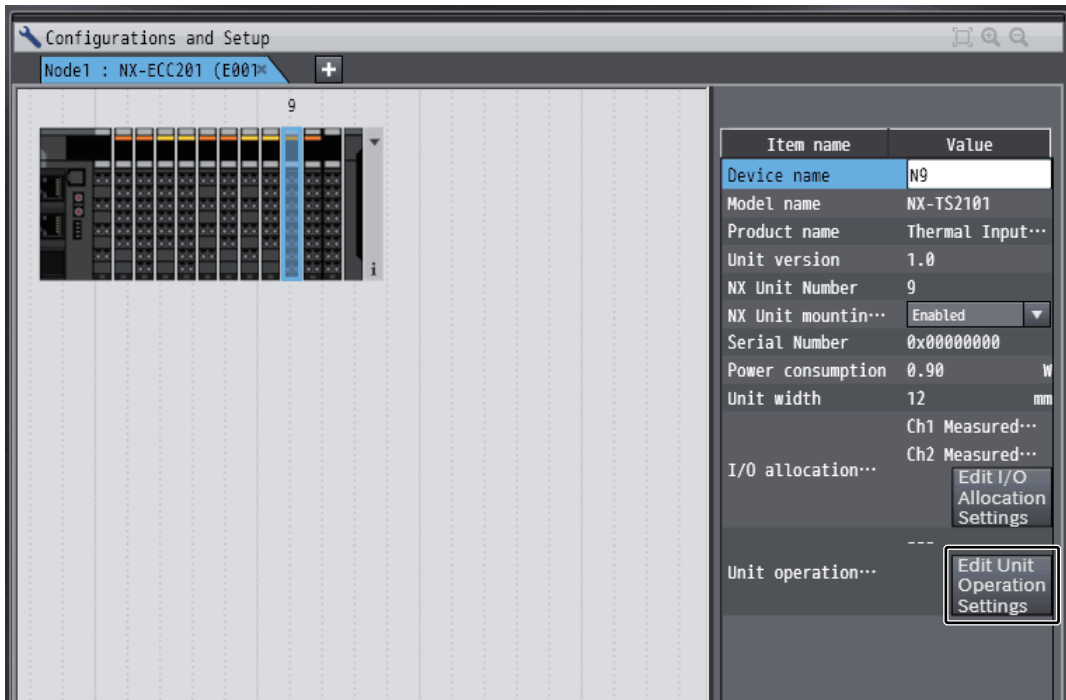

The Edit Unit Operation Settings Tab Page is displayed.

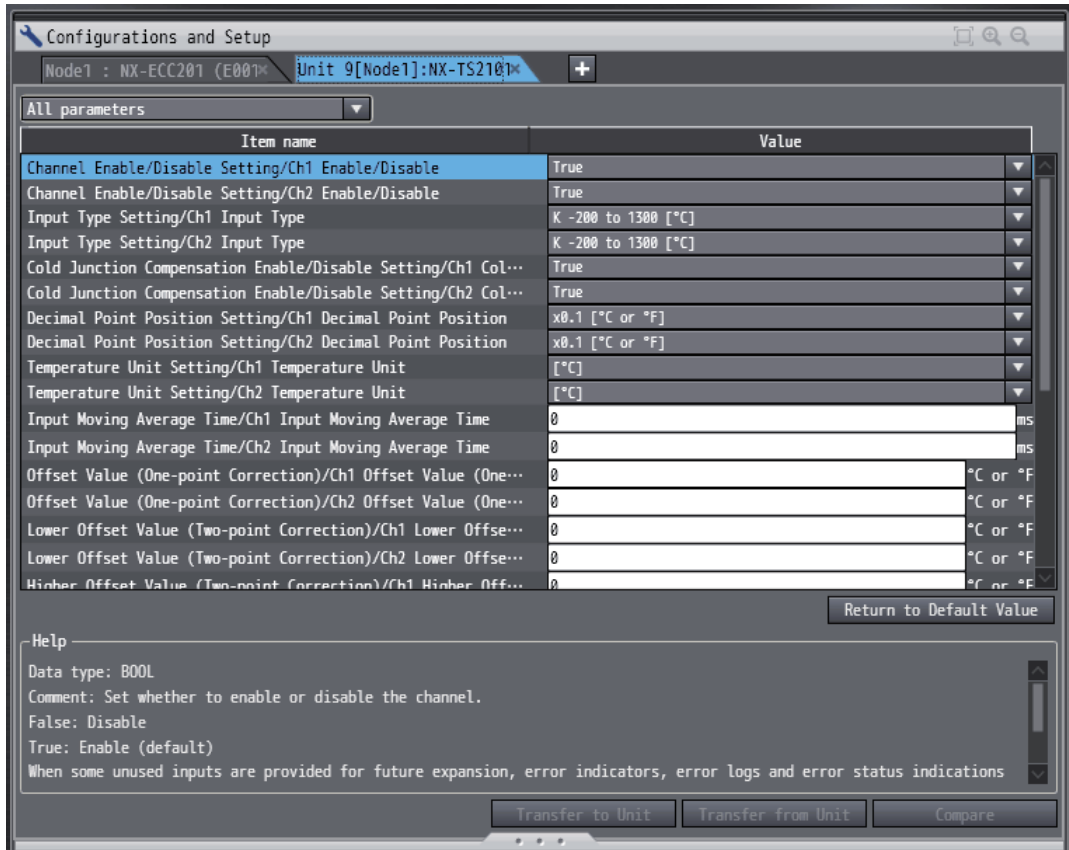

- Enter each set value in the text box of the offset value and pre-correction measurement value you want to set.

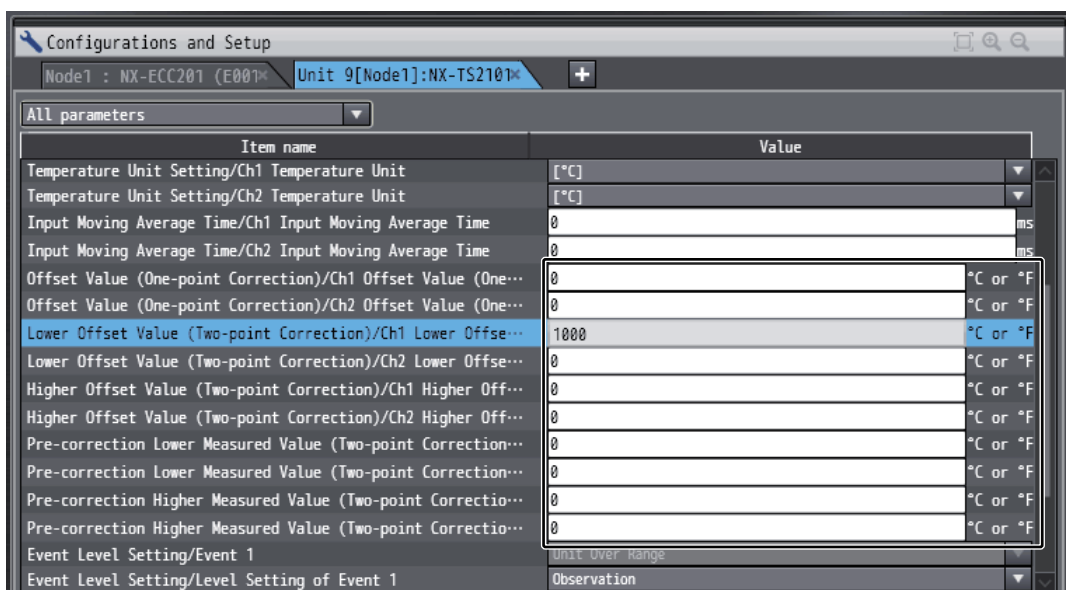



Additional Information

- Click a list button on the tab page to display the item in the Edit Unit Operation Settings Tab Page.

Example:

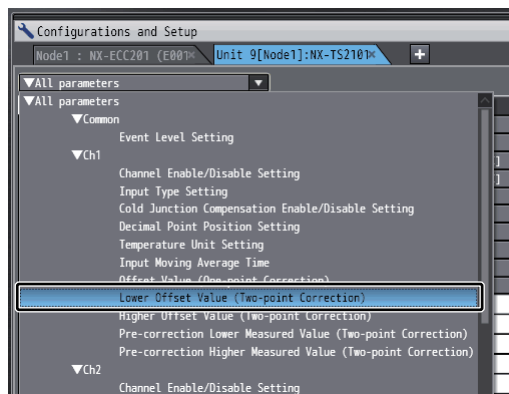

Select Lower Offset Value (Two-point Correction) under Ch1

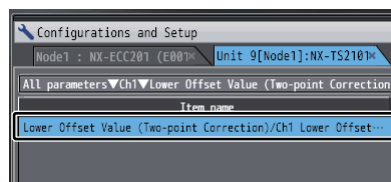

Only Lower Offset Value (Two-point Correction) under Ch1 is displayed

- If you set a value different from the default value, the Value on the Sysmac Studio is displayed in a different color.
- You can click the **Return to Default Value** Button to return all set values on the Sysmac Studio to the default values.
- Help for the settings is displayed at the bottom of the Edit Unit Operation Settings Tab Page.

3 Click the **Transfer to Unit** Button.

The settings are transferred from the Sysmac Studio to the NX Unit.

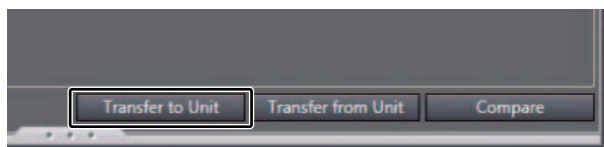

Additional Information

It is not necessary to restart an NX Unit after changing the parameters.

8-5-10 Decimal Point Position Setting

Purpose

This function sets the number of digits which is displayed after the decimal point when measured values are INT and DINT data.

Inside the Temperature Input Unit, there are the measured values with a resolution smaller than the first decimal place, which is the decimal point position for the default values.

It is effective to use INT data type for measured values in order to reduce the I/O size when the measurement range is narrow.

For example, if the decimal point position is set to 2, the measured value is displayed until the second decimal place. At this time, if the measurement temperature is within the range from -320.00 to +320.00°C, the INT data with the small size can be used for the measured value.

Details on the Function

The data types of measured values that the Temperature Input Unit can use are as follows.

After measured values are calculated inside the Temperature Input Unit with REAL data, they are converted to INT and DINT data.

I/O port	Data type	Normal range	Conversion method
Ch□ Measured Value INT	INT	-32000 to 32000	Convert (Ch□ Measured Value REAL x 10^{\wedge} decimal point position) to INT data
Ch□ Measured Value DINT	DINT	Convertible temperature range x 10^{\wedge} decimal point position	Convert (Ch□ Measured Value REAL x 10^{\wedge} decimal point position) to DINT data
Ch□ Measured Value REAL	REAL	Convertible temperature range	Do not convert since it is matched with data inside the Temperature Input Unit.



Additional Information

- When you use a model that the specification of resolution is 0.1°C or less, the value of the second decimal place of the measured value exceeds the specified resolution of the relevant model, so use this value as reference data.
- Digit data lost in conversion is rounded off.
(Example) REAL data type of 1.454°C
 - INT data for decimal point position 0 = 1
 - INT data for decimal point position 1 = 15
 - INT data for decimal point position 2 = 145
 The same processing is performed for both DINT and INT data.
- If the conversion result exceeds the normal range, the measured value is the upper limit or lower limit of the normal range.
(Example) Temperature = 1000°C, decimal point position = 2
 - Ch□ Measured Value INT = $1000 \times 10^2 = 100000$ -> The value is 32000 because it exceeds the range.
 - Ch□ Measured Value DINT = $1000 \times 10^2 = 100000$
 - Ch□ Measured Value REAL = 1000.0

● Two-point Input Units

Setting name	Description	Default value	Unit
Ch1 Decimal Point Position	Set the decimal point position for the channel analog input measured value (INT and DINT). 0: ×1 °C or °F 1: ×0.1 °C or °F 2: ×0.01 °C or °F	1	–
Ch1 Decimal Point Position		1	–

● Four-point Input Units

Setting name	Description	Default value	Unit
Ch1 Decimal Point Position	Set the decimal point position for the channel analog input measured value (INT and DINT). 0: ×1 °C or °F 1: ×0.1 °C or °F 2: ×0.01 °C or °F	1	–
Ch2 Decimal Point Position		1	–
Ch3 Decimal Point Position		1	–
Ch4 Decimal Point Position		1	–

Target NX Units

All Temperature Input Units

Setting Method

- Use the Sysmac Studio

- 1 Use any of the following methods to display the Edit Unit Operation Settings Tab Page on the Edit Slave Terminal Configuration Tab Page.

Double-click the NX Unit.

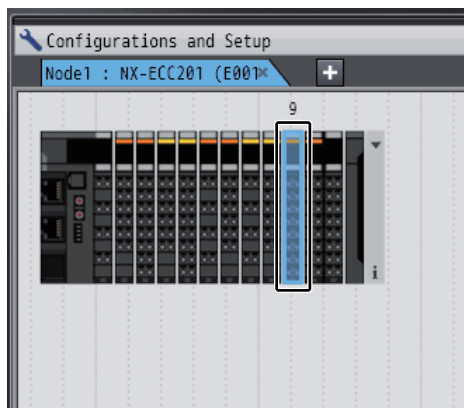

Right-click the NX Unit, then select *Edit Unit Operation Settings* from the menu.

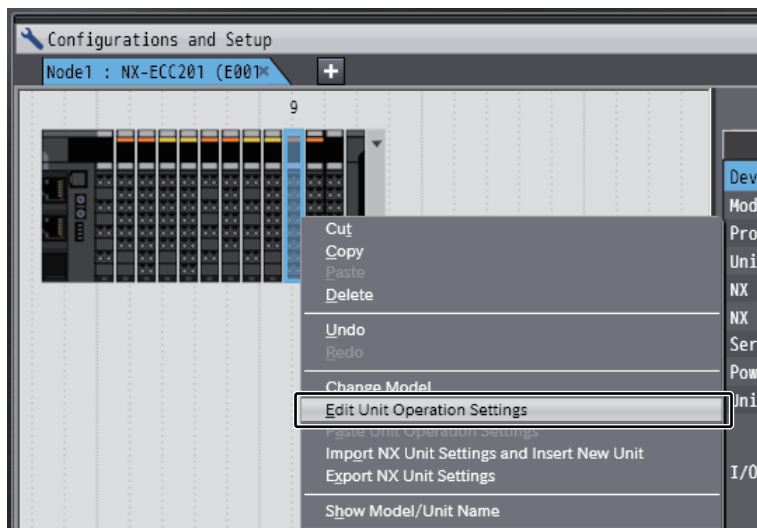

Select the NX Unit, then click the **Edit Unit Operation Settings** Button.

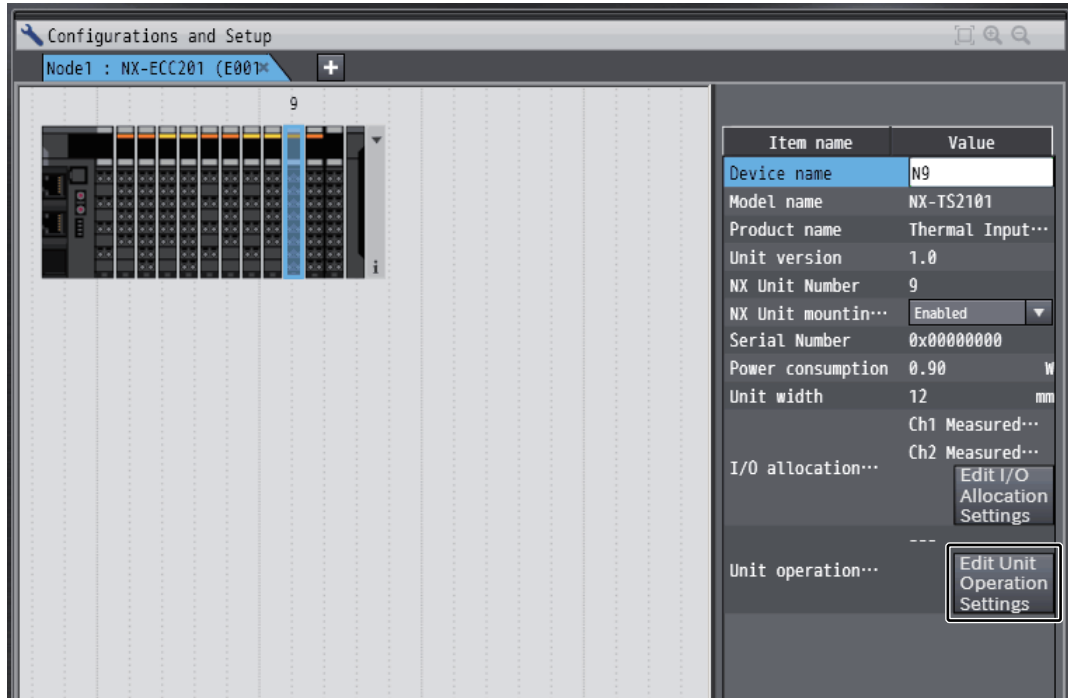

The Edit Unit Operation Settings Tab Page is displayed.

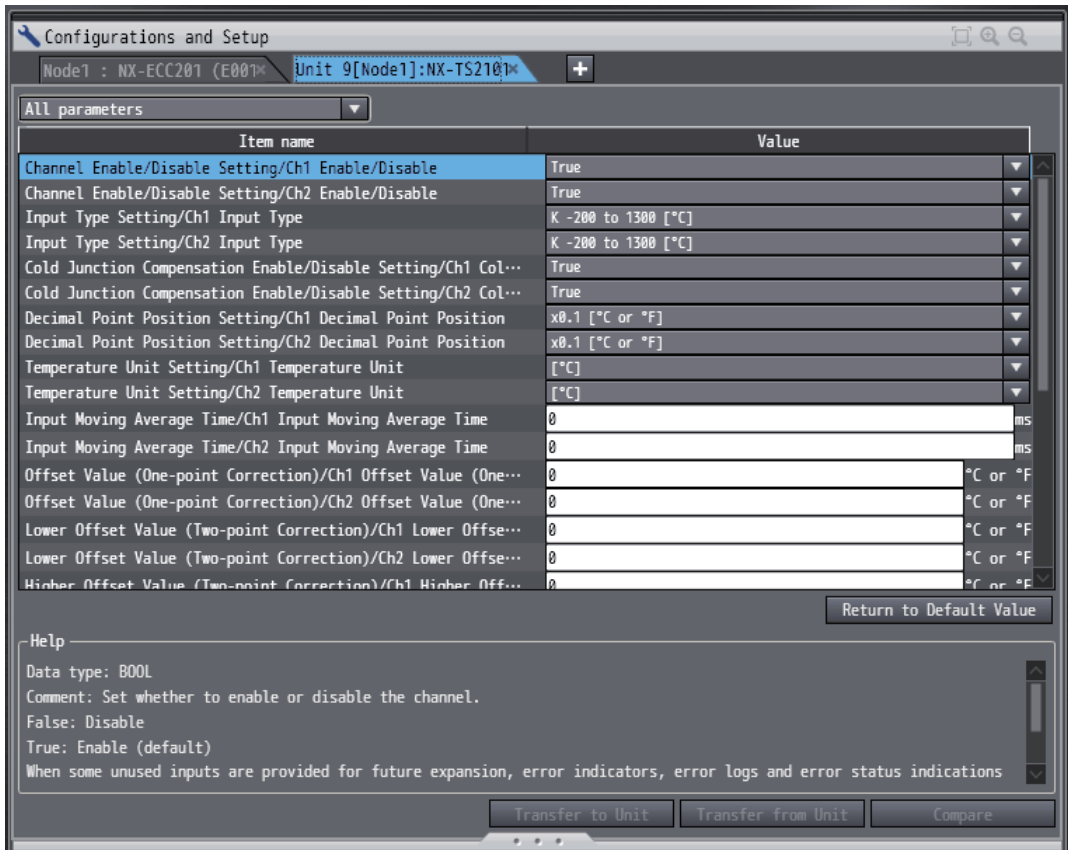

- 2 Select the decimal point position from the list of Decimal Point Position Setting for which the channel you want to set.

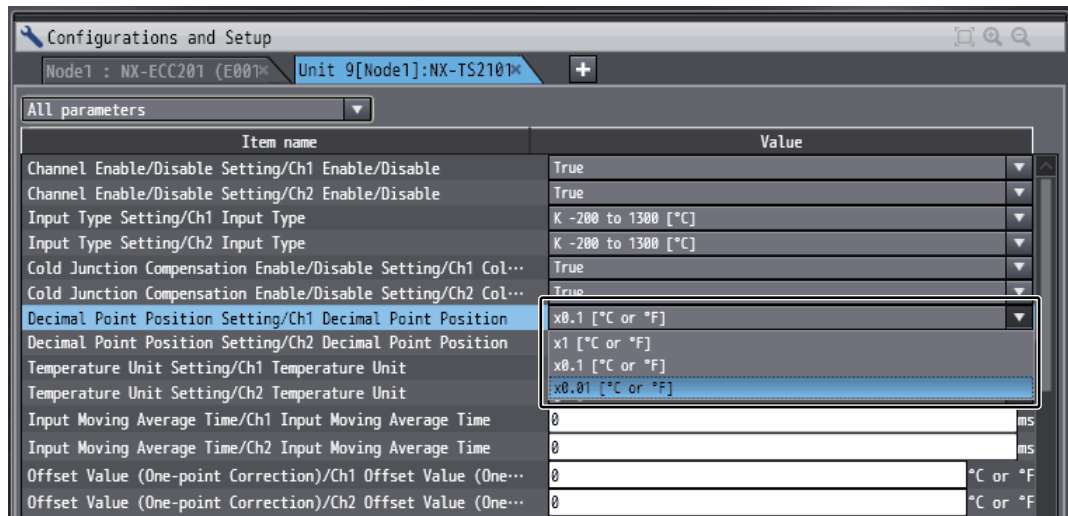

Additional Information

- Click a list button on the tab page to display the item in the Edit Unit Operation Settings Tab Page.

Example:

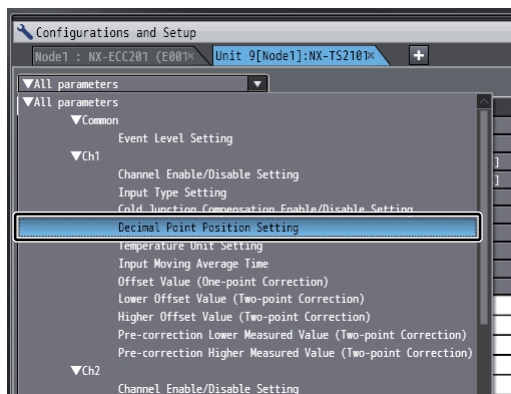

Select Decimal Point Position Setting under Ch1

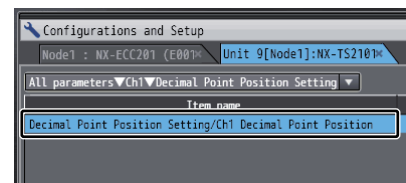

Only Decimal Point Position Setting under Ch1 is displayed

- If you set a value different from the default value, the Value on the Sysmac Studio is displayed in a different color.
- You can click the **Return to Default Value** Button to return all set values on the Sysmac Studio to the default values.
- Help for the settings is displayed at the bottom of the Edit Unit Operation Settings Tab Page.

3 Click the **Transfer to Unit** Button.

The settings are transferred from the Sysmac Studio to the NX Unit.

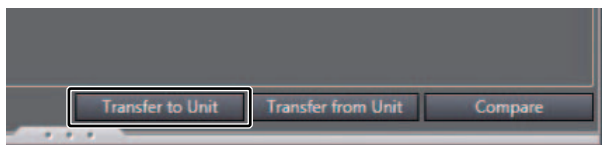

The settings are reflected after the Unit is restarted.



Precautions for Safe Use

The Unit is required to restart after the transfer of Unit operation settings on the Sysmac Studio is completed. Always sufficiently check the safety at the connected devices before you transfer the Unit operation settings.

8-6 Measured Values Used When an Error Occurs

If an error is detected in measured value math operation, the measured value for that point becomes as in the table below and you can see from this measured value that an error has occurred.

This feature allows, the allocation error status to be omitted in order to reduce the size of I/O data.

However, the details for the error cannot be specified because the same measured value is used for more than one error.

The measured values differ depending on the data type as following, and they are always the fixed values without being affected by the decimal point position.

I/O port	Data type	Measured values used when an error occurs
Ch□ Measured Value INT	INT	32767
Ch□ Measured Value DINT	DINT	2147483647
Ch□ Measured Value REAL	REAL	1.0E + 10 *1

*1. If the error is detected by REAL data, be sure that the measured value is greater than 0.9E + 10.

9

Troubleshooting

This section describes the error information and corrections for errors that can occur when the Analog I/O Units are used.

9-1	How to Check for Errors	9-2
9-2	Checking for Errors with the Indicators	9-3
9-3	Checking for Errors and Troubleshooting on the Sysmac Studio	9-6
9-3-1	Checking for Errors from the Sysmac Studio	9-6
9-3-2	Event Codes and Corrections for Errors	9-9
9-3-3	Meaning of Error	9-16
9-3-4	Error Descriptions of Analog Input Units and Analog Output Units	9-17
9-3-5	Error Descriptions of Temperature Input Units	9-37
9-4	Resetting Errors	9-47
9-5	Troubles Specific To Each Type of NX Units	9-48
9-5-1	Analog I/O Units (Common)	9-48
9-5-2	Analog Input Units	9-48
9-5-3	Analog Output Units	9-49
9-5-4	Temperature Input Units	9-49
9-6	Troubleshooting Flowchart	9-50

9-1 How to Check for Errors

You can check the status of errors on the Slave Terminal with the following methods.

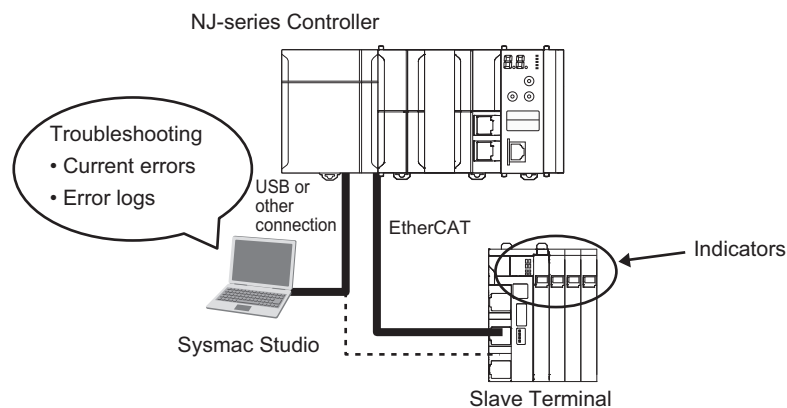

Checking method	What you can check
Checking the indicators	Status of Units and degree of error
Troubleshooting with Sysmac Studio	You can check for current Controller errors, a log of past Controller errors, error sources, error causes, and corrections.

Note With an NS-series PT, you can check on an error occurring in an EtherCAT Coupler Unit and some of the NX Units, and check which NX Unit the error occurred on.

If you use an NJ-series Controller, refer to the *NJ-series Troubleshooting Manual* (Cat. No. W503) for information on how to check for errors in the entire Controller.

9-2 Checking for Errors with the Indicators

You can use the TS indicators on the NX Units to check the NX Unit status and level of errors.

This section describes the meanings of errors that the TS indicator shows and the troubleshooting procedures for them.

In this section, the status of the indicator is indicated with the following abbreviations.

Abbreviation	Indicator status
Lit	Lit
Not Lit	Not lit
FS ()	Flashing. The numeric value in parentheses is the flashing interval.
–	Undefined

Main Errors and Corrections

● Analog Input Units and Analog Output Units

TS indicator		Cause	Correction
Green	Red		
Lit	Not Lit	–	– (This is the normal status.)
FS (2 s)	Not Lit	<ul style="list-style-type: none"> Initializing Downloading 	– (Normal. Wait until the processing is completed.)
Lit	Lit	This status is not present.	
Not Lit	Not Lit	<p>The Unit power supply is not supplied.</p> <ul style="list-style-type: none"> Waiting for initialization to start Restarting <p>If you cannot resolve the problem after you check the above items and cycle the Slave Terminal power supply, the Unit may have a hardware failure. If this happens, replace the Unit.</p>	<p>Check the following items and supply the Unit power supply correctly.</p> <p>[Check items for power supply]</p> <ul style="list-style-type: none"> Make sure that the power supply cable is wired correctly. Make sure that the power supply cable is not disconnected. Make sure that power supply voltage is within the specified range. Make sure that the power supply has enough capacity. Make sure that power supply has not failed. <p>– (Normal. Wait until the processing is completed.)</p>
Not Lit	Lit	Hardware failure	If this error occurs after you cycle the Slave Terminal power supply, replace the Unit.
Not Lit	Lit	Non-volatile Memory Hardware Error	Refer to Event <i>Non-volatile Memory Hardware Error</i> on page 9-17.
Not Lit	Lit	Analog Unit Calibration Parameter Error	Refer to Event <i>Analog Unit Calibration Parameter Error</i> on page 9-18.

TS indicator		Cause	Correction
Green	Red		
Not Lit	Lit	Control Parameter Error in Master	Refer to Event <i>Control Parameter Error in Master</i> on page 9-19.
Not Lit	Lit	Unit Calibration Value Parity Error	Refer to Event <i>Unit Calibration Value Parity Error</i> on page 9-20.
Not Lit	Lit	NX Unit Clock Not Synchronized Error	Refer to Event <i>NX Unit Clock Not Synchronized Error</i> on page 9-27.
Not Lit	FS (1 s)	NX Unit I/O Communications Error	Refer to Event <i>NX Unit I/O Communications Error</i> on page 9-25.
Not Lit	FS (1 s)	NX Unit Output Synchronization Error	Refer to Event <i>NX Unit Output Synchronization Error</i> on page 9-26.
The indicator status is held immediately before the event occurred.		Unit I/O Disconnection Detected for Channel <input type="checkbox"/>	Refer to Event <i>Unit I/O Disconnection Detected for Channel 1</i> on page 9-20.
		Unit Over Range for Channel <input type="checkbox"/>	Refer to Event <i>Unit Over Range for Channel 1</i> on page 9-28.
		Unit Under Range for Channel <input type="checkbox"/>	Refer to Event <i>Unit Under Range for Channel 1</i> on page 9-32.

● Temperature Input Units

TS indicator		Cause	Correction
Green	Red		
Lit	Not Lit	–	– (This is the normal status.)
FS (2 s)	Not Lit	<ul style="list-style-type: none"> • Initializing • Downloading 	– (Normal. Wait until the processing is completed.)
Lit	Lit	This status is not present.	
Not Lit	Not Lit	The Unit power supply is not supplied.	<p>Check the following items and supply the Unit power supply correctly.</p> <p>[Check items for power supply]</p> <ul style="list-style-type: none"> • Make sure that the power supply cable is wired correctly. • Make sure that the power supply cable is not disconnected. • Make sure that power supply voltage is within the specified range. • Make sure that the power supply has enough capacity. • Make sure that power supply has not failed.
		<ul style="list-style-type: none"> • Waiting for initialization start • Restarting 	– (Normal. Wait until the processing is completed.)
		If the above checks and a restart of the Slave Terminal power supply do not solve the problem, Unit hardware is broken. In this case, replace the Unit.	
Not Lit	Lit	Hardware failure	If this error occurs after you turn Slave Terminal power supply ON again, replace the Unit.
Not Lit	Lit	Non-volatile Memory Hardware Error	Refer to Event <i>Non-volatile Memory Hardware Error</i> on page 9-37.
Not Lit	Lit	Control Parameter Error in Master	Refer to Event <i>Control Parameter Error in Master</i> on page 9-40.
Not Lit	Lit	A/D Converter Error	Refer to Event <i>A/D Converter Error</i> on page 9-38.
Not Lit	Lit	NX Unit Clock Not Synchronized Error	Refer to Event <i>NX Unit Clock Not Synchronized Error</i> on page 9-27.

TS indicator		Cause	Correction
Green	Red		
Not Lit	FS (1 s)	NX Unit I/O Communications Error	Refer to Event <i>NX Unit I/O Communications Error</i> on page 9-42.
The indicator status is held immediately before the event occurred.		Cold Junction Sensor Error	Refer to Event <i>Cold Junction Sensor Error</i> on page 9-39.
		Sensor Disconnected Error	Refer to Event <i>Sensor Disconnected Error</i> on page 9-41.
		Process Value Over Range	Refer to Event <i>Process Value Over Range</i> on page 9-44.
		Process Value Under Range	Refer to Event <i>Process Value Under Range</i> on page 9-45.
		NX Message Communications Error	Refer to Event <i>NX Message Communications Error</i> on page 9-46.

9-3 Checking for Errors and Troubleshooting on the Sysmac Studio

Error management on the NX Series is based on the methods used for the NJ-series Controllers.

This allows you to use the Sysmac Studio to check the meanings of errors and troubleshooting procedures.

9-3-1 Checking for Errors from the Sysmac Studio

When an error occurs, you can place the Sysmac Studio online to the Controller or the Communications Coupler Unit to check current Controller errors and the log of past Controller errors.

The methods that are used to check errors depend on the Controller you use.

Controller used	Sysmac Studio connection	Scope of check	Remarks
NJ-series Controller	NJ-series CPU Unit	You can check the errors that are managed by the Controller. This includes errors for the connected EtherCAT Slave Terminals.	You cannot check errors if there is a fatal error in the CPU Unit.
	EtherCAT Coupler Unit	You can check the errors that are managed by the EtherCAT Coupler Unit. You can check errors in the EtherCAT Coupler Unit to which the Sysmac Studio is connected, and errors in the NX Units that are connected after the EtherCAT Coupler Unit.	<ul style="list-style-type: none"> You can check errors in the Slave Terminals even if there is a fatal error in the CPU Unit. You cannot check errors if there is a fatal error in the EtherCAT Coupler Unit. Some errors in the NX Units cannot be checked if a fatal error occurs in that NX Unit.*1
Other controllers	EtherCAT Coupler Unit	Same as above.	Same as above.

*1. On NX Units that manage their own errors, current NX errors cannot be checked after a fatal error occurs in that NX Unit. On NX Units that record their own event logs, the error log cannot be checked after a fatal error occurs in that NX Unit.

Refer to the *NJ-series Troubleshooting Manual* (Cat. No. W503) for information on NJ-series error management methods.

Refer to the *NJ-Series Sysmac Studio Version 1 Operation Manual* (Cat. No. W504) for details on troubleshooting with the Sysmac Studio.

If you cannot check the error on the Sysmac Studio, check the error by following the flow outlined in *9-6 Troubleshooting Flowchart* on page 9-50.



Additional Information

Checking Errors in an EtherCAT Slave Terminal with an NS-series PT

You can use an NS-series PT to view current errors on the EtherCAT Coupler Unit errors and some of the NX Units as well as information on the NX Units in which current errors occurred. You cannot use it to check event logs and details on current errors in the NX Units.

Current Errors

Open the Sysmac Studio's Controller Error Tab Page to check the current error's level, source, source details, event name, event codes, details, attached information 1 to 4, and correction. Errors in the observation level are not displayed.



Additional Information

Number of Current Errors

The following table gives the number of errors that are reported simultaneously as current errors in each Unit.

Unit	Number of simultaneous error notifications
EtherCAT Coupler Unit	128 errors
Analog Input Units Analog Output Units	Since current errors are managed in the Communications Coupler Unit, the number of current errors is limited by the number of errors for the Communications Coupler Unit.
Temperature Input Units	15 errors

If the number of errors exceeds the maximum number of reportable current errors, errors are reported with a priority given to the oldest and highest-level errors. Errors that exceed the limit on simultaneous error notifications are not reported.

Errors that are not reported are still reflected in the error status.

Log of Past Errors

Open the Sysmac Studio's Controller Event Log Tab Page to check the times, levels, sources, source details, event names, event codes, details, attached information 1 to 4, and corrections for previous errors.



Additional Information

Number of Logs of Past Errors

Each event log can contain the following number of records. If the number of events exceeds the following number of records, the oldest events are overwritten.

Event logs in the Analog I/O Units are stored in the EtherCAT Coupler Unit.

Event logs in the Temperature Input Units are stored in the Temperature Input Unit itself.

Event log category	Types of Units		
	EtherCAT Coupler Unit	Analog I/O Units	Temperature Input Units
System event log	Total: 128 events		Total: 15 events
Access event log	Total: 32 events		Total: 2 events

Refer to the *NJ-series Troubleshooting Manual* (Cat. No. W503) and the *Sysmac Studio Version 1 Operation Manual* (Cat. No. W504) for the items that you can check and the procedures to check for errors.

Refer to *9-3-2 Event Codes and Corrections for Errors* on page 9-9 for details on event codes.

9-3-2 Event Codes and Corrections for Errors

The errors (i.e., events) that occur in the Analog I/O Unit is shown below.

The following abbreviations are used in the event level column.

Abbreviation	Name
Maj	Major fault level
Prt	Partial fault level
Min	Minor fault level
Obs	Observation
Info	Information

Symbol	Meaning
S	Event levels that are defined by the system.
U	Event levels that can be changed by the user. *1

*1. This symbol appears only for events for which the user can change the event level.

Refer to the *NJ-series Troubleshooting Manual* (Cat. No. W503) for all NJ-series event codes.

Analog Input Units and Analog Output Units

Event code	Event name	Meaning	Assumed cause	Level					Reference
				Maj	Prt	Min	Obs	Info	
00200000 hex	Non-volatile Memory Hardware Error	An error occurred in non-volatile memory.	<ul style="list-style-type: none"> Non-volatile memory failure 			S			P. 9-17
10400000 hex	Analog Unit Calibration Parameter Error	An error occurred for the calibration data in the Analog Unit.	<ul style="list-style-type: none"> The power supply to the Analog Unit was turned OFF or Sysmac Studio communications were disconnected while writing the calibration values to the Analog Unit. 			S			P. 9-18
10410000 hex	Control Parameter Error in Master	An error occurred in the control parameters that are saved in the master.	<ul style="list-style-type: none"> There is an error in the area of the non-volatile memory in the Communications Coupler Unit in which the control parameters for the NX Unit are saved. The power supply to the NX Unit was turned OFF or Sysmac Studio communications were disconnected while writing the control parameters. 			S			P. 9-19
14C00000 hex	Unit Calibration Value Parity Error	An error occurred in the user calibration data in the NX Unit.	<ul style="list-style-type: none"> An error was detected in the calibration data. 			S			P. 9-20
65030000 hex	Unit I/O Disconnection Detected for Channel 1	A disconnected input was detected for channel 1.	<ul style="list-style-type: none"> Input wiring is broken. Input wiring is disconnected. 			S	U		P. 9-20

Event code	Event name	Meaning	Assumed cause	Level					Reference
				Maj	Prt	Min	Obs	Info	
65040000 hex	Unit I/O Disconnection Detected for Channel 2	A disconnected input was detected for channel 2.	<ul style="list-style-type: none"> Input wiring is broken. Input wiring is disconnected. 			S	U		P. 9-21
65050000 hex	Unit I/O Disconnection Detected for Channel 3	A disconnected input was detected for channel 3.	<ul style="list-style-type: none"> Input wiring is broken. Input wiring is disconnected. 			S	U		P. 9-21
65060000 hex	Unit I/O Disconnection Detected for Channel 4	A disconnected input was detected for channel 4.	<ul style="list-style-type: none"> Input wiring is broken. Input wiring is disconnected. 			S	U		P. 9-22
65070000 hex	Unit I/O Disconnection Detected for Channel 5	A disconnected input was detected for channel 5.	<ul style="list-style-type: none"> Input wiring is broken. Input wiring is disconnected. 			S	U		P. 9-22
65080000 hex	Unit I/O Disconnection Detected for Channel 6	A disconnected input was detected for channel 6.	<ul style="list-style-type: none"> Input wiring is broken. Input wiring is disconnected. 			S	U		P. 9-23
65090000 hex	Unit I/O Disconnection Detected for Channel 7	A disconnected input was detected for channel 7.	<ul style="list-style-type: none"> Input wiring is broken. Input wiring is disconnected. 			S	U		P. 9-23
650A0000 hex	Unit I/O Disconnection Detected for Channel 8	A disconnected input was detected for channel 8.	<ul style="list-style-type: none"> Input wiring is broken. Input wiring is disconnected. 			S	U		P. 9-24
80200000 hex	NX Unit I/O Communications Error	An I/O communications error occurred between the Communications Coupler Unit and the NX Unit.	<ul style="list-style-type: none"> The NX Unit is not mounted properly. The power cable for the Unit power supply is disconnected. Or, the wiring from the Unit power supply to the NX Units is incorrect. The power cable for the Unit power supply is broken. The voltage of the Unit power supply is outside the specified range. Or, the capacity of the Unit power supply is insufficient. There is a hardware error in the NX Unit. 			S			P. 9-25
80210000 hex	NX Unit Output Synchronization Error	An output synchronization error occurred in the NX Unit.	<ul style="list-style-type: none"> The NX Unit is not mounted properly. The Slave Terminal Configuration Information when the EtherCAT Coupler Unit synchronization settings were downloaded did not agree with the actual configuration of the Slave Terminal. There is an NX Unit that cannot be synchronized to the specified output synchronization timing. (This will not cause an error when the synchronization setting is made from the Sysmac Studio.) 			S			P. 9-26

Event code	Event name	Meaning	Assumed cause	Level					Reference
				Maj	Prt	Min	Obs	Info	
80240000 hex	NX Unit Clock Not Synchronized Error	An error occurred in the clock information between the EtherCAT Coupler Unit and the NX Unit.	<ul style="list-style-type: none"> There is a hardware error in the NX Unit. There is a hardware error in the EtherCAT Coupler Unit. 			S			P. 9-27
64F00000 hex	Unit Over Range for Channel 1	The analog input data for input channel 1 exceeded the upper limit of the input range. Or, the analog output data for output channel 1 exceeded the upper limit of the output range.	<ul style="list-style-type: none"> The analog input data exceeded the upper limit of the input range. Or, the analog output data exceeded the upper limit of the output range. 			U	S		P. 9-28
64F10000 hex	Unit Over Range for Channel 2	The analog input data for input channel 2 exceeded the upper limit of the input range. Or, the analog output data for output channel 2 exceeded the upper limit of the output range.	<ul style="list-style-type: none"> The analog input data exceeded the upper limit of the input range. Or, the analog output data exceeded the upper limit of the output range. 			U	S		P. 9-28
64F20000 hex	Unit Over Range for Channel 3	The analog input data for input channel 3 exceeded the upper limit of the input range. Or, the analog output data for output channel 3 exceeded the upper limit of the output range.	<ul style="list-style-type: none"> The analog input data exceeded the upper limit of the input range. Or, the analog output data exceeded the upper limit of the output range. 			U	S		P. 9-29
64F30000 hex	Unit Over Range for Channel 4	The analog input data for input channel 4 exceeded the upper limit of the input range. Or, the analog output data for output channel 4 exceeded the upper limit of the output range.	<ul style="list-style-type: none"> The analog input data exceeded the upper limit of the input range. Or, the analog output data exceeded the upper limit of the output range. 			U	S		P. 9-29
64F40000 hex	Unit Over Range for Channel 5	The analog input data for input channel 5 exceeded the upper limit of the input range. Or, the analog output data for output channel 5 exceeded the upper limit of the output range.	<ul style="list-style-type: none"> The analog input data exceeded the upper limit of the input range. Or, the analog output data exceeded the upper limit of the output range. 			U	S		P. 9-30

Event code	Event name	Meaning	Assumed cause	Level					Reference
				Maj	Prt	Min	Obs	Info	
64F50000 hex	Unit Over Range for Channel 6	The analog input data for input channel 6 exceeded the upper limit of the input range. Or, the analog output data for output channel 6 exceeded the upper limit of the output range.	<ul style="list-style-type: none"> The analog input data exceeded the upper limit of the input range. Or, the analog output data exceeded the upper limit of the output range. 			U	S		P. 9-30
64F60000 hex	Unit Over Range for Channel 7	The analog input data for input channel 7 exceeded the upper limit of the input range. Or, the analog output data for output channel 7 exceeded the upper limit of the output range.	<ul style="list-style-type: none"> The analog input data exceeded the upper limit of the input range. Or, the analog output data exceeded the upper limit of the output range. 			U	S		P. 9-31
64F70000 hex	Unit Over Range for Channel 8	The analog input data for input channel 8 exceeded the upper limit of the input range. Or, the analog output data for output channel 8 exceeded the upper limit of the output range.	<ul style="list-style-type: none"> The analog input data exceeded the upper limit of the input range. Or, the analog output data exceeded the upper limit of the output range. 			U	S		P. 9-31
64F80000 hex	Unit Under Range for Channel 1	The analog input data for input channel 1 went below the lower limit of the input range. Or, the analog output data for output channel 1 went below the lower limit of the output range.	<ul style="list-style-type: none"> The analog input data went below the lower limit of the input range. Or, the analog output data went below the lower limit of the output range. 			U	S		P. 9-32
64F90000 hex	Unit Under Range for Channel 2	The analog input data for input channel 2 went below the lower limit of the input range. Or, the analog output data for output channel 2 went below the lower limit of the output range.	<ul style="list-style-type: none"> The analog input data went below the lower limit of the input range. Or, the analog output data went below the lower limit of the output range. 			U	S		P. 9-32
64FA0000 hex	Unit Under Range for Channel 3	The analog input data for input channel 3 went below the lower limit of the input range. Or, the analog output data for output channel 3 went below the lower limit of the output range.	<ul style="list-style-type: none"> The analog input data went below the lower limit of the input range. Or, the analog output data went below the lower limit of the output range. 			U	S		P. 9-33

Event code	Event name	Meaning	Assumed cause	Level					Reference
				Maj	Prt	Min	Obs	Info	
64FB0000 hex	Unit Under Range for Channel 4	The analog input data for input channel 4 went below the lower limit of the input range. Or, the analog output data for output channel 4 went below the lower limit of the output range.	<ul style="list-style-type: none"> The analog input data went below the lower limit of the input range. Or, the analog output data went below the lower limit of the output range. 			U	S		P. 9-33
64FC0000 hex	Unit Under Range for Channel 5	The analog input data for input channel 5 went below the lower limit of the input range. Or, the analog output data for output channel 5 went below the lower limit of the output range.	<ul style="list-style-type: none"> The analog input data went below the lower limit of the input range. Or, the analog output data went below the lower limit of the output range. 			U	S		P. 9-34
64FD0000 hex	Unit Under Range for Channel 6	The analog input data for input channel 6 went below the lower limit of the input range. Or, the analog output data for output channel 6 went below the lower limit of the output range.	<ul style="list-style-type: none"> The analog input data went below the lower limit of the input range. Or, the analog output data went below the lower limit of the output range. 			U	S		P. 9-34
64FE0000 hex	Unit Under Range for Channel 7	The analog input data for input channel 7 went below the lower limit of the input range. Or, the analog output data for output channel 7 went below the lower limit of the output range.	<ul style="list-style-type: none"> The analog input data went below the lower limit of the input range. Or, the analog output data went below the lower limit of the output range. 			U	S		P. 9-35
64FF0000 hex	Unit Under Range for Channel 8	The analog input data for input channel 8 went below the lower limit of the input range. Or, the analog output data for output channel 8 went below the lower limit of the output range.	<ul style="list-style-type: none"> The analog input data went below the lower limit of the input range. Or, the analog output data went below the lower limit of the output range. 			U	S		P. 9-35
90400000 hex	Event Log Cleared	The event log was cleared.	<ul style="list-style-type: none"> The event log was cleared by the user. 					S	P. 9-36

Temperature Input Units

Event code	Event name	Meaning	Assumed cause	Level					Reference
				Maj	Prt	Min	Obs	Info	
00200000 hex	Non-volatile Memory Hardware Error	An error occurred in non-volatile memory.	<ul style="list-style-type: none"> Non-volatile memory failure. 			S			P. 9-37
05100000 hex	A/D Converter Error	An error occurred in the A/D converter	<ul style="list-style-type: none"> Noise A/D converter failure 			S			P. 9-38
05110000 hex	Cold Junction Sensor Error	The temperature cannot be converted because the cold junction sensor is disconnected	<ul style="list-style-type: none"> There is a faulty connection to the cold junction sensor. The cold junction sensor failed. 			S	U		P. 9-39
10410000 hex	Control Parameter Error in Master	An error occurred in the control parameters that are saved in the master.	<ul style="list-style-type: none"> There is an error in the area of the non-volatile memory in the Communications Coupler Unit in which the control parameters for the NX Unit are saved. The power supply to the NX Unit was turned OFF or Sysmac Studio communications were disconnected while writing the control parameters. 			S			P. 9-40
65100000 hex	Sensor Disconnected Error	A disconnected temperature sensor was detected.	<ul style="list-style-type: none"> The temperature sensor is damaged or the wires are broken. An unused channel is not disabled. 			S	U		P. 9-41
80200000 hex	NX Unit I/O Communications Error	An I/O communications error occurred between the Communications Coupler Unit and the NX Unit.	<ul style="list-style-type: none"> The NX Unit is not mounted properly. The power cable for the Unit power supply is disconnected. Or, the wiring from the Unit power supply to the NX Units is incorrect. The power cable for the Unit power supply is broken. The voltage of the Unit power supply is outside the specified range. Or, the capacity of the Unit power supply is insufficient. There is a hardware error in the NX Unit. 			S			P. 9-42
80240000 hex	NX Unit Clock Not Synchronized Error	An error occurred in the clock information between the EtherCAT Coupler Unit and the NX Unit.	<ul style="list-style-type: none"> There is a hardware error in the NX Unit. There is a hardware error in the EtherCAT Coupler Unit. 			S			P. 9-27

Event code	Event name	Meaning	Assumed cause	Level					Reference
				Maj	Prt	Min	Obs	Info	
65110000 hex	Process Value Over Range	The process temperature exceeded the upper limit of temperature conversion range.	<ul style="list-style-type: none"> The sensor is disconnected. The sensor or the compensating cables are not wired correctly. The sensor and the input type setting do not agree. The range of the input type is too narrow for the temperatures that need to be measured. An unused channel is not disabled. 			U	S		P. 9-44
65120000 hex	Process Value Under Range	The process temperature went below the lower limit of temperature conversion range.	<ul style="list-style-type: none"> The sensor or the compensating cables are not wired correctly. The sensor and the input type setting do not agree. The range of the input type is too narrow for the temperatures that need to be measured. 			U	S		P. 9-45
80220000 hex	NX Message Communications Error	An error was detected in message communications for an NX Unit and the message frame was discarded.	<ul style="list-style-type: none"> The message communications load is high. The communications cable is disconnected or broken. This cause does not apply if attached information 2 is 0 (NX bus). Message communications were cut off as the result of executing a synchronization or restoration operation on the Sysmac Studio or as the result of disconnecting an EtherCAT slave. 				S		P. 9-46
90400000 hex	Event Log Cleared	The event log was cleared.	<ul style="list-style-type: none"> The event log was cleared by the user. 					S	P. 9-46

9-3-3 Meaning of Error

This section describes the information that is given for individual errors.

Error Descriptions

The items that are used to describe individual errors (events) are described in the following copy of an error table.

Event name	Gives the name of the error.		Event code	Gives the code of the error.	
Meaning	Gives a short description of the error.				
Source	Gives the source of the error.		Source details	Gives details on the source of the error.	Detection timing Tells when the error is detected.
Error attributes	Level	Tells the level of influence on control.*1	Recovery	Gives the recovery method.*2	Log category Tells which log the error is saved in.*3
Effects	User program	Tells what will happen to execution of the user program.*4	Operation	Provides special information on the operation that results from the error.	
Indicators	Gives the status of the built-in EtherNet/IP port and built-in EtherCAT port indicators. Indicator status is given only for errors in the EtherCAT Master Function Module and the EtherNet/IP Function Module.				
System-defined variables	Variable	Data type		Name	
	Lists the variable names, data types, and meanings for system-defined variables that provide direct error notification, that are directly affected by the error, or that contain settings that cause the error.				
Cause and correction	Assumed cause	Correction		Prevention	
	Lists the possible causes, corrections, and preventive measures for the error.				
Attached information	This is the attached information that is displayed by the Sysmac Studio or an NS-series PT.				
Precautions/Remarks	Provides precautions, restrictions, and supplemental information. If the user can set the event level, the event levels that can be set, the recovery method, operational information, and other information are also provided.				

*1. One of the following:

- Major fault: Major fault level
- Partial fault: Partial fault level
- Minor fault: Minor fault level
- Observation
- Information

*2. One of the following:

- Automatic recovery: Normal status is restored automatically when the cause of the error is removed.
- Error reset: Normal status is restored when the error is reset after the cause of the error is removed.
- Cycle the power supply: Normal status is restored when the power supply to the Controller is turned OFF and then back ON after the cause of the error is removed.
- Controller reset: Normal status is restored when the Controller is reset after the cause of the error is removed.
- Depends on cause: The recovery method depends on the cause of the error.

*3. One of the following:

- System: System event log
- Access: Access event log

*4. One of the following:

- Continues: Execution of the user program will continue.
- Stops: Execution of the user program stops.
- Starts: Execution of the user program starts.

9-3-4 Error Descriptions of Analog Input Units and Analog Output Units

This section describes the information that occurs on the Analog Input Units and Analog Output Units.

Event name	Non-volatile Memory Hardware Error		Event code	0020 0000 hex		
Meaning	An error occurred in non-volatile memory.					
Source	Depends on where the Sysmac Studio is connected and the system configuration.		Source details	NX Unit	Detection timing	When power is turned ON to the NX Unit
Error attributes	Level	Minor fault	Recovery	Restart the Slave Terminal and then reset all errors in Controller.	Log category	System
Effects	User program	Continues.	Operation	I/O refreshing for the NX Unit stops. Messages cannot be sent to the NX Unit.		
Sys-tem-defined variables	Variable		Data type		Name	
	None		---		---	
Cause and correction	Assumed cause		Correction		Prevention	
	Non-volatile memory failure		Replace the NX Unit.		None	
Attached information	None					
Precautions/Remarks	None					

Event name	Analog Unit Calibration Parameter Error		Event code	10400000 hex	
Meaning	An error occurred for the calibration data in the Analog Unit.				
Source	Depends on where the Sysmac Studio is connected and the system configuration.		Source details	NX Unit	Detection timing When power is turned ON to the NX Unit
Error attributes	Level	Minor fault	Recovery	When the fail-soft operation for the Communications Coupler Unit is set to stop, restart the NX Unit and then reset all errors in Controller. When the fail-soft operation for the Communications Coupler Unit is set to fail-soft, restart the NX Unit.	Log category System
Effects	User program	Continues.	Operation	I/O refreshing for the NX Unit stops.	
System-defined variables	Variable	Data type		Name	
	None	---		---	
Cause and correction	Assumed cause		Correction		Prevention
	The power supply to the Analog Unit was turned OFF or Sysmac Studio communications were disconnected while writing the calibration values to the Analog Unit.		Write the calibration values to the Analog Unit again.		Do not turn OFF the power supply to the Analog Unit or disconnect Sysmac Studio communications while writing the calibration values to the Analog Unit.
Attached information	None				
Precautions/Remarks	None				

Event name	Control Parameter Error in Master		Event code	1041 0000 hex	
Meaning	An error occurred in the control parameters that are saved in the master.				
Source	Depends on where the Sysmac Studio is connected and the system configuration.		Source details	NX Unit	Detection timing When power is turned ON to the NX Unit
Error attributes	Level	Minor fault	Recovery	When the fail-soft operation for the Communications Coupler Unit is set to stop, restart the NX Unit and then reset all errors in Controller. When the fail-soft operation for the Communications Coupler Unit is set to fail-soft, restart the NX Unit and then reset errors in Communications Coupler Unit.	Log category System
Effects	User program	Continues.	Operation	I/O refreshing for the NX Unit stops.	
System-defined variables	Variable	Data type		Name	
	None	---		---	
Cause and correction	Assumed cause		Correction		Prevention Do not turn OFF the power supply to the NX Unit or disconnect Sysmac Studio communications while the control parameters are being written.
	There is an error in the area of the non-volatile memory in the Communications Coupler Unit in which the control parameters for the NX Unit are saved. The power supply to the NX Unit was turned OFF or Sysmac Studio communications were disconnected while writing the control parameters.		Write the control parameters again and restart the Communications Coupler Unit. If the error occurs again even after you make the above correction, replace the Communications Coupler Unit.		
Attached information	None				
Precautions/Remarks	None				

Event name	Unit Calibration Value Parity Error		Event code	14C00000 hex		
Meaning	An error occurred in the user calibration data in the NX Unit.					
Source	Depends on where the Sysmac Studio is connected and the system configuration.		Source details	NX Unit	Detection timing	Continuously
Error attributes	Level	Minor fault	Recovery	Restart the Slave Terminal.	Log category	System
Effects	User program	Continues.	Operation	The NX Unit will continue to operate. Input data: Updating input values stops. Output data: The output values depend on the Load Rejection Output Setting.		
System-defined variables	Variable	Data type		Name		
	None	---		---		
Cause and correction	Assumed cause		Correction		Prevention	
	An error was detected in the calibration data.		Cycle the power supply to the NX Unit. If this error occurs again even after you cycle the power supply, replace the NX Unit.		None	
Attached information	None					

Event name	Unit I/O Disconnection Detected for Channel 1		Event code	65030000 hex			
Meaning	A disconnected input was detected for channel 1.						
Source	Depends on where the Sysmac Studio is connected and the system configuration.		Source details	NX Unit	Detection timing	Continuously	
Error attributes	Level	Minor fault	Recovery	Reset error in the NX Unit.	Log category	System	
Effects	User program	Continues.	Operation	The converted value will be 32,767. Operation continues and the converted value returns to normal when the connection is restored.			
System-defined variables	Variable	Data type		Name			
	None	---		---			
Cause and correction	Assumed cause		Correction		Prevention		
	Input wiring is broken.		Check the input wiring for breaks and replace the cable if any are found.		Check the cable for broken wires.		
		Input wiring is disconnected.		Check the input wiring for bad connections and reconnect any bad connections that are found.		Make sure that the wiring is connected properly.	
Attached information	None						
Precautions/Remarks	You can change the event level to the observation level.						

Event name	Unit I/O Disconnection Detected for Channel 2		Event code	65040000 hex		
Meaning	A disconnected input was detected for channel 2.					
Source	Depends on where the Sysmac Studio is connected and the system configuration.		Source details	NX Unit	Detection timing	Continuously
Error attributes	Level	Minor fault	Recovery	Reset error in the NX Unit.	Log category	System
Effects	User program	Continues.	Operation	The converted value will be 32,767. Operation continues and the converted value returns to normal when the connection is restored.		
System-defined variables	Variable	Data type		Name		
	None	---		---		
Cause and correction	Assumed cause	Correction		Prevention		
	Input wiring is broken.	Check the input wiring for breaks and replace the cable if any are found.		Check the cable for broken wires.		
	Input wiring is disconnected.	Check the input wiring for bad connections and reconnect any bad connections that are found.		Make sure that the wiring is connected properly.		
Attached information	None					
Precautions/Remarks	You can change the event level to the observation level.					

Event name	Unit I/O Disconnection Detected for Channel 3		Event code	65050000 hex		
Meaning	A disconnected input was detected for channel 3.					
Source	Depends on where the Sysmac Studio is connected and the system configuration.		Source details	NX Unit	Detection timing	Continuously
Error attributes	Level	Minor fault	Recovery	Reset error in the NX Unit.	Log category	System
Effects	User program	Continues.	Operation	The converted value will be 32,767. Operation continues and the converted value returns to normal when the connection is restored.		
System-defined variables	Variable	Data type		Name		
	None	---		---		
Cause and correction	Assumed cause	Correction		Prevention		
	Input wiring is broken.	Check the input wiring for breaks and replace the cable if any are found.		Check the cable for broken wires.		
	Input wiring is disconnected.	Check the input wiring for bad connections and reconnect any bad connections that are found.		Make sure that the wiring is connected properly.		
Attached information	None					
Precautions/Remarks	You can change the event level to the observation level.					

Event name	Unit I/O Disconnection Detected for Channel 4		Event code	65060000 hex		
Meaning	A disconnected input was detected for channel 4.					
Source	Depends on where the Sysmac Studio is connected and the system configuration.		Source details	NX Unit	Detection timing	Continuously
Error attributes	Level	Minor fault	Recovery	Reset error in the NX Unit.	Log category	System
Effects	User program	Continues.	Operation	The converted value will be 32,767. Operation continues and the converted value returns to normal when the connection is restored.		
System-defined variables	Variable	Data type		Name		
	None	---		---		
Cause and correction	Assumed cause		Correction		Prevention	
	Input wiring is broken.		Check the input wiring for breaks and replace the cable if any are found.		Check the cable for broken wires.	
	Input wiring is disconnected.		Check the input wiring for bad connections and reconnect any bad connections that are found.		Make sure that the wiring is connected properly.	
Attached information	None					
Precautions/Remarks	You can change the event level to the observation level.					

Event name	Unit I/O Disconnection Detected for Channel 5		Event code	65070000 hex		
Meaning	A disconnected input was detected for channel 5.					
Source	Depends on where the Sysmac Studio is connected and the system configuration.		Source details	NX Unit	Detection timing	Continuously
Error attributes	Level	Minor fault	Recovery	Reset error in the NX Unit.	Log category	System
Effects	User program	Continues.	Operation	The converted value will be 32,767. Operation continues and the converted value returns to normal when the connection is restored.		
System-defined variables	Variable	Data type		Name		
	None	---		---		
Cause and correction	Assumed cause		Correction		Prevention	
	Input wiring is broken.		Check the input wiring for breaks and replace the cable if any are found.		Check the cable for broken wires.	
	Input wiring is disconnected.		Check the input wiring for bad connections and reconnect any bad connections that are found.		Make sure that the wiring is connected properly.	
Attached information	None					
Precautions/Remarks	You can change the event level to the observation level.					

Event name	Unit I/O Disconnection Detected for Channel 6		Event code	65080000 hex		
Meaning	A disconnected input was detected for channel 6.					
Source	Depends on where the Sysmac Studio is connected and the system configuration.		Source details	NX Unit	Detection timing	Continuously
Error attributes	Level	Minor fault	Recovery	Reset error in the NX Unit.	Log category	System
Effects	User program	Continues.	Operation	The converted value will be 32,767. Operation continues and the converted value returns to normal when the connection is restored.		
System-defined variables	Variable		Data type		Name	
	None		---		---	
Cause and correction	Assumed cause		Correction		Prevention	
	Input wiring is broken.		Check the input wiring for breaks and replace the cable if any are found.		Check the cable for broken wires.	
	Input wiring is disconnected.		Check the input wiring for bad connections and reconnect any bad connections that are found.		Make sure that the wiring is connected properly.	
Attached information	None					
Precautions/Remarks	You can change the event level to the observation level.					

Event name	Unit I/O Disconnection Detected for Channel 7		Event code	65090000 hex		
Meaning	A disconnected input was detected for channel 7.					
Source	Depends on where the Sysmac Studio is connected and the system configuration.		Source details	NX Unit	Detection timing	Continuously
Error attributes	Level	Minor fault	Recovery	Reset error in the NX Unit.	Log category	System
Effects	User program	Continues.	Operation	The converted value will be 32,767. Operation continues and the converted value returns to normal when the connection is restored.		
System-defined variables	Variable		Data type		Name	
	None		---		---	
Cause and correction	Assumed cause		Correction		Prevention	
	Input wiring is broken.		Check the input wiring for breaks and replace the cable if any are found.		Check the cable for broken wires.	
	Input wiring is disconnected.		Check the input wiring for bad connections and reconnect any bad connections that are found.		Make sure that the wiring is connected properly.	
Attached information	None					
Precautions/Remarks	You can change the event level to the observation level.					

Event name	Unit I/O Disconnection Detected for Channel 8		Event code	650A0000 hex	
Meaning	A disconnected input was detected for channel 8.				
Source	Depends on where the Sysmac Studio is connected and the system configuration.		Source details	NX Unit	Detection timing Continuously
Error attributes	Level	Minor fault	Recovery	Reset error in the NX Unit.	Log category System
Effects	User program	Continues.	Operation	The converted value will be 32,767. Operation continues and the converted value returns to normal when the connection is restored.	
System-defined variables	Variable	Data type		Name	
	None	---		---	
Cause and correction	Assumed cause		Correction		Prevention
	Input wiring is broken.		Check the input wiring for breaks and replace the cable if any are found.		Check the cable for broken wires.
	Input wiring is disconnected.		Check the input wiring for bad connections and reconnect any bad connections that are found.		Make sure that the wiring is connected properly.
Attached information	None				
Precautions/Remarks	You can change the event level to the observation level.				

Event name	NX Unit I/O Communications Error		Event code	80200000 hex	
Meaning	An I/O communications error occurred between the Communications Coupler Unit and the NX Unit.				
Source	Depends on where the Sysmac Studio is connected and the system configuration.		Source details	NX Unit	Detection timing Continuously
Error attributes	Level	Minor fault	Recovery	When the fail-soft operation for the Communications Coupler Unit is set to stop, reset all errors in Controller. When the fail-soft operation for the Communications Coupler Unit is set to fail-soft, reset errors in Communications Coupler Unit and NX Unit.	Log category System
Effects	User program	Continues.	Operation	The NX Unit will continue to operate. Input data: Updating input values stops. Output data: The output values depend on the Load Rejection Output Setting.	
Sys-tem-defined variables	Variable	Data type		Name	
	None	---		---	
Cause and correction	Assumed cause	Correction		Prevention	
	The NX Unit is not mounted properly.	Mount the NX Units and End Cover securely and secure them with End Plates.		Mount the NX Units and End Cover securely and secure them with End Plates.	
	The power cable for the Unit power supply is disconnected. Or, the wiring from the Unit power supply to the NX Units is incorrect.	Correctly wire the Unit power supply to the NX Units.		Correctly wire the Unit power supply to the NX Units.	
	The power cable for the Unit power supply is broken.	Replace the power cable between the Unit power supply and the NX Units.		None	
	The voltage of the Unit power supply is outside the specified range. Or, the capacity of the Unit power supply is insufficient.	Correctly configure the power supply system according to the power supply design methods.		Correctly configure the power supply system according to the power supply design methods.	
	There is a hardware error in the NX Unit.	If the error occurs again even after you make the above correction, replace the NX Unit.		None	
Attached information	None				
Precautions/Remarks	None				

Event name	NX Unit Output Synchronization Error		Event code	80210000 hex	
Meaning	An output synchronization error occurred in the NX Unit.				
Source	Depends on where the Sysmac Studio is connected and the system configuration.		Source details	NX Unit	Detection timing Continuously
Error attributes	Level	Minor fault	Recovery	Reset error in the NX Unit.	Log category System
Effects	User program	Continues.	Operation	The NX Unit will continue to operate. Input data: Updating input values stops. Output data: The output values depend on the Load OFF Output Setting.	
System-defined variables	Variable	Data type		Name	
	None	---		---	
Cause and correction	Assumed cause		Correction		Prevention
	The NX Unit is not mounted properly.		Mount the NX Units and End Cover securely and secure them with End Plates.		Mount the NX Units and End Cover securely and secure them with End Plates.
	The Slave Terminal Configuration Information when the EtherCAT Coupler Unit synchronization settings were downloaded did not agree with the actual configuration of the Slave Terminal.		Correct the actual configuration of the Slave Terminal so that it agrees with the Slave Terminal Configuration Information when the EtherCAT Coupler Unit synchronization settings are downloaded. Or, download synchronization settings that agree with the actual configuration of the Slave Terminal.		Correct the actual configuration of the Slave Terminal so that it agrees with the Slave Terminal Configuration Information when the EtherCAT Coupler Unit synchronization settings are downloaded. Or, download synchronization settings that agree with the actual configuration of the Slave Terminal.
	There is an NX Unit that cannot be synchronized to the specified output synchronization timing. (This will not cause an error when the synchronization setting is made from the Sysmac Studio.)		Adjust the timing of output synchronization to the slowest NX Unit of the NX Units to synchronize.		Adjust the timing of output synchronization to the slowest NX Unit of the NX Units to synchronize.
Attached information	None				
Precautions/Remarks	None				

Event name	NX Unit Clock Not Synchronized Error		Event code	80240000 hex	
Meaning	An error occurred in the clock information between the EtherCAT Coupler Unit and the NX Unit.				
Source	Depends on where the Sysmac Studio is connected and the system configuration.		Source details	NX Unit	Detection timing Continuously
Error attributes	Level	Minor fault	Recovery	Cycle the power supply to the EtherCAT Coupler Unit and the NX Unit.	Log category System
Effects	User program	Continues.	Operation	The NX Unit will continue to operate. Input data: Updating input values stops. Output data: The output values depend on the Load OFF Output Setting.	
System-defined variables	Variable	Data type		Name	
	None	---		---	
Cause and correction	Assumed cause		Correction		Prevention
	There is a hardware error in the NX Unit.		If the error occurred in only a specific NX Unit in the Slave Terminal, replace the NX Unit.		None
There is a hardware error in the EtherCAT Coupler Unit.		If the error occurred in all of the NX Units on the Slave Terminal except for the System Units, replace the EtherCAT Coupler Unit.			
Attached information	None				
Precautions/Remarks	None				

Event name	Unit Over Range for Channel 1		Event code	64F00000 hex		
Meaning	The analog input data for input channel 1 exceeded the upper limit of the input range. Or, the analog output data for output channel 1 exceeded the upper limit of the output range.					
Source	Depends on where the Sysmac Studio is connected and the system configuration.		Source details	NX Unit	Detection timing	Continuously
Error attributes	Level	Observation	Recovery	---	Log category	System
Effects	User program	Continues.	Operation	If the input range is exceeded, the converted value will be the upper limit of the input range. If the output range is exceeded, the analog output will be the upper limit of the output range.		
System-defined variables	Variable		Data type		Name	
	None		---		---	
Cause and correction	Assumed cause		Correction		Prevention	
	The analog input data exceeded the upper limit of the input range. Or, the analog output data exceeded the upper limit of the output range.		Find the reason for exceeding the upper limit of the input or output range and make suitable corrections.		Find the reasons for exceeding the upper limit of the input or output range and take suitable preventive measures.	
Attached information	None					
Precautions/Remarks	You can change the event level to the minor fault level. If you change the level to the minor fault level, the Recovery column above will be changed to "Reset error in the NX Unit."					

Event name	Unit Over Range for Channel 2		Event code	64F10000 hex		
Meaning	The analog input data for input channel 2 exceeded the upper limit of the input range. Or, the analog output data for output channel 2 exceeded the upper limit of the output range.					
Source	Depends on where the Sysmac Studio is connected and the system configuration.		Source details	NX Unit	Detection timing	Continuously
Error attributes	Level	Observation	Recovery	---	Log category	System
Effects	User program	Continues.	Operation	If the input range is exceeded, the converted value will be the upper limit of the input range. If the output range is exceeded, the analog output will be the upper limit of the output range.		
System-defined variables	Variable		Data type		Name	
	None		---		---	
Cause and correction	Assumed cause		Correction		Prevention	
	The analog input data exceeded the upper limit of the input range. Or, the analog output data exceeded the upper limit of the output range.		Find the reason for exceeding the upper limit of the input or output range and make suitable corrections.		Find the reasons for exceeding the upper limit of the input or output range and take suitable preventive measures.	
Attached information	None					
Precautions/Remarks	You can change the event level to the minor fault level. If you change the level to the minor fault level, the Recovery column above will be changed to "Reset error in the NX Unit."					

Event name	Unit Over Range for Channel 3		Event code	64F20000 hex		
Meaning	The analog input data for input channel 3 exceeded the upper limit of the input range. Or, the analog output data for output channel 3 exceeded the upper limit of the output range.					
Source	Depends on where the Sysmac Studio is connected and the system configuration.		Source details	NX Unit	Detection timing	Continuously
Error attributes	Level	Observation	Recovery	---	Log category	System
Effects	User program	Continues.	Operation	If the input range is exceeded, the converted value will be the upper limit of the input range. If the output range is exceeded, the analog output will be the upper limit of the output range.		
System-defined variables	Variable		Data type		Name	
	None		---		---	
Cause and correction	Assumed cause		Correction		Prevention	
	The analog input data exceeded the upper limit of the input range. Or, the analog output data exceeded the upper limit of the output range.		Find the reason for exceeding the upper limit of the input or output range and make suitable corrections.		Find the reasons for exceeding the upper limit of the input or output range and take suitable preventive measures.	
Attached information	None					
Precautions/Remarks	You can change the event level to the minor fault level. If you change the level to the minor fault level, the Recovery column above will be changed to "Reset error in the NX Unit."					

Event name	Unit Over Range for Channel 4		Event code	64F30000 hex		
Meaning	The analog input data for input channel 4 exceeded the upper limit of the input range. Or, the analog output data for output channel 4 exceeded the upper limit of the output range.					
Source	Depends on where the Sysmac Studio is connected and the system configuration.		Source details	NX Unit	Detection timing	Continuously
Error attributes	Level	Observation	Recovery	---	Log category	System
Effects	User program	Continues.	Operation	If the input range is exceeded, the converted value will be the upper limit of the input range. If the output range is exceeded, the analog output will be the upper limit of the output range.		
System-defined variables	Variable		Data type		Name	
	None		---		---	
Cause and correction	Assumed cause		Correction		Prevention	
	The analog input data exceeded the upper limit of the input range. Or, the analog output data exceeded the upper limit of the output range.		Find the reason for exceeding the upper limit of the input or output range and make suitable corrections.		Find the reasons for exceeding the upper limit of the input or output range and take suitable preventive measures.	
Attached information	None					
Precautions/Remarks	You can change the event level to the minor fault level. If you change the level to the minor fault level, the Recovery column above will be changed to "Reset error in the NX Unit."					

Event name	Unit Over Range for Channel 5		Event code	64F40000 hex		
Meaning	The analog input data for input channel 5 exceeded the upper limit of the input range. Or, the analog output data for output channel 5 exceeded the upper limit of the output range.					
Source	Depends on where the Sysmac Studio is connected and the system configuration.		Source details	NX Unit	Detection timing	Continuously
Error attributes	Level	Observation	Recovery	---	Log category	System
Effects	User program	Continues.	Operation	If the input range is exceeded, the converted value will be the upper limit of the input range. If the output range is exceeded, the analog output will be the upper limit of the output range.		
System-defined variables	Variable		Data type		Name	
	None		---		---	
Cause and correction	Assumed cause		Correction		Prevention	
	The analog input data exceeded the upper limit of the input range. Or, the analog output data exceeded the upper limit of the output range.		Find the reason for exceeding the upper limit of the input or output range and make suitable corrections.		Find the reasons for exceeding the upper limit of the input or output range and take suitable preventive measures.	
Attached information	None					
Precautions/Remarks	You can change the event level to the minor fault level. If you change the level to the minor fault level, the Recovery column above will be changed to "Reset error in the NX Unit."					

Event name	Unit Over Range for Channel 6		Event code	64F50000 hex		
Meaning	The analog input data for input channel 6 exceeded the upper limit of the input range. Or, the analog output data for output channel 6 exceeded the upper limit of the output range.					
Source	Depends on where the Sysmac Studio is connected and the system configuration.		Source details	NX Unit	Detection timing	Continuously
Error attributes	Level	Observation	Recovery	---	Log category	System
Effects	User program	Continues.	Operation	If the input range is exceeded, the converted value will be the upper limit of the input range. If the output range is exceeded, the analog output will be the upper limit of the output range.		
System-defined variables	Variable		Data type		Name	
	None		---		---	
Cause and correction	Assumed cause		Correction		Prevention	
	The analog input data exceeded the upper limit of the input range. Or, the analog output data exceeded the upper limit of the output range.		Find the reason for exceeding the upper limit of the input or output range and make suitable corrections.		Find the reasons for exceeding the upper limit of the input or output range and take suitable preventive measures.	
Attached information	None					
Precautions/Remarks	You can change the event level to the minor fault level. If you change the level to the minor fault level, the Recovery column above will be changed to "Reset error in the NX Unit."					

Event name	Unit Over Range for Channel 7		Event code	64F60000 hex		
Meaning	The analog input data for input channel 7 exceeded the upper limit of the input range. Or, the analog output data for output channel 7 exceeded the upper limit of the output range.					
Source	Depends on where the Sysmac Studio is connected and the system configuration.		Source details	NX Unit	Detection timing	Continuously
Error attributes	Level	Observation	Recovery	---	Log category	System
Effects	User program	Continues.	Operation	If the input range is exceeded, the converted value will be the upper limit of the input range. If the output range is exceeded, the analog output will be the upper limit of the output range.		
System-defined variables	Variable		Data type		Name	
	None		---		---	
Cause and correction	Assumed cause		Correction		Prevention	
	The analog input data exceeded the upper limit of the input range. Or, the analog output data exceeded the upper limit of the output range.		Find the reason for exceeding the upper limit of the input or output range and make suitable corrections.		Find the reasons for exceeding the upper limit of the input or output range and take suitable preventive measures.	
Attached information	None					
Precautions/Remarks	You can change the event level to the minor fault level. If you change the level to the minor fault level, the Recovery column above will be changed to "Reset error in the NX Unit."					

Event name	Unit Over Range for Channel 8		Event code	64F70000 hex		
Meaning	The analog input data for input channel 8 exceeded the upper limit of the input range. Or, the analog output data for output channel 8 exceeded the upper limit of the output range.					
Source	Depends on where the Sysmac Studio is connected and the system configuration.		Source details	NX Unit	Detection timing	Continuously
Error attributes	Level	Observation	Recovery	---	Log category	System
Effects	User program	Continues.	Operation	If the input range is exceeded, the converted value will be the upper limit of the input range. If the output range is exceeded, the analog output will be the upper limit of the output range.		
System-defined variables	Variable		Data type		Name	
	None		---		---	
Cause and correction	Assumed cause		Correction		Prevention	
	The analog input data exceeded the upper limit of the input range. Or, the analog output data exceeded the upper limit of the output range.		Find the reason for exceeding the upper limit of the input or output range and make suitable corrections.		Find the reasons for exceeding the upper limit of the input or output range and take suitable preventive measures.	
Attached information	None					
Precautions/Remarks	You can change the event level to the minor fault level. If you change the level to the minor fault level, the Recovery column above will be changed to "Reset error in the NX Unit."					

Event name	Unit Under Range for Channel 1		Event code	64F80000 hex		
Meaning	The analog input data for input channel 1 went below the lower limit of the input range. Or, the analog output data for output channel 1 went below the lower limit of the output range.					
Source	Depends on where the Sysmac Studio is connected and the system configuration.		Source details	NX Unit	Detection timing	Continuously
Error attributes	Level	Observation	Recovery	---	Log category	System
Effects	User program	Continues.	Operation	If the input data goes below the input range, the converted value will be the lower limit of the input range. If the output data goes below the output range, the analog output will be the lower limit of the output range.		
System-defined variables	Variable		Data type		Name	
	None		---		---	
Cause and correction	Assumed cause		Correction		Prevention	
	The analog input data went below the lower limit of the input range. Or, the analog output data went below the lower limit of the output range.		Find the reason for going below the lower limit of the input or output range and make suitable corrections.		Find the reasons for going below the lower limit of the input or output range and take suitable preventive measures.	
Attached information	None					
Precautions/Remarks	You can change the event level to the minor fault level. If you change the level to the minor fault level, the Recovery column above will be changed to "Reset error in the NX Unit."					

Event name	Unit Under Range for Channel 2		Event code	64F90000 hex		
Meaning	The analog input data for input channel 2 went below the lower limit of the input range. Or, the analog output data for output channel 2 went below the lower limit of the output range.					
Source	Depends on where the Sysmac Studio is connected and the system configuration.		Source details	NX Unit	Detection timing	Continuously
Error attributes	Level	Observation	Recovery	---	Log category	System
Effects	User program	Continues.	Operation	If the input data goes below the input range, the converted value will be the lower limit of the input range. If the output data goes below the output range, the analog output will be the lower limit of the output range.		
System-defined variables	Variable		Data type		Name	
	None		---		---	
Cause and correction	Assumed cause		Correction		Prevention	
	The analog input data went below the lower limit of the input range. Or, the analog output data went below the lower limit of the output range.		Find the reason for going below the lower limit of the input or output range and make suitable corrections.		Find the reasons for going below the lower limit of the input or output range and take suitable preventive measures.	
Attached information	None					
Precautions/Remarks	You can change the event level to the minor fault level. If you change the level to the minor fault level, the Recovery column above will be changed to "Reset error in the NX Unit."					

Event name	Unit Under Range for Channel 3		Event code	64FA0000 hex		
Meaning	The analog input data for input channel 3 went below the lower limit of the input range. Or, the analog output data for output channel 3 went below the lower limit of the output range.					
Source	Depends on where the Sysmac Studio is connected and the system configuration.		Source details	NX Unit	Detection timing	Continuously
Error attributes	Level	Observation	Recovery	---	Log category	System
Effects	User program	Continues.	Operation	If the input data goes below the input range, the converted value will be the lower limit of the input range. If the output data goes below the output range, the analog output will be the lower limit of the output range.		
System-defined variables	Variable		Data type		Name	
	None		---		---	
Cause and correction	Assumed cause		Correction		Prevention	
	The analog input data went below the lower limit of the input range. Or, the analog output data went below the lower limit of the output range.		Find the reason for going below the lower limit of the input or output range and make suitable corrections.		Find the reasons for going below the lower limit of the input or output range and take suitable preventive measures.	
Attached information	None					
Precautions/Remarks	You can change the event level to the minor fault level. If you change the level to the minor fault level, the Recovery column above will be changed to "Reset error in the NX Unit."					

Event name	Unit Under Range for Channel 4		Event code	64FB0000 hex		
Meaning	The analog input data for input channel 4 went below the lower limit of the input range. Or, the analog output data for output channel 4 went below the lower limit of the output range.					
Source	Depends on where the Sysmac Studio is connected and the system configuration.		Source details	NX Unit	Detection timing	Continuously
Error attributes	Level	Observation	Recovery	---	Log category	System
Effects	User program	Continues.	Operation	If the input data goes below the input range, the converted value will be the lower limit of the input range. If the output data goes below the output range, the analog output will be the lower limit of the output range.		
System-defined variables	Variable		Data type		Name	
	None		---		---	
Cause and correction	Assumed cause		Correction		Prevention	
	The analog input data went below the lower limit of the input range. Or, the analog output data went below the lower limit of the output range.		Find the reason for going below the lower limit of the input or output range and make suitable corrections.		Find the reasons for going below the lower limit of the input or output range and take suitable preventive measures.	
Attached information	None					
Precautions/Remarks	You can change the event level to the minor fault level. If you change the level to the minor fault level, the Recovery column above will be changed to "Reset error in the NX Unit."					

Event name	Unit Under Range for Channel 5		Event code	64FC0000 hex		
Meaning	The analog input data for input channel 5 went below the lower limit of the input range. Or, the analog output data for output channel 5 went below the lower limit of the output range.					
Source	Depends on where the Sysmac Studio is connected and the system configuration.		Source details	NX Unit	Detection timing	Continuously
Error attributes	Level	Observation	Recovery	---	Log category	System
Effects	User program	Continues.	Operation	If the input data goes below the input range, the converted value will be the lower limit of the input range. If the output data goes below the output range, the analog output will be the lower limit of the output range.		
System-defined variables	Variable		Data type		Name	
	None		---		---	
Cause and correction	Assumed cause		Correction		Prevention	
	The analog input data went below the lower limit of the input range. Or, the analog output data went below the lower limit of the output range.		Find the reason for going below the lower limit of the input or output range and make suitable corrections.		Find the reasons for going below the lower limit of the input or output range and take suitable preventive measures.	
Attached information	None					
Precautions/Remarks	You can change the event level to the minor fault level. If you change the level to the minor fault level, the Recovery column above will be changed to "Reset error in the NX Unit."					

Event name	Unit Under Range for Channel 6		Event code	64FD0000 hex		
Meaning	The analog input data for input channel 6 went below the lower limit of the input range. Or, the analog output data for output channel 6 went below the lower limit of the output range.					
Source	Depends on where the Sysmac Studio is connected and the system configuration.		Source details	NX Unit	Detection timing	Continuously
Error attributes	Level	Observation	Recovery	---	Log category	System
Effects	User program	Continues.	Operation	If the input data goes below the input range, the converted value will be the lower limit of the input range. If the output data goes below the output range, the analog output will be the lower limit of the output range.		
System-defined variables	Variable		Data type		Name	
	None		---		---	
Cause and correction	Assumed cause		Correction		Prevention	
	The analog input data went below the lower limit of the input range. Or, the analog output data went below the lower limit of the output range.		Find the reason for going below the lower limit of the input or output range and make suitable corrections.		Find the reasons for going below the lower limit of the input or output range and take suitable preventive measures.	
Attached information	None					
Precautions/Remarks	You can change the event level to the minor fault level. If you change the level to the minor fault level, the Recovery column above will be changed to "Reset error in the NX Unit."					

Event name	Unit Under Range for Channel 7		Event code	64FE 0000 hex		
Meaning	The analog input data for input channel 7 went below the lower limit of the input range. Or, the analog output data for output channel 7 went below the lower limit of the output range.					
Source	Depends on where the Sysmac Studio is connected and the system configuration.		Source details	NX Unit	Detection timing	Continuously
Error attributes	Level	Observation	Recovery	---	Log category	System
Effects	User program	Continues.	Operation	If the input data goes below the input range, the converted value will be the lower limit of the input range. If the output data goes below the output range, the analog output will be the lower limit of the output range.		
System-defined variables	Variable		Data type		Name	
	None		---		---	
Cause and correction	Assumed cause		Correction		Prevention	
	The analog input data went below the lower limit of the input range. Or, the analog output data went below the lower limit of the output range.		Find the reason for going below the lower limit of the input or output range and make suitable corrections.		Find the reasons for going below the lower limit of the input or output range and take suitable preventive measures.	
Attached information	None					
Precautions/Remarks	You can change the event level to the minor fault level. If you change the level to the minor fault level, the Recovery column above will be changed to "Reset error in the NX Unit."					

Event name	Unit Under Range for Channel 8		Event code	64FF 0000 hex		
Meaning	The analog input data for input channel 8 went below the lower limit of the input range. Or, the analog output data for output channel 8 went below the lower limit of the output range.					
Source	Depends on where the Sysmac Studio is connected and the system configuration.		Source details	NX Unit	Detection timing	Continuously
Error attributes	Level	Observation	Recovery	---	Log category	System
Effects	User program	Continues.	Operation	If the input data goes below the input range, the converted value will be the lower limit of the input range. If the output data goes below the output range, the analog output will be the lower limit of the output range.		
System-defined variables	Variable		Data type		Name	
	None		---		---	
Cause and correction	Assumed cause		Correction		Prevention	
	The analog input data went below the lower limit of the input range. Or, the analog output data went below the lower limit of the output range.		Find the reason for going below the lower limit of the input or output range and make suitable corrections.		Find the reasons for going below the lower limit of the input or output range and take suitable preventive measures.	
Attached information	None					
Precautions/Remarks	You can change the event level to the minor fault level. If you change the level to the minor fault level, the Recovery column above will be changed to "Reset error in the NX Unit."					

Event name	Event Log Cleared		Event code	90400000 hex	
Meaning	The event log was cleared.				
Source	Depends on where the Sysmac Studio is connected and the system configuration.		Source details	NX Unit	Detection timing When commanded from user
Error attributes	Level	Information	Recovery	---	Log category Access
Effects	User program	Continues.	Operation	Not affected.	
System-defined variables	Variable		Data type		Name
	None		---		---
Cause and correction	Assumed cause		Correction		Prevention
	The event log was cleared by the user.		---		---
Attached information	Attached information: Events that were cleared 1: The system event log was cleared. 2: The access event log was cleared.				
Precautions/Remarks	None				

9-3-5 Error Descriptions of Temperature Input Units

This section describes the information that occurs on the Temperature Input Units.

Event name	Non-volatile Memory Hardware Error		Event code	00200000 hex		
Meaning	An error occurred in non-volatile memory.					
Source	Depends on where the Sysmac Studio is connected and the system configuration.		Source details	NX Unit	Detection timing	When power is turned ON to the NX Unit
Error attributes	Level	Minor fault	Recovery	Restart the Slave Terminal and then reset all errors in Controller.	Log category	System
Effects	User program	Continues.	Operation	I/O refreshing for the NX Unit stops. Messages cannot be sent to the NX Unit.		
Sys-tem-defined variables	Variable	Data type		Name		
	None	---		---		
Cause and correction	Assumed cause		Correction		Prevention	
	Non-volatile memory failure		Replace the NX Unit.		None	
Attached information	None					
Precautions/Remarks	None					

Event name	A/D Converter Error		Event code	05100000 hex		
Meaning	An error occurred in the A/D converter					
Source	Depends on where the Sysmac Studio is connected and the system configuration.		Source details	NX Unit	Detection timing	Continuously
Error attributes	Level	Minor fault	Recovery	Cycle the power supply to the NX Unit.	Log category	System
Effects	User program	Continues.	Operation	The process value goes to 32767 for INT data, to 2147483647 for DINT data, and to 1.0E+10 for REAL data.		
System-defined variables	Variable		Data type		Name	
	None		---		---	
Cause and correction	Assumed cause		Correction		Prevention	
	Noise		Cycle the power to the NX Unit and see if this clears the error. If the error occurs frequently, check for noise entry paths and implement noise countermeasures as required.		Implement noise countermeasures.	
	A/D converter failure		If cycling the power supply to the NX Unit does not clear the error, replace the NX Unit.		None	
Attached information	<p>Attached Information 1: Error Channel</p> <p>0001 hex: Channel 1 0010 hex: Channel 2 0100 hex: Channel 3 1000 hex: Channel 4</p> <p>If this error occurs at the same time for more than one channel, the sum of the codes is given.</p> <p>For example, if errors occur at the same time for all channels (1 to 4), then 1111 hex is given.</p>					
Precautions/Remarks	None					

Event name	Cold Junction Sensor Error		Event code	0511 0000 hex	
Meaning	The temperature cannot be converted because the cold junction sensor is disconnected or shorted.				
Source	Depends on where the Sysmac Studio is connected and the system configuration.		Source details	NX Unit	Detection timing Continuously
Error attributes	Level	Minor fault	Recovery	Reset error in the NX Unit.	Log category System
Effects	User program	Continues.	Operation	<p>Operation before Cause Is Removed: The process value goes to 32767 for INT data, to 2147483647 for DINT data, and to 1.0E+10 for REAL data.</p> <p>Operation after Cause Is Removed: The process value returns to normal when the connection is restored.</p>	
Sys-tem-defined variables	Variable	Data type		Name	
	None	---		---	
Cause and correction	Assumed cause	Correction		Prevention	
	There is a faulty connection to the cold junction sensor.	Check the connections to the cold junction sensor on the terminal block and correct any bad connections that are found.		Make sure that the cold junction sensor is corrected correctly on the terminal block.	
	The cold junction sensor failed.	Replace the NX Unit.		None	
Attached information	<p>Attached Information 1: Error Channel</p> <p>0001 hex: Channel 1 0010 hex: Channel 2 0100 hex: Channel 3 1000 hex: Channel 4</p> <p>If this error occurs at the same time for more than one channel, the sum of the codes is given.</p> <p>For example, if errors occur at the same time for all channels (1 to 4), then 1111 hex is given.</p>				
Precautions/Remarks	You can change the event level to the observation level.				

Event name	Control Parameter Error in Master		Event code	10410000 hex	
Meaning	An error occurred in the control parameters that are saved in the master.				
Source	Depends on where the Sysmac Studio is connected and the system configuration.		Source details	NX Unit	Detection timing When power is turned ON to the NX Unit
Error attributes	Level	Minor fault	Recovery	When the fail-soft operation for the Communications Coupler Unit is set to stop, restart the NX Unit and then reset all errors in Controller. When the fail-soft operation for the Communications Coupler Unit is set to fail-soft, restart the NX Unit and then reset errors in Communications Coupler Unit.	Log category System
Effects	User program	Continues.	Operation	I/O refreshing for the NX Unit stops.	
System-defined variables	Variable	Data type		Name	
	None	---		---	
Cause and correction	Assumed cause		Correction		Prevention Do not turn OFF the power supply to the NX Unit or disconnect Sysmac Studio communications while the control parameters are being written.
	There is an error in the area of the non-volatile memory in the Communications Coupler Unit in which the control parameters for the NX Unit are saved. The power supply to the NX Unit was turned OFF or Sysmac Studio communications were disconnected while writing the control parameters.		Write the control parameters again and restart the Communications Coupler Unit. If the error occurs again even after you make the above correction, replace the Communications Coupler Unit.		
Attached information	None				
Precautions/Remarks	None				

Event name	Sensor Disconnected Error		Event code	65100000 hex	
Meaning	A disconnected temperature sensor was detected.				
Source	Depends on where the Sysmac Studio is connected and the system configuration.		Source details	NX Unit	Detection timing Continuously
Error attributes	Level	Minor fault	Recovery	Reset error in the NX Unit.	Log category System
Effects	User program	Continues.	Operation	<p>Operation before Cause Is Removed: The process value goes to 32767 for INT data, to 2147483647 for DINT data, and to 1.0E+10 for REAL data.</p> <p>Operation after Cause Is Removed: The process value returns to normal when the connection is restored.</p>	
Sys-tem-defined variables	Variable	Data type		Name	
	None	---		---	
Cause and correction	Assumed cause		Correction		Prevention
	The temperature sensor is damaged or the wires are broken.		Check the temperature sensor for damage or broken wires and replace it if it is damaged or there are broken wires.		Make sure that the temperature sensor is not damaged and that no wires are broken before you use it.
	An unused channel is not disabled.		Set the Enabled Channel Setting to Disabled for any unused channels.		Set the Enabled Channel Setting to Disabled for any unused channels.
Attached information	<p>Attached Information 1: Error Channel</p> <p>0001 hex: Channel 1</p> <p>0010 hex: Channel 2</p> <p>0100 hex: Channel 3</p> <p>1000 hex: Channel 4</p> <p>If this error occurs at the same time for more than one channel, the sum of the codes is given.</p> <p>For example, if errors occur at the same time for all channels (1 to 4), then 1111 hex is given.</p>				
Precautions/Remarks	You can change the event level to the observation level.				

Event name	NX Unit I/O Communications Error		Event code	80200000 hex	
Meaning	An I/O communications error occurred between the Communications Coupler Unit and the NX Unit.				
Source	Depends on where the Sysmac Studio is connected and the system configuration.		Source details	NX Unit	Detection timing Continuously
Error attributes	Level	Minor fault	Recovery	When the fail-soft operation for the Communications Coupler Unit is set to stop, reset all errors in Controller. When the fail-soft operation for the Communications Coupler Unit is set to fail-soft, reset errors in Communications Coupler Unit and NX Unit.	Log category System
Effects	User program	Continues.	Operation	The NX Unit will continue to operate. Input data: Updating input values stops.	
System-defined variables	Variable	Data type		Name	
	None	---		---	
Cause and correction	Assumed cause		Correction		Prevention
	The NX Unit is not mounted properly.		Mount the NX Units and End Cover securely and secure them with End Plates.		Mount the NX Units and End Cover securely and secure them with End Plates.
	The power cable for the Unit power supply is disconnected. Or, the wiring from the Unit power supply to the NX Units is incorrect.		Correctly wire the Unit power supply to the NX Units.		Correctly wire the Unit power supply to the NX Units.
	The power cable for the Unit power supply is broken.		Replace the power cable between the Unit power supply and the NX Units.		None
	The voltage of the Unit power supply is outside the specified range. Or, the capacity of the Unit power supply is insufficient.		Correctly configure the power supply system according to the power supply design methods.		Correctly configure the power supply system according to the power supply design methods.
	There is a hardware error in the NX Unit.		If the error occurs again even after you make the above correction, replace the NX Unit.		None
Attached information	None				
Precautions/Remarks	None				

Event name	NX Unit Clock Not Synchronized Error		Event code	80240000 hex	
Meaning	An error occurred in the clock information between the EtherCAT Coupler Unit and the NX Unit.				
Source	Depends on where the Sysmac Studio is connected and the system configuration.		Source details	NX Unit	Detection timing Continuously
Error attributes	Level	Minor fault	Recovery	Restart the NX Unit.	Log category System
Effects	User program	Continues.	Operation	The NX Unit will continue to operate. Input data: Updating input values stops. Output data: The output values depend on the Load Rejection Output Setting.	
System-defined variables	Variable	Data type		Name	
	None	---		---	
Cause and correction	Assumed cause		Correction		Prevention
	There is a hardware error in the NX Unit.		If the error occurred in only a specific NX Unit in the Slave Terminal, replace the NX Unit.		None
There is a hardware error in the EtherCAT Coupler Unit.		If the error occurred in all of the NX Units on the Slave Terminal except for the System Units, replace the EtherCAT Coupler Unit.			
Attached information	None				
Precautions/Remarks	None				

Event name	Process Value Over Range		Event code	6511 0000 hex	
Meaning	The process temperature exceeded the upper limit of temperature conversion range.				
Source	Depends on where the Sysmac Studio is connected and the system configuration.		Source details	NX Unit	Detection timing Continuously
Error attributes	Level	Observation	Recovery	Reset error in the NX Unit.	Log category System
Effects	User program	Continues.	Operation	<p>Operation before Cause Is Removed: The process value goes to the upper limit of temperature conversion range.</p> <p>Operation after Cause Is Removed: The process value returns to normal.</p>	
System-defined variables	Variable	Data type		Name	
	None	---		---	
Cause and correction	Assumed cause		Correction		Prevention
	The sensor is disconnected.		Find the reason the upper limit of the temperature conversion range was exceeded and make suitable corrections.		Investigate reasons for exceeding the upper limit of the temperature conversion range and take suitable preventive measures.
	The sensor or the compensating cables are not wired correctly.				
	The sensor and the input type setting do not agree.				
	The range of the input type is too narrow for the temperatures that need to be measured.				
	An unused channel is not disabled.				
Attached information	<p>Attached Information 1: Error Channel</p> <p>0001 hex: Channel 1</p> <p>0010 hex: Channel 2</p> <p>0100 hex: Channel 3</p> <p>1000 hex: Channel 4</p> <p>If this error occurs at the same time for more than one channel, the sum of the codes is given.</p> <p>For example, if errors occur at the same time for all channels (1 to 4), then 1111 hex is given.</p>				
Precautions/Remarks	You can change the event level to the minor fault level.				

Event name	Process Value Under Range		Event code	65120000 hex	
Meaning	The process temperature went below the lower limit of temperature conversion range.				
Source	Depends on where the Sysmac Studio is connected and the system configuration.		Source details	NX Unit	Detection timing Continuously
Error attributes	Level	Observation	Recovery	Reset error in the NX Unit.	Log category System
Effects	User program	Continues.	Operation	Operation before Cause Is Removed: The process value goes to the lower limit of temperature conversion range. Operation after Cause Is Removed: The process value returns to normal.	
Sys-tem-defined variables	Variable		Data type		Name
	None		---		---
Cause and correction	Assumed cause		Correction		Prevention
	The sensor or the compensating cables are not wired correctly.		Find the reason for going below the lower limit of the temperature conversion range and make suitable corrections.		Investigate reasons for going below the lower limit of the temperature conversion range and take suitable preventive measures.
	The sensor and the input type setting do not agree.				
	The range of the input type is too narrow for the temperatures that need to be measured.				
Attached information	<p>Attached Information 1: Error Channel</p> <p>0001 hex: Channel 1 0010 hex: Channel 2 0100 hex: Channel 3 1000 hex: Channel 4</p> <p>If this error occurs at the same time for more than one channel, the sum of the codes is given.</p> <p>For example, if errors occur at the same time for all channels (1 to 4), then 1111 hex is given.</p>				
Precautions/Remarks	You can change the event level to the minor fault level.				

Event name	NX Message Communications Error		Event code	80220000 hex		
Meaning	An error was detected in message communications for an NX Unit and the message frame was discarded.					
Source	Depends on where the Sysmac Studio is connected and the system configuration.		Source details	NX Unit	Detection timing	During NX message communications
Error attributes	Level	Observation	Recovery	---	Log category	System
Effects	User program	Continues.	Operation	Not affected.		
System-defined variables	Variable	Data type		Name		
	None	---		---		
Cause and correction	Assumed cause		Correction		Prevention	
	The message communications load is high.		Reduce the number of times that instructions are used to send NX messages. Refer to the appendix of the <i>NJ-series Instructions Reference Manual</i> (Cat. No. W502-E1-07) for information on the instructions that send messages.		Reduce the number of times that instructions are used to send NX messages.	
	The communications cable is disconnected or broken. This cause does not apply if attached information 2 is 0 (NX bus).		Connect the communications cable securely.		Connect the communications cable securely.	
Attached information	Attached information 1: System information Attached information 2: Type of communications where error occurred 0: NX bus 1: EtherCAT 2: Serial communications (USB) 65535: Internal Unit communications (routing)					
Precautions/Remarks	None					

Event name	Event Log Cleared		Event code	90400000 hex		
Meaning	The event log was cleared.					
Source	Depends on where the Sysmac Studio is connected and the system configuration.		Source details	NX Unit	Detection timing	When commanded from user
Error attributes	Level	Information	Recovery	---	Log category	Access
Effects	User program	Continues.	Operation	Not affected.		
System-defined variables	Variable	Data type		Name		
	None	---		---		
Cause and correction	Assumed cause		Correction		Prevention	
	The event log was cleared by the user.		---		---	
Attached information	Attached information: Events that were cleared 1: The system event log was cleared. 2: The access event log was cleared.					
Precautions/Remarks	None					

9-4 Resetting Errors

Current errors in a Slave Terminal are retained, unless you reset them, until you cycle the power supply or restart the Slave Terminal.

To reset errors, you must remove the cause of the current error. If you reset an error without removing the cause, the same error will occur again.



Precautions for Correct Use

Resetting the errors does not remove the cause of the error.

Always remove the cause of the error, and then reset the error.

You can use the following methods to reset errors in a Slave Terminal.

Method	Operation	Scope of error reset	Description
Commands from Sysmac Studio	Resetting Controller errors	All errors in the Controller	Reset the Controller error from the Troubleshooting Dialog Box on the Sysmac Studio.
		All errors in the Slave Terminal	Refer to the user's manual of the Communications Coupler Unit for details on resetting errors in the EtherCAT Slave Terminal.
		Errors for individually specified NX Units	
Commands from the user program	Clearing all memory for the Slave Terminal	All errors in the Slave Terminal	If the causes for the Controller errors are removed, all Controller errors in the Slave Terminals are reset.
	Restarting Slave Terminals		
Commands from the user program	Resetting Controller errors in the EtherCAT Master Function Module	All errors in the EtherCAT Master Function Module	Execute the Reset EtherCAT Error (ResetECError) instruction in the user program of the NJ-series Controller.
Cycling the Unit power supply to the Slave Terminal	---	All errors in the Slave Terminal	If the causes for the Controller errors are removed, all Controller errors in the Slave Terminals are reset.

Note On the NS-Series PT, you can only reset all errors for the entire Controller.

Refer to the *Sysmac Studio Version 1 Operation Manual* (Cat. No. W504-E1-07 or later) for Sysmac Studio operating procedures.

For details on the Reset EtherCAT Error (ResetECError) instruction, refer to the *NJ-series Instructions Reference Manual* (Cat. No. W502).

9-5 Troubles Specific To Each Type of NX Units

9-5-1 Analog I/O Units (Common)

Problem	Assumed cause	Correction
The converted values or analog signal values are different from expected or the error is too large.	The user calibration error is too large.	Execute the user calibration again.
	The required input or output is disabled.	Check to see if the setting is enabled.
	Wiring is incorrect. (Positive and negative are reversed etc.)	Check that the wiring is correct.

9-5-2 Analog Input Units

Problem	Assumed cause	Correction
The disconnection indication does not clear.	The sensor is disconnected.	Restore the sensor connection. Check the connected sensor and input type.
	The input is significantly out of sensor measurement range.	Check that the input is correct.
	Wiring is incorrect. (Positive and negative are reversed etc.)	Check that the wiring is correct.
	The user calibration error is too large.	Execute the user calibration again.
The disconnection detection is not performed.	The disconnection detection cannot be performed with input types other than 4 to 20 mA.	Check the input type.
The user calibration is not accepted.	Attempted to make calibration with inputs outside the correction range.	Input the voltage/current within the correction range from the input device and make the calibration again. If the voltage/current within the correction range cannot be input, change the connecting method to the input device.

9-5-3 Analog Output Units

Problem	Assumed cause	Correction
The expected output is not held when communications errors occur.	The output settings at load rejection are incorrect.	Set the output value at load rejection.
The user calibration is not accepted.	Attempted to make calibration with values outside the correction range.	Set the voltage/current within the correction range and make the calibration again. If the final output values cannot be calibrated within the correctable range, change the connecting method to the output device.
The output is not performed.	The Unit is not wired correctly with the connected external device.	Check the wiring with the connected external device.
	The wiring to the connected external device is disconnected.	Check the wiring with the connected external device.
	A connected external device is defective.	Replace the connected external device.

9-5-4 Temperature Input Units

Unit type	Problem	Assumed cause	Correction
Thermocouple Input Unit	The cold junction sensor error occurs when the cold junction compensation is disabled.	The cold junction sensor is disconnected.	Connect the cold junction sensor.
All Units	The measurement error occurs when using the input correction.	The temperature unit was changed after the input correction parameters (Index 5010 to 5014) are set.	Implement one of the following measures. <ul style="list-style-type: none"> After loading the input correction parameters, perform the unit conversion and set again. Perform the input correction again and set the input correction parameters.

9-6 Troubleshooting Flowchart

Refer to the *NX-series EtherCAT Coupler Unit User's Manual* (Cat. No. W519) for information on the standard troubleshooting flowcharts.

10

Inspection and Maintenance

This section describes how to clean, inspect, and maintain the system.

10-1 Cleaning and Inspection	10-2
10-1-1 Cleaning	10-2
10-1-2 Periodic Inspection	10-2
10-2 Maintenance Procedures	10-5
10-2-1 Backing Up Data	10-5
10-2-2 Replacement Procedure for NX Units	10-6

10-1 Cleaning and Inspection

This section describes daily device maintenance such as cleaning and inspection.

Make sure to perform daily or periodic inspections in order to maintain the Analog I/O Unit's functions in the best operating condition.

10-1-1 Cleaning

Perform the following cleaning procedures periodically to ensure the Analog I/O Units are maintained in the best operating condition.

- Wipe the equipment over with a soft, dry cloth when performing daily cleaning.
- If dirt remains even after wiping with a soft, dry cloth, wipe with a cloth that has been wet with a sufficiently diluted detergent (2%) and wrung dry.
- Units will become stained if items such as rubber, vinyl products, or adhesive tape are left on the NX Unit for a long period. Remove such items during regular cleaning.



Precautions for Correct Use

- Never use benzene, thinners, other volatile solvents, or chemical cloths.
- Do not touch the NX bus connectors.

10-1-2 Periodic Inspection

NX Units do not have parts with a specific life. However, its elements can deteriorate under improper environmental conditions. Periodic inspections are thus required to ensure that the required conditions are being maintained.

Inspection is recommended at least once every six months to a year, but more frequent inspections may be necessary depending on the severe environments.

Take immediate steps to correct the situation if any of the conditions in the following table are not met.

Periodic Inspection Items

No.	Inspection item	Inspection details	Criteria	Correction
1	External power supply	Is the power supply voltage measured at the terminal block within standards?	Within the power supply voltage range	Use a voltage tester to check the power supply at the terminals. Take necessary steps to bring the power supply within the power supply voltage range.
2	I/O power supply	Is the power supply voltage measured at the I/O terminal block within standards?	Voltages must be within I/O specifications of each NX Unit.	Use a voltage tester to check the power voltage at the terminals. Take necessary steps to bring the I/O power supply within NX Unit standards.
3	Ambient environment	Is the ambient operating temperature within standards?	0 to 55°C	Use a thermometer to check the temperature and ensure that the ambient operating temperature remains within the allowed range of 0 to 55°C.
		Is the ambient operating humidity within standards?	Relative humidity must be 10% to 95% with no condensation.	Use a hygrometer to check the humidity and ensure that the ambient operating humidity remains between 10% and 95%. Make sure that condensation does not occur due to rapid changes in temperature.
		Is it subject to direct sunlight?	Not in direct sunlight	Protect the Controller if necessary.
		Is there an accumulation of dirt, dust, salt, metal powder, etc.?	No accumulation	Clean and protect the Controller if necessary.
		Is there water, oil, or chemical sprays hitting the Controller?	No spray	Clean and protect the Controller if necessary.
		Are there corrosive or flammable gases in the area of the Controller?	No spray	Check by smell or use a sensor.
		Is the Unit subject to shock or vibration?	Vibration resistance and shock resistance must be within specifications.	Install cushioning or other vibration and shock absorbing equipment if necessary.
		Are there noise sources near the Controller?	No significant noise sources	Either separate the Controller and noise source, or protect the Controller.
4	Installation and wiring	Are the DIN track mounting hooks for each NX Unit securely locked?	No looseness	Securely lock the DIN track mounting hooks.
		Are the cable connectors fully inserted and locked?	No looseness	Correct any improperly installed connectors.
		Are there any loose screws on the End Plates (PFP-M)?	No looseness	Tighten loose screws with a Phillips-head screwdriver.
		Are the NX Units connected to each other along the hookup guides and until they touch the DIN track?	You must connect and fix the NX Units to the DIN track.	Connect the NX Units to each other along the hookup guides and until they touch the DIN track.
		Are there any damaged external wiring cables?	No visible damage	Check visually and replace cables if necessary.

Tools Required for Inspections

● **Required Tools**

- Phillips screwdriver
- Flat-blade screwdriver
- Voltage tester or digital voltmeter
- Industrial alcohol and pure cotton cloth

● **Tools Required Occasionally**

- Oscilloscope
- Thermometer and hygrometer

10-2 Maintenance Procedures

This section describes the procedures for backing up the data in the Analog I/O Units, and how to replace the Analog I/O Units.

10-2-1 Backing Up Data

Perform backups so that you can restore the EtherCAT Coupler Unit to its original state in the event of a failure or other problem.

The target data to back up on the EtherCAT Coupler Unit are listed below.

- Unit configuration information
- I/O allocation information
- Unit operation settings
- Hardware switch information
- Production information



Precautions for Correct Use

The backup data for the EtherCAT Coupler Unit includes data for NX Units that store their settings in the EtherCAT Coupler Unit. If you replace the EtherCAT Coupler Unit, you must restore this data to restore the settings for these NX Units.

Refer to the user's manual of the Communications Coupler Unit for backup methods, and to the *Sysmac Studio Version 1 Operation Manual* (Cat. No. W504) for the backup procedures.

10-2-2 Replacement Procedure for NX Units

This section describes the basic replacement procedures for the NX Units that are mounted after the EtherCAT Coupler Unit.

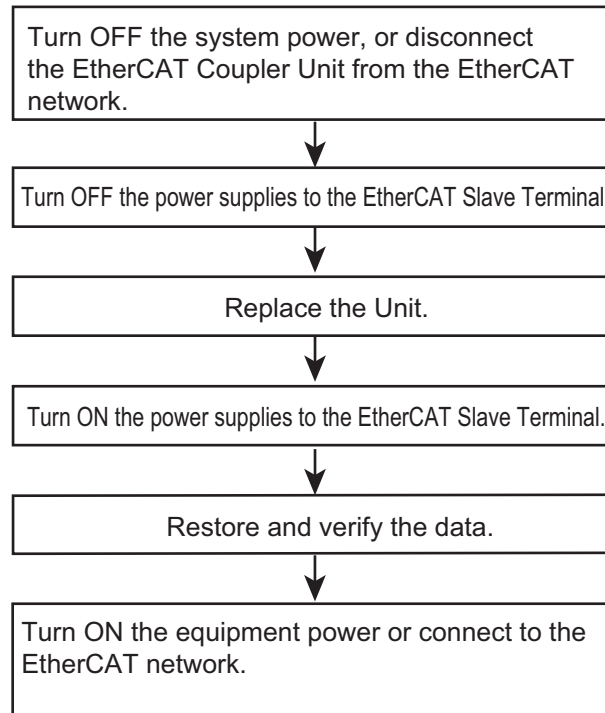

- 1** Turn OFF the power supply to all of the equipment or disconnect the EtherCAT Slave Terminal that includes the NX Unit to replace from the EtherCAT network.
- 2** Turn OFF the Unit power supplies and I/O power supplies for the EtherCAT Slave Terminal.
- 3** Replace the NX Unit. If the NX Unit has hardware switches, set the hardware switches to the same settings as on the original NX Unit.
- 4** Turn ON the Unit power supplies and I/O power supplies to the EtherCAT Slave Terminal.
- 5** Restore and verify data for the new NX Unit.
- 6** Turn ON the power supply to all of the equipment, or connect the EtherCAT Slave Terminal to the EtherCAT network.

The user calibration values of the Analog Input Unit and Analog Output Unit are not backed up or restored. If necessary, execute the user calibration of the Unit after replacement.



Precautions for Correct Use

Checking the Serial Numbers of NX Units

If the Serial Number Check Method setting on the EtherCAT Coupler Unit is set to *Setting = Actual device*, temporarily change this setting to *None*, and then replace the NX Unit. Get the serial number of the new NX Unit, and then set the Serial Number Check Method setting on the EtherCAT Coupler Unit to *Setting = Actual device* again.

If you replace the NX Unit with the Serial Number Check Method setting set to *Setting = Actual device*, a Unit Configuration Verification Error will occur.

Refer to the user's manual of the Communications Coupler Unit for details on the Serial Number Check Method setting for the EtherCAT Coupler Unit.



Additional Information

- Refer to the *4-1 Installing NX Units* on page 4-2 for the procedures to mount and remove the NX Unit.
 - Refer to the *NJ-series CPU Unit Built-in EtherCAT Port User's Manual* (Cat. No. W505) for the procedures to disconnect and connect the EtherCAT Coupler Unit from and to the EtherCAT network.
 - Refer to *NJ-series CPU Unit Software User's Manual* (Cat. No. W501-E1-06 or later) for the procedures for restoring and comparing data.
-



Appendices

This section describes the data sheets of the Analog I/O Units and their dimensions.

A-1 Data Sheet	A-2
A-1-1 Model List	A-2
A-1-2 Analog Input Units	A-5
A-1-3 Analog Output Units	A-24
A-1-4 Temperature Input Units	A-37
A-2 Dimensions	A-56
A-2-1 Screwless Clamping Terminal Block Type	A-56
A-3 List of NX Objects	A-58
A-3-1 Format of Object Descriptions	A-58
A-3-2 Analog Input Units	A-59
A-3-3 Analog Output Units	A-68
A-3-4 Temperature Input Units	A-73
A-4 List of Terminal Block Models	A-94
A-4-1 Model Notation	A-94
A-4-2 List of Terminal Block Models	A-94
A-5 Version Information	A-95
A-5-1 Relationship between the Unit Versions of Each Unit and the EtherCAT Coupler Units, CPU Units, and Sysmac Studio Versions	A-95
A-5-2 Functions That Were Added or Changed for Each Unit Version	A-97

A-1 Data Sheet

The specifications of individual Analog I/O Unit are shown below.

A-1-1 Model List

Analog Input Units (Screwless Clamping Terminal Block, 12 mm Width)

Model	Number of points	Input range	Resolution	Input method	I/O refreshing method	Conversion time	Reference
NX-AD2203	2 points	4 to 20 mA	1/8000	Single-ended	Free-Run refreshing	250 μs/point	P. A-6
NX-AD2204							P. A-7
NX-AD2208			1/30000	Differential	Switching Synchronous I/O refreshing and Free-Run refreshing	10 μs/point	P. A-8
NX-AD2603			-10 to +10 V	1/8000	Single-ended	Free-Run refreshing	250 μs/point
NX-AD2604		P. A-10					
NX-AD2608	1/30000	Differential		Switching Synchronous I/O refreshing and Free-Run refreshing	10 μs/point	P. A-11	
NX-AD3203	4 points	4 to 20 mA		1/8000	Single-ended	Free-Run refreshing	250 μs/point
NX-AD3204					P. A-13		
NX-AD3208			1/30000	Differential	Switching Synchronous I/O refreshing and Free-Run refreshing	10 μs/point	P. A-14
NX-AD3603			-10 to +10 V	1/8000	Single-ended	Free-Run refreshing	250 μs/point
NX-AD3604		P. A-16					
NX-AD3608	1/30000	Differential		Switching Synchronous I/O refreshing and Free-Run refreshing	10 μs/point	P. A-17	

Model	Number of points	Input range	Resolution	Input method	I/O refreshing method	Conversion time	Reference
NX-AD4203	8 points	4 to 20 mA	1/8000	Single-ended	Free-Run refreshing	250 µs/point	P. A-18
NX-AD4204							P. A-19
NX-AD4208			1/30000	Differential	Switching Synchronous I/O refreshing and Free-Run refreshing	10 µs/point	P. A-20
NX-AD4603		-10 to +10 V	1/8000	Single-ended	Free-Run refreshing	250 µs/point	P. A-21
NX-AD4604							P. A-22
NX-AD4608			1/30000	Differential	Switching Synchronous I/O refreshing and Free-Run refreshing	10 µs/point	P. A-23

Analog Output Units (Screwless Clamping Terminal Block, 12 mm Width)

Model	Number of points	Output range	Resolution	I/O refreshing method	Conversion time	Reference
NX-DA2203	2 points	4 to 20 mA	1/8000	Free-Run refreshing	250 µs/point	P. A-25
NX-DA2205			1/30000	Switching Synchronous I/O refreshing and Free-Run refreshing	10 µs/point	P. A-27
NX-DA2603		-10 to +10 V	1/8000	Free-Run refreshing	250 µs/point	P. A-29
NX-DA2605			1/30000	Switching Synchronous I/O refreshing and Free-Run refreshing	10 µs/point	P. A-30
NX-DA3203	4 points	4 to 20 mA	1/8000	Free-Run refreshing	250 µs/point	P. A-31
NX-DA3205			1/30000	Switching Synchronous I/O refreshing and Free-Run refreshing	10 µs/point	P. A-33
NX-DA3603		-10 to +10 V	1/8000	Free-Run refreshing	250 µs/point	P. A-35
NX-DA3605			1/30000	Switching Synchronous I/O refreshing and Free-Run refreshing	10 µs/point	P. A-36

Temperature Input Units (Screwless Clamping Terminal Block, 12 mm Width)

Model	Number of points	Input type	Conversion time	Resolution	I/O refreshing method	Reference
NX-TS2101	2 points	Thermocouple	250 ms/Unit	0.1°C max. ^{*1}	Free-Run refreshing	P. A-40
NX-TS2102			10 ms/Unit	0.01°C max.		P. A-41
NX-TS2104			60 ms/Unit	0.001°C max.		P. A-42
NX-TS2201		Resistance thermometer (Pt100/Pt1000, three-wire) ^{*2}	250 ms/Unit	0.1°C max.		P. A-43
NX-TS2202			10 ms/Unit	0.01°C max.		P. A-44
NX-TS2204			60 ms/Unit	0.001°C max.		P. A-45

*1. The resolution is 0.2°C max. when the input type is R, S, or W.

*2. The NX-TS2202 only supports Pt100 three-wire sensor.

Temperature Input Units (Screwless Clamping Terminal Block, 24 mm Width)

Model	Number of points	Input type	Conversion time	Resolution	I/O refreshing method	Reference
NX-TS3101	4 points	Thermocouple	250 ms/Unit	0.1°C max. ^{*1}	Free-Run refreshing	P. A-46
NX-TS3102			10 ms/Unit	0.01°C max.		P. A-47
NX-TS3104			60 ms/Unit	0.001°C max.		P. A-48
NX-TS3201		Resistance thermometer (Pt100/Pt1000, three-wire) ^{*2}	250 ms/Unit	0.1°C max.		P. A-49
NX-TS3202			10 ms/Unit	0.01°C max.		P. A-50
NX-TS3204			60m ms/Unit	0.01°C max.		P. A-51

*1. The resolution is 0.2°C max. when the input type is R, S, or W.

*2. The NX-TS3202 only supports Pt100 three-wire sensor.

A-1-2 Analog Input Units

Description of Items on Data Sheet of the Analog Input Unit

The meanings of the items on the data sheet of the Analog Input Unit are explained in the table below.

Item	Description
Unit name	The name of the Unit.
Model	The model of the Unit.
Number of points	The number of analog input points provided by the Unit.
External connection terminals	The type of terminal block and connector that is used for connecting the Unit. The number of terminals on the terminal block is also described when a screwless clamping terminal block is used.
I/O refreshing method	The I/O refreshing methods that are used by the Unit. Free-Run refreshing and synchronous I/O refreshing are available.
Indicators	The type of indicators on the Unit and the layout of those indicators.
Input method	The analog signal input method provided by the Unit. Single-ended input and differential input are available.
Input range	The input range of the Unit.
Input conversion range	The conversion range of converted values for the full scale of the Unit. Input converted values range is fixed to the conversion limit value.
Absolute maximum rating	The maximum value of analog input signals of the Unit. If a signal exceeding this range is input, the Unit may be damaged.
Input impedance	The input impedance of the Unit.
Resolution	The resolution of converted values of the Unit.
Overall accuracy	The analog conversion input accuracy of the Unit. It is defined under the conditions of 25°C and 0 to 55°C.
Conversion time	The time required to convert analog input signals of the Unit to the converted values.
Dimensions	The dimensions of the Unit. They are described as W x H x D. The unit is "mm".
Isolation method	The isolation method between the input circuits and internal circuits and between the input circuits of the Unit.
Insulation resistance	The insulation resistance between the input circuits and internal circuits and between each input circuit of the Unit.
Dielectric strength	The dielectric strength between the input circuits and internal circuits and between each input circuit of the Unit.
I/O power supply method	The method for supplying I/O power for the Unit. The supply method is determined for each Unit. The power is supplied from the NX bus or the external source.
Current capacity of I/O power supply terminal	The current capacity of the I/O power supply terminals (IOV/IOG) of the Unit. Do not exceed this value when supplying the I/O power to the connected external devices.
NX Unit power consumption	The power consumption of the NX Unit power supply of the Unit.
Current consumption from I/O power supply	The current consumption from I/O power supply of the Unit. The above input current and current consumption of any connected external devices are excluded.
Weight	The weight of the Unit.
Circuit layout	The input circuit layout of the Unit.
Installation orientation and restrictions	The installation orientation of the Slave Terminal including the Unit, and the details of restrictions on the specifications due to the installation orientation.
Terminal connection diagram	A diagram of the connection between the Unit and connected external devices. When an I/O Power Supply Connection Unit or a Shield Connection Unit is required to be connected to the connected external devices, the description for such is included.
Input disconnection detection	The function of the Unit to detect an input disconnection. This function is provided for models with the 4 to 20 mA input range.

Analog Input Units (Screwless Clamping Terminal Block, 12 mm Width)

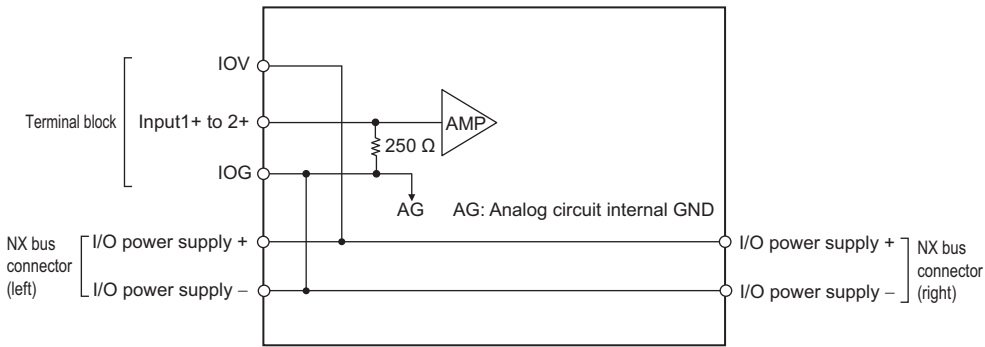
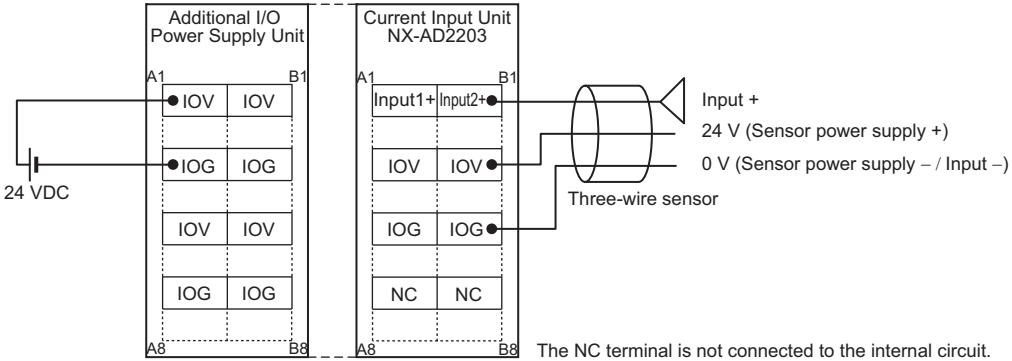
Unit name	Analog Input Unit (current input type)	Model	NX-AD2203				
Number of points	2 points	External connection terminals	Screwless clamping terminal block (8 terminals)				
I/O refreshing method	Free-Run refreshing						
Indicators	TS indicator 	Input method	Single-ended input				
		Input range	4 to 20 mA				
		Input conversion range	-5 to 105% (full scale)				
		Absolute maximum rating	±30 mA				
		Input impedance	250 Ω				
		Resolution		1/8000 (full scale)			
			Over-all accuracy	<table border="1"> <tr> <td>25 °C</td> <td>±0.2% (full scale)</td> </tr> <tr> <td>0 to 55°C</td> <td>±0.4% (full scale)</td> </tr> </table>	25 °C	±0.2% (full scale)	0 to 55°C
		25 °C	±0.2% (full scale)				
0 to 55°C	±0.4% (full scale)						
Conversion time		250 μs/point					
Dimensions	12 (W) x 100 (H) x 71 (D)	Isolation method	Between the input and the NX bus: Power = Transformer, Signal = Digital isolator (no isolation between inputs)				
Insulation resistance	20 MΩ min. between isolated circuits (at 100 VDC)	Dielectric strength	510 VAC between isolated circuits for 1 minute at a leakage current of 5 mA max.				
I/O power supply method	Supply from the NX bus	Current capacity of I/O power supply terminal	IOV: 0.1 A/terminal max., IOG: 0.1 A/terminal max.				
NX Unit power consumption	0.90 W max.	Current consumption from I/O power supply	No consumption				
Weight	70 g max.						
Circuit layout							
Installation orientation and restrictions	Installation orientation: Possible in 6 orientations. Restrictions: No restrictions						
Terminal connection diagram							
Input disconnection detection	Supported						

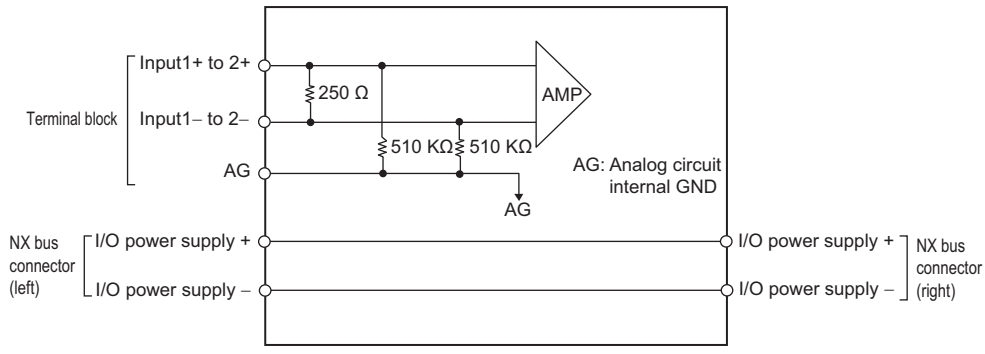
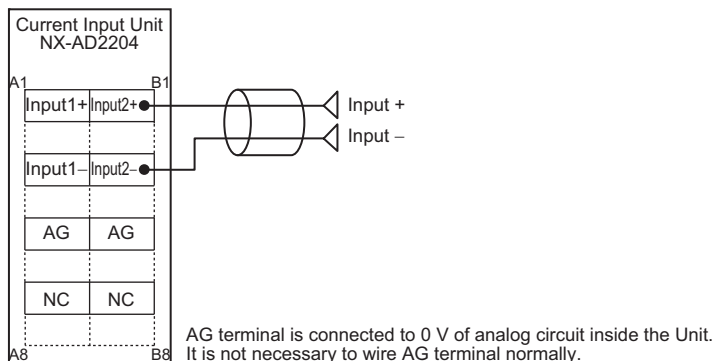
Unit name	Analog Input Unit (current input type)	Model	NX-AD2204	
Number of points	2 points	External connection terminals	Screwless clamping terminal block (8 terminals)	
I/O refreshing method	Free-Run refreshing			
Indicators	TS indicator 	Input method	Differential input	
		Input range	4 to 20 mA	
		Input conversion range	-5 to 105% (full-scale)	
		Absolute maximum rating	±30 mA	
		Input impedance	250 Ω	
		Resolution	1/8000 (full scale)	
		Over-all accuracy	25°C	±0.2% (full scale)
			0 to 55°C	±0.4% (full scale)
Conversion time	250 μs/point			
Dimensions	12 (W) x 100 (H) x 71 (D)	Isolation method	Between the input and the NX bus: Power = Transformer, Signal = Digital isolator (no isolation between inputs)	
Insulation resistance	20 MΩ min. between isolated circuits (at 100 VDC)	Dielectric strength	510 VAC between isolated circuits for 1 minute at a leakage current of 5 mA max.	
I/O power supply method	No supply	Current capacity of I/O power supply terminal	Without I/O power supply terminals	
NX Unit power consumption	0.90 W max.	Current consumption from I/O power supply	No consumption	
Weight	70 g max.			
Circuit layout				
Installation orientation and restrictions	Installation orientation: Possible in 6 orientations. Restrictions: No restrictions			
Terminal connection diagram	 <p>AG terminal is connected to 0 V of analog circuit inside the Unit. It is not necessary to wire AG terminal normally.</p>			
Input disconnection detection	Supported			

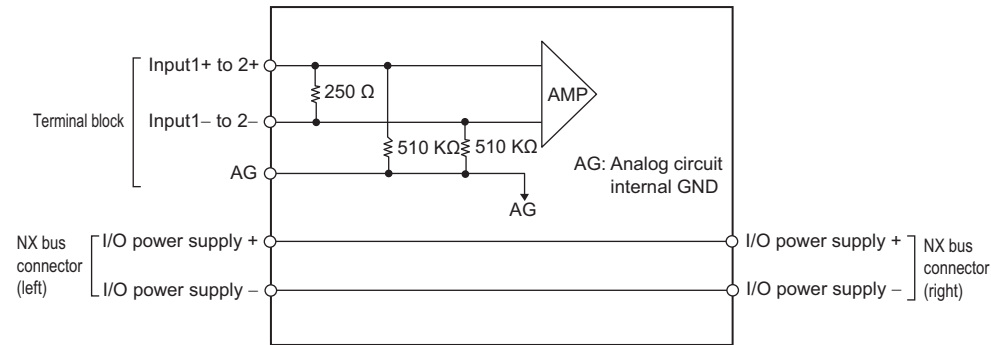
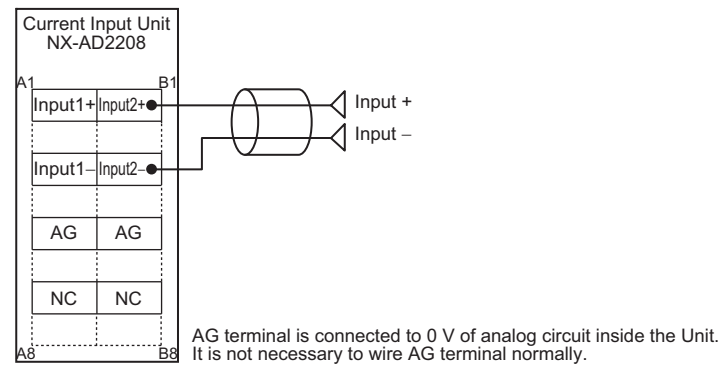
Unit name	Analog Input Unit (current input type)	Model	NX-AD2208
Number of points	2 points	External connection terminals	Screwless clamping terminal block (8 terminals)
I/O refreshing method	Switching synchronous I/O refreshing and Free-Run refreshing		
Indicators	TS indicator 	Input method	Differential input
		Input range	4 to 20 mA
		Input conversion range	-5 to 105% (full scale)
		Absolute maximum rating	±30 mA
		Input impedance	250 Ω
		Resolution	1/30000 (full scale)
			Over-all accuracy
		Conversion time	10 μs/point
Dimensions	12 (W) x 100 (H) x 71 (D)	Isolation method	Between the input and the NX bus: Power = Transformer, Signal = Digital isolator (no isolation between inputs)
Insulation resistance	20 MΩ min. between isolated circuits (at 100 VDC)	Dielectric strength	510 VAC between isolated circuits for 1 minute at a leakage current of 5 mA max.
I/O power supply method	No supply	Current capacity of I/O power supply terminal	Without I/O power supply terminals
NX Unit power consumption	0.90 W max.	Current consumption from I/O power supply	No consumption
Weight	70 g max.		
Circuit layout			
Installation orientation and restrictions	Installation orientation: Possible in 6 orientations. Restrictions: No restrictions		
Terminal connection diagram	 <p>AG terminal is connected to 0 V of analog circuit inside the Unit. It is not necessary to wire AG terminal normally.</p>		
Input disconnection detection	Supported		

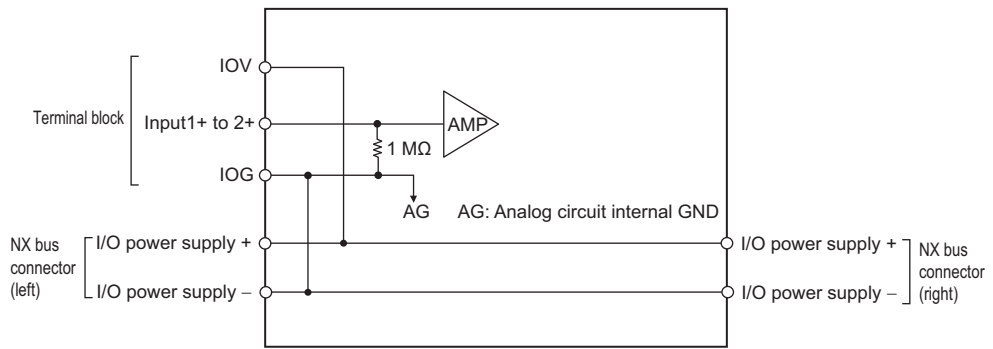
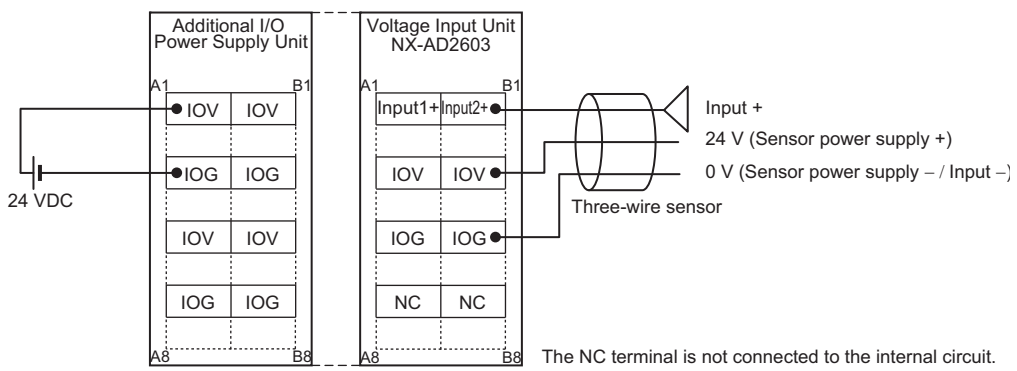
Unit name	Analog Input Unit (voltage input type)	Model	NX-AD2603
Number of points	2 points	External connection terminals	Screwless clamping terminal block (8 terminals)
I/O refreshing method	Free-Run refreshing		
Indicators	TS indicator 	Input method	Single-ended input
		Input range	-10 to +10 V
		Input conversion range	-5 to 105% (full scale)
		Absolute maximum rating	±15 V
		Input impedance	1 MΩ min.
		Resolution	1/8000 (full scale)
		Over-all accuracy	25°C
0 to 55°C	±0.4% (full scale)		
	Conversion time	250 μs/point	
Dimensions	12 (W) x 100 (H) x 71 (D)	Isolation method	Between the input and the NX bus: Power = Transformer, Signal = Digital isolator (no isolation between inputs)
Insulation resistance	20 MΩ min. between isolated circuits (at 100 VDC)	Dielectric strength	510 VAC between isolated circuits for 1 minute at a leakage current of 5 mA max.
I/O power supply method	Supply from the NX bus	Current capacity of I/O power supply terminal	IOV: 0.1 A/terminal max., IOG: 0.1 A/terminal max.
NX Unit power consumption	1.05 W max.	Current consumption from I/O power supply	No consumption
Weight	70 g max.		
Circuit layout			
Installation orientation and restrictions	Installation orientation: Possible in 6 orientations. Restrictions: No restrictions		
Terminal connection diagram	 <p>The NC terminal is not connected to the internal circuit.</p>		
Input disconnection detection	Not supported.		

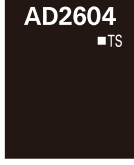
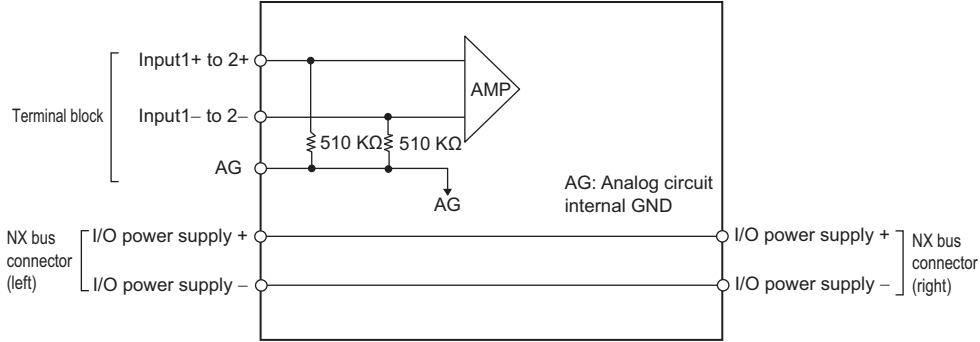
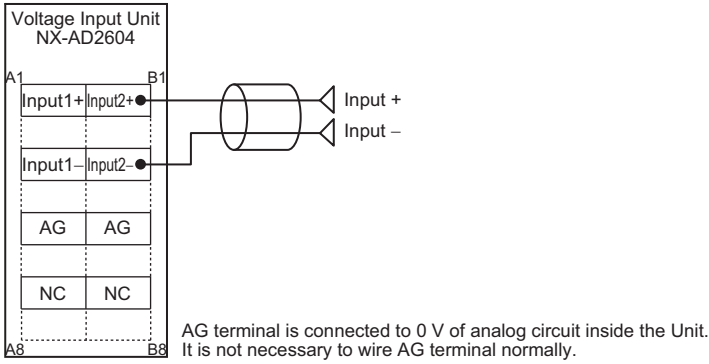
Unit name	Analog Input Unit (voltage input type)	Model	NX-AD2604	
Number of points	2 points	External connection terminals	Screwless clamping terminal block (8 terminals)	
I/O refreshing method	Free-Run refreshing			
Indicators	TS indicator 	Input method	Differential input	
		Input range	-10 to +10 V	
		Input conversion range	-5 to 105% (full scale)	
		Absolute maximum rating	±15 V	
		Input impedance	1 MΩ min.	
		Resolution	1/8000 (full scale)	
		Over-all accuracy	25°C	±0.2% (full scale)
			0 to 55°C	±0.4% (full scale)
Conversion time	250 μs/point			
Dimensions	12 (W) x 100 (H) x 71 (D)	Isolation method	Between the input and the NX bus: Power = Transformer, Signal = Digital isolator (no isolation between inputs)	
Insulation resistance	20 MΩ min. between isolated circuits (at 100 VDC)	Dielectric strength	510 VAC between isolated circuits for 1 minute at a leakage current of 5 mA max.	
I/O power supply method	No supply	Current capacity of I/O power supply terminal	Without I/O power supply terminals	
NX Unit power consumption	1.05 W max.	Current consumption from I/O power supply	No consumption	
Weight	70 g max.			
Circuit layout				
Installation orientation and restrictions	Installation orientation: Possible in 6 orientations. Restrictions: No restrictions			
Terminal connection diagram	 <p>AG terminal is connected to 0 V of analog circuit inside the Unit. It is not necessary to wire AG terminal normally.</p>			
Input disconnection detection	Not supported.			

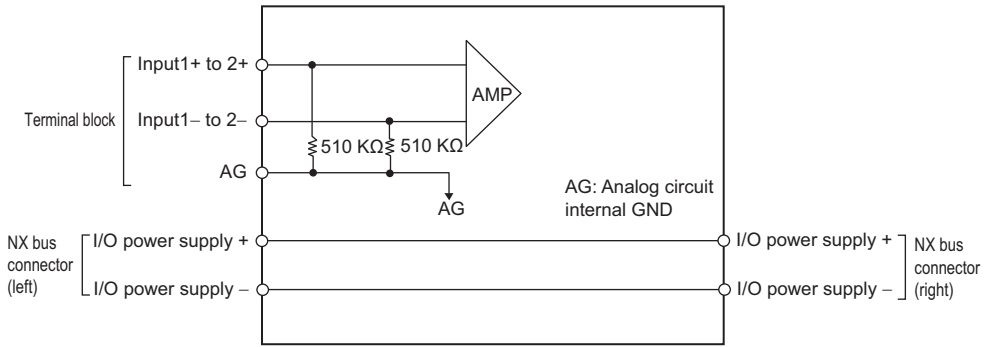
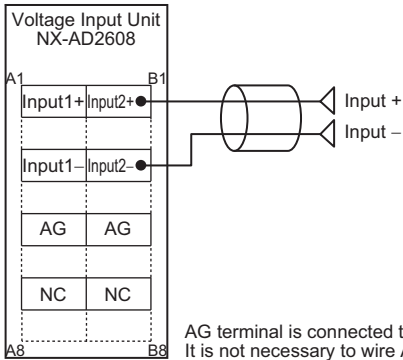
Unit name	Analog Input Unit (voltage input type)	Model	NX-AD2608	
Number of points	2 points	External connection terminals	Screwless clamping terminal block (8 terminals)	
I/O refreshing method	Switching synchronous I/O refreshing and Free-Run refreshing			
Indicators	TS indicator 	Input method	Differential input	
		Input range	-10 to +10 V	
		Input conversion range	-5 to 105% (full scale)	
		Absolute maximum rating	±15 V	
		Input impedance	1 MΩ min.	
		Resolution	1/30000 (full scale)	
		Over-all accuracy	25°C	±0.1% (full scale)
			0 to 55°C	±0.2% (full scale)
	Conversion time	10 μs/point		
Dimensions	12 (W) x 100 (H) x 71 (D)	Isolation method	Between the input and the NX bus: Power = Transformer, Signal = Digital isolator (no isolation between inputs)	
Insulation resistance	20 MΩ min. between isolated circuits (at 100 VDC)	Dielectric strength	510 VAC between isolated circuits for 1 minute at a leakage current of 5 mA max.	
I/O power supply method	No supply	Current capacity of I/O power supply terminal	Without I/O power supply terminals	
NX Unit power consumption	1.05 W max.	Current consumption from I/O power supply	No consumption	
Weight	70 g max.			
Circuit layout				
Installation orientation and restrictions	Installation orientation: Possible in 6 orientations. Restrictions: No restrictions			
Terminal connection diagram	 <p>AG terminal is connected to 0 V of analog circuit inside the Unit. It is not necessary to wire AG terminal normally.</p>			
Input disconnection detection	Not supported.			

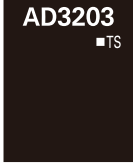
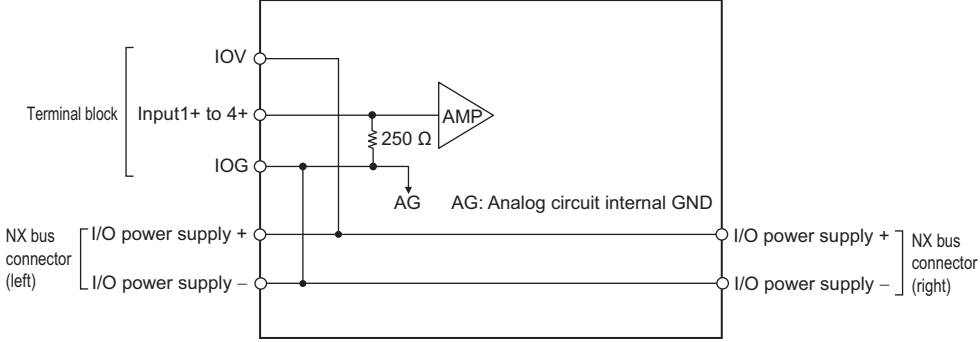
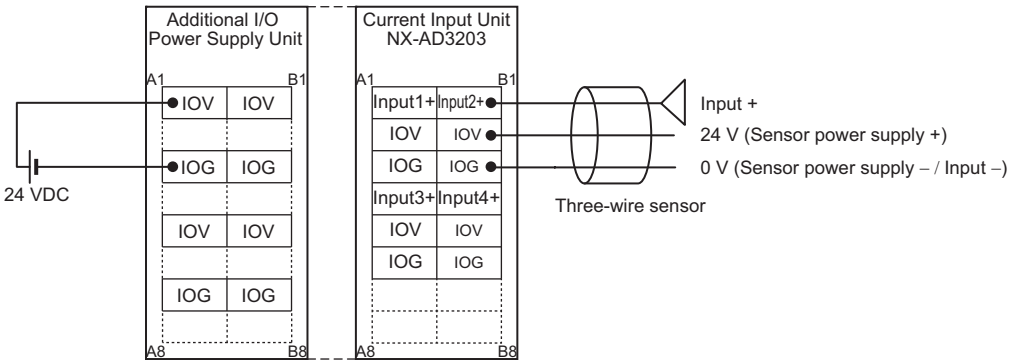
Unit name	Analog Input Unit (current input type)	Model	NX-AD3203	
Number of points	4 points	External connection terminals	Screwless clamping terminal block (12 terminals)	
I/O refreshing method	Free-Run refreshing			
Indicators	TS indicator 	Input method	Single-ended input	
		Input range	4 to 20 mA	
		Input conversion range	-5 to 105% (full scale)	
		Absolute maximum rating	±30 mA	
		Input impedance	250 Ω	
		Resolution	1/8000 (full scale)	
		Over-all accuracy	25°C	±0.2% (full scale)
			0 to 55°C	±0.4% (full scale)
Conversion time	250 μs/point			
Dimensions	12 (W) x 100 (H) x 71 (D)	Isolation method	Between the input and the NX bus: Power = Transformer, Signal = Digital isolator (no isolation between inputs)	
Insulation resistance	20 MΩ min. between isolated circuits (at 100 VDC)	Dielectric strength	510 VAC between isolated circuits for 1 minute at a leakage current of 5 mA max.	
I/O power supply method	Supply from the NX bus	Current capacity of I/O power supply terminal	IOV: 0.1 A/terminal max., IOG: 0.1 A/terminal max.	
NX Unit power consumption	0.90 W max.	Current consumption from I/O power supply	No consumption	
Weight	70 g max.			
Circuit layout				
Installation orientation and restrictions	Installation orientation: Possible in 6 orientations. Restrictions: No restrictions			
Terminal connection diagram				
Input disconnection detection	Supported			

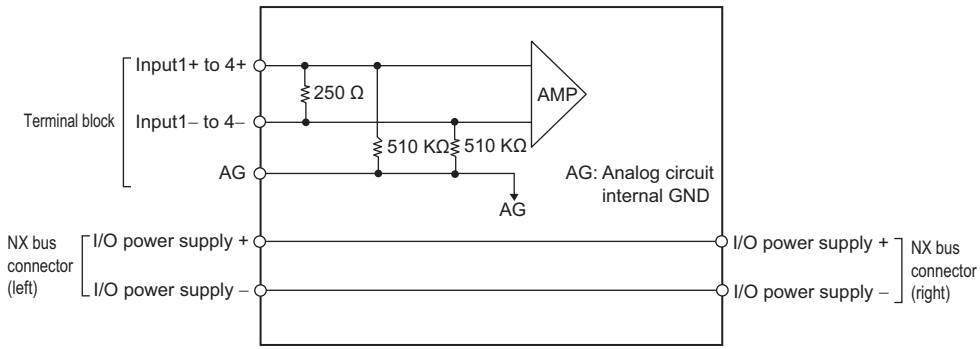
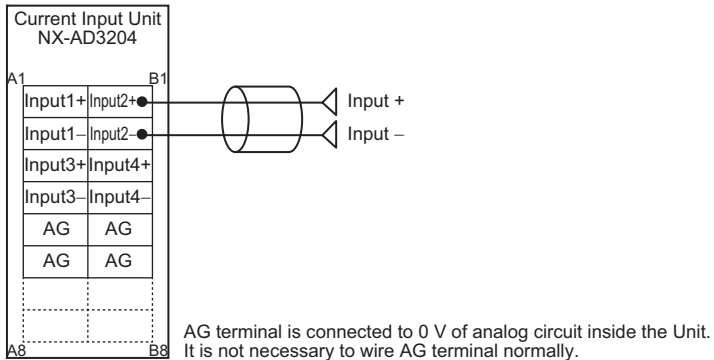
Unit name	Analog Input Unit (current input type)	Model	NX-AD3204	
Number of points	4 points	External connection terminals	Screwless clamping terminal block (12 terminals)	
I/O refreshing method	Free-Run refreshing			
Indicators	TS indicator 	Input method	Differential input	
		Input range	4 to 20 mA	
		Input conversion range	-5 to 105% (full scale)	
		Absolute maximum rating	±30 mA	
		Input impedance	250 Ω	
		Resolution	1/8000 (full scale)	
		Over-all accuracy	25°C	±0.2% (full scale)
			0 to 55°C	±0.4% (full scale)
Conversion time	250 μs/point			
Dimensions	12 (W) x 100 (H) x 71 (D)	Isolation method	Between the input and the NX bus: Power = Transformer, Signal = Digital isolator (no isolation between inputs)	
Insulation resistance	20 MΩ min. between isolated circuits (at 100 VDC)	Dielectric strength	510 VAC between isolated circuits for 1 minute at a leakage current of 5 mA max.	
I/O power supply method	No supply	Current capacity of I/O power supply terminal	Without I/O power supply terminals	
NX Unit power consumption	0.90 W max.	Current consumption from I/O power supply	No consumption	
Weight	70 g max.			
Circuit layout				
Installation orientation and restrictions	Installation orientation: Possible in 6 orientations. Restrictions: No restrictions			
Terminal connection diagram	 <p>AG terminal is connected to 0 V of analog circuit inside the Unit. It is not necessary to wire AG terminal normally.</p>			
Input disconnection detection	Supported			

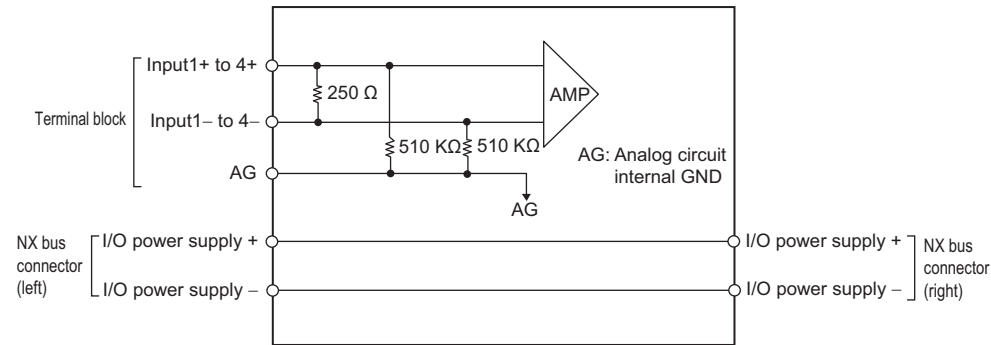
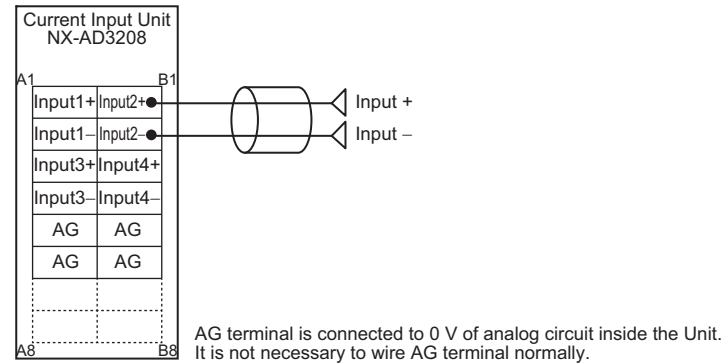
Unit name	Analog Input Unit (current input type)	Model	NX-AD3208	
Number of points	4 points	External connection terminals	Screwless clamping terminal block (12 terminals)	
I/O refreshing method	Switching synchronous I/O refreshing and Free-Run refreshing			
Indicators	TS indicator 	Input method	Differential input	
		Input range	4 to 20 mA	
		Input conversion range	-5 to 105% (full scale)	
		Absolute maximum rating	±30 mA	
		Input impedance	250 Ω	
		Resolution	1/30000 (full scale)	
		Over-all accuracy	25°C	±0.1% (full scale)
			0 to 55°C	±0.2% (full scale)
Conversion time	10 μs/point			
Dimensions	12 (W) x 100 (H) x 71 (D)	Isolation method	Between the input and the NX bus: Power = Transformer, Signal = Digital isolator (no isolation between inputs)	
Insulation resistance	20 MΩ min. between isolated circuits (at 100 VDC)	Dielectric strength	510 VAC between isolated circuits for 1 minute at a leakage current of 5 mA max.	
I/O power supply method	No supply	Current capacity of I/O power supply terminal	Without I/O power supply terminals	
NX Unit power consumption	0.95 W max.	Current consumption from I/O power supply	No consumption	
Weight	70 g max.			
Circuit layout				
Installation orientation and restrictions	Installation orientation: Possible in 6 orientations. Restrictions: No restrictions			
Terminal connection diagram				
Input disconnection detection	Supported			

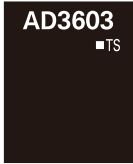
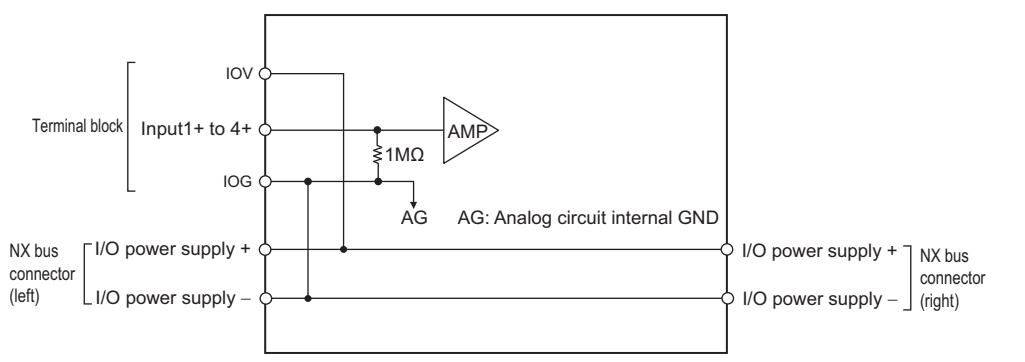
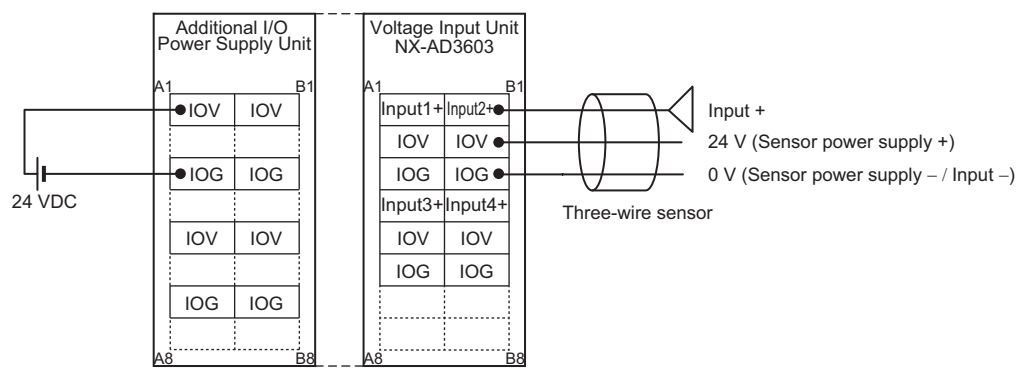
Unit name	Analog Input Unit (voltage input type)	Model	NX-AD3603	
Number of points	4 points	External connection terminals	Screwless clamping terminal block (12 terminals)	
I/O refreshing method	Free-Run refreshing			
Indicators	TS indicator 	Input method	Single-ended input	
		Input range	-10 to +10 V	
		Input conversion range	-5 to 105% (full scale)	
		Absolute maximum rating	±15 V	
		Input impedance	1 MΩ min.	
		Resolution	1/8000 (full scale)	
		Over-all accuracy	25°C	±0.2% (full scale)
			0 to 55°C	±0.4% (full scale)
Conversion time	250 μs/point			
Dimensions	12 (W) x 100 (H) x 71 (D)	Isolation method	Between the input and the NX bus: Power = Transformer, Signal = Digital isolator (no isolation between inputs)	
Insulation resistance	20 MΩ min. between isolated circuits (at 100 VDC)	Dielectric strength	510 VAC between isolated circuits for 1 minute at a leakage current of 5 mA max.	
I/O power supply method	Supply from the NX bus	Current capacity of I/O power supply terminal	IOV: 0.1 A/terminal max., IOG: 0.1 A/terminal max.	
NX Unit power consumption	1.10 W max.	Current consumption from I/O power supply	No consumption	
Weight	70 g max.			
Circuit layout				
Installation orientation and restrictions	Installation orientation: Possible in 6 orientations. Restrictions: No restrictions			
Terminal connection diagram				
Input disconnection detection	Not supported.			

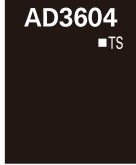
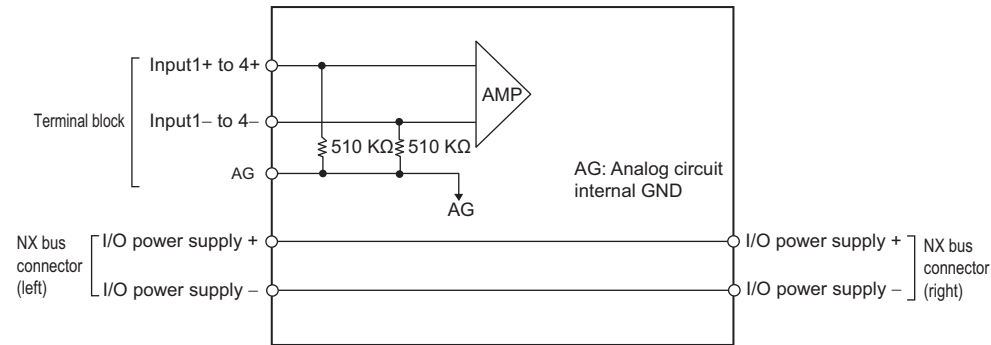
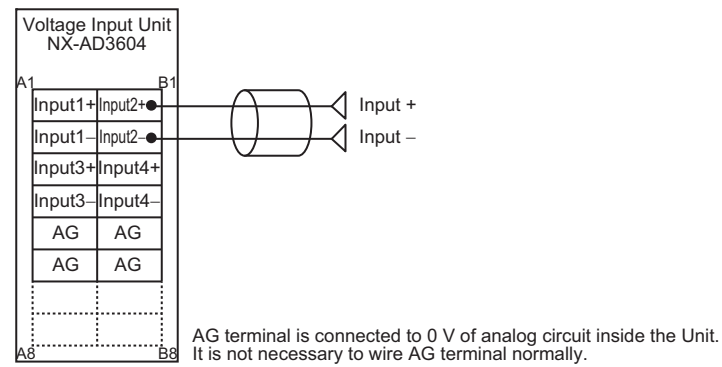
Unit name	Analog Input Unit (voltage input type)	Model	NX-AD3604	
Number of points	4 points	External connection terminals	Screwless clamping terminal block (12 terminals)	
I/O refreshing method	Free-Run refreshing			
Indicators	TS indicator 	Input method	Differential input	
		Input range	-10 to +10 V	
		Input conversion range	-5 to 105% (full scale)	
		Absolute maximum rating	±15 V	
		Input impedance	1 MΩ min.	
		Resolution	1/8000 (full scale)	
		Over-all accuracy	25°C	±0.2% (full scale)
			0 to 55°C	±0.4% (full scale)
Conversion time	250 μs/point			
Dimensions	12 (W) x 100 (H) x 71 (D)	Isolation method	Between the input and the NX bus: Power = Transformer, Signal = Digital isolator (no isolation between inputs)	
Insulation resistance	20 MΩ min. between isolated circuits (at 100 VDC)	Dielectric strength	510 VAC between isolated circuits for 1 minute at a leakage current of 5 mA max.	
I/O power supply method	No supply	Current capacity of I/O power supply terminal	Without I/O power supply terminals	
NX Unit power consumption	1.10 W max.	Current consumption from I/O power supply	No consumption	
Weight	70 g max.			
Circuit layout				
Installation orientation and restrictions	Installation orientation: Possible in 6 orientations. Restrictions: No restrictions			
Terminal connection diagram	 <p>AG terminal is connected to 0 V of analog circuit inside the Unit. It is not necessary to wire AG terminal normally.</p>			
Input disconnection detection	Not supported.			

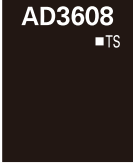
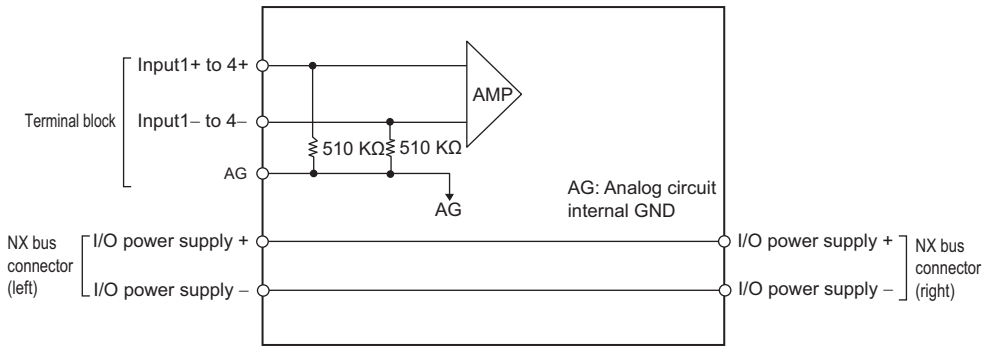
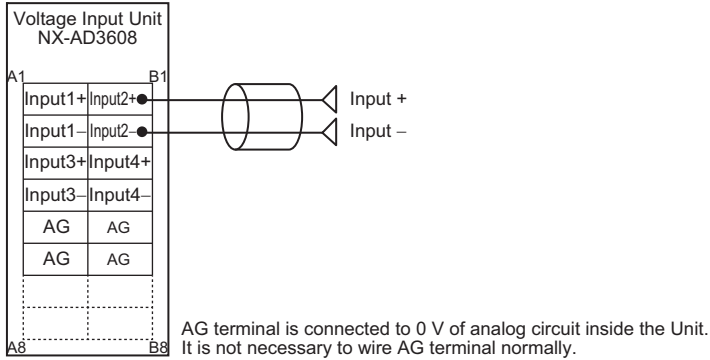
Unit name	Analog Input Unit (voltage input type)	Model	NX-AD3608	
Number of points	4 points	External connection terminals	Screwless clamping terminal block (12 terminals)	
I/O refreshing method	Switching synchronous I/O refreshing and Free-Run refreshing			
Indicators	TS indicator 	Input method	Differential input	
		Input range	-10 to +10 V	
		Input conversion range	-5 to 105% (full scale)	
		Absolute maximum rating	±15 V	
		Input impedance	1 MΩ min.	
		Resolution	1/30000 (full scale)	
		Over-all accuracy	25°C	±0.1% (full scale)
			0 to 55°C	±0.2% (full scale)
	Conversion time	10 μs/point		
Dimensions	12 (W) x 100 (H) x 71 (D)	Isolation method	Between the input and the NX bus: Power = Transformer, Signal = Digital isolator (no isolation between inputs)	
Insulation resistance	20 MΩ min. between isolated circuits (at 100 VDC)	Dielectric strength	510 VAC between isolated circuits for 1 minute at a leakage current of 5 mA max.	
I/O power supply method	No supply	Current capacity of I/O power supply terminal	Without I/O power supply terminals	
NX Unit power consumption	1.10 W max.	Current consumption from I/O power supply	No consumption	
Weight	70 g max.			
Circuit layout				
Installation orientation and restrictions	Installation orientation: Possible in 6 orientations. Restrictions: No restrictions			
Terminal connection diagram	 <p>AG terminal is connected to 0 V of analog circuit inside the Unit. It is not necessary to wire AG terminal normally.</p>			
Input disconnection detection	Not supported.			

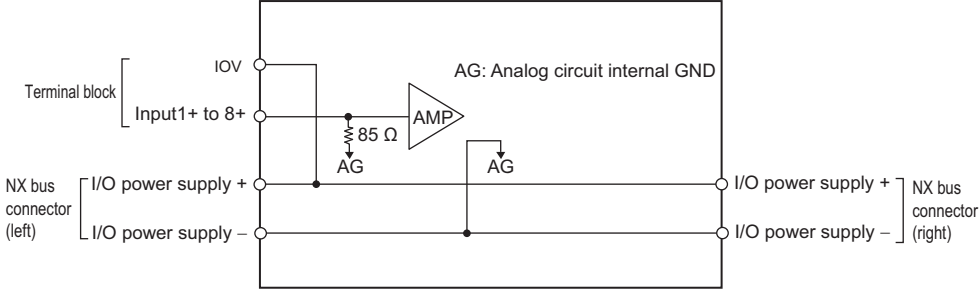
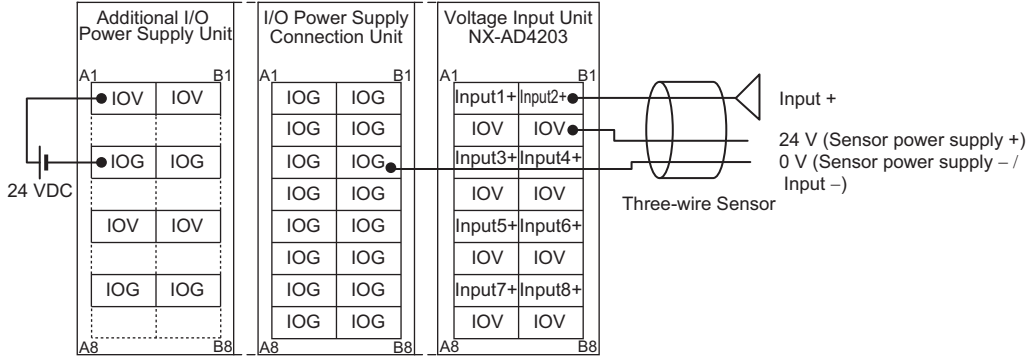
Unit name	Analog Input Unit (current input type)	Model	NX-AD4203	
Number of points	8 points	External connection terminals	Screwless clamping terminal block (16 terminals)	
I/O refreshing method	Free-Run refreshing			
Indicators	TS indicator 	Input method	Single-ended input	
		Input range	4 to 20 mA	
		Input conversion range	-5 to 105% (full scale)	
		Absolute maximum rating	±30 mA	
		Input impedance	85 Ω	
		Resolution	1/8000 (full scale)	
		Over-all accuracy	25°C	±0.2% (full scale)
			0 to 55°C	±0.4% (full scale)
Conversion time	250 μs/point			
Dimensions	12 (W) x 100 (H) x 71 (D)	Isolation method	Between the input and the NX bus: Power = Transformer, Signal = Digital isolator (no isolation between inputs)	
Insulation resistance	20 MΩ min. between isolated circuits (at 100 VDC)	Dielectric strength	510 VAC between isolated circuits for 1 minute at a leakage current of 5 mA max.	
I/O power supply method	Supply from the NX bus	Current capacity of I/O power supply terminal	IOV: 0.1 A/terminal max.	
NX Unit power consumption	1.05 W max.	Current consumption from I/O power supply	No consumption	
Weight	70 g max.			
Circuit layout				
Installation orientation and restrictions	Installation orientation: Possible in 6 orientations. Restrictions: No restrictions			
Terminal connection diagram				
Input disconnection detection	Supported			

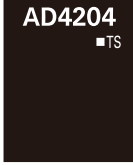
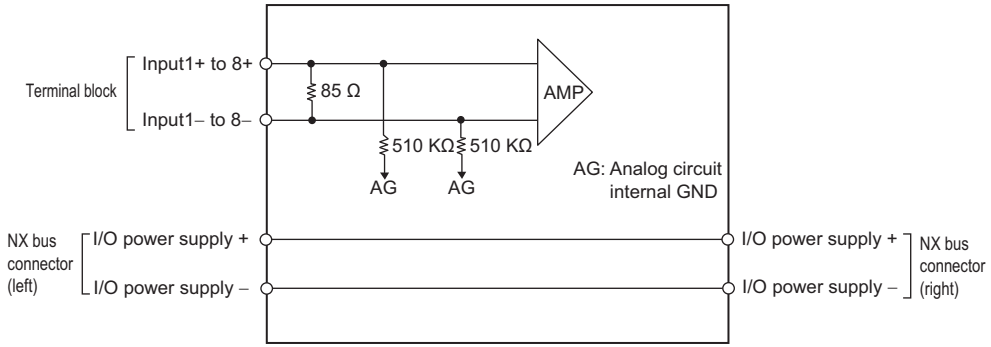
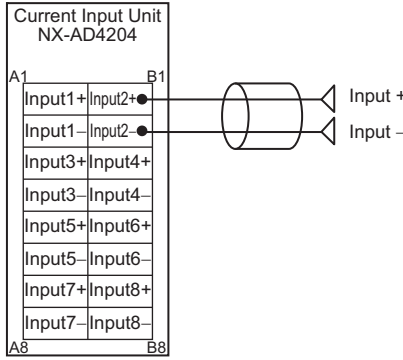
Unit name	Analog Input Unit (current input type)	Model	NX-AD4204	
Number of points	8 points	External connection terminals	Screwless clamping terminal block (16 terminals)	
I/O refreshing method	Free-Run refreshing			
Indicators	TS indicator 	Input method	Differential input	
		Input range	4 to 20 mA	
		Input conversion range	-5 to 105% (full scale)	
		Absolute maximum rating	±30 mA	
		Input impedance	85 Ω	
		Resolution	1/8000 (full scale)	
		Over-all accuracy	25°C	±0.2% (full scale)
			0 to 55°C~	±0.4% (full scale)
Conversion time	250 μs/point			
Dimensions	12 (W) x 100 (H) x 71 (D)	Isolation method	Between the input and the NX bus: Power = Transformer, Signal = Digital isolator (no isolation between inputs)	
Insulation resistance	20 MΩ min. between isolated circuits (at 100 VDC)	Dielectric strength	510 VAC between isolated circuits for 1 minute at a leakage current of 5 mA max.	
I/O power supply method	No supply	Current capacity of I/O power supply terminal	Without I/O power supply terminals	
NX Unit power consumption	1.05 W max.	Current consumption from I/O power supply	No consumption	
Weight	70 g max.			
Circuit layout				
Installation orientation and restrictions	Installation orientation: Possible in 6 orientations. Restrictions: No restrictions			
Terminal connection diagram				
Input disconnection detection	Supported			

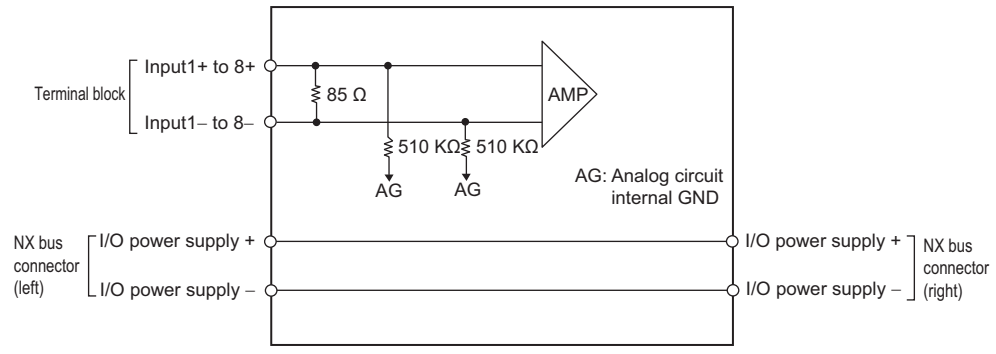
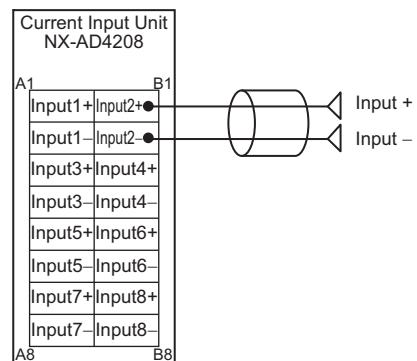
Unit name	Analog Input Unit (current input type)	Model	NX-AD4208	
Number of points	8 points	External connection terminals	Screwless clamping terminal block (16 terminals)	
I/O refreshing method	Switching synchronous I/O refreshing and Free-Run refreshing			
Indicators	TS indicator 	Input method	Differential input	
		Input range	4 to 20 mA	
		Input conversion range	-5 to 105% (full scale)	
		Absolute maximum rating	±30 mA	
		Input impedance	85 Ω	
		Resolution	1/30000 (full scale)	
		Over-all accuracy	25°C	±0.1% (full scale)
			0 to 55°C	±0.2% (full scale)
Conversion time	10 μs/point			
Dimensions	12 (W) x 100 (H) x 71 (D)	Isolation method	Between the input and the NX bus: Power = Transformer, Signal = Digital isolator (no isolation between inputs)	
Insulation resistance	20 MΩ min. between isolated circuits (at 100 VDC)	Dielectric strength	510 VAC between isolated circuits for 1 minute at a leakage current of 5 mA max.	
I/O power supply method	No supply	Current capacity of I/O power supply terminal	Without I/O power supply terminals	
NX Unit power consumption	1.10 W max.	Current consumption from I/O power supply	No consumption	
Weight	70 g max.			
Circuit layout				
Installation orientation and restrictions	Installation orientation: Possible in 6 orientations. Restrictions: No restrictions			
Terminal connection diagram				
Input disconnection detection	Supported			

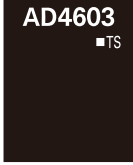
Unit name	Analog Input Unit (voltage input type)	Model	NX-AD4603	
Number of points	8 points	External connection terminals	Screwless clamping terminal block (16 terminals)	
I/O refreshing method	Free-Run refreshing			
Indicators	TS indicator 	Input method	Single-ended input	
		Input range	-10 to +10 V	
		Input conversion range	-5 to 105% (full scale)	
		Absolute maximum rating	±15 V	
		Input impedance	1 MΩ min.	
		Resolution	1/8000 (full scale)	
		Over-all accuracy	25°C	±0.2% (full scale)
			0 to 55°C	±0.4% (full scale)
Conversion time	250 μs/point			
Dimensions	12 (W) x 100 (H) x 71 (D)		Isolation method	Between the input and the NX bus: Power = Transformer, Signal = Digital isolator (no isolation between inputs)
Insulation resistance	20 MΩ min. between isolated circuits (at 100 VDC)		Dielectric strength	510 VAC between isolated circuits for 1 minute at a leakage current of 5 mA max.
I/O power supply method	Supply from the NX bus		Current capacity of I/O power supply terminal	I/O: 0.1 A/terminal max.
NX Unit power consumption	1.15 W max.		Current consumption from I/O power supply	No consumption
Weight	70 g max.			

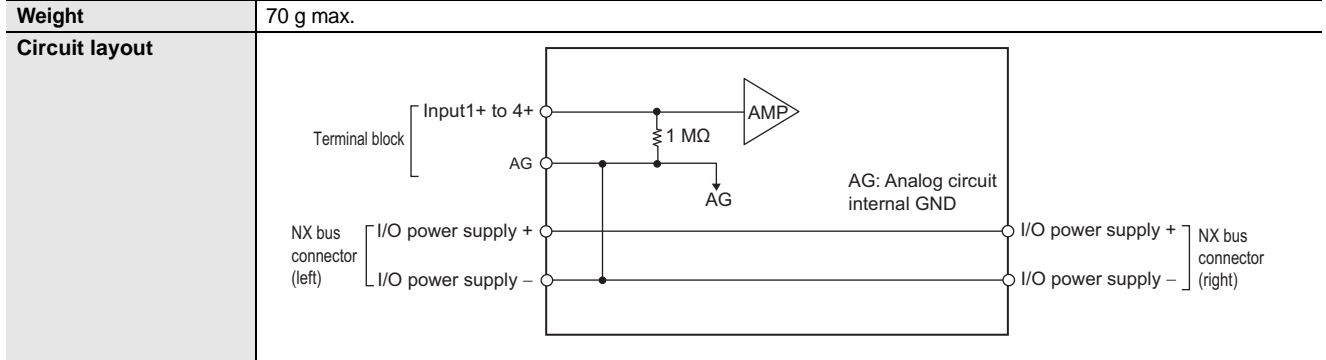

Installation orientation and restrictions
 Installation orientation: Possible in 6 orientations.
 Restrictions: No restrictions

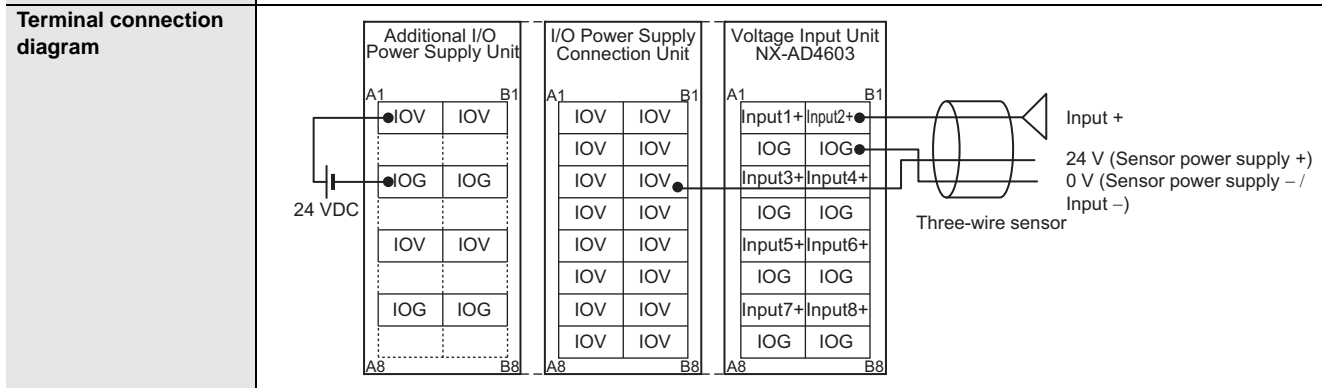

Input disconnection detection
 Not supported.

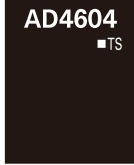
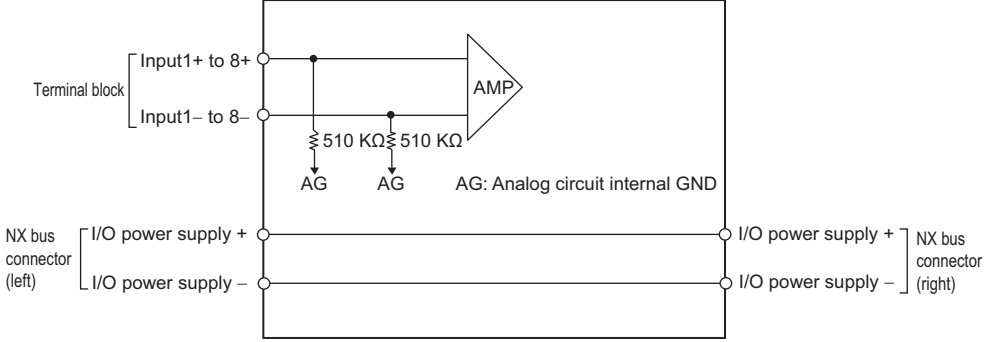
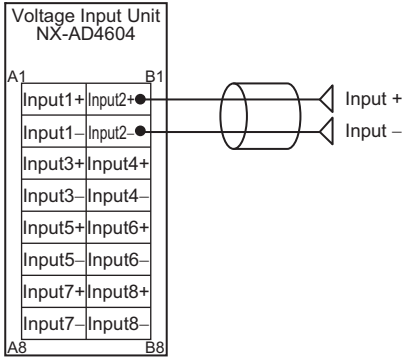
Unit name	Analog Input Unit (voltage input type)	Model	NX-AD4604	
Number of points	8 points	External connection terminals	Screwless clamping terminal block (16 terminals)	
I/O refreshing method	Free-Run refreshing			
Indicators	TS indicator 	Input method	Differential input	
		Input range	-10 to +10 V	
		Input conversion range	-5 to 105% (full scale)	
		Absolute maximum rating	±15 V	
		Input impedance	1 MΩ min.	
		Resolution	1/8000 (full scale)	
		Over-all accuracy	25°C	±0.2% (full scale)
			0 to 55°C	±0.4% (full scale)
Conversion time	250 μs/point			
Dimensions	12 (W) x 100 (H) x 71 (D)	Isolation method	Between the input and the NX bus: Power = Transformer, Signal = Digital isolator (no isolation between inputs)	
Insulation resistance	20 MΩ min. between isolated circuits (at 100 VDC)	Dielectric strength	510 VAC between isolated circuits for 1 minute at a leakage current of 5 mA max.	
I/O power supply method	No supply	Current capacity of I/O power supply terminal	Without I/O power supply terminals	
NX Unit power consumption	1.15 W max.	Current consumption from I/O power supply	No consumption	
Weight	70 g max.			
Circuit layout				
Installation orientation and restrictions	Installation orientation: Possible in 6 orientations. Restrictions: No restrictions			
Terminal connection diagram				
Input disconnection detection	Not supported.			

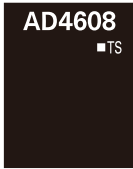
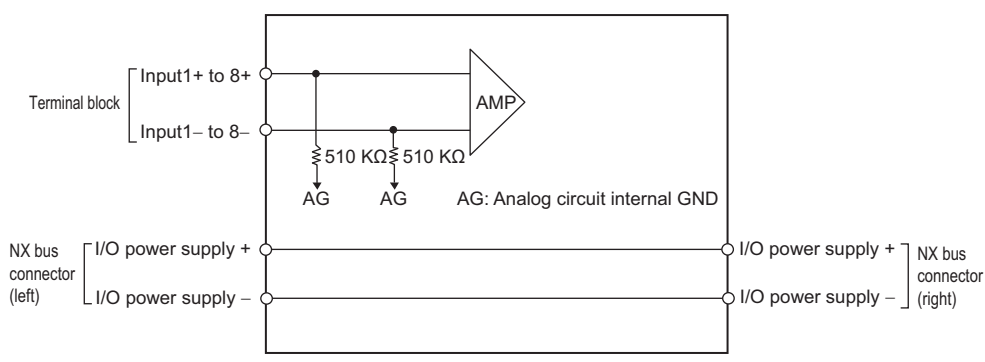
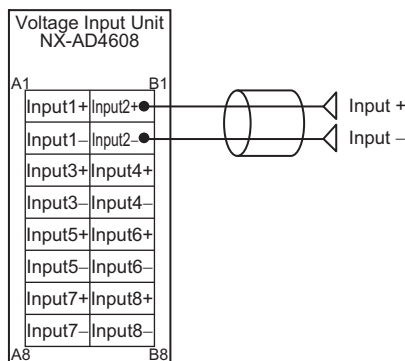
Unit name	Analog Input Unit (voltage input type)	Model	NX-AD4608	
Number of points	8 points	External connection terminals	Screwless clamping terminal block (16 terminals)	
I/O refreshing method	Switching synchronous I/O refreshing and Free-Run refreshing			
Indicators	TS indicator 	Input method	Differential input	
		Input range	-10 to +10 V	
		Input conversion range	-5 to 105% (full scale)	
		Absolute maximum rating	±15 V	
		Input impedance	1 MΩ min.	
		Resolution	1/30000 (full scale)	
		Over-all accuracy	25°C	±0.1% (full scale)
			0 to 55°C	±0.2% (full scale)
Conversion time	10 μs/point			
Dimensions	12 (W) x 100 (H) x 71 (D)	Isolation method	Between the input and the NX bus: Power = Transformer, Signal = Digital isolator (no isolation between inputs)	
Insulation resistance	20 MΩ min. between isolated circuits (at 100 VDC)	Dielectric strength	510 VAC between isolated circuits for 1 minute at a leakage current of 5 mA max.	
I/O power supply method	No supply	Current capacity of I/O power supply terminal	Without I/O power supply terminals	
NX Unit power consumption	1.15 W max.	Current consumption from I/O power supply	No consumption	
Weight	70 g max.			
Circuit layout				
Installation orientation and restrictions	Installation orientation: Possible in 6 orientations. Restrictions: No restrictions			
Terminal connection diagram				
Input disconnection detection	Not supported.			

A-1-3 Analog Output Units

Description of Items on the Data Sheet of the Analog Output Unit

The meanings of the items on the data sheet of the Analog Output Unit are explained in the table below.

Item	Description
Unit name	The name of the Unit.
Model	The model of the Unit.
Number of points	The number of analog output points provided by the Unit.
External connection terminals	The type of terminal block and connector that is used for connecting the Unit. The number of terminals on the terminal block is also described when a screwless clamping terminal block is used.
I/O refreshing method	The I/O refreshing methods that are used by the Unit. Free-Run refreshing and synchronous I/O refreshing are available.
Indicators	The type of indicators on the Unit and the layout of those indicators.
Output range	The output range of the Unit.
Output conversion range	The conversion range from the converted values of the Unit to analog output signals for the full scale. Output converted values range is fixed to the conversion limit value.
Allowable load resistance	The resistance value of external load that can be connected to the Unit. The minimum value is written for voltage output and the maximum value is written for current output.
Output impedance	The output impedance of the Unit.
Resolution	The resolution of converted values of the Unit.
Overall accuracy	The conversion accuracy of analog outputs of the Unit. It is defined under the conditions of 25°C and 0 to 55°C.
Conversion time	The time required to convert output set values of the Unit to the analog output signals.
Dimensions	The dimensions of the Unit. They are described as W x H x D. The unit is "mm".
Isolation method	The isolation method between the output circuits and internal circuits and between the output circuits of the Unit.
Insulation resistance	The insulation resistance between the output circuits and internal circuits and between the output circuits of the Unit.
Dielectric strength	The dielectric strength between the output circuits and internal circuits and between the output circuits of the Unit.
I/O power supply method	The method for supplying I/O power for the Unit. The supply method is determined for each Unit. The power is supplied from the NX bus or the external source.
Current capacity of I/O power supply terminal	The current capacity of the I/O power supply terminals (IOV/IOG) of the Unit. Do not exceed this value when supplying the I/O power to the connected external devices.
NX Unit power consumption	The power consumption of the NX Unit power supply of the Unit.
Current consumption from I/O power supply	The current consumption from I/O power supply of the Unit. The above input current and current consumption of any connected external devices are excluded.
Weight	The weight of the Unit.
Circuit layout	The output circuit layout of the Unit.
Installation orientation and restrictions	The installation orientation of the Slave Terminal including the Unit, and the details of restrictions on the specifications due to the installation orientation.
Terminal connection diagram	A diagram of the connection between the Unit and connected external devices. When an I/O Power Supply Connection Unit or a Shield Connection Unit is required to be connected to the connected external devices, the description for such is included.

Analog Output Units (Screwless Clamping Terminal Block, 12 mm Width)

Unit name	Analog Output Unit (current output type)	Model	NX-DA2203	
Number of points	2 points	External connection terminals	Screwless clamping terminal block (8 terminals)	
I/O refreshing method	Free-Run refreshing			
Indicators	TS indicator 	Output range	4 to 20 mA	
		Output conversion range	-5 to 105% (full scale)	
		Allowable load resistance	600 Ω max.	
		Resolution	1/8000 (full scale)	
		Over-all accuracy	25°C	±0.3% (full scale)
			0 to 55°C	±0.6% (full scale)
	Conversion time	250 μs/point		
Dimensions	12 (W) x 100 (H) x 71 (D)	Isolation method	Between the input and the NX bus: Power = Transformer, Signal = Digital isolator (no isolation between inputs)	
Insulation resistance	20 MΩ min. between isolated circuits (at 100 VDC)	Dielectric strength	510 VAC between isolated circuits for 1 minute at a leakage current of 5 mA max.	
I/O power supply method	Supply from the NX bus	Current capacity of I/O power supply terminal	IOV: 0.1 A/terminal max., IOG: 0.1 A/terminal max.	
NX Unit power consumption	1.75 W max.	Current consumption from I/O power supply	No consumption	
Weight	70 g max.			

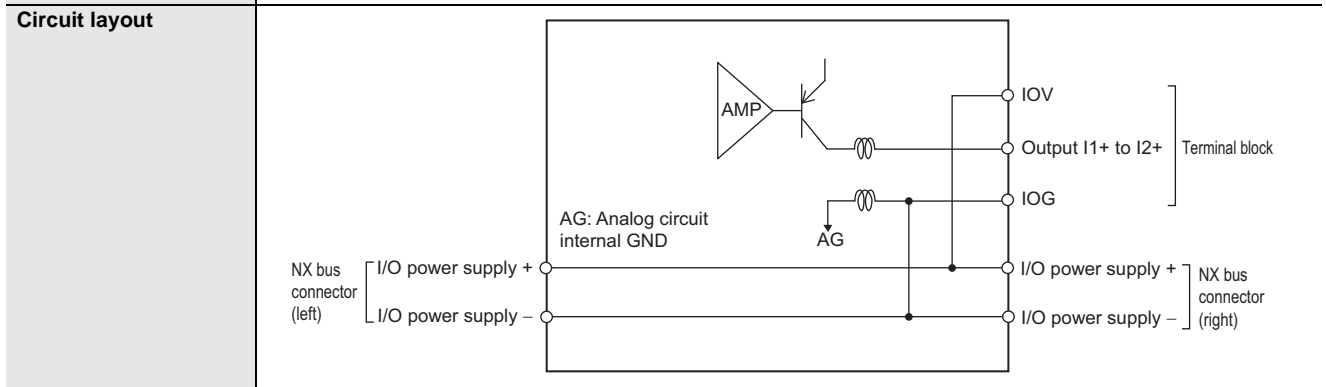

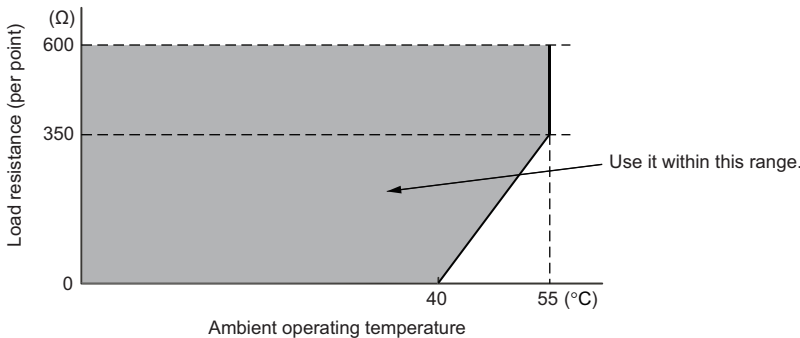

Installation orientation and restrictions

Installation orientation: Possible in 6 orientations.
 Restrictions:
 For upright installation: No restrictions
 For any installation other than upright: Restricted as shown in the graph below.

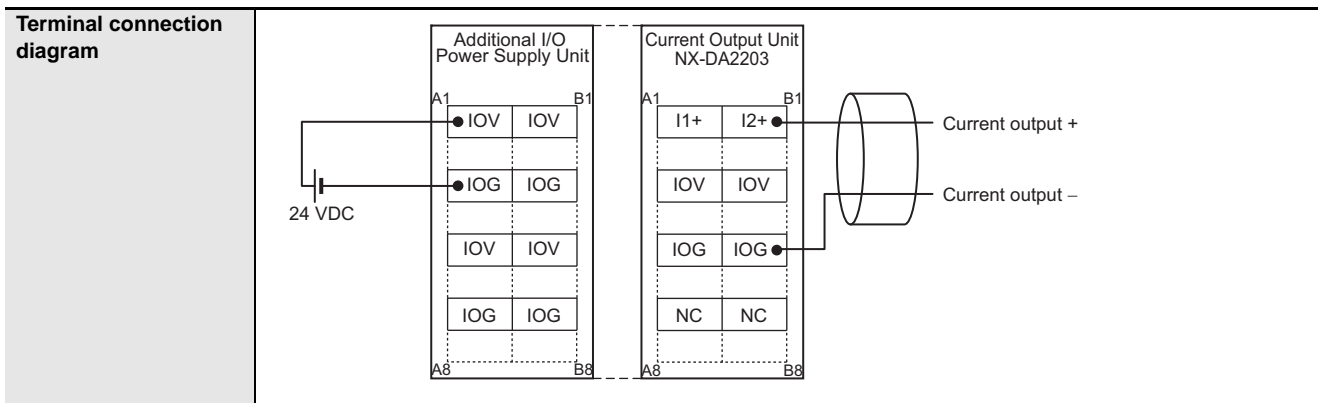

The graph plots Load resistance (per point) in Ohms (Ω) on the y-axis (0 to 600) against Ambient operating temperature in degrees Celsius (°C) on the x-axis (0 to 55). A shaded region indicates the acceptable operating range, which is constant at 600 Ω up to 40°C and then decreases linearly to 350 Ω at 55°C. An arrow points to this shaded region with the text 'Use it within this range.'



Unit name	Analog Output Unit (current output type)	Model	NX-DA2205	
Number of points	2 points	External connection terminals	Screwless clamping terminal block (8 terminals)	
I/O refreshing method	Switching synchronous I/O refreshing and Free-Run refreshing			
Indicators	TS indicator 	Output range	4 to 20 mA	
		Output conversion range	-5 to 105% (full scale)	
		Allowable load resistance	600 Ω max.	
		Resolution	1/30000 (full scale)	
		Overall accuracy	25°C	±0.1% (full scale)
			0 to 55°C	±0.3% (full scale)
	Conversion time	10 μs/point		
Dimensions	12 (W) x 100 (H) x 71 (D)	Isolation method	Between the input and the NX bus: Power = Transformer, Signal = Digital isolator (no isolation between inputs)	
Insulation resistance	20 MΩ min. between isolated circuits (at 100 VDC)	Dielectric strength	510 VAC between isolated circuits for 1 minute at a leakage current of 5 mA max.	
I/O power supply method	Supply from the NX bus	Current capacity of I/O power supply terminal	IOV: 0.1 A/terminal max., IOG: 0.1 A/terminal max.	
NX Unit power consumption	1.75 W max.	Current consumption from I/O power supply	No consumption	
Weight	70 g max.			

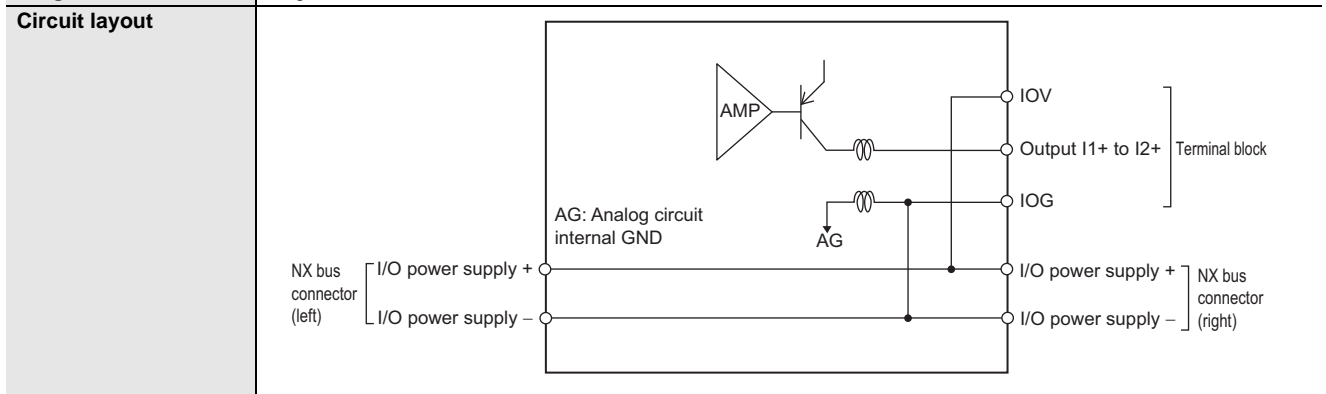

Installation orientation and restrictions

Installation orientation: Possible in 6 orientations.

Restrictions:

For upright installation: No restrictions

For any installation other than upright: Restricted as shown in the graph below.

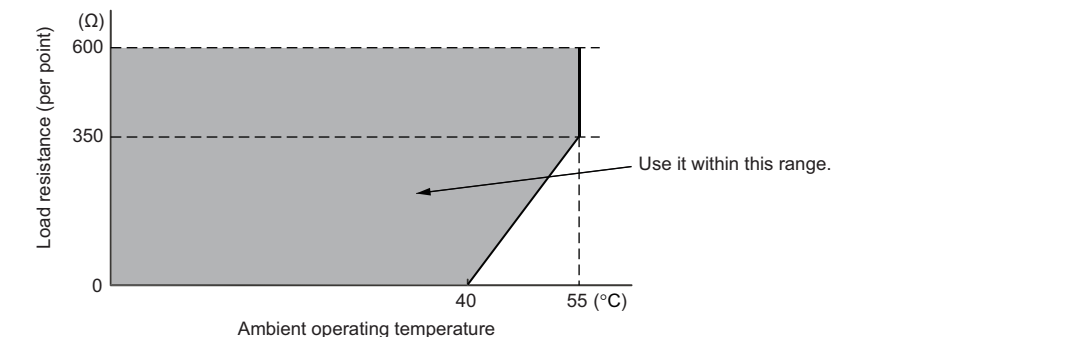

The graph shows the relationship between load resistance and ambient operating temperature. The y-axis represents Load resistance (per point) in Ohms (Ω), ranging from 0 to 600. The x-axis represents Ambient operating temperature in degrees Celsius (°C), ranging from 0 to 55. A shaded region indicates the allowable load resistance range, which is constant at 600 Ω up to 40°C and then decreases linearly to 350 Ω at 55°C. An arrow points to this shaded region with the text "Use it within this range."

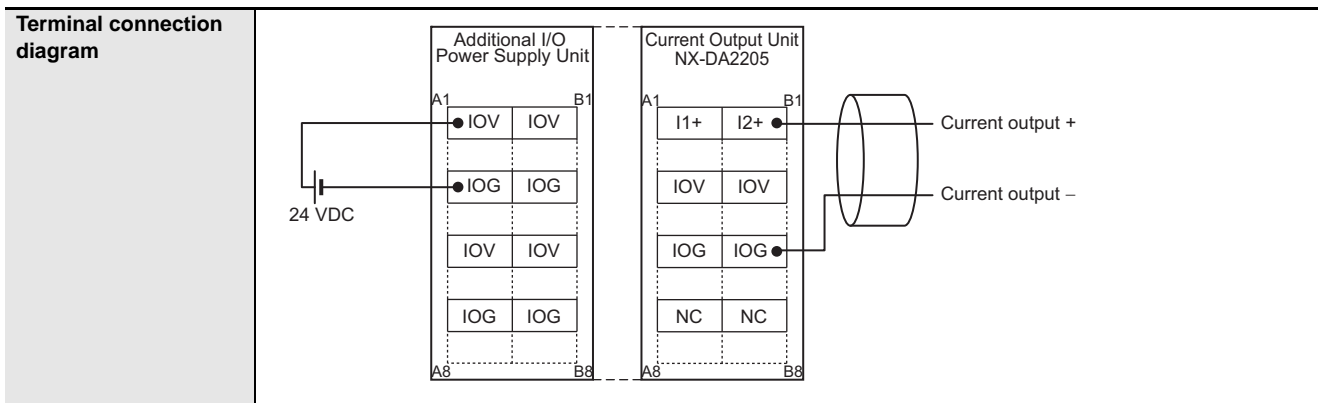

Unit name	Analog Output Unit (voltage output type)	Model	NX-DA2603	
Number of points	2 points	External connection terminals	Screwless clamping terminal block (8 terminals)	
I/O refreshing method	Free-Run refreshing			
Indicators	TS indicator 	Output range	-10 to +10 V	
		Output conversion range	-5 to 105% (full scale)	
		Allowable load resistance	5 kΩ min.	
		Output impedance	0.5 Ω max.	
		Resolution	1/8000 (full scale)	
		Over-all accuracy	25°C	±0.3% (full scale)
			0 to 55°C	±0.5% (full scale)
	Conversion time	250 μs/point		
Dimensions	12 (W) x 100 (H) x 71 (D)	Isolation method	Between the input and the NX bus: Power = Transformer, Signal = Digital isolator (no isolation between inputs)	
Insulation resistance	20 MΩ min. between isolated circuits (at 100 VDC)	Dielectric strength	510 VAC between isolated circuits for 1 minute at a leakage current of 5 mA max.	
I/O power supply method	Supply from the NX bus	Current capacity of I/O power supply terminal	IOV: 0.1 A/terminal max., IOG: 0.1 A/terminal max.	
NX Unit power consumption	1.10 W max.	Current consumption from I/O power supply	No consumption	
Weight	70 g max.			

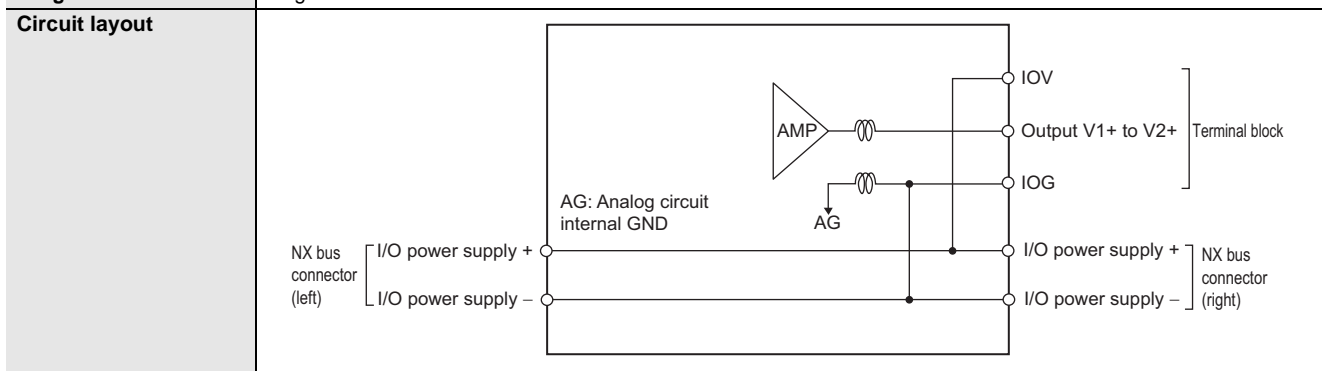

Installation orientation and restrictions
 Installation orientation: Possible in 6 orientations.
 Restrictions: No restrictions

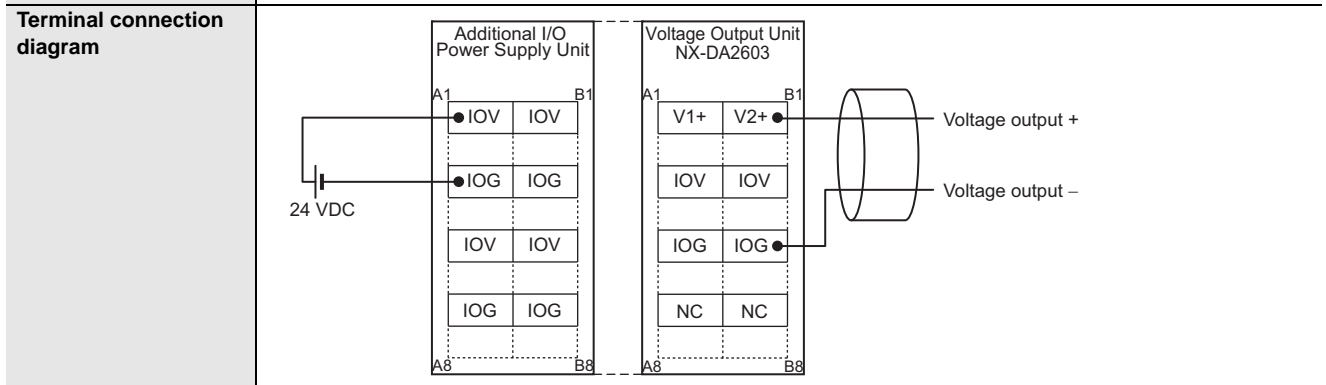

Unit name	Analog Output Unit (voltage output type)	Model	NX-DA2605	
Number of points	2 points	External connection terminals	Screwless clamping terminal block (8 terminals)	
I/O refreshing method	Switching synchronous I/O refreshing and Free-Run refreshing			
Indicators	TS indicator 	Output range	-10 to +10 V	
		Output conversion range	-5 to 105% (full scale)	
		Allowable load resistance	5 kΩ min.	
		Output impedance	0.5 Ω max.	
		Resolution	1/30000 (full scale)	
		Over-all accuracy	25°C	±0.1% (full scale)
			0 to 55°C	±0.3% (full scale)
Conversion time	10 μs/point			
Dimensions	12 (W) x 100 (H) x 71 (D)	Isolation method	Between the input and the NX bus: Power = Transformer, Signal = Digital isolator (no isolation between inputs)	
Insulation resistance	20 MΩ min. between isolated circuits (at 100 VDC)	Dielectric strength	510 VAC between isolated circuits for 1 minute at a leakage current of 5 mA max.	
I/O power supply method	Supply from the NX bus	Current capacity of I/O power supply terminal	IOV: 0.1 A/terminal max., IOG: 0.1 A/terminal max.	
NX Unit power consumption	1.10 W max.	Current consumption from I/O power supply	No consumption	
Weight	70 g max.			

Circuit layout

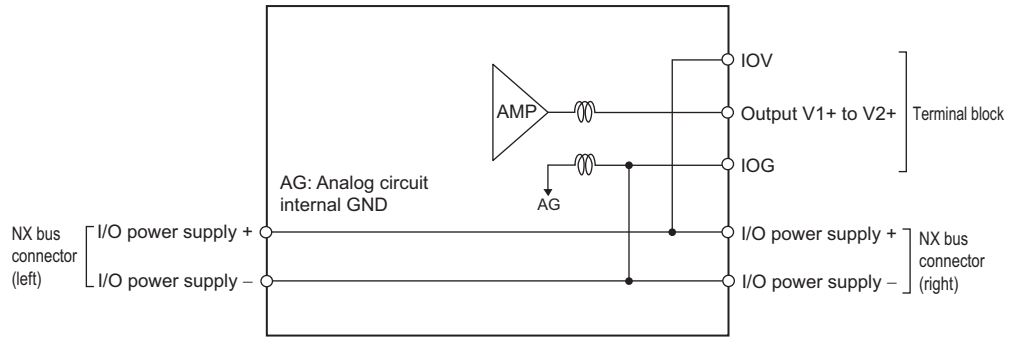

Installation orientation and restrictions

Installation orientation: Possible in 6 orientations.
 Restrictions: No restrictions

Terminal connection diagram

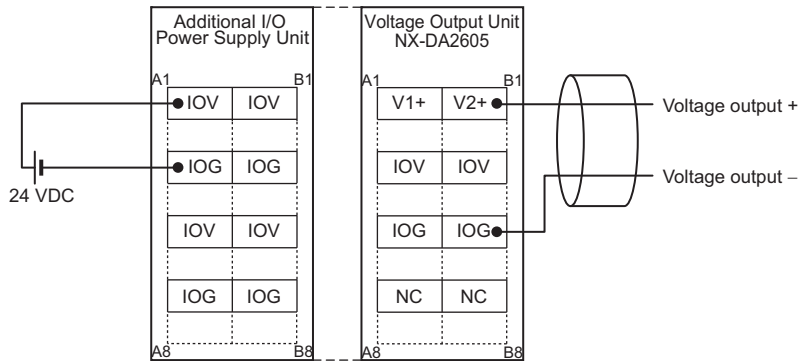

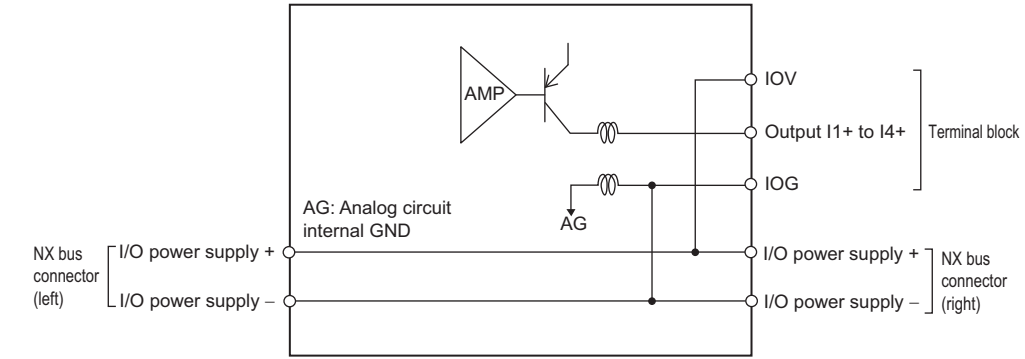
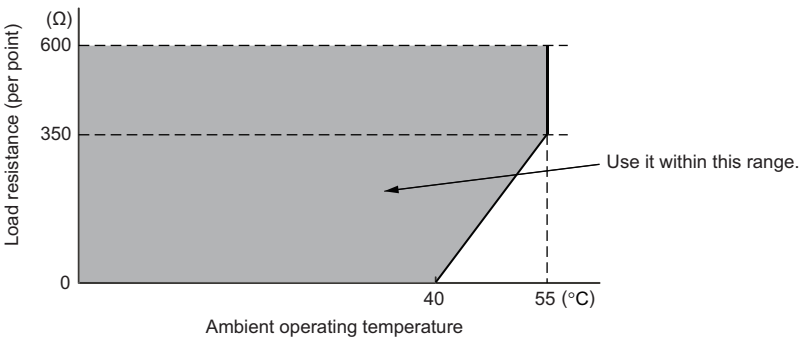
Unit name	Analog Output Unit (current output type)	Model	NX-DA3203	
Number of points	4 points	External connection terminals	Screwless clamping terminal block (12 terminals)	
I/O refreshing method	Free-Run refreshing			
Indicators	TS indicator 	Output range	4 to 20 mA	
		Output conversion range	-5 to 105% (full scale)	
		Allowable load resistance	350 Ω max.	
		Resolution	1/8000 (full scale)	
		Overall accuracy	25°C	±0.3% (full scale)
			0 to 55°C	±0.6% (full scale)
Conversion time	250 μs/point			
Dimensions	12 (W) x 100 (H) x 71 (D)	Isolation method	Between the input and the NX bus: Power = Transformer, Signal = Digital isolator (no isolation between inputs)	
Insulation resistance	20 MΩ min. between isolated circuits (at 100 VDC)	Dielectric strength	510 VAC between isolated circuits for 1 minute at a leakage current of 5 mA max.	
I/O power supply method	Supply from the NX bus	Current capacity of I/O power supply terminal	IOV: 0.1 A/terminal max., IOG: 0.1 A/terminal max.	
NX Unit power consumption	1.80 W max.	Current consumption from I/O power supply	No consumption	
Weight	70 g max.			
Circuit layout				
Installation orientation and restrictions	Installation orientation: Possible in 6 orientations. Restrictions: For upright installation: No restrictions For any installation other than upright: Restricted as shown in the graph below.			
				

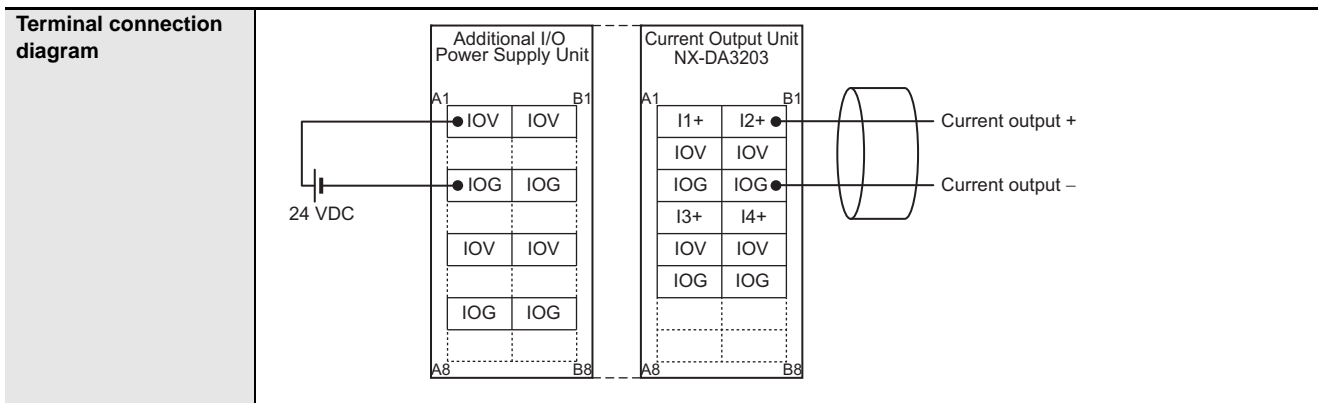

Unit name	Analog Output Unit (current output type)	Model	NX-DA3205	
Number of points	4 points	External connection terminals	Screwless clamping terminal block (12 terminals)	
I/O refreshing method	Switching synchronous I/O refreshing and Free-Run refreshing			
Indicators	TS indicator 	Output range	4 to 20 mA	
		Output conversion range	-5 to 105% (full scale)	
		Allowable load resistance	350 Ω max.	
		Resolution	1/30000 (full scale)	
		Overall accuracy	25°C	±0.1% (full scale)
			0 to 55°C	±0.3% (full scale)
	Conversion time	10 μs/point		
Dimensions	12 (W) x 100 (H) x 71 (D)	Isolation method	Between the input and the NX bus: Power = Transformer, Signal = Digital isolator (no isolation between inputs)	
Insulation resistance	20 MΩ min. between isolated circuits (at 100 VDC)	Dielectric strength	510 VAC between isolated circuits for 1 minute at a leakage current of 5 mA max.	
I/O power supply method	Supply from the NX bus	Current capacity of I/O power supply terminal	IOV: 0.1 A/terminal max., IOG: 0.1 A/terminal max.	
NX Unit power consumption	1.80 W max.	Current consumption from I/O power supply	No consumption	
Weight	70 g max.			

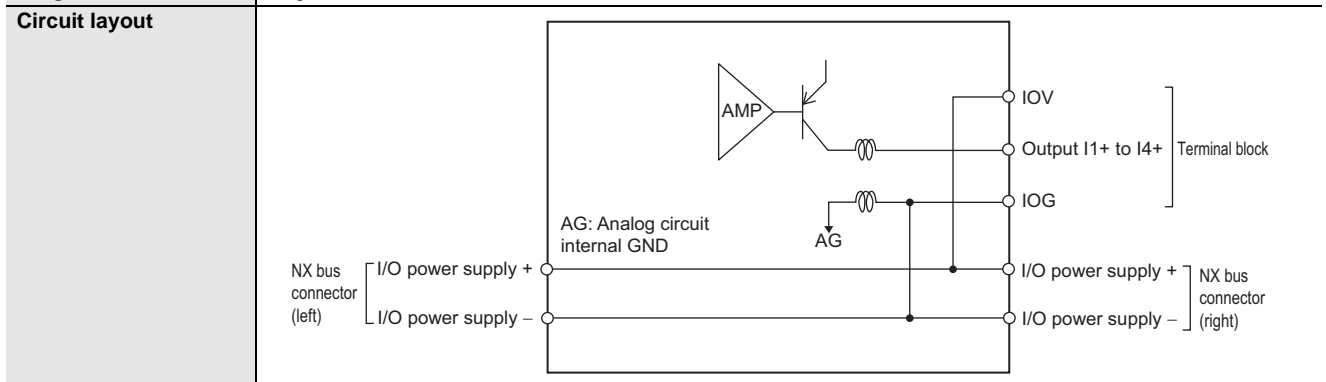

Installation orientation and restrictions

Installation orientation: Possible in 6 orientations.

Restrictions:

For upright installation: No restrictions

For any installation other than upright: Restricted as shown in the graph below.

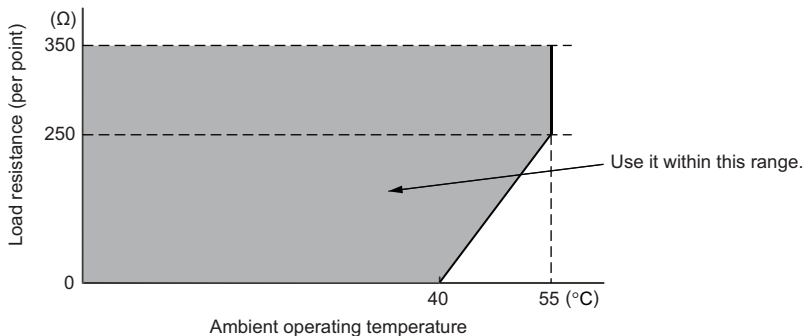

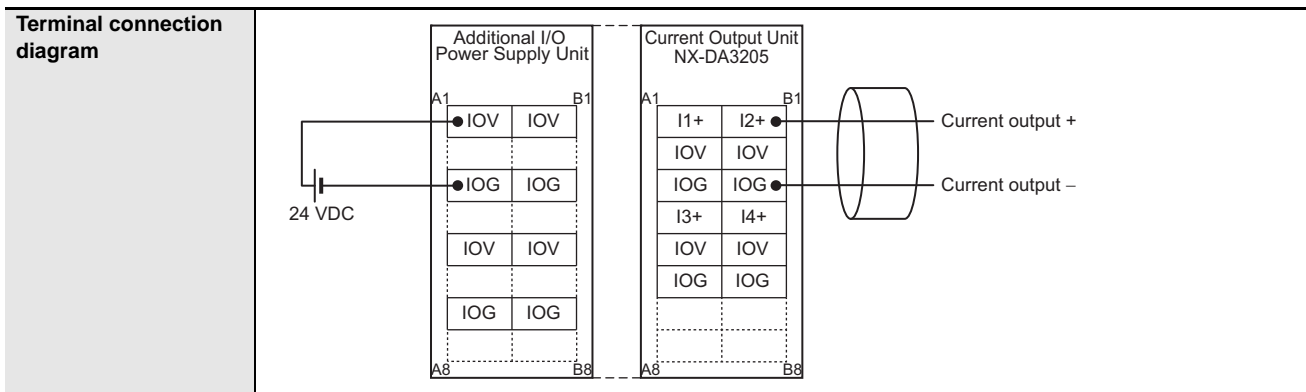

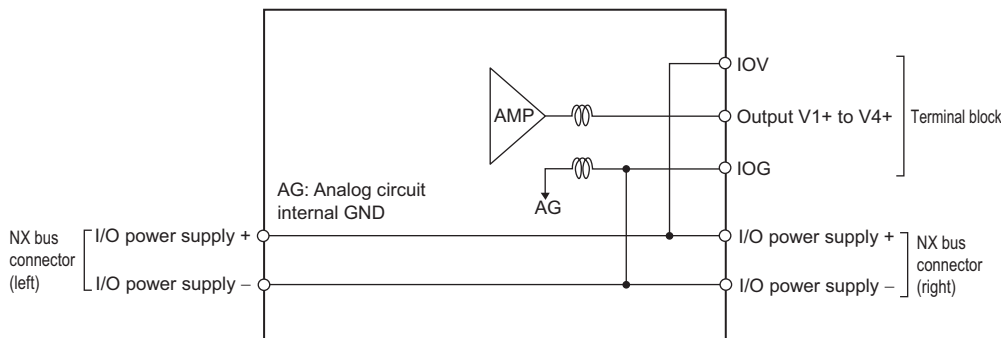
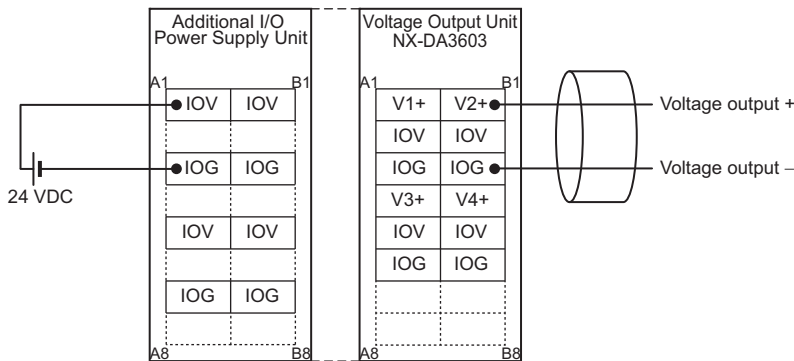
Unit name	Analog Output Unit (voltage output type)	Model	NX-DA3603	
Number of points	4 points	External connection terminals	Screwless clamping terminal block (12 terminals)	
I/O refreshing method	Free-Run refreshing			
Indicators	TS indicator 	Output range	-10 to +10 V	
		Output conversion range	-5 to 105% (full scale)	
		Allowable load resistance	5 kΩ min.	
		Output impedance	0.5 Ω max.	
		Resolution	1/8000 (full scale)	
		Over-all accuracy	25°C	±0.3% (full scale)
			0 to 55°C	±0.5% (full scale)
Conversion time	250 μs/point			
Dimensions	12 (W) x 100 (H) x 71 (D)	Isolation method	Between the input and the NX bus: Power = Transformer, Signal = Digital isolator (no isolation between inputs)	
Insulation resistance	20 MΩ min. between isolated circuits (at 100 VDC)	Dielectric strength	510 VAC between isolated circuits for 1 minute at a leakage current of 5 mA max.	
I/O power supply method	Supply from the NX bus	Current capacity of I/O power supply terminal	IOV: 0.1 A/terminal max., IOG: 0.1 A/terminal max.	
NX Unit power consumption	1.25 W max.	Current consumption from I/O power supply	No consumption	
Weight	70 g max.			
Circuit layout				
Installation orientation and restrictions	Installation orientation: Possible in 6 orientations. Restrictions: No restrictions			
Terminal connection diagram				

Unit name	Analog Output Unit (voltage output type)	Model	NX-DA3605	
Number of points	4 points	External connection terminals	Screwless clamping terminal block (12 terminals)	
I/O refreshing method	Switching synchronous I/O refreshing and Free-Run refreshing			
Indicators	TS indicator 	Output range	-10 to +10 V	
		Output conversion range	-5 to 105% (full scale)	
		Allowable load resistance	5 kΩ min.	
		Output impedance	0.5 Ω max.	
		Resolution	1/30000 (full scale)	
		Over-all accuracy	25°C	±0.1% (full scale)
			0 to 55°C	±0.3% (full scale)
Conversion time	10 μs/point			
Dimensions	12 (W) x 100 (H) x 71 (D)	Isolation method	Between the input and the NX bus: Power = Transformer, Signal = Digital isolator (no isolation between inputs)	
Insulation resistance	20 MΩ min. between isolated circuits (at 100 VDC)	Dielectric strength	510 VAC between isolated circuits for 1 minute at a leakage current of 5 mA max.	
I/O power supply method	Supply from the NX bus	Current capacity of I/O power supply terminal	IOV: 0.1 A/terminal max., IOG: 0.1 A/terminal max.	
NX Unit power consumption	1.25 W max.	Current consumption from I/O power supply	No consumption	
Weight	70 g max.			

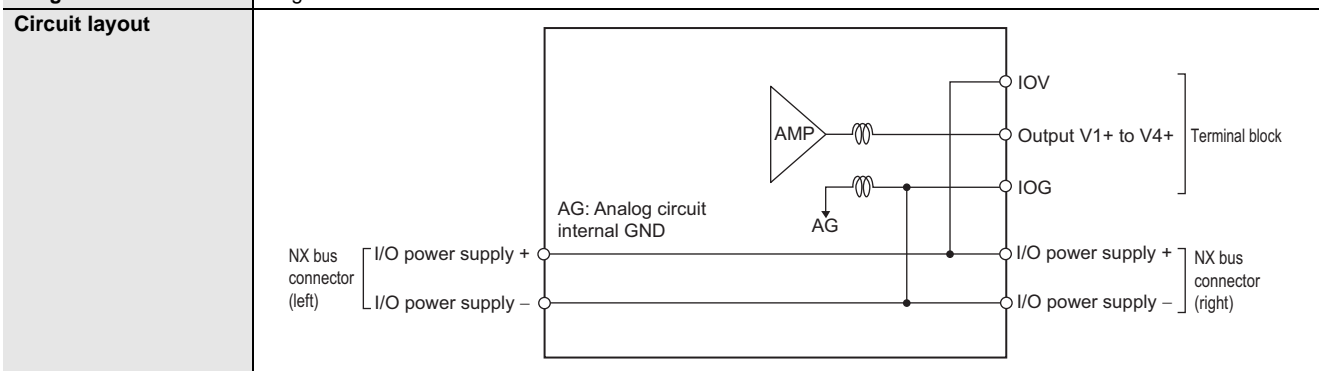

Installation orientation and restrictions
 Installation orientation: Possible in 6 orientations.
 Restrictions: No restrictions

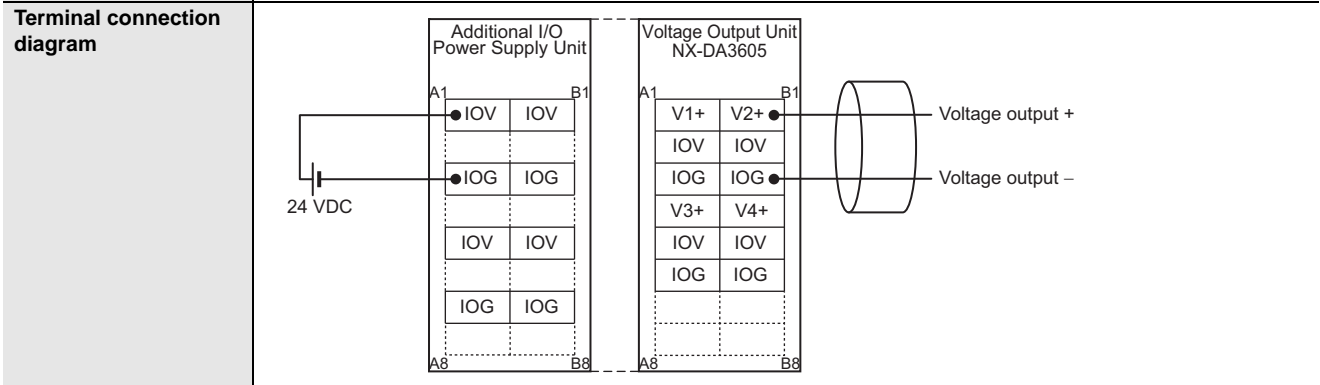

A-1-4 Temperature Input Units

Description of Items on the Data Sheet of the Temperature Input Unit

The meanings of the items on the data sheet of the Temperature Input Unit are explained in the table below.

● Thermocouple Type

Item	Description
Unit name	The name of the Unit.
Model	The model of the Unit.
Number of points	The number of temperature input points provided by the Unit.
External connection terminals	The type of terminal block and connector that is used for connecting the Unit. The number of terminals on the terminal block is also described when a screwless clamping terminal block is used.
I/O refreshing method	The I/O refreshing methods that are used by the Unit. Only Free-Run refreshing method is available.
Indicators	The type of indicators on the Unit and the layout of those indicators.
Temperature sensor	A temperature sensor that can be connected to the Unit.
Input conversion range	The conversion range of temperature data for the full scale of the Unit. Input temperature data outside this range are fixed to the conversion limit value.
Absolute maximum rating	The maximum value of sensor input signal of the Unit. If a signal exceeding this range is input, the Unit may be damaged.
Input impedance	The input impedance of the Unit.
Resolution	The resolution of the measured values for the Unit. It is defined in °C.
Reference accuracy	The reference conversion accuracy of temperature inputs of the Unit. It is defined at an ambient temperature of 25°C.
Temperature coefficient	The conversion coefficient of temperature inputs of the Unit.
Cold junction compensation error	The cold junction compensation error of the Unit.
Input disconnection detection current	The current that detect disconnection of the temperature sensor of the Unit.
Warm-up period	The warm-up period of the Unit. If the Unit is warmed up, the temperature inside the Unit is stable. Thus, the measured value is stable. If the Unit is not warmed up, the temperature data error becomes larger.
Conversion time	The time required to convert temperature input signals of the Unit to temperature data.
Dimensions	The dimensions of the Unit. They are described as W x H x D. The unit is "mm".
Isolation method	The isolation method between the input circuits and internal circuits and between the input circuits of the Unit.
Insulation resistance	The insulation resistance between the input circuits and internal circuits and between each input circuit of the Unit.
Dielectric strength	The dielectric strength between the input circuits and internal circuits and between each input circuit of the Unit.
I/O power supply method	The method for supplying I/O power for the Unit. The supply method is determined for each Unit. The power is supplied from the NX bus or the external source. There is no I/O power supply for the connected external devices.
Current capacity of I/O power supply terminal	The current capacity of the I/O power supply terminals (IOV/IOG) of the Unit. Do not exceed this value when supplying the I/O power to the connected external devices.
NX Unit power consumption	The power consumption of the NX Unit power supply of the Unit.
Current consumption from I/O power supply	The current consumption from I/O power supply of the Unit. The above input current and current consumption of any connected external devices are excluded.
Weight	The weight of the Unit.
Installation orientation and restrictions	The installation orientation of the Slave Terminal including the Unit, and the details of restrictions on the specifications due to the installation orientation.

Terminal connection diagram	A diagram of the connection between the Unit and connected external devices. When an I/O Power Supply Connection Unit or a Shield Connection Unit is required to be connected to the connected external devices, the description for such is included.
------------------------------------	--

● Resistance Thermometer Type

Item	Description
Unit name	The name of the Unit.
Model	The model of the Unit.
Number of points	The number of temperature input points provided by the Unit.
External connection terminals	The type of terminal block and connector that is used for connecting the Unit. The number of terminals on the terminal block is also described when a screwless clamping terminal block is used.
I/O refreshing method	The I/O refreshing methods that are used by the Unit. Only Free-Run refreshing method is available.
Indicators	The type of indicators on the Unit and the layout of those indicators.
Temperature sensor	A temperature sensor that can be connected to the Unit.
Input conversion range	The conversion range of temperature data for the full scale of the Unit. Input temperature data outside this range are fixed to the conversion limit value.
Input detection current	The current value for detecting temperature inputs of the Unit.
Resolution	The resolution of the measured values for the Unit. It is defined in °C.
Reference accuracy	The reference conversion accuracy of temperature inputs of the Unit. It is defined at an ambient temperature of 25°C.
Temperature coefficient	The conversion coefficient of temperature inputs of the Unit.
Effect of conductor resistance	The effect of conductor resistance of the Unit.
Warm-up period	The warm-up period of the Unit. If the Unit is warmed up, the temperature inside the Unit is stable. Thus, the measured value is stable. If the Unit is not warmed up, the temperature data error becomes larger.
Conversion time	The time required to convert temperature input signals of the Unit to temperature data.
Dimensions	The dimensions of the Unit. They are described as W x H x D. The unit is "mm".
Isolation method	The isolation method between the input circuits and internal circuits and between the input circuits of the Unit.
Insulation resistance	The insulation resistance between the input circuits and internal circuits and between each input circuit of the Unit.
Dielectric strength	The dielectric strength between the input circuits and internal circuits and between each input circuit of the Unit.
I/O power supply method	The method for supplying I/O power for the Unit. The supply method is determined for each Unit. The power is supplied from the NX bus or the external source. There is no I/O power supply for the connected external devices.
Current capacity of I/O power supply terminal	The current capacity of I/O power supply terminals (IOV/IOG) of the Unit. Do not exceed this value when supplying the I/O power to the connected external devices.
NX Unit power consumption	The power consumption of the NX Unit power supply of the Unit.
Current consumption from I/O power supply	The current consumption from I/O power supply of the Unit. The above input current and current consumption of any connected external devices are excluded.
Weight	The weight of the Unit.
Installation orientation and restrictions	The installation orientation of the Slave Terminal including the Unit, and the details of restrictions on the specifications due to the installation orientation.
Terminal connection diagram	A diagram of the connection between the Unit and connected external devices. When an I/O Power Supply Connection Unit or a Shield Connection Unit is required to be connected to the connected external devices, the description for such is included.

Temperature Input Units (Screwless Clamping Terminal Block, 12 mm Width)

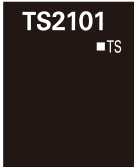
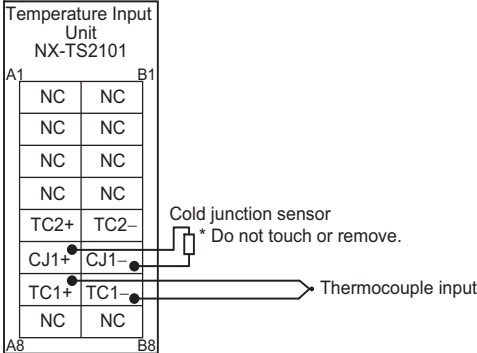
Unit name	Temperature Input Unit (thermocouple input type)	Model	NX-TS2101
Number of points	2 points	External connection terminals	Screwless clamping terminal block (16 terminals)
I/O refreshing method	Free-Run refreshing		
Indicators		Temperature sensor	K, J, T, E, L, U, N, R, S, B, WRe5-26, PLII
		Input conversion range	±20°C of the input range
		Absolute maximum rating	±130 mV
		Input impedance	20 kΩ min.
		Resolution	0.1°C max. *1
		Reference accuracy	*2
		Temperature coefficient	*2
		Cold junction compensation error	±1.2°C *3 *4
		Input disconnection detection current	Approx. 0.1 μA
Warm-up period	30 minutes	Conversion time	250 ms/Unit
Dimensions	12 (W) x 100 (H) x 71 (D)	Isolation method	Between the input and the NX bus: Power = Transformer, Signal = Photocoupler Between inputs: Power = Transformer, Signal = Photocoupler
Insulation resistance	20 MΩ min. between isolated circuits (at 100 VDC)	Dielectric strength	510 VAC between isolated circuits for 1 minute at a leakage current of 5 mA max.
I/O power supply method	No supply	Current capacity of I/O power supply terminal	Without I/O power supply terminals
NX Unit power consumption	0.90 W max.	Current consumption from I/O power supply	No consumption
Weight	70 g max.		
Installation orientation and restrictions	Installation orientation: Possible in 6 orientations. Restrictions: The cold junction compensation error is restricted according to the installation orientation and the power consumption of adjacent Units. Refer to <i>Cold Junction Compensation Error Specifications for Units That Take a Thermocouple Input Type</i> on page A-55 for details.		
Terminal connection diagram			

*1. The resolution is 0.2°C max. when the input type is R, S, or W.

*2. Refer to *Reference Accuracy and Temperature Coefficient According to the Input Type and Measurement Temperature* *1 on page A-52.

*3. The cold junction compensation error is guaranteed for a set consisting of a cold junction sensor that is mounted on the terminal block and a Temperature Input Unit. Be sure to use the terminal block and the Temperature Input Unit together. A calibration control number is both displayed on the terminal block and the Unit. Make sure to return the terminal block (including a cold junction sensor mounted) and the Unit together for repair.

*4. Refer to *Cold Junction Compensation Error Specifications for Units That Take a Thermocouple Input Type* on page A-55 for the specifications for each set of operating conditions.

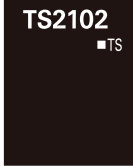
Unit name	Temperature Input Unit (thermocouple input type)	Model	NX-TS2102
Number of points	2 points	External connection terminals	Screwless clamping terminal block (16 terminals)
I/O refreshing method	Free-Run refreshing		
Indicators		Temperature sensor	K, J, T, E, L, U, N, R, S, WRe5-26, PLII
		Input conversion range	±20°C of the input range
		Absolute maximum rating	±130 mV
		Input impedance	20 kΩ min.
		Resolution	0.01°C max.
		Reference accuracy	*1
		Temperature coefficient	*1
		Cold junction compensation error	±1.2°C *2 *3
		Input disconnection detection current	Approx. 0.1 μA
Warm-up period	45 minutes	Conversion time	10 ms/Unit
Dimensions	12 (W) x 100 (H) x 71 (D)	Isolation method	Between the input and the NX bus: Power = Transformer, Signal = Digital isolator Between inputs: Power = Transformer, Signal = Digital isolator
Insulation resistance	20 MΩ min. between isolated circuits (at 100 VDC)	Dielectric strength	510 VAC between isolated circuits for 1 minute at a leakage current of 5 mA max.
I/O power supply method	No supply	Current capacity of I/O power supply terminal	Without I/O power supply terminals
NX Unit power consumption	0.80 W max.	Current consumption from I/O power supply	No consumption
Weight	70 g max.		
Installation orientation and restrictions	Installation orientation: Possible in 6 orientations. Restrictions: The cold junction compensation error is restricted according to the installation orientation and the power consumption of adjacent Units. Refer to <i>Cold Junction Compensation Error Specifications for Units That Take a Thermocouple Input Type</i> on page A-55 for details.		
Terminal connection diagram			

- *1. Refer to *Reference Accuracy and Temperature Coefficient According to the Input Type and Measurement Temperature* *1 on page A-52.
- *2. The cold junction compensation error is guaranteed for a set consisting of a cold junction sensor that is mounted on the terminal block and a Temperature Input Unit. Be sure to use the terminal block and the Temperature Input Unit together. A calibration control number is both displayed on the terminal block and the Unit. Make sure to return the terminal block (including a cold junction sensor mounted) and the Unit together for repair.
- *3. Refer to *Cold Junction Compensation Error Specifications for Units That Take a Thermocouple Input Type* on page A-55 for the specifications for each set of operating conditions.

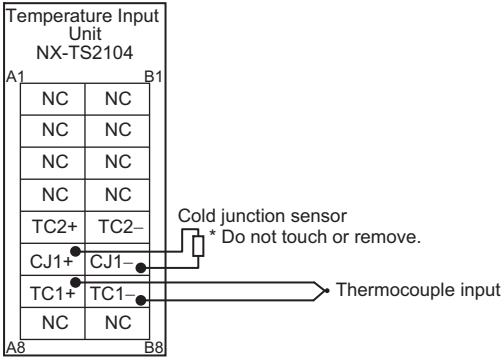
Unit name	Temperature Input Unit (thermocouple input type)	Model	NX-TS2104
Number of points	2 points	External connection terminals	Screwless clamping terminal block (16 terminals)
I/O refreshing method	Free-Run refreshing		
Indicators		Temperature sensor	K, J, T, E, L, U, N, R, S, WRe5-26, PLII
		Input conversion range	±20°C of the input range
		Absolute maximum rating	±130 mV
		Input impedance	20 kΩ min.
		Resolution	0.001°C max.
		Reference accuracy	*1
		Temperature coefficient	*1
		Cold junction compensation error	±1.2°C *2 *3
		Input disconnection detection current	Approx. 0.1 μA
Warm-up period	45 minutes	Conversion time	60 ms/Unit
Dimensions	12 (W) x 100 (H) x 71 (D)	Isolation method	Between the input and the NX bus: Power = Transformer, Signal = Digital isolator Between inputs: Power = Transformer, Signal = Digital isolator
Insulation resistance	20 MΩ min. between isolated circuits (at 100 VDC)	Dielectric strength	510 VAC between isolated circuits for 1 minute at a leakage current of 5 mA max.
I/O power supply method	No supply	Current capacity of I/O power supply terminal	Without I/O power supply terminals
NX Unit power consumption	0.80 W max.	Current consumption from I/O power supply	No consumption
Weight	70 g max.		
Installation orientation and restrictions	Installation orientation: Possible in 6 orientations. Restrictions: The cold junction compensation error is restricted according to the installation orientation and the power consumption of adjacent Units. Refer to <i>Cold Junction Compensation Error Specifications for Units That Take a Thermocouple Input Type</i> on page A-55 for details.		
Terminal connection diagram			

- *1. Refer to *Reference Accuracy and Temperature Coefficient According to the Input Type and Measurement Temperature *1* on page A-52.
- *2. The cold junction compensation error is guaranteed for a set consisting of a cold junction sensor that is mounted on the terminal block and a Temperature Input Unit. Be sure to use the terminal block and the Temperature Input Unit together. A calibration control number is both displayed on the terminal block and the Unit. Make sure to return the terminal block (including a cold junction sensor mounted) and the Unit together for repair.
- *3. Refer to *Cold Junction Compensation Error Specifications for Units That Take a Thermocouple Input Type* on page A-55 for the specifications for each set of operating conditions.

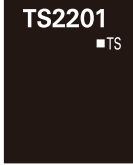
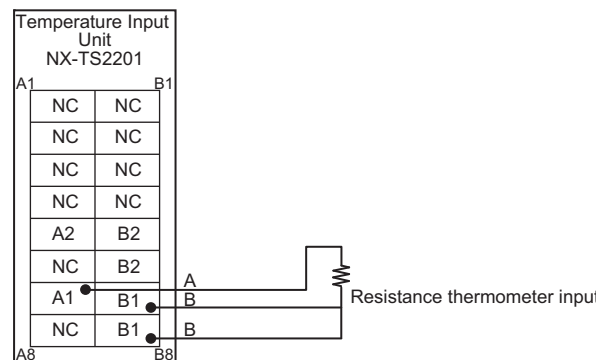
Unit name	Temperature Input Unit (resistance thermometer input type)	Model	NX-TS2201
Number of points	2 points	External connection terminals	Screwless clamping terminal block (16 terminals)
I/O refreshing method	Free-Run refreshing		
Indicators		Temperature sensor	Pt100 (three-wire)/Pt1000 (three-wire)
		Input conversion range	±20°C of the input range
		Input detection current	Approx. 0.25 mA
		Resolution	0.1°C max.
		Reference accuracy	*1
		Temperature coefficient	*1
		Effect of conductor resistance	0.06°C/Ω max. (also 20 Ω max.)
Warm-up period	10 minutes	Conversion time	250 ms/Unit
Dimensions	12 (W) x 100 (H) x 71 (D)	Isolation method	Between the input and the NX bus: Power = Transformer, Signal = Photocoupler Between inputs: Power = Transformer, Signal = Photocoupler
Insulation resistance	20 MΩ min. between isolated circuits (at 100 VDC)	Dielectric strength	510 VAC between isolated circuits for 1 minute at a leakage current of 5 mA max.
I/O power supply method	No supply	Current capacity of I/O power supply terminal	Without I/O power supply terminals
NX Unit power consumption	0.90 W max.	Current consumption from I/O power supply	No consumption
Weight	70 g max.		
Installation orientation and restrictions	Installation orientation: Possible in 6 orientations. Restrictions: No restrictions		
Terminal connection diagram			

*1. Refer to Reference Accuracy and Temperature Coefficient According to the Input Type and Measurement Temperature *1 on page A-52.

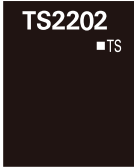
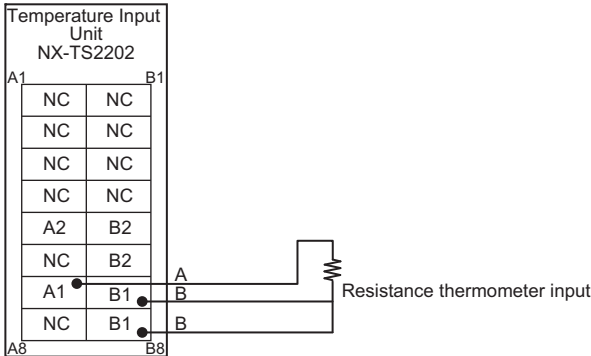
Unit name	Temperature Input Unit (resistance thermometer input type)	Model	NX-TS2202
Number of points	2 points	External connection terminals	Screwless clamping terminal block (16 terminals)
I/O refreshing method	Free-Run refreshing		
Indicators	TS indicator 	Temperature sensor	Pt100 (three-wire)
		Input conversion range	±20°C of the input range
		Input detection current	Approx. 0.25 mA
		Resolution	0.01°C max.
		Reference accuracy	*1
		Temperature coefficient	*1
		Effect of conductor resistance	0.06°C/Ω max. (also 20 Ω max.)
Warm-up period	30 minutes	Conversion time	10 ms/Unit
Dimensions	12 (W) x 100 (H) x 71 (D)	Isolation method	Between the input and the NX bus: Power = Transformer, Signal = Digital isolator Between inputs: Power = Transformer, Signal = Digital isolator
Insulation resistance	20 MΩ min. between isolated circuits (at 100 VDC)	Dielectric strength	510 VAC between isolated circuits for 1 minute at a leakage current of 5 mA max.
I/O power supply method	No supply	Current capacity of I/O power supply terminal	Without I/O power supply terminals
NX Unit power consumption	0.75 W max.	Current consumption from I/O power supply	No consumption
Weight	70 g max.		
Installation orientation and restrictions	Installation orientation: Possible in 6 orientations. Restrictions: No restrictions		
Terminal connection diagram			

*1. Refer to *Reference Accuracy and Temperature Coefficient According to the Input Type and Measurement Temperature* *1 on page A-52.

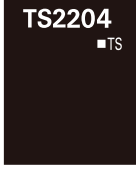
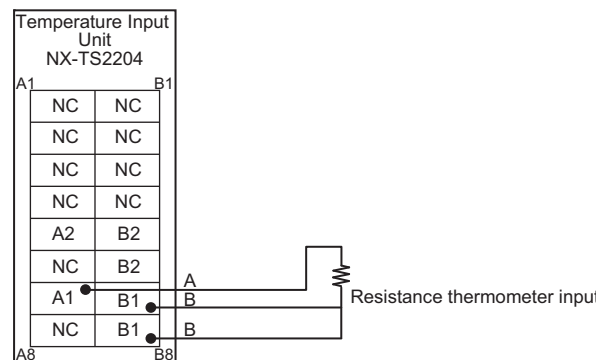
Unit name	Temperature Input Unit (resistance thermometer input type)	Model	NX-TS2204
Number of points	2 points	External connection terminals	Screwless clamping terminal block (16 terminals)
I/O refreshing method	Free-Run refreshing		
Indicators		Temperature sensor	Pt100 (three-wire)/Pt1000 (three-wire)
		Input conversion range	±20°C of the input range
		Input detection current	Approx. 0.25 mA
		Resolution	0.001°C max.
		Reference accuracy	*1
		Temperature coefficient	*1
		Effect of conductor resistance	0.06°C/Ω max. (also 20 Ω max.)
Warm-up period	30 minutes	Conversion time	60 ms/Unit
Dimensions	12 (W) x 100 (H) x 71 (D)	Isolation method	Between the input and the NX bus: Power = Transformer, Signal = Digital isolator Between inputs: Power = Transformer, Signal = Digital isolator
Insulation resistance	20 MΩ min. between isolated circuits (at 100 VDC)	Dielectric strength	510 VAC between isolated circuits for 1 minute at a leakage current of 5 mA max.
I/O power supply method	No supply	Current capacity of I/O power supply terminal	Without I/O power supply terminals
NX Unit power consumption	0.75 W max.	Current consumption from I/O power supply	No consumption
Weight	70 g max.		
Installation orientation and restrictions	Installation orientation: Possible in 6 orientations. Restrictions: No restrictions		
Terminal connection diagram			

*1. Refer to Reference Accuracy and Temperature Coefficient According to the Input Type and Measurement Temperature *1 on page A-52.

Temperature Input Units (Screwless Clamping Terminal Block, 24 mm Width)

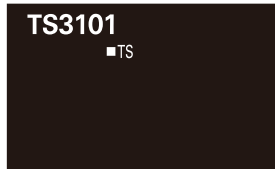
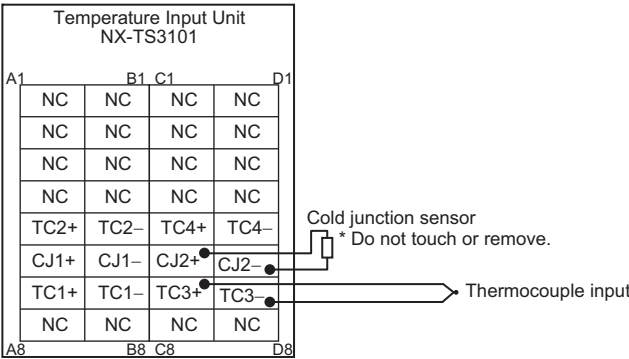
Unit name	Temperature Input Unit (thermocouple input type)	Model	NX-TS3101
Number of points	4 points	External connection terminals	Screwless clamping terminal block (16 terminals × 2)
I/O refreshing method	Free-Run refreshing		
Indicators		Temperature sensor	K, J, T, E, L, U, N, R, S, B, WRe5-26, PLII
		Input conversion range	±20°C of the input range
		Absolute maximum rating	±130 mV
		Input impedance	20 kΩ min.
		Resolution	0.1°C max. *1
		Reference accuracy	*2
		Temperature coefficient	*2
		Cold junction compensation error	±1.2°C *3 *4
		Input disconnection detection current	Approx. 0.1 μA
Warm-up period	30 minutes	Conversion time	250 ms/Unit
Dimensions	24 (W) x 100 (H) x 71 (D)	Isolation method	Between the input and the NX bus: Power = Transformer, Signal = Photocoupler Between inputs: Power = Transformer, Signal = Photocoupler
Insulation resistance	20 MΩ min. between isolated circuits (at 100 VDC)	Dielectric strength	510 VAC between isolated circuits for 1 minute at a leakage current of 5 mA max.
I/O power supply method	No supply	Current capacity of I/O power supply terminal	Without I/O power supply terminals
NX Unit power consumption	1.30 W max.	Current consumption from I/O power supply	No consumption
Weight	140 g max.		
Installation orientation and restrictions	Installation orientation: Possible in 6 orientations. Restrictions: The cold junction compensation error is restricted according to the installation orientation and the power consumption of adjacent Units. Refer to <i>Cold Junction Compensation Error Specifications for Units That Take a Thermocouple Input Type</i> on page A-55 for details.		
Terminal connection diagram			

*1. The resolution is 0.2°C max. when the input type is R, S, or W.

*2. Refer to *Reference Accuracy and Temperature Coefficient According to the Input Type and Measurement Temperature* *1 on page A-52.

*3. The cold junction compensation error is guaranteed for a set consisting of a cold junction sensor that is mounted on the terminal block and a Temperature Input Unit. Be sure to use the terminal block and the Temperature Input Unit together. A calibration control number is both displayed on the terminal block and the Unit. Make sure to return the terminal block (including a cold junction sensor mounted) and the Unit together for repair.

*4. Refer to *Cold Junction Compensation Error Specifications for Units That Take a Thermocouple Input Type* on page A-55 for the specifications for each set of operating conditions.

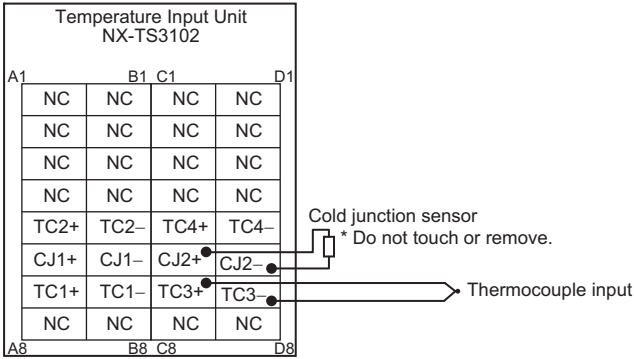
Unit name	Temperature Input Unit (thermocouple input type)	Model	NX-TS3102
Number of points	4 points	External connection terminals	Screwless clamping terminal block (16 terminals × 2)
I/O refreshing method	Free-Run refreshing		
Indicators		Temperature sensor	K, J, T, E, L, U, N, R, S, WRe5-26, PLII
		Input conversion range	±20°C of the input range
		Absolute maximum rating	±130 mV
		Input impedance	20 kΩ min.
		Resolution	0.01°C max.
		Reference accuracy	*1
		Temperature coefficient	*1
		Cold junction compensation error	±1.2°C *2 *3
		Input disconnection detection current	Approx. 0.1 μA
		Warm-up period	45 minutes
Dimensions	24 (W) x 100 (H) x 71 (D)	Isolation method	Between the input and the NX bus: Power = Transformer, Signal = Digital isolator Between inputs: Power = Transformer, Signal = Digital isolator
		Insulation resistance	20 MΩ min. between isolated circuits (at 100 VDC)
Dielectric strength	510 VAC between isolated circuits for 1 minute at a leakage current of 5 mA max.	Current capacity of I/O power supply terminal	Without I/O power supply terminals
I/O power supply method	No supply	Current consumption from I/O power supply	No consumption
NX Unit power consumption	1.10 W max.		
Weight	140 g max.		
Installation orientation and restrictions	Installation orientation: Possible in 6 orientations. Restrictions: The cold junction compensation error is restricted according to the installation orientation and the power consumption of adjacent Units. Refer to <i>Cold Junction Compensation Error Specifications for Units That Take a Thermocouple Input Type</i> on page A-55 for details.		
Terminal connection diagram			

- *1. Refer to *Reference Accuracy and Temperature Coefficient According to the Input Type and Measurement Temperature* *1 on page A-52.
- *2. The cold junction compensation error is guaranteed for a set consisting of a cold junction sensor that is mounted on the terminal block and a Temperature Input Unit. Be sure to use the terminal block and the Temperature Input Unit together. A calibration control number is both displayed on the terminal block and the Unit. Make sure to return the terminal block (including a cold junction sensor mounted) and the Unit together for repair.
- *3. Refer to *Cold Junction Compensation Error Specifications for Units That Take a Thermocouple Input Type* on page A-55 for the specifications for each set of operating conditions.

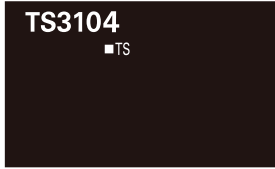
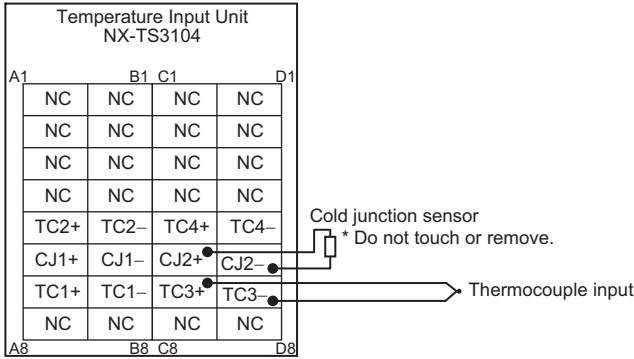
Unit name	Temperature Input Unit (thermocouple input type)	Model	NX-TS3104
Number of points	4 points	External connection terminals	Screwless clamping terminal block (16 terminals × 2)
I/O refreshing method	Free-Run refreshing		
Indicators		Temperature sensor	K, J, T, E, L, U, N, R, S, WRe5-26, PLII
		Input conversion range	±20°C of the input range
		Absolute maximum rating	±130 mV
		Input impedance	20 kΩ min.
		Resolution	0.001°C max.
		Reference accuracy	*1
		Temperature coefficient	*1
		Cold junction compensation error	±1.2°C *2 *3
	Input disconnection detection current	Approx. 0.1 μA	
Warm-up period	45 minutes	Conversion time	60 ms/Unit
Dimensions	24 (W) x 100 (H) x 71 (D)	Isolation method	Between the input and the NX bus: Power = Transformer, Signal = Digital isolator Between inputs: Power = Transformer, Signal = Digital isolator
Insulation resistance	20 MΩ min. between isolated circuits (at 100 VDC)	Dielectric strength	510 VAC between isolated circuits for 1 minute at a leakage current of 5 mA max.
I/O power supply method	No supply	Current capacity of I/O power supply terminal	Without I/O power supply terminals
NX Unit power consumption	1.10 W max.	Current consumption from I/O power supply	No consumption
Weight	140 g max.		
Installation orientation and restrictions	Installation orientation: Possible in 6 orientations. Restrictions: The cold junction compensation error is restricted according to the installation orientation and the power consumption of adjacent Units. Refer to <i>Cold Junction Compensation Error Specifications for Units That Take a Thermocouple Input Type</i> on page A-55 for details.		
Terminal connection diagram			

- *1. Refer to *Reference Accuracy and Temperature Coefficient According to the Input Type and Measurement Temperature *1* on page A-52.
- *2. The cold junction compensation error is guaranteed for a set consisting of a cold junction sensor that is mounted on the terminal block and a Temperature Input Unit. Be sure to use the terminal block and the Temperature Input Unit together. A calibration control number is both displayed on the terminal block and the Unit. Make sure to return the terminal block (including a cold junction sensor mounted) and the Unit together for repair.
- *3. Refer to *Cold Junction Compensation Error Specifications for Units That Take a Thermocouple Input Type* on page A-55 for the specifications for each set of operating conditions.

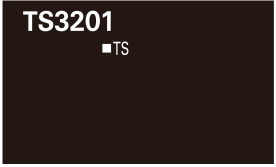
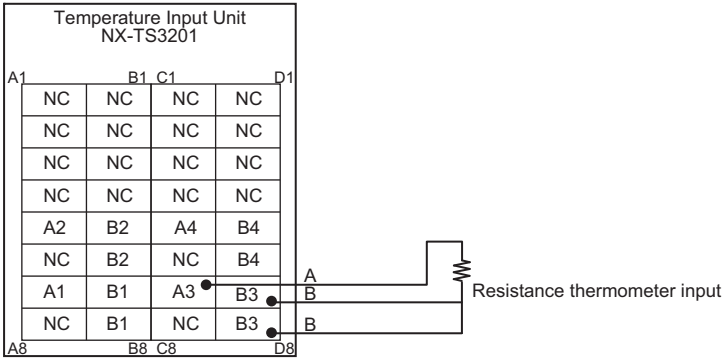
Unit name	Temperature Input Unit (resistance thermometer input type)	Model	NX-TS3201
Number of points	4 points	External connection terminals	Screwless clamping terminal block (16 terminals × 2)
I/O refreshing method	Free-Run refreshing		
Indicators	TS indicator 	Temperature sensor	Pt100 (three-wire)/Pt1000 (three-wire)
		Input conversion range	±20°C of the input range
		Input detection current	Approx. 0.25 mA
		Resolution	0.1°C max.
		Reference accuracy	*1
		Temperature coefficient	*1
		Effect of conductor resistance	0.06°C/Ω max. (also 20 Ω max.)
Warm-up period	10 minutes	Conversion time	250 ms/Unit
Dimensions	24 (W) x 100 (H) x 71 (D)	Isolation method	Between the input and the NX bus: Power = Transformer, Signal = Photocoupler Between inputs: Power = Transformer, Signal = Photocoupler
Insulation resistance	20 MΩ min. between isolated circuits (at 100 VDC)	Dielectric strength	510 VAC between isolated circuits for 1 minute at a leakage current of 5 mA max.
I/O power supply method	No supply	Current capacity of I/O power supply terminal	Without I/O power supply terminals
NX Unit power consumption	1.30 W max.	Current consumption from I/O power supply	No consumption
Weight	140 g max.		
Installation orientation and restrictions	Installation orientation: Possible in 6 orientations. Restrictions: No restrictions		
Terminal connection diagram	 <p>The diagram shows a 16-pin terminal block for the Temperature Input Unit NX-TS3201. The pins are arranged in two columns of eight. The left column pins are labeled A1 through A8, and the right column pins are labeled D1 through D8. The top four pins (A1-D1) are labeled 'NC' (Not Connected). The bottom four pins (A4-D4) are labeled A2, B2, A4, B4. The bottom four pins (A8-D8) are labeled A1, B1, A3, B3. A resistance thermometer input is connected to pins A3 and B3, with a common ground connection to pin B8.</p>		

*1. Refer to Reference Accuracy and Temperature Coefficient According to the Input Type and Measurement Temperature *1 on page A-52.

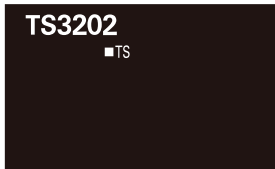
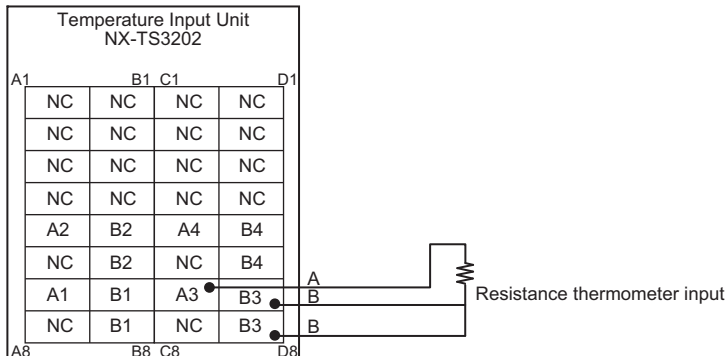
Unit name	Temperature Input Unit (resistance thermometer input type)	Model	NX-TS3202
Number of points	4 points	External connection terminals	Screwless clamping terminal block (16 terminals × 2)
I/O refreshing method	Free-Run refreshing		
Indicators	TS indicator 	Temperature sensor	Pt100 (three-wire)
		Input conversion range	±20°C of the input range
		Input detection current	Approx. 0.25 mA
		Resolution	0.01°C max.
		Reference accuracy	*1
		Temperature coefficient	*1
		Effect of conductor resistance	0.06°C/Ω max. (also 20 Ω max.)
Warm-up period	30 minutes	Conversion time	10 ms/Unit
Dimensions	24 (W) × 100 (H) × 71 (D)	Isolation method	Between the input and the NX bus: Power = Transformer, Signal = Digital isolator Between inputs: Power = Transformer, Signal = Digital isolator
Insulation resistance	20 MΩ min. between isolated circuits (at 100 VDC)	Dielectric strength	510 VAC between isolated circuits for 1 minute at a leakage current of 5 mA max.
I/O power supply method	No supply	Current capacity of I/O power supply terminal	Without I/O power supply terminals
NX Unit power consumption	1.05 W max.	Current consumption from I/O power supply	No consumption
Weight	130 g max.		
Installation orientation and restrictions	Installation orientation: Possible in 6 orientations. Restrictions: No restrictions		
Terminal connection diagram	 <p>The diagram shows a 16-pin terminal block for the Temperature Input Unit NX-TS3202. The pins are arranged in two rows of eight. The top row is labeled A1 through D1, and the bottom row is labeled A8 through D8. The connections are as follows:</p> <ul style="list-style-type: none"> Row 1 (A1-D1): All pins are NC (Not Connected). Row 2 (A2-D2): A2, B2, A4, B4. Row 3 (A3-D3): NC, B2, NC, B4. Row 4 (A4-D4): A1, B1, A3, B3. Row 5 (A5-D5): NC, B1, NC, B3. <p>External connections are shown on the right side of the terminal block:</p> <ul style="list-style-type: none"> Terminal A (top) is connected to terminal A3. Terminal B (middle) is connected to terminal B3. Terminal B (bottom) is connected to terminal B3. <p>The external terminals are labeled A, B, and B. A resistance thermometer input symbol is shown connected to these terminals.</p>		

*1. Refer to Reference Accuracy and Temperature Coefficient According to the Input Type and Measurement Temperature *1 on page A-52.

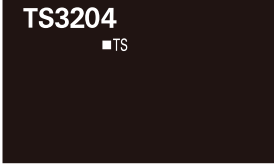
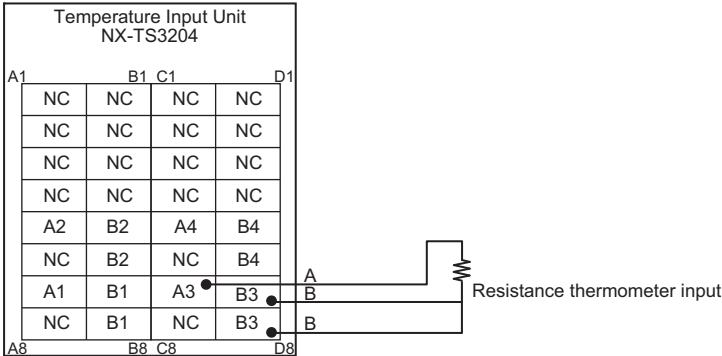
Unit name	Temperature Input Unit (resistance thermometer input type)	Model	NX-TS3204
Number of points	4 points	External connection terminals	Screwless clamping terminal block (16 terminals × 2)
I/O refreshing method	Free-Run refreshing		
Indicators		Temperature sensor	Pt100 (three-wire)/Pt1000 (three-wire)
		Input conversion range	±20°C of the input range
		Input detection current	Approx. 0.25 mA
		Resolution	0.001°C max.
		Reference accuracy	*1
		Temperature coefficient	*1
		Effect of conductor resistance	0.06°C/Ω max. (also 20 Ω max.)
Warm-up period	30 minutes	Conversion time	60 ms/Unit
Dimensions	24 (W) x 100 (H) x 71 (D)	Isolation method	Between the input and the NX bus: Power = Transformer, Signal = Digital isolator Between inputs: Power = Transformer, Signal = Digital isolator
Insulation resistance	20 MΩ min. between isolated circuits (at 100 VDC)	Dielectric strength	510 VAC between isolated circuits for 1 minute at a leakage current of 5 mA max.
I/O power supply method	No supply	Current capacity of I/O power supply terminal	Without I/O power supply terminals
NX Unit power consumption	1.05 W max.	Current consumption from I/O power supply	No consumption
Weight	130 g max.		
Installation orientation and restrictions	Installation orientation: Possible in 6 orientations. Restrictions: No restrictions		
Terminal connection diagram			

*1. Refer to Reference Accuracy and Temperature Coefficient According to the Input Type and Measurement Temperature *1 on page A-52.

● Reference Accuracy and Temperature Coefficient According to the Input Type and Measurement Temperature *1

NX-TS□□02/TS□□04

Conversion time	Input type		Measurement temperature (°C)	Reference accuracy °C (%) *3	Temperature coefficient °C/°C *4 (ppm/°C *5)
	Input type *2	Temperature range (°C)			
10 ms	K	-200 to 1300	-200 to 1300	±0.75 (±0.05%)	±0.08 (±50 ppm/°C)
60 ms	K	-20 to 600 (High Resolution)	-20 to 600	±0.3 (±0.05%)	±0.03 (±48 ppm/°C)
	J	-200 to 1200	-200 to 0	±0.7 (±0.05%)	±0.13 (±96 ppm/°C)
			0 to 1200		±0.06 (±42 ppm/°C)
	J	-20 to 600 (High Resolution)	-20 to 600	±0.3 (±0.05%)	±0.04 (±72 ppm/°C)
	T	-200 to 400	-200 to -180	±1.3 (±0.22%)	±0.05 (±75 ppm/°C)
			-180 to 0	±0.7 (±0.12%)	
			0 to 400	±0.33 (±0.055%)	
	E	-200 to 1000	-200 to 0	±0.6 (±0.05%)	±0.12 (±100 ppm/°C)
			0 to 1000		±0.06 (±50 ppm/°C)
	L	-200 to 900	-200 to 900	±0.5 (±0.05%)	±0.04 (±40 ppm/°C)
	U	-200 to 600	-200 to -100	±0.7 (±0.09%)	±0.06 (±75 ppm/°C)
			-100 to 0	±0.5 (±0.07%)	
			0 to 600	±0.4 (±0.05%)	
	N	-200 to 1300	-200 to -150	±1.6 (±0.11%)	±0.11 (±70 ppm/°C)
			-150 to -100	±0.75 (±0.05%)	
			-100 to 1300		
	R	-50 to 1700	-50 to 0	±3.2 (±0.19%)	±0.13 (±77 ppm/°C)
			0 to 100	±2.5 (±0.15%)	±0.11 (±60 ppm/°C)
			100 to 1700	±1.75 (±0.1%)	
	S	-50 to 1700	-50 to 0	±3.2 (±0.19%)	±0.13 (±77 ppm/°C)
0 to 100			±2.5 (±0.15%)	±0.11 (±60 ppm/°C)	
100 to 1700			±1.75 (±0.1%)		
WRe5-26	0 to 2300	0 to 1500	±1.15 (±0.05%)	±0.13 (±58 ppm/°C)	
		1500 to 2200		±0.21 (±91 ppm/°C)	
		2200 to 2300			±1.4 (±0.07%)
PL II	0 to 1300	0 to 1300	±0.65 (±0.05%)	±0.07 (±57 ppm/°C)	
Pt100	-200 to 850	-200 to -50	±0.5 (±0.05%)	±0.08 (±78 ppm/°C)	
		-50 to 150	±0.21 (±0.02%)	±0.03 (±29 ppm/°C)	
		150 to 850	±0.5 (±0.05%)	±0.08 (±78 ppm/°C)	
Pt1000	-200 to 850	-200 to 850	±0.5 (±0.05%)	±0.09 (±85 ppm/°C)	

NX-TS□□01

Conversion time	Input type		Measurement temperature (°C)	Reference accuracy °C (%) *3	Temperature coefficient °C/°C *4 (ppm/°C *5)
	Input type	Temperature range (°C)			
250 ms	K	-200 to 1300	-200 to -100	±1.5 (±0.1%)	±0.15 (±100 ppm/°C)
			-100 to 400		±0.30 (±200 ppm/°C)
			400 to 1300		±0.38 (±250 ppm/°C)
	J	-200 to 1200	-200 to 400	±1.4 (±0.1%)	±0.14 (±100 ppm/°C)
			400 to 900	±1.2 (±0.09%)	±0.28 (±200 ppm/°C)
			900 to 1200		±0.35 (±250 ppm/°C)
	T	-200 to 400	-200 to -100	±1.2 (±0.2%)	±0.30 (±500 ppm/°C)
			-100 to 400		±0.12 (±200 ppm/°C)
	E	-200 to 1000	-200 to 400	±1.2 (±0.1%)	±0.12 (±100 ppm/°C)
			400 to 700	±2.0 (±0.17%)	±0.24 (±200 ppm/°C)
			700 to 1000		±0.30 (±250 ppm/°C)
	L	-200 to 900	-200 to 300	±1.1 (±0.1%)	±0.11 (±100 ppm/°C)
			300 to 700	±2.2 (±0.2%)	±0.22 (±200 ppm/°C)
			700 to 900		±0.28 (±250 ppm/°C)
	U	-200 to 600	-200 to 400	±1.2 (±0.15%)	±0.12 (±150 ppm/°C)
			400 to 600	±1.0 (±0.13%)	
	N	-200 to 1300	-200 to 400	±1.5 (±0.1%)	±0.30 (±200 ppm/°C)
			400 to 1000		
			1000 to 1300		±0.38 (±250 ppm/°C)
	R	-50 to 1700	-50 to 500	±1.75 (±0.1%)	±0.44 (±250 ppm/°C)
			500 to 1200	±2.5 (±0.15%)	
			1200 to 1700		
	S	-50 to 1700	-50 to 600	±1.75 (±0.1%)	±0.44 (±250 ppm/°C)
			600 to 1100	±2.5 (±0.15%)	
			1100 to 1700		
	B	0 to 1800	0.0 to 400.0	Reference accuracy does not apply	Reference accuracy does not apply
			400 to 1200	±3.6 (±0.2%)	±0.45 (±250 ppm/°C)
			1200 to 1800	±5.0 (±0.28%)	±0.54 (±300 ppm/°C)
WRe5-26	0 to 2300	0 to 300	±1.15 (±0.05%)	±0.46 (±200 ppm/°C)	
		300 to 800	±2.3 (±0.1%)		
		800 to 1500	±3.0 (±0.13%)		
		1500 to 2300			±0.691 (±300 ppm/°C)
PLII	0 to 1300	0 to 400	±1.3 (±0.1%)	±0.23 (±200 ppm/°C)	
		400 to 800	±2.0 (±0.15%)	±0.39 (±300 ppm/°C)	
		800 to 1300		±0.65 (±500 ppm/°C)	
Pt100	-200 to 850	-200 to 300	±1.0 (±0.1%)	±0.1 (±100 ppm/°C)	
		300 to 700	±2.0 (±0.2%)	±0.2 (±200 ppm/°C)	
		700 to 850	±2.5 (±0.25%)	±0.25 (±250 ppm/°C)	
Pt1000	-200 to 850	-200 to 300	±1.0 (±0.1%)	±0.1 (±100 ppm/°C)	
		300 to 700	±2.0 (±0.2%)	±0.2 (±200 ppm/°C)	
		700 to 850	±2.5 (±0.25%)	±0.25 (±250 ppm/°C)	

- *1. To convert the temperature unit from Celsius to Fahrenheit, use the following equation.
Fahrenheit temperature (°F) = Celsius temperature (°C) x 1.8 + 32
- *2. If there is more than one input range for the same input type, the one with narrower input range has higher resolution.
- *3. For a thermocouple input type Temperature Input Unit, the overall accuracy is guaranteed for a set consisting of a cold junction sensor that is mounted on the terminal block and a Temperature Input Unit. Be sure to use the terminal block and Temperature Input Unit with the same calibration control number together. For the 24 mm wide model, also be sure the left and right terminal blocks are correctly attached.

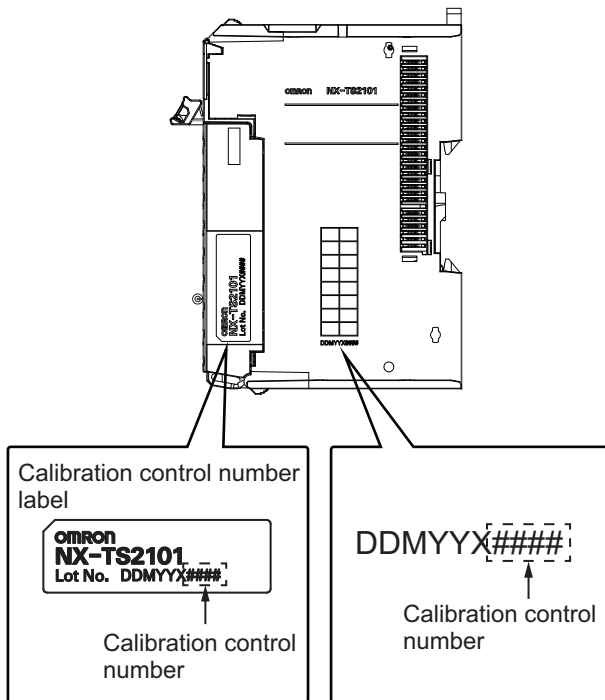

- *4. An error for a measured value when the ambient temperature changes by 1°C.
The following formula is used to calculate the error of the measured value.
Overall accuracy = Reference accuracy + Temperature characteristic x Change in the ambient temperature + Cold junction compensation error
(Calculation example)

Conditions

Item	Description
Ambient temperature	30°C
Measured value	100°C
NX Unit	NX-TS2101
Thermocouple	K thermocouple

The characteristic values are formulated from the data sheet or reference accuracy and temperature coefficient table under the above conditions

Item	Description
Reference accuracy	-100 to 400°C: ±1.5°C
Temperature coefficient	-100 to 400°C: ±0.30°C/°C
Change in the ambient temperature	25°C -> 30°C 5 deg
Cold junction compensation error	±1.2°C

Therefore,

$$\begin{aligned}
 \text{Overall accuracy} &= \text{Reference accuracy} + \text{Temperature characteristic} \times \text{Change in the ambient temperature} + \text{Cold junction compensation error} \\
 &= \pm 1.5^\circ\text{C} + (\pm 0.30^\circ\text{C}/^\circ\text{C}) \times 5 \text{ deg} + \pm 1.2^\circ\text{C} \\
 &= \pm 4.2^\circ\text{C}
 \end{aligned}$$

- *5. The ppm value is for the full scale of the input range.

● **Cold Junction Compensation Error Specifications for Units That Take a Thermocouple Input Type**

The cold junction compensation error for Units that take a thermocouple input type is restricted as follows according to the installation orientation and the power consumption of adjacent Units *1.

(a) For upright installation, when the power consumption is 1.5 W or less for both the left and right adjacent Units

The cold junction compensation error is $\pm 1.2^{\circ}\text{C}$.

However, there are some exceptions according to the input type and temperature range. The conditions and the cold junction compensation errors are given in the following table.

Input type and temperature range	Cold junction compensation error
T below -90°C	$\pm 3.0^{\circ}\text{C}$
J, E, K and N below -100°C	
U, L and PLII	
R and S below 200°C	
B below 400°C	Not guaranteed
W	$\pm 3.0^{\circ}\text{C}$

(b) For upright installation, when the power consumption of either the left or the right adjacent Unit is more than 1.5 W but less than 3.9 W or for any installation other than upright, when the power consumption of both the left and right adjacent Units is less than 3.9 W

The cold junction compensation error is $\pm 4.0^{\circ}\text{C}$.

However, there are some exceptions according to the input type and temperature range. The conditions and the cold junction compensation errors are given in the following table.

Input type and temperature range	Cold junction compensation error
T below -90°C	$\pm 7.0^{\circ}\text{C}$
J, E, K and N below -100°C	
U, L and PLII	
R and S below 200°C	
B below 400°C	Not guaranteed
W	$\pm 9.0^{\circ}\text{C}$

(c) When the power consumption exceeds 3.9 W for either the left or right adjacent Unit

Do not use the above condition (c) because the cold junction compensation error is not guaranteed in this condition.

*1. The power consumption of adjacent Units is the total of the following values.
 The power consumption of the NX Unit power supply and I/O power supply for the NX Units adjacent to the Temperature Input Unit. If the adjacent Unit is an Input Unit, it is the total power consumption according to the input current.

A-2 Dimensions

A-2-1 Screwless Clamping Terminal Block Type

12 mm Width

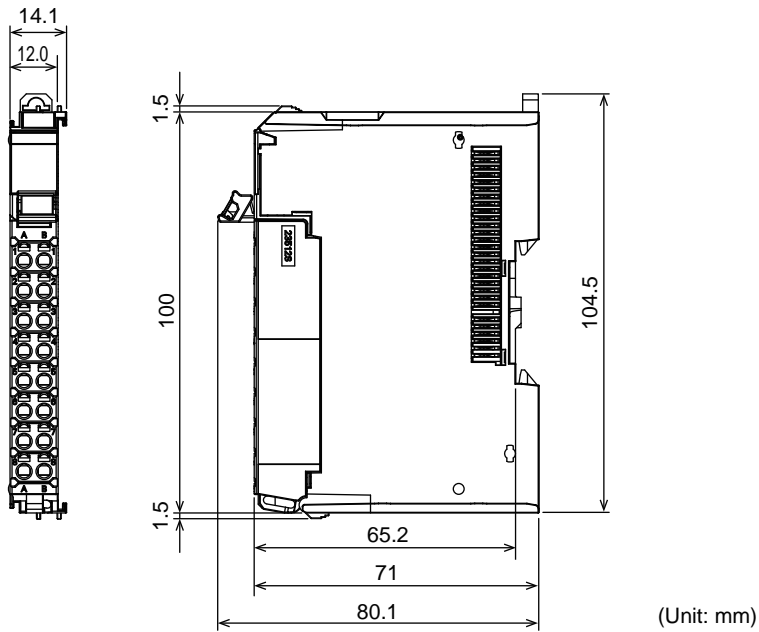

24 mm Width

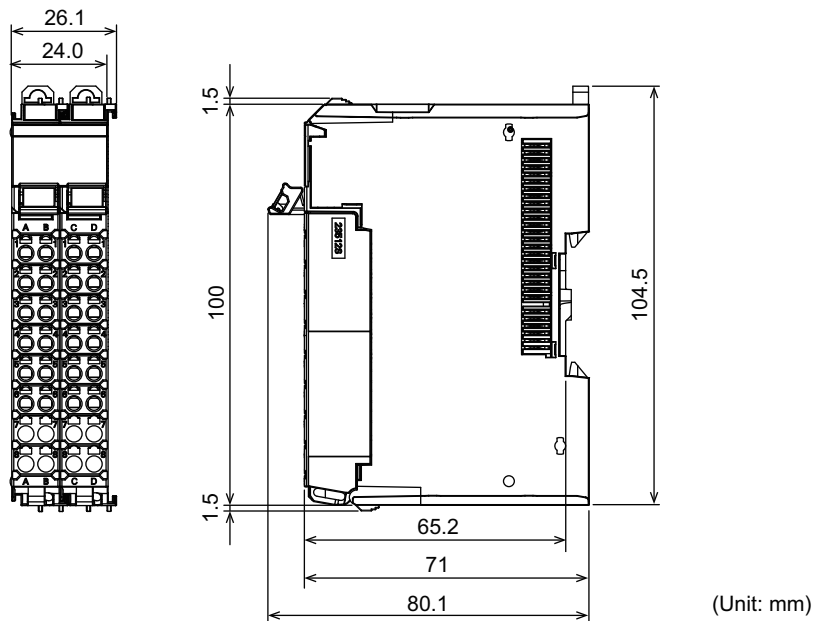

Installation Height

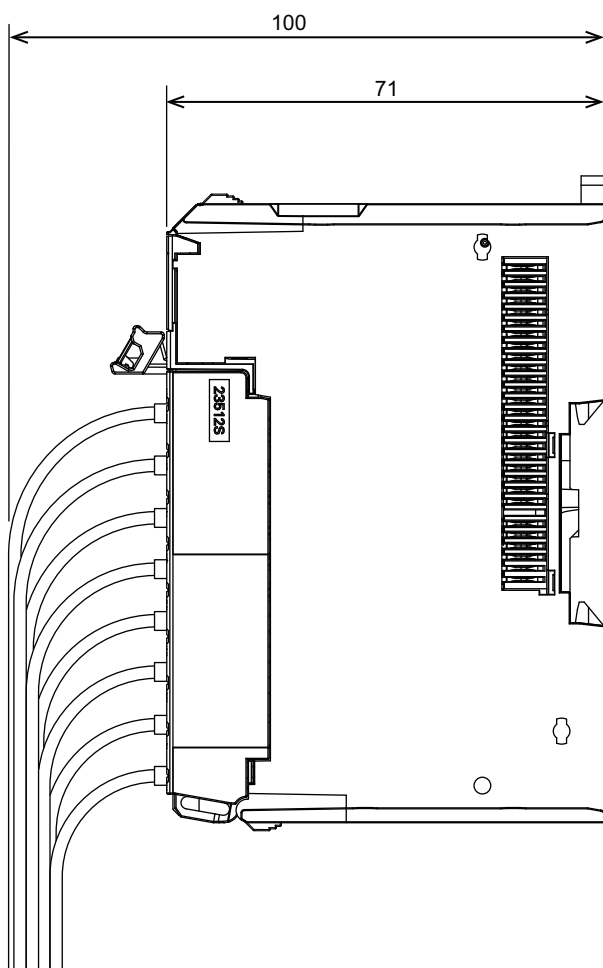

(Unit: mm)

A-3 List of NX Objects

A-3-1 Format of Object Descriptions

In this manual, NX objects are described with the following format.

Index (hex)	Subindex (hex)	Object name	Default value	Data range	Unit	Data type	Access	I/O allocation	Data attribute

- Index (Hex) : This is the index of the NX object that is expressed as a four-digit hexadecimal number.
- Subindex (Hex) : This is the subindex of the NX object that is expressed as a two-digit hexadecimal number.
- Object name : This is the name of the object. For a subindex, this is the name of the subindex.
- Default value : This is the value that is set by default.
- Data range : For a read-only (RO) NX object, this is the range of the data you can read. For a read-write (RW) NX object, this is the setting range of the data.
- Unit : The unit is the physical units.
- Data type : This is the data type of the object.
- Access : This data tells if the object is read-only or read/write.
 RO: Read only
 RW: Read/write
- I/O allocation : This tells whether I/O allocation is allowed.
- Data attribute : This is the timing when changes to writable NX objects are enabled.
 Y: Enabled by restarting
 N: Enabled at all times
 —: Write-prohibited

A-3-2 Analog Input Units

Unit Information Objects

This object gives the product information.

Index (hex)	Subindex (hex)	Object name	Default value	Data range	Unit	Data type	Access	I/O allocation	Data attribute
1000	–	NX Bus Identify	–	–	–	–	–	–	–
	00	Number of Entries	7	7	–	USINT	RO	Not possible	–
	02	Model	*1	–	–	ARRAY [0..11] OF BYTE	RO	Not possible	–
	03	Device Type	*2	–	–	UDINT	RO	Not possible	–
	04	Product Code	*3	–	–	UDINT	RO	Not possible	–
	05	Vendor Code	00000001 hex *4	–	–	UDINT	RO	Not possible	–
	06	Unit Version	*5	–	–	UDINT	RO	Not possible	–
	07	Serial Number	*6	00000000 to FFFFFFFF hex	–	UDINT	RO	Not possible	–
1001	–	Production Info	–	–	–	–	–	–	–
	00	Number of Entries	2	2	–	USINT	RO	Not possible	–
	01	Lot Number	*7	00000000 to FFFFFFFF hex	–	UDINT	RO	Not possible	–
	02	Hardware Version	*8	–	–	ARRAY [0..19] OF BYTE	RO	Not possible	–

*1. The product models are assigned in ascending order from the lowest number of array elements. Any remainder elements are filled with spaces.

*2. The device types are assigned for each product Unit type.
Bits 0 to 31: Device type

*3. The product codes are assigned for each product model.
Bits 0 to 31: Product code

*4. OMRON vendor code

*5. Bits 24 to 31: Integer part of the Unit version.
Bits 16 to 23: Fractional part of the Unit version.
Bits 0 to 15: Reserved
(Example) For Ver.1.0, 0100□□□□ hex

*6. A unique serial number is assigned for each product unit.
Bits 0 to 31: Serial number

*7. The year, month, and day of production are assigned to the "lot number".
Bits 24 to 31: Date of production
Bits 16 to 23: Month of production
Bits 8 to 15: Year of production
Bits 0 to 7: Reserved

*8. The hardware version is assigned in ascending order from the earliest number of array elements. Any remainder elements are filled with spaces.

Objects That Accept I/O Allocations

These objects accept I/O allocations.

You cannot access the objects that are described below with the Read NX Unit Object instruction or the Write NX Unit Object instruction.

Refer to the *NJ-series Instructions Reference Manual* (Cat. No. W502-E1-07 or later) for details on the Read NX Unit Object instruction or the Write NX Unit Object instruction.

Index (hex)	Subindex (hex)	Object name	Default value	Data range	Unit	Data type	Access	I/O allocation	Data attribute
6000	-	Analog Input Value	-	-	-	-	-	-	-
	00	Number of Entries	*1	*1	-	USINT	RO	Not possible	-
	01	Ch1 Analog Input Value	0	-32768 to 32767	-	INT	RO	Possible	-
	02	Ch2 Analog Input Value	0	-32768 to 32767	-	INT	RO	Possible	-
	03	Ch3 Analog Input Value	0	-32768 to 32767	-	INT	RO	Possible	-
	04	Ch4 Analog Input Value	0	-32768 to 32767	-	INT	RO	Possible	-
	05	Ch5 Analog Input Value	0	-32768 to 32767	-	INT	RO	Possible	-
	06	Ch6 Analog Input Value	0	-32768 to 32767	-	INT	RO	Possible	-
	07	Ch7 Analog Input Value	0	-32768 to 32767	-	INT	RO	Possible	-
	08	Ch8 Analog Input Value	0	-32768 to 32767	-	INT	RO	Possible	-

*1. The default value and data range for Number of Entries are as follows.

NX Units	Default value	Data range
NX-AD2203/AD2204/AD2208/ AD2603/AD2604/AD2608	2	2
NX-AD3203/AD3204/AD3208/ AD3603/AD3604/AD3608	4	4
NX-AD4203/AD4204/AD4208/ AD4603/AD4604/AD4608	8	8
Other models	0	0

Other Objects

This section lists other objects.

Index (hex)	Subindex (hex)	Object name	Default value	Data range	Unit	Data type	Access	I/O allocation	Data attribute
5002	–	Input Enable/Disable Setting	–	–	–	–	–	–	–
	00	Number of Entries	*1	*1	–	USINT	RO	Not possible	–
	01	Ch1 Enable/Disable	TRUE	TRUE or FALSE *2	–	BOOL	RW	Not possible	Y
	02	Ch2 Enable/Disable	TRUE		–	BOOL	RW	Not possible	Y
	03	Ch3 Enable/Disable	TRUE		–	BOOL	RW	Not possible	Y
	04	Ch4 Enable/Disable	TRUE		–	BOOL	RW	Not possible	Y
	05	Ch5 Enable/Disable	TRUE		–	BOOL	RW	Not possible	Y
	06	Ch6 Enable/Disable	TRUE		–	BOOL	RW	Not possible	Y
	07	Ch7 Enable/Disable	TRUE		–	BOOL	RW	Not possible	Y
	08	Ch8 Enable/Disable	TRUE		–	BOOL	RW	Not possible	Y

*1. The default value and data range for Number of Entries are as follows.

NX Units	Default value	Data range
NX-AD2203/AD2204/AD2208/ AD2603/AD2604/AD2608	2	2
NX-AD3203/AD3204/AD3208/ AD3603/AD3604/AD3608	4	4
NX-AD4203/AD4204/AD4208/ AD4603/AD4604/AD4608	8	8
Other models	0	0

*2. The meanings of the set values for Ch□ Enable/Disable are as follows.

Set value	Meaning
FALSE	Disable
TRUE	Enable

Index (hex)	Subindex (hex)	Object name	Default value	Data range	Unit	Data type	Access	I/O allocation	Data attribute
5003	–	Input Range Setting	–	–	–	–	–	–	–
	00	Number of Entries	*1	*1	–	USINT	RO	Not possible	–
	01	Ch1 Range Setting	*2	*2	–	UINT	RW	Not possible	Y
	02	Ch2 Range Setting			–	UINT	RW	Not possible	Y
	03	Ch3 Range Setting			–	UINT	RW	Not possible	Y
	04	Ch4 Range Setting			–	UINT	RW	Not possible	Y
	05	Ch5 Range Setting			–	UINT	RW	Not possible	Y
	06	Ch6 Range Setting			–	UINT	RW	Not possible	Y
	07	Ch7 Range Setting			–	UINT	RW	Not possible	Y
	08	Ch8 Range Setting			–	UINT	RW	Not possible	Y

*1. The default value and data range for Number of Entries are as follows.

NX Units	Default value	Data range
NX-AD2203/AD2204/AD2208/ AD2603/AD2604/AD2608	2	2
NX-AD3203/AD3204/AD3208/ AD3603/AD3604/AD3608	4	4
NX-AD4203/AD4204/AD4208/ AD4603/AD4604/AD4608	8	8
Other models	0	0

*2. The default value and data range for Ch□ Range Setting are as follows.

NX Units	Set value	Meaning	Default value	Data range
NX-AD2203/AD2204/AD2208/ AD3203/AD3204/AD3208/ AD4203/AD4204/AD4208	0	4 to 20 mA	0	0
	1	0 to 10 V		
	2	-10 to +10 V		
	3	0 to 5 V		
	4	1 to 5 V		
	5	0 to 20 mA		

NX Units	Set value	Meaning	Default value	Data range
NX-AD2603/AD2604/AD2608/ AD3603/AD3604/AD3608/ AD4603/AD4604/AD4608	0	4 to 20 mA	2	2
	1	0 to 10 V		
	2	-10 to +10 V		
	3	0 to 5 V		
	4	1 to 5 V		
	5	0 to 20 mA		

A

Index (hex)	Subindex (hex)	Object name	Default value	Data range	Unit	Data type	Access	I/O allocation	Data attribute
5004	–	Input Moving Average Time	–	–	–	–	–	–	–
	00	Number of Entries	*1	*1	–	USINT	RO	Not possible	–
	01	Ch1 Input Moving Average Time	0	*2	μs	UINT	RW	Not possible	Y
	02	Ch2 Input Moving Average Time	0			UINT	RW	Not possible	Y
	03	Ch3 Input Moving Average Time	0			UINT	RW	Not possible	Y
	04	Ch4 Input Moving Average Time	0			UINT	RW	Not possible	Y
	05	Ch5 Input Moving Average Time	0			UINT	RW	Not possible	Y
	06	Ch6 Input Moving Average Time	0			UINT	RW	Not possible	Y
	07	Ch7 Input Moving Average Time	0			UINT	RW	Not possible	Y
	08	Ch8 Input Moving Average Time	0			UINT	RW	Not possible	Y

*1. The default value and data range for Number of Entries are as follows.

NX Units	Default value	Data range
NX-AD2203/AD2204/AD2208/ AD2603/AD2604/AD2608	2	2
NX-AD3203/AD3204/AD3208/ AD3603/AD3604/AD3608	4	4
NX-AD4203/AD4204/AD4208/ AD4603/AD4604/AD4608	8	8
Other models	0	0

*2. The setting range of Ch□ Input Moving Average Time depends on the model. The input moving average time data range for each type is as follows.

NX Units	Data range
NX-AD2203/AD2204/AD2603/ AD2604/AD3203/AD3204/ AD3603/AD3604/AD4203/ AD4204/AD4603/AD4604	0 to 32000
NX-AD2208/AD2608/AD3208/ AD3608/AD4208/AD4608	0 to 640

Index (hex)	Subindex (hex)	Object name	Default value	Data range	Unit	Data type	Access	I/O allocation	Data attribute
5005	–	Disconnection Detection Status	–	–	–	–	–	–	–
	00	Number of Entries	*1	*1	–	USINT	RO	Not possible	–
	01	Ch1 Disconnection Detection Status	FALSE	TRUE or FALSE *2	–	BOOL	RO	Not possible	–
	02	Ch2 Disconnection Detection Status	FALSE		–	BOOL	RO	Not possible	–
	03	Ch3 Disconnection Detection Status	FALSE		–	BOOL	RO	Not possible	–
	04	Ch4 Disconnection Detection Status	FALSE		–	BOOL	RO	Not possible	–
	05	Ch5 Disconnection Detection Status	FALSE		–	BOOL	RO	Not possible	–
	06	Ch6 Disconnection Detection Status	FALSE		–	BOOL	RO	Not possible	–
	07	Ch7 Disconnection Detection Status	FALSE		–	BOOL	RO	Not possible	–
	08	Ch8 Disconnection Detection Status	FALSE		–	BOOL	RO	Not possible	–

*1. The default value and data range for Number of Entries are as follows.

NX Units	Default value	Data range
NX-AD2203/AD2204/AD2208/ AD2603/AD2604/AD2608	2	2
NX-AD3203/AD3204/AD3208/ AD3603/AD3604/AD3608	4	4
NX-AD4203/AD4204/AD4208/ AD4603/AD4604/AD4608	8	8
Other models	0	0

*2. The meanings of the set values for Ch□ Disconnection Detection Status are as follows.

Value	Meaning
FALSE	Disconnection Undetected
TRUE	Disconnection Detected

Index (hex)	Subindex (hex)	Object name	Default value	Data range	Unit	Data type	Access	I/O allocation	Data attribute
5006	–	Input Over Range/Under Range Status	–	–	–	–	–	–	–
	00	Number of Entries	*1	*1	–	USINT	RO	Not possible	–
	01	Ch1 Over Range Status	FALSE	TRUE or FALSE *2	–	BOOL	RO	Not possible	–
	02	Ch1 Under Range Status	FALSE		–	BOOL	RO	Not possible	–
	03	Ch2 Over Range Status	FALSE		–	BOOL	RO	Not possible	–
	04	Ch2 Under Range Status	FALSE		–	BOOL	RO	Not possible	–
	05	Ch3 Over Range Status	FALSE		–	BOOL	RO	Not possible	–
	06	Ch3 Under Range Status	FALSE		–	BOOL	RO	Not possible	–
	07	Ch4 Over Range Status	FALSE		–	BOOL	RO	Not possible	–
	08	Ch4 Under Range Status	FALSE		–	BOOL	RO	Not possible	–
	09	Ch5 Over Range Status	FALSE		–	BOOL	RO	Not possible	–
	0A	Ch5 Under Range Status	FALSE		–	BOOL	RO	Not possible	–
	0B	Ch6 Over Range Status	FALSE		–	BOOL	RO	Not possible	–
	0C	Ch6 Under Range Status	FALSE		–	BOOL	RO	Not possible	–
	0D	Ch7 Over Range Status	FALSE		–	BOOL	RO	Not possible	–
	0E	Ch7 Under Range Status	FALSE		–	BOOL	RO	Not possible	–
	0F	Ch8 Over Range Status	FALSE		–	BOOL	RO	Not possible	–
	10	Ch8 Under Range Status	FALSE		–	BOOL	RO	Not possible	–

*1. The default value and data range for Number of Entries are as follows.

NX Units	Default value	Data range
NX-AD2203/AD2204/AD2208/ AD2603/AD2604/AD2608	2	2
NX-AD3203/AD3204/AD3208/ AD3603/AD3604/AD3608	4	4
NX-AD4203/AD4204/AD4208/ AD4603/AD4604/AD4608	8	8
Other models	0	0

*2. The meanings of Ch□ Over Range Status/Ch□ Under Range Status are as follows.

Value	Meaning
FALSE	Over Range/Under Range Undetected
TRUE	Over Range/Under Range Detected

A-3-3 Analog Output Units

Unit Information Objects

This object gives the product information.

Index (hex)	Subindex (hex)	Object name	Default value	Data range	Unit	Data type	Access	I/O allocation	Data attribute
1000	–	NX Bus Identify	–	–	–	–	–	–	–
	00	Number of Entries	7	7	–	USINT	RO	Not possible	–
	02	Model	*1	–	–	ARRAY [0..11] OF BYTE	RO	Not possible	–
	03	Device Type	*2	–	–	UDINT	RO	Not possible	–
	04	Product Code	*3	–	–	UDINT	RO	Not possible	–
	05	Vendor Code	00000001 hex *4	–	–	UDINT	RO	Not possible	–
	06	Unit Version	*5	–	–	UDINT	RO	Not possible	–
	07	Serial Number	*6	00000000 to FFFFFFFF hex	–	UDINT	RO	Not possible	–
1001	–	Production Info	–	–	–	–	–	–	–
	00	Number of Entries	2	2	–	USINT	RO	Not possible	–
	01	Lot Number	*7	00000000 to FFFFFFFF hex	–	UDINT	RO	Not possible	–
	02	Hardware Version	*8	–	–	ARRAY [0..19] OF BYTE	RO	Not possible	–

*1. The product models are assigned in ascending order from the lowest number of array elements. Any remainder elements are filled with spaces.

*2. The device types are assigned for each product Unit type.
Bits 0 to 31: Device type

*3. The product codes are assigned for each product model.
Bits 0 to 31: Product code

*4. OMRON vendor code

*5. Bits 24 to 31: Integer part of the Unit version.
Bits 16 to 23: Fractional part of the Unit version.
Bits 0 to 15: Reserved
(Example) For Ver.1.0, 0100□□□□ hex

*6. A unique serial number is assigned for each product unit.
Bits 0 to 31: Serial number

*7. The year, month, and day of production are assigned to the "lot number".
Bits 24 to 31: Date of production
Bits 16 to 23: Month of production
Bits 8 to 15: Year of production
Bits 0 to 7: Reserved

*8. The hardware version is assigned in ascending order from the earliest number of array elements. Any remainder elements are filled with spaces.

Objects That Accept I/O Allocations

These objects accept I/O allocations.

You cannot access the objects that are described below with the Read NX Unit Object instruction or the Write NX Unit Object instruction.

Refer to the *NJ-series Instructions Reference Manual* (Cat. No. W502-E1-07 or later) for details on the Read NX Unit Object instruction or the Write NX Unit Object instruction.

Index (hex)	Subindex (hex)	Object name	Default value	Data range	Unit	Data type	Access	I/O allocation	Data attribute
7000	–	Analog Output Value	–	–	–	–	–	–	–
	00	Number of Entries	*1	*1	–	USINT	RO	Not possible	–
	01	Ch1 Analog Output Value	0	-32768 to 32767	–	INT	RW	Possible	N
	02	Ch2 Analog Output Value	0	-32768 to 32767	–	INT	RW	Possible	N
	03	Ch3 Analog Output Value	0	-32768 to 32767	–	INT	RW	Possible	N
	04	Ch4 Analog Output Value	0	-32768 to 32767	–	INT	RW	Possible	N

*1. The default value and data range for Number of Entries are as follows.

NX Units	Default value	Data range
NX-DA2203/DA2205/DA2603/DA2605	2	2
NX-DA3203/DA3205/DA3603/DA3605	4	4
Other models	0	0

Other Objects

This section lists other objects.

Index (hex)	Subindex (hex)	Object name	Default value	Data range	Unit	Data type	Access	I/O allocation	Data attribute
5010	–	Output Enabled/Disabled Setting	–	–	–	–	–	–	–
	00	Number of Entries	*1	*1	–	USINT	RO	Not possible	–
	01	Ch1 Enable/Disable	TRUE	TRUE or FALSE*2	–	BOOL	RW	Not possible	Y
	02	Ch2 Enable/Disable	TRUE		–	BOOL	RW	Not possible	Y
	03	Ch3 Enable/Disable	TRUE		–	BOOL	RW	Not possible	Y
	04	Ch4 Enable/Disable	TRUE		–	BOOL	RW	Not possible	Y

*1. The default value and data range for Number of Entries are as follows.

NX Units	Default value	Data range
NX-DA2203/DA2205/DA2603/DA2605	2	2
NX-DA3203/DA3205/DA3603/DA3605	4	4
Other models	0	0

*2. The meanings of the set values for Ch□ Enable/Disable are as follows.

Set value	Meaning
FALSE	Disable
TRUE	Enable

Index (hex)	Subindex (hex)	Object name	Default value	Data range	Unit	Data type	Access	I/O allocation	Data attribute
5011	–	Output Range Setting	–	–	–	–	–	–	–
	00	Number of Entries	*1	*1	–	USINT	RO	Not possible	–
	01	Ch1 Range Setting	*2	*2	–	UINT	RW	Not possible	Y
	02	Ch2 Range Setting			–	UINT	RW	Not possible	Y
	03	Ch3 Range Setting			–	UINT	RW	Not possible	Y
	04	Ch4 Range Setting			–	UINT	RW	Not possible	Y
–					UINT	RW	Not possible	Y	

*1. The default value and data range for Number of Entries are as follows.

NX Units	Default value	Data range
NX-DA2203/DA2205/DA2603/DA2605	2	2
NX-DA3203/DA3205/DA3603/DA3605	4	4
Other models	0	0

*2. The default value and data range for Ch□ Range Setting are as follows.

NX Units	Set value	Meaning	Default value	Data range
NX-DA2203/DA2205/DA3203/DA3205	0	4 to 20 mA	0	0
	1	0 to 10 V		
	2	-10 to +10 V		
	3	0 to 5 V		
	4	1 to 5 V		
	5	0 to 20 mA		
NX-DA2603/DA2605/DA3603/DA3605	0	4 to 20 mA	2	2
	1	0 to 10 V		
	2	-10 to +10 V		
	3	0 to 5 V		
	4	1 to 5 V		
	5	0 to 20 mA		

Index (hex)	Subindex (hex)	Object name	Default value	Data range	Unit	Data type	Access	I/O allocation	Data attribute
5012	–	Load Rejection Output Setting	–	–	–	–	–	–	–
	00	Number of Entries	*1	*1	–	USINT	RO	Not possible	–
	01	Ch1 Hold Value Setting	4	0 to 4 *2	–	USINT	RW	Not possible	Y
	02	Ch1 User-specified Value Setting	0	-32768 to 32767	–	INT	RW	Not possible	Y
	03	Ch2 Hold Value Setting	4	0 to 4 *2	–	USINT	RW	Not possible	Y
	04	Ch2 User-specified Value Setting	0	-32768 to 32767	–	INT	RW	Not possible	Y
	05	Ch3 Hold Value Setting	4	0 to 4 *2	–	USINT	RW	Not possible	Y
	06	Ch3 User-specified Value Setting	0	-32768 to 32767	–	INT	RW	Not possible	Y
	07	Ch4 Hold Value Setting	4	0 to 4 *2	–	USINT	RW	Not possible	Y
	08	Ch4 User-specified Value Setting	0	-32768 to 32767	–	INT	RW	Not possible	Y

*1. The default value and data range for Number of Entries are as follows.

NX Units	Default value	Data range
NX-DA2203/DA2205/DA2603/DA2605	2	2
NX-DA3203/DA3205/DA3603/DA3605	4	4
Other models	0	0

*2. The meanings of the set values for Ch□ Hold Value Setting are as follows.

Set value	Meaning
0	Hold Last State
1	Low Limit
2	High Limit
3	User Count
4	Zero Count

A-3-4 Temperature Input Units

Unit Information Objects

This object gives the product information.

Index (hex)	Subindex (hex)	Object name	Default value	Data range	Unit	Data type	Access	I/O allocation	Data attribute
1000	–	NX Bus Identify	–	–	–	–	–	–	–
	00	Number of Entries	7	7	–	USINT	RO	Not possible	–
	02	Model	*1	–	–	ARRAY [0..11] OF BYTE	RO	Not possible	–
	03	Device Type	*2	–	–	UDINT	RO	Not possible	–
	04	Product Code	*3	–	–	UDINT	RO	Not possible	–
	05	Vendor Code	00000001 hex *4	–	–	UDINT	RO	Not possible	–
	06	Unit Version	*5	–	–	UDINT	RO	Not possible	–
	07	Serial Number	*6	00000000 to FFFFFFFF hex	–	UDINT	RO	Not possible	–
1001	–	Production Info	–	–	–	–	–	–	–
	00	Number of Entries	2	2	–	USINT	RO	Not possible	–
	01	Lot Number	*7	00000000 to FFFFFFFF hex	–	UDINT	RO	Not possible	–
	02	Hardware Version	*8	–	–	ARRAY [0..19] OF BYTE	RO	Not possible	–

*1. The product models are assigned in ascending order from the lowest number of array elements. Any remainder elements are filled with spaces.

*2. The device types are assigned for each product Unit type.
Bits 0 to 31: Device type

*3. The product codes are assigned for each product model.
Bits 0 to 31: Product code

*4. OMRON vendor code

*5. Bits 24 to 31: Integer part of the Unit version.
Bits 16 to 23: Fractional part of the Unit version.
Bits 0 to 15: Reserved
(Example) For Ver.1.0, 0100□□□□ hex

*6. A unique serial number is assigned for each product unit.
Bits 0 to 31: Serial number

*7. The year, month, and day of production are assigned to the "lot number".
Bits 24 to 31: Date of production
Bits 16 to 23: Month of production
Bits 8 to 15: Year of production
Bits 0 to 7: Reserved

*8. The hardware version is assigned in ascending order from the earliest number of array elements. Any remainder elements are filled with spaces.

Objects That Accept I/O Allocations

These objects accept I/O allocations.

If you assign any of the objects that are described below to I/O, you cannot access those objects with the Read NX Unit Object instruction or the Write NX Unit Object instruction. Refer to the *NJ-series Instructions Reference Manual* (Cat. No. W502-E1-07 or later) for details on the Read NX Unit Object instruction or the Write NX Unit Object instruction.

Index (hex)	Subindex (hex)	Object name	Default value	Data range	Unit	Data type	Access	I/O allocation	Data attribute
6000	–	Channel Status	–	–	–	–	–	–	–
	00	Number of Entries	*1	*1	–	USINT	RO	Not possible	–
	01	Ch1 Status *2	0000 hex	0000 to FFFF hex	–	WORD	RO	Possible	–
	02	Ch2 Status *2	0000 hex	0000 to FFFF hex	–	WORD	RO	Possible	–
	03	Ch3 Status *2	0000 hex	0000 to FFFF hex	–	WORD	RO	Possible	–
	04	Ch4 Status *2	0000 hex	0000 to FFFF hex	–	WORD	RO	Possible	–

*1. The default value and data range for Number of Entries are as follows.

NX Units	Default value	Data range
NX-TS2101/TS2102/TS2104/TS2201/TS2202/TS2204	2	2
NX-TS3101/TS3102/TS3104/TS3201/TS3202/TS3204	4	4
Other models	0	0

*2. The meaning of each bit in Ch□ Status is as follows.

Bit	Meaning
0	Ch□ Sensor Disconnected Error
1	Ch□ Over Range
2	Ch□ Under Range
3	Ch□ Cold Junction Error
4	Ch□ AD Converter Error
5 to 16	Reserved

Index (hex)	Subindex (hex)	Object name	Default value	Data range	Unit	Data type	Access	I/O allocation	Data attribute
6001	–	Analog Input Measured Value INT	–	–	–	–	–	–	–
	00	Number of Entries	*1	*1	–	USINT	RO	Not possible	–
	01	Ch1 Measured Value INT	0	-32000 to 32000 *2	°C or °F	INT	RO	Possible	–
	02	Ch2 Measured Value INT	0	-32000 to 32000 *2		INT	RO	Possible	–
	03	Ch3 Measured Value INT	0	-32000 to 32000 *2		INT	RO	Possible	–
	04	Ch4 Measured Value INT	0	-32000 to 32000 *2		INT	RO	Possible	–

*1. The default value and data range for Number of Entries are as follows.

NX Units	Default value	Data range
NX-TS2101/TS2102/TS2104/TS2201/TS2202/TS2204	2	2
NX-TS3101/TS3102/TS3104/TS3201/TS3202/TS3204	4	4
Other models	0	0

*2. If an error occurs, the measured value is 32767.

Index (hex)	Subindex (hex)	Object name	Default value	Data range	Unit	Data type	Access	I/O allocation	Data attribute
6002	–	Analog Input Measured Value DINT	–	–	–	–	–	–	–
	00	Number of Entries	*1	*1	–	USINT	RO	Not possible	–
	01	Ch1 Measured Value DINT	0	-2147483000 to 2147483000 *2	°C or °F	DINT	RO	Possible	–
	02	Ch2 Measured Value DINT	0	-2147483000 to 2147483000 *2		DINT	RO	Possible	–
	03	Ch3 Measured Value DINT	0	-2147483000 to 2147483000 *2		DINT	RO	Possible	–
	04	Ch4 Measured Value DINT	0	-2147483000 to 2147483000 *2		DINT	RO	Possible	–

*1. The default value and data range for Number of Entries are as follows.

NX Units	Default value	Data range
NX-TS2101/TS2102/TS2104/TS2201/TS2202/TS2204	2	2
NX-TS3101/TS3102/TS3104/TS3201/TS3202/TS3204	4	4
Other models	0	0

*2. If an error occurs, the measured value is 2147483647.

Index (hex)	Subindex (hex)	Object name	Default value	Data range	Unit	Data type	Access	I/O allocation	Data attribute
6003	–	Analog Input Measured Value REAL	–	–	–	–	–	–	–
	00	Number of Entries	*1	*1	–	USINT	RO	Not possible	–
	01	Ch1 Measured Value REAL	0	-2147483000 to 2147483000 *2	°C or °F	REAL	RO	Possible	–
	02	Ch2 Measured Value REAL	0	-2147483000 to 2147483000 *2		REAL	RO	Possible	–
	03	Ch3 Measured Value REAL	0	-2147483000 to 2147483000 *2		REAL	RO	Possible	–
	04	Ch4 Measured Value REAL	0	-2147483000 to 2147483000 *2		REAL	RO	Possible	–

*1. The default value and data range for Number of Entries are as follows.

NX Units	Default value	Data range
NX-TS2101/TS2102/TS2104/TS2201/TS2202/TS2204	2	2
NX-TS3101/TS3102/TS3104/TS3201/TS3202/TS3204	4	4
Other models	0	0

*2. If an error occurs, the measured value is 1.0E + 10.

Other Objects

This section lists other objects.

Index (hex)	Subindex (hex)	Object name	Default value	Data range	Unit	Data type	Access	I/O allocation	Data attribute
5000	–	Channel Enable/Disable Setting	–	–	–	–	–	–	–
	00	Number of Entries	*1	*1	–	USINT	RO	Not possible	–
	01	Ch1 Enable/Disable	TRUE	TRUE or FALSE *2	–	BOOL	RW	Not possible	Y
	02	Ch2 Enable/Disable	TRUE			BOOL	RW	Not possible	Y
	03	Ch3 Enable/Disable	TRUE			BOOL	RW	Not possible	Y
	04	Ch4 Enable/Disable	TRUE			BOOL	RW	Not possible	Y

*1. The default value and data range for Number of Entries are as follows.

NX Units	Default value	Data range
NX-TS2101/TS2102/TS2104/TS2201/TS2202/TS2204	2	2
NX-TS3101/TS3102/TS3104/TS3201/TS3202/TS3204	4	4
Other models	0	0

*2. The meanings of the set values for Ch□ Enable/Disable are as follows.

Set value	Meaning
FALSE	Disable
TRUE	Enable

Index (hex)	Subindex (hex)	Object name	Default value	Data range	Unit	Data type	Access	I/O allocation	Data attribute
5001	–	Input Type Setting	–	–	–	–	–	–	–
	00	Number of Entries	*1	*1	–	USINT	RO	Not possible	–
	01	Ch1 Input Type	*2	*2	–	USINT	RW	Not possible	Y
	02	Ch2 Input Type				USINT	RW	Not possible	Y
	03	Ch3 Input Type				USINT	RW	Not possible	Y
	04	Ch4 Input Type				USINT	RW	Not possible	Y

*1. The default value and data range for Number of Entries are as follows.

NX Units	Default value	Data range
NX-TS2101/TS2102/TS2104/TS2201/TS2202/TS2204	2	2
NX-TS3101/TS3102/TS3104/TS3201/TS3202/TS3204	4	4
Other models	0	0

*2. The meaning of the set value, default value and data range for Ch□ Input Type are as follows.

Meanings of the set values for Ch□ Input Type

Set value	Meaning
15	K -200 to 1300°C
16	K -20 to 600°C (High Resolution)
17	J -200 to 1200°C
18	J -20 to 600°C (High Resolution)
19	T -200 to 400°C
20	E -200 to 1000°C
21	L -200 to 900°C
22	U -200 to 600°C
23	N -200 to 1300°C
24	R -50 to 1700°C
25	S -50 to 1700°C
26	B 0 to 1800°C
27	W 0 to 2300°C
28	PL II 0 to 1300°C
0	Pt100 (3wire) -200 to 850°C
7	Pt1000 (3wire) -200 to 850°C

Default value and data range for Ch□ Input Type

- NX-TS□1□□

NX Units	Default value	Data range
NX-TS2101/TS3101	15	15, 17, 19 to 28
NX-TS2102/TS2104/TS3102/TS3104	15	15 to 28

- NX-TS□2□□

NX Units	Default value	Data range
NX-TS2201/TS2204/TS3201/TS3204	0	0, 7
NX-TS2202/TS3202	0	0

Index (hex)	Subindex (hex)	Object name	Default value	Data range	Unit	Data type	Access	I/O allocation	Data attribute
5002	–	Cold Junction Compensation Enable/Disable Setting	–	–	–	–	–	–	–
	00	Number of Entries	*1	*1	–	USINT	RO	Not possible	–
	01	Ch1 Cold Junction Compensation Enable/Disable	TRUE	TRUE or FALSE *2	–	BOOL	RW	Not possible	Y
	02	Ch2 Cold Junction Compensation Enable/Disable	TRUE			BOOL	RW	Not possible	Y
	03	Ch3 Cold Junction Compensation Enable/Disable	TRUE			BOOL	RW	Not possible	Y
	04	Ch4 Cold Junction Compensation Enable/Disable	TRUE			BOOL	RW	Not possible	Y

*1. The default value and data range for Number of Entries are as follows.

NX Units	Default value	Data range
NX-TS2101/TS2102/TS2104/TS2201/TS2202/TS2204	2	2
NX-TS3101/TS3102/TS3104/TS3201/TS3202/TS3204	4	4
Other models	0	0

*2. The meanings of the set values for Ch□ Cold Junction Compensation Enable/Disable are as follows.

Set value	Meaning
FALSE	Disable
TRUE	Enable

Index (hex)	Subindex (hex)	Object name	Default value	Data range	Unit	Data type	Access	I/O allocation	Data attribute
5003	–	Decimal Point Position Setting	–	–	–	–	–	–	–
	00	Number of Entries	*1	*1	–	USINT	RO	Not possible	–
	01	Ch1 Decimal Point Position	1	0/1/2 *2	–	UINT	RW	Not possible	Y
	02	Ch2 Decimal Point Position	1			UINT	RW	Not possible	Y
	03	Ch3 Decimal Point Position	1			UINT	RW	Not possible	Y
	04	Ch4 Decimal Point Position	1			UINT	RW	Not possible	Y

*1. The default value and data range for Number of Entries are as follows.

NX Units	Default value	Data range
NX-TS2101/TS2102/TS2104/TS2201/TS2202/TS2204	2	2
NX-TS3101/TS3102/TS3104/TS3201/TS3202/TS3204	4	4
Other models	0	0

*2. The meanings of the set values for Ch□ Decimal Point Position are as follows.

Set value	Meaning
0	×1 °C or °F
1	×0.1 °C or °F
2	×0.01 °C or °F

Index (hex)	Subindex (hex)	Object name	Default value	Data range	Unit	Data type	Access	I/O allocation	Data attribute
5004	–	Temperature Unit Setting	–	–	–	–	–	–	–
	00	Number of Entries	*1	*1	–	USINT	RO	Not possible	–
	01	Ch1 Temperature Unit	0	0/1 *2	–	UINT	RW	Not possible	Y
	02	Ch2 Temperature Unit	0			UINT	RW	Not possible	Y
	03	Ch3 Temperature Unit	0			UINT	RW	Not possible	Y
	04	Ch4 Temperature Unit	0			UINT	RW	Not possible	Y

*1. The default value and data range for Number of Entries are as follows.

NX Units	Default value	Data range
NX-TS2101/TS2102/TS2104/TS2201/TS2202/TS2204	2	2
NX-TS3101/TS3102/TS3104/TS3201/TS3202/TS3204	4	4
Other models	0	0

*2. The meanings of the set values for Ch□ Temperature Unit are as follows.

Set value	Meaning
0	°C
1	°F

Index (hex)	Subindex (hex)	Object name	Default value	Data range	Unit	Data type	Access	I/O allocation	Data attribute
5005	–	Input Moving Average Time	–	–	–	–	–	–	–
	00	Number of Entries	*1	*1	–	USINT	RO	Not possible	–
	01	Ch1 Input Moving Average Time	0	*2	ms	UINT	RW	Not possible	Y
	02	Ch2 Input Moving Average Time	0	*2	ms	UINT	RW	Not possible	Y
	03	Ch3 Input Moving Average Time	0	*2	ms	UINT	RW	Not possible	Y
	04	Ch4 Input Moving Average Time	0	*2	ms	UINT	RW	Not possible	Y

*1. The default value and data range for Number of Entries are as follows.

NX Units	Default value	Data range
NX-TS2101/TS2102/TS2104/TS2201/TS2202/TS2204	2	2
NX-TS3101/TS3102/TS3104/TS3201/TS3202/TS3204	4	4
Other models	0	0

*2. The data range of Ch□ Input Moving Average Time depends on the model. The descriptions for each model are as below.

NX Units	Data range
NX-TS□□01	0 to 32000
NX-TS□□02	0 to 1280
NX-TS□□04	0 to 7680

Index (hex)	Subindex (hex)	Object name	Default value	Data range	Unit	Data type	Access	I/O allocation	Data attribute
5007	–	Sensor Disconnected Error Status	–	–	–	–	–	–	–
	00	Number of Entries	*1	*1	–	USINT	RO	Not possible	–
	01	Ch1 Sensor Disconnected Error Status	FALSE	TRUE or FALSE *2	–	BOOL	RO	Not possible	–
	02	Ch2 Sensor Disconnected Error Status	FALSE						
	03	Ch3 Sensor Disconnected Error Status	FALSE						
	04	Ch4 Sensor Disconnected Error Status	FALSE						

*1. The default value and data range for Number of Entries are as follows.

NX Units	Default value	Data range
NX-TS2101/TS2102/TS2104/TS2201/TS2202/TS2204	2	2
NX-TS3101/TS3102/TS3104/TS3201/TS3202/TS3204	4	4
Other models	0	0

*2. The meanings of Ch□ Sensor Disconnected Error Status are as follows.

Value	Meaning
FALSE	Normal
TRUE	Disconnection Detected

Index (hex)	Subindex (hex)	Object name	Default value	Data range	Unit	Data type	Access	I/O allocation	Data attribute
5008	–	Measured Value Over Range Status	–	–	–	–	–	–	–
	00	Number of Entries	*1	*1	–	USINT	RO	Not possible	–
	01	Ch1 Measured Value Over Range	FALSE	TRUE or FALSE *2	–	BOOL	RO	Not possible	–
	02	Ch2 Measured Value Over Range	FALSE			BOOL	RO	Not possible	–
	03	Ch3 Measured Value Over Range	FALSE			BOOL	RO	Not possible	–
	04	Ch4 Measured Value Over Range	FALSE			BOOL	RO	Not possible	–

*1. The default value and data range for Number of Entries are as follows.

NX Units	Default value	Data range
NX-TS2101/TS2102/TS2104/TS2201/TS2202/TS2204	2	2
NX-TS3101/TS3102/TS3104/TS3201/TS3202/TS3204	4	4
Other models	0	0

*2. The meanings of Ch□ Measured Value Over Range are as follows.

Value	Meaning
FALSE	Normal
TRUE	Over Range Detected

Index (hex)	Subindex (hex)	Object name	Default value	Data range	Unit	Data type	Access	I/O allocation	Data attribute
5009	–	Measured Value Under Range Status	–	–	–	–	–	–	–
	00	Number of Entries	*1	*1	–	USINT	RO	Not possible	–
	01	Ch1 Measured Value Under Range	FALSE	TRUE or FALSE*2	–	BOOL	RO	Not possible	–
	02	Ch2 Measured Value Under Range	FALSE						
	03	Ch3 Measured Value Under Range	FALSE						
	04	Ch4 Measured Value Under Range	FALSE						

*1. The default value and data range for Number of Entries are as follows.

NX Units	Default value	Data range
NX-TS2101/TS2102/TS2104/TS2201/TS2202/TS2204	2	2
NX-TS3101/TS3102/TS3104/TS3201/TS3202/TS3204	4	4
Other models	0	0

*2. The meanings of Ch□ Measured Value Under Range are as follows.

Value	Meaning
FALSE	Normal
TRUE	Under Range Detected

Index (hex)	Subindex (hex)	Object name	Default value	Data range	Unit	Data type	Access	I/O allocation	Data attribute
500A	–	Cold Junction Sensor Error Status	–	–	–	–	–	–	–
	00	Number of Entries	*1	*1	–	USINT	RO	Not possible	–
	01	Ch1 Cold Junction Sensor Error Status	FALSE	TRUE or FALSE *2	–	BOOL	RO	Not possible	–
	02	Ch2 Cold Junction Sensor Error Status	FALSE			BOOL	RO	Not possible	–
	03	Ch3 Cold Junction Sensor Error Status	FALSE			BOOL	RO	Not possible	–
	04	Ch4 Cold Junction Sensor Error Status	FALSE			BOOL	RO	Not possible	–

*1. The default value and data range for Number of Entries are as follows.

NX Units	Default value	Data range
NX-TS2101/TS2102/TS2104/TS2201/TS2202/TS2204	2	2
NX-TS3101/TS3102/TS3104/TS3201/TS3202/TS3204	4	4
Other models	0	0

*2. The meanings of Ch□ Cold Junction Sensor Error Status are as follows.

Value	Meaning
FALSE	Normal
TRUE	Disconnection Detected

Index (hex)	Subindex (hex)	Object name	Default value	Data range	Unit	Data type	Access	I/O allocation	Data attribute
500B	–	AD Converter Error Status	–	–	–	–	–	–	–
	00	Number of Entries	*1	*1	–	USINT	RO	Not possible	–
	01	Ch1 AD Converter Error Status	FALSE	TRUE or FALSE *2	–	BOOL	RO	Not possible	–
	02	Ch2 AD Converter Error Status	FALSE			BOOL	RO	Not possible	–
	03	Ch3 AD Converter Error Status	FALSE			BOOL	RO	Not possible	–
	04	Ch4 AD Converter Error Status	FALSE			BOOL	RO	Not possible	–

*1. The default value and data range for Number of Entries are as follows.

NX Units	Default value	Data range
NX-TS2101/TS2102/TS2104/TS2201/TS2202/TS2204	2	2
NX-TS3101/TS3102/TS3104/TS3201/TS3202/TS3204	4	4
Other models	0	0

*2. The meanings of Ch□ AD Converter Error Status are as follows.

Value	Meaning
FALSE	Normal
TRUE	Error

Index (hex)	Subindex (hex)	Object name	Default value	Data range	Unit	Data type	Access	I/O allocation	Data attribute
5010	–	Offset Value (One-point Correction)	–	–	–	–	–	–	–
	00	Number of Entries	*1	*1	–	USINT	RO	Not possible	–
	01	Ch1 Offset Value (One-point Correction)	0	-400 to 5000	°C or °F	REAL	RW	Not possible	N
	02	Ch2 Offset Value (One-point Correction)	0	-400 to 5000		REAL	RW	Not possible	N
	03	Ch3 Offset Value (One-point Correction)	0	-400 to 5000		REAL	RW	Not possible	N
	04	Ch4 Offset Value (One-point Correction)	0	-400 to 5000		REAL	RW	Not possible	N

*1. The default value and data range for Number of Entries are as follows.

NX Units	Default value	Data range
NX-TS2101/TS2102/TS2104/TS2201/TS2202/TS2204	2	2
NX-TS3101/TS3102/TS3104/TS3201/TS3202/TS3204	4	4
Other models	0	0

Index (hex)	Subindex (hex)	Object name	Default value	Data range	Unit	Data type	Access	I/O allocation	Data attribute
5011	–	Lower Offset Value (Two-point Correction)	–	–	–	–	–	–	–
	00	Number of Entries	*1	*1	–	USINT	RO	Not possible	–
	01	Ch1 Lower Offset Value (Two-point Correction)	0	-400 to 5000	°C or °F	REAL	RW	Not possible	N
	02	Ch2 Lower Offset Value (Two-point Correction)	0	-400 to 5000		REAL	RW	Not possible	N
	03	Ch3 Lower Offset Value (Two-point Correction)	0	-400 to 5000		REAL	RW	Not possible	N
	04	Ch4 Lower Offset Value (Two-point Correction)	0	-400 to 5000		REAL	RW	Not possible	N

*1. The default value and data range for Number of Entries are as follows.

NX Units	Default value	Data range
NX-TS2101/TS2102/TS2104/TS2201/TS2202/TS2204	2	2
NX-TS3101/TS3102/TS3104/TS3201/TS3202/TS3204	4	4
Other models	0	0

Index (hex)	Subindex (hex)	Object name	Default value	Data range	Unit	Data type	Access	I/O allocation	Data attribute
5012	–	Higher Offset Value (Two-point Correction)	–	–	–	–	–	–	–
	00	Number of Entries	*1	*1	–	USINT	RO	Not possible	–
	01	Ch1 Higher Offset Value (Two-point Correction)	0	-400 to 5000	°C or °F	REAL	RW	Not possible	N
	02	Ch2 Higher Offset Value (Two-point Correction)	0	-400 to 5000		REAL	RW	Not possible	N
	03	Ch3 Higher Offset Value (Two-point Correction)	0	-400 to 5000		REAL	RW	Not possible	N
	04	Ch4 Higher Offset Value (Two-point Correction)	0	-400 to 5000		REAL	RW	Not possible	N

*1. The default value and data range for Number of Entries are as follows.

NX Units	Default value	Data range
NX-TS2101/TS2102/TS2104/TS2201/TS2202/TS2204	2	2
NX-TS3101/TS3102/TS3104/TS3201/TS3202/TS3204	4	4
Other models	0	0

Index (hex)	Subindex (hex)	Object name	Default value	Data range	Unit	Data type	Access	I/O allocation	Data attribute
5013	–	Pre-correction Lower Measured Value (Two-point Correction)	–	–	–	–	–	–	–
	00	Number of Entries	*1	*1	–	USINT	RO	Not possible	–
	01	Ch1 Pre-correction Lower Measured Value (Two-point Correction)	0	-400 to 5000	°C or °F	REAL	RW	Not possible	N
	02	Ch2 Pre-correction Lower Measured Value (Two-point Correction)	0	-400 to 5000		REAL	RW	Not possible	N
	03	Ch3 Pre-correction Lower Measured Value (Two-point Correction)	0	-400 to 5000		REAL	RW	Not possible	N
	04	Ch4 Pre-correction Lower Measured Value (Two-point Correction)	0	-400 to 5000		REAL	RW	Not possible	N

*1. The default value and data range for Number of Entries are as follows.

NX Units	Default value	Data range
NX-TS2101/TS2102/TS2104/TS2201/TS2202/TS2204	2	2
NX-TS3101/TS3102/TS3104/TS3201/TS3202/TS3204	4	4
Other models	0	0

Index (hex)	Subindex (hex)	Object name	Default value	Data range	Unit	Data type	Access	I/O allocation	Data attribute
5014	–	Pre-correction Higher Measured Value (Two-point Correction)	–	–	–	–	–	–	–
	00	Number of Entries	*1	*1	–	USINT	RO	Not possible	–
	01	Ch1 Pre-correction Higher Measured Value (Two-point Correction)	0	-400 to 5000	°C or °F	REAL	RW	Not possible	N
	02	Ch2 Pre-correction Higher Measured Value (Two-point Correction)	0	-400 to 5000		REAL	RW	Not possible	N
	03	Ch3 Pre-correction Higher Measured Value (Two-point Correction)	0	-400 to 5000		REAL	RW	Not possible	N
	04	Ch4 Pre-correction Higher Measured Value (Two-point Correction)	0	-400 to 5000		REAL	RW	Not possible	N

*1. The default value and data range for Number of Entries are as follows.

NX Units	Default value	Data range
NX-TS2101/TS2102/TS2104/TS2201/TS2202/TS2204	2	2
NX-TS3101/TS3102/TS3104/TS3201/TS3202/TS3204	4	4
Other models	0	0

A-4 List of Terminal Block Models

A-4-1 Model Notation

The Terminal Block models are assigned based on the following rules.

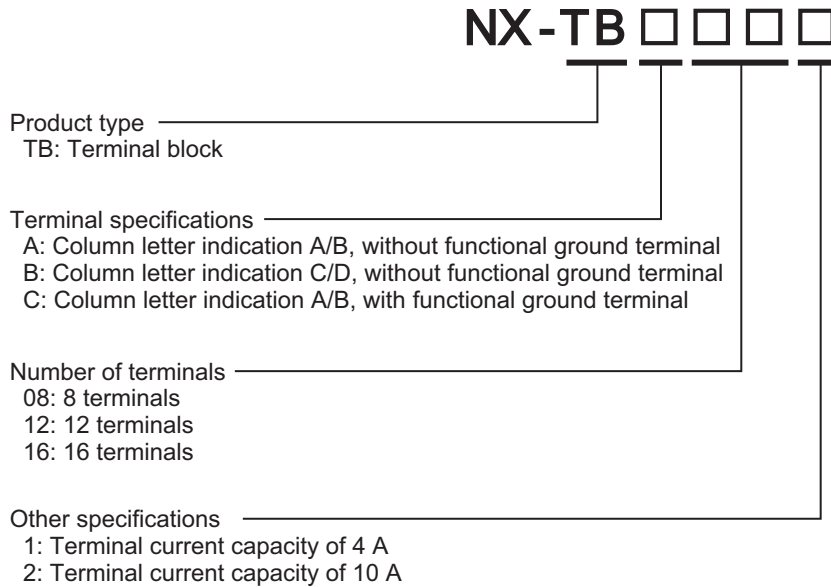

A-4-2 List of Terminal Block Models

The following table shows a list of Terminal Blocks.

Terminal Block model	Number of terminals	Ground terminal	Terminal current capacity
NX-TBA081	8	Not provided	4 A
NX-TBA121	12		
NX-TBA161	16		
NX-TBB121	12		
NX-TBB161	16		
NX-TBA082	8		
NX-TBA122	12		
NX-TBA162	16		
NX-TBB122	12		
NX-TBB162	16		
NX-TBC082	8		
NX-TBC162	16		

Note When you purchase a Terminal Block, purchase an NX-TB□□□2.

A-5 Version Information

This section describes the relationship between the unit versions of each Unit and the EtherCAT Coupler Units, CPU Units, and Sysmac Studio versions, and the specification changes for each unit version of each Unit.

A-5-1 Relationship between the Unit Versions of Each Unit and the EtherCAT Coupler Units, CPU Units, and Sysmac Studio Versions

The relationship between the unit versions of each Unit and the EtherCAT Coupler Units, CPU Units, and Sysmac Studio versions are shown below.

With the combinations of the unit versions/versions shown below, you can use all the functions that are supported by each unit version of each Unit model.

Use the unit versions/versions that correspond to the NX Unit models and the unit versions or the later/higher versions.

You cannot use the specifications that were added or changed for the relevant NX Unit models and the unit versions unless you use the corresponding unit versions/versions.

Refer to the user's manuals for the specific Units for the functions that were added or changed for each unit version update of the Communications Coupler Units or NX Units.

Refer to the *NX-series Data Reference Manual* (Cat. No. W525-E1-03 or later) for information on the relationship between the support functions of the Communications Coupler Units and restrictions on the NX Units.

- **Analog Input Units and Analog Output Units**

NX Units		Corresponding unit versions/versions		
Model	Unit version	EtherCAT Coupler Units NX-ECC201/ECC202	NJ-series CPU Units NJ501-□□□□/ NJ301-□□□□	Sysmac Studio
NX-AD2203	Ver.1.0	Ver.1.0	Ver.1.05	Ver.1.06
NX-AD2204				
NX-AD2208				
NX-AD2603				
NX-AD2604				
NX-AD2608				
NX-AD3203				
NX-AD3204				
NX-AD3208				
NX-AD3603				
NX-AD3604				
NX-AD3608				
NX-AD4203				
NX-AD4204				
NX-AD4208				
NX-AD4603				
NX-AD4604				
NX-AD4608				
NX-DA2203				
NX-DA2205				
NX-DA2603	Ver.1.0	Ver.1.0	Ver.1.05	Ver.1.06
NX-DA2605				
NX-DA3203				
NX-DA3205				

● Temperature Input Units

NX Units		Corresponding unit versions/versions			
Model	Unit version	EtherCAT Coupler Units NX-ECC201/ECC202	NJ-series CPU Units NJ501-□□□□/ NJ301-□□□□	Sysmac Studio	
NX-TS2101	Ver.1.0	Ver.1.0	Ver.1.05	Ver.1.06	
	Ver.1.1			Ver.1.08	
NX-TS2102	Ver.1.1				
NX-TS2104	Ver.1.1				
NX-TS2201	Ver.1.0				Ver.1.06
	Ver.1.1				Ver.1.08
NX-TS2202	Ver.1.1				
NX-TS2204	Ver.1.1				
NX-TS3101	Ver.1.0				Ver.1.06
	Ver.1.1				Ver.1.08
NX-TS3102	Ver.1.1				
NX-TS3104	Ver.1.1				
NX-TS3201	Ver.1.0				Ver.1.06
	Ver.1.1				Ver.1.08
NX-TS3202	Ver.1.1				
NX-TS3204	Ver.1.1				

A-5-2 Functions That Were Added or Changed for Each Unit Version

The following table shows the relationship between the unit versions of the NX Units, EtherCAT Coupler Units, CPU Units, and the version of the Sysmac Studio, for changes in or additions to the functions.

You can also use the added or changed functions with the unit versions/versions given in the table or with later/higher versions.

Temperature Input Units

Function	Change or addition	NX Units		Corresponding unit versions/versions		
		Model	Unit version	EtherCAT Coupler Units NX-ECC201/E CC202	NJ-series CPU Units NJ501-□□□□/ NJ301-□□□□	Sysmac Studio
Restarting a specified NX Unit ^{*1}	Addition	NX-TS□□□□	Ver.1.1	Ver.1.2	Ver.1.07 ^{*3}	Ver.1.08
Monitoring total power-ON time ^{*2}	Addition				Ver.1.05	

*1. Refer to the *EtherCAT Coupler Unit User's Manual* (Cat. No. W519-E1-03 or later) for details on how to restart a specified NX Unit.

*2. Refer to the *EtherCAT Coupler Unit User's Manual* (Cat. No. W519-E1-03 or later) for details on monitoring the total power-ON time.

*3. A CPU Unit with unit version 1.07 or later is required to specify an NX Unit with the restart instruction. If you do not specify an NX Unit with the restart instruction, you can use version 1.05. Refer to the *NJ-series Instructions Reference Manual* (Cat. No. W502-E1-09 or later) for details on specifying an NX Unit with the restart instruction.



Index



Index

Numerics

1.0E + 10	8-57
12 mm Width	3-2, 3-4
2147483647	8-57
24 mm Width	3-2, 3-4
24 mm width	3-7
32767	6-5, 8-57

A

Access	A-58
Additional I/O Power Supply Unit	4-13
Additional NX Unit Power Supply Unit	4-12
Applicable Wire	4-16
Assumed cause	9-9, 9-14

C

Calibration control number	3-5
calibration control number	4-27
Calibration control number label	3-5
CiA	1-32
Coding Pin	4-30
Cold Junction Compensation Error	A-55
Cold junction sensor	3-5
Communications Coupler Unit	1-3
Communications Master Unit	5-2
Correctable Range	6-30, 7-23
CPU Unit	5-2
crimping tool	4-17
Current Error	9-7

D

Data attribute	A-58
Data range	A-58
Data type	A-58
Default value	A-58
Differential	4-34
DIN Track mounting hook	3-3, 3-5

E

enable distributed clock	5-3
Event code	9-9, 9-14
Event name	9-9, 9-14

F

Ferrule	4-17
forced refreshing	4-33

G

Ground terminal	4-17, 4-18
-----------------------	------------

H

High Limit	7-15
Hold Last State	7-15

I

I/O allocation	A-58
I/O allocation information	7-5, 8-9
I/O allocation setting	6-6, 7-5, 8-9
I/O entry	6-6, 7-5, 8-9
I/O entry mapping	6-6, 7-5, 8-9
I/O Map	4-33
I/O power supply	4-8
I/O Power Supply Connection Unit	4-14
incorrect attachment prevention hole	4-29
Index	A-58
Indicator	3-3, 3-5

L

Log of Past Error	9-7
Low Limit	7-15

M

Marker	4-4
Marker attachment location	3-3, 3-5
maximum current of I/O power supply	4-13
maximum I/O power supply current	4-11
Model number indication	3-9

N

NX bus connector	3-3, 3-5
NX Object	A-58
NX Unit power supply	4-8
NX Unit power supply capacity	4-12

O

Object name	A-58
Objects That Accept I/O Allocations	A-60, A-69, A-74
One-point Correction	8-44
Other Objects	A-61, A-70, A-77

P

Periodic Inspection Item	10-3
Preventing Incorrect Attachment	4-29

primary periodic task5-11, 5-15
 Protrusions for removing the Unit 3-3, 3-5

R

range for which conversion is possible . 6-4, 6-28, 7-3, 7-21
 Reference accuracy A-52
 Refresh cycle of the NX bus5-2
 Release hole3-7

S

shield4-35
 Shield Connection Unit4-35
 Single-ended4-34
 Slave Terminal 1-3, 4-8, 5-2
 Solid Wire4-18
 Subindex A-58
 Sync0 5-9, 5-13

T

Temperature Coefficient A-52
 Terminal block 3-3, 3-5
 Terminal hole3-7
 Terminal number indication3-7
 timing to read inputs 5-4, 5-9
 timing to refresh outputs 5-4, 5-13
 Twisted Wire4-18
 Two-point Correction8-45

U

Unit A-58
 Unit hookup guide 3-3, 3-5
 Unit Information Object A-59, A-68, A-73
 Unit power supply4-8
 Unit power supply terminal4-9
 Unit specifications 3-3, 3-5
 unit versions1-26
 User Count7-15

W

Watch Tab Page4-33
 Wiring Terminal4-15

Z

Zero Count7-15

OMRON Corporation Industrial Automation Company

Tokyo, JAPAN

Contact: www.ia.omron.com

Regional Headquarters

OMRON EUROPE B.V.

Wegalaan 67-69-2132 JD Hoofddorp
The Netherlands

Tel: (31)2356-81-300/Fax: (31)2356-81-388

OMRON ELECTRONICS LLC

One Commerce Drive Schaumburg,
IL 60173-5302 U.S.A.

Tel: (1) 847-843-7900/Fax: (1) 847-843-7787

OMRON ASIA PACIFIC PTE. LTD.

No. 438A Alexandra Road # 05-05/08 (Lobby 2),
Alexandra Technopark,
Singapore 119967

Tel: (65) 6835-3011/Fax: (65) 6835-2711

OMRON (CHINA) CO., LTD.

Room 2211, Bank of China Tower,
200 Yin Cheng Zhong Road,
PuDong New Area, Shanghai, 200120, China

Tel: (86) 21-5037-2222/Fax: (86) 21-5037-2200

Authorized Distributor:

© OMRON Corporation 2013 All Rights Reserved.
In the interest of product improvement,
specifications are subject to change without notice.

Cat. No. W522-E1-03

0913