

OMRON

Vision Sensor

FQ-M-series

Specialized Vision Sensor for Positioning

User's Manual

FQ-MS12□



SYSTMAC
always in control

Z314-E1-03

Introduction

Thank you for purchasing the FQ-M.

This manual provides information regarding functions, performance and operating methods that are required for using the FQ-M.

When using the FQ-M, be sure to observe the following:

- The FQ-M must be operated by personnel knowledgeable in electrical engineering.
- To ensure correct use, please read this manual thoroughly to deepen your understanding of the product.
- Please keep this manual in a safe place so that it can be referred to whenever necessary.

User's Manual

Vision Sensor for Positioning
FQ-M

APPLICATION CONSIDERATIONS (Please Read)	
Introduction	1
Installation and Connections	2
Taking Images	3
Setting Up Inspections	4
Testing and Saving Settings	5
Operation	6
Convenient Functions	7
Communications with External Devices	8
Calibration	9
Offline Settings	10
Troubleshooting	11
Appendices	12

READ AND UNDERSTAND THIS DOCUMENT

Please read and understand this document before using the products. Please consult your OMRON representative if you have any questions or comments.

WARRANTY

OMRON's exclusive warranty is that the products are free from defects in materials and workmanship for a period of one year (or other period if specified) from date of sale by OMRON.

OMRON MAKES NO WARRANTY OR REPRESENTATION, EXPRESS OR IMPLIED, REGARDING NON-INFRINGEMENT, MERCHANTABILITY, OR FITNESS FOR PARTICULAR PURPOSE OF THE PRODUCTS. ANY BUYER OR USER ACKNOWLEDGES THAT THE BUYER OR USER ALONE HAS DETERMINED THAT THE PRODUCTS WILL SUITABLY MEET THE REQUIREMENTS OF THEIR INTENDED USE. OMRON DISCLAIMS ALL OTHER WARRANTIES, EXPRESS OR IMPLIED.

LIMITATIONS OF LIABILITY

OMRON SHALL NOT BE RESPONSIBLE FOR SPECIAL, INDIRECT, OR CONSEQUENTIAL DAMAGES, LOSS OF PROFITS OR COMMERCIAL LOSS IN ANY WAY CONNECTED WITH THE PRODUCTS, WHETHER SUCH CLAIM IS BASED ON CONTRACT, WARRANTY, NEGLIGENCE, OR STRICT LIABILITY.

In no event shall responsibility of OMRON for any act exceed the individual price of the product on which liability is asserted.

IN NO EVENT SHALL OMRON BE RESPONSIBLE FOR WARRANTY, REPAIR, OR OTHER CLAIMS REGARDING THE PRODUCTS UNLESS OMRON'S ANALYSIS CONFIRMS THAT THE PRODUCTS WERE PROPERLY HANDLED, STORED, INSTALLED, AND MAINTAINED AND NOT SUBJECT TO CONTAMINATION, ABUSE, MISUSE, OR INAPPROPRIATE MODIFICATION OR REPAIR.

SUITABILITY FOR USE

THE PRODUCTS CONTAINED IN THIS DOCUMENT ARE NOT SAFETY RATED. THEY ARE NOT DESIGNED OR RATED FOR ENSURING SAFETY OF PERSONS, AND SHOULD NOT BE RELIED UPON AS A SAFETY COMPONENT OR PROTECTIVE DEVICE FOR SUCH PURPOSES.

Please refer to separate catalogs for OMRON's safety rated products.

OMRON shall not be responsible for conformity with any standards, codes, or regulations that apply to the combination of products in the customer's application or use of the product.

At the customer's request, OMRON will provide applicable third party certification documents identifying ratings and limitations of use that apply to the products. This information by itself is not sufficient for a complete determination of the suitability of the products in combination with the end product, machine, system, or other application or use.

The following are some examples of applications for which particular attention must be given. This is not intended to be an exhaustive list of all possible uses of the products, nor is it intended to imply that the uses listed may be suitable for the products:

- Outdoor use, uses involving potential chemical contamination or electrical interference, or conditions or uses not described in this document.

- Nuclear energy control systems, combustion systems, railroad systems, aviation systems, medical equipment, amusement machines, vehicles, safety equipment, and installations subject to separate industry or government regulations.
- Systems, machines, and equipment that could present a risk to life or property.

Please know and observe all prohibitions of use applicable to the products.

NEVER USE THE PRODUCTS FOR AN APPLICATION INVOLVING SERIOUS RISK TO LIFE OR PROPERTY WITHOUT ENSURING THAT THE SYSTEM AS A WHOLE HAS BEEN DESIGNED TO ADDRESS THE RISKS, AND THAT THE OMRON PRODUCT IS PROPERLY RATED AND INSTALLED FOR THE INTENDED USE WITHIN THE OVERALL EQUIPMENT OR SYSTEM.

PERFORMANCE DATA

Performance data given in this document is provided as a guide for the user in determining suitability and does not constitute a warranty. It may represent the result of OMRON's test conditions, and the users must correlate it to actual application requirements. Actual performance is subject to the OMRON Warranty and Limitations of Liability.

CHANGE IN SPECIFICATIONS

Product specifications and accessories may be changed at any time based on improvements and other reasons.

It is our practice to change model numbers when published ratings or features are changed, or when significant construction changes are made. However, some specifications of the product may be changed without any notice. When in doubt, special model numbers may be assigned to fix or establish key specifications for your application on your request. Please consult with your OMRON representative at any time to confirm actual specifications of purchased products.

DIMENSIONS AND WEIGHTS

Dimensions and weights are nominal and are not to be used for manufacturing purposes, even when tolerances are shown.

ERRORS AND OMISSIONS

The information in this document has been carefully checked and is believed to be accurate; however, no responsibility is assumed for clerical, typographical, or proofreading errors, or omissions.

PROGRAMMABLE PRODUCTS

OMRON shall not be responsible for the user's programming of a programmable product, or any consequence thereof.

COPYRIGHT AND COPY PERMISSION

This document shall not be copied for sales or promotions without permission.

This document is protected by copyright and is intended solely for use in conjunction with the product. Please notify us before copying or reproducing this document in any manner, for any other purpose. If copying or transmitting this document to another, please copy or transmit it in its entirety.

Meanings of Signal Words

The following signal words are used in this manual.



Indicates a potentially hazardous situation which, if not avoided, will result in minor or moderate injury, or may result in serious injury or death. Additionally there may be significant property damage.

Meanings of Alert Symbols

The following alert symbols are used in this manual

	Indicates general prohibitions for which there is no specific symbol.
	Indicates the possibility of explosion under specific conditions.
	Indicates prohibition when there is a risk of minor injury from electrical shock or other source if the product is disassembled.

WARNING

This product is not designed or rated for ensuring safety of persons.
Do not use it for such purposes.



A lithium ion battery is built into the Touch Finder and may occasionally combust, explode, or burn if not treated properly.
Dispose of the Touch Finder as industrial waste, and never disassemble, apply pressure that would deform, heat to 100 °C or higher, or incinerate the Touch Finder.



High-voltage parts inside; danger of electrical shock. Do not open the product cover.



Precautions for Safe Use

The following points are important to ensure safety, so make sure that they are strictly observed.

1. Installation Environment

- Do not use the product in environments where it can be exposed to inflammable/explosive gas.
- To secure the safety of operation and maintenance, do not install the product close to high-voltage devices and power devices.
- Install the product in such a way that its ventilation holes are not blocked.
- Tighten mounting screws at the torque specified in this manual.

2. Power Supply and Wiring

- The power supply voltage must be within the rated range (24 VDC \pm 10%), and an AC voltage must not be used.
- Reverse connection of the power supply is not allowed. Do not short the load of the open collector output.
- The load must be within the rated range.
- High-voltage lines and power lines must be wired separately from this product. Wiring them together or placing them in the same duct may cause induction, resulting in malfunction or damage.
- Use the products within the power supply voltages specified in this manual.
- Use the specified size of crimp terminals to wire connections. Do not connect wires that have been simply twisted together directly to the power supply or terminal block.
- Use a DC power supply with safety measures against high voltages (safety extra low-voltage circuit).
- Use independent power sources for the products. Do not use a shared power source.
- Tighten mounting screws at the torque specified in this manual.
- Always turn OFF the power supply to the Camera before performing any of the following. The Sensor may become faulty if you do any of these while power is being supplied.
 - Setting the node address setting switches
 - Connecting or wiring the cable
 - Connecting or disconnecting the connector

3. Battery

- Do not short the positive and negative terminals of the Battery.
- Do not use the Touch Finder in an environment that exceeds the operating temperature range of the Battery. If the Touch Finder is used at temperatures that exceed the operating temperature range, the protective device may activate and prevent charging.
- Do not connect the Battery directly to a power supply or car cigarette lighter socket.
- Do not use the Touch Finder with any other type of battery.
- Turn OFF the power supply immediately if the Battery leaks or produces an odor. Electrolyte leaked from the Battery may ignite, possibly causing smoke, rupture, or fire.
- If during usage, charging, or storage, the Battery produces an odor, heats, becomes discolored, becomes misshapen, or exhibits any other unusual conditions, remove it and do not use it. Continuing to use such a Battery may result in the Battery heating, smoking, rupturing, or igniting.
- If the Touch Finder (FQ-MD31) will be installed permanently or semi-permanently, remove the Battery (FQ-BAT1). If the rated temperature is exceeded with the Battery inserted, the protective circuit may activate and stop the Touch Finder.

4. AC Adapter

- Use an AC cable that is suitable for the power supply and power voltage you are using.
- Do not touch the power plug with a wet hand. Doing so may result in electrical shock.
- If you notice an abnormal condition, such as smoke, abnormal heating of the outer surface, or a strange odor, immediately stop using the AC Adapter, turn OFF the power, and remove the power plug from the outlet.

Consult your dealer, as it is dangerous to attempt to repair the AC Adapter yourself.

- If the AC Adapter is dropped or damaged, turn OFF the power, remove the power plug from the outlet, and contact your dealer. There is a risk of fire if you continue using the AC Adapter.

5. Other

- Do not use this product in safety circuits associated with nuclear power and human life.
- Do not disassemble, repair, modify, deform by pressure, or incinerate this product.
- Dispose of this product as industrial waste.
- Connect the special products (Sensor, Touch Finder, Cables). The product might break down or malfunction if you use a part not included in the special products.
- If you notice an abnormal condition, such as a strange odor, extreme heating of any product, or smoke, immediately stop using the product, turn OFF the power, and consult your dealer.
- The Sensor surfaces become hot during use. Do not touch them.
- Do not drop or subject the products to shock.
- Use the special Sensor (FQ-M), Touch Finder (FQ-MD), Cables (FQ-WN, FQ-MWNL, FQ-MWD, and FQ-MWDL), Battery (FQ-BAT1), and AC Adapter (FQ-AC). Using other than the specified products may cause fire, burning, malfunction or failure.
- If the product has a lock mechanism, always make sure it is locked before using the product.

6. Laws and Regulations, Standards

- This product complies with the following EC Directives and EN Standards:
EC Directive No.2004/104/EC
EN Standards EN61326

Precautions for Correct Use

Observe the following precautions to prevent failure to operate, malfunctions, or undesirable effects on product performance.

1. Installation Site

Do not install this product in locations subjected to the following conditions:

- Ambient temperature outside the rating
- Rapid temperature fluctuations (causing condensation)
- Relative humidity outside the range of 35 to 85%
- Direct vibration or shock
- Strong ambient light (such as other laser beams, light from arc-welding machines, or ultraviolet light)
- Direct sunlight or near heaters
- Strong magnetic or electric field

Also, do not install this product in locations subjected to the following conditions to ensure its protective performance as described in the specifications:

- Presence of corrosive or flammable gases
- Presence of dust, salt, or iron particles
- Water, oil, or chemical fumes or spray, or mist atmospheres

2. Power Supply, Connection, and Wiring

- When using a commercially available switching regulator, make sure that the FG terminal is grounded.
- If surge currents are present in the power lines, connect surge absorbers that suit the operating environment.
- Before turning ON the power after the product is connected, make sure that the power supply voltage is correct, there are no incorrect connections (e.g. load short-circuit) and the load current is appropriate. Incorrect wiring may result in breakdown of the product.
- For cables, use only the special products specified in this manual.

 p.237, p.238

- Use only combinations of the Sensor, Touch Finder, and PC Tool that are specified in this manual. Using other combinations may cause malfunction or damage.
- Do not turn the power OFF in the following instances. Doing so will damage data that is in the process of being saved.
 - While data is being saved in internal memory
 - While data is being saved on the SD card
- The LCD panel has been made using precision technology, and sometimes a few pixels are missing in the panel. This is due to the structure of the LCD panel, and is not a malfunction.
- Connector cover
Always attach the covers of I/O cable connector and Ethernet cable connector. This prevents extraneous material from making malfunction of the Sensor.

3. Battery

- Do not use or charge the Battery with other than the specified products.
- Do not charge the Battery with other than the specified AC adapter.
- When using the Touch Finder, the battery cover screw must be tightened.

4. AC Adapter

- During maintenance and when not using the Touch Finder for an extended time, remove the power plug from the outlet.
- Do not bend the power cable past its natural bending radius.
- Do not use the AC Adapter with other than the specified products.
- If a voltage higher than 380 V is applied, there is a risk that the capacitor will be damaged, the pressure valve will open, and vaporized gas will be emitted. If there is a possibility that a voltage higher than 380 V will be applied, use a protective device.

5. Maintenance and Inspection

Do not use thinner, benzene, acetone or kerosene to clean the Sensor and Touch Finder. If large dust particles adhere to the Camera, use a blower brush (used to clean camera lenses) to blow them off. Do not use breath from your mouth to blow the dust off. To remove dust particles from the Camera, wipe gently with a soft cloth (for cleaning lenses) moistened with a small amount of alcohol. Do not use excessive force to wipe off dust particles. Scratches to the Camera might cause error.

Editor's Note

■ Meaning of Symbols

Menu items that are displayed on the Touch Finder LCD screen, and windows, dialog boxes and other GUI elements displayed on the PC are indicated enclosed by brackets "[]".

■ Visual Aids

Important

Indicates points that are important to achieve the full product performance, such as operational precautions.

Note

Indicates application procedures.



Indicates pages where related information can be found.

Copyrights and Trademarks

- Sysmac is a trademark or registered trademark of OMRON corporation in Japan and other countries for our FA equipment products.
- Windows, Windows XP, Windows Vista, Windows 7, and Windows 8 are registered trademarks of Microsoft Corporation in the USA and other countries.
- EtherCAT® is registered trademark and patented technology that is licensed by Beckhoff Automation GmbH, Germany.
- Other system names and product names that appear in this manual are the trademarks or registered trademarks of the respective companies.

© OMRON, 2011

All rights reserved. No part of this publication may be reproduced, stored in a retrieval system, or transmitted, in any form, or by any means, mechanical, electronic, photocopying, recording, or otherwise, without the prior written permission of OMRON.

No patent liability is assumed with respect to the use of the information contained herein. Moreover, because OMRON is constantly striving to improve its high-quality products, the information contained in this manual is subject to change without notice. Every precaution has been taken in the preparation of this manual. Nevertheless, OMRON assumes no responsibility for errors or omissions. Neither is any liability assumed for damages resulting from the use of the information contained in this publication.

Related Manuals

The following manual is related to the NJ-series Controllers. Use this manual for reference.

Manual name	Cat. No.	Model numbers	Application	Description
Sysmac Studio Version 1 Operation Manual	W504	SYSMAC-SE2□□□	Learning about the operating procedures and functions of the Sysmac Studio.	Describes the operating procedures of the Sysmac Studio.

Table of Contents

Copyrights and Trademarks	8
Related Manuals	9

1. Introduction

1-1 FQ-M-series Vision Sensors	20
Sensor Models	20
Differences between the PC Tool and Touch Finder	21
1-2 Measurement Process	22
1-3 Basic Operational Flow	23

2. Installation and Connections

2-1 System Configuration	26
System Configuration	26
Connection Compatibility	27
2-2 Part Names and Functions	29
2-3 Installation	32
Installing the Sensor	32
Installing the Touch Finder	36
2-4 Wiring	40
Wiring the Sensor	40
Wiring the Touch Finder	45
2-5 Installing the Sysmac Studio	48
2-6 Starting a Project	49
Connecting to the Sensor from the PC Tool	49
Entering Project Information	50
2-7 The User Interface	52
PC Tool	52
Touch Finder	58
2-8 Saving a Project	59
Saving a Project	59
Exporting Projects	59
Importing Projects	60
Exportable and Importable File Types	61

3. Taking Images

3-1	Selecting a Sensor for Configuration	64
	PC Tool	64
	Touch Finder	67
3-2	Adjusting Image Quality	69
	Adjusting the Focus	69
	Adjusting the Sensor Installation	70
	Displaying Guide Lines to Assist in Sensor Installation	72
	Adjusting Image Brightness with External Lighting	73
	Taking Clear Images of Moving Objects	75
	Improving the Image Quality of Metallic and other Shiny Surfaces	76
	Adjusting the Colors of the Image (White Balance)	78
3-3	Synchronizing the Measurement Object Image Capture Timing	79
	Setting the Measurement Trigger	79
	Delaying the Image Capture Timing from the Trigger Input	80
	Adjusting External Lighting Timing	81
3-4	Preventing Mutual Interference of Multiple Sensors	82

4. Setting Up Inspections

4-1	Inspection Item Selection Guide	84
4-2	Setup Procedure for Inspection Items	85
4-3	Registering Inspection Items	86
	Registering New Inspection Items	86
	Modifying Registered Inspection Items	86
	Copying Registered Inspection Items	87
	Deleting Registered Inspection Items	87
	Changing the Name of Registered Inspection Items	87
4-4	Inspecting with the Search Inspection Item	88
	Search Inspection Item	88
	Setup Procedure for Search Inspection Item	88
	Changing Output Coordinate Positions	91
	Increasing Measurement Position Accuracy	92
	Obtaining Multiple Results Simultaneously	93
	Select the Results to Output	94
	Using the Encoder Input to Exclude Redundant Search Results	95
	Using the Grip Interference Check Function to Exclude the Search Results of Workpieces That Are Not Able to Grip	96
	Handling the Tilt of a Search Object	98
	Stabilizing Search Results	98
	Increasing the Processing Speed	98
	Editing the Model Region	99
	Changing the Measurement Region	102

	Measurement Data That Can Be Used for External Outputs and Calculations	103
	Measurement Data That Can Be Logged	103
	Errors	104
4-5	Inspecting with the Edge Position Inspection Item	105
	Edge Position	105
	Setup Procedure for Edge Position Inspection Item	105
	Stabilizing Edge Position Results	108
	Specifying the Edge Detection Color (Sensors with Color Cameras Only)	110
	Changing Edge Detection Conditions (Sensors with Monochrome Cameras Only)	111
	Increasing Processing Speed for Edge Position	111
	Measurement Data That Can Be Used for External Outputs and Calculations	111
	Measurement Data That Can Be Logged for Edge Position	112
	Errors	112
4-6	Inspecting with the Labeling Inspection Item	113
	Labeling	113
	Setup Procedure for Labeling Inspection Item	113
	Measuring Multiple Colors	117
	Checking the Extracted Results as an Image	117
	Changing the Label Detection Conditions	118
	Changing the Label Extraction Conditions	119
	Sorting Extracted Labels	120
	Using an Encoder Input to Exclude Redundant Labeling Results	121
	Editing the Measurement Region	122
	Increasing the Processing Speed	123
	Measurement Data That Can Be Used for External Outputs and Calculations	123
	Measurement Data That Can Be Logged for Labeling	124
	Errors	124
4-7	Inspecting with the Shape Search Inspection Item	125
	Shape Search	125
	Setup Procedure for the Shape Search Inspection Item	125
	Changing Output Coordinate Positions	128
	Obtaining Multiple Results Simultaneously	129
	Select the Results to Output	130
	Using the Encoder Input to Exclude Redundant Search Results	131
	Using the Grip Interference Check Function to Exclude the Search Results of Workpieces That Are Not Able to Grip	132
	Handling the Tilt of a Search Object	134
	Stabilizing Search Results	134
	Increasing the Processing Speed	134
	Editing the Model Region	135
	Changing the Measurement	135
	Measurement Data That Can Be Used for External Outputs and Calculations	136
	Measurement Data That Can Be Logged	137

	Errors	137
4-8	Calculations and Judgements Using Inspection Item Data.....	138
	Calculation	138
	Setup Procedure for Calculations	140
	Copying Expressions	142
	Deleting Expressions	142
	Function List	143
	Performing Expression Judgement	145
	Reflecting the Judgement Results for Expressions to the Overall Judgement Results	146
	Inspection Item Data That Can Be Used in Expressions	146
	Measurement Data That Can Be Logged for Calculations	148

5. Testing and Saving Settings

5-1	Performing Test Measurements.....	150
	Performing Test Measurements with Samples	150
	Performing Test Measurements with Saved Images (Re-measuring)	151
5-2	Checking the Trend of Measurement Results with Graphs.....	152
	Trend Monitor	152
	Arranging the Trend Monitor Display	153
	Histograms	155
	Arranging Histogram Displays	156
5-3	Decreasing the Measurement Takt Time.....	158
	Checking the Measurement Takt Time	158
	Increasing Image Input Speed	159
	Shortening the Processing Time for Measurement Items	159
5-4	Checking a List of All Inspection Item Results.....	160
5-5	Saving Data to the Sensor	161

6. Operation

6-1	Starting Operation.....	164
	Run Mode Display	164
	Changing to Run Mode	165
	Starting the Monitor	168
6-2	Configuring the Run Mode Display	169
	Displayed Information	169
	Specifying the Startup Run Mode Display for the Touch Finder	172
6-3	Checking the Trend of Measurement Results with Graphs.....	173
	Trend Monitor	173
	Arranging the Trend Monitor Display	173
	Histograms	174
	Arranging Histogram Displays	175

6-4	Adjusting Judgement Parameters during Operation	176
	Preparations	176
	Changing the Judgement Parameters in Run Mode	176

7. Convenient Functions

7-1	Changing the Scene to Change the Line Process	180
	What Are Scenes?	180
	Creating New Scenes	181
	Changing to a Different Scene	181
	Changing Scene Names, Copying Scenes, and Deleting Scenes	182
	Switching Scenes from an External Device	182
	Setting the Startup Scene	182
7-2	Display Functions	183
	Image Zoom	183
	Displaying a Live Image	184
	Displaying a Frozen Image	185
	Displaying a Saved Image	186
	Updating the Display and Measurement Results Only for NG Measurement Results	187
	Displaying Guide Lines	189
	Automatically Changing to the Display for Any Sensor with an NG Result (Touch Finder Only)	190
	Hiding the Menu (Touch Finder Only)	190
	Turning OFF the LCD Backlight (Touch Finder Only)	190
	Changing the LCD Brightness (Touch Finder Only)	190
7-3	Logging Measurement Data and Image Data	191
	Logging All Data (File Logging)	191
	Checking Recent Measurement Trends (Recent Results Logging)	199
	Selecting the Data To Log	201
	Saving Logged Recent Results Data in a File	201
	Deleting Logged Data	203
7-4	Transferring and Saving Settings	204
	Backing Up Sensor Data to an External File	204
	Transferring External Files to the Sensor	205
	Printing the Sensor Settings Data	205
7-5	SD Card Operations	206
	Inserting and Removing SD Cards	206
	Checking the Available Space on the SD Card	207
	Formatting an SD Card	207
7-6	Convenient Functions for Operation	208
	Setting a Password to Prevent Unwanted Changes	208
	Capturing the Currently Visible Display (Touch Finder Only)	209
7-7	Functions Related to the Sensor System Environment	210

	Changing the Sensor Name	210
	Initializing the Sensor	210
	Restarting the Sensor	210
	Checking Versions	210
	Displaying Help	211
7-8	Functions Related to the Touch Finder System Environment	212
	Switching the Display Language	212
	Setting the Time on the Touch Finder	212
	Initializing the Touch Finder	212
	Restarting the Touch Finder	212
	Checking the Touch Finder Battery Level	212
	Correcting the Touch Screen Positions of the Touch Finder	212

8. Communications with External Devices

8-1	Connecting to Parallel I/O	214
	Operation with Default Settings	214
	Performing One Measurement for Each External Measurement Trigger	215
	Outputting the Overall Judgement Result	217
	Outputting Individual Judgement Results	218
	Adjusting the Judgement Output Timing	220
	Changing the Judgement Output ON Conditions	222
	Changing the BUSY Signal Output Condition	222
	Turning the ERROR Signal OFF	224
	Monitoring the Signal I/O Status	225
	Changing the STGOUT Signal Output Conditions	225
	Resetting the Ring Counter Value	227
8-2	EtherCAT Connection	228
	Overview of EtherCAT Networks	228
	FQ-M Communications for an EtherCAT Connection	231
	Setting Up EtherCAT Communications	234
	Setting the Data To Output Automatically after Measurements	235
	I/O Ports by Area (PDO Mapping) and Memory Assignments	241
	Timing Chart for EtherCAT Communications	259
	Sample EtherCAT Ladder Programming	263
	Sysmac Device Features	264
8-3	PLC Link Connections	266
	Setting Up PLC Link Communications	270
	Setting the Data To Output Automatically after Measurements	273
	Memory Assignments for PLC Link Communications	279
	Timing Chart for PLC Link Communications	292
	Sample Ladder Programming	294
8-4	No-protocol Connections	296
	Setting Up No-protocol Communications	297

	Setting the Data To Output Automatically after Measurements	299
	Controlling the Sensor from an External Device (Procedure for No-protocol Command/Response Communications)	305
8-5	Connecting with the Programmable No-protocol Communications.	325
	Setting Up Programmable No-protocol Communications	326
	Setting the Data To Output Automatically after Measurements	329
8-6	Using the Encoder Input	339
	Controlling Measurement Timing with an Encoder Input	340
	Enabling Synchronized Control by Outputting the Encoder Value	343

9. Calibration

9-1	Calibration	346
9-2	Calibration for Conveyor Tracking.	347
	Batch Sampling Calibration	348
	Point Specification Calibration	353
9-3	General-purpose Calibration	356
	General-purpose Calibration	356
9-4	Direct Input	368

10. Offline Settings

10-1	Offline Setup.	372
10-2	Starting a Project in Offline Mode	373
10-3	Changing between Online and Offline.	374
10-4	Offline Simulation of Sensor Measurement Operations	375
10-5	Offline Debugging of the Sensor Control Program and Sensor Operation	376

11. Troubleshooting

11-1	Error Histories	382
	EtherCAT Connection (Sysmac Error Status)	382
	Errors for Ethernet (No-protocol or PLC Link) Connections	388
11-2	Error Messages	390
11-3	Basic Troubleshooting	391

12. Appendices

12-1	Function List	394
12-2	External Reference Parameters	412
	Search	412
	Edge Position	416
	Labeling	418
	Shape Search	422

	Calculations	426
12-3	Specifications and Dimensions	428
	Vision Sensors	428
	EtherCAT Communications Specifications	434
	Touch Finders	435
	Sysmac Studio	439
	Options	440
12-4	Upgrading Sensor and Touch Finder Firmware	446
12-5	Object Dictionary	447
	Object Dictionary Area	447
	Data Types	447
	Object Description Format	448
	Communication Objects	449
	PDO Mapping Object	451
	Sync Manager Communication Object	454
	Manufacturer Specific Objects	457
	Index	462
	Revision History.....	465

Introduction

1-1 FQ-M-series Vision Sensors	20
1-2 Measurement Process	22
1-3 Basic Operational Flow	23

1-1 FQ-M-series Vision Sensors

The FQ-M Series is a series of Vision Sensors that are designed to be integrated with high-speed positioning equipment. To set up or monitor a Sensor, you can use either the Touch Finder or the computer-based PC Tool.

Setup, Image Confirmation, and Logging Tools

The PC Tool and Touch Finder are used to check images and set the judgement parameters. These are also used to save measurement results and check status during operation.

Vision Sensor

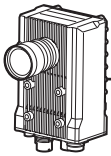

The Sensor includes a camera, measurement processor, and I/O. After the Sensor has been set up, it can be operated alone to perform measurements without the Touch Finder or PC Tool.

PC Tool



The PC Tool is used to perform initial setup of the Sensor and for system design. You can operate FQ-M series Vision Sensors from the integrated Sysmac development environment that is provided by the Sysmac Studio Automation Software.

Touch Finder

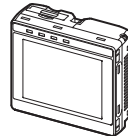

The Touch Finder is a special user interface that allows you to easily check the operating status of the Sensor and adjust settings after you have constructed the system.







Sensor Models

There are four different models of FQ-M-series Vision Sensors. The differences are given in the following table.

Model	FQ-MS□□□-M	FQ-MS□□□-M-ECT	FQ-MS□□□	FQ-MS□□□-ECT
Type	Monochrome		Color	
I/O specifications	EtherCAT not supported.	EtherCAT supported.	EtherCAT not supported.	EtherCAT supported.

Differences between the PC Tool and Touch Finder

The PC Tool (provided in the Sysmac Studio package) and the Touch Finder are different primarily in the following ways.

Item	Description	Sysmac Studio (Standard Edition)	Sysmac Studio (Vision Edition)	Touch Finder
Offline simulation  Offline Settings p. 371	Simulation is performed with images saved in the PC Tool without a connection to the Sensor.	Supported.	Supported.	Not supported.
Debugging the Sensor control program and Sensor operation offline  Offline Debugging of the Sensor Control Program and Sensor Operation p. 376	The linked operation of the sequence control of the NJ-series Controller and the operation of the FQ-M Sensor is checked offline.	Supported.	Not supported.	Not supported.
Calibration settings  Calibration p. 345	Calibration settings are made for the Sensor.	Supported.	Supported.	Not supported.
Customized output settings  Connecting with the Programmable No-protocol Communications p. 329	Customized settings are made for data output.	Supported.	Supported.	Not supported.
Simultaneous monitoring of multiple Sensors  Selecting a Sensor for Configuration p. 66	You can simultaneously monitor images from more than one Sensor.	Not supported.	Not supported.	Supported.
Monitoring logging  Checking the Results of Recent Logging p. 200	You can display graphs of the most recent data that was logged in the Sensor.	Not supported.	Not supported.	Supported.
Monitoring trends  Arranging the Trend Monitor Display p. 173	You can simultaneously display up to three types of data on graphs.	Supported.	Supported.	Not supported.

1-2 Measurement Process

This section describes the basic flow of the measurement process.



- The measurements are started for an encoder input or a signal from an external device.

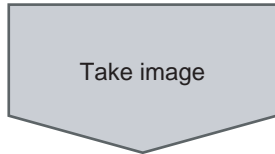

- Images are taken according to the trigger.

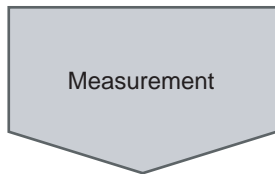

- The image is measured using inspection items.
- You can also perform calculations based on the measurement results from inspection items.

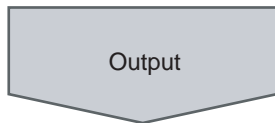

- The overall judgement of all inspection items are output using OR logic.
- Detailed measurement results for each inspection item can be output via Ethernet or EtherCAT.



- Measurement data and image data can be logged in memory in the Sensor, with the PC Tool, or on an SD card (if using the Touch Finder).

1-3 Basic Operational Flow

The following flow shows the basic operation of FQ-M-series Vision Sensors.

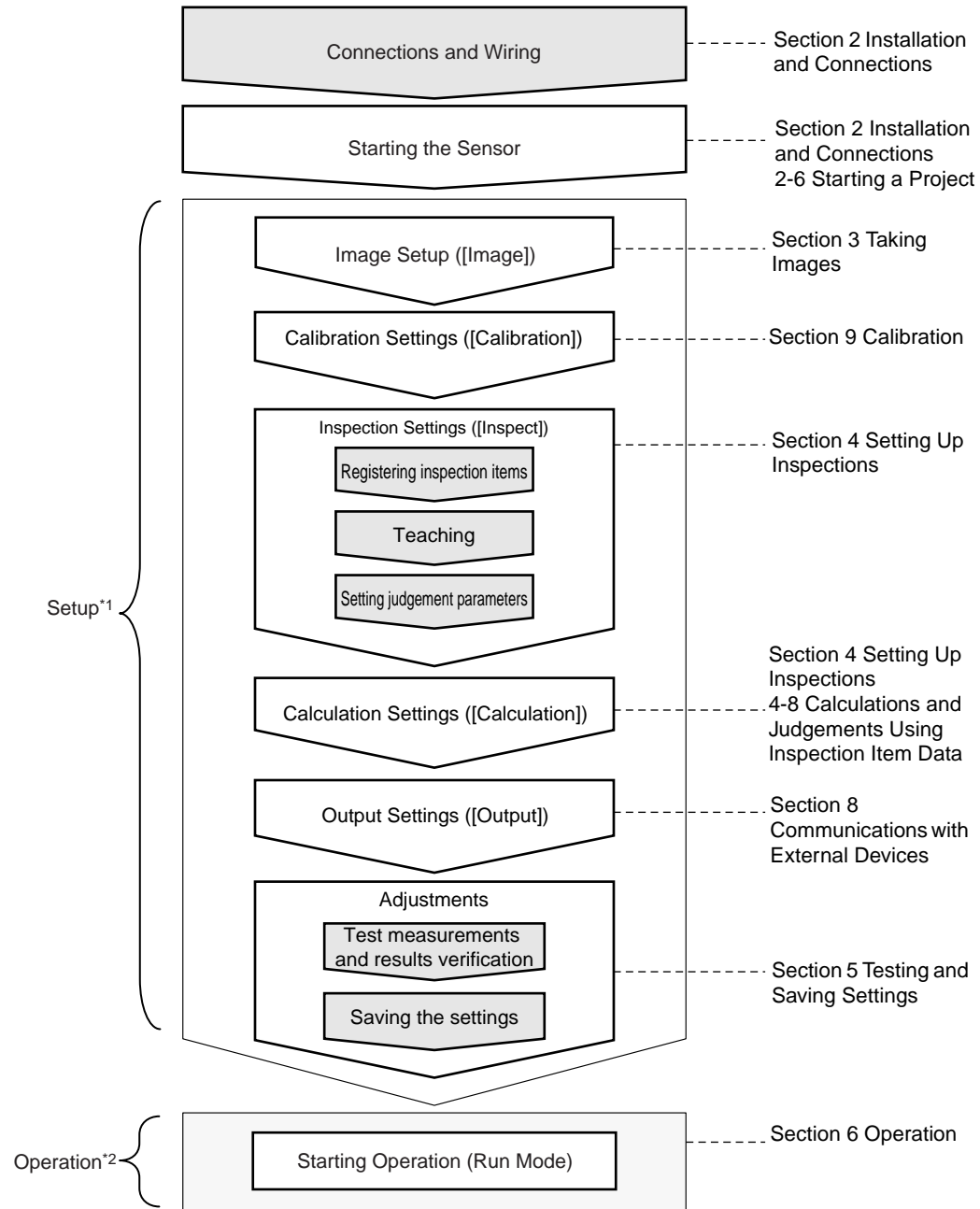

*1: In Setup Mode, the Sensor can be set up and adjusted, but it does not output signals on the I/O lines.

*2: In Run Mode, the Sensor performs measurements and outputs signals on the I/O lines.

Note

With FQ-M-series Vision Sensors, you can change settings offline without connecting to the Vision Sensor.

 Section 10 Offline Settings

MEMO

Installation and Connections

2-1 System Configuration	26
2-2 Part Names and Functions	29
2-3 Installation	32
2-4 Wiring	40
2-5 Installing the Sysmac Studio.	48
2-6 Starting a Project	49
2-7 The User Interface	52
2-8 Saving a Project	59

2-1 System Configuration

System Configuration

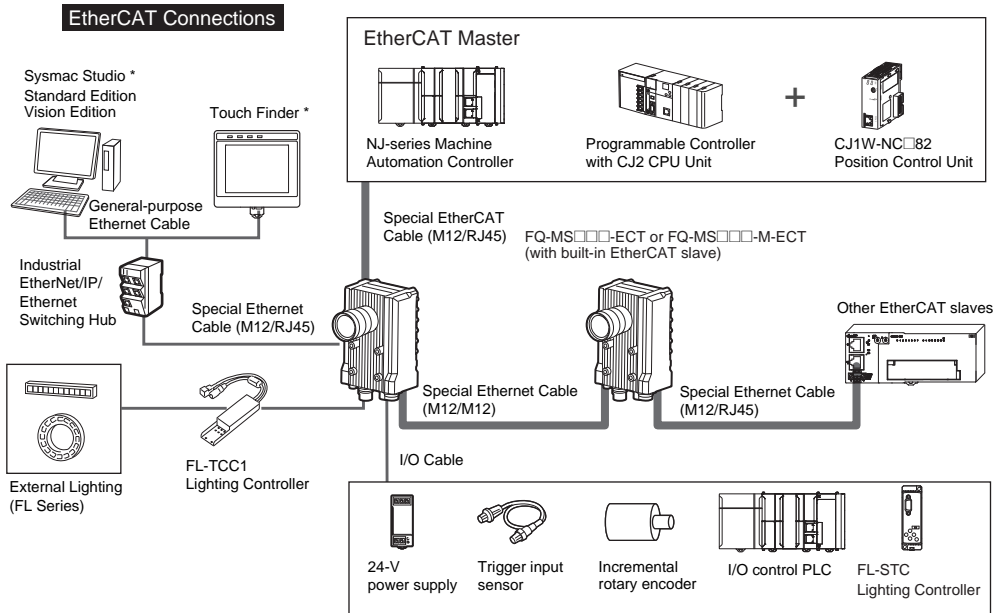

* The Sysmac Studio and Touch Finder cannot be used at the same time. If both are used at the same time, the Sysmac Studio takes priority.

No-protocol Ethernet and PLC Link Connections

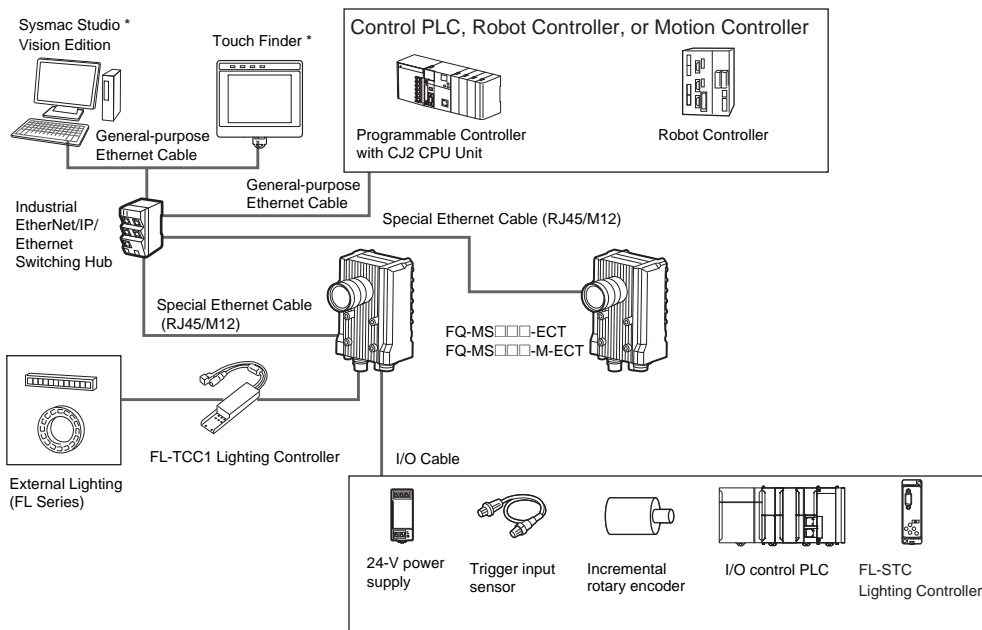

* The Sysmac Studio and Touch Finder cannot be used at the same time. If both are used at the same time, the Sysmac Studio takes priority.

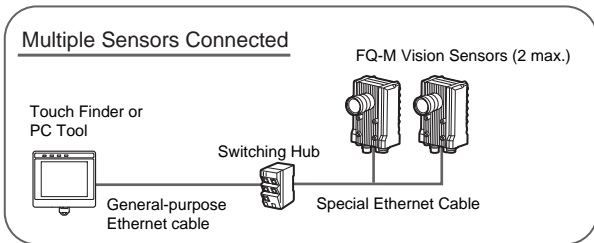

Connection Compatibility

Connected to FQ-M	Other connection				
	EtherCAT	Ethernet (PLC Link)	Ethernet (no-protocol)	Ethernet (Robot Controller protocol)	I/O Cable
EtherCAT	---	Not compatible	Compatible	Compatible	Compatible
Ethernet (PLC Link)	Not compatible	---	Not compatible	Not compatible	Compatible
Ethernet (no-protocol)	Compatible	Not compatible	---	---	Compatible
Ethernet (programmable no-protocol)	Compatible	Not compatible	---	---	Compatible

Important

- EtherCAT and Ethernet (PLC Link) connections cannot be used at the same time.
- When the FQ-M is connected via EtherCAT, you cannot set up or adjust the FQ-M through an NJ-series Controller (route 1 in the figure). To use the Sysmac Studio Standard Edition to set up and adjust the FQ-M while setting up and adjusting an NJ-series Controller, connect the computer to the FQ-M through Ethernet (route 2 in the figure). Up to eight FQ-M Vision Sensors can be connected with EtherCAT.

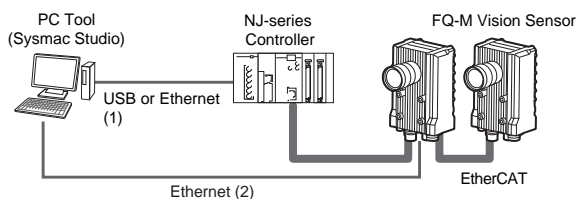

Product	Model	Application
Vision Sensor	FQ-MS□□□□□□□□	This Vision Sensor performs measurements.
Touch Finder	FQ-MD□□	This is a setup console for setting up the Sensor and checking images.
PC Tool	<p>Sysmac Studio Standard Edition</p> <ul style="list-style-type: none"> • SYSMAC-SE200D (no licenses included (media only)) • SYSMAC-SE201L (1-license edition) • SYSMAC-SE203L/210L/230L/250L (multilicense editions (3, 10, 30, or 50 licenses)) <p>Sysmac Studio Vision Edition</p> <ul style="list-style-type: none"> • SYSMAC-VE001L (1-license edition) 	<p>This is the setup application. It is part of the Sysmac Studio Package and it runs on Windows.</p> <p>The Sysmac Studio comes in two different editions.</p> <ul style="list-style-type: none"> • Sysmac Studio Standard Edition The Sysmac Studio provides an integrated development environment for the NJ-series Controllers and other Machine Automation Controllers and EtherCAT Slaves. It supports setup, programming, debugging, operation, and maintenance. The Sysmac Studio Standard Edition DVD includes Support Software for EtherNet/IP, DeviceNet, serial communications, and PT screen design (CX-Designer). Refer to the Sysmac catalog (Cat. No. P072) for details. • Sysmac Studio Vision Edition This license provides the functions that are required to set up FQ-M Vision Sensors from the Sysmac Studio. This model number is for the license only. You must also purchase the DVD for the Sysmac Studio Standard Edition.
Special Ethernet Cable	FQ-MWN□□□	This cable connects the Sensor to external devices, such as the Touch Finder, computers, and PLCs.
Special EtherCAT Cable	FQ-MWNE□□□	The Special EtherCAT Cable connects the Sensor to another Sensor or to another EtherCAT device.
General-purpose Ethernet cable ^{*1}	---	This cable connects the Switching Hub to the Touch Finder, computers, and PLCs. Use a connector that complies with the FCC RJ45 standard. (STP (shielded twisted-pair) cable, category 5e or 6, impedance: 100 Ω)
I/O Cable	FQ-MWD□□□	The I/O Cable connects the Sensor to external devices such as the power supply, encoder, and trigger input sensor.
Switching Hub	W4S1-0□□	The Switching Hub connects multiple Sensors to one Touch Finder or one computer running PC Tool.
Encoder	---	The encoder enables you to use an encoder counter to activate triggers for the Sensor or to attach an encoder counter to measurement results for outputs.
PLC	---	<p>The PLC sends control commands to control the Sensor or to store specified data. However, the following restrictions apply for some connection methods.</p> <ul style="list-style-type: none"> • EtherCAT connection: Compatible with NJ-series Controllers only. • Ethernet (PLC Link): Not compatible with NJ-series Controllers.
Robot Controller	---	The Robot Controller is used to receive measurement results or encoder information from the Sensor. You can change the format of the Robot Controller data output as required.

*1: The shape and dimensions of the Ethernet connector plug and jack are specified in ISO/IEC 8877:1992 (JIS X 5110:1996) and RJ-45 of the FCC regulations. To prevent connector connection failures, the structure of the jack of this product does not allow insertion of plugs that do not comply with the standard. If a commercially available plug cannot be inserted, it is likely that the plug is non-compliant.

Important

Do not connect network devices other than PLCs or Robot Controllers on the same network as the Touch Finder or computer. If another device is connected, the responsiveness of displays and settings of the Touch Finder or computer may be slow.

2-2 Part Names and Functions

Vision Sensor

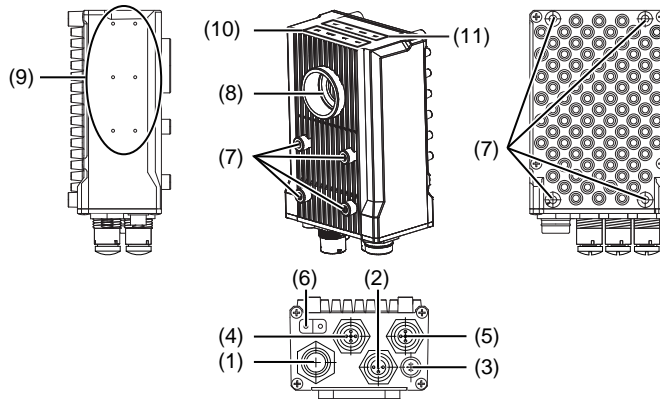

No.	Name	Description	
(1)	I/O connector	An I/O Cable is used to connect the Sensor to the power supply and external devices.	
(2)	Ethernet connector	An Ethernet cable is used to connect the Sensor to external devices such as PLCs, the Touch Finder, or computers.	
(3)	Lighting connector	This connector is used to connect to external lighting (a Strobe Controller).	
(4)	EtherCAT input connector ^{*1}	This connector is used to connect to EtherCAT-compatible devices.	
(5)	EtherCAT output connector ^{*1}	This connector is used to connect to EtherCAT-compatible devices.	
(6)	Node address setting switches ^{*1}	These switches are used to set the node address as an EtherCAT communications device. The setting range is 00 to 99.	
(7)	Mounting holes	These mounting holes are used to mount the camera. 12-3 Specifications and Dimensions p. 428	
(8)	C-mount lens fitting	The C-mount lens is attached here. Determine the appropriate CCTV lens (C-mount lens) to use based on the field of view required for the size of the measurement object. Optical Diagrams p. 33	
(9)	Strobe Controller mounting holes	The Strobe Controller is attached here. The Vision Sensor is compatible with the FL-TCC1. Strobe Controller Installation Method p. 32	
(10)	Measurement process operation indicators	OR	This indicator lights orange when the OR output signal turns ON.
		ETN	This indicator lights orange when Ethernet communications are performed.
		ERROR	This indicator lights red when an error occurs. 11-1 Error Histories p. 382
		BUSY	This indicator lights green when the Sensor is executing a process.
(11)	EtherCAT operation indicators ^{*1}	ECAT RUN	This indicator lights green when EtherCAT communications can be performed.
		ECAT ERROR	This indicator lights red when an EtherCAT communications error has occurred.
		L/A IN	This indicator lights green when the Sensor is connected to an EtherCAT device. It flashes green during data input communications.
		L/A OUT	This indicator lights green when the Sensor is connected to an EtherCAT device. It flashes green during data output communications.

*1: Applicable models: FQ-MS□□□-ECT and FQ-MS□□□-M-ECT.

Detailed LED specifications are given below.

LED name	Color	Status	Contents
ECAT RUN	Green	OFF	Initialization status
		Blinking	Pre-Operational status
		Single flash	Safe-Operational status
		ON	Operational status
ECAT ERROR	Red	OFF	No error
		Blinking	Communication setting error or PDO mapping error
		Single flash	Synchronization error or communications data error
		Double flash	Application WDT timeout
		ON	PDI WDT timeout
L/A IN	Green	OFF	Link not established in physical layer
		Flickering	In operation after establishing link
		ON	Link established in physical layer
L/A OUT	Green	OFF	Link not established in physical layer
		Flickering	In operation after establishing link
		ON	Link established in physical layer

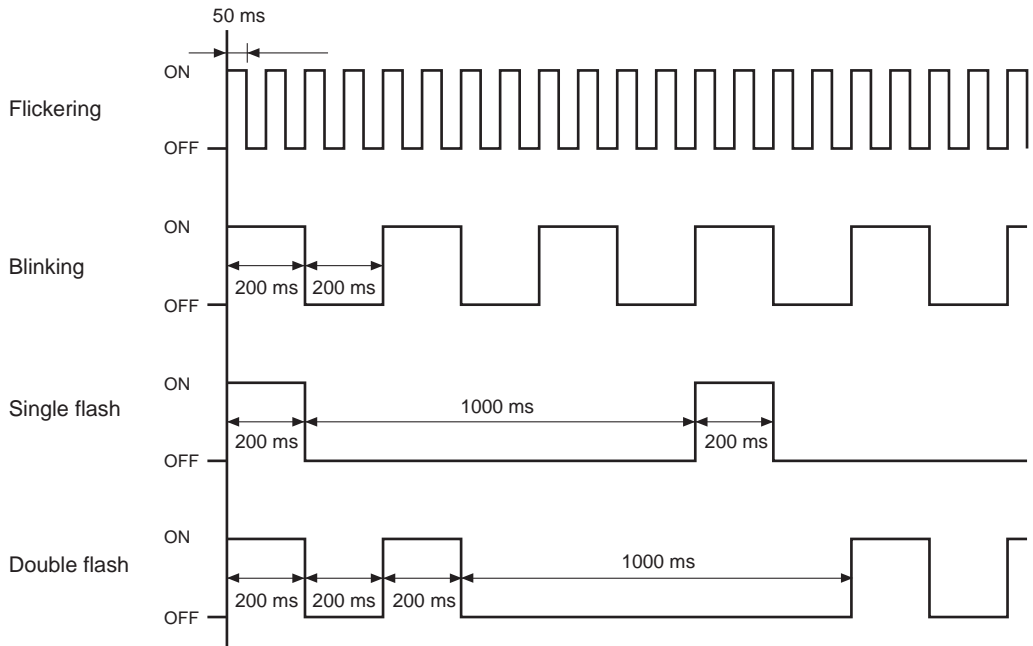

Note

The timing of the flashing of the EtherCAT operation indicators is as follows:

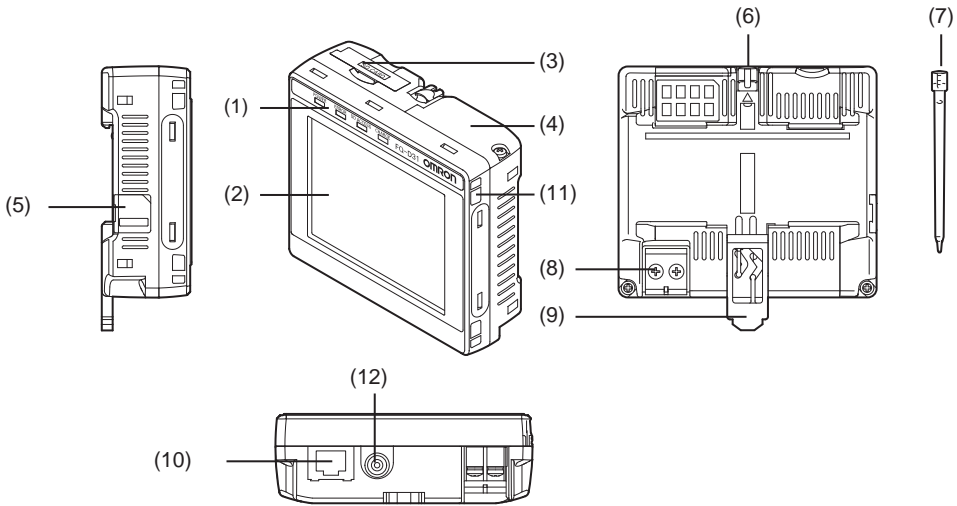

Touch Finder



No.	Name	Description
(1)	Operation indicators	POWER Lights green when the Touch Finder is turned ON.
		ERROR Lights red when an error occurs.  11-1 Error Histories p. 382
		SD ACCESS Lights yellow when an SD card is inserted. Flashes yellow when the SD card is being accessed.
		CHARGE* ¹ Lights orange when the Battery is charging.
(2)	LCD/touch panel	Displays the setting menu, measurement results, and images input by the camera.
(3)	SD card slot	An SD card can be inserted.
(4)	Battery cover* ¹	The Battery is inserted behind this cover. Remove the cover when mounting or removing the Battery.
(5)	Power supply switch	Used to turn the Touch Finder ON and OFF.
(6)	Touch pen holder	The touch pen can be stored here when it is not being used.
(7)	Touch pen	Used to operate the touch panel.
(8)	DC power supply connector	Used to connect a DC power supply.  p. 45
(9)	Slider	Used to mount the Touch Finder to a DIN Track.
(10)	Ethernet port	Used when connecting the Touch Finder to the Sensor with an Ethernet cable. Insert the connector until it locks in place. The indicator will light green when a link is established and flash orange during packet communications.
(11)	Strap holder	This is a holder for attaching the strap.
(12)	AC power supply connector* ¹	Used to connect the AC adapter.

*1: Applicable to the FQ-MD31 only.

2-3 Installation

Installing the Sensor

Installation Procedure

- 1 Mount the Vision Sensor into with M4 screws. You can mount it from either the front or the back.

Tightening torque: 1.2 N·m

Effective depth of front mounting holes: 7 mm

Effective depth of back mounting holes: 8.5 mm

 12-3 Specifications and Dimensions p. 428

Important

Refer to the dimension drawings in the appendix for the positions of the screw holes.

Front Installation

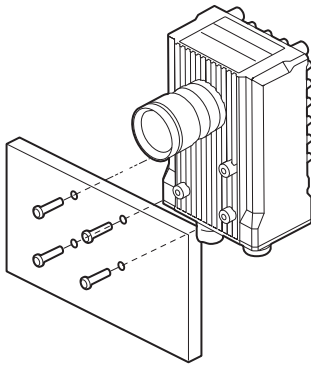

Back Installation

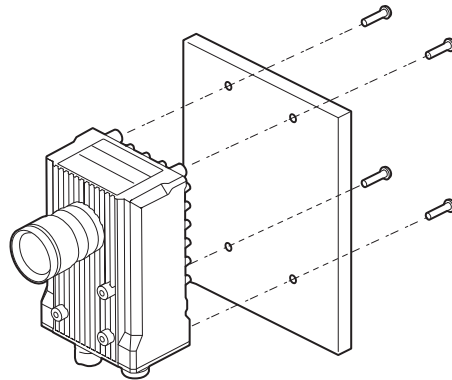

Strobe Controller Installation Method

FL-TCC1 Strobe Controller

- 1 Mount the FL-TCC1 onto the Sensor with the M2 × 6-mm screws enclosed with the FL-TCC1 (tightening torque: 0.15 N·m max.).

FL-TCC1

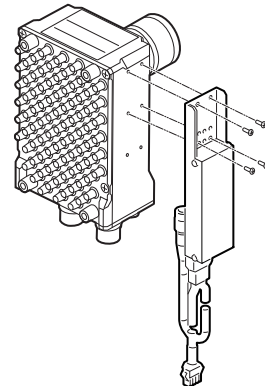

The X axis in the above optical diagrams represent field of view (mm)^{*1}. The Y axis represents the camera installation distance (mm) or WD (mm)^{*2}. These optical diagrams show the relationship between the detection range and installation distance for different CCTV Lenses. The values vary for each Lens. Pay close attention to the Lens that you are using when you refer to these optical diagrams. The macro ring thickness to be used is given as, for example “t5.0,” on the graphs. “t0” means that a macro ring is not required. “t5.0” means that you must use a 5-mm macro ring.

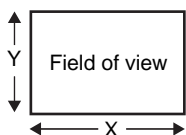

*1: The Y axis in the optical charts represents the height of the field of view.

*2: The Y axis of the Compact Camera represents the WD.

Example: If you use a 3Z4S-LE SV-1614V CCTV Lens for a measurement object that requires field of view of 50 mm, the camera installation distance must be 300 mm and a 1-mm macro ring is required.

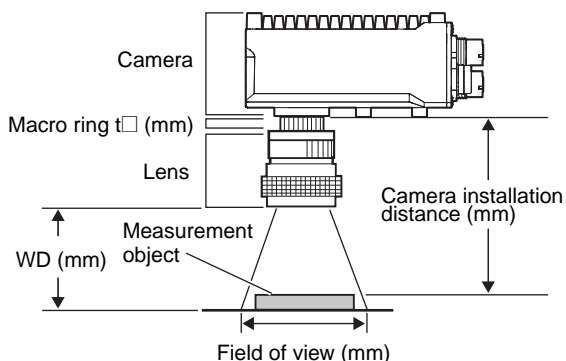

Lens Models and Dimensions

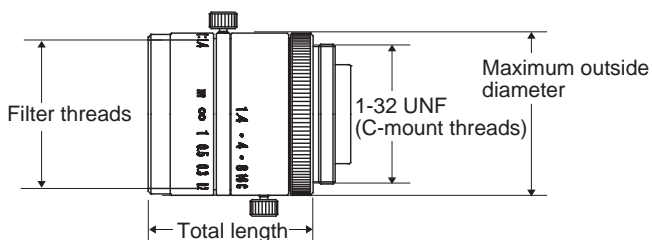

Lens model	Focal length	Brightness	Maximum outside diameter	Total length	Filter size
3Z4S-LE SV-0614V	6.20 mm	F1.4	29 mm	30.0 mm	M27 P0.5
3Z4S-LE SV-0813V	8.05 mm	F1.3	28 mm	34.0 mm	M25.5 P0.5
3Z4S-LE SV-1214V	12.43 mm	F1.4	29 mm	29.5 mm	M27 P0.5
3Z4S-LE SV-1614V	16.34 mm	F1.4	29 mm	24.0 mm	M27 P0.5
3Z4S-LE SV-2514V	25.17 mm	F1.4	29 mm	24.5 mm	M27 P0.5
3Z4S-LE SV-3518V	34.75 mm	F1.8	29 mm	33.5 mm	M27 P0.5
3Z4S-LE SV-5018V	47.97 mm	F1.8	32 mm	37.0 mm	M30.5 P0.5
3Z4S-LE SV-7527V	76.71 mm	F2.7	32 mm	42.0 mm	M30.5 P0.5
3Z4S-LE SV-10035V	95.4 mm	F3.5	32 mm	43.9 mm	M30.5 P0.5

Macro Rings

Macro rings are inserted between the Lens and the camera to adjust the focus. You can use up to seven macro rings to achieve the required thickness.

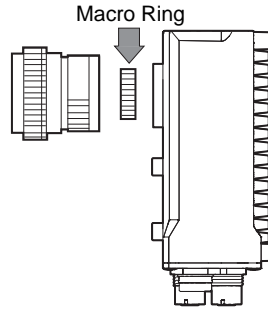

Model	Maximum outside diameter	Thickness
3Z4S-LE SV-EXR	31 mm	7-piece set Thickness: 0.5 mm 1 mm 2 mm 5 mm 10 mm 20 mm 40 mm

Important

- Do not stack 0.5 mm, 1.0 mm, and 2.0 mm macro rings. These sizes fit between the Lens and the threaded portion of other macro rings. If two or more are stacked together, the screw cannot be tightened securely.
- The macro rings may need to be reinforced depending on the vibration conditions if over 30 mm is used.

Installing the Touch Finder

Installation Precautions

Install the Touch Finder in the following orientation to allow sufficient heat dissipation.

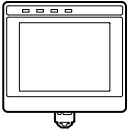

Do not mount it in the following orientations.

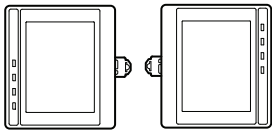

Important

- To improve ventilation, leave space on both sides of the Touch Finder. The distance between the Touch Finder and other devices should be at least that shown in the following diagram.

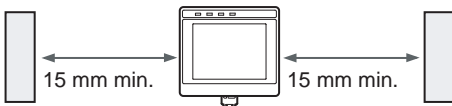

- Make sure that the ambient temperature is 50°C or lower. If it exceeds 50°C, install a cooling fan or an air conditioner and maintain the temperature at 50°C or lower.
- To prevent interference by noise, do not mount the Sensor on panels which contain high-voltage devices.
- To keep the level of noise from the surrounding environment to a minimum, install the Sensor and Touch Finder at least 10 m away from power lines.

Mounting to DIN Track

Installation Procedure

- 1** Press the slider on the Touch Finder to the top.
- 2** Hook the clip at the top of the Touch Finder on to the DIN Track.
- 3** Press the Touch Finder onto the DIN Track until the bottom clip clicks into place.

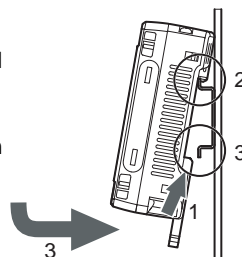

Important

- Attach End Plates (sold separately) on the sides of the Touch Finder on the DIN Track.
- If other devices will be installed next to the Touch Finder on the same DIN Track, make sure that sufficient space is kept between the devices as indicated on previous page.
- Always hook the clip at the top of the Touch Finder on the DIN Track first. If the lower clip is hooked on first, the Touch Finder will not be mounted very securely.

Removal Procedure

- 1** Pull down on the slider on the Touch Finder.
- 2** Lift the Touch Finder at the bottom and remove it from the DIN Track.

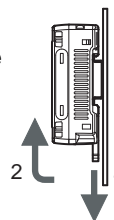

Mounting to a Control Panel

The Touch Finder can be mounted on a panel using the FQ-XPM Panel Mounting Adapter.

Important

- Always turn OFF the Touch Finder power before attaching or detaching the Panel Mount Adapter. Attaching or detaching with the power turned ON may cause a failure.

- 1** Set the Touch Finder in the Panel Mount Adapter.

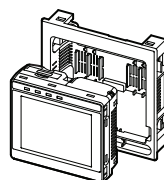

2 Press the slider up on the Touch Finder.

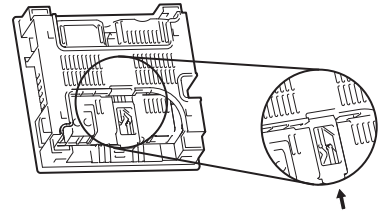

3 Create holes in the panel for mounting.
Refer to the following page for hole dimensions.

 p. 438

4 Connect the cable to the Touch Finder.

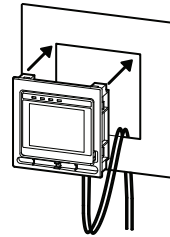

5 Mount the Touch Finder with the Panel Mount Adapter from the front of the panel.

6 Hook the hooks on the Mounting Bracket in the four holes of the Panel Mount Adapter and secure them with screws. (Tightening torque: 1.2 N-m)

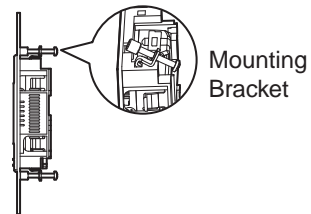

7 Check that the Touch Finder is attached properly to the Panel.

Using the Touch Finder as a Portable Device (with Battery)

The Touch Finder with a Battery can be used as a portable device. Use the strap when carrying it to prevent dropping it.

There are two types of straps (FQ-XH, sold separately), a Neck Strap and a Hand Strap.

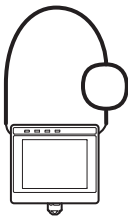

Neck Strap

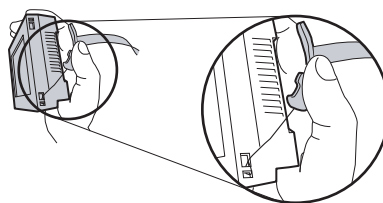

Hand Strap

1 Attach the Mini-strap to the Touch Finder.

There are a total of four holes for attaching the Mini-strap on the left and on the right of the Touch Finder.

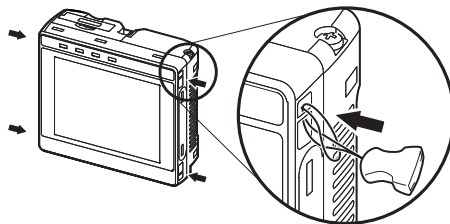

2 Connect the Neck Strap or Hand Strap to the Mini-strap.

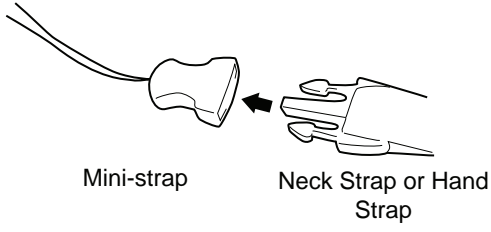

2-4 Wiring

Wiring the Sensor

Connect and secure the I/O Cable to the I/O Cable connector located at the bottom of the Vision Sensor. Wire the I/O Cable signals.

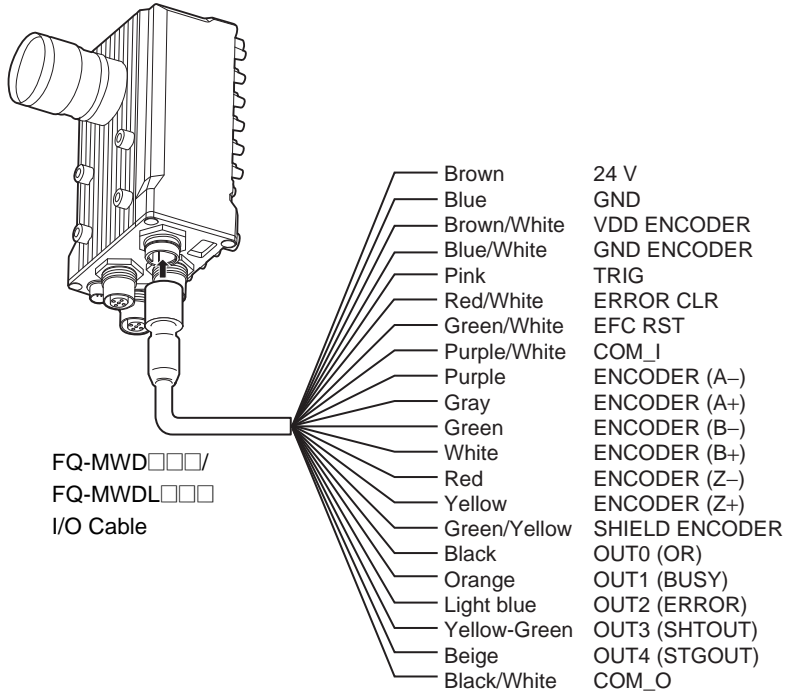

Important

Cut off lines that are not required so that they do not come into contact with the other signal lines.

Classification	Signal	Application
Power supply	Power supply (24 V)	These terminals are for the external power supply (24 V).
	GND	Important Wire the power supply separately from other devices. If the wiring for other devices is placed together or in the same duct as the wiring for the Vision Sensor, the influences of electromagnetic induction may cause the Sensor to malfunction or may damage it.
	VDD ENCODER	These terminals are for the encoder power supply.
	GND ENCODER	Connect these terminals to the same power supply as the encoder (5 V, 12 V, or 24 V).
Inputs	TRIG	This terminal is the trigger signal input.
	ERROR CLR	This terminal is the clear error input.
	EFC RST	This terminal is the encoder ring counter reset input.
	COM_I	This is the common terminal for the TRIG, ERROR_CLR, and EFC_RST signals.
Encoder inputs	ENCODER (A±, B±, Z±)	These terminals are for the encoder inputs.
Shield wire	SHIELD ENCODER	This is the shield wire for encoder signals. Connect the shield wire to the GND ENCODER ground wire for the encoder power supply.

Classification	Signal	Application
Outputs	OUT0(OR)	This is an output terminal. By default, this is the OR output signal (overall judgement). The assignment can be changed to an individual judgement signal between OR0 and OR31.
	OUT1(BUSY)	This is an output terminal. By default, this is the BUSY output signal. The assignment can be changed to an individual judgement signal between OR0 and OR31.
	OUT2(ERROR)	This is an output terminal. By default, this is the ERROR output signal. The assignment can be changed to an individual judgement signal between OR0 and OR31.
	OUT3(SHTOUT)	This is an output terminal. By default, this is the SHTOUT output signal (shutter output). ^{*1} The assignment can be changed to an individual judgement signal between OR0 and OR31.
	OUT4(STGOUT)	This is an output terminal. By default, this is the STGOUT output signal (strobe trigger output). ^{*2,3} The assignment can be changed to an individual judgement signal between OR0 and OR31.
	COM_O	This is the common terminal for the OUT0 to OUT4 output signals.

*1: This signal is output to an external device when exposure of the imaging elements is completed. If you want to move the Sensor to the next measurement location after a measurement is completed, move the Sensor only after this signal turns ON.

Shutter Output Signal (SHTOUT)

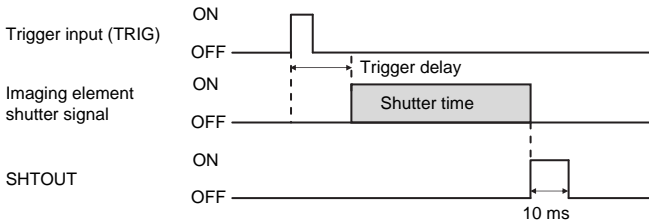

The SHTOUT signal turns ON for approximately 10 ms (fixed) when the shutter time (exposure period) elapses after the trigger is input from an external device.

*2: This control signal is used to turn ON external lighting when an image is taken. Connect this signal to external lighting.

*3: You can select whether to turn the external lighting ON (Positive) or OFF (Negative) when the signal turns ON. (The setting is called the strobe output polarity.)



Changing the Output Polarity of the STGOUT Signal p. 225

Note

The assignments of I/O signals can be changed.



Communications with External Devices p. 213

I/O Signal Circuit Diagrams

NPN

Input Circuit

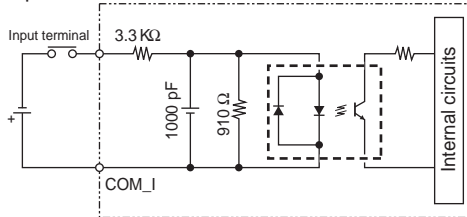

Output Circuit

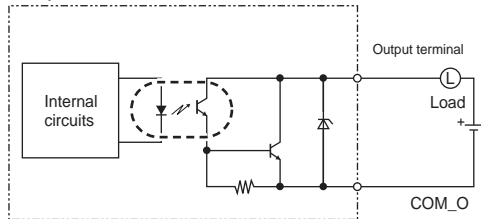

PNP

Input Circuit

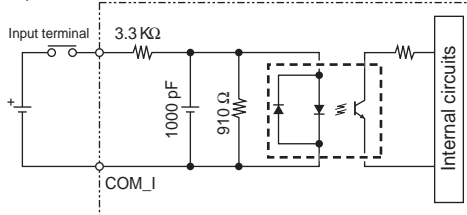

Output Circuit

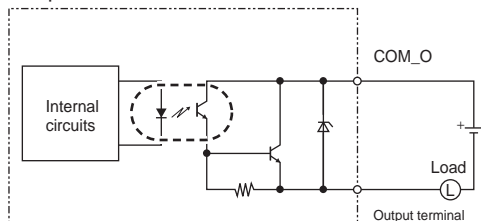

Important

Preventing Chattering

- The Sensor is equipped with an anti-chattering function, but if the chattering is 100 μs or longer, a faulty input may occur. (Input signals of 99 μs or shorter are ignored. Signals of 100 μs or longer are treated as input signals.)
- Use no-contact output devices (e.g., SSR or PLC transistor output) for the input signals. If contacts (e.g., a relay) are used, chattering may cause the trigger to be input again during execution of a measurement.

Power Supply Specifications When a Switching Regulator Is Connected

Use a power supply that meets the following specifications. (They are sold separately.)

Item	Description
Power supply voltage	24 VDC (21.6 to 26.4 V)
Output current	0.65 A or higher when no Strobe Controller is connected 1.3 A or higher when a Strobe Controller is connected
Recommended Power Supplies	S8VS-01524□ (15 W, 0.65 A) when no Strobe Controller is connected S8VS-03024 (30 W, 1.3 A) when a Strobe Controller is connected
External power supply terminal screws	M4 (tightening torque: 1.2 N·m)

Important

Use a DC power supply with safety measures against high voltages (safety extra low-voltage circuit).

If UL certification is required for the overall system, use a UL Class II DC power supply.

Encoder Connection Examples

NPN Open-collector Input

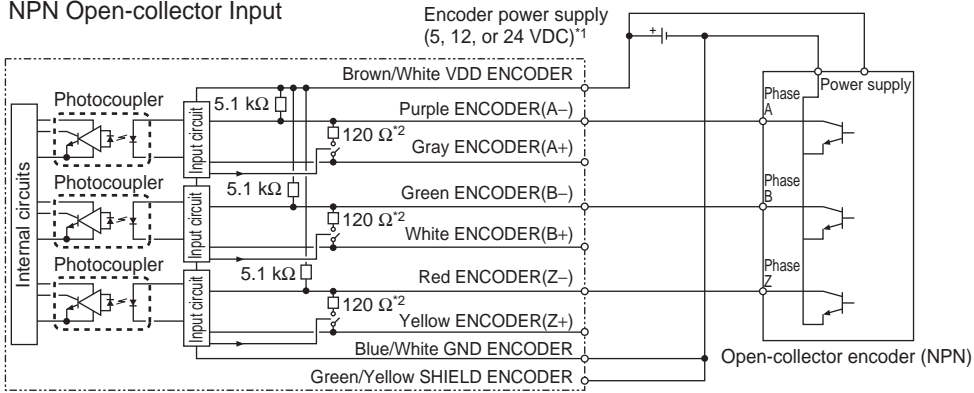

FQ-M

- *1: Connect these wires to the same power supply as the encoder (5, 12, or 24 V).
- *2: The 120-Ω resistors are used when line driver encoders are connected. Make the software settings to turn OFF the switches that are connected to the 120-Ω resistors when open-collector encoders are connected.

PNP Open-collector Input

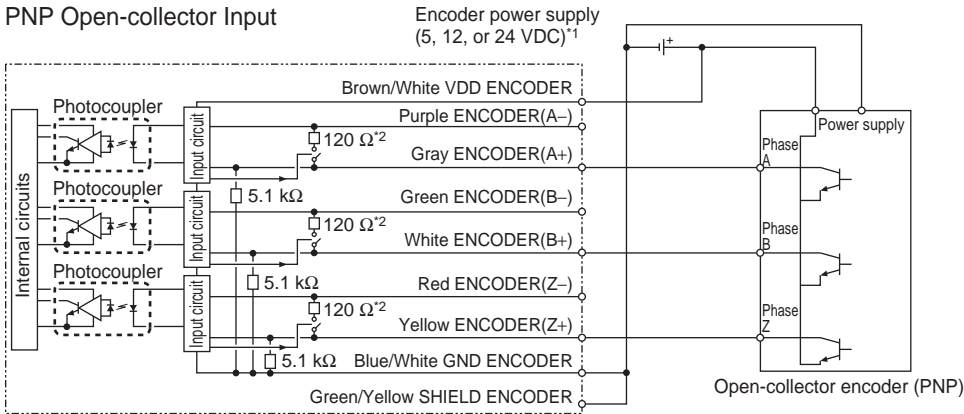

FQ-M

- *1: Connect these wires to the same power supply as the encoder (5, 12, or 24 V).
- *2: The 120-Ω resistors are used when line driver encoders are connected. Make the software settings to turn OFF the switches that are connected to the 120-Ω resistors when open-collector encoders are connected.

Line-driver Input

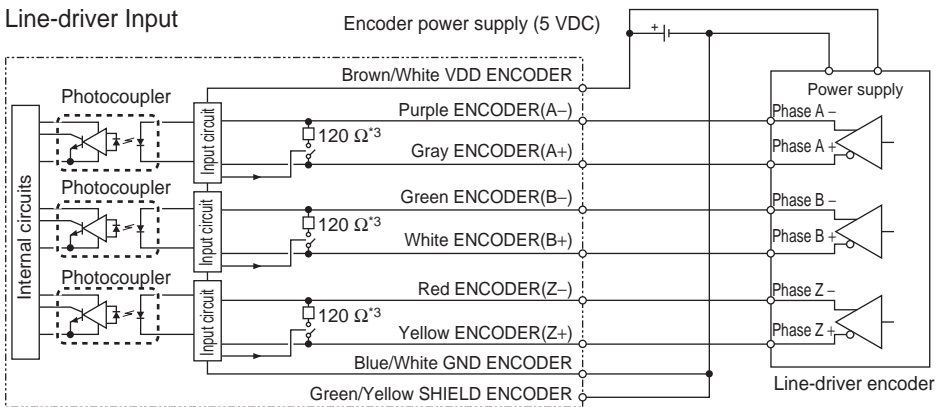

FQ-M

- *3: The 120-Ω resistors are used when line driver encoders are connected. The terminating resistance can be turned ON and OFF from the PC Tool. Turn the terminating resistance ON or OFF according to the application conditions.



Controlling Measurement Timing with an Encoder Input p. 339

Grounding

The case of the Sensor, the shell of the Ethernet connector, and the hood of the lighting connector are at the same electrical potential. They are connected to 0 V by the internal circuits through a capacitor and resistor. The shell of the EtherCAT connector is connected to the case through a capacitor and resistor.

Ground the object to which the case of the Sensor is mounted (e.g., the machine frame).

Normal Grounding

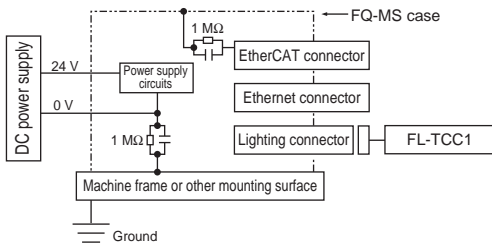

Grounding the Positive 24-VDC Power Supply Terminal

Do not connect 3Z4S-LT-series Strobe Controller if you ground the positive 24-VDC power supply terminal. The connector shell on the Strobe Controller cable is the signal ground (SG), which will cause a short-circuit in the power supply due to a difference in electrical potential with the Sensor case.

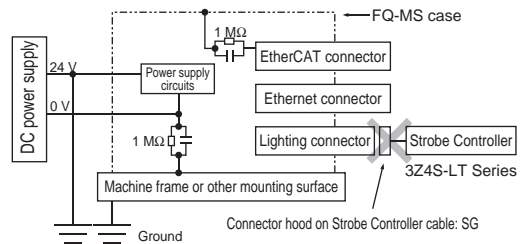
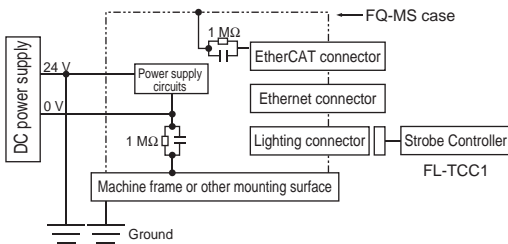

Wiring the Touch Finder

Power Supply Wiring

Connecting the Power Supply

- 1** Loosen the two terminal screws using a Phillips screwdriver.
- 2** Attach crimp terminals to the power lines. Secure the positive and negative lines as indicated using M3 screws.
Power supply tightening torque: 0.54 N·m
- 3** In environments where there is excessive noise, attach a ferrite core (ZCAT1730-0730 from TDK or the equivalent) to the power supply cable.

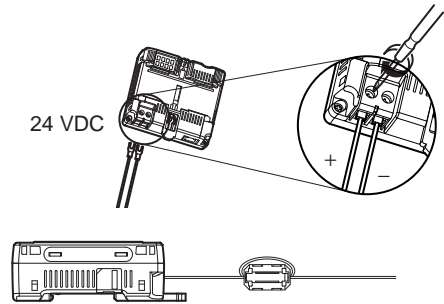

When you attach the ferrite core to the power supply cable, wrap the cable only one time.

Turning ON the Touch Finder

- 1** Remove the cover from the power switch on the left side of the Touch Finder.
- 2** Press the switch toward **ON**.

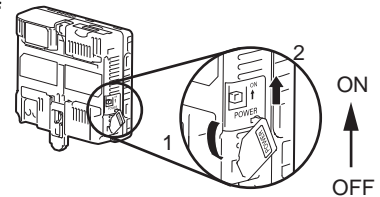

Power Supply Specifications

Use a power supply that meets the following specifications. (The power supply is sold separately.)

Item	Description
Power supply voltage	24 VDC (21.6 to 26.4 V)
Output current	0.65 A min.
Recommended Power Supply	S8VS-01524□ (24 VDC, 0.65 A)
External power supply terminal screws	M4 (tightening torque: 1.2 N·m)
Recommended power line wire size	AWG16 to AWG22 (length of 5 m max.)

Important

- Supply power from a DC power supply for which measures have been applied to prevent high voltages (e.g., a safety extra low voltage circuit).
If UL certification is required for the overall system, use a UL Class II DC power supply.
- When using the FQ-MD31, do not connect a switching regulator and AC Adapter (FQ-AC□) at the same time.

Charging the Battery

This section describes how to charge and install the FQ-MD31 Battery and provides applicable precautions.

Charge the Battery while it is attached to the Touch Finder.

Use the AC adapter to charge the battery.

Mounting the Battery in the Touch Finder

- 1** Remove the screw from the battery cover on the top of the Touch Finder, slide the cover in the direction of the arrow, and open the battery cover.

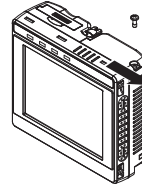

- 2** Face the rounded side of the battery toward the back of the Touch Finder and insert the battery.

Important

Do not insert the battery in the wrong orientation.

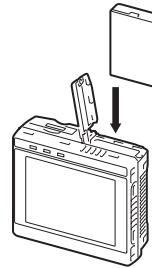

- 3** Close the battery cover, slide the battery cover in the direction of the arrow, and tighten the screw on the battery cover.

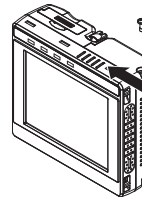

- 4** Attach the AC adapter to the Touch Finder to start charging the battery.

The CHARGE indicator will be lit while the battery is being charged. It will go out when charging the battery has been completed.

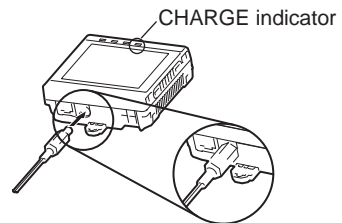

Note

The Touch Finder will operate even if the AC adapter is connected when no battery is mounted in the Touch Finder.

Important

- If the Touch Finder (FQ-MD31) will be installed permanently or semi-permanently, remove the Battery (FQ-BAT1). If the rated temperature is exceeded with the Battery inserted, the protective circuit may activate and stop the Touch Finder.
- The battery complies with the following recycling regulation.

Japan



Li-ion00

EU



Taiwan



- California regulations concerning perchlorate:

This product is a lithium battery that contains perchlorate, which is regulated by the State of California. Please comply with these regulations. For details see the following URL:

www.dtsc.ca.gov/hazardouswaste/perchlorate/

2-5 Installing the Sysmac Studio

The PC Tool used to set up FQ-M-series Vision Sensors is installed from the Sysmac Studio Installer. Refer to the *Sysmac Studio Version 1 Operation Manual* (Cat. No. W504) for the system requirements and installation procedure.

2-6 Starting a Project

Connecting to the Sensor from the PC Tool

Creating a Project

This section shows how to create a project, add a Vision Sensor to the project, and start communicating with the Vision Sensor.

1 Start the PC Tool.

2 Create a project.

Click [New Project], select [Vision Sensor] for the [Category] of the [Select Device], and select [FQ-M] for the [Device].

Then enter information for the [Project name], [Author], and [Comment] fields.

Click the [Create] Button. An empty project is created.

Note

If you have already created a project, click the [Open Project] Button. A list of existing projects is displayed. Select the project you want to open, and then click the [Open] Button. When you open an existing project, the project will start in Offline Mode. Refer to the following section for information on Offline Mode.

 Section 10 Offline Settings p. 371

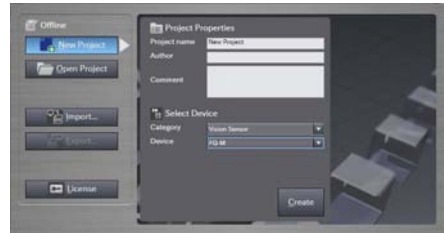

3 Use either of the following methods to specify the Sensor to connect to.

- Searching for the Sensor to Connect to
Click [Search for sensors] and select a Sensor. When you click the [Execute] Button, a list of all the Sensors found on the network is displayed. Click the Sensor you want to connect to, and then click the [OK] Button.
- Directly Enter the IP Address of the Sensor to Connect to
Select the [Specify the IP address] Check Box. Enter the IP address of the Sensor you want to connect to, and then click the [OK] Button.
- Not Connecting to a Sensor (Offline Mode)
To not connect to an actual Sensor and set up the project in Offline Mode, click [Enter the type]. Select a Sensor model and software version, and then click the [OK] Button.

 Section 10 Offline Settings p. 371

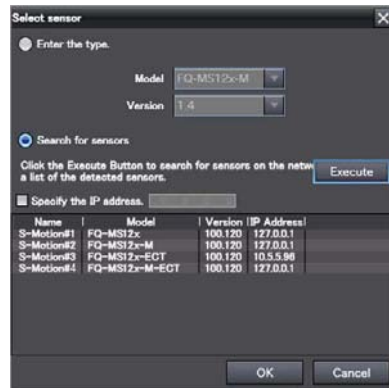

4 After connecting to the Sensor, the following pane is displayed.

If the Sensor Has Not Been Set Up:

- The Edit Scene Pane is displayed for the Edit Pane.
The Sensor starts in Setup Mode.

If the Sensor Has Already Been Set Up:

- The Main Pane is displayed for the Edit Pane.
The Sensor starts in Run Mode.



Adding a Sensor to a Project

After you create a project, you can add Sensors to it.

- ▶ **Multiview Explorer: [Device group] (Right-click) – [Add]**

Note

When a Sensor is added to the project, a scene (scene 0) is also automatically added.

Entering Project Information

You can enter comments related to the project.

- ▶ **Multiview Explorer: [Device group] – Sensor name (Double-click)**
→ **Edit Pane: [General settings] icon**

- 1 Enter comments about the project in the [Comment] field.

Note

Use the following procedure if you connected to the Sensor from the Touch Finder.

- 1 The Sensor is automatically detected by the Touch Finder when the power supply to the Sensor and Touch Finder is turned ON.**

The Auto Connect Display will appear if the Sensor cannot be detected. Check that the cable is connected correctly to the Sensor and Touch Finder, and then press [Auto connect]. If the Sensor is still not detected after you press [Auto Connect], refer to the following information.

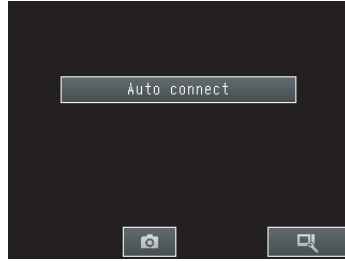

 The Sensor cannot be detected: p. 391

- 2 When the Sensor is detected, the following display will appear.**

The Setup Mode will appear if a Sensor that has not been set up is connected.



The Run Mode will appear if a Sensor that has already been set up is connected.



2-7 The User Interface

PC Tool

This section describes the names and functions of elements of the Sysmac Studio user interface.

Main Window

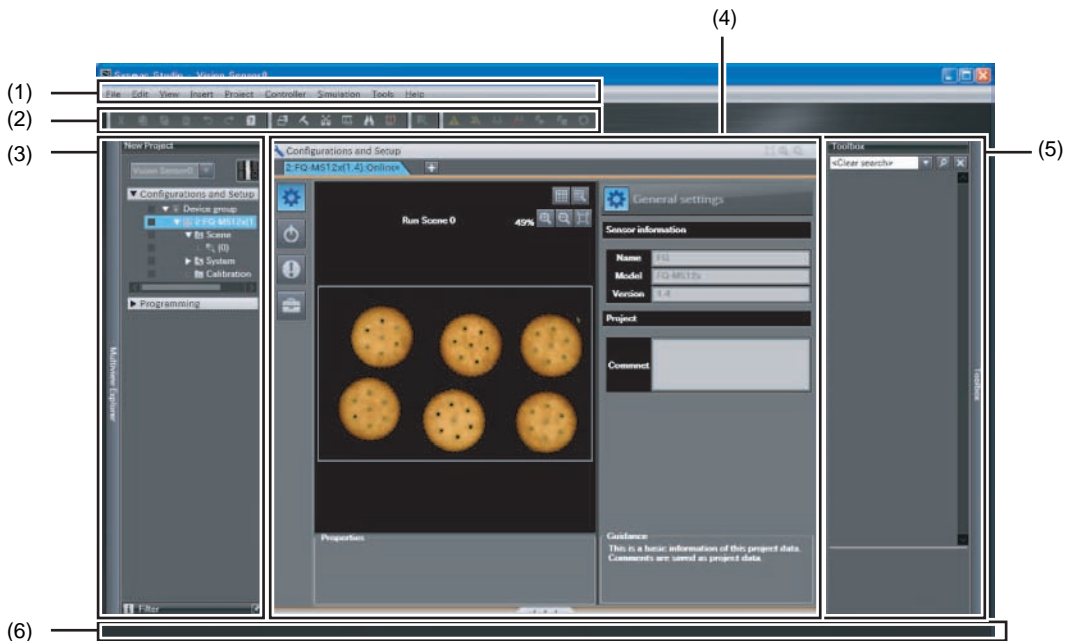

No.	Name	Description
(1)	Menu bar	This is where the menu for the PC Tool is displayed.
(2)	Toolbar	This is where the icons for the various tools available in the PC Tool are displayed.
(3)	Multiview Explorer	The Multiview Explorer displays the data hierarchy of the Sensor in a tree format. You can double-click data items to display the Main Pane, Scene Data Edit Pane, System Data Edit Pane, or Calibration Data Edit Pane for the Edit Pane.
(4)	Edit Pane	The Edit Pane is used to edit and view the data selected in the Explorer Pane. The Edit Pane primarily consists of images, settings, properties, and guidance.
(5)	Toolbox	The Toolbox displays a list of all inspection items that you can add to the scene. You can add inspection items to the scene by dragging them with the mouse.
(6)	Status bar	The status bar displays the status of the setting operation.

Explorer Pane

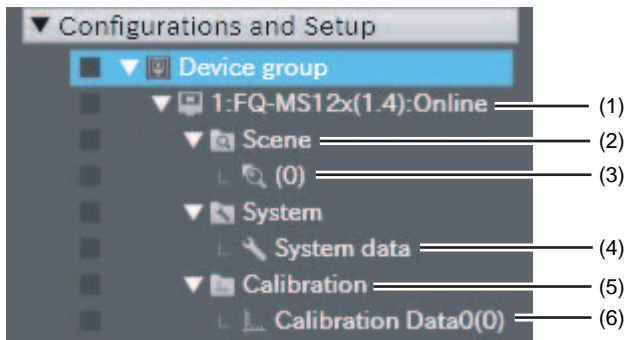

No.	Name	Description
(1)	Sensor model	Displays the model of the Vision Sensor. The online/offline status of the Sensor is displayed after the model number.
(2)	Scene group	A scene group is a collection of scene data. Up to 32 scene data items can be added to a single scene group.
(3)	Scene data	Scene data includes image settings, inspection settings, or output settings. The scene data names are also displayed. The number in parenthesis is the scene number.
(4)	System data	System data is shared by all scenes.
(5)	Calibration group	A calibration group is a collection of calibration data. Up to four calibration data items can be added to a single calibration group.
(6)	Calibration data	Calibration data is used to convert the scale of position coordinates that are measured during inspection. Up to four calibration data items can be added.

Right-click Menus

Tree view item	Menu command	Description
Device group	Add – FQ-M	Adds a Sensor to the project
	Paste	Pastes a copied Sensor into the project.
	Rename	Renames the device group.
Sensor model	Edit	Displays the Main Pane for the Edit Pane.
	Delete	Deletes the Sensor from the project.
	Copy	Copies the Sensor.
	Setup	When online, changes the Sensor to Setup Mode.
	Run	When online, changes the Sensor to Run Mode.
	Start monitor	Displays the Monitor Pane as a modeless dialog box.
	Online	Places a Sensor online.
	Offline	Places a Sensor offline.
Scene group	Add – Scene data	Adds a new scene to the scene group.
	Paste	Adds the copied scene to the scene group.
Scene data	Edit	Displays the Edit Scene Pane for the Edit Pane.
	Copy	Copies the scene.
	Delete	Deletes the scene.
	Rename	Renames the scene.
System data	Edit	Displays the System Data Edit Pane for the Edit Pane.
	Copy	Copies the system data.
	Paste	Overwrites the system data. Before overwriting, a confirmation message (yes/no: default) is displayed.
Calibration group	Add – Calibration scene data	Adds new calibration data to the calibration group.
	Paste	Adds the copied calibration data to the calibration group.
Calibration data	Edit	Displays the Calibration Data Edit Pane for the Edit Pane.
	Copy	Copies the calibration data.
	Delete	Deletes calibration data.
	Rename	Changes the name of the calibration data.





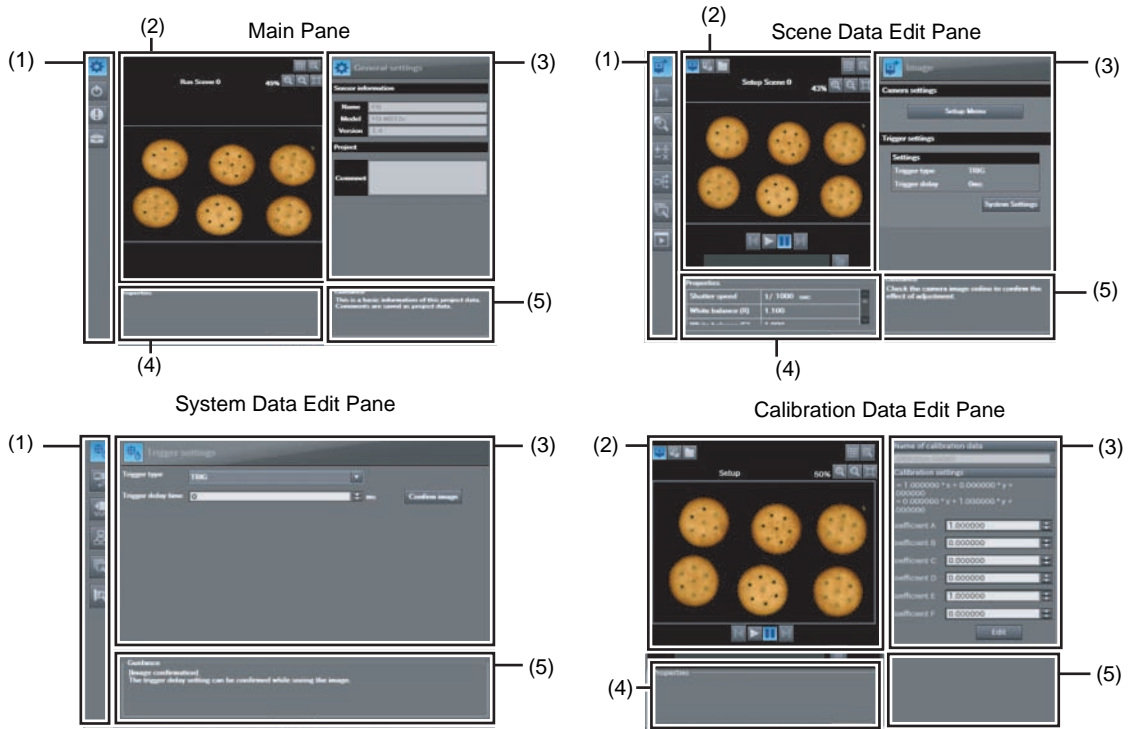













Edit Pane

The Edit Pane changes as shown below based on what is selected in the Explorer Pane.



No.	Name	Description
(1)	Menu icons	Allows you to change the parameters that are displayed in the Edit Pane.
(2)	Image	Displays the Sensor image that is being edited. When online, the image from the connected Sensor is displayed. When offline, the image from the specified image file is displayed.
(3)	Parameters	Allows you to edit the parameters for the selected menu icon. A dialog box is displayed when editing parameters.
(4)	Property	Displays the details of the parameters.
(5)	Guidance	Displays a description of the currently selected parameter.

(1) Menu Icons

Edit Pane	Icon	Menu command	Description
Main Pane		General settings	Allows you to view Sensor names and project information.
		Online	Allows you to switch between online and offline and switch run modes. You can also transfer settings data, save settings data, and monitor measurement results.
		Error history	Allows you to view and clear errors that have occurred in the Sensor.
		Support software	Allows you to initialize or upgrade the Sensor. You can also print the patterns that are used for calibration. You can import, export, and print the project data.
Scene Data Edit Pane		Image	Allows you to change image conditions, such as the shutter speed, white balance, and external lighting. You can also adjust the timing to take images.
		Calibration	Allows you to change the scale of position coordinates measured during inspection. You can select from any of the registered calibration patterns.
		Inspection	Allows you to use the Search, Shape Search, Edge Position, and Labeling inspection items to set up the inspections. Up to 32 inspection items can be registered.
		Calculation	Allows you to perform calculations using inspection results. You can make up to 32 expressions.
		Logging	Allows you to set the data to log to the Sensor's internal memory, the Touch Finder, or external PC memory for each inspection.
		Output	Allows you to set up the data to output to external devices through Ethernet or EtherCAT, such as PLCs or Robot Controllers.
		Run	Allows you to save settings data to the Sensor's internal memory, switch Sensor modes, or monitor measurement results.
System Data Edit Pane		Trigger settings	Allows you to select the external trigger signal and set the timing.
		I/O settings	Allows you to set the I/O conditions for parallel I/O.
		Encoder settings	Allows you to set encoder input conditions, the maximum ring counter value, and offsets. Also allows you to set conditions when using an encoder as a measurement trigger.
		Ethernet communication settings	Allows you to change settings related to Ethernet communications. You can set Sensor settings, data output network settings, and output conditions.
		EtherCAT communication settings	Sets parameters for EtherCAT communications. Allows you to set communications conditions to output data to the EtherCAT master or to control the Sensor from the EtherCAT master.
		Log settings	Allows you to set execution conditions for statistical data, image data, and measurement data logging.
		Sensor settings	Allows you to set the scene number when the Sensor starts, change the password, and set up the Adjustment Mode in Run Mode.

(2) Operation Icons

Edit Pane, Dialog Box



Monitor Pane



Icon	Name	Description
	Camera image	Displays the image from the Sensor.
	Logging image	Displays images logged in the Sensor's internal memory.
	Image file	Displays the image from the specified file.
	Live	Starts updating the image on the display.
	Freeze	Stops updating the image on the display.
	Switch to the next image	Displays the next image when the image on the display is not being updated and when a logged image or file image is currently displayed.
	Switch to the previous image	Displays the previous image when the image on the display is not being updated and when a logged image or file image is currently displayed.
	Select the image	Selects the image file to display when displaying file images.
	Zoom in	Enlarges the displayed image.
	Zoom out	Reduces the displayed image.
	Maximum	Automatically resizes the displayed image to fit the size of the pane.
	Switch the scale display on and off	Displays scale lines on the image.
	Set the conditions of the scale display	Allows you to change scale line settings.
	Single-view display	Changes to a single-view display.
	4-view display	Changes to a 4-view display (Graphics, Result List, Histogram, and Trend Graph).
	Graphics	Graphically displays the measurement results of selected inspection items.
	Result list	Displays a list of all inspection item measurement results.
	Trend graph	Displays a trend graph.
	Histogram	Displays a histogram.
	Latest result	Updates the view after each measurement.
	Latest NG	Refreshes the display after each NG result.
	Start logging	Starts logging to a file.
	Stop logging	Stops logging to a file.

Touch Finder

Setup Mode

In Setup Mode, you can set the image conditions, judgement parameters, and I/O settings for the Sensor.

The name of the mode or the menu hierarchy is displayed.

The name of the Sensor being set up is displayed.

The selected scene number is displayed.

The menu changes according to the selected tab page.

- Buttons will appear on the right according to the mode.
- If the [◀] Button appears, pressing it will display the sub-menu or commands.

The setup flow is shown by these five tabs.

[Image]: Used to adjust the image.

[Inspect]: Used to set the inspection items.

[In/Out]: Used to set the I/O.

[Test]: Used to test and adjust the set measurements.

[Run]: Used to switch to Run Mode.

- This button menu is always displayed.
- Only-image Button: Used to select either displaying the camera image and messages, or only the camera image.
 - Display Button: Used to select the source of the image or to zoom the image.
 7-2 Display Functions p. 183
 - Capture Button: Used to capture the current screen to the SD card.
 Capturing the Displayed Image p. 209
 - Tool Button: Used to call functions, such as saving data or select scenes.

Note

The Display Button can be used to switch between the following images.

- Live: The live image is displayed.
- Freeze: The image that was taken last is displayed.
- Log: An image saved in internal memory is displayed.
- File: An image saved on an SD card is displayed.

p. 163

Note

The Touch Finder does not support guide lines or a 4-view display (Graphics, Result List, Histogram, and Trend Graph). These are supported only by the PC Tool.

2-8 Saving a Project

Saving a Project

You can save the project you are currently editing in the PC Tool.

The following information is stored in a saved project.

Data	Description
Project information	Sensor data registered in the project
Sensor all information	All of the Sensor data. This data is compatible with the Touch Finder.
PC Tool settings data	PC Tool setting parameters for each Sensor registered in the project <ul style="list-style-type: none">• Monitoring data• File logging specifications

You cannot save projects while in Run Mode. Change to Setup Mode, and then save the project.

Note



Changing to Setup Mode p. 165

1

Select [File] – [Save] from the menu bar.

Exporting Projects

You can export the project data to a single file (.smc) or to seven different files that can be read by the Touch Finder (file types: scn, sgp, syd, clb, cgp, bkd, and vsn). You can import the exported data to use it on the PC Tool running on a different computer. The different types of data are described below.



Exportable and Importable File Types p. 61

Exporting Project Data

1

Select [File] – [Export] from the menu bar.

Exporting Data That the Touch Finder Can Read

1

Multiview Explorer: [Device group] – Sensor name (Double-click)

Select  (Support software) Icon – [Sensor data] – [Save] in the Edit Pane.

- 2 When [Scene data] or [Calibration scene data] is selected as a file type, you can specify the data to export.

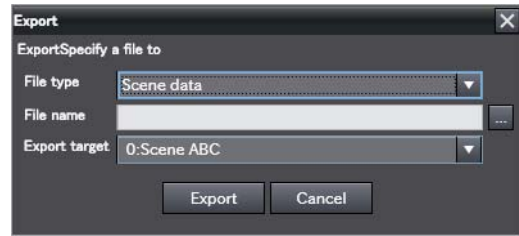

Note

Scene data 0 through 31 and any calibration scene data is displayed for export. You cannot specify any location (number) that has no data.

Importing Projects

You can import data that has been exported from another computer into your projects as project data.

Importing Project Data

- 1 Select [File] – [Import] from the menu bar.

Importing Data That the Touch Finder Can Read

- 1 Multiview Explorer: [Device group] – Sensor name (Double-click)
Select  (Support software) Icon – [Sensor data] – [Save] in the Edit Pane.
- 2 When [Scene data] or [Calibration scene data] is selected as a file type, you can specify where to import the data.

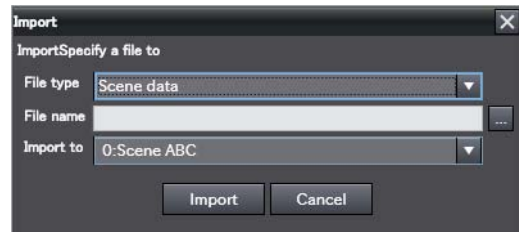

Note

Scene data 0 through 31 and any calibration scene data is displayed for import. You can specify any location (number), even if no data exists there yet.

Exportable and Importable File Types

Select the file type from the drop-down list.

File type	File name extension	Description
Project data	smc	All of the project data
Scene data	scn	Settings data for an FQ-M scene (scene 0 to 31)
Scene group data	sgp	Settings data for all FQ-M scenes (scenes 0 to 31)
Sensor system data	syd	FQ-M system data
Calibration scene data	clb	Individual FQ-M calibration scene data (scene 0 to 31)
Calibration scene group data	cgp	All of the calibration scene data in the FQ-M (scenes 0 to 31)
Sensor all data	bkd	A collection of system data, scene group data, and calibration scene group data

MEMO

Taking Images

3-1 Selecting a Sensor for Configuration	64
3-2 Adjusting Image Quality	69
3-3 Synchronizing the Measurement Object Image Capture Timing	79
3-4 Preventing Mutual Interference of Multiple Sensors	82

3-1 Selecting a Sensor for Configuration

If more than one Sensor is connected to the Touch Finder or computer, you can select the Sensor that you want to set up.

PC Tool

Selecting a Sensor That Is Registered in the Project

You can select a Sensor for setting from the Multiview Explorer. You can select from the Sensors that have already been added to the project.

- 1 Click the Sensor you want to set from the list of registered Sensors in the Multiview Explorer.

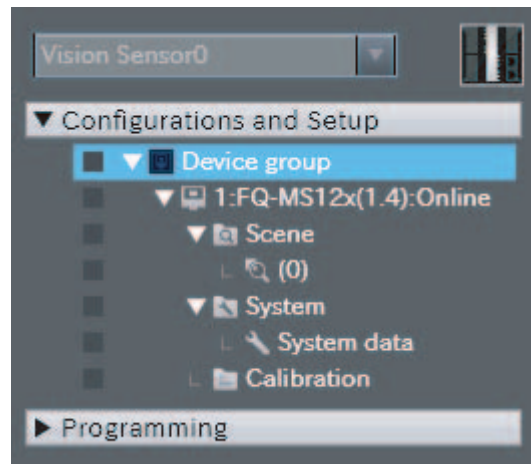

Adding a Sensor to the Project

If you want to connect multiple Sensors to a single computer, use the PC Tool to add those Sensors to the project.

- 1 Right-click [Device group] in the Multiview Explorer, then select [Add] – [FQ-M].

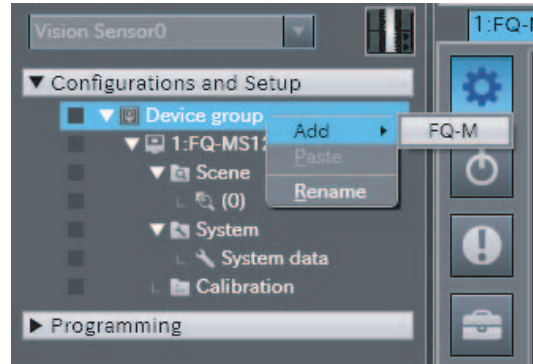

- 2 To make the settings offline, click [Enter the type].

To make the settings online, click [Search for sensor], and then click [Execute]. After that, click the Sensor you want to set from the list.

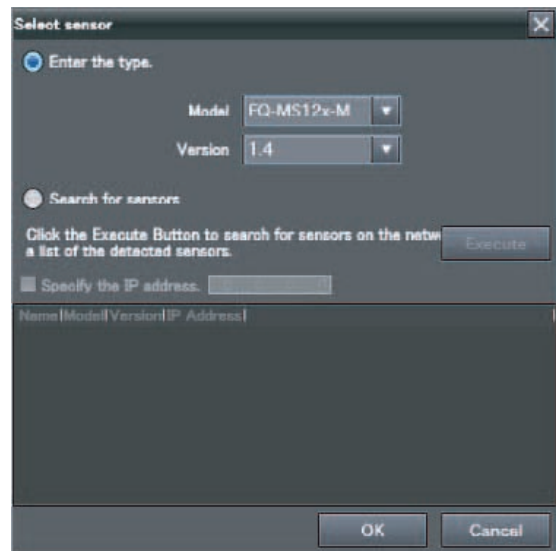

The selected Sensor is added to the Multiview Explorer.

Important

You can register up to eight FQ-M Sensors in one project.

Making an Online Connection to the Sensor to Set

You can transfer Sensor data that was added to the project offline to a network Sensor if you go online with the Sensor.

- 1 Double-click the Sensor model, or right-click the model and select [Edit] from the pop-up menu. The Main Pane is displayed for the Edit Pane.

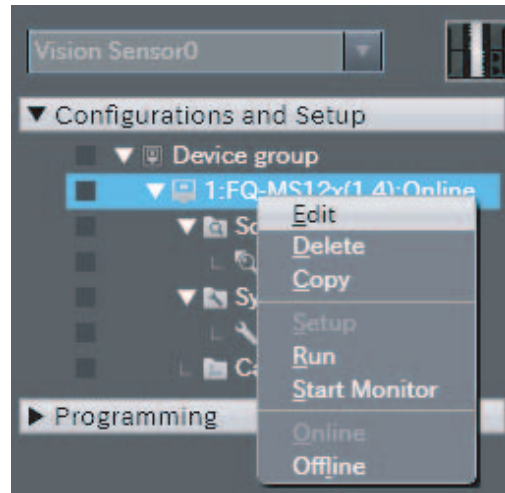

- 2 Click [Online] – [Sensor connection] – [Connect] in the Edit Pane.

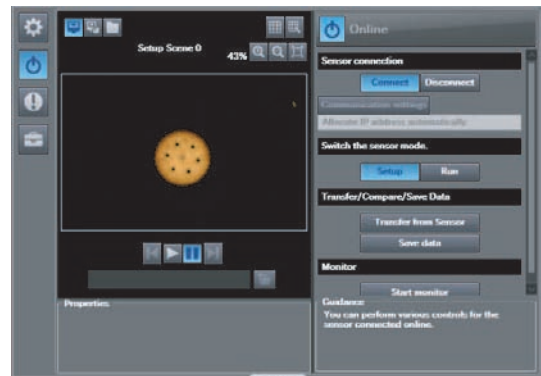

- 3 Click the Sensor you want to connect to.

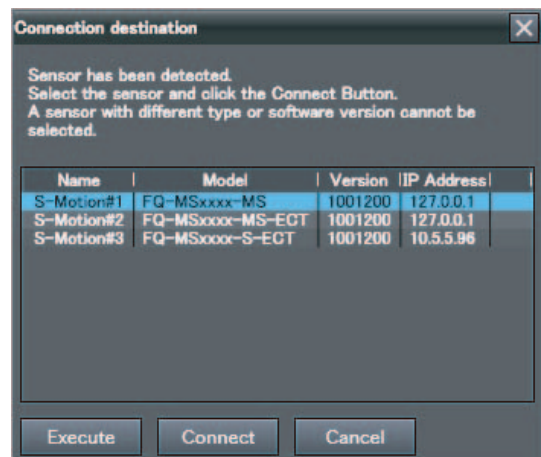

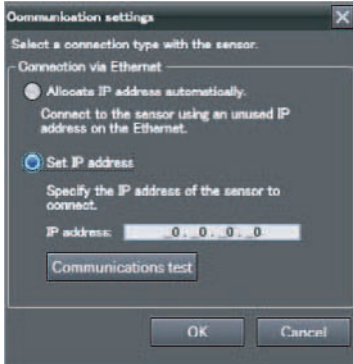

Note

To specify a Sensor with its IP address, click [Communication settings] and select [Set IP address].





Touch Finder

- 1 Press [Run].
This will enable setting the current Sensor into RUN Mode before selecting another Sensor.
- 2 Then press [Switch to Run mode].
- 3 Press [Yes].
- 4 Press  - [Switch Sensor].
- 5 Press the image of the Sensor to be set up.
 will be displayed for Sensors that are not yet set.

Note

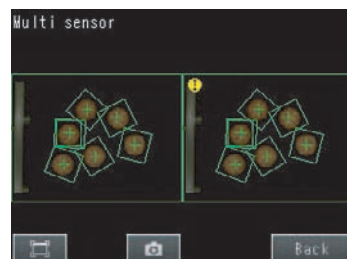
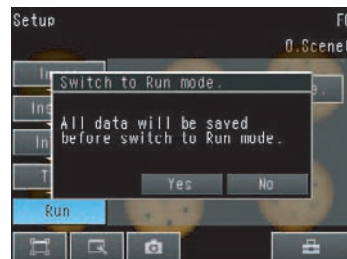
Once the Touch Finder detects and records a Sensor, the display order for showing more than one Sensor is fixed. Even if the system configuration is changed to reduce the number of Sensors, the previous display location will remain for Sensors that were removed. To update displays of multiple Sensors to the current connection status, press [◀] - [Auto connect] on the right of the display in step 5, above, to automatically reconnect.



6 Press  – [Sensor settings] to return to Setup Mode.



7 Press [Yes].

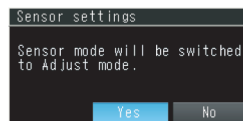

3-2 Adjusting Image Quality

Adjusting the Focus

- ▶ **Multiview Explorer: [Scene] – Scene number**
→ **Edit Pane: [Image] Icon – [Setup menu] – [Mounting status monitor]**

1 Display the Camera Setup Display.

The focus can be seen as a numerical value.
The higher the value, the better the focus.

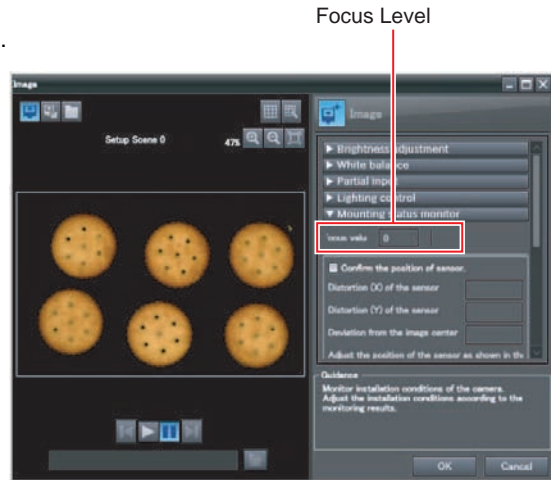

- 2 Click the  (Live) icon to change the display mode to Live Mode.
- 3 Adjust the position so that the measurement object is in the center of the monitor display.
- 4 Adjust the focus of the Lens.

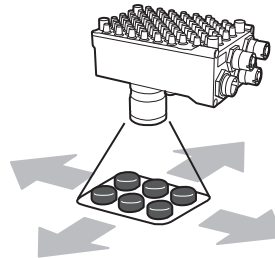

• Operation on the Touch Finder

Use the following menu command to display the Setup Display on the Touch Finder.

- ▶ **[Image] – [Camera setting]**

Adjusting the Sensor Installation

You can use a special pattern for calibration to quantify the installation condition of the Sensor to use as an adjustment scale.

Printing a Calibration Pattern

- ▶ **Multiview Explorer: [Device group] – Sensor name (Double-click)**
→ **Edit Pane: [Support software] Icon**

- 1 Click [The mark for calibration] under [Print].

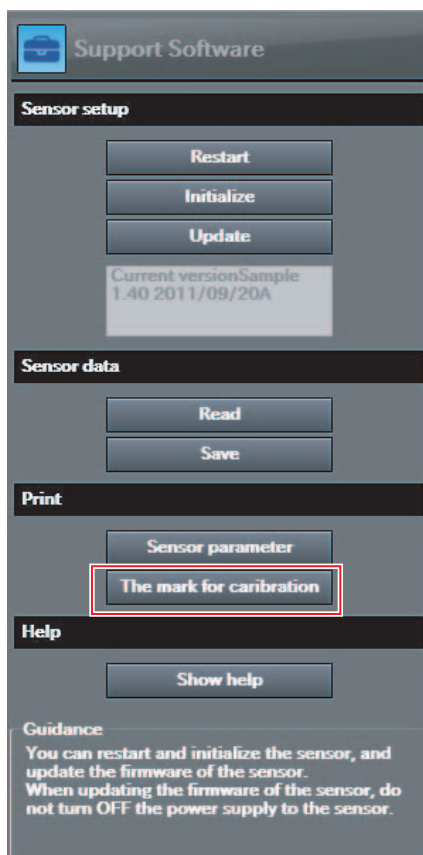

Setting the Camera Position

- **Multiview Explorer: [Scene] – Scene number**
 → Edit Pane:  (Image) Icon – [Setup Menu] – [Mounting status monitor]

- 1** Select the [Confirm the position of sensor] Check Box under [Mounting status monitor].

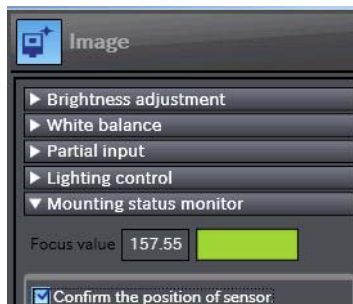

- 2** Align the center of the display with the center of the target mark sheet.

Move the camera position or the position of the target mark sheet so that the point where the dotted blue lines cross (the center of the display) and the red cross (the center of the detected target mark) line up with each other.

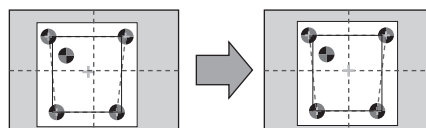

- 3** Adjust the tilt of the camera.

- Adjust the position of the camera in the direction of the arrows shown on the camera icon on the tab page.
- The is completed when the border on the display changes to green.

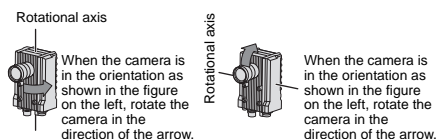

Meanings of Display Items

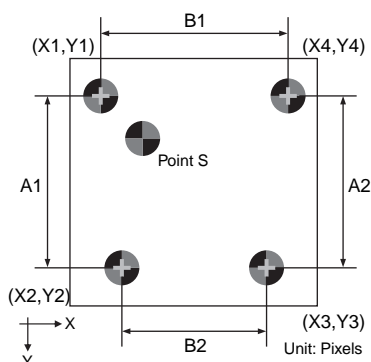

Camera X Distortion

- This value represents the amount of distortion there is along the X axis of the target mark sheet. This is the ratio of A1 to A2.

Camera Y Distortion

- This value represents the amount of distortion there is along the Y axis of the target mark sheet. This is the ratio of B1 to B2.

Target Marks 1 to 4

- These are represented by four points arranged counterclockwise from the closest point to the inner point (point S).
In the above figure, the target marks are as follows:
Target mark 1 (X1,Y1)
Target mark 2 (X2,Y2)
Target mark 3 (X3,Y3)
Target mark 4 (X4,Y4)

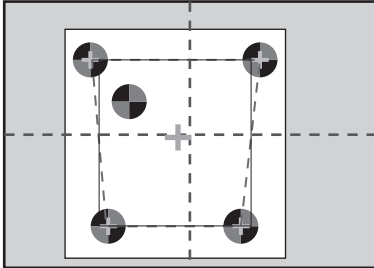

Displacement from the Center of the Display

- This is the Euclidean distance between the intersection of the dotted blue lines (the center of the display) and the green cross (the center of the detected target mark).

Note

This operation is not possible on the Touch Finder.

Displaying Guide Lines to Assist in Sensor Installation

You can display guide lines (scale lines) on top of the image.

- 1 Click the  (Guide Lines) Icon.

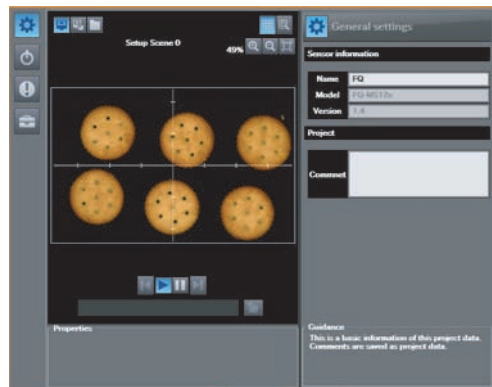

Note

- You can change the drawing conditions for the guide lines.
 Displaying Guide Lines p. 189
- This operation is not possible on the Touch Finder.

Adjusting Image Brightness with External Lighting

You can adjust image brightness with external lighting or by setting the Sensor sensitivity.

Using a Strobe Controller to Control External Lighting

► Multiview Explorer: [Scene] – Scene number

→ Edit Pane:  (Image) Icon – [Setup menu] – [Lighting control]

1 Connect the Strobe Controller to the Sensor.

2 Set the timing to turn ON the external lighting.

Lighting Mode

- Off: Do not turn ON the light.
- Trigger sync: Turn ON the light in sync with the trigger.
- Lighting always: Keeps the light turned ON constantly.

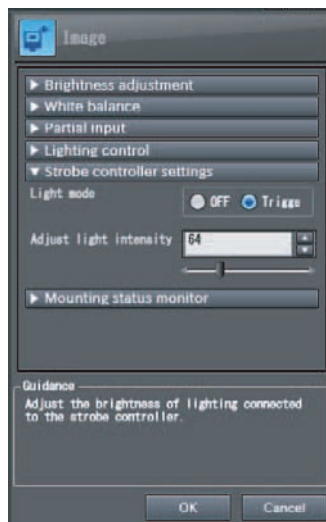

3 Adjust light intensity values to set the image brightness.

• Operation on the Touch Finder

Use the following menu command to display the Setup Display on the Touch Finder.

► [Image] – [Camera Setup] –  – [Lighting control]

Using a Strobe Trigger Signal to Control External Lighting

You can change the output time of the strobe trigger signal to adjust the brightness.

 Changing the STGOUT Signal Output Conditions p. 225

Adjusting the Shutter Speed and Brightness of the Sensor

- ▶ **Multiview Explorer: [Scene] – Scene number**
→ **Edit Pane:**  **(Image) Icon – [Setup menu] – [Brightness adjustment]**

- **Normal Mode**

Adjust the shutter speed settings.

The longer the shutter speed, the brighter the image.

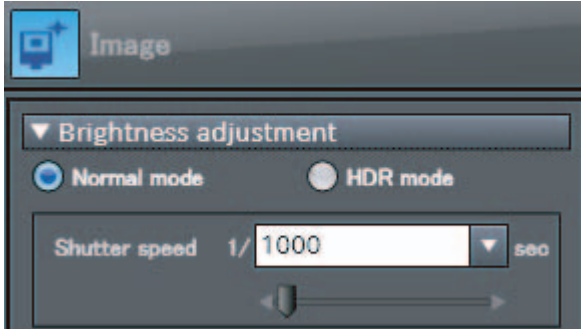

- **HDR Mode**

Set the brightness adjustment value. The higher the brightness adjustment value, the brighter the image.

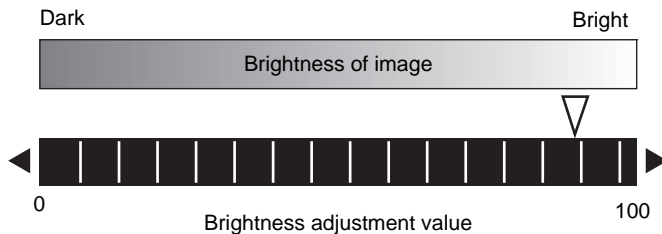

- **Operation on the Touch Finder**

Use one of the following menu commands to display the Setup Display on the Touch Finder.

When HDR Is OFF

- ▶ **[Image] – [Camera setting] –  – [Shutter speed]**

When HDR Is ON

- ▶ **[Image] – [Camera setting] –  – [Brightness]**

Important

- The exposure time will be longer for higher brightness values. This may cause the image to blur if the object is moving fast. If the Sensor is used on a high-speed line, check that the images are not blurred under actual operating conditions.

Taking Clear Images of Moving Objects

For quick moving objects, the effect of blurring can be reduced by decreasing the shutter speed. In HDR Mode, set the brightness value to a low setting.

- **Relationship between Shutter Speed and the Brightness Adjustment Value in HDR Mode**

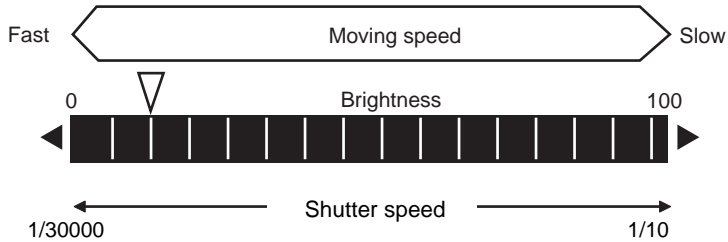

- ▶ **Multiview Explorer: [Scene] – Scene number**
→ **Edit Pane:** (Image) Icon – [Setup menu] – [Brightness adjust]

Adjusting the Shutter Speed and Brightness of the Sensor p. 74

Important

The smaller the value you set for the shutter speed and brightness, the darker the image becomes. If the Sensor is used in a dark environment, make sure that the darkness of the image does not cause the measurements to be unstable.

- **Operation on the Touch Finder**

Use the following menu command to display the Setup Display on the Touch Finder.

- ▶ **[Image] – [Camera setting] – – [Brightness]**

Improving the Image Quality of Metallic and other Shiny Surfaces

When objects with shiny surfaces are being measured, the lighting may be reflected off the surface and affect the image.

To remove reflections, the following function can be used.

Function	Description
HDR (High Dynamic Range)	If objects have contrasting light and dark areas, the dynamic range can be made wider to improve the quality of the images.

HDR Function

The HDR function is used for objects that have a large difference between light and dark areas. For this kind of object, clear images cannot be achieved with the standard brightness setting. The HDR function combines several images of different brightnesses (exposure times) so that the resulting image has a lower degree of contrast and can be measured stably for the desired characteristic.

Inputting Images with a Limit Range of Brightness

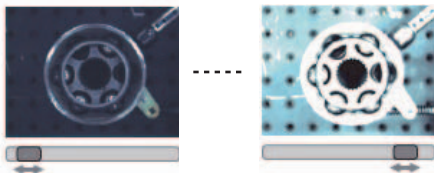

Combining Images to Create an Image with a Wide Dynamic Range

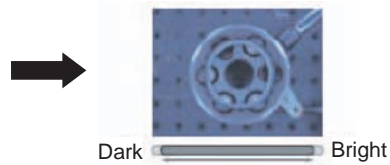

Observe the following precautions.

- Use the HDR function only for objects that are not moving to avoid image blurring. Several images are taken with different shutter speeds and combined. If the object moves while the image is being taken, the image will become blurred.
- Images with different brightnesses are combined, so the resulting image will have a lower degree of contrast.

► Multiview Explorer: [Scene] – Scene number

→ Edit Pane:  (Image) Icon – [Setup menu] – [Brightness adjust]

Adjusting the Colors of the Image (White Balance)

If external lighting is used, the image may appear as having different colors than the actual object. If this is the case, adjust the white balance.

This can be done only when a Sensor with Color Camera is connected.

- ▶ **Multiview Explorer: [Scene] – Scene number**
→ **Edit Pane:**  **(Image) Icon – [Setup menu] – [White balance]**

- 1 Input a picture of white paper or cloth.
- 2 Click the [Auto] Button. The Sensor will automatically adjust the colors.
- 3 Move the bar to the left (light) or right (dark) to finetune the colors.
- 4 Click the [OK] Button.



• Operation on the Touch Finder

Use the following menu command to display the Setup Display on the Touch Finder.

- ▶ **[Image] – [Camera setup] –  – [White balance]**

3-3 Synchronizing the Measurement Object Image Capture Timing

Setting the Measurement Trigger

Select the type of trigger input to use to capture an image of the measurement object. You can select from three different types of input triggers, based on the configuration of the system connected to the Sensor.

- TRIG: One inspection is performed in sync with an external trigger.
- EtherCAT trigger: One inspection is performed when a command to measure is received via EtherCAT.
- Encoder trigger: One inspection is performed based on the encoder input value.

► **Multiview Explorer: [System] – [System data]**
→ **Edit Pane:**  **(Trigger settings) Icon – [Trigger type]**

1 Select the trigger type.

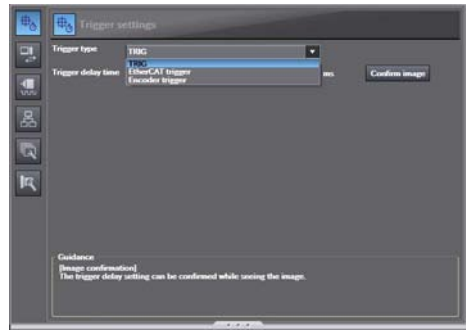

Item	Description
TRIG	An external trigger is used to perform measurements.
EtherCAT trigger	A measurement command received via EtherCAT is used to perform measurements.
Encoder trigger	An encoder counter value is used to perform measurements.

Delaying the Image Capture Timing from the Trigger Input

If objects are moving, the position in the image of the characteristic that is to be measured will vary according to the timing of the trigger signal. A delay can be applied from when the trigger (the TRIG signal) is input until when the image is input, to synchronize the timing of image input with the speed of the moving objects. If the object position varies in the image, this function cannot be used to make the object position more stable. When you use a trigger delay, you will also need to adjust the timing to turn ON external lighting.

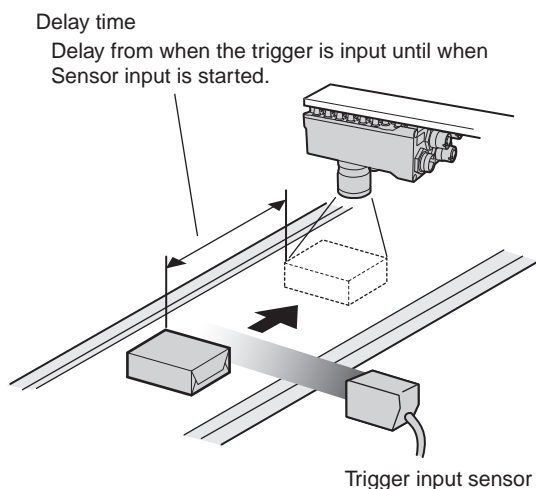

► Multiview Explorer: [System] – [System data]



→ Edit Pane:  (Trigger settings) Icon

- 1 Set a suitable value for the trigger delay time.

You can also adjust the trigger delay while monitoring the image.

► Multiview Explorer: [System] – [System data]

→ Edit Pane:  (Trigger settings) Icon – [Confirm image]

- 1 Input a TRIG signal.
Images are input continuously.
- 2 Display the image with the measurement object in the center using  and  Buttons.
- 3 Select the image.
- 4 Click the [OK] Button.

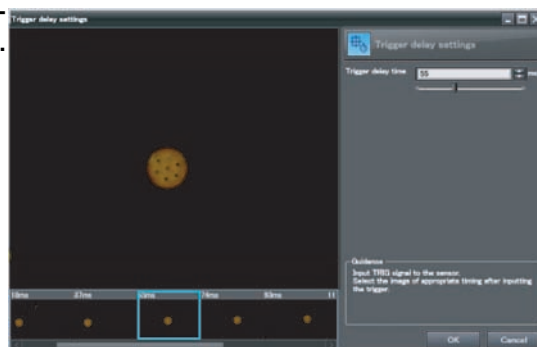

Note

The delay time can be set using the adjustment bar or by directly entering a value.

- **Operation on the Touch Finder**

Use the following menu command to display the Setup Display on the Touch Finder.

▶ **[Image] – [Trigger setup] – ▶ – [Trigger delay]**

Note

When you use a trigger delay, you will also need to adjust the timing to turn ON external lighting so that it matches the trigger delay timing.



Adjusting External Lighting Timing p. 81

Adjusting External Lighting Timing

When you use a trigger delay, you must adjust the timing to turn ON external lighting so that it matches the trigger delay timing.

Using a Strobe Controller to Control External Lighting

If a Strobe Controller is used and the lighting mode is set to [Triggered synchronization], it is not necessary to set any lighting controls to match the lighting to the trigger delay timing.

Using a Strobe Trigger Signal to Control External Lighting

Delay the output time of the strobe trigger signal to adjust the external lighting timing.



Changing the STGOUT Signal Output Conditions p. 225

- **Operation on the Touch Finder**

Use the following menu command to display the Setup Display on the Touch Finder.

▶ **[Image] – [Camera setup] – [Lighting control]**

3-4 Preventing Mutual Interference of Multiple Sensors

When the same trigger signal is input to multiple Sensors, the lighting from one Sensor may affect the measurements of the other Sensors. This is called mutual interference. This kind of interference can be prevented offsetting the image input timing of each Sensor from when the trigger signal is received.

Example:

A trigger (i.e., the TRIG signal) is input to Sensor 0 and Sensor 1 at the same time.

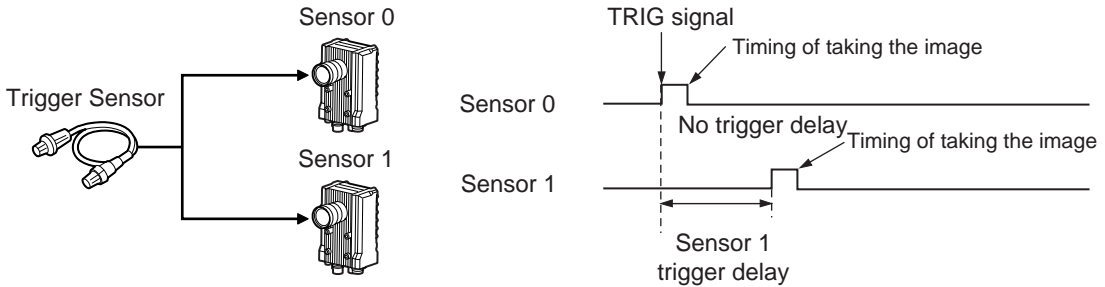

Sensor 0 immediately begins image input when the trigger is input.
Sensor 1 begins image input after the specified time has passed.

1 Change to the setup for to Sensor 1.

 p. 64

2 Multiview Explorer: [System] – [System data]

→ Edit Pane:  (Trigger settings) Icon

3 Set the trigger input delay time for Sensor 1.

 p. 80

4 Adjust the external lighting timing to match the trigger delay.

 p. 81

Important

- The delay time for preventing mutual interference must be longer than the shutter time.

• Operation on the Touch Finder

Use the following menu command to display the Setup Display on the Touch Finder.





▶ [Image] – [Trigger setup] –  – [Trigger delay]

Setting Up Inspections

4-1 Inspection Item Selection Guide	84
4-2 Setup Procedure for Inspection Items	85
4-3 Registering Inspection Items	86
4-4 Inspecting with the Search Inspection Item	88
4-5 Inspecting with the Edge Position Inspection Item	105
4-6 Inspecting with the Labeling Inspection Item	113
4-7 Inspecting with the Shape Search Inspection Item	125
4-8 Calculations and Judgements Using Inspection Item Data	138

4-1 Inspection Item Selection Guide

The Vision Sensor uses inspection items to judge measurement objects and perform position detection. There are four different inspection items. Select the inspection items to use according to the features of the measurement object and the required results (OK/NG judgement, position detection, etc.)

Inspection	Example	Inspection item used	Reference
Detecting positions with shapes at high speed	Measurement objects of the same shape can be detected. 	Shape Search	p. 125
Detecting positions with patterns	Measurement objects of the same color and pattern can be detected. 	Search	p. 88
Detecting positions by edges	The positions of the edges of glass surfaces can be detected. 	Edge Position	p. 105
Detecting positions with groups	Groups of the same color can be detected. 	Labeling	p. 113

4-2 Setup Procedure for Inspection Items

The basic steps for setting up inspection items are given below.

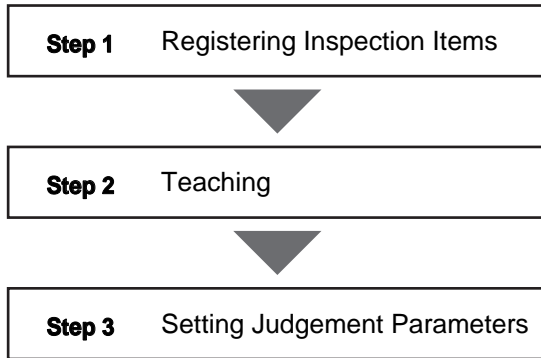

If measurements are unstable:

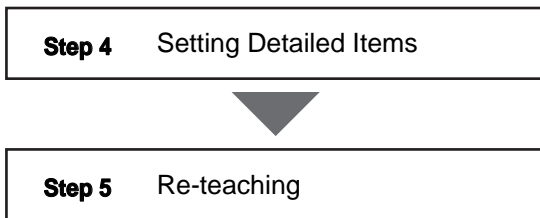

4-3 Registering Inspection Items

Registering New Inspection Items

► Multiview Explorer: [Scene] – Scene number (Double-click) or (right-click [Edit])

- 1 Click the  (Inspection) Icon.
- 2 Drag the inspection item you want to register from the [Available inspection items] area in the Toolbox to the inspection item list.

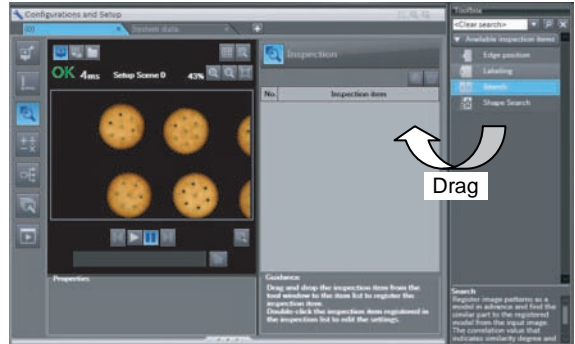

• Operation on the Touch Finder



Use the following menu command to display the Setup Display on the Touch Finder.

► [Inspect] – [Inspection] – Unregistered item number – [Add item]

Modifying Registered Inspection Items

► Multiview Explorer: [Scene] – Scene number (Double-click) or (right-click [Edit])

- 1 Click the  (Inspection) Icon.
- 2 Right-click the inspection item to set up and select [Edit]. The Edit Pane is displayed.



No.	Inspection item
0	 Search
1	 Search

• Operation on the Touch Finder

Use the following menu command to display the Setup Display on the Touch Finder.



► [Inspect] – [Inspection] – Registered item number – [Modify]

Copying Registered Inspection Items

- ▶ **Multiview Explorer: [Scene] – Scene number (Double-click) or (right-click [Edit])**
 - 1 Click the  (Inspection) Icon.
 - 2 Click the inspection item to copy.
 - 3 Right-click and select [Copy], or click the  (Copy) Icon.

When you make a copy of an inspection item, the copy is inserted at the end of the inspection item list.

Deleting Registered Inspection Items

- ▶ **Multiview Explorer: [Scene] – Scene number (Double-click) or (right-click [Edit])**
 - 1 Click the  (Inspection) Icon.
 - 2 Click the inspection item to delete.
 - 3 Right-click and select [Delete], or click the  (Delete) Icon.

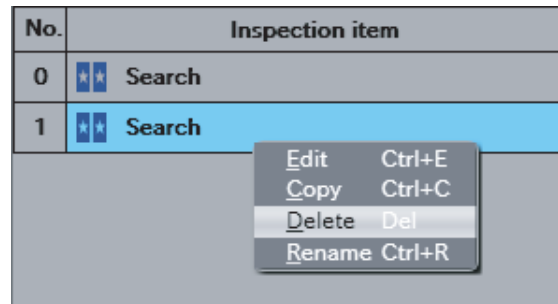

• Operation on the Touch Finder

Use the following menu command to display the Setup Display on the Touch Finder.

- ▶ **[Inspect] – [Inspection] – Registered item number – [Delete]**

Changing the Name of Registered Inspection Items

- ▶ **Multiview Explorer: [Scene] – Scene number (Double-click) or (right-click [Edit])**
 - 1 Click the  (Inspection) Icon.
 - 2 Click the inspection item for which to change the name.
 - 3 Right-click and select [Rename].
 - 4 Enter the new name.
 - 5 Press the [ENTER] key to confirm the new name.

4-4 Inspecting with the Search Inspection Item

Search Inspection Item

The image pattern to use for measurements is registered in advance and measurements are performed to see if the pattern is present, to find the position of the pattern, or to see if characteristics, such as the shape or color, are different. The image pattern that is registered in advance is called the model. The degree to which the image matches the model is called the correlation.

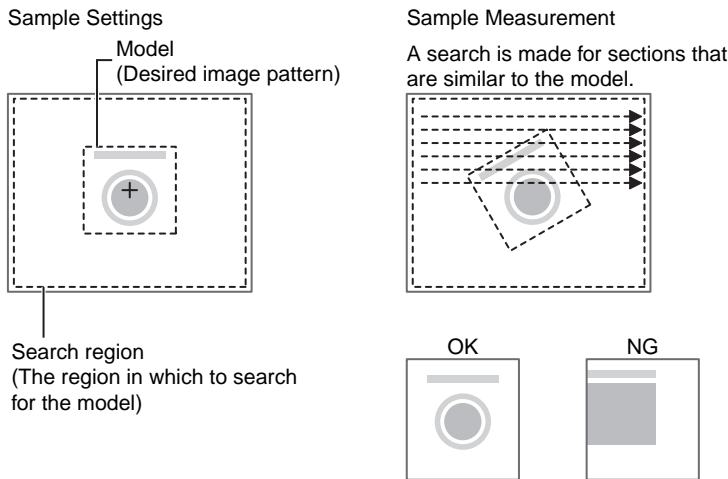

Setup Procedure for Search Inspection Item

Step 1 Selecting the Inspection Item

- ▶ **Multiview Explorer: [Scene] – Scene number**
→ **Edit Pane:**  (Inspection) Icon

- 1 Drag [Search] from the [Available inspection items] area to the inspection item list.
- 2 Right-click the [Search] inspection item you added to the inspection item list and select [Edit].

 Registering Inspection Items p.86

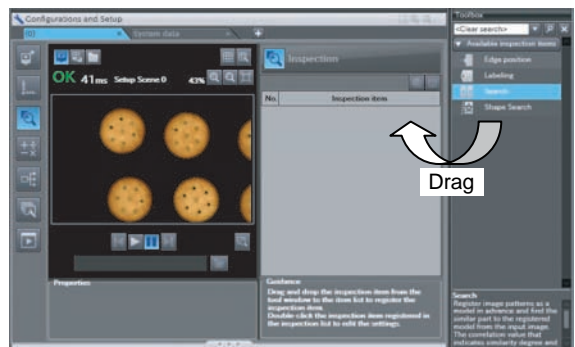

• **Operation on the Touch Finder**

Use the following menu command to display the Setup Display on the Touch Finder.

- ▶ **[Inspect] – [Inspection]**

Step 2 Teaching

Teaching means to store the region and image as reference data for the measurement.

- ▶ **Multiview Explorer: [Scene] – Scene number**
 - **Edit Pane:**  **(Inspection) Icon – [Search] (right-click [Edit])**
 - **Search Pane:** **[Model region] – [Edit]**

1 Place the object that is to be used as the measurement reference in front of the Camera.

2 Move the rectangle to the location to be measured.

3 Click [TEACH].
The basic settings will be registered when teaching has been completed.

Drag the rectangle to move it. Drag a corner to size the rectangle.

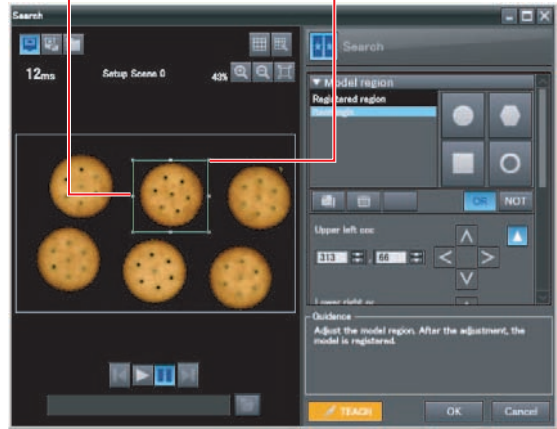

The following data is stored as the measurement reference.

Item	Parameter	Description
Reference data	Model image	This is the image in the model region that is stored as the reference.
	Reference position X	These are the coordinates of the model image that are stored as the reference.
	Reference position Y	

Note

- You can edit the region to use for teaching.
 -  Editing the Model Region p. 99
- The Teaching Button will flash if the conditions for model registration change.
When the Teaching Button flashes, click the Teaching Button again to register the model.

• **Operation on the Touch Finder**

Use the following menu command to display the Setup Display on the Touch Finder.

- ▶ **[Inspect] – [Inspection] – [Search] – [Modify] – [Settings] Tab Page – [Teach] –  – [Model region]**

Step 3 Adjusting the Judgement Parameters

- ▶ **Multiview Explorer: [Scene] – Scene number**
 - **Edit Pane:**  (Inspection) Icon – [Search] (right-click [Edit])
 - **Search Pane:** [Judgment parameters]

1 Set the ranges that are to be judged as OK for the following parameters.

Continuous measurements will be performed for the images that are taken. The measured value is displayed beside the setting name.

2 Click [OK] at the lower right of the Edit Pane.

Click the [OK] Button to apply all edited settings. Click the [Cancel] Button to cancel all changes.

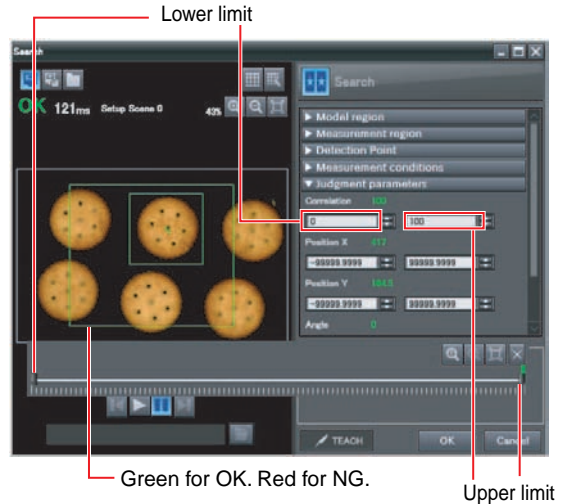

Parameter	Setting	Description
Correlation	Range: 0 to 100 Defaults: Lower limit: 0, Upper limit: 100	Adjust the upper and lower limits of the correlation for an OK judgement.
Position X	Range: -99,999.9999 to 99,999.9999 Defaults: Lower limit: -99,999.9999, Upper limit: 99,999.9999	Adjust the upper and lower limits of measurement position X for an OK judgement.
Position Y	Range: -99,999.9999 to 99,999.9999 Defaults: Lower limit: -99,999.9999, Upper limit: 99,999.9999	Adjust the upper and lower limits of measurement position Y for an OK judgement.
Measure angle	Range: -180 to 180 Defaults: Lower limit: -180, Upper limit: 180	Adjust the upper and lower limits of measurement angle for an OK judgement.
Count	Range: 0 to 32 Defaults: Lower limit: 0, Upper limit: 32	Adjust the upper and lower limits of the detection count for an OK judgement.

Note

If you enabled the output of multiple results, you can specify the results to display with their detection number.

• Operation on the Touch Finder

Use the following menu command to display the Setup Display on the Touch Finder.

- ▶ **[Inspect] – [Inspection] – [Search] – [Modify] – [Settings] Tab Page – [Judgement]**

Changing Output Coordinate Positions

You can specify which part of the model to detect as coordinates during inspections. Normally, the center position of the registered model is used as the detection point.

- ▶ **Multiview Explorer: [Scene] – Scene number**
 - **Edit Pane:**  (Inspection) Icon – [Search] (right-click [Edit])
 - **Search Pane:** [Detection Point]

1 Move the cross cursor to any position.

The position of the cross cursor will be the coordinate position that is output. This position is registered relative to the model region. You can also enter a value directly.

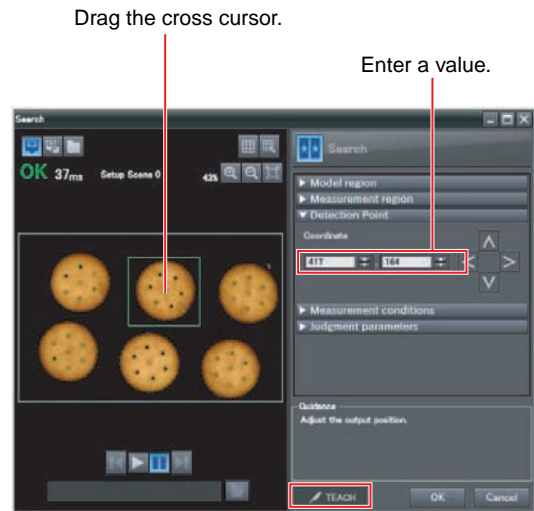

Note

The detection coordinates will automatically return to the center coordinates of the model if you change the model region.

• Operation on the Touch Finder

Use the following menu command to display the Setup Display on the Touch Finder.

- ▶ **[Inspect] – [Inspection] – [Search] – [Modify] – [Settings] Tab Page – [Teach] –  – [Detection point]**

Increasing Measurement Position Accuracy

You can increase the accuracy of measurement positioning.

You can calculate down to four decimal places.

- ▶ **Multiview Explorer: [Scene] – Scene number**
 - **Edit Pane:**  **(Inspection) Icon – [Search] (right-click [Edit])**
 - **Search Dialog Box: [Measurement conditions]**

1 Select the [Sub-pixel] Check Box.

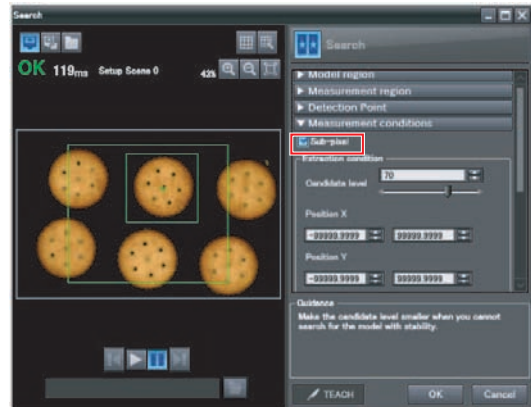

• Operation on the Touch Finder

Use the following menu command to display the Setup Display on the Touch Finder.

- ▶ **[Inspect] – [Inspection] – [Search] – [Modify] – [Details] Tab Page – [Meas. Parameter]**

Obtaining Multiple Results Simultaneously

You can detect all items that satisfy the extraction conditions.

Judgement is performed for all detected results.

You can also change the output order when you output the results.

- ▶ **Multiview Explorer: [Scene] – Scene number**
 - **Edit Pane:**  (**Inspection**) Icon – [**Search**] (right-click [**Edit**])
 - **Search Dialog Box:** [**Measurement conditions**]

- 1** Select the [**Multi-point output**] Check Box.
- 2** Select the conditions by which to sort the detected results under [**Sorting method**].
You can output the results in the sort order that you selected.
- 3** Set the [**Count**].
This allows you to set the maximum number of results to output.



Selection item	Setting	Description
Sorting method	Ascending order of correlation value	Sorts the results in order from the smallest correlation to the largest.
	Descending order of correlation value	Sorts the results in order from the largest correlation to the smallest.
	Ascending order of position X	Sorts the results in order from the smallest measurement X position to the largest.
	Descending order of position X	Sorts the results in order from the largest measurement X position to the smallest.
	Ascending order of position Y	Sorts the results in order from the smallest measurement Y position to the largest.
	Descending order of position Y	Sorts the results in order from the largest measurement Y position to the smallest.
Count	1 to 32	Sets the upper limit for the number of items to detect as a single set of search results.

• Operation on the Touch Finder

Use the following menu command to display the Setup Display on the Touch Finder.

- ▶ [**Inspect**] – [**Inspection**] – [**Search**] – [**Modify**] – [**Details**] Tab Page – [**Meas. Parameter**]

Select the Results to Output

You can use multiple conditions to determine which results to output from all the objects detected with a correlation at the candidate level or higher.

Only the results that meet all the specified conditions are output.

- ▶ **Multiview Explorer: [Scene] – Scene number**
 - **Edit Pane:**  (Inspection) Icon – [Search] (right-click [Edit])
 - **Search Dialog Box:** [Measurement conditions]

- 1 Adjust the [Candidate level] under [Extraction condition] so that only objects higher than a certain correlation are detected.
- 2 Set the measurement range (position X, position Y) and the measure angle.

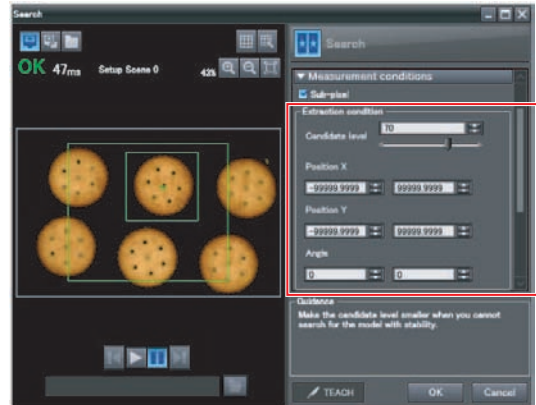

Extraction condition	Range	Description
Candidate level	0 to 100	Outputs only objects with a correlation that is higher than the specified candidate level.
Position X	-99999.9999 to 99999.9999	Outputs only objects with an X measurement position that is within this range.
Position Y	-99999.9999 to 99999.9999	Outputs only objects with an Y measurement position that is within this range.
Measure angle	-180 to 180	Outputs only objects with a measurement angle that is within this range.

• Operation on the Touch Finder

Use the following menu command to display the Setup Display on the Touch Finder.

- ▶ **[Inspect] – [Inspection] – [Search] – [Modify] – [Details] Tab Page – [Meas. Parameter]**

Note

The processing time changes if you change the candidate level.

Using the Encoder Input to Exclude Redundant Search Results

When you detect workpieces as they travel along a conveyor belt, you can use an encoder input to exclude the results detected for the previous inspection. To use this function, an encoder input to the Sensor and conveyor tracking calibration are required.

Refer to Section 9 Calibration for how to perform the conveyor tracking calibration.

 9-1 Calibration p. 346

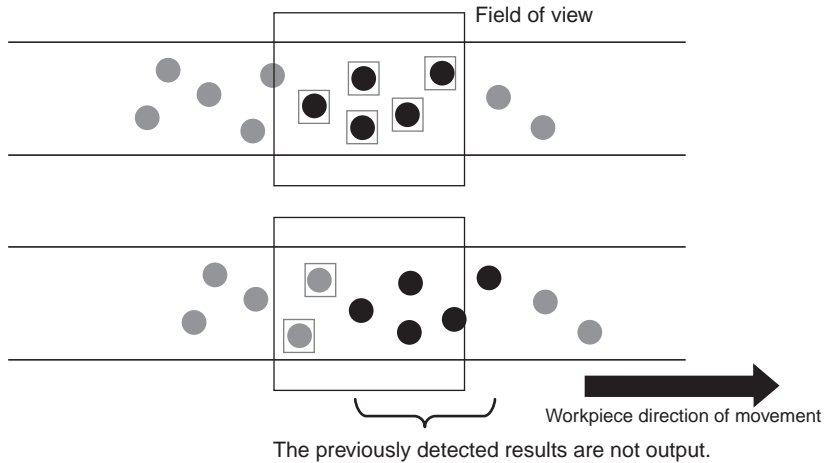

Important

When using this function, continuously input the trigger at a short interval. The intended detection results may not be achieved if the trigger interval is too long.

Input the next trigger before the measurement objects leave the field of view of the camera.

- When using an encoder trigger, adjust the trigger counter timing (p. 341).
- When using the TRIG parallel I/O signal (p. 215), an EtherCAT trigger (p. 241), the MEASURE no-protocol command (p. 283), or a single measurement PLC link command (p. 310), program the external device to create a short measurement trigger interval.

► Multiview Explorer: [Scene] – Scene number

→ Edit Pane:  (Inspection) Icon – [Search] (right-click [Edit])

→ Search Dialog Box: [Measurement conditions]

1 Select the [Remove duplication] Check Box.

2 Adjust the [Judgement distance] based on the size of the detection object.

Set the numerical values after calibration (i.e., the values in the robot coordinate system). The unit will be the setting unit that was used for calibration.



Note

You cannot set the judgement distance from the Touch Finder.

Using the Grip Interference Check Function to Exclude the Search Results of Workpieces That Are Not Able to Grip

When you detect workpiece, you can use the grip interference check function to exclude results from workpieces that are not able to grip.

- 1 Specify the necessary grip region aside from the model region, and register the color to be measured and area to be determined from the workpieces and the background colors within the specified region.

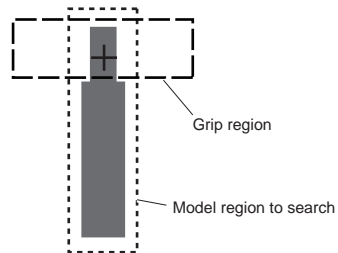

- 2 Complete measurement within the grip region of the detected workpiece using the area of the color registered in step 1 to determine whether gripping is possible or not by relative value to reference area value (the %).

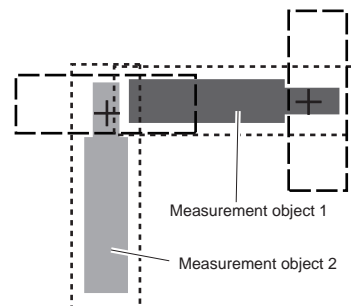

- 3 Only the search results for workpieces that have been determined as being able to grip with gripping areas at or above the grip area level are output.

- ▶ **Multiview Explorer: [Scene] – Scene number**
 - Edit Pane: (Inspection) Icon – [Search] (right-click [Edit])
 - Search Dialog Box: [Measurement conditions]

- 1 Select the [Grip interference check] Check Box. The [Grip region] and [Set color] are displayed under [Judgment parameters].

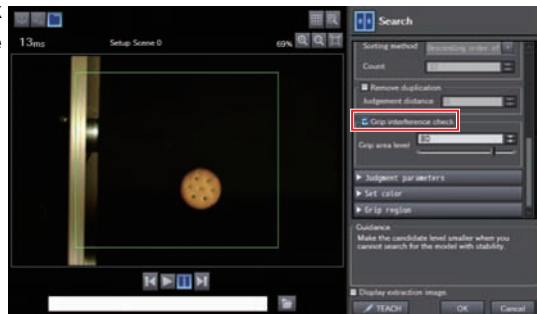

2 Set the region necessary for gripping.

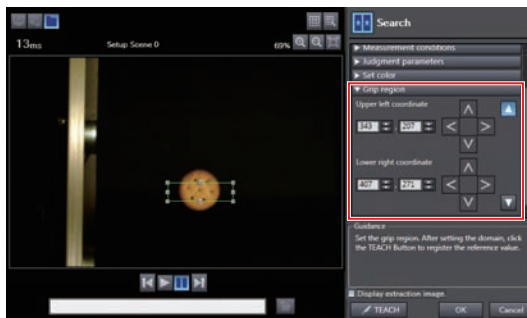

3 Specify the color of the workpiece in the gripping region and use it to teach the basic color area of the specified color. Refer to the below for instructions on how to specify the set color.

p. 114

4 Set the [Grip area level].

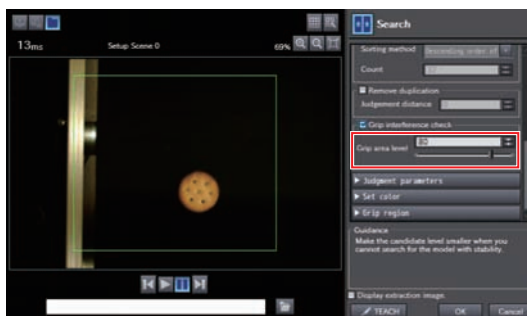

Selection item	Setting	Description
Grip area level	Range: 0 to 100 Default: 80	Set the threshold value for the grip interference check by area. Threshold value is relative value to reference area value (the %). Increase the grip area level if any workpieces that are unable to grip are detected.

Note

The grip interference check function cannot be set from the Touch Finder.

Handling the Tilt of a Search Object

Adjust the [Angle range] parameter to increase the range in which a search is made for the model. The Search inspection item judges whether an image is OK or NG according to the correlation with a previously registered image pattern. For this reason, if the object is at an angle, the correlation is reduced and the image may be judged as NG. To achieve an OK judgement for the same image pattern even when the object is at an angle, the rotation range must be widened.

- ▶ **Multiview Explorer: [Scene] – Scene number**
 - **Edit Pane:**  (Inspection) Icon – [Search] (right-click [Edit])
 - **Search Dialog Box:** [Model region] – [Rotation]

Parameter	Setting	Description
Rotation range	-180° to 180°	A search is performed within the set angle range. The larger the angle range, the longer the processing time. Important If you change the angle range, perform teaching again.  p. 89

- **Operation on the Touch Finder**

Use the following menu command to display the Setup Display on the Touch Finder.

- ▶ **[Inspect] – [Inspection] – [Search] – [Modify] – [Details] Tab Page – [Model parameter]**

Stabilizing Search Results

Correlation Is Inconsistent Due to Low Contrast

Adjust the brightness to improve the contrast of the mark.

 Adjusting Brightness p. 73

Correlation Is Inconsistent Due to Variations in the Measurement Object

Inconsistent portions can be masked so that they are omitted from matching.

 Masking Parts of the Model p.101

Increasing the Processing Speed

The following two methods can be used to reduce processing time.

- **Reduce the range in which a search is performed for the model.**

 Changing the measurement region p. 102

- **Reduce the angle range setting.**

Adjust the [Angle range] parameter to reduce the range in which a search for the model is performed.

 Setting the angle range p. 98

Editing the Model Region

This section describes how to edit the model regions.

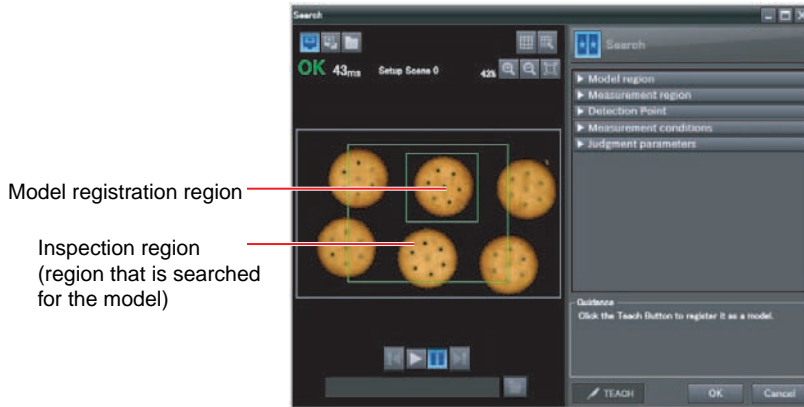

Important

If the model region is changed, perform teaching again.

 p. 89

Changing the Model Registration Region to a Shape Other Than a Rectangle

One rectangular region is registered as the default model registration region.

Other than rectangles, ellipses and polygons can be set as the model registration regions.

► Multiview Explorer: [Scene] – Scene number

→ Edit Pane:  (Inspection) Icon – [Search] (right-click [Edit])

→ Search Dialog Box: [Model region] – [Edit]

1 Click [Edit].

2 Click [Rectangle] in the registered region list.

When you select a shape it is added to the list.

3 Click  (Delete).

The rectangle will be deleted.

4 Select the shape of the region you want to draw from the shape icons.

You can select from the following four shapes.

- Rectangle
- Ellipse
- Circumference
- Polygon

5 Draw the region on the image.

6 Click the [TEACH] Button.

7 Click [OK].



Note

- Up to 8 shapes can be combined to create a region for one model.
- If you want to adjust the position of a model region by individual pixels, enter the coordinate values for the model region directly.

• Operation on the Touch Finder

Use the following menu command to display the Setup Display on the Touch Finder.

► [Inspect] – [Inspection] – [Search] – [Inspection] – [Settings] Tab Page – [Teach] –  – [Model region]

Ellipse

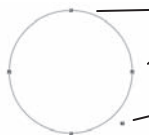

Enlarges or shrinks the circle in the vertical or horizontal direction.

Enlarges or shrinks the circle with the same horizontal to vertical ratio.

Rectangle

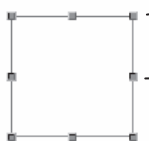

Enlarges or shrinks the rectangle from the corner.

Enlarges or shrinks the rectangle horizontally or vertically.

Polygon



Enlarges or shrinks the polygon from the corner. You can also click anywhere on the lines to add a new vertex.

Circumference



Enlarges or shrinks the outer circle in the vertical or horizontal direction.

Enlarges or shrinks the inner circle in the vertical or horizontal direction.

Masking Parts of the Model

The model registration region can be formed freely by combining enabled and disabled regions.

Example:

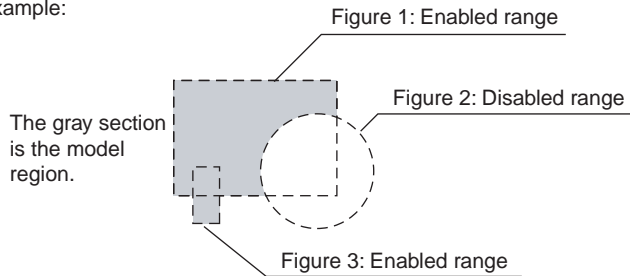

- ▶ **Multiview Explorer: [Scene] – Scene number**
 - **Edit Pane:** (Inspection) Icon – [Search] (right-click [Edit])
 - **Search Dialog Box:** [Model region] – [Edit]

- 1 Draw the figure according to the section that you want to mask.

p. 100

- 2 **Select the region to mask, then click [NOT].**
The selected area will be removed from the model.

OR: Enabled range
NOT: Disabled range

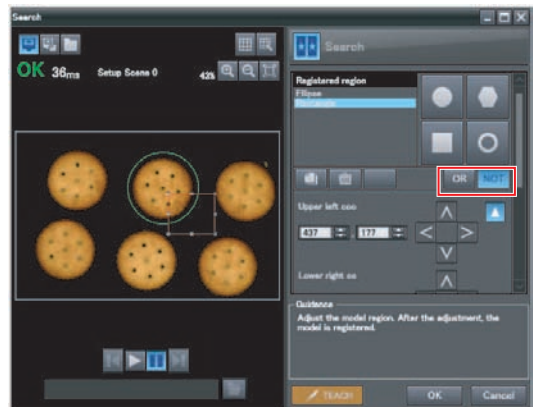

• Operation on the Touch Finder

Use the following menu command to display the Setup Display on the Touch Finder.

- ▶ **[Inspect] – [Inspection] – [Search] – [Modify] – [Settings] Tab Page – [Teach] – – [Model region]**

Changing the Measurement Region

The region within which the model is searched can be changed.

- ▶ **Multiview Explorer: [Scene] – Scene number**
 - **Edit Pane:**  (**Inspection**) Icon – [**Search**] (right-click [**Edit**])
 - **Search Dialog Box:** [**Measurement region**]

1 Adjust the size and position of the measurement region.

- **Change the size.**
Click one of the four corner points to select it.
The processing time can be shortened by making the region smaller
Specify the upper left or lower right coordinates directly, or use the directional keys to adjust the size.
- **Change the position.**
Drag the figure to move it.
Specify the center coordinates directly, or use the directional keys to adjust the size.



2 Click [OK].

• Operation on the Touch Finder

Use the following menu command to display the Setup Display on the Touch Finder.

- ▶ [**Inspect**] – [**Inspection**] – [**Search**] – [**Modify**] – [**Settings**] Tab Page – [**Teach**] –  – [**Insp. region**]

Measurement Data That Can Be Used for External Outputs and Calculations

The following values can be used as measurement data and output to external devices used in calculations.

Expression text string	Data name	Description	Data range
JG	Judgement	This is the judgement results of the search.	-2: No judgement (not measured), 0: Judgement is OK, -1: Judgement is NG, -13: Teaching not performed error, -14: Figure not registered error, -15: Out of range error
C	Count	This is the number of models found.	0 to 32
CR[0] to CR[31]	Correlation	This is the correlation of the Nth model that was found.	0 to 100
X[0] to X[31]	Position X	This is the X coordinate where the Nth model was found.	-99999.9999 to 99999.9999
Y[0] to Y[31]	Position Y	This is the Y coordinate where the Nth model was found.	-99999.9999 to 99999.9999
TH[0] to TH[31]	Measure angle	This is the angle in which the Nth model was found.	-180 to 180
SX	Reference X	This is the X coordinate of the position where the model was registered. (This is the center of the model region.)	-99999.9999 to 99999.9999
SY	Reference Y	This is the Y coordinate of the position where the model was registered. (This is the center of the model region.)	-99999.9999 to 99999.9999
ST	Reference angle	This is the angle when the model was registered.	-180 to 180
RX	Detection point coordinate X	This is the X coordinate of the detection point when the model was registered.	-99999.9999 to 99999.9999
RY	Detection point coordinate Y	This is the Y coordinate of the detection point when the model was registered.	-99999.9999 to 99999.9999

 4-8 Calculations and Judgements Using Inspection Item Data p. 138

Measurement Data That Can Be Logged

You can select to log any of the following values.

Parameter	Range	Description
Judgement	0: Judgement is OK -1: Judgement is NG -13: Teaching not performed error -14: Figure not registered error -15: Out of range error	This is the measurement judgement results.
Count	0 to 32	This is the number of models found.
Correlation	0 to 100	This is the measured correlation.
Position X	-99999.999 to 99999.999	This is the measurement position X.
Position Y	-99999.999 to 99999.999	This is the measurement position Y.
Measure angle	-180 to 180	This is the measurement angle.

* When logging data is output, the data is output in the order of the above table.
If more than one item is stored, results are output for each model.

 7-3 Logging Measurement Data and Image Data p. 191

Errors

Errors in Teaching

A teaching error message will appear if the contrast of the image within the model registration region is too low. Select a region with a larger contrast between light and dark areas compared to the region that was registered as the model and re-register it as the model.

4-5 Inspecting with the Edge Position Inspection Item

Edge Position

Places where the color changes greatly are called edges. The positions of these edges are measured. For example, Edge Position can be used to see if a label is attached at the correct position or if a component is set in the correct position.

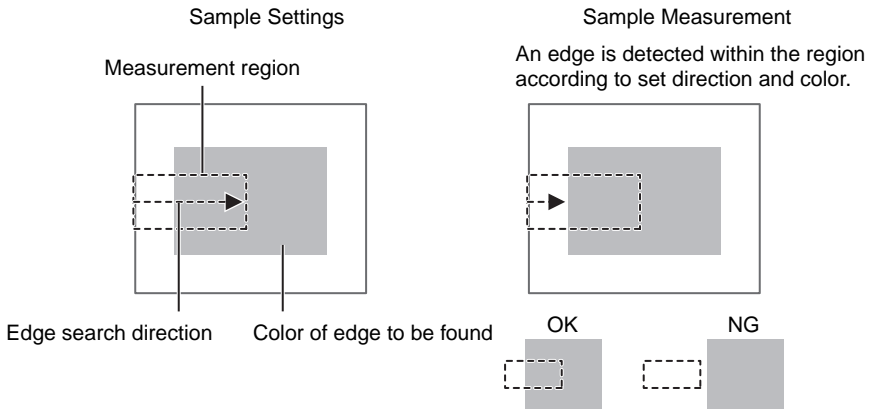

Setup Procedure for Edge Position Inspection Item

Step 1 Selecting the Inspection Item

- ▶ **Multiview Explorer: [Scene] – Scene number**
→ **Edit Pane:** (Inspection) Icon

- 1 Drag [Edge Position] from the [Available inspection items] area to the inspection item list.
- 2 Right-click the [Edge Position] inspection item you added to the inspection item list and select [Edit].

Registering Inspection Items p. 86

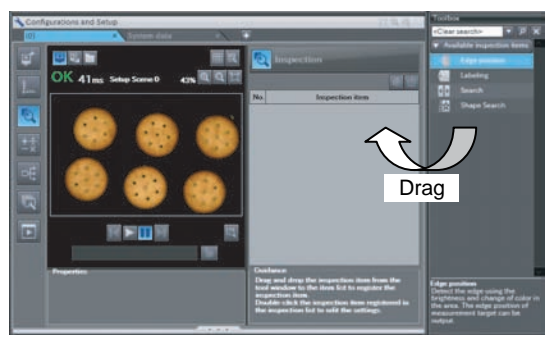

• Operation on the Touch Finder

Use the following menu command to display the Setup Display on the Touch Finder.

- ▶ **[Inspect] – [Inspection]**

Step 2 Teaching

Teaching means to store the region and the edge position in the region as reference data for the measurement.

► **Multiview Explorer: [Scene] – Scene number**

- **Edit Pane:**  (Inspection) Icon – [Edge Position] (right-click [Edit])
- **Edge Position Pane:** [Measurement region]

- 1** Place the object that is to be used as the measurement reference in front of the Camera.
- 2** Move the rectangle to the location to be measured.
- 3** Click the [TEACH] Button in the lower-right corner.
The basic settings will be registered when teaching has been completed.

 Changing the Measurement Region
p. 102

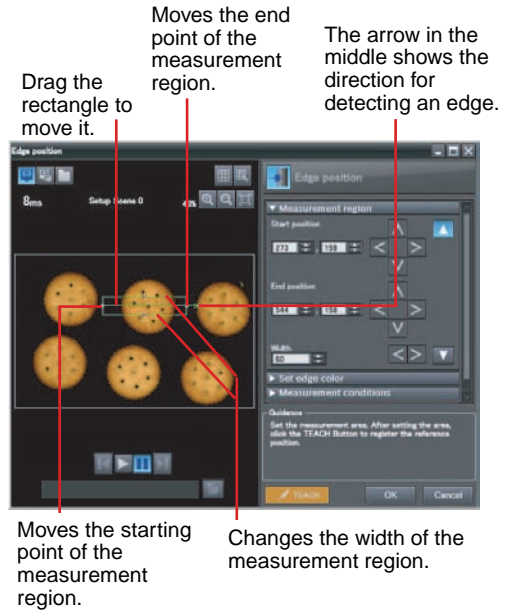

The following data is stored as basic measurement data.

Item	Parameter	Description
Reference data	Reference position X	The reference coordinates (X, Y) of the position are set automatically.
	Reference position Y	

Note

- The Teaching Button will flash if the conditions for reference registration change. When the Teaching Button flashes, click the Teaching Button again to register the reference.

• **Operation on the Touch Finder**

Use the following menu command to display the Setup Display on the Touch Finder.

- **[Inspect] – [Inspection] – [Edge Position] – [Modify] – [Settings] Tab Page – [Teach] –  – [Inspect region]**

Step 3 Adjusting the Judgement Parameters

- ▶ **Multiview Explorer: [Scene] – Scene number**
 - **Edit Pane:**  (**Inspection**) Icon – [**Edge Position**] (**right-click [Edit]**)
 - **Edge Position Pane:** [**Judgment parameters**]

1 Set the ranges that are to be judged as OK for the following parameters.

Continuous measurements will be performed for the images that are taken. The measured value is displayed beside the setting name.

2 Click [OK] at the lower right of the Edit Pane.

Click the [OK] Button to apply all of the changes made to the settings. Click the [Cancel] Button to cancel all changes.



Lower limit Upper limit

Parameter	Setting	Description
Position X	Range: -99,999.9999 to 99,999.9999 Defaults: Lower limit: -99,999.9999, Upper limit: 99,999.9999	Adjust the upper and lower limits of edge position X for an OK judgement.
Position Y	Range: -99,999.9999 to 99,999.9999 Defaults: Lower limit: -99,999.9999, Upper limit: 99,999.9999	Adjust the upper and lower limits of edge position Y for an OK judgement.

• Operation on the Touch Finder

Use the following menu command to display the Setup Display on the Touch Finder.

- ▶ **[Inspect] – [Inspection] – [Edge Position] – [Modify] – [Settings] Tab Page – [Judgement]**

Stabilizing Edge Position Results

There Is an Edge But It Cannot Be Detected

► **Multiview Explorer: [Scene] – Scene number**

→ **Edit Pane:**  **(Inspection) Icon – [Edge Position] (right-click [Edit])**

→ **Edge Position Dialog Box: [Measurement conditions]**

Parameter	Setting	Description
Edge threshold	Range: 0 to 100 Default: 50	Set the color change threshold to detect as an edge. The edge point is found based on a threshold that is set for a color change. Important If you change the edge threshold, perform teaching again.

Note

Edge Threshold

An edge is detected in the following way.

1. The color change distribution of the entire measurement region is determined.
2. The minimum color change is 0%. The maximum color change is 100%.
3. The location where the color change intersects with the edge threshold is detected as the edge.

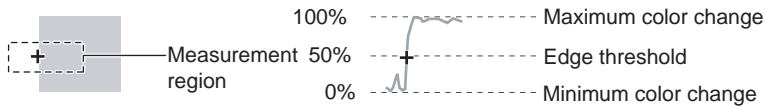

• Operation on the Touch Finder

Use the following menu command to display the Setup Display on the Touch Finder.

- **[Inspect] – [Inspection] – [Edge Position] – [Modify] – [Details] Tab Page – [Meas. Parameter] – [Edge level]**

Noise Is Mistaken as an Edge

► Multiview Explorer: [Scene] – Scene number

→ Edit Pane:  (Inspection) Icon – [Edge Position] (right-click [Edit])

→ Edge Position Dialog Box: [Measurement conditions]

Parameter	Setting	Description
Noise threshold	Sensors with Color Cameras Only Range: 0 to 422 Default: 10 (Sensors with Monochrome Cameras only) Range: 0 to 256 Default: 128	Sets the density level to be considered as noise. If the difference between the maximum and minimum color changes in the region is below the noise level, it will be assumed that there is no edge. Increase this value if noise is incorrectly detected as an edge. Important If you change the noise threshold, perform teaching again.

Note

Noise threshold

The maximum and minimum color deviations and densities within the edge detection region are determined. If the difference is less than the noise threshold, it is assumed that there are no edges. Normally there is no problem with the default value of 10, but if noise is mistakenly detected as an edge, make this value higher.

Sensors with Color Camera

Within the Region

Max. color change – Min. color change < Noise threshold → No edge found → Measurement result: NG

Max. color change – Min. color change ≥ Noise threshold → Edge found → Perform measurement

Sensors with Monochrome Cameras

Max. density change – Min. density change < Noise threshold → No edge found → Measurement result: NG

Max. density change – Min. density change ≥ Noise threshold → Edge found → Perform measurement

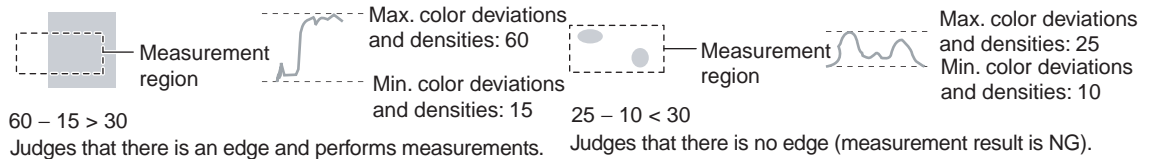

Screen Display When the Edge Threshold and Noise Threshold Are Changing

A bar showing the threshold level moves up and down on the graphic as the edge threshold/noise threshold value changes.

A cross-key cursor will also appear at the detected edge position.

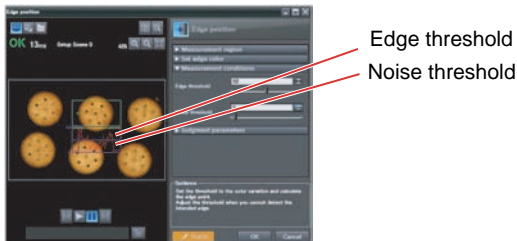

• Operation on the Touch Finder

Use the following menu command to display the Setup Display on the Touch Finder.

- [Inspect] – [Modify] – [Edge Position] – [Modify] – [Details] Tab Page – [Meas. Parameter] – [Noise level]

Specifying the Edge Detection Color (Sensors with Color Cameras Only)

Manually set the color of the edge that you want to detect.

- ▶ **Multiview Explorer: [Scene] – Scene number**
 - **Edit Pane:**  **(Inspection) Icon – [Edge Position] (right-click [Edit])**
 - **Edge Position Dialog Box: [Set edge color]**

- 1** Select the **[Set edge color]** Check Box.
- 2** Select a density change.
- 3** Select the color to detect in the color palette.
You can check the extraction color you selected in the color palette. You can also check and adjust the RGB values of the extraction color. The specified color will be extracted.
- 4** Click **[TEACH]**.

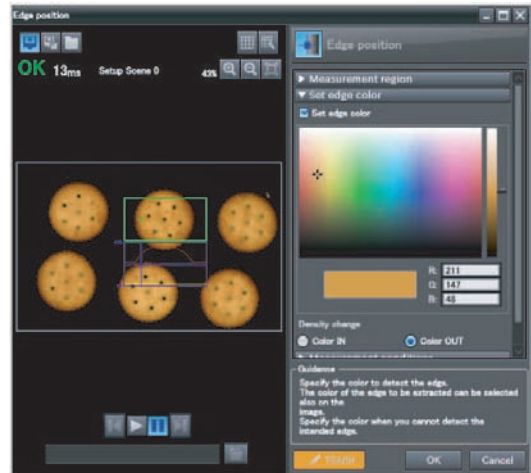

(Only a rectangle can be used to specify the region.)

Item	Parameter	Description
Density change	Color IN	Detects as an edge any position where the color changes from another color to the specified color.
	Color OUT	Detects as an edge any position where the color changes from the specified color to another color.

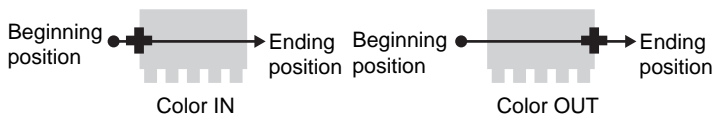

• Operation on the Touch Finder

Use the following menu command to display the Setup Display on the Touch Finder.

- ▶ **[Inspect] – [Inspection] – [Edge Position] – [Modify] – [Settings] Tab Page – [Teach] –  – [Set color]**

Changing Edge Detection Conditions (Sensors with Monochrome Cameras Only)

You can change the following measurement conditions for Sensors with Monochrome Cameras.

- ▶ **Multiview Explorer: [Scene] – Scene number**
 - **Edit Pane:**  **(Inspection) Icon – [Edge Position] (right-click [Edit])**
 - **Edge Position Dialog Box: [Measurement conditions]**

Item	Parameter	Description
Density change	Light to Dark	Detects as an edge any position within the specified region that changes from white to black.
	Dark to Light	Detects as an edge any position within the specified region that changes from black to white.
Measurement methods	Projection method	A projection is formed based on the gray level, and any position of intersection between the gray level value and the threshold (edge level) is detected as an edge. This detection method is used when you must process an image with excessive noise or when the edges are blurry.
	Differentiation method	A differentiated waveform is created that represents the amount of change in gray level between neighboring pixels. The maximum value of the differentiated waveform that exceeds the threshold (edge level) is detected as an edge. This detection method is used for low-contrast images.

• Operation on the Touch Finder

Use the following menu command to display the Setup Display on the Touch Finder.

- ▶ **[Inspect] – [Inspection] – [Edge Position] – [Modify] – [Details] Tab Page – [Meas. Parameter]**

Increasing Processing Speed for Edge Position

Make the measurement region smaller to reduce the processing time.

 Changing the Measurement Region p. 102

Measurement Data That Can Be Used for External Outputs and Calculations

The following values can be used as measurement data and output to external devices used in calculations.

Expression text string	Data name	Description	Data range
JG	Judgement	This is the judgement results for the edge position.	-2: No judgement (not measured), 0: Judgement is OK, -1: Judgement is NG, -13: Teaching not performed error, -14: Figure not registered error, -15: Out of range error
X	Edge position X	This is the X coordinate of the measured edge position.	-99999.9999 to 99999.9999
Y	Edge position Y	This is the Y coordinate of the measured edge position.	-99999.9999 to 99999.9999
SX	Standard position X	This is the X position of the edge position when a region is registered.	-99999.9999 to 99999.9999
SY	Standard position Y	This is the Y position of the edge position when a region is registered.	-99999.9999 to 99999.9999

 4-8 Calculations and Judgements Using Inspection Item Data p.138

Measurement Data That Can Be Logged for Edge Position

You can select to log any of the following values.

Measurement item	Range of value	Description
Judgement	0: Judgement is OK -1: Judgement is NG -13: Teaching not performed error -14: Figure not registered error -15: Out of range error	This is the measurement judgement results.
Edge position X	-99999.9999 to 99999.9999	This is the X coordinate of the measured edge position.
Edge position Y	-99999.9999 to 99999.9999	This is the Y coordinate of the measured edge position.

* When logging data is output, the data is output in the order of the above table. If more than one item is stored, results are output for each model.

 7-3 Logging Measurement Data and Image Data p. 191

Errors

Errors in Teaching

A teaching error message will appear if the edge position cannot be detected when teaching. Perform the following.

- If the color of the measurement object has changed from the specified color, set the color again and try teaching again.
- If there is an edge and it cannot be detected, adjust the [Noise level] on the [Details] Tab Page and try teaching again.

Edge Not Found

If an edge is not found, the measurement result will be NG. Perform the following.

- If a color was specified, make sure the color of the measurement object has not changed from the specified color.
- Set the color again if necessary.
- If there is an edge and it cannot be detected, make sure the [Edge level] parameter on the [Details] Tab Page is correct.

 Edge Levels p. 108

 Setting Colors p. 110

4-6 Inspecting with the Labeling Inspection Item

Labeling

One region of the color you want to measure is counted as a Label. You can sort these labels by position or size, and assign numbers to them. You can then output the total number of labels, and size and position of a desired label.

Sample Settings

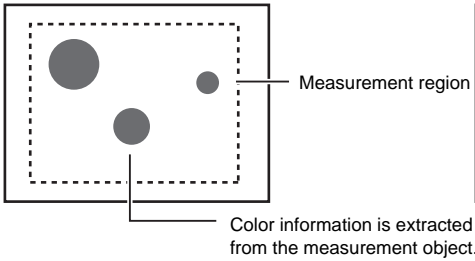

Sample Measurement

Regions of the extracted color are detected as labels.

Total number of detected labels: 3

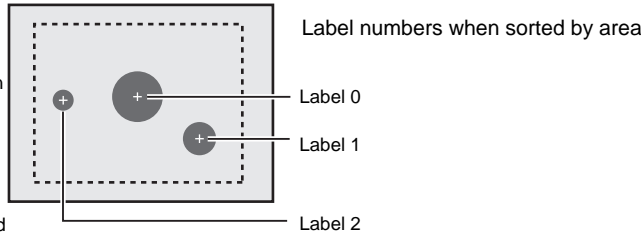

Note

If a Sensor with Color Camera is connected, you can specify up to four colors to measure. If a Sensor with Monochrome Camera is connected, the image is converted to a black and white binary image. Then, white pixels are measured.

Setup Procedure for Labeling Inspection Item

Step 1 Selecting the Inspection Item

- ▶ **Multiview Explorer: [Scene] – Scene number**
→ **Edit Pane:**  **(Inspection) Icon**

- 1 Drag [Labeling] from the [Available inspection items] area to the inspection item list.
- 2 Right-click the [Labeling] inspection item you added to the inspection item list and select [Edit].

 Registering Inspection Items p.86

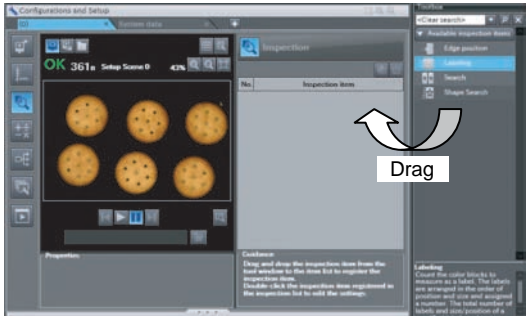

• Operation on the Touch Finder

Use the following menu command to display the Setup Display on the Touch Finder.

- ▶ **[Inspect] – [Inspection]**

Step 2 Teaching

Teaching means to store the region and label characteristics in that region as reference data for measurements.

- ▶ **Multiview Explorer: [Scene] – Scene number**
 - **Edit Pane:**  (Inspection) Icon – [Labeling] (right-click [Edit])
 - **Labeling Pane:** [Measurement region]

- 1** Place the object that is to be used as the measurement reference in front of the Camera.
- 2** Move the rectangle to the location to be measured.

 Changing the Measurement Region
p. 102

Drag the rectangle to move it. Drag a corner to size the rectangle.

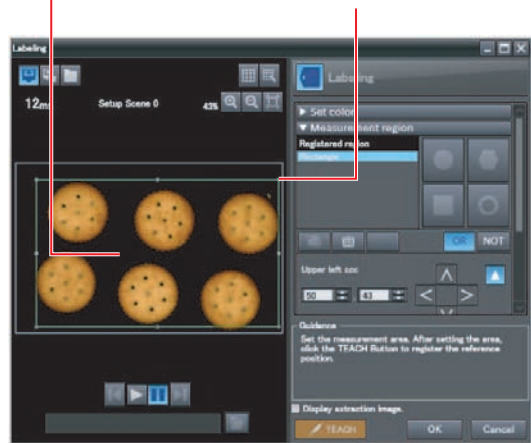

- 3** Select the range of color to detect. (This operation is possible for Sensors with Color Cameras only.) Select [Set color], and then click to select the extraction colors you want to register out of the color extraction ranges 0 through 3.
- 4** Drag a box around the color in the color palette for which you want to measure the area. Areas with that color will be automatically detected. If [Display extraction image] is selected, the image is displayed after extraction so that you can check it.



- 5 Select the range of brightness to detect. (Sensors with Monochrome Cameras only)**
 Click [Binary]. Specify the gray level you want to detect, and then click the [OK] Button. Specify the range of brightness to extract to convert to a binary image. Measurement is performed after the image taken by the camera in 256-color grayscale is converted to a binary image. In this case, white pixels are measured.

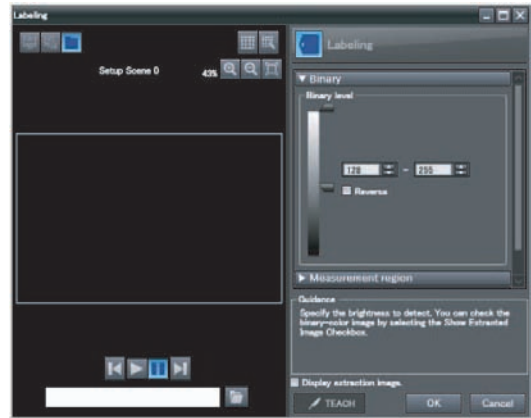

- 6 Click the [TEACH] Button in the lower-right corner.**
 The basic settings will be registered when teaching has been completed.

The following data is stored as the measurement reference.

Note

If you press the [TEACH] Button without specifying a color, the color with the largest area in the measurement region will be extracted and the resulting color information will be registered.

Item	Parameter	Description
Reference data	Reference area	The area for label 0 to use as a reference is set automatically.
	Reference position X	The gravity position X for label 0 to use as a reference is set automatically.
	Reference position Y	The gravity position Y for label 0 to use as a reference is set automatically.

• Operation on the Touch Finder

Use the following menu command to display the Setup Display on the Touch Finder.

Editing the Measurement Region

- ▶ [Inspect] – [Inspection] – [Labeling] – [Modify] – [Settings] Tab Page – [Teach] – ◀ – [Inspect region]

Creating a Binary Image (Sensors with Monochrome Cameras Only)

- ▶ [Inspect] – [Inspection] – [Labeling] – [Modify] – [Settings] Tab Page – [Teach] – ◀ – [Binary level]

Note

- The Teaching Button will flash if the conditions for reference registration change. When the Teaching Button flashes, click the Teaching Button again to register the model.

Step 3 Adjusting the Judgement Parameters

- ▶ **Multiview Explorer: [Scene] – Scene number**
 - **Edit Pane:**  (**Inspection**) Icon – [**Labeling**] (**right-click [Edit]**)
 - **Labeling Pane:** [**Judgment parameters**]

1 Set the ranges that are to be judged as OK for the following parameters.

Continuous measurements will be performed for the images that are taken.

2 Click [OK] at the lower right of the Edit Pane.

Click the [OK] Button to apply all edited settings.
Click the [Cancel] Button to cancel all changes.

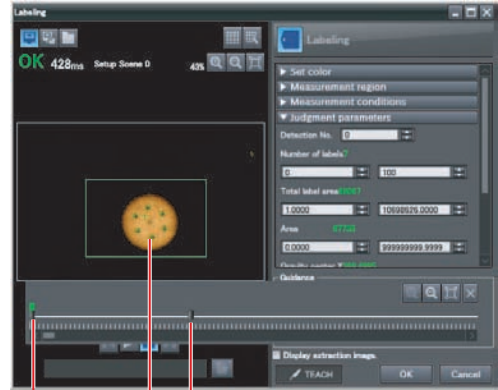

Lower limit Upper limit
Green for OK. Red for NG.

Item	Parameter	Setting	Description
Judgment parameters	Number of labels	Range: 0 to 100 Defaults: Upper limit: 100, Lower limit: 0	Set the upper and lower limits of the number of labels for an OK judgement.
	Total label area	Range: 0 to 999,999,999.9999 Defaults: Upper limit: 999,999,999.999, Lower limit: 0	Set the upper and lower limits of the total label area for an OK judgement.
	Area	Range: 0 to 999,999,999.9999 Defaults: Upper limit: 999,999,999.999, Lower limit: 0	Sets the upper and lower limits of the area for an OK judgement.
	Gravity center X	Range: -99,999.999 to 99,999.999 Defaults: Upper limit: 99,999.999, Lower limit: -99,999.999	Set the upper and lower limits of the gravity X for an OK judgement.
	Gravity center Y	Range: -99,999.999 to 99,999.999 Defaults: Upper limit: 99,999.999, Lower limit: -99,999.999	Set the upper and lower limits of the gravity Y for an OK judgement.
	Elliptic major angle	Range: -180 to 180 Defaults: Upper limit: 180, Lower limit: -180	Sets the upper and lower limits of the elliptic major angle for an OK judgement.

• Operation on the Touch Finder

Use the following menu command to display the Setup Display on the Touch Finder.

- ▶ **[Inspect] – [Inspection] – [Labeling] – [Modify] – [Settings] Tab Page – [Judgement]**

Measuring Multiple Colors

Set the colors using the color palette. Up to four colors can be specified. (This operation is possible for Sensors with Color Cameras only.)

- ▶ **Multiview Explorer: [Scene] – Scene number**
 - **Edit Pane:** (Inspection) Icon – [Labeling] (right-click [Edit])
 - **Labeling Dialog Box: [Set color]**

If the Reverse Check Box is selected, the color outside the region will become the selected color. The [Reverse] parameter applies to all colors.

Select the [Exclude] Check Box to exclude the selected color from extraction.



• Operation on the Touch Finder

Use the following menu command to display the Setup Display on the Touch Finder.

- ▶ **[Inspect] – [Inspection] – [Labeling] – [Modify] – [Settings] Tab Page – [TEACH] – – [Set color] – – [Color Palette]**

Checking the Extracted Results as an Image

You can change how the extraction color and all other colors are displayed. (This operation is for Sensors with Color Cameras only.)

- ▶ **Multiview Explorer: [Scene] – Scene number**
 - **Edit Pane:** (Inspection) Icon – [Labeling] (right-click [Edit])
 - **Labeling Dialog Box: [Display setting]*1**

*1 If [Display extraction image] is selected, the [Display setting] menu is displayed.

Item	Parameter	Setting	Description
Set color data	Extraction image type	All color image Binary image	Allows you to change how the extraction color is displayed.
	Select the background color	Black, White, Red, Green, or Blue	Allows you to change how colors other than the extraction color are displayed.

• Operation on the Touch Finder

Use the following menu command to display the Setup Display on the Touch Finder.

- ▶ **[Inspect] – [Inspection] – [Labeling] – [Inspection] – [Settings] Tab Page – [Teach] – – [Set color] – – [Display setting]/[Background color]**

Changing the Label Extraction Conditions

Set the label extraction conditions.

You can select to extract only labels that satisfy all three of the following: specified area, gravity X, and gravity Y conditions.

- ▶ **Multiview Explorer: [Scene] – Scene number**
 - **Edit Pane:**  (Inspection) Icon – [Labeling] (right-click [Edit])
 - **Labeling Dialog Box:** [Measurement conditions]

1 Set the parameters for the extraction conditions.



Item	Parameter	Setting	Description
Extraction condition	Area	Range: -999,999,999.9999 to 999,999,999.9999 Defaults: Upper limit: 999,999,999.999, Lower limit: 0	Specify the area range to judge as a label.
	Gravity X	Range: -999,999,999.9999 to 999,999,999.9999 Defaults: Upper limit: 999,999,999.999, Lower limit: -999,999,999.999	Specify the gravity X position to judge as a label.
	Gravity Y	Range: -999,999,999.9999 to 999,999,999.9999 Defaults: Upper limit: 999,999,999.999, Lower limit: -999,999,999.999	Specify the gravity Y position to judge as a label.

• Operation on the Touch Finder

Use the following menu command to display the Setup Display on the Touch Finder.

- ▶ **[Inspect] – [Inspection] – [Labeling] – [Modify] – [Settings] Details – [Details] Tab Page – [Meas. Parameter] – [Extraction condition]**

Sorting Extracted Labels

Set the sort condition and count for extracted labels.

You can set the sort condition and the maximum number of detections for detection results.

- ▶ **Multiview Explorer: [Scene] – Scene number**
 - **Edit Pane:**  (Inspection) Icon – [Labeling] (right-click [Edit])
 - **Labeling Dialog Box:** [Measurement conditions]

- 1 Select a sort condition.
- 2 Set the [Count].

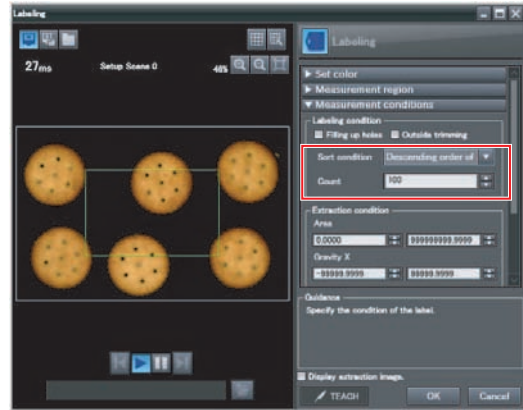

Item	Parameter	Settings	Description
Labeling condition	Sort condition	Ascending order of area Descending order of area (default) Ascending order of X coordinate Descending order of X coordinate Ascending order of Y coordinate Descending order of Y coordinate	Sets the condition to use for label number reassignment. When sorting by X or Y coordinates, the upper-left corner is the origin.
	Count	1 to 100 100 (default)	Set the maximum number of labels to detect.

• Operation on the Touch Finder

Use the following menu command to display the Setup Display on the Touch Finder.

- ▶ **[Inspect] – [Inspection] – [Labeling] – [Modify] – [Details] Tab Page – [Meas. Parameter]**

Using an Encoder Input to Exclude Redundant Labeling Results

When you detect workpieces as they travel along a conveyor belt, you can use an encoder input to exclude the results detected for the previous inspection. To use this function, an encoder input to the Sensor and conveyor tracking calibration are required. Refer to Section 9 Calibration for how to perform the conveyor tracking calibration.

 Calibration p. 345

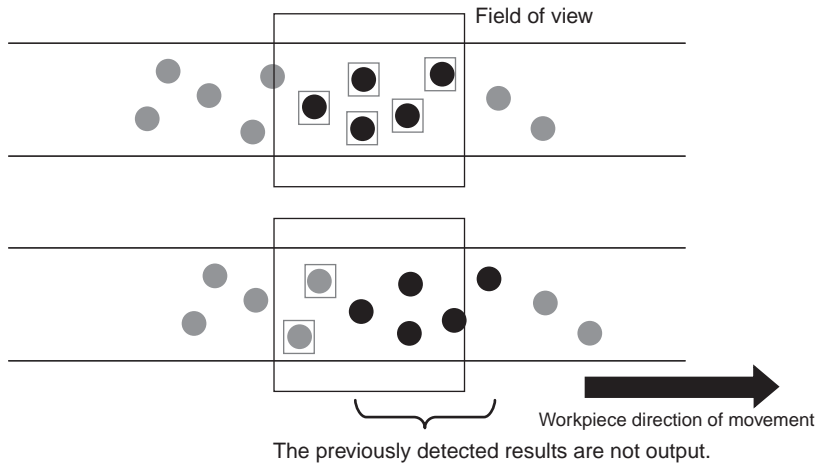

Important

When using this function, continuously input the trigger at a short interval. The intended detection results may not be achieved if the trigger interval is too long.

Input the next trigger before the measurement objects leave the field of view of the camera.

- When using an encoder trigger, adjust the trigger counter timing (p. 341).
- When using the TRIG parallel I/O signal (p. 215), an EtherCAT trigger (p. 241), the MEASURE no-protocol command (p. 283), or a single measurement PLC link command (p. 310), program the external device to create a short measurement trigger interval.

► Multiview Explorer: [Scene] – Scene number

- Edit Pane:  (Inspection) Icon – [Labeling] (right-click [Edit])
- Labeling Dialog Box: [Measurement conditions]

- 1 Select the [Remove duplication] Check Box.
- 2 Adjust the [Judgement distance] based on the size of the detection object.

Set the numerical values after calibration (i.e., the values in the robot coordinate system). The unit will be the setting unit that was used for calibration.

You can use the Panorama Display in Run Mode to check the adjusted results.

 6-2 Configuring the Run Mode Display
p. 169

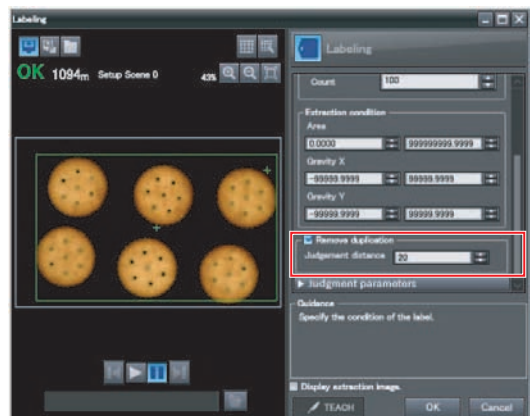

Note

You cannot set the judgement distance from the Touch Finder.

Editing the Measurement Region

This section describes how to edit the measurement regions.

You can edit the measurement region in the same way as for a search region.

 Changing the Model Registration Region to a Shape Other Than a Rectangle p. 100

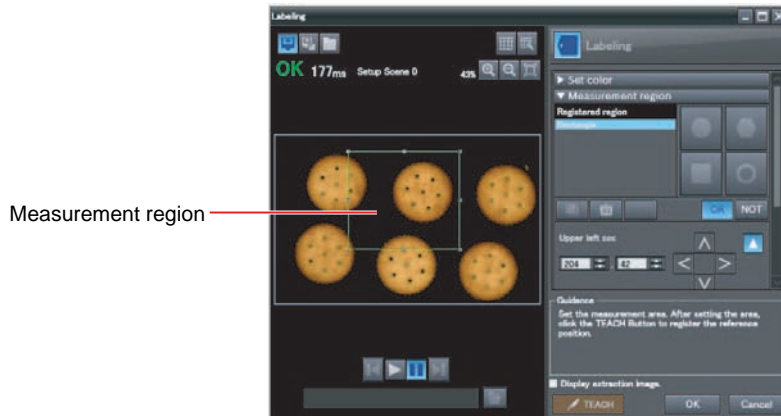

Important

If the measurement region is changed, perform teaching if required.

 p. 89

Increasing the Processing Speed

Make the measurement region smaller to reduce the processing time.

 Changing the Measurement Region p. 102

Measurement Data That Can Be Used for External Outputs and Calculations

The following values can be used as measurement data and output to external devices via the Ethernet or used in calculations.

Expression text string	Data name	Description	Data range
JG	Judgement	This is the Labeling judgement results.	-2: No judgement (not measured), 0: Judgement is OK, -1: Judgement is NG, -13: Teaching not performed error, -14: Figure not registered error, -15: Out of range error
L	Number of labels	This is the number of labels found.	0 to 100
TAR	Total label area	This is the total area of all labels found.	0 to 999,999,999.9999
AR[0] to AR[99]	Area	These are the areas of each individual label.	0 to 999,999,999.9999
X[0] to X[99]	Gravity coordinate X	These are the X coordinates of the center of each label.	-99,999.9999 to 99,999.9999
Y[0] to Y[99]	Gravity coordinate Y	These are the Y coordinates of the center of each label.	-99,999.9999 to 99,999.9999
ATH[0] to ATH[99]	Elliptic major angle	These are the elliptic major angles of the center of each label.	-180 to 180
SA	Reference area	This is the reference area.	0 to 999,999,999.9999
SX	Reference position X	This is the X coordinate of the reference position.	-99,999.9999 to 99,999.9999
SY	Reference position Y	This is the Y coordinate of the reference position.	-99,999.9999 to 99,999.9999

 4-8 Calculations and Judgements Using Inspection Item Data p. 138

Measurement Data That Can Be Logged for Labeling

You can select to log any of the following values.

Measurement item	Range of value	Description
Judgement	0: Judgement is OK -1: Judgement is NG -13: Teaching not performed error -14: Figure not registered error -15: Out of range error	This is the measurement judgement results.
Number of labels	0 to 100	This is the number of labels.
Total label area	0 to 999,999,999.9999	This is the total area of all extracted labels.
Area	0 to 999,999,999.9999	This is the area of the detected label (100 max.).
Gravity center X	-99999.9999 to 99999.9999	This is the gravity coordinate X of the detected label (100 max.).
Gravity center Y	-99999.9999 to 99999.9999	This is the gravity coordinate Y of the detected label (100 max.).
Elliptic major angle	-180 to 180	This is the elliptic major angle of the detected label (100 max.).

* When logging data is output, the data is output in the order of the above table.
If more than one item is stored, results are output in order for each label.

Example:

[# of label] [Total area] [Area 0.X] [Area 0.Y] [Gravity 0.X] [Gravity 0.Y] [Elliptic major angle 0.ATH] ... [Area N.X]
[Area N.Y] [Gravity N.X] [Gravity N.Y] [Elliptic major angle N.ATH] ... [Label (Count-1).X] [Label (Count-1).Y]
[Label (Count-1).TH]



7-3 Logging Measurement Data and Image Data p. 191

Errors

Errors in Teaching

A teaching error message will appear if the reference area registered during teaching is 0. Perform the following.

- If the color of the measurement object has changed from the specified color, set the color again and try teaching again.

4-7 Inspecting with the Shape Search Inspection Item

Shape Search

The shape data of the image to measure is registered in advance and measurements are performed to see where that shape is located. The image pattern that is registered in advance is called the model. The degree to which the image matches the model is called the correlation.

Sample Settings

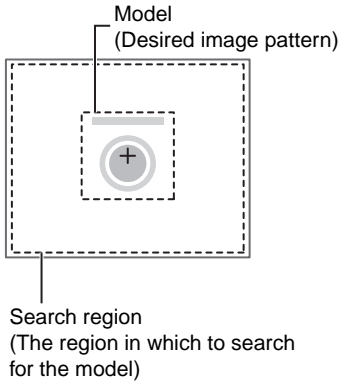

Sample Measurement

A search is made for sections that are similar to the model.

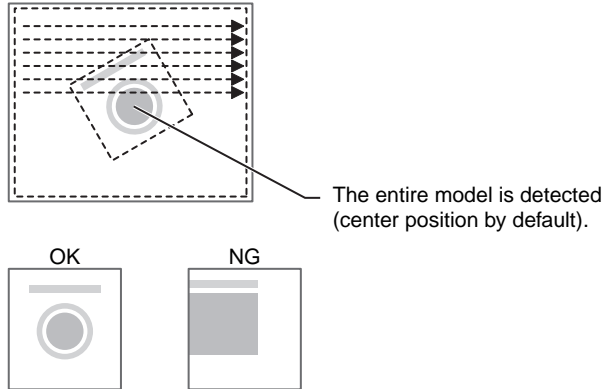

Setup Procedure for the Shape Search Inspection Item

Step 1 Selecting the Inspection Item

- ▶ **Multiview Explorer: [Scene] – Scene number**
→ **Edit Pane:**  **(Inspection) Icon**

- 1 Drag [Shape Search] from the [Available inspection items] area to the inspection item list.
- 2 Right-click the [Shape Search] inspection item you added to the inspection item list and select [Edit].

 Registering Inspection Items p.86

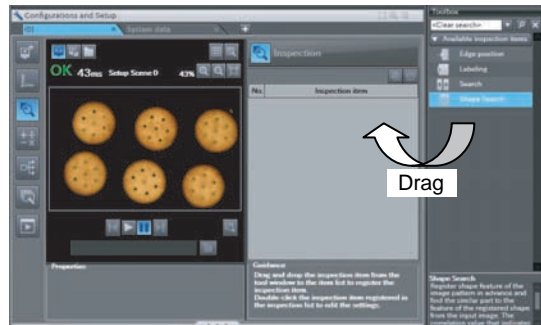

• Operation on the Touch Finder

Use the following menu command to display the Setup Display on the Touch Finder.

- ▶ **[Inspect] – [Inspection]**

Step 2 Teaching

Teaching means to store the region and image as reference data for the measurement.

► **Multiview Explorer: [Scene] – Scene number**

- **Edit Pane:**  (Inspection) Icon – [Shape Search] (right-click [Edit])
- **Shape Search Pane:** [Model region] – [Edit]

1 Place the object that is to be used as the measurement reference in front of the Camera.

2 Move the rectangle to the location to be measured.

3 Click [TEACH].

The basic settings will be registered when teaching has been completed.

Drag the rectangle to move it.

Drag a corner to size the rectangle.

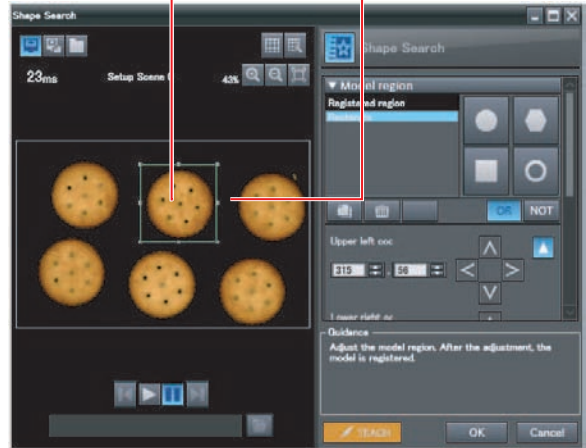

The following data is stored as the measurement reference.

Item	Parameter	Description
Reference data	Model image	This is the image in the model region that is stored as the reference.
	Reference position X	These are the center coordinates of the model image that are stored as the reference.
	Reference position Y	

Note

- You can customize the region to use for teaching.

 [Editing the Model Region p. 99](#)

- The Teaching Button will flash if the conditions for model registration change.
When the Teaching Button flashes, click the Teaching Button again to register the model.

• **Operation on the Touch Finder**

Use the following menu command to display the Setup Display on the Touch Finder.

- **[Inspect] – [Inspection] – [Shape Search] – [Modify] – [Settings] Tab Page – [TEACH] –  – [Model region]**

Step 3 Adjusting the Judgement Conditions

- ▶ **Multiview Explorer: [Scene] – Scene number**
 - **Edit Pane:**  (Inspection) Icon – [Shape Search] (right-click [Edit])
 - **Shape Search Pane:** [Judgment parameters]

1 Set the ranges that are to be judged as OK for the following parameters.

Continuous measurements will be performed for the images that are taken. The measured value is displayed beside the setting name.

- ### 2 Click [OK] at the lower right of the Edit Pane.
- Click the [OK] Button to apply all of the changes made to the settings. Click the [Cancel] Button to cancel all changes.

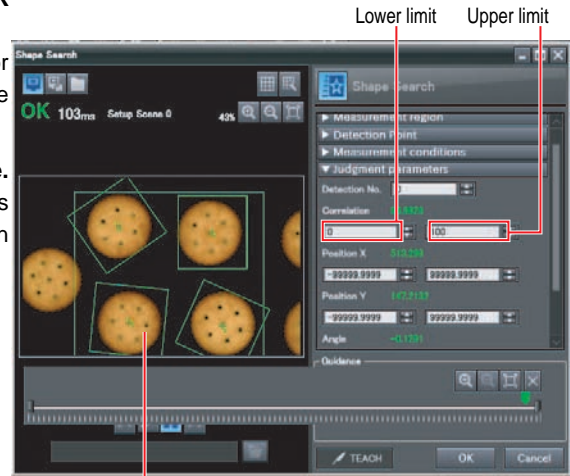

Green for OK. Red for NG.

Parameter	Setting	Description
Correlation	Range: 0 to 100 Defaults: Lower limit: 0, Upper limit: 100	Adjust the upper and lower limits of the correlation for an OK judgement.
Position X	Range: -99,999.9999 to 99,999.9999 Defaults: Lower limit: -99,999.999, Upper limit: 99,999.999	Adjust the upper and lower limits of measurement position X for an OK judgement.
Position Y	Range: -99,999.9999 to 99,999.9999 Defaults: Lower limit: -99,999.999, Upper limit: 99,999.999	Adjust the upper and lower limits of measurement position Y for an OK judgement.
Angle	Range: -180 to 180 Defaults: Lower limit: -180, Upper limit: 180	Adjust the upper and lower limits of measurement angle for an OK judgement.
Count	Range: 0 to 32 Defaults: Lower limit: 0, Upper limit: 32	Adjust the upper and lower limits of the detection count for an OK judgement.

Note

If you enabled the output of multiple results, you can specify the results to display with their detection number.

• Operation on the Touch Finder

Use the following menu command to display the Setup Display on the Touch Finder.

- ▶ **[Inspect] – [Inspection] – [Shape Search] – [Modify] – [Settings] Tab Page – [TEACH] – [Judgement]**

Changing Output Coordinate Positions

You can specify which part of the model to detect as coordinates during inspections. Normally, the center position of the registered model is used as the detection point.

► **Multiview Explorer: [Scene] – Scene number**

→ **Edit Pane:**  (Inspection) Icon – [Shape Search] (right-click [Edit])

→ **Shape Search Dialog Box:** [Detection Point]

1 Move the cross cursor to any position.

The position of the cross cursor will be the coordinate position that is output. This position is registered relative to the model region. You can also enter a value directly.

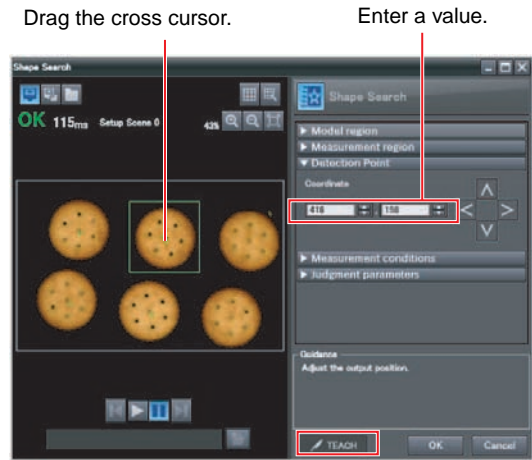

Note

The detection coordinates will automatically return to the center coordinates of the model if you change the model region.

• **Operation on the Touch Finder**

Use the following menu command to display the Setup Display on the Touch Finder.

► **[Inspect] – [Inspection] – [Shape Search] – [Modify] – [Settings] Tab Page – [Teach] –  – [Detection point]**

Obtaining Multiple Results Simultaneously

You can select to detect only the set number of objects that satisfy the extraction conditions.

Judgement is performed for all detected results.

You can also change the output order when you output the results.

► Multiview Explorer: [Scene] – Scene number

→ Edit Pane:  (Inspection) Icon – [Shape Search] (right-click [Edit])

→ Shape Search Dialog Box: [Measurement conditions]

1 Select the conditions by which to sort the detected results under [Sorting method].

You can output the results in the sort order that you selected.

2 Set the [Count].

This allows you to set the maximum number of results to output.



Selection item	Setting	Description
Sorting method	Ascending order of correlation value	Sorts the results in order from the smallest correlation to the largest.
	Descending order of correlation value (default)	Sorts the results in order from the largest correlation to the smallest.
	Ascending order of position X	Sorts the results in order from the smallest measurement X position to the largest.
	Descending order of position X	Sorts the results in order from the largest measurement X position to the smallest.
	Ascending order of position Y	Sorts the results in order from the smallest measurement Y position to the largest.
	Descending order of position Y	Sorts the results in order from the largest measurement Y position to the smallest.
Count	1 to 32	Sets the maximum number of objects to detect.

• Operation on the Touch Finder

Use the following menu command to display the Setup Display on the Touch Finder.

- [Inspect] – [Inspection] – [Shape Search] – [Modify] – [Details] Tab Page – [Meas. Parameter] – [Extraction condition] – [Detection count]

Select the Results to Output

You can use multiple conditions to determine which results to output from all the objects detected with a correlation at the candidate level or higher.

Only the results that meet all the specified conditions are output.

► Multiview Explorer: [Scene] – Scene number

→ Edit Pane:  (Inspection) Icon – [Shape Search] (right-click [Edit])

→ Shape Search Dialog Box: [Measurement conditions]

- 1 Adjust the [Candidate level] under [Extraction condition] so that only objects higher than a certain correlation are detected.
- 2 Set the measurement range (position X, position Y).



Extraction condition	Range	Description
Candidate level	Range: 0 to 100 Defaults: Lower limit: 60, Upper limit: 100	Outputs only objects with a correlation that is higher than the specified candidate level.
Position X	Range: -99,999.9999 to 99,999.9999 Defaults: Lower limit: -99,999.9999, Upper limit: 99,999.9999	Outputs only objects with an X measurement position that is within this range.
Position Y	Range: -99,999.9999 to 99,999.9999 Defaults: Lower limit: -99,999.9999, Upper limit: 99,999.9999	Outputs only objects with a Y measurement position that is within this range.

• Operation on the Touch Finder

Use the following menu command to display the Setup Display on the Touch Finder.

- [Inspect] – [Inspection] – [Shape Search] – [Modify] – [Details] Tab Page – [Meas. Parameter] – [Extraction condition]

Note

The processing time changes if you change the candidate level.

Using the Encoder Input to Exclude Redundant Search Results

When you detect workpieces as they travel along a conveyor belt, you can use an encoder input to exclude the results detected for the previous inspection. To use this function, an encoder input to the Sensor and conveyor tracking calibration are required.

Refer to Section 9 Calibration for how to perform the conveyor tracking calibration.

 9-1 Calibration p. 346

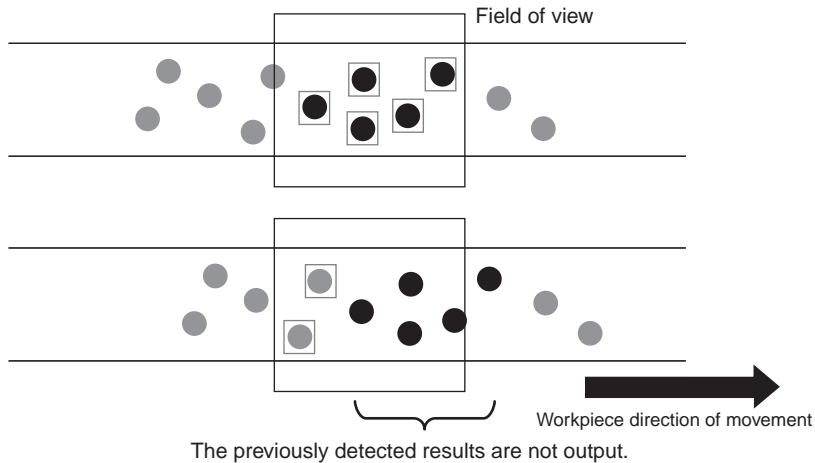

Important

When using this function, continuously input the trigger at a short interval. The intended detection results may not be achieved if the trigger interval is too long.

Input the next trigger before the measurement objects leave the field of view of the camera.

- When using an encoder trigger, adjust the trigger counter timing (p. 341).
- When using the TRIG parallel I/O signal (p. 215), an EtherCAT trigger (p. 241), the MEASURE no-protocol command (p. 283), or a single measurement PLC link command (p. 310), program the external device to create a short measurement trigger interval.

► Multiview Explorer: [Scene] – Scene number

- Edit Pane:  (Inspection) Icon – [Shape Search] (right-click [Edit])
- Shape Search Dialog Box: [Measurement conditions]

1 Select the [Remove duplication] Check Box.

2 Adjust the [Judgement distance] based on the size of the detection object.

Set the numerical values after calibration (i.e., the values in the robot coordinate system). The unit will be the setting unit that was used for calibration.

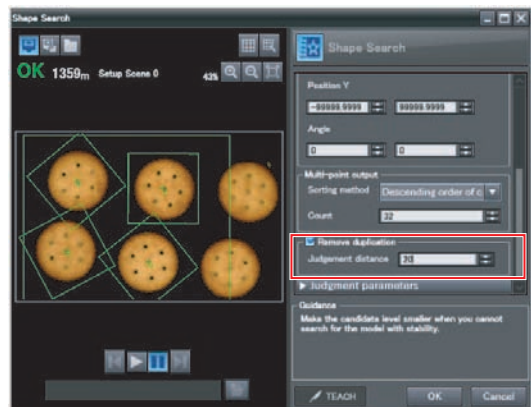

Note

You cannot set the judgement distance from the Touch Finder.

Using the Grip Interference Check Function to Exclude the Search Results of Workpieces That Are Not Able to Grip

When you detect workpiece, you can use the grip interference check function to exclude results from workpieces that are not able to grip.

- 1 Specify the necessary grip region aside from the model region, and register the color to be measured and area to be determined from the workpieces and the background colors within the specified region.

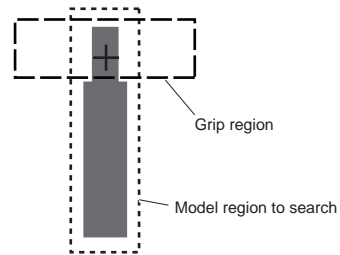

- 2 Complete measurement within the grip region of the detected workpiece using the area of the color registered in step 1 to determine whether gripping is possible or not by relative value to reference area value (the %).

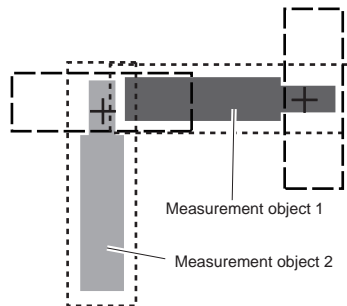

- 3 Only the search results for workpieces that have been determined as being able to grip with gripping areas at or above the grip area level are output.

- ▶ **Multiview Explorer: [Scene] – Scene number**
 - Edit Pane:  (Inspection) Icon – [Shape Search] (right-click [Edit])
 - Shape Search Dialog Box: [Measurement conditions]

- 1 Select the [Grip interference check] Check Box. The [Grip region] and [Set color] are displayed under [Judgment parameters].

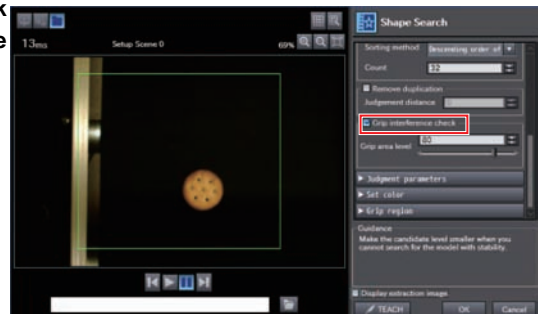

2 Set the region necessary for gripping.

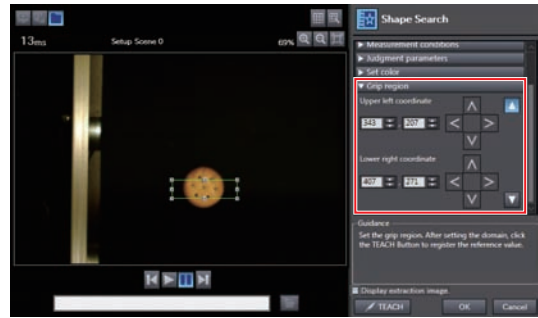

3 Specify the color of the workpiece in the gripping region and use it to teach the basic color area of the specified color. Refer to the below for instructions on how to specify the set color.

 p. 114

4 Set the [Grip area level].

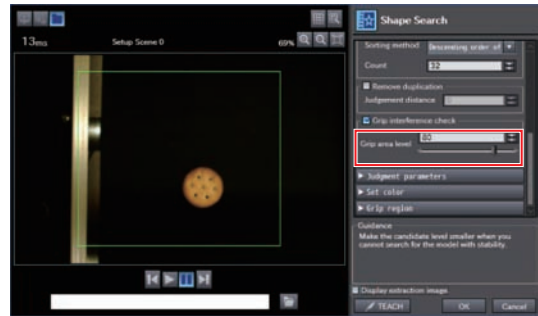

Selection item	Setting	Description
Grip area level	Range: 0 to 100 Default: 80	Set the threshold value for the grip interference check by area. Threshold value is relative value to reference area value (the %). Increase the grip area level if any workpieces that are unable to grip are detected.

Note

The grip interference check function cannot be set from the Touch Finder.

Handling the Tilt of a Search Object

Adjust the [Angle range] parameter to increase the range in which a search is made for the model.

The Search inspection item judges whether an image is OK or NG according to the correlation with a previously registered image pattern. For this reason, if the object is at an angle, the correlation is reduced and the image may be judged as NG.

To achieve an OK judgement for the same image pattern even when the object is at an angle, the rotation range must be widened.

► Multiview Explorer: [Scene] – Scene number

→ Edit Pane:  (Inspection) Icon – [Shape Search] (right-click [Edit])

→ Shape Search Dialog Box: [Model region] – [Rotation]

Parameter	Parameter	Description
Rotation range	-180° to 180°	A search is performed within the set angle range. The larger the angle range, the longer the processing time. Important If you change the angle range, perform teaching again.  p. 89

• Operation on the Touch Finder

Use the following menu command to display the Setup Display on the Touch Finder.

- [Inspect] – [Inspection] – [Shape Search] – [Modify] – [Details] Tab Page – [Model parameter] – [Angle range]

Stabilizing Search Results

Correlation Is Inconsistent Due to Low Contrast

Adjust the brightness to improve the contrast of the mark.

 Adjusting Brightness p. 73

Correlation Is Inconsistent Due to Variations in the Measurement Object

Inconsistent portions can be masked so that they are omitted from matching.

 Masking Parts of the Model p.101

Increasing the Processing Speed

The following two methods can be used to reduce processing time.

- Reduce the range in which a search is performed for the model.

 Changing the Measurement Region p. 102

- Reduce the angle range setting.

Adjust the [Angle range] parameter to reduce the range in which a search for the model is performed.

 Setting Angle Ranges p. 98

Editing the Model Region

You can edit model regions.

You can edit the inspection region in the same way as for a search region.

 Changing the Model Registration Region to a Shape Other Than a Rectangle p. 100

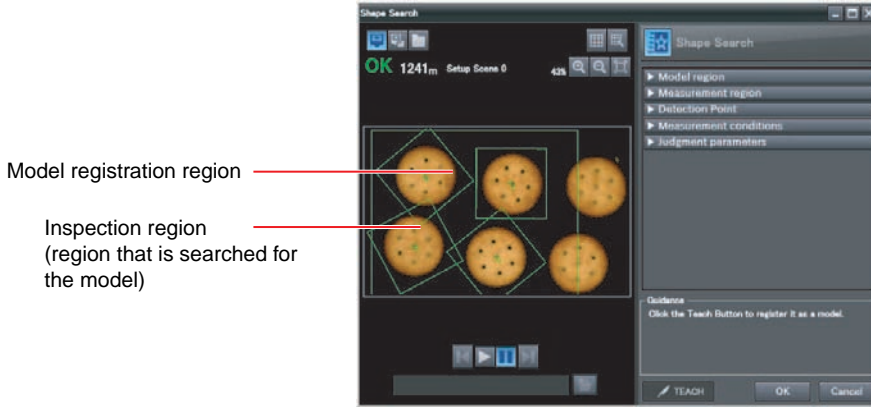

Important

If the model region is changed, perform teaching again.

 p. 89

Changing the Measurement

The region within which the model is searched can be changed. In the default settings, the whole display is set as the measurement region.

You can edit the inspection region in the same way as for a search region.

 Changing the Model Registration Region to a Shape Other Than a Rectangle p. 100



Measurement Data That Can Be Used for External Outputs and Calculations

The following values can be used as measurement data and output to external devices used in calculations.

Expression text string	Data name	Description	Data range
JG	Judgement	This is the judgement results of the search.	-2: No judgement (not measured), 0: Judgement is OK, -1: Judgement is NG, -13: Teaching not performed error, -14: Figure not registered error, -15: Out of range error
C	Count	This is the number of models found.	0 to 32
CR[0] to CR[31]	Correlation	This is the correlation of the Nth model that was found.	0 to 100
X[0] to X[31]	Position X	This is the X coordinate where the Nth model was found.	-99,999.9999 to 99,999.9999
Y[0] to Y[31]	Position Y	This is the Y coordinate where the Nth model was found.	-99,999.9999 to 99,999.9999
TH[0] to TH[31]	Angle	This is the angle in which the Nth model was found.	-180 to 180
SX	Reference position X	This is the X coordinate of the position where the model was registered.	-99,999.9999 to 99,999.9999
SY	Reference position Y	This is the Y coordinate of the position where the model was registered.	-99,999.9999 to 99,999.9999
ST	Reference angle	This is the angle when the model was registered.	-180 to 180
RX	Detection point coordinate X	This is the X coordinate of the detection point when the model was registered.	-99,999.9999 to 99,999.9999
RY	Detection point coordinate Y	This is the Y coordinate of the detection point when the model was registered.	-99,999.9999 to 99,999.9999



4-8 Calculations and Judgements Using Inspection Item Data p. 138

Measurement Data That Can Be Logged

You can select to log any of the following values.

Parameter	Range	Description
Judgement	0: Judgement is OK -1: Judgement is NG -13: Teaching not performed error -14: Figure not registered error -15: Out of range error	This is the measurement judgement results.
Correlation	0 to 100	This is the measured correlation.
Position X	-99,999.999 to 99,999.999	This is the measurement position X.
Position Y	-99,999.999 to 99,999.999	This is the measurement position Y.
Angle	-180 to 180	This is the measurement angle.

* When logging data is output, the data is output in the order of the above table.
If more than one item is stored, results are output for each model.

 7-3 Logging Measurement Data and Image Data p. 191

Errors

Errors in Teaching

A teaching error message will appear if the contrast of the image within the model registration region is too low. Select a region with a larger contrast between light and dark areas compared to the region that was registered as the model and re-register it as the model.

4-8 Calculations and Judgements Using Inspection Item Data

You can set inspection item judgement results and measurement data with the Calculation menu command to use them in basic arithmetic operations and functions. You can reflect the judgement results of the calculations in the overall judgement.

Calculation

Use the Calculation menu command to set the calculation expressions and the judgement parameters for the calculation results.

Expression

You can get up to 32 expressions. You can also combine expressions.

You can use the following values in calculations.

- Inspection item data (measurement data, reference values, and judgement results)
- Constants
- Other calculation results

Judgement

Upper and lower limit values are used for the judgement of calculation results (D0 to D31). Each calculation judgement result (J0 to J31) is turned ON if the result falls within the upper and lower limits. The OR logic of these results will be the overall judgement result JG.

Outputting the Calculation Results

You can use the overall calculation judgement results (JG) of the calculations in determining the overall judgement of the inspection item. You can also output the results of individual calculation results (D0 to D31) via Ethernet (output no-protocol data, output PLC link data, output programmable no-protocol data, or output file logging) or EtherCAT.

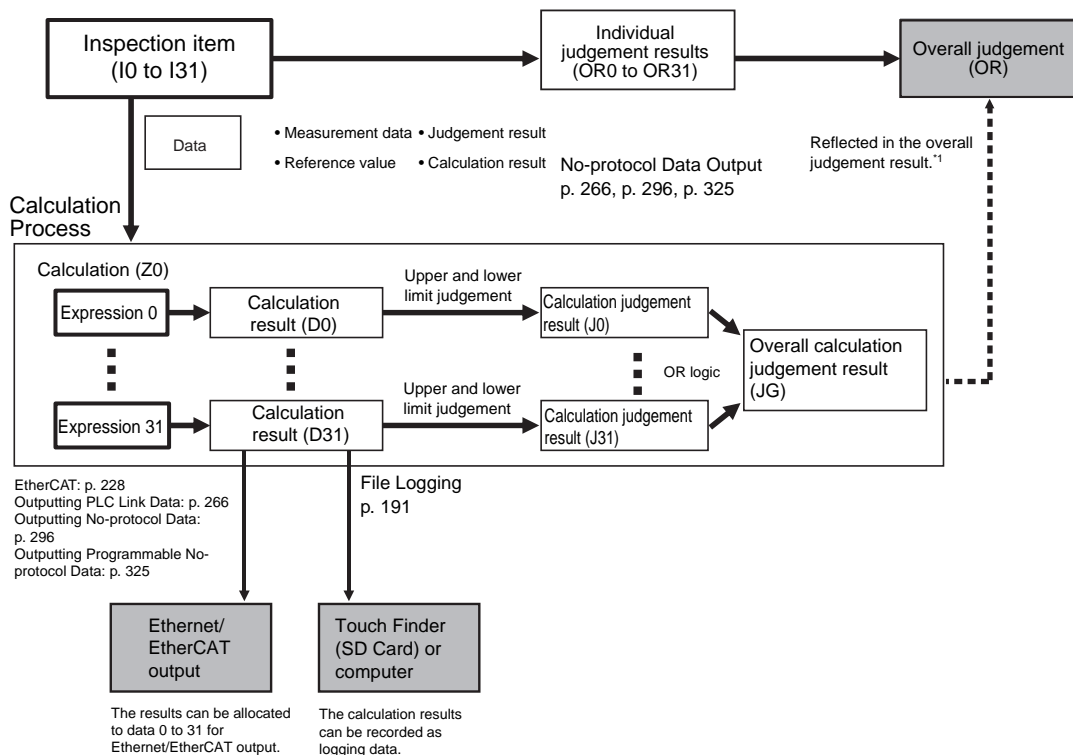

*1 You do not have to reflect the judgement results of the calculations in the overall judgement.

p. 146

Examples for Calculation

This example finds edge position 2 by detecting the two edge positions of inspection item 0 and inspection item 1, and calculates the distance between the two points.

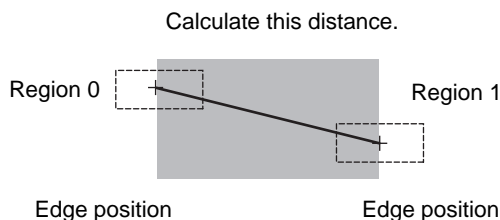

- Region 0 (edge position coordinates of inspection item 0): (I0.X,I0.Y)
- Region 1 (edge position coordinates of inspection item 1): (I1.X,I1.Y)
- Distance between two points = DIST (I0.X,I0.Y,I1X,I1.Y)

Setup Procedure for Calculations

- ▶ **Multiview Explorer: [Scene] – Scene number**
→ **Edit Pane:**  **(Calculation) Icon**
- 1** Right-click the expression list number you want to assign and select **[Edit]**.



• Operation on the Touch Finder

Use the following menu command to display the Setup Display on the Touch Finder.

- ▶ **[Inspect] – [Calculation]**

Setting Expressions

- 1** Set the expression under **[Expression]**. You can specify inspection item output data, constants, and variables in expressions.

Note

You can enter expressions as text.

- 2** Enter a comment about the expression under **[Name]**.

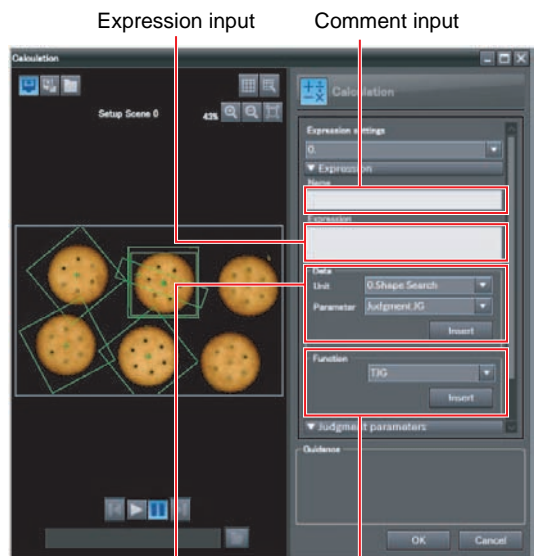

Select and insert inspection item output data.

Select and insert functions.

• Operation on the Touch Finder

Use the following menu command to display the Setup Display on the Touch Finder.

- ▶ **[Inspect] – [Calculation] – [Expression*] – [Settings] Tab Page – [Expression]**

Expression Notation

You can write expressions as shown below.

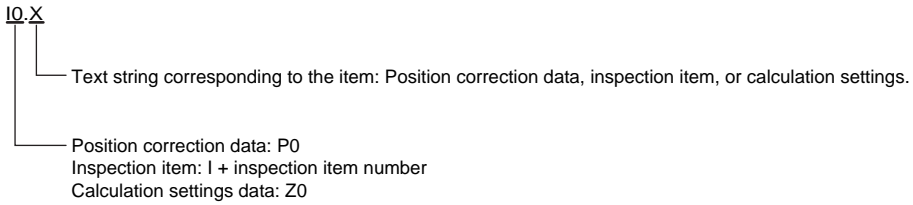

Example: Finding the distance between the centers of gravity of inspection item 1 and inspection item 2 using a function.

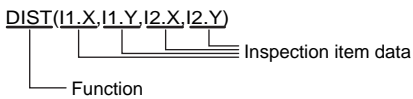

Example: Subtracting 120 from the calculation result of expression 0.

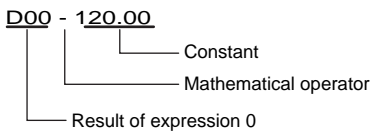

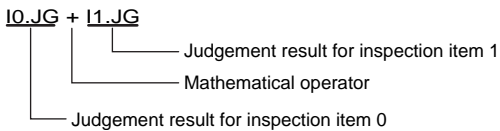

Example: Adding the judgement result of inspection items 0 and 1.



Copying Expressions

You can copy an expression if you need to use a similar expression in more than one location.

- 1** Click the expression you want to copy in the Expression List.
- 2** Click the  (Copy) Icon.
- 3** Select the location where you want to make the copy in the Expression List.
- 4** Click the  (Paste) Icon.

Deleting Expressions

You can delete a previously set expression.

- 1** Click the expression you want to delete in the Expression List.
- 2** Click the  (Delete) Icon.

Function List

The following functions can be used in calculations.

Function	Description
SIN	Finds the sine. The result is a value between -1 and 1 . The angle in the expression is in degrees. $SIN(\text{angle})$
COS	Finds the cosine. The result is a value between -1 and 1 . The angle in the expression is in degrees. $COS(\text{angle})$
ATAN	Finds the arctangent of the value (Y component, X component). The result is a radian value between $-\pi$ and π . $ANGL(Y_component, X_component)$ Example: Finding the angle between the straight line joining the centers of region 0 and region 1 and horizontal. $ATAN(R1.Y-R0.Y, R1.X-R0.X)$ If the two arguments are both 0, the result is 0 and the judgement is NG.
AND	Finds the logical AND. If one of the arguments is 0, the calculation result is 0. Otherwise it is -1 . $AND(\text{argument}_1, \text{argument}_2)$
OR	Finds the logical OR. If both of the arguments are 0, the calculation result is 0. Otherwise it is -1 . $OR(\text{argument}_1, \text{argument}_2)$
NOT	Applies a logical NOT operation. If the argument is 0, the calculation result is -1 . Otherwise it is 0. $NOT(\text{argument})$
ABS	Finds the absolute value. $ABS(\text{argument})$
MAX	Returns the larger of the two arguments. $MAX(\text{argument}_1, \text{argument}_2)$
MIN	Returns the smaller of the two arguments. $MIN(\text{argument}_1, \text{argument}_2)$

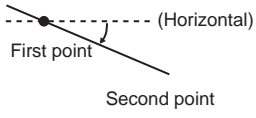
Function	Description
ANGL	<p>Finds the angle of the straight line joining two points (the center of gravity and center of the model). The angle against the horizontal is found. The result is a value between -180 and 180.</p> <p>$ANGL(Y_component, X_component)$</p> <p>Example: Finding the angle of the straight line joining the centers of region 0 and region 1</p> <p>$ANGL(R1.Y-R0.Y, R1.X-R0.X)$</p>  <p>If the two arguments are both 0, the result is 0 and the judgement is NG.</p>
MOD	<p>Finds the remainder after dividing a dividend with a divisor.</p> <p>$MOD(dividend, divisor)$</p> <p>If any of the arguments are real numbers, the decimals are rounded off before calculating the remainder. The remainder is the result of dividing integers.</p> <p>Example: $MOD(13,4)$... Result: 1 (remainder when 13 is divided by 4)</p> <p>$MOD(25.68,6.99)$... Result: 5 (remainder when 26 is divided by 7)</p>
SQRT	<p>Finds the square root.</p> <p>If the argument is negative, the result is 0. The judgement will be NG.</p> <p>$SQRT(argument)$</p>
DIST	<ul style="list-style-type: none"> Finds the distance between two points (the center of gravity and the center of the model). <p>$DIST(first_position_X, first_position_Y, second_poistion_X, second_position_Y)$</p> <p>Example: Finding the distance between the centers of gravity of region 0 and region 1</p> <p>$DIST(R0.X, R0.Y, R1.X, R1.Y)$</p> <p>The following calculation is performed internally.</p> $\sqrt{(R1.X-R0.X)^2+(R1.Y-R0.Y)^2}$ <ul style="list-style-type: none"> Finds the length of a perpendicular line from point (x,y) to line $ax + by + c = 0$. <p>$DIST(X_coordinate_of_point, Y_coordinate_of_point, coefficient_a_of_line, coefficient_b_of_line, coefficient_c_of_line)$</p>
ECNT	<ul style="list-style-type: none"> You can obtain the value of the encoder. <p>You can set ECNT only from the PC Tool.</p> <p>$ECNT(value\ to\ obtain)$</p> <ul style="list-style-type: none"> The following values can be obtained. <p>0: Get ring counter value at trigger</p> <p>1: Get ring counter value at calculation</p> <p>2: Get trigger counter value</p>

Performing Expression Judgement

- ▶ **Multiview Explorer: [Scene] – Scene number**
→ **Edit Pane:**  (Calculation) Icon – Expression number

- 1** Right-click the expression for which to adjust judgement conditions and select [Edit].
- 2** Click [Judgment parameters].
- 3** Set the upper and lower limit values for the judgement conditions.

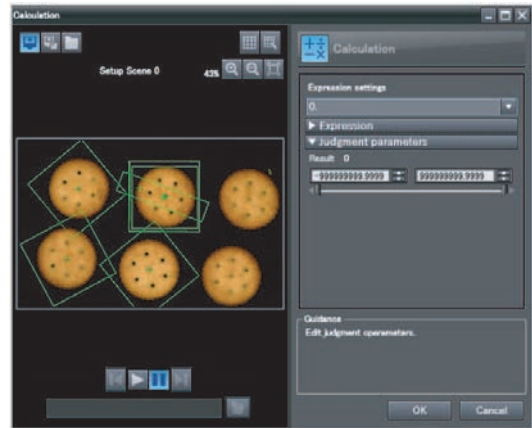

- **Operation on the Touch Finder**

Use the following menu command to display the Setup Display on the Touch Finder.

- ▶ **[Inspect] – [Calculation] – [Settings] Tab Page – [Judgement]**

Reflecting the Judgement Results for Expressions to the Overall Judgement Results

Perform the following settings to reflect the judgement results of a calculation in the overall judgement.

► **Multiview Explorer: [Scene] – Scene number**

→ Edit Pane:  (Calculation) Icon

- 1 Select the [Reflect to overall judgement] Check Box.

• **Operation on the Touch Finder**

Use the following menu command to display the Setup Display on the Touch Finder.

► **[Inspect] – [Calculation] – [Details] Tab Page – [Reflect]**

Inspection Item Data That Can Be Used in Expressions

Inspection item	Data name	Expression text string	Data range	Default
Search	Judgement	JG	-2: No judgement (not measured), 0: Judgement is OK, -1: Judgement is NG, -13: Teaching not performed error, -14: Figure not registered error, -15: Out of range error	
	Count	C	0 to 32	
	Correlation	CR[0] ^{*1} to CR[31]	0 to 100	
	Position X	X[0] ^{*1} to X[31]	-99999.9999 to 99999.9999	
	Position Y	Y[0] ^{*1} to Y[31]	-99999.9999 to 99999.9999	
	Angle	TH[0] ^{*1} to TH[31]	-180 to 180	
	Reference position X	SX	-99999.9999 to 99999.9999	
	Reference position Y	SY	-99999.9999 to 99999.9999	
	Reference angle	ST	-180 to 180	
	Detection point coordinate X	RX	-99999.9999 to 99999.9999	
Detection point coordinate Y	RY	-99999.9999 to 99999.9999		
Edge Position	Judgement	JG	-2: No judgement (not measured), 0: Judgement is OK, -1: Judgement is NG, -13: Teaching not performed error, -14: Figure not registered error, -15: Out of range error	
	Edge position X	X	-99999.9999 to 99999.9999	
	Edge position Y	Y	-99999.9999 to 99999.9999	
	Standard position X	SX	-99999.9999 to 99999.9999	
	Standard position Y	SY	-99999.9999 to 99999.9999	

Inspection item	Data name	Expression text string	Data range	Default
Labeling	Judgement	JG	-2: No judgement (not measured), 0: Judgement is OK, -1: Judgement is NG, -13: Teaching not performed error, -14: Figure not registered error, -15: Out of range error	
	# of label	L	0 to 100	
	Total area	TAR	0 to 999999999.9999	
	Area	AR[0] ^{*1} to AR[99]	0 to 999999999.9999	
	Gravity coordinate X	X[0] ^{*1} to X[99]	-99999.9999 to 99999.9999	
	Gravity coordinate Y	Y[0] ^{*1} to Y[99]	-99999.9999 to 99999.9999	
	Elliptic major angle	ATH[0] ^{*1} to ATH[99]	-180 to 180	
	Reference area	SA	0 to 999999999.9999	
	Reference position X	SX	-99999.9999 to 99999.9999	
	Reference position Y	SY	-99999.9999 to 99999.9999	
Shape Search	Judgement	JG	-2: No judgement (not measured), 0: Judgement is OK, -1: Judgement is NG, -13: Teaching not performed error, -14: Figure not registered error, -15: Out of range error	
	Count	C	0 to 32	
	Correlation	CR[0] ^{*1} to CR[31]	0 to 100	
	Position X	X[0] ^{*1} to X[31]	-99999.9999 to 99999.9999	
	Position Y	Y[0] ^{*1} to Y[31]	-99999.9999 to 99999.9999	
	Measurement angle	TH[0] ^{*1} to TH[31]	-180 to 180	
	Reference position X	SX	-99999.9999 to 99999.9999	
	Reference position Y	SY	-99999.9999 to 99999.9999	
	Reference angle	ST	-180 to 180	
	Detection point coordinate X	RX	-99999.9999 to 99999.9999	
Detection point coordinate Y	RY	-99999.9999 to 99999.9999		

*1: You can omit [0] if there is only a single value.

The following expression values can be specified as expression data to output them.

Expression text string	Data name	Description	Data range
JG	Judgement	This is the overall judgement results for all expressions.	-2: No judgement (not measured), 0: Judgement is OK, -1: Judgement is NG
JG[0] to JG[31]	Individual judgement results	This is the individual judgement result for expression N.	-2: No judgement (not measured), 0: Judgement is OK, -1: Judgement is NG
D[0] to D[31]	Individual calculation results	This is the calculation result for expression N.	-999,999,999.9999 to 999,999,999.9999

Measurement Data That Can Be Logged for Calculations

You can select to log any of the following values.

Measurement item	Range of value	Description
Overall judgement results	-2: No judgement (not measured), 0: Judgement is OK, -1: Judgement is NG	This is the overall judgement results for all expressions.
Individual judgement results	-2: No judgement (not measured), 0: Judgement is OK, -1: Judgement is NG	This is the individual judgement results of expressions 0 to 31.
Results 0 to 31	-999999999.9999 to 999999999.9999	This is the results of expressions 0 to 31.

* When logging data is output, the data is output in the order of the above table.

Testing and Saving Settings

5-1 Performing Test Measurements.....	150
5-2 Checking the Trend of Measurement Results with Graphs	152
5-3 Decreasing the Measurement Takt Time.....	158
5-4 Checking a List of All Inspection Item Results	160
5-5 Saving Data to the Sensor.....	161

5-1 Performing Test Measurements

After you finish making the [Image], [Calibration], [Inspection], and [Calculation] settings, you can perform a test measurement to check for correct operation. Test measurements is used to verify that the settings that have been made will produce stable results and, if necessary, to fine-tune the measurements. Test measurements are performed on the currently displayed image.

Note

You can select from four different views: Graphics, Result List, Trend Monitor, and Histogram.

 Changing the Run Mode Display p. 169

Performing Test Measurements with Samples

Test measurements are performed on the image currently being taken by the Sensor. You can view the overall judgement of all inspection items for the target of a test measurement.

▶ Multiview Explorer: [Scene] – Scene number

→ Edit Pane:  [Run] – [Start monitor]

- 1 Input an image of a previously prepared object.
Check the judgement results.
- 2 When you finish checking the results, click [Close].

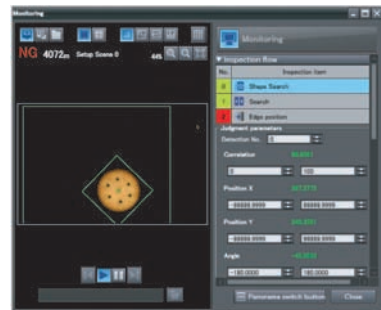

• Operation on the Touch Finder



Use the following menu command to display the Setup Display on the Touch Finder.

▶ [Test] – [Continuous test] – [Graphics + Details]





Performing Test Measurements with Saved Images (Re-measuring)

The Sensor can save measured images in the Sensor's built-in memory or on an SD card through either the PC Tool or the Touch Finder. Test measurements can be performed by using these saved images. This function is useful for adjusting the judgement parameters when objects are not available.

- ▶ **Multiview Explorer: [Scene] – Scene number**
→ **Edit Pane: [Inspection]**

- 1 **Select  (Logging image) or  (Image file).**
 - Logging image: Images logged in the Sensor's internal memory
 - File image: Images saved in the personal computer
- 2 **Click the  (Select the image) icon and select a file.**
- 3 **The display switches to the selected image and measurements are taken again.**
- 4 **You can use the following control buttons to change the displayed image and perform measurements again.**



	For file images, this button cycles through all image files in the folder where the selected file is stored. For logged images, all logged images are cycled through.
	When the  [Pause] Button is pressed, this button changes to the previous image.
	When the  [Pause] Button is pressed, this button changes to the next image.



Note

With the PC Tool, you can perform test measurements even in Offline Mode. When offline, you can select file images and perform test measurements. However, you cannot accurately determine the measurement time with offline measurements.

 Offline Settings p. 372

• **Operation on the Touch Finder**

Use the following menu command to display the Setup Display on the Touch Finder.

- ▶ **[Test] – [Continuous test] – [Graphics + Details] –  – **

5-2 Checking the Trend of Measurement Results with Graphs

You can use the trend monitor and histograms to check the test measurement result histories.

Trend Monitor

Changes in the measurement values of the selected inspection item against time can be observed from the graph. It is possible to predict when malfunctions may occur or to analyze the cause of a malfunction by checking the trends in the measurement values. The most recent 1,000 measurement values are displayed on a graph.

PC Tool

- ▶ **Multiview Explorer: [Scene] – Scene number**
→ Edit Pane: (Run) Icon – [Start monitor] – (Trend Monitor) Icon



Changes in the measured values of the selected inspection item are displayed against time in a graph.

Touch Finder

- ▶ (Run Mode) – [Select display] – [Monitor]

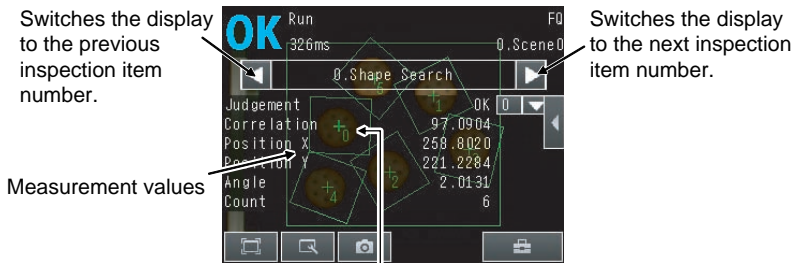

Changes in the measured values of the selected inspection item are displayed against time in a graph.

Note

If there is a high load on the Sensor for measurement processing, display data can sometimes be omitted from the Trend Monitor. To prevent display data omissions, set the BUSY signal output timing to [Result display]. If the Sensor is being controlled over a PLC link, execute the next command only after confirming that the BUSY signal from the Sensor is OFF.

 Adjusting the End Timing of the BUSY Output p. 223

Arranging the Trend Monitor Display

PC Tool

You can change the parameters to display (3 max.), the number of data on the X axis, and the display range on the Y axis. The Trend Monitor Settings Pane is displayed in the detailed results field.

• Selecting the Parameters to Display

- 1 Click the  (Add the new graph) icon.
- 2 Select the [View] Check Box for the parameters to display.
- 3 Click the display color box and select a color.
- 4 Select an inspection item and parameter.

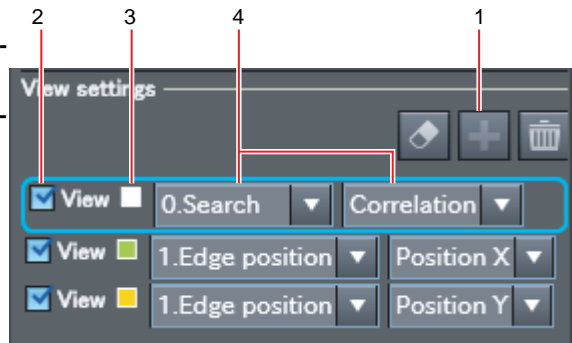

• Selecting the Parameter to Delete

- 1 Select the parameter to delete. The currently selected parameter is highlighted with a light-blue box.
- 2 Click the  (The display of the selected graph is cleared) icon.

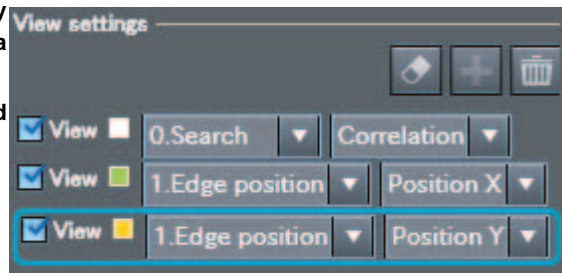

• Changing the Display Range of the Y Axis

- 1 Set the display range for the Y axis (-9,999,999.999 to 9,999,999.999).

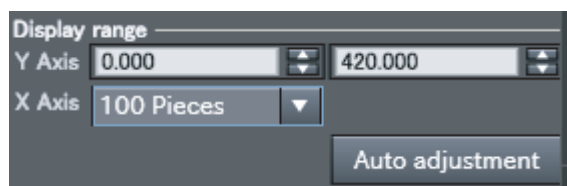

- **Automatically Setting the Display Range of the Y Axis**

- 1 Click the [Auto adjustment] Button. The range of the Y axis is set automatically based on the displayed data.

- **Changing the Display Range of the X Axis**

- 1 Select the number of data to display (100 to 1,000).

Touch Finder

You can change the display range for the Y axis and the number of values that are displayed for the X axis.

Note

You can display only one parameter in the Trend Monitor on the Touch Finder.
You cannot display multiple parameters at the same time.

- **Disabling Automatic Selection of the Display Range**

- 1 Press [] – [Auto display] on the right of the trend monitor.
- 2 Press [OFF].

- **Changing the Display Range of the Vertical Axis**

- 1 Press [] – [Display range] on the right of the trend monitor.
- 2 Set the minimum and maximum values of the measurement values.

- **Changing the Number of Values That Are Displayed**

- 1 Press [] – [Number of data] on the right of the trend monitor.
- 2 Select the number of values from 200, 400, and 1,000.

Note

- Trend monitor data is held until the power supply is turned OFF.
- You can select whether to display all data on the trend monitor or only data for which the overall judgement is NG. Logging settings are applied to the trend monitor as well. However, they are not applied to trend monitor when it is displayed in Setup Mode.



Checking Recent Measurement Trends (Recent Results Logging) p. 199

Histograms

You can check the distribution of measurement values on a histogram.

PC Tool

► Multiview Explorer: [Scene] – Scene number

→ Edit Pane: (Run) Icon - [Start monitor] – (Histogram) Icon



The distribution of measurement values that are equivalent to the judgement values is displayed in a histogram for the selected inspection item.

Touch Finder



The distribution of measurement values that are equivalent to the judgement values is displayed in a histogram for the selected inspection item.

► (Run Mode) – [Select display] – [Histogram]

Note

If there is a high load on the Sensor for measurement processing, display data can sometimes be omitted from the Histogram. To prevent display data omissions, set the BUSY signal output timing to [Result display]. If the Sensor is being controlled over a PLC link, execute the next command only after confirming that the BUSY signal from the Sensor is OFF.

Adjusting the End Timing of the BUSY Output p. 223

Arranging Histogram Displays

PC Tool

The parameters to display, the display range on the X axis, and the number of data on the Y axis of the histogram can be changed. The Histogram Settings Pane is displayed in the detailed results field.

- **Selecting the Parameters to Display**

- 1 Select the display color.
- 2 Select the inspection item and the parameter.



- **Changing the Display Range of the X Axis**

- 1 Set the display range for the X axis (-9,999,999.999 to 9,999,999.999).
- 2 Set the spacing between vertical histogram bars (1 to 9,999,999).

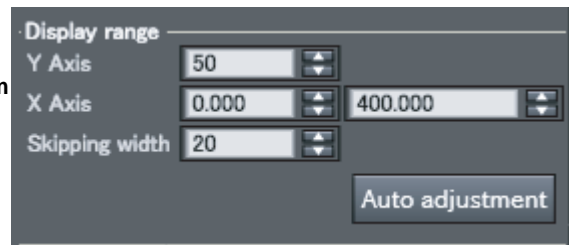

- **Changing the Number of Data on the Y Axis**

- 1 Set the maximum number of data to display (1 to 99,999).

- **Automatically Setting the Maximum Number of Data for the Y Axis**

- 1 Click the [Auto adjustment] Button.
The maximum number of data for the Y axis is set automatically based on the displayed data.

Arranging Histogram Display

The display range on the X axis and the number of data on the Y axis of the histogram can be changed.

- **Disabling Automatic Adjustment of the Display Range**

- 1 Press [◀] – [Auto display] on the right of the histogram.
- 2 Press [OFF].

- **Changing the Display Range of the X Axis**

- 1 Press [◀] – [Display range] on the right of the histogram.
- 2 Select the maximum measurement value, the minimum measurement value, and the class.

- **Changing the Number of Data on the Y Axis**

- 1 Press [◀] – [Number of data] on the right of the histogram.
- 2 Select the maximum number of data to display.

Note

- Histogram data is held until the power supply is turned OFF.
- You can select whether to display all data in the histogram or only data for which the overall judgement is NG. Logging settings are applied to the histogram as well. However, they are not applied to histograms displayed in Setup Mode.



Checking Recent Measurement Trends (Recent Results Logging) p. 199

5-3 Decreasing the Measurement Takt Time

Checking the Measurement Takt Time

You can check the measurement time of the Sensor from the Edit Pane. When online, the measurement time is displayed as the amount of time that was required for processing by the Sensor. When offline, the amount of time that was required for processing by the computer is displayed. To estimate the processing time, connect the Sensor and go online.

Measurement Time Display Example



The measurement time is the time taken from when a trigger is input until when all measurement processes are executed.

During the measurement time, this Sensor will not accept the next trigger. This means that the measurement time is the basic measurement takt time.

Inputting a trigger

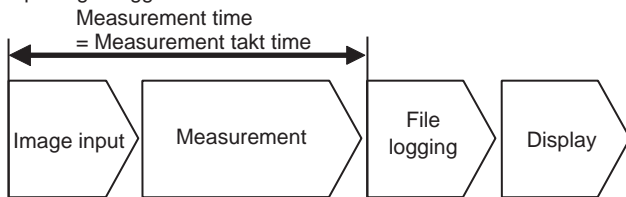

Increasing Image Input Speed

With the partial input function, it is possible to input only images that are in the region that is necessary for measurements. The image measurement region becomes smaller and thus the image input time is shortened.

- ▶ **Multiview Explorer: [Scene] – Scene number**
→ **Edit Pane:**  **(Image) Icon – [Setup menu] – [Partial input]**

1 Change the input size.

The minimum vertical width for image input is 8 lines.





Important

If you use partial input, perform teaching again.

• Operation on the Touch Finder

Use the following menu command to display the Setup Display on the Touch Finder.

- ▶  **[Image] – [Camera setup] –  – [Partial input]**

Shortening the Processing Time for Measurement Items

The processing time can be shortened by making the measurement region for each measurement item smaller.

 Changing the Measurement Region p. 102

5-4 Checking a List of All Inspection Item Results

You can check the individual judgement results for all inspection items in a list. You can select the individual inspection items to change the judgement parameters.

- ▶ **Multiview Explorer: [Scene] – Scene number**
→ **Edit Pane:**  **(Inspection) Icon**

The judgement results (OK: green, NG: red) are displayed in the inspection item list in Edit Pane.



The judgement results (OK: Green, NG: Red) are also displayed in the inspection item flow list in the Monitoring Pane.

- **Starting the Monitor**

 p. 150

- **Operation on the Touch Finder**

Use the following menu command to display the Setup Display on the Touch Finder.

- ▶ **[Test] – [Continuous test] – [All results/region]**

5-5 Saving Data to the Sensor

Execute [Save data] after you have finished making your settings.

The Vision Sensor will remind you to do so with a message if you switch from Setup Mode to Run Mode. When a message is displayed, always execute [Save data].

Important

Do not turn OFF the power supply while data is being saved. The data that is being saved may become corrupted.

1 Use either of the following methods to save the settings to the Sensor.

- Multiview Explorer: [Device group] – Sensor name (Double-click)
→ Edit Pane:  (Online) Icon – [Save data]



- Multiview Explorer: [Scene] – Scene number
→ Edit Pane:  (Run) Icon – [Save data]



2 Click the [Yes] Button.

• Operation on the Touch Finder

Use the following menu command to display the Setup Display on the Touch Finder.

▶ [Test] – [Save data]

Note

- Scene data, system data, and calibration data can be saved with the above procedure.

 Scene Data and System Data p. 204

- Measurement data and image data cannot be saved with the above procedure.

 Logging Measurement Data and Image Data p. 191

- Settings data can also be backed up to an external memory

 Saving Settings p. 204

MEMO

Operation

6-1 Starting Operation.....	164
6-2 Configuring the Run Mode Display.....	169
6-3 Checking the Trend of Measurement Results with Graphs.....	173
6-4 Adjusting Judgement Parameters during Operation.....	176

6-1 Starting Operation

After you have completed test measurements and adjustments in Setup Mode, you change to Run Mode and start actual measurements. After entering Run Mode, the Sensor performs measurements in sync with the measurement trigger. This section describes the displays on both the PC Tool and the Touch Finder when the Sensor is in Run Mode. You can use the PC Tool for setup, and use the Touch Finder for constant monitoring.

Run Mode Display

PC Tool



Item	Description
(1) Display layout	Changes area (7) to a non-split or a four-way split display.
(2) Display type	When a non-split display is selected for the display layout (1), you can select between the following four displays for area (7). <ul style="list-style-type: none"> • Image + Graphics • Image + Result list • Trend monitor • Histogram
(3) Display refresh condition	Select from the following two timings to refresh the display. <ul style="list-style-type: none"> • When the measurement results are updated • When the measurement results are NG
(4) Overall judgement	Displays the overall judgement result and the measurement processing time.
(5) Image display controls	Used to set the zoom level of the image displayed in area (7) or to automatically resize the image to fit the size of the display.
(6) Image magnification	Used to set the magnification of the image displayed in area (7).
(7) Results display	Displays the measured image, trend monitor, and other results.
(8) Statistical data	Displays statistical data.
(9) Clear Statistical Data Button	Clears the statistical data.
(10) Detailed results display	Displays detailed results, such as the inspection items and calculation results.
(11) Close Button	Closes the Monitoring Pane.
(12) Log to the File Button	Starts or stops logging to a file.
(13) Guide line display settings	Used to set the display conditions for guide lines.
(14) Show Guide Lines Button	Used to show and hide guide lines.

Touch Finder

The present display name. → Selected inspection item

Overall judgement → OK

Measurement processing time → 326ms

The time required from when an image is input until all measurements have been completed.

Inspection results can be displayed in six patterns, such as in a list or as a trend graph. → p. 169

These buttons are displayed both in Setup Mode and Run Mode. → p. 58

Connected Sensor name → FQ

Selected scene number → 0.Scene 0

Sub-menu → 0

Indicates the measurement results that are currently displayed.

Tool Button or OK Button

Sub-menu

Indicates the measurement results that are currently displayed.

Tool Button or OK Button

Changing to Run Mode

PC Tool

You can move from Setup Mode to Run Mode from either the Main Pane or an Edit Pane. Use either of the following methods to save the settings to the Sensor.

• Main Pane

- ▶ **Multiview Explorer: [Device group] – Sensor model (right-click [Edit])**
→ **Edit Pane: [Online] – [Switch the sensor mode]**

1 Press [Run].

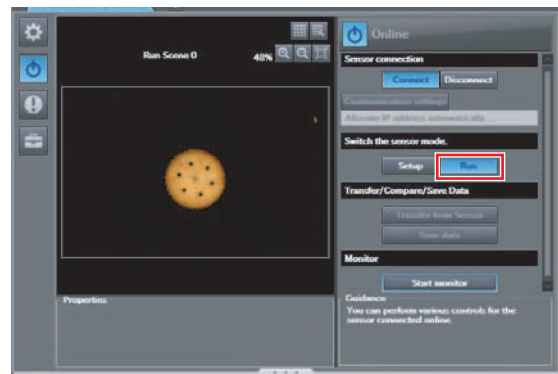

- Scene Edit Pane

- ▶ Multiview Explorer: [Scene] – Scene number
→ Edit Pane: ▶ [Run] Icon

1 Press [Run].



Note

If you did not save the changes made in Setup Mode to the Sensor, the following dialog box is displayed. Click [Save data] to save the settings data to the Sensor.

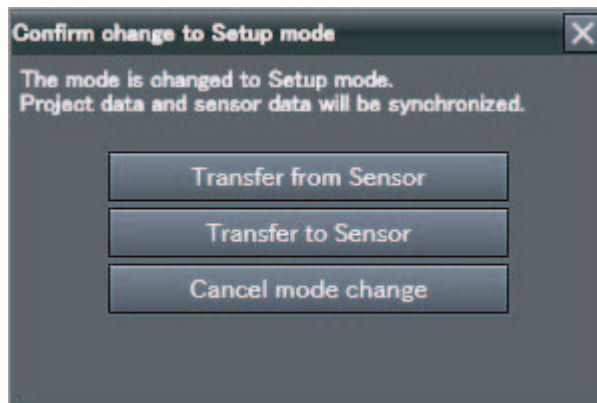

After the data is saved, the Sensor changes to Run Mode.

Note

You cannot edit scene data, system data, or calibration data in Run Mode. If you change to Run Mode, the Edit Pane for the scene data, system data, or calibration data will close. You will be able to display only the Main Pane.

Touch Finder

You can move from Setup Mode to Run Mode by using the following procedure.

- 1 Press [Run].
- 2 Press [Switch to Run mode.].

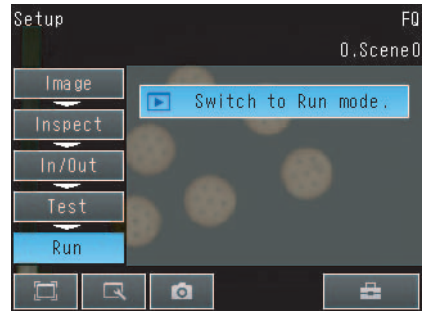

Note

- Returning to Setup Mode

Press  and press [Sensor settings].

- Signal Status When Moving to Run Mode

When moving to Run Mode, the signal will change as shown below and data can be input from and output to an external device.

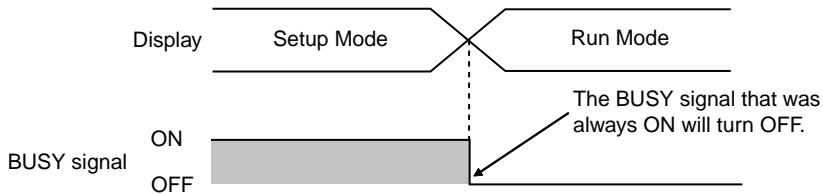

Starting the Monitor

In the PC Tool, you can open the Monitor Pane to view measurement results.

• Main Pane

- ▶ **Multiview Explorer: [Device group] – Sensor model (right-click [Edit])**
→ Edit Pane: [Online]

1 Select [Start monitor].

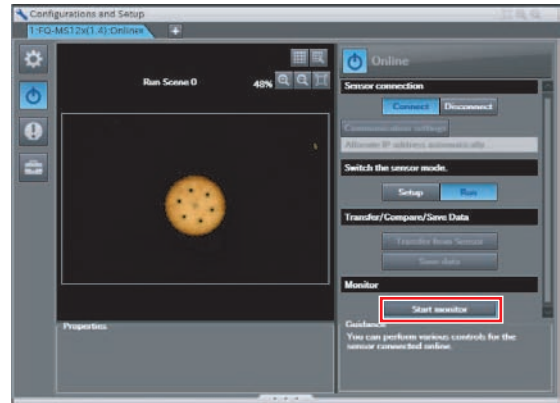

• Scene Edit Pane

- ▶ **Multiview Explorer: [Scene] – Scene number**
→ Edit Pane: ▶ [Run] Icon

1 Select [Start monitor].



Note

You cannot edit scene data, system data, or calibration data while monitoring measurement results.

6-2 Configuring the Run Mode Display

Displayed Information

You can select what information is displayed in Run Mode. Select the display as desired for the application.

PC Tool

You can click the display type icon to view results in the results display area in two different patterns. The detailed results display shows detailed results for the inspection item that is currently selected in the [Inspect flow].

- Statistical data: The history of the overall judgement results (measurement count, NG count, and NG rate) will appear.
- Inspect flow: Displays a list of registered inspection items sorted by order of inspection.
- Detailed results: Displays detailed measurement results for an inspection item.
- Calculation: Displays the results for each expression registered to an inspection item.

Image + Graphics



Image + Result list



Important

You cannot select the trend monitor or histogram on the PC Tool in Run Mode.

Click the [Panorama switch button] to view the panorama display.

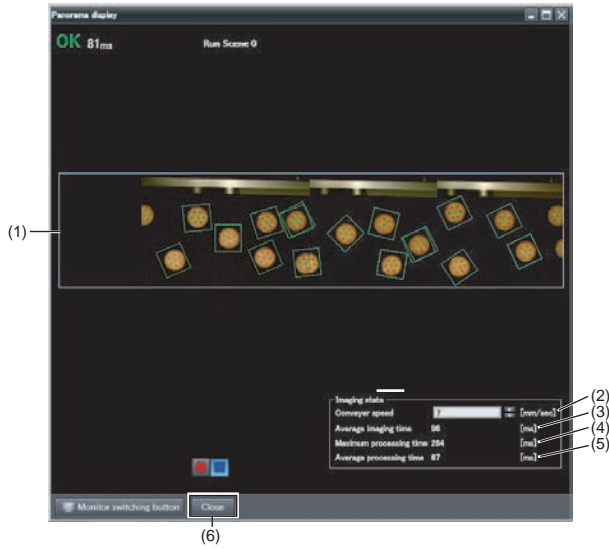

No.	Item	Description
(1)	Panorama image	Combines continuous display images into a panorama image display. The model region and detection points for the inspection item are displayed. The regions where the images overlap are also displayed. This allows you to easily confirm if any models were not detected.
(2)	Conveyor speed	Enter the speed of the conveyor. The average imaging interval is calculated based on these values.
(3)	Average imaging time	Displays the average image trigger interval in milliseconds.
(4)	Maximum processing time	Displays the maximum time that was required for measurement processing in milliseconds. This allows you to confirm how much leeway you have in the measurement time compared with the averaging imaging interval.
(5)	Average processing time	Displays the average processing time for measurement processing in milliseconds.
(6)	Close	Closes the panorama display.

Note

The following conditions must be satisfied to view the panorama display.

- The encoder must be connected directly to the Sensor and must be used for the value of the ring counter.
- The calibration for conveyor tracking must be completed.
- The BUSY output condition for the BUSY signal must be set to [Result display completion].

Changing the BUSY Signal Output Condition p. 222

- When offline, an image that was saved by using file logging must be selected.
- The file name assigned for logging must not be changed.
- When offline, the Sensor settings (calibration data and scene data) when the logging was performed must be imported into the PC Tool.

Touch Finder

Checking the Judgement Results of Inspection Items

Graphics



The image and region currently being measured will appear.

Graphics + Details



In addition to [Graphics] display, individual judgement results and measurement values of selected inspection items will appear.

Checking the Overall Judgement Result History

Statistical data



The currently measured image and history of the overall judgement results (measurement count, NG count, and NG rate) will appear.

Checking the Judgements of All Inspection Items in a List

All results/region
(Standard Models Only)

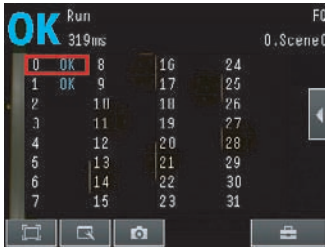

The judgement results of all inspection items can be checked in a list.

Displaying Measurement Result Histories

Trend monitor



The statistical data for the currently selected inspection item can be checked against time.

p. 173

Histogram

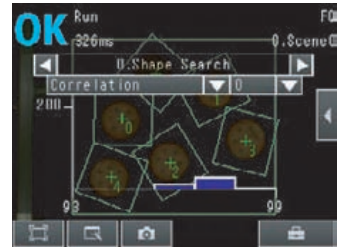

The distribution of measurement results of the currently selected inspection item can be checked.

p. 173

(Run Mode) – [Select display]

The following displays are convenient if more than one Sensor is connected.

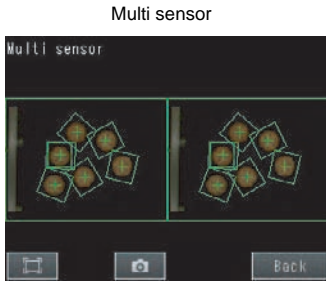

Displays the measurement results of all connected Sensors.
Green display: OK, Red display: NG

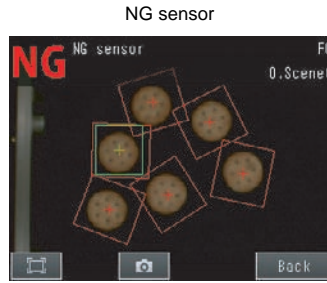

Automatically changes to the display for any Sensor with an NG result.

▶ (Run Mode) – [Sensor monitor]

Displaying the Inspection Item Results

You can scroll through the measurement results of all the configured inspection items by using the following operations.

Switches to the previous inspection item.

Switches to the next inspection item.



Note

The following are also displayed in addition to the measurement results for each inspection item.

- Camera input: The image that is being measured is displayed.
- Position comp.: The result of position compensation is displayed.
- All Region: The measurement regions for all inspection items are displayed.

Specifying the Startup Run Mode Display for the Touch Finder

You can set the display that appears when the power supply is turned ON. The default setting is [Graphics].

▶ (Setup Mode or Run Mode) – [TF settings] – [Startup display] – [Display pattern]

Note

You can set the scene to display when the power supply is turned ON.

 Setting the Startup Scene p. 182

6-3 Checking the Trend of Measurement Results with Graphs

You can use the trend monitor and histograms to check the measurement result histories.

Important

You cannot display the trend monitor or histogram on the PC Tool in Run Mode.

Trend Monitor

Changes in the measurement values of the selected inspection item against time can be observed from the graph. It is possible to predict when malfunctions may occur or to analyze the cause of a malfunction by checking the trends in the measurement values. The most recent 1,000 measurement values are displayed on a graph.

Touch Finder

- ▶  (Run Mode) – [Select display] – [Monitor]

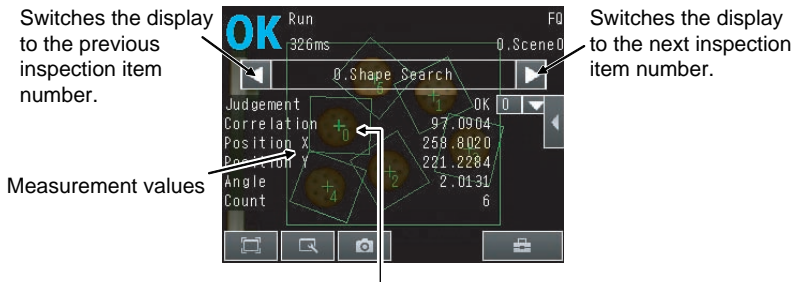

Changes in the measured values of the selected inspection item are displayed against time in a graph.

Arranging the Trend Monitor Display

Touch Finder

You can change the display range for the Y axis and the number of values that are displayed for the X axis.

Note

You can display only one parameter in the Trend Monitor on the Touch Finder. You cannot display multiple parameters at the same time.

• Disabling Automatic Selection of the Display Range

- 1 Press [- 2 Press [OFF].

- **Changing the Display Range of the Vertical Axis**

- 1 Press [◀] – [Display range] on the right of the trend monitor.
- 2 Set the minimum and maximum values of the measurement values.

- **Changing the Number of Values That Are Displayed**

- 1 Press [◀] – [Number of data] on the right of the trend monitor.
- 2 Select the number of values from 200, 400, and 1,000.

Note

- Trend monitor data is held until the power supply is turned OFF.
- You can select whether to display all data on the trend monitor or only data for which the overall judgement is NG. Logging settings are applied to the trend monitor as well. However, they are not applied to trend monitor when it is displayed in Setup Mode.

 Checking Recent Measurement Trends (Recent Results Logging) p. 199

Histograms

You can check the distribution of measurement values on a histogram.

Touch Finder

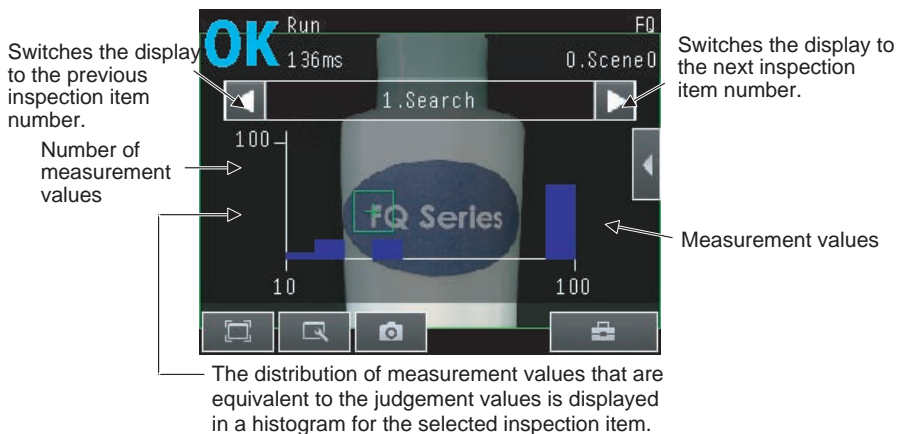

▶  (Run Mode) – [Select display] – [Histogram]

Arranging Histogram Displays

Arranging Histogram Display

The display range on the X axis and the number of data on the Y axis of the histogram can be changed.

- **Disabling Automatic Adjustment of the Display Range**

- 1 Press [\blacktriangleleft] – [Auto display] on the right of the histogram.
- 2 Press [OFF].

- **Changing the Display Range of the X Axis**

- 1 Press [\blacktriangleleft] – [Display range] on the right of the histogram.
- 2 Select the maximum measurement value, the minimum measurement value, and the class.

- **Changing the Number of Data on the Y Axis**

- 1 Press [\blacktriangleleft] – [Number of data] on the right of the histogram.
- 2 Select the maximum number of data to display.

Note

- Histogram data is held until the power supply is turned OFF.
- You can select whether to display all data in the histogram or only data for which the overall judgement is NG. Logging settings are applied to the histogram as well. However, they are not applied to histograms displayed in Setup Mode.



Checking Recent Measurement Trends (Recent Results Logging) p. 199

6-4 Adjusting Judgement Parameters during Operation

With this Sensor, you can adjust the judgement parameters while measurements are being performed. Downtime can be eliminated with this feature because the production line does not have to be stopped while making adjustments.

Preparations

This function is switched OFF as a default to prevent it from inadvertently operating during operation. Turn ON the function if you want to use it.

- ▶ **Multiview Explorer: [System] – [System data]**
→ **Edit Pane:**  **(Sensor setting) Icon – [Adjust judgement]**

1 Click [ON].

• Operation on the Touch Finder

Use the following menu command to display the Setup Display on the Touch Finder.

- ▶  **(Setup Mode) – [Sensor settings] – [Adjustment mode in Run]**

Changing the Judgement Parameters in Run Mode

This section describes how to change the judgement parameters without stopping measurement in Run Mode.

PC Tool

- 1 Select the inspection item for which to adjust judgement parameters from the Inspect Flow Area.
- 2 The detailed results and judgement values for the selected inspection item are displayed in the Detailed Result Display. Adjust the judgement parameters.



► Run Mode

- 1 Select the inspection item for which you want to adjust the judgement parameters using the ◀ and ▶ Buttons.
- 2 Press [◀] – [Adjust judgement].

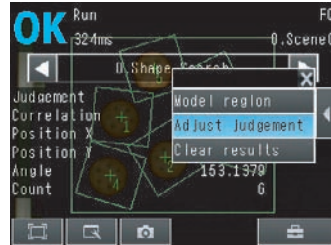

- 3 Change the adjustment parameters with the slider.
- 4 Press [OK].
The judgement results with the changed judgement parameters will appear.



Important

The changed judgement parameters will not be reflected in the measurement result until [OK] is pressed.

MEMO

Convenient Functions

7-1 Changing the Scene to Change the Line Process	180
7-2 Display Functions	183
7-3 Logging Measurement Data and Image Data	191
7-4 Transferring and Saving Settings	204
7-5 SD Card Operations	206
7-6 Convenient Functions for Operation.....	208
7-7 Functions Related to the Sensor System Environment	210
7-8 Functions Related to the Touch Finder System Environment	212

7-1 Changing the Scene to Change the Line Process

What Are Scenes?

With an FQ-M Vision Sensor, the inspection items that can be processed at the same time are registered as scenes. A command input from an external device, a Touch Finder operation, or a PC Tool operation can be used to select a certain scene. If a scene is registered for each type of measurement object or inspection, the line process can be changed simply by changing the scene when the measurement object or inspection changes. You can create up to 32 scenes.

Example:

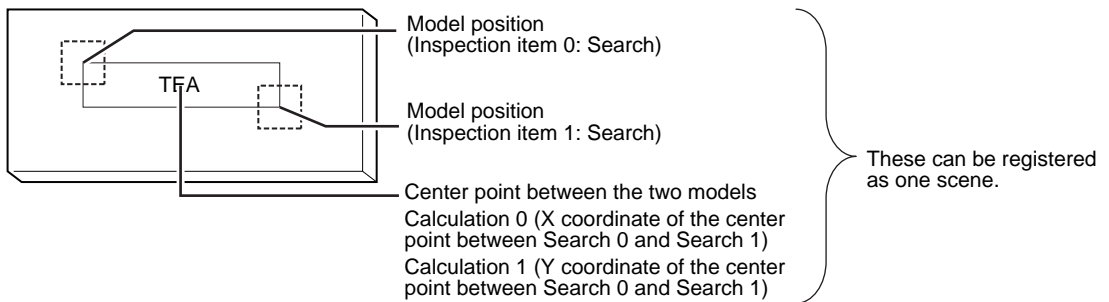

Line Process Changes:

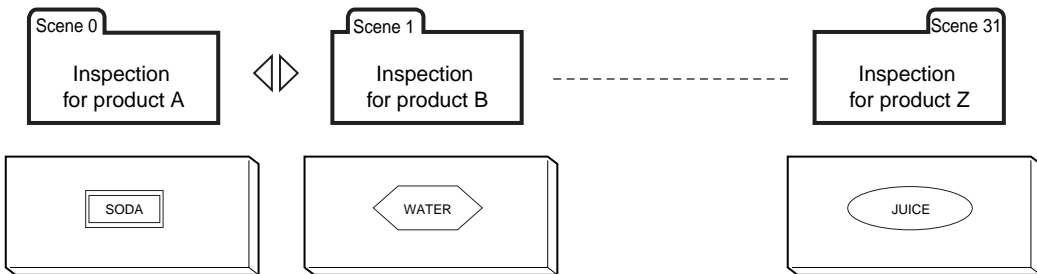

• Settings Included with Scenes

Settings, such as the camera image and inspection items, are changed when the scene is changed. The settings related to external I/O specifications that are included in the output settings and the system settings for the overall Sensor are used for all of the scenes. Refer to the following information for the data that is included in the scene data.

12-1 Function List p. 394

Creating New Scenes

The default scene number is 0. To create another scene, use the following procedure to create the scene and then make the settings.

- ▶ **Multiview Explorer: [Scene] (Right-click) – [Add] – [Scene data]**

- 1** This command creates a new scene. The newly added scene is displayed in the Multiview Explorer as “Scene Name (Scene Number).” You can register up to 32 scenes.

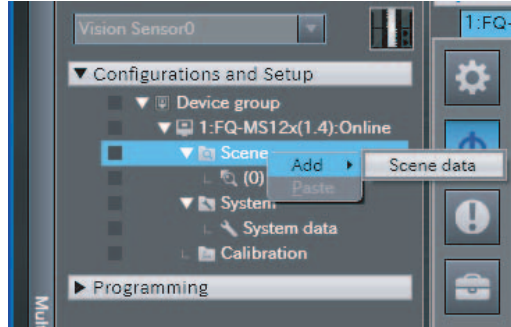

Note

The Touch Finder displays all scenes, including unregistered scenes. Therefore, the Touch Finder does not have a menu command to register new scenes.

Changing to a Different Scene

- ▶ **Multiview Explorer: [Scene] – Target scene (right-click [Edit])**

- 1** You can now modify the selected scene. Make the settings for the scene.

• Operation on the Touch Finder

Use the following menu command to display the Setup Display on the Touch Finder.

- ▶  **(Setup Mode) – [Select scene] – Target Scene – [Select]**

Changing Scene Names, Copying Scenes, and Deleting Scenes

► **Multiview Explorer: [Scene] – Scene Number (Right-click) – [Copy]/[Delete]/[Rename]**

- 1 To change the name, enter a new scene name in 15 alphanumeric characters or less. To copy a scene, select the number of the scene to copy.

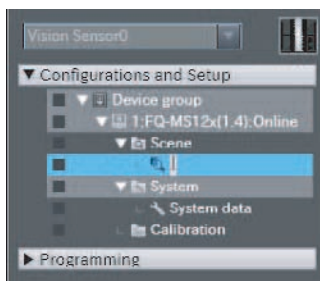

• Operation on the Touch Finder

Use the following menu command to display the Setup Display on the Touch Finder.

►  **(Setup Mode) – [Select scene] – Touch Target Scene – [Rename]/[Copy]/[Clear]**

Switching Scenes from an External Device

• Switching Scenes with an EtherCAT Command

 p. 255

• Switching Scenes with a PLC Link Command

 p. 288

• Controlling with Ethernet Inputs

 Command Details p. 308

Setting the Startup Scene

► **Multiview Explorer: [System] – [System data]**
→ **Edit Pane:  (Sensor setting) Icon – [Startup mode]**

The following items can be set.

Item	Purpose	Setting range
Startup mode	Select whether the startup scene number is set manually.	ON OFF (The scene number when the settings were saved will be the startup scene number. The startup mode is set to OFF in the default settings.)
Startup scene	Set the scene number to use at startup.	0 to 31

• Operation on the Touch Finder

Use the following menu command to display the Setup Display on the Touch Finder.

►  **(Setup Mode) – [Sensor settings] – [Startup settings]**

7-2 Display Functions

The procedures given in this section can be used to make the Sensor easier to use and the display easier to understand.

Image Zoom

The display can be zoomed in or out to make the image easier to see.

PC Tool

- ▶ **Multiview Explorer: [Scene] – Scene Number**
→ Edit Pane:  (Run) Icon – [Setup]

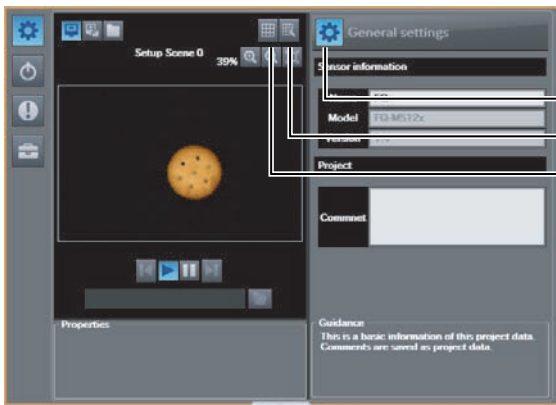

- Fits the image to the display size.
- Reduces the displayed image.
- Enlarges the displayed image.

Touch Finder

- ▶  (Setup Mode or Run Mode)



- Enlarges the display.
- Reduces the display.
- Fits the image to the display size.



Press [Back] to end setting the display.

Displaying a Live Image

You can display a live image to check the image that is input by the Sensor in realtime.

PC Tool

► **Edit Pane:**  (Online) Icon – [Setup]

- 1 Click the  (Camera image) Icon.
- 2 Click the  (Live) Icon.

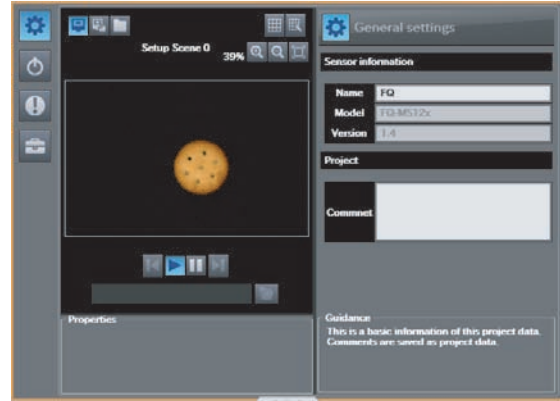

Note

You can select [Camera image] only when online.
If [Logging image] or [Image file] are selected, all images in the same folder are displayed in order.

Touch Finder

►  (Setup Mode)

- 1 Press  .
- 2 Press [Camera].
- 3 Press [Live].
- 4 Press the [Back] Button to return to the [Display] Display.



Displaying a Frozen Image

When you stop the live image, the image is no longer refreshed and the last image that was input is displayed.

PC Tool

► **Edit Pane:**  (Online) Icon – [Setup]

1 Click the  (Freeze) Icon.

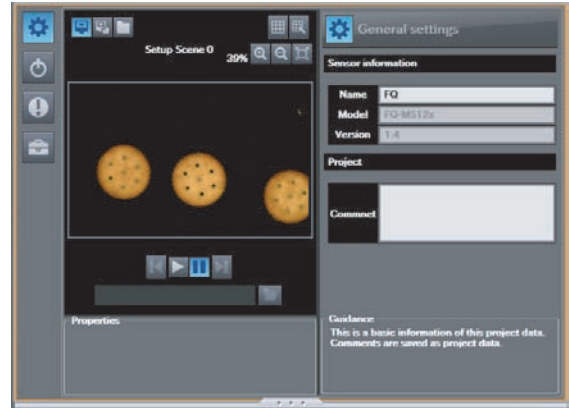

Touch Finder

►  (Setup Mode)

- 1** Press .
- 2** Press [Camera].
- 3** Press [Freeze].
- 4** Press the [Back] Button to return to the [Display] Display.





Displaying a Saved Image

You can display an image that was saved in internal memory in the Sensor, with the PC Tool, or in an SD card. This can be done to configure inspection items or to check measurements using saved images.

PC Tool

► **Edit Pane:**  (Online) Icon – [Setup]

1 Click the  (Logged image) Icon.

Click the  (Image file) Icon to use a file image.

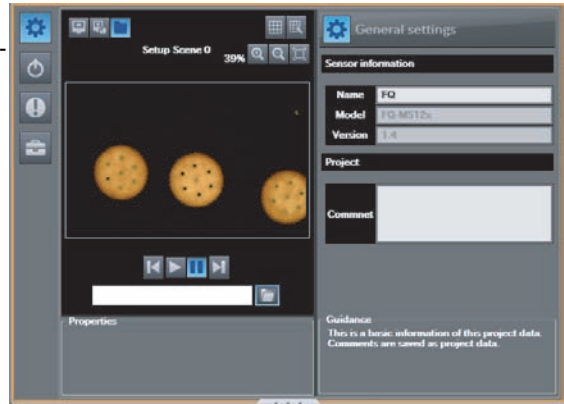

Note

You can select [Logging image] only when online and in Setup Mode.
You can select [Image file] only when offline or in Setup Mode.

Touch Finder

►  (Setup Mode)

- 1** Press .
- 2** Images in the Sensor's built-in memory: Press [Log].
Images on the SD card: Press [File].
- 3** Press the [Back] Button to return to the [Display] Display.



Note

Refer to the following information for the procedures to save images.

 Logging Measurement Data: p. 191

Updating the Display and Measurement Results Only for NG Measurement Results

In Run Mode, you can specify updating the display of the image and measurement results only when the measurement result is NG.

PC Tool

- ▶ **Multiview Explorer: [Device group] – Sensor name (Double-click)**
→ Edit Pane:  (Online) Icon – [Start monitor]

- 1 Click the  (Latest NG) Icon.



Note

This menu command can be selected only in Run Mode.

Touch Finder

- ▶  (Run Mode)

- 1 Press .
- 2 Press [Last NG image].
- 3 Press [Back].

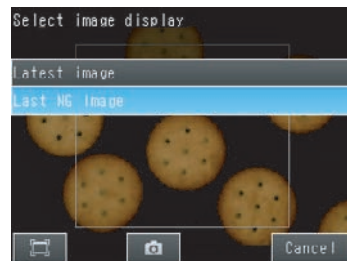

Change the following setting to display the last NG image after restarting.

▶  (Setup Mode or Run Mode) - [TF Settings] - [Startup display] - [Display update mode]

1 Press [Last NG image].



Note



If an operation to change the display is performed (e.g., if the display pattern is changed or the inspection item is changed) when displaying images for NG results is set, the display will change to refreshing the most recent measurement results and the most recent NG display will disappear. To ensure that you can check the NG results, log the NG results.



Checking Recent Measurement Trends (Recent Results Logging) p. 199

Displaying Guide Lines



• Displaying Guide Lines

- ▶ **Multiview Explorer: [Scene] – Scene number**
 - **Edit Pane:**  (Run) Icon – [Start monitor]
 - **Monitor Pane:**  (Switch the scale display on and off) Icon

- 1 A scale is displayed on the measurement image.



• Customizing Guide Lines

- ▶ **Multiview Explorer: [Scene] – Scene number**
 - **Edit Pane:**  (Run) Icon – [Start monitor]
 - **Monitor Pane:**  (Set the conditions of the scale display) Icon

- 1 **Set the scale type.**
You can select to display either a scale (marks) or scale lines.
- 2 **Set the color of the scale lines.**
- 3 **Set the scale display interval.**
This value is in pixels when not using calibration.

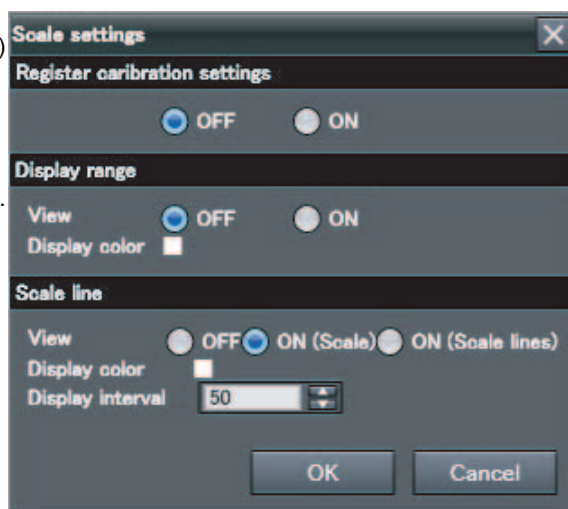

Note

This operation is only possible on the PC Tool. This operation is not possible on the Touch Finder.

Automatically Changing to the Display for Any Sensor with an NG Result (Touch Finder Only)

You can change the settings to automatically display the Sensor for which the measurement result is NG if more than one Sensor is connected.

- ▶  (Run Mode) – [Sensor monitor] – [NG sensor]

Hiding the Menu (Touch Finder Only)

You can hide the menu and display only the image on the Touch Finder to check the part of the image hidden behind the menu. If you press the icon again, the menu will be displayed.

- ▶  (Setup Mode or Run Mode)

Turning OFF the LCD Backlight (Touch Finder Only)

You can use Eco Mode to turn OFF the LCD backlight and reduce the power consumed by the Touch Finder whenever there is no operation on the Touch Finder for 30 seconds or longer. The LCD backlight will turn ON whenever any part of the touch panel is pressed.

- ▶  (Setup Mode or Run Mode) – [TF settings] – [LCD backlight] – [ECO mode]

Changing the LCD Brightness (Touch Finder Only)

The brightness of the LCD backlight can be changed to any of five levels.

- ▶  (Setup Mode or Run Mode) – [TF settings] – [LCD backlight] – [Brightness level]

7-3 Logging Measurement Data and Image Data

There are two ways to log data. Data can be temporarily saved in memory inside the Sensor (called recent results logging) or large amounts of data can be saved in external media, such as a computer or SD card (called file logging). The amounts of data that can be logged are given in the following table.

Logged data	Recent results logging ^{*1}	File logging
Measurement data (measured values and calculation results)	32,000 data items max. ^{*2}	Up to the capacity of the external memory
Image data (measured values and calculation results)	20 images max.	

*1: For recent results logging, the oldest data is overwritten when the maximum number of saved data items is exceeded.

*2: If more than one data item is logged at the same time, logging can be performed as long as the total number of data items in all logged data is 32,000 or less.

Logging All Data (File Logging)

Large amounts of measurement and image data can be saved in files in external memory (SD cards or computer).

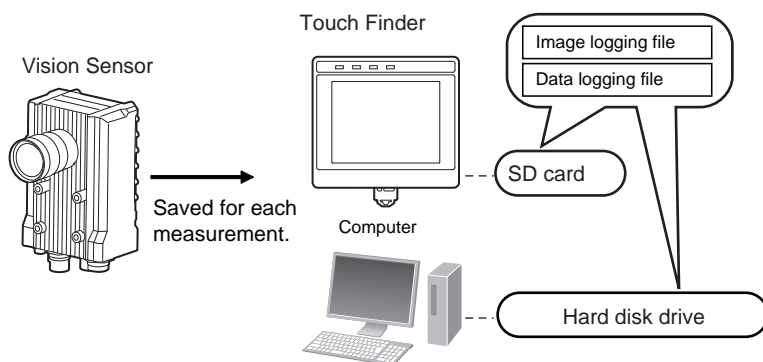

 System Configuration p. 26

Note

Only the data for the Sensor that is currently being displayed on the Touch Finder will be logged if more than one Sensor is connected.

If multiple Sensors are displayed or if the most recent NG Sensor is displayed, only the results of the Sensor that was displayed before changing to the monitor screen for the other Sensor will continue to be logged.

Simultaneous logging of the results of multiple Sensors is not possible.

Important

To implement stable file logging for an extended period of time (i.e., 1 hour or longer), use the Touch Finder. Observe the following precautions when implementing file logging from the PC Tool.

- There may be inconsistencies in the logging processing time.
- Logging processing may be interrupted if the load on the computer is too heavy.

Setting Logging Conditions

You can select the data to be logged.

- ▶ **Multiview Explorer: [System] – [System data]**
→ **Edit Pane:**  **(Log settings) Icon**

- 1 Select the data for which to change the logging parameters.

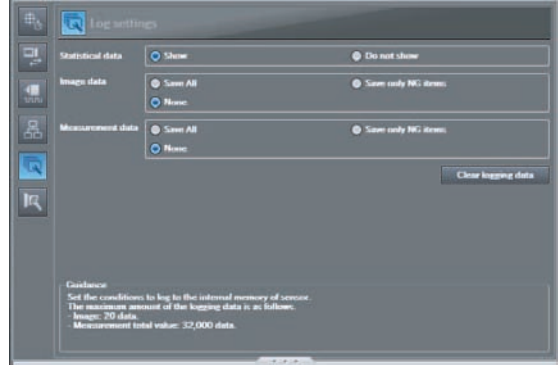

Item	Description
Image data	<ul style="list-style-type: none"> • Save all: All images will be logged regardless of the measurement results. • Save only NG items: Only images for which the overall judgement was NG will be logged. • None: No images will be logged. (Default)
Measurement data	<ul style="list-style-type: none"> • Save all: All measurement data (measured values and calculation results) will be logged regardless of the measurement results. • Save only NG items: Only measurement data (measured values and calculation results) for which the overall judgement was NG will be logged. • None: No measurement data (measured values and calculation results) will be logged. (Default)

Note

The logging parameter settings are the same for file logging and recent results logging.

• Operation on the Touch Finder

Use the following menu command to display the Setup Display on the Touch Finder.

- ▶ **[In/Out] – [Logging settings]**

Setting the Data To Log

With file logging, you can select what measurement data to log. This setting also applies to recent results logging.

 Selecting the Data To Log p. 201

Starting and Stopping Logging

After logging is started (i.e., set to ON), the specified image data and measurement data will be saved in the SD card in the Touch Finder or on the computer hard disk each time measurements are performed.

• PC Tool

► **Edit Pane:**  (Online) Icon – [Start monitor]

- 1 Start the monitor.
- 2 Click the  (Start the logging to the file) icon.



- 3 Select the check boxes for the items to log and then specify the location to store the log files and the name to save under.
- 4 Select the method to use to create log files for measurement data.

[Separate the logging file by scene]

Select whether to store the results for all scenes in a single file, or to separate the log files by scene or whenever the scene is changed.

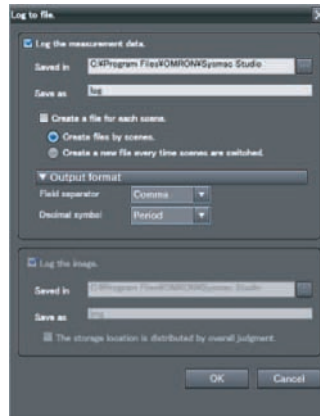

 Storage Methods and File Names for Logged Data p. 195

[Output Format]

The separator to use in the output file can be changed as shown below according to the external device.

Item	Separator
Field separator	None, comma (default), tab, space, or semicolon
Decimal symbol	None, point (default), or comma

Note

The record separator is always CR + LF.

5 Select the method to use to store image data in log files.

By default, image data is stored in the same folder. However, to separate the storage location by total judgement, select the [The storage location is distributed by total judgement] Check Box.

 Storage Methods and File Names for Logged Data p. 195

6 Click the [OK] Button.

7 Click the  (Stop logging) Icon to stop logging.

Note

To save logged data, you must first select either [All data is saved] or [Only NG data is saved] in the logging parameters.

 Setting Logging Conditions p. 192

• **Touch Finder**

▶  (Run Mode)

- 1** Press [Log to the file].
- 2** Press [Image data] or [Measurement data].
- 3** Press [ON] to start logging.
Press [OFF] to stop logging.
- 4** Press [OK].

Use the following menu command to change the output CSV file format.

▶  (Setup Mode or Run Mode) – [TF settings] – [File format]

 Format of Saved Data p. 202

Storage Methods and File Names for Logged Data

PC Tool

- Measurement Data

You can select one of the following three types of storage for measurement data.

- 1) Store the results for all scenes in a single file (default).
- 2) Store the results for each scene in a separate file.
- 3) Store the results for a separate file each time the scene is changed.

The setting method is described below.

 Starting and Stopping Logging p. 193

The file names depend on the selected storage method, as described in the following table.

Case	File name	Examples	Note
Storing the results for all scenes in a single file	<i>name.csv</i>	log.csv	The item name is inserted on the first line of the file. However, if the data output is different for each scene, the data name is inserted each time the scene is changed.
Storing the results for each scene in a separate file	<i>name_ScnXXX.csv</i> XXX: Scene number (000 to 031)	log_Scn000.csv log_Scn001.csv	The data name is inserted on the first line of each file. All results for a scene are stored in the same file.
Storing the results in a separate file each time the scene is changed	<i>name_ScnXXX(YYYY).csv</i> XXX: Scene number (000 to 031) YYYY: Serial number for each scene (0000 to 9999)	log_Scn000(0000).csv log_Scn001(0000).csv log_Scn000(0001).csv log_Scn001(0001).csv	The data name is inserted on the first line of each file.

Important

In the following cases, logging will not continue in the current file and the data will be saved in a new file.

- When the Sensor is changed
- When the Sensor is changed between Run and Setup Mode

File Format

Image data: Image data is saved in a special format for OMRON Vision Sensors. (The file name extension is IFZ.)

Measurement data: Measurement data is saved in the following CSV format.

- 1) → SensorType FQ-MSxxx-M-ECT
- 2) → SensorName abcdf
- 3) → Unit Information ID=search I1=*** Z0=Calculation

Data	Time	FIG ID	Scene No.	Judge	I0.CR0	I0.X0	...	I0.CR1	...	I1.Diff	Z0.D00	...
yyyy_mm_dd	hh:mm:ss	100	0	0	85	152		79		578	58	
yyyy_mm_dd	hh:mm:ss	150	0	-1	88	155		82		581	61	

Diagram annotations: Arrows point from labels 4) to 10) to the corresponding columns in the table. A red box highlights columns 5 through 10, and a blue box highlights columns 11 and 12.

Item	Format	Description	
1)	Sensor type	---	Gives the model of the Sensor that is logging the data.
2)	Sensor name	---	Gives the name of the Sensor.
3)	Unit Information	---	This is the identifier for the registered inspection item or calculation.
4)	Date	YYYY/MM/DD	This is the date that the measurement data was obtained from the Sensor.
5)	Time	hh:mm:ss	This is the time that the measurement data was obtained from the Sensor.
6)	FIG ID	---	This is the measurement ID information. When an encoder trigger is used, this is the value of the ring counter when the trigger was executed.
7)	Scene No.	---	Scene number
8)	Judge	---	Overall judgement 0: OK, -1: NG, -2: NC (not measured)
9)	Inspection item region	I(<i>inspection_item_number</i>).(measurement_item)(<i>detection_point</i>) Example: The correlation of the second detection point in a search for inspection item number 0 would be given as follows: I0.CR2	The data selected for logging in the [Logging settings] under [Scene] is output. If multiple results are detected, only the maximum number of data items that is set in the [Logging settings] are output.
10)	Expression region	Z0.D** Example: The fourth registered expression would be given as follows: Z0.D04	This is the expression results for each expression.

*1: The data and time are not recorded with the measurement data. Therefore, this is not the date that the measurement was executed. This is the date that the PC Tool or the Touch Finder obtained the data from the Sensor.

Ensuring That All Measurement Results Are Logged in External Memory

To ensure that all measurement results are actually saved, change the settings so that the BUSY signal remains ON until logging has been completed. During operation, do not input the next trigger until the BUSY signal turns OFF.

- ▶ **Multiview Explorer: [System] – [System data]**
→ **Edit Pane:  (I/O) Icon – [BUSY output] – [Output condition]**

Change the BUSY output parameter to [End data logging] or [Image logging].

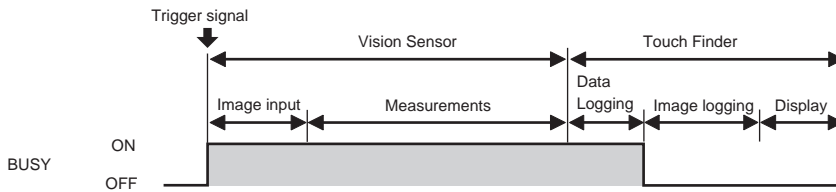

Note

- File logging cannot be used when performing continuous measurements.
- If you use the PC Tool, the logging time may vary by up to 100 ms depending on the application conditions of your computer.
- If logging data to an SD card, the write time depends on the amount of the available space on the SD card.
Reference value: For SDHC class 4, the time required to write image data is approx. 200 to 800 ms.

• Operation on the Touch Finder

Use the following menu command to display the Setup Display on the Touch Finder.

- ▶ **[In/Out] – [I/O setting] – [I/O terminals] – [BUSY output]**

Checking Recent Measurement Trends (Recent Results Logging)

The most recent measurement results can be logged inside the Sensor. Even if data is not logged in external memory, such as an SD card, trends in measurement results can be easily checked on the Touch Finder. However, if the power supply is turned OFF or the scene is changed, this data will be lost.

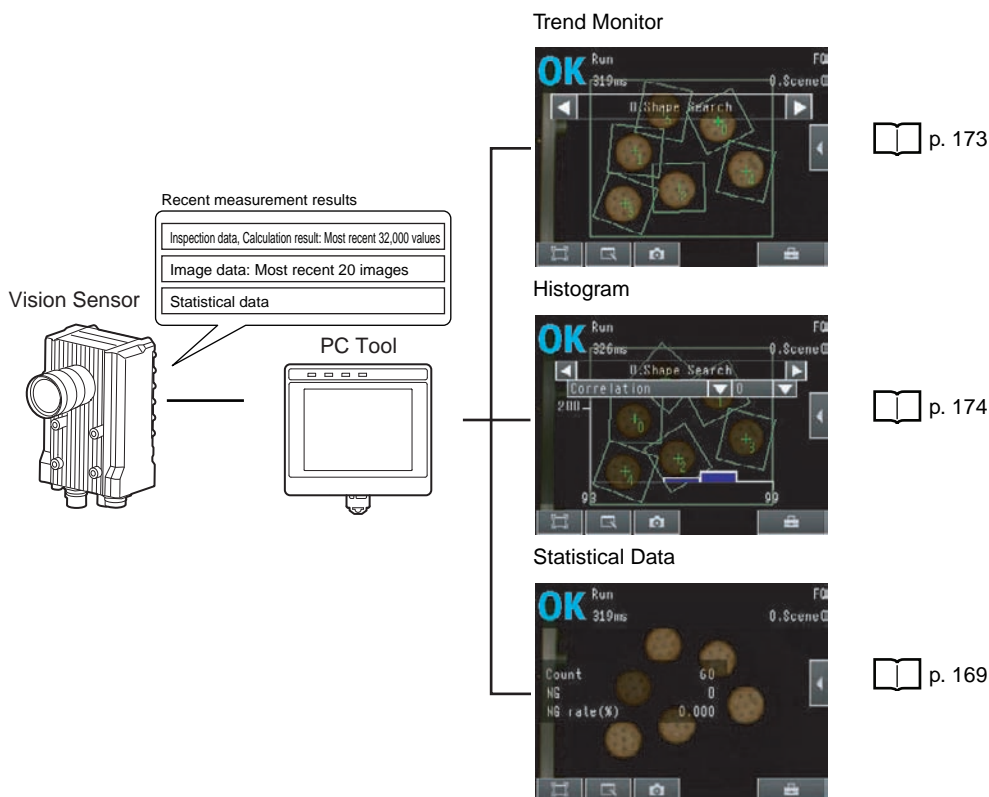

Note

With the PC Tool, you can only export recent results logging data as a CSV file. Use the Touch Finder to view all recent results logging data stored in the Sensor.

Setting Logging Conditions

Use the following procedure to set the statistical data, image data, and measurement data that will be logged. Some of these operations and settings are the same as for file logging.

Setting the Data To Log p. 192

Item	Description
Statistical data	Statistical data, such as the number of measurements, the number of NG overall judgements, and the NG rate, since the power supply was turned ON will be logged. <ul style="list-style-type: none"> • ON: Statistical data will be displayed (default). • OFF: Statistical data will not be displayed.
Image data	These are the same as for file logging.
Measurement data	

Selecting the Data To Log

With recent results logging, you can select what measurement data to log. This setting also applies to file logging.

 Selecting the Data To Log p. 201

Starting Logging

Logging will be started as soon as the data to log has been set. If the settings are saved, logging will start automatically the next time the power supply is turned ON.

Checking the Results of Logging

You can use trend monitors, histograms, or statistical data on the Touch Finder to check all logged data.

 p. 169

Note

With the PC Tool, you can also view any other parameters in addition to logged data by using the trend monitors and histograms.

Select the logged data to use as reference data. You can select up to three parameters for trend monitors, or a single parameter for histograms.

Checking Logged Images

Use the following menu command to check the measurement images.

▶ **(Setup Mode)** –  **(Logging image) Icon**

• Operation on the Touch Finder

Use the following menu command to display the Setup Display on the Touch Finder.

▶  **(Setup Mode or Run Mode)** – [] – [Log]

Selecting the Data To Log

Select the measurement data to log.

- ▶ **Multiview Explorer: [Scene] – Scene number**
→ **Edit Pane:**  **(Logging) Icon**

- 1 Select the measurement data to log.



• Operation on the Touch Finder

Use the following menu command to display the Setup Display on the Touch Finder.

- ▶ **[In/Out] – [Log settings] – [Measurement data] – [Select measurement data]**

Saving Logged Recent Results Data in a File

Although the logged recent results data will be deleted when the power supply is turned OFF, it can be saved in a file in external memory. The most recent 32,000 measurement values and the most recent 20 images will be saved.

PC Tool

- ▶ **(Setup Mode) Multiview Explorer: [Device group] – Sensor name (Double-click)**
→ **Edit Pane:**  **(Online) Icon – [Transfer or Save Data] – [Transfer from Sensor]**

Touch Finder

- ▶ **(Setup Mode) – [Save to file] – [Logging] Tab Page**

- 1 Select the data to save.

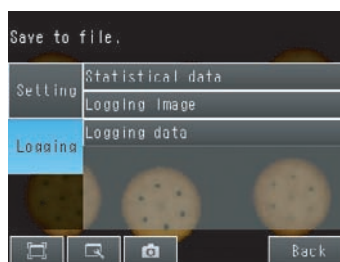

- 2 The following display will appear if **[Image data]** is selected.

Select whether to save the most recently logged image or to save all of the data that is logged in the Sensor.



The file storage locations and file format are given in the following table.

Item	Storage location	File name
Statistical data	sensor_name LOGDATA**1	YYYY_MM_DD-HH_MM_SS.CSV
Measurement data		Example: The following name would be used for data saved at 10:10:21 pm on March 10, 2010. 2010_03_10-22_10_21.CSV
Image data	sensor_name LOGIMAGE**1	YYYY_MM_DD-HH_MM_SS_NNN.IFZ Example: The following name would be used for data saved at 10:10:21 pm on March 10, 2010. 2010_03_10-22_10_21_000.IFZ * NNN is the serial number that is appended when multiple items are logged at the same time.

**1: Files are stored in the specified folder with the specified file name when the PC Tool is used.

• File Format

- Statistical data: The data is saved in the following CSV format.
Number of measurements, number of OKs, number of NGs, OK rate, NG rate (line feed code)
- Image data: Image data is saved in a special format for OMRON Vision Sensors. (The file name extension is IFZ.)
- Measurement data: Measurement data is saved in the following CSV format.

The same format is used to log the most recent results to files for the inspection item region and expression region of the file logging function.

 File logging format: Items 9 and 10 on p. 197

Note

- The saved recent measurement data cannot be loaded back into the Sensor and displayed on a trend monitor or histogram.
- The date and time are not recorded with the measurement data.
The file name is created from the time when the file is saved. It does not indicate when the measurement was made.

Important

The recent log data will be cleared if the scene is changed.

Changing the File Format

The output CSV file format can be changed as shown below according to the external device.

 Changing the File Format p. 193

Deleting Logged Data

The logged data will be deleted when the power supply to the Sensor is turned OFF or the scene is changed. You can also delete the logged data without turning OFF the power supply.

- ▶ **Multiview Explorer: [System] – [System data]**
→ Edit Pane:  (Logging) Icon – [Clear logging data]

1 Select [Clear logging data].

- **Operation on the Touch Finder**

Use the following menu command to display the Setup Display on the Touch Finder.

- ▶ **[In/Out] – [Log settings]**

7-4 Transferring and Saving Settings

The Sensor settings are saved in flash memory inside the Sensor. This section describes how to back up the settings in and restore them from an SD card or other external memory.

Backing Up Sensor Data to an External File

You can transfer various types of data from an online Sensor to an external file.

- ▶ **Multiview Explorer: [Device group] – Sensor name (Double-click)**
→ **Edit Pane:**  **(Support Software) Icon – [Sensor data] - [Save]**

1 Select the data to transfer.

• Operation on the Touch Finder

Use the following menu command to display the Setup Display on the Touch Finder.

- ▶  **(Setup Mode) – [Save to file] – [Settings] Tab Page**

Applicable Data

Data	Storage location ^{*1}	Description
Scene data (file name extension: SCN)	\sensor_name\SCN	The following data is backed up for each scene. <ul style="list-style-type: none">• Settings for all inspection items• Order of inspection items
Scene group data (file name extension: SGP)	\sensor_name\SGP	All scene data is backed up.
Sensor system data (file name extension: SYD)	\sensor_name\SYD	All system data in the Sensor is backed up. The system data is the same for all scenes.
Sensor all information (file name extension: BKD)	\sensor_name\BKD	All settings in the Sensor (all scene data, Sensor system data, and calibration group data) are backed up.
Touch Finder data ^{*2} (The file name extension is MSD.)	\sensor_name\MSD	All settings in the Touch Finder are backed up.
Calibration data (file name extension: CLB)	---	The calibration settings for each scene are backed up.
Calibration group data (file name extension: CGP)	---	The calibration settings for all scenes are backed up.

*1: This is the storage location when the Touch Finder is used to save data to an SD card. With the PC Tool, you can save data to any folder.

*2: This data can be saved only with the Touch Finder.

Transferring External Files to the Sensor

You can transfer externally saved settings to any Sensor that is connected online. The procedure for transferring this data is described below.

Note

 Changing between Online and Offline p. 374

You can use the following to transfer saved data to the Sensor.

- ▶ **Multiview Explorer: [Device group] – Sensor name (Double-click)**
→ **Edit Pane:  (Support Software) Icon – [Sensor data] - [Read]**

1 Select the data to transfer.

• Operation on the Touch Finder

Use the following menu command to display the Setup Display on the Touch Finder.

 **(Setup Mode) – [Load from file]**

Printing the Sensor Settings Data

You can print the Sensor scene and system data.

- ▶ **Multiview Explorer: [Device group] – Sensor name (Double-click)**
→ **Edit Pane:  (Support software) Icon – [Print]**

- 1 Click [Sensor parameter].
- 2 Select the data to print.
- 3 Click [Print].

7-5 SD Card Operations

With an FQ Vision Sensor, the following folders are automatically created in the SD card according to the data that is saved. The specified data is saved in files in these folders.

Storage folder*1	Data
\\sensor_name\SCN	Scene data (The file name extension is SCN.)
\\sensor_name\SGP	Scene group data (The file name extension is SGP.)
\\sensor_name\SYD	Sensor system data (The file name extension is SYD.)
\\sensor_name\BKD	All sensor data (The file name extension is BKD.)
MSD	Touch Finder data (The file name extension is MSD.)
\\sensor_name\LOGIMAGE	Image data (The file name extension is IFZ.)
\\sensor_name\LOGDATA	Statistical data and measurement data (The file name extension is CSV.)
\CAPTURE	Captured images (The file name extension is BMP.)

*1: For the PC Tool, data will be saved in the following folder: \\.\My Documents\OMRON FQ

Note

The PC Tool does not support SD card operations.

Inserting and Removing SD Cards

Inserting an SD Card in the Touch Finder

- 1** Open the cover to the SD card slot on the top of the Touch Finder.
- 2** Insert the SD card with the back of the SD card facing the front of the Touch Finder and press it in until it clicks into place.
- 3** Close the cover to the SD card slot.

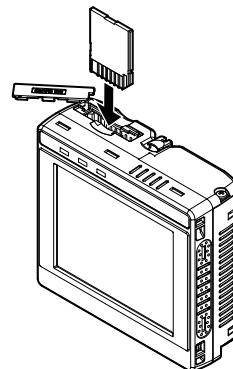
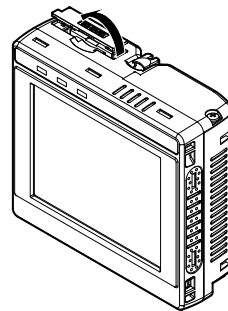

Removing an SD Card from the Touch Finder

- 1 Open the cover to the SD card slot on the top of the Touch Finder.
- 2 Press in on the SD card until you hear a click.
- 3 Pull out the SD card.
- 4 Close the cover to the SD card slot.

- Never remove the SD card while data is being saved or read. The data on the SD card may be corrupted.

Important

Do not restart or turn OFF the power supply to the Sensor or Touch Finder while a message is being displayed saying that data is being saved to or read from the SD card. The settings or system data may be corrupted.

Checking the Available Space on the SD Card

Before saving data to the SD card, use the following display to make sure that there is sufficient space available on the SD card.

- ▶  (Setup Mode or Run Mode) – [TF settings] – [SD card] – [SD card information]

The following information in the SD card inserted in the Touch Finder can be checked.



Formatting an SD Card

- ▶  (Setup Mode or Run Mode) – [TF settings] – [SD card] – [Format]

Press [Yes] to start formatting.



7-6 Convenient Functions for Operation

This section describes the functions that can be used during Sensor operation.

Setting a Password to Prevent Unwanted Changes

A password can be set to prevent unwanted changes to settings.

If a password is set, you cannot change from Run Mode to Setup Mode without entering the password.

Setting a Password

- ▶ **Multiview Explorer: [System] – [System data]**
 - **Edit Pane:  (Sensor settings) Icon – [Password settings]**
- 1** Set the password setting to [ON].
- 2** Enter a password that contains up to 15 characters.

• Operation on the Touch Finder

Use the following menu command to display the Setup Display on the Touch Finder.

- ▶  **(Setup Mode) – [Sensor settings] – [Password]**

Clearing the Password

- ▶ **Multiview Explorer: [System] – [System data]**
 - **Edit Pane:  (Sensor settings) Icon – [Password settings]**
- 1** Set the password setting to [OFF].

• Operation on the Touch Finder

Use the following menu command to display the Setup Display on the Touch Finder.

- ▶  **(Setup Mode) – [Sensor settings] – [Password settings]**

Entering the Password When Switching from Run Mode to Setup Mode

- 1** If a password is set and you try to change from Run Mode to Setup Mode, the following password entry display will appear.
 - ▶ **Edit Pane:  (Run) Icon – [Setup]**
- 2** Enter the password that you set.

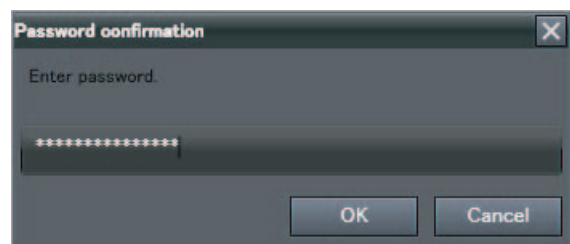

Important

- This password restricts only the operation to switch from Run Mode to Setup Mode. It does not restrict other operations.
- If you forget the password, contact your OMRON representative for the procedure to clear the password.
- The password is deleted when the Sensor is initialized.

- **Operation on the Touch Finder**

Use the following menu command to display the password entry display on the Touch Finder.

- ▶ **[Run Mode] – [Sensor settings]**

Capturing the Currently Visible Display (Touch Finder Only)

The current display on the Touch Finder can be captured and used in text files and other files on the computer. The captured images are saved in external memory as bit maps.

- ▶  **(Setup Mode or Run Mode)**

The image that is being displayed when the button is pressed is saved in external memory.

- **Storage Location and File Names**

Storage location	File name
√CAPTURE	YYYY_MM_DD-HH_MM_SS_MS.BMP Example: The following file name would be used for a screen capture executed at 10:10:21.350 PM on March 10, 2010. 2010_03_10-22_10_21_350.BMP

Important

Make sure an SD card is inserted in the Touch Finder before capturing display images.

7-7 Functions Related to the Sensor System Environment

Changing the Sensor Name

You can change the name of a Sensor.

- ▶ **Multiview Explorer:** [Device group] – Sensor name (Double-click)
→ Edit Pane:  (General settings) Icon – [Sensor information] – [Name]

1 Change the name of the Sensor.

• Operation on the Touch Finder

- ▶  (Setup Mode) – [Sensor settings] – [Information] –  – [Rename]

Note

From the Touch Finder, you can enter only alphanumeric characters for names.

Initializing the Sensor

- ▶ **Multiview Explorer:** [Device group] – Sensor name (Double-click)
→ Edit Pane:  (Support software) Icon – [Initialize]

• Operation on the Touch Finder

- ▶  (Setup Mode) – [Sensor settings] – [Initialize]

Restarting the Sensor

- ▶ **Multiview Explorer:** [Device group] – Sensor name (Double-click)
→ Edit Pane:  (Support software) Icon – [Restart]

• Operation on the Touch Finder

- ▶  (Setup Mode) – [Sensor settings] – [Restart]

Checking Versions

- ▶ **Multiview Explorer:** [Device group] – Sensor name (Double-click)
→ Edit Pane:  (Support software) Icon – [Current version]

• Operation on the Touch Finder

- ▶  (Setup Mode) – [Sensor settings] – [Information]

Displaying Help

You can view Help when you use the PC Tool.

- ▶ **Multiview Explorer: [Device group] – Sensor name (Double-click)**
→ **Edit Pane:**  **(Support software) Icon**

- 1** Click [Show help].

7-8 Functions Related to the Touch Finder System Environment

Switching the Display Language

Any of the following languages can be selected for display on the Touch Finder or the PC Tool.

Japanese or English

- ▶  (Setup Mode or Run Mode) – [TF settings] – [Language]

Press the language to be displayed.

Setting the Time on the Touch Finder

You can set the date and time.

- ▶  (Setup Mode or Run Mode) – [TF settings] – [Time settings]

Initializing the Touch Finder

- ▶  (Setup Mode or Run Mode) – [TF settings] – [Initialize]

Restarting the Touch Finder

- ▶  (Setup Mode or Run Mode) – [TF settings] – [Reset TF]

Checking the Touch Finder Battery Level

- ▶  (Setup Mode or Run Mode) – [TF settings] – [Battery remaining]

Important

- The battery level is displayed only for a Touch Finder with a DC/AC/battery power supply (FQ-MD31).
- The settings will be lost if the battery runs out while you are making the settings. If the battery level is low, save the settings and charge the battery immediately.

Correcting the Touch Screen Positions of the Touch Finder

Use this function to correct the touch screen positions if they are offset from the opposite position.

- ▶  (Setup Mode) – [TF settings] – [Touch panel calib]

Communications with External Devices

8-1 Connecting to Parallel I/O	214
8-2 EtherCAT Connection	228
8-3 PLC Link Connections	266
8-4 No-protocol Connections	296
8-5 Connecting with the Programmable No-protocol Communications	325
8-6 Using the Encoder Input	338

8-1 Connecting to Parallel I/O

Operation with Default Settings

This section describes the basic connections and signal flow with external devices. With the default settings, the Sensor operates in the following manner.

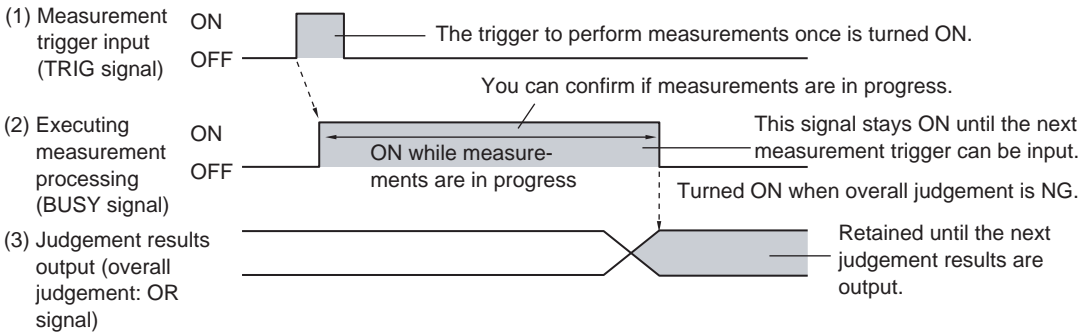
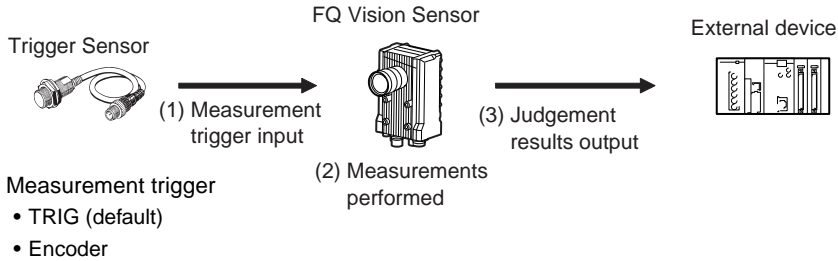

Important

- Create the ladder program to control the TRIG signal so that it does not turn ON while the BUSY signal is ON. If not, a TRIG input error will occur and the ERROR signal will turn ON.
- Operation When the Sensor Power Supply Is Turned ON

The BUSY signal will operate as shown below when the Sensor's power supply is turned ON.

Create the ladder program in the PLC or other external device so that the BUSY signal is ignored while it turns OFF, ON, and OFF again for up to 5 s after the power supply is turned ON.

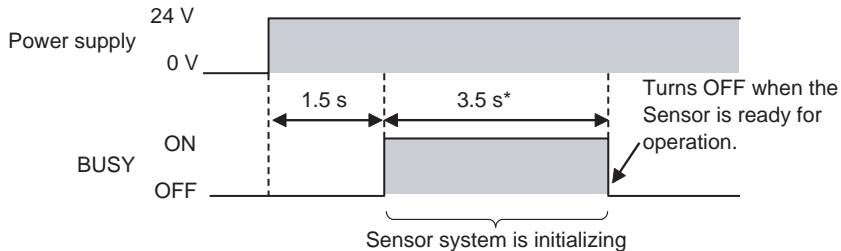

* Depends on the scene data.

Changing the Operation

The following settings can be selected depending on the system configuration and application.

Type of change	Change	Reference
Changing the type of measurement trigger	<ul style="list-style-type: none"> • TRIG (default setting) • EtherCAT triggers • Encoder trigger 	p. 79
Changing the output method of the judgement results	Obtaining individual judgement results	p. 218
	Adjusting the judgement output timing	p. 220
	Changing the judgement output ON conditions	p. 222
Changing the polarity of the BUSY output	Reversing the polarity of the BUSY signal	p. 222
Changing the BUSY output condition	Adjusting the end timing of the BUSY signal	p. 223
Changing the output conditions for the STGOUT signal	Changing the output polarity of the STGOUT signal, changing the output time of the STGOUT signal, and changing the output timing of the STGOUT signal	p. 225

Performing One Measurement for Each External Measurement Trigger

Performing One Measurement for Each External Trigger

A measurement trigger is input as the TRIG signal from a proximity sensor, PLC, or other external device. One measurement is performed when the TRIG signal turns ON.

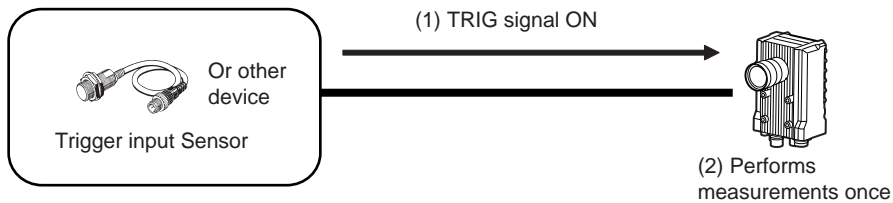

Wiring

Color	Signal	Description
Pink	TRIG	Trigger signal
Black	OUT0 (OR)	Overall judgement (default assignment)
Orange	OUT1 (BUSY)	Processing in progress (default assignment)

The signals shown at the left are used. Refer to the following information for signal wiring.



Wiring p. 40

Timing Chart (For Single Measurement with Parallel TRIG Signal)

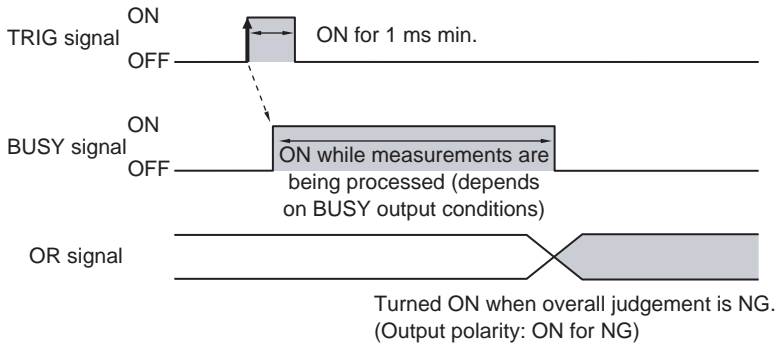

1. Turn ON the TRIG signal while the BUSY signal is OFF.
2. Measurement begins and the BUSY signal is turned ON during the measurement process.
3. When the measurement has been finished, the measurement result is output using an OR signal, and the BUSY signal is turned OFF. *1

*1: You can also set the signal to be turned OFF after data logging, image logging, or displaying results in the [BUSY output].

Sample Ladder Program

The following sample program is used to input a TRIG signal to perform a single measurement. A single measurement will be performed when W0.00 turns ON.

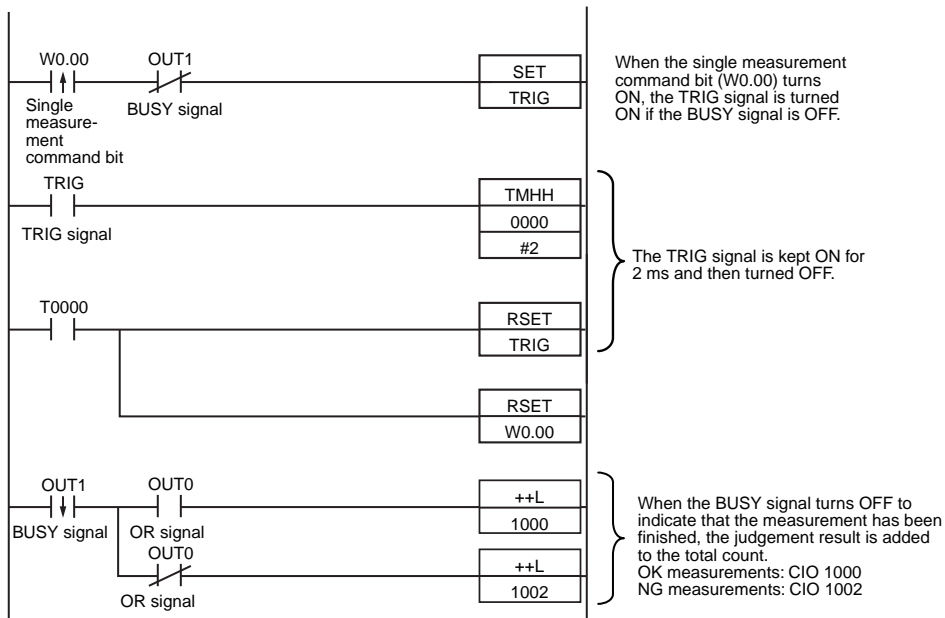

• I/O Signal Allocations

Signal	Address	
Output signals	OUT0 (OR signal)	CIO 0.00
	OUT1 (BUSY signal)	CIO 0.01
Input signals	TRIG	CIO 1.00

Performing a Measurement for the Encoder Input Value

A measurement is performed when the ring counter changes to a specified value.

Note



Controlling Measurement Timing with an Encoder Input p. 339

Outputting the Overall Judgement Result

When the results of the inspection items are judged, if even one individual judgement result is NG, the OR output signal is turned ON.

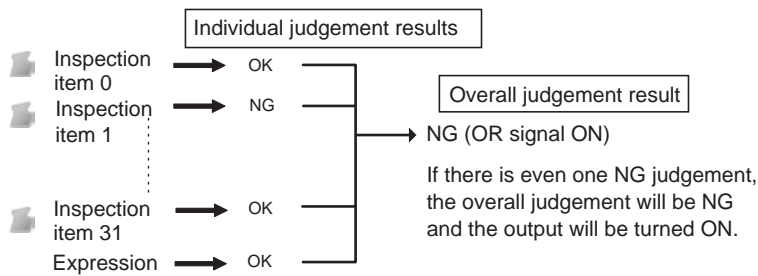

Note

You can also turn ON the overall judgement result output signal when all individual judgement results are OK.



Changing the Judgement Output ON Conditions p. 222

You can select whether to use the judgement result of one of the calculations (0 through 31) as the overall judgement.



Using Calculation Results without Applying Them to the Overall Judgement p. 146

Note

The timing for updating the OR signal and the ON time after judgement processing can be adjusted.



Adjusting the Judgement Output Timing p. 220

Output Using a Parallel I/O Cable

Use the following wiring for the output.

Color	Signal	Description
Black	OUT0 (OR)	Overall judgement (default assignment)

The signal shown at the left is used.
Refer to the following information for signal wiring.

 Wiring p. 40

Timing Chart (For Single Measurement with Parallel TRIG Signal)

The OR signal that is output is held until the next overall judgement is output.

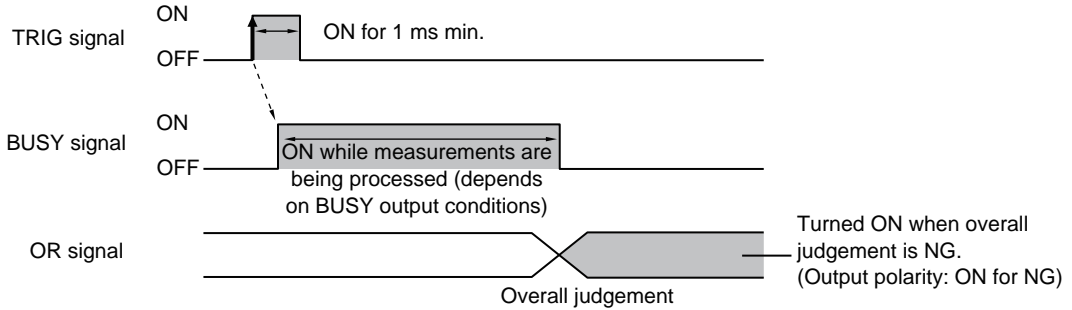

Outputting Individual Judgement Results

You can output the judgement results of individual inspection items (individual judgement signals OR0 to OR31) to an external device.

Note

The timing for updating the OR0 to OR31 signals and the ON time after judgement processing can be changed.

 Adjusting the Judgement Output Timing p. 220

Output Using a Parallel I/O Cable

As shown below, you can assign up to five outputs to terminals OUT0 to OUT4 to output to external devices.

Output terminal	Output signals that can be assigned
OUT0	<ul style="list-style-type: none"> OR (overall judgement) ... (default) OR0 (Item 0 judgement) to OR31 (Item 31 judgement)
OUT1	<ul style="list-style-type: none"> BUSY ... (default) OR0 (Item 0 judgement) to OR31 (Item 31 judgement)
OUT2	<ul style="list-style-type: none"> ERROR (error) ... (default) OR0 (Item 0 judgement) to OR31 (Item 31 judgement)
OUT3	<ul style="list-style-type: none"> SHTOUT (shutter output) ... (default) OR0 (Item 0 judgement) to OR31 (Item 31 judgement)
OUT4	<ul style="list-style-type: none"> STGOUT (strobe lighting output) ... (default) OR0 (Item 0 judgement) to OR31 (Item 31 judgement)

Note

You cannot assign signals to OUT3 or OUT4 from the Touch Finder.

Example: Signals are assigned to terminals OUT0 to OUT2 as shown below.

- OUT0: Inspection number 2 (OR2)
- OUT1: Inspection number 5 (OR5)
- OUT2: Inspection number 14 (OR14)

Color	Signal	Description
Black	OUT0 (OR2)	Outputs the judgement for OR2.
Orange	OUT1 (OR5)	Outputs the judgement for OR5.
Light blue	OUT2 (OR14)	Outputs the judgement for OR14.

The signals shown at the left are used.
Refer to the following information for signal wiring.



As described above, if terminals OUT0 to OUT2 are all assigned to individual judgement output signals, the BUSY signal and ERROR signal assigned as the default settings will no longer be output. Similarly, if you assign individual judgement output signals to terminals OUT3 and OUT4, the SHTOUT and STGOUT signals will not be output.

Use the following procedure to make the setting.

► **Multiview Explorer: [System] – [System data]**

→ **Edit Pane:**  **(I/O) Icon – [OUT allocation]**

- 1 Select [OR2 (Item 2 judgement)] for [OUT0].**
OR2 output signal will be assigned to OUT0.
- 2 Assign the other signals in the following manner.**
OUT1: OR5
OUT2: OR14

Timing Chart (For Single Measurement with Parallel TRIG Signal)

Output OR0 to OR31 signals are held until the next judgement output.

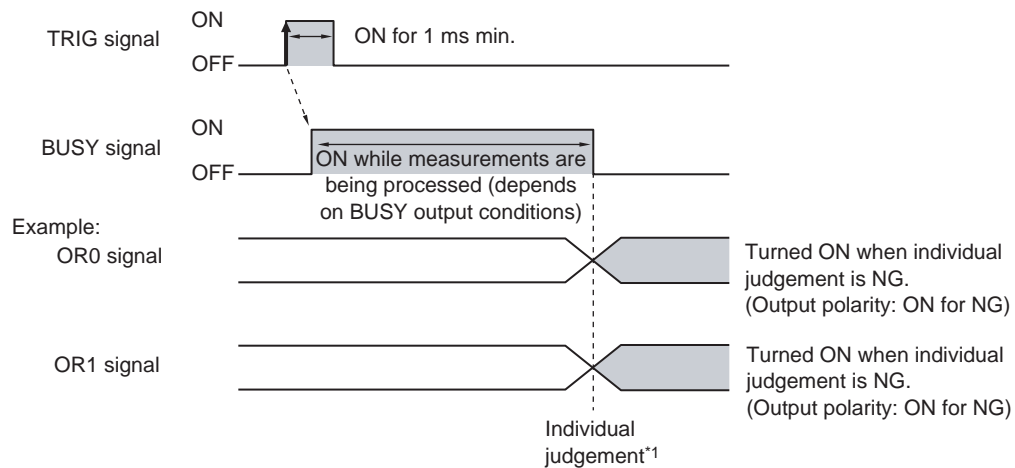

*1: The timing for updating the OR signal is when the measurement results are finalized, regardless of the output settings of the BUSY signal (BUSY output conditions).

• **Operation on the Touch Finder**

Use the following menu command to display the Setup Display on the Touch Finder.

► **[In/Out] – [I/O setting] – [I/O terminals]**

Adjusting the Judgement Output Timing

The output timing of the OR signal or OR0 to OR31 signals can be selected from two modes depending on the external device.

Selecting the OFF Timing

- Level output (default)

The status of the output OR signal is held until the next OR signal is output.

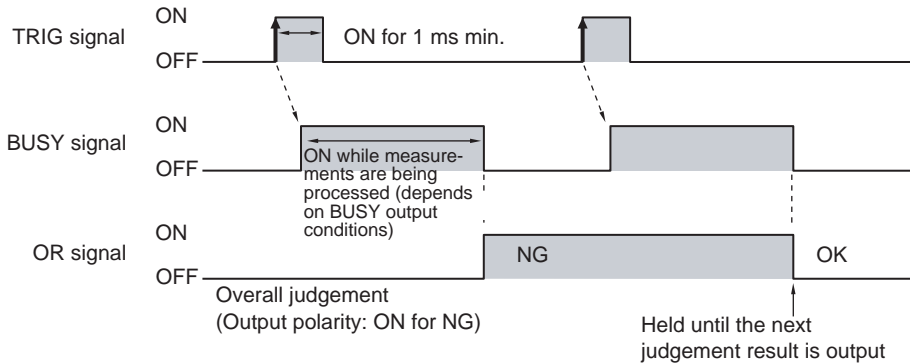

- One-shot output

The status of the output OR signal is turned OFF after a specified time has passed. (Setting range: 1 to 1,000 ms)

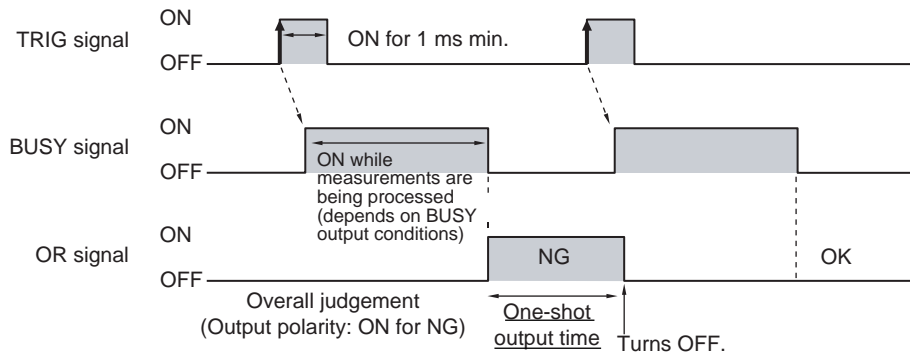

Delaying the Output Timing

When using one-shot output, the output timing of the OR signal can be delayed. (Setting range: 0 to 1,000 ms)

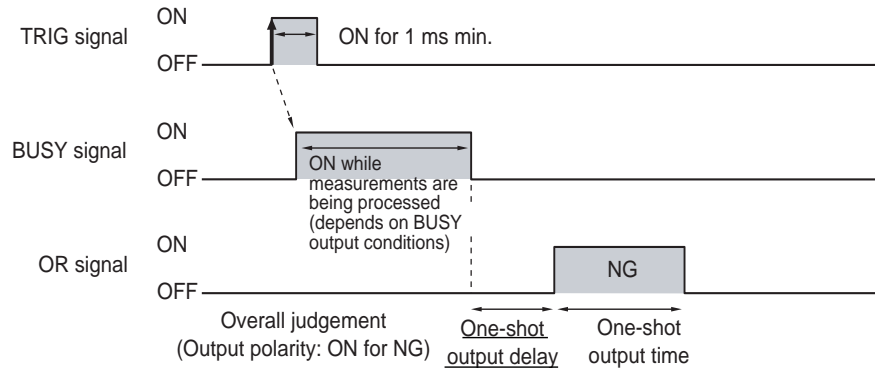

Settings

- ▶ **Multiview Explorer: [System] – [System data]**
→ **Edit Pane:  (I/O settings) Icon – [OR output settings]**

- 1** Select [One-shot output] for the [Output mode].
- 2** Set the [One-shot output delay].
- 3** Set the [One-shot output time].

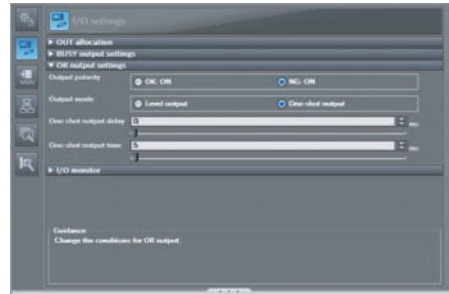

Item		Description
Output mode	One-shot output	After the measurement results are finalized, if the judgement output ON condition is met, the OR signal is turned ON for the one-shot output time. It is then turned OFF once the specified time has expired.
	Level output (default)	The judgement is output after measurement results are finalized and the ON/OFF status of the OR signal is held until it is changed for the next measurement result.
One-shot output delay		When one-shot output mode is selected, this parameter sets the delay from when a measurement is completed until when the OR signal turns ON. (Setting range: 0 to 1,000 ms)
One-shot output time		When one-shot output mode is selected, this parameter sets the time that the OR signal is ON. (Setting range: 1 to 1,000 ms)

Important

When a one-shot output is selected for the output mode, make the following value smaller than the trigger input period.

- One-shot delay time + One-shot output time

• Operation on the Touch Finder

Use the following menu command to display the Setup Display on the Touch Finder.

- ▶ **[In/Out] – [I/O setting] – [I/O terminals]**

Changing the Judgement Output ON Conditions

The ON conditions for the OR signal and the OR0 to OR31 signals can be set to turn ON the signals when the judgement results are OK or when they are NG. The default setting is when they are NG.

Settings

▶ **Multiview Explorer: [System] – [System data]**

→ **Edit Pane:**  **(I/O settings) Icon – [OR output settings] – [Output polarity]**

Item		Description
Output polarity	OK: ON	The output is turned ON if the judgement is OK. For the overall judgement, the output is turned ON if all judgements are OK.
	NG: ON (default)	The output is turned ON if the judgement is NG. For the overall judgement, the output is turned ON if even one judgements is NG.

• Operation on the Touch Finder

Use the following menu command to display the Setup Display on the Touch Finder.

▶ **[In/Out] – [I/O setting] – [I/O terminals] – [Output Polarity]**

Changing the BUSY Signal Output Condition

Changing the Polarity of the BUSY Output

The Sensor turns ON the BUSY output signal during measurements, command execution, and other processing to indicate that a measurement trigger cannot be received. You can change the BUSY signal output conditions.

Settings

▶ **Multiview Explorer: [System] – [System data]**

→ **Edit Window:**  **(I/O) Icon – [BUSY output settings] – [Output polarity]**

Item		Description
Output polarity	BUSY: ON (default)	The BUSY signal is ON while the Sensor is processing data.
	READY: ON	The BUSY signal is ON while the Sensor can receive a trigger signal.

Important

All timing charts in this manual show the operation of the BUSY signal at the default setting. If you change the polarity of the BUSY signal, take this into consideration when reading the timing charts.

• Operation on the Touch Finder

Use the following menu command to display the Setup Display on the Touch Finder.

▶ **[In/Out] – [I/O setting] – [I/O terminals]– [BUSY Polarity]**

Adjusting the End Timing of the BUSY Output

The end timing of the BUSY signal can be changed.

Settings

► **Multiview Explorer: [System] – [System data]**

→ **Edit Window:  (I/O settings) Icon – [BUSY output] – [Output condition]**

Item	Description	
Output condition	Measurement completion (default)	The BUSY signal turns OFF when the measurement is completed.
	Data logging completion	The BUSY signal turns OFF when data logging is completed.
	Image logging completion	The BUSY signal turns OFF when image logging is completed.
	Result display completion	The BUSY signal turns OFF when the result display is completed.

• Operation on the Touch Finder

Use the following menu command to display the Setup Display on the Touch Finder.

► **[In/Out] – [I/O setting] – [I/O terminals] – [BUSY output]**

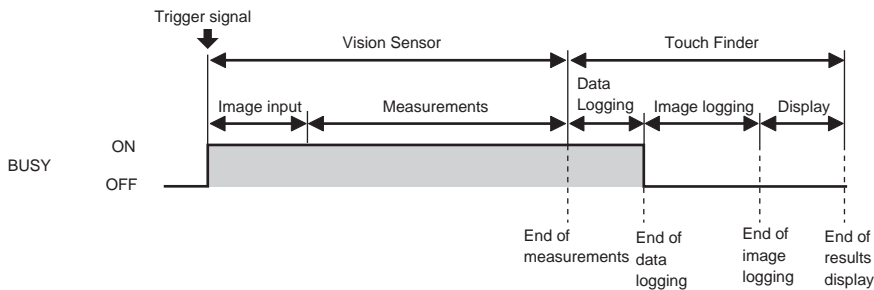

Turning the ERROR Signal OFF

The ERROR signal can be turned OFF with command inputs from an external device without connecting the Touch Finder.

Turning OFF the ERROR Signal

The ERROR signal turns ON when an error occurs. After you remove the cause of the error, turn OFF the ERROR signal using one of the following methods.

Method 1

Turn the error clear signal ON from an external device, such as a PLC.

Method 2

Input the measurement trigger again.

For example, turn the TRIG signal OFF and then ON.

The ERROR signal will turn OFF when measurement is executed correctly.

Note

This function can be used in Run Mode only.

Clearing Errors Using a Parallel I/O Cable

Color	Signal	Description
Red/White	IN0	Clear error input terminal
Orange	OUT1 (BUSY)	Processing in progress (default assignment)
Light blue	OUT2 (ERROR)	ERROR signal (default assignment)

The signals shown at the left are used. Refer to the following information for signal wiring.

 I/O Signal Wiring p. 40

The timing chart to clear errors through a parallel TRIG signal is given below. Turn ON the IN0 signal while the BUSY signal is OFF to clear the error.

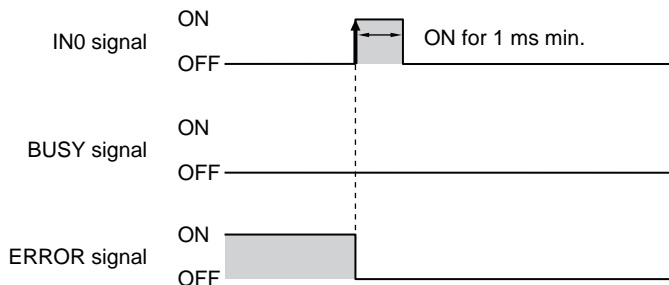

Monitoring the Signal I/O Status

You can check if the I/O connections are working normally.

- ▶ **Multiview Explorer: [System] – [System data]**
→ **Edit Pane: [I/O settings] – [I/O monitor] – [Monitoring start]**

- 1** The I/O status of the external devices will be displayed.
- 2** Press the output signal and change the output status. Then, check the connection with the external device.

Input Signals (TRIG, ERRCLR, and ENCCLR)
Signals that are displayed in red are currently being input from the external devices to the Sensor.

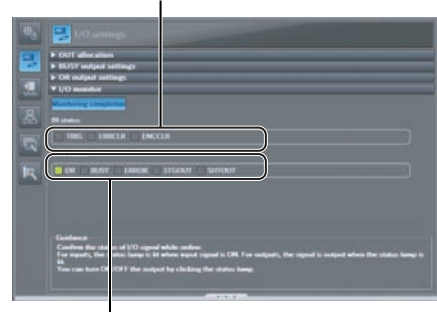

Output Signals (OR, BUSY, ERROR, STGOUT, and SHTOUT)
Signals that are displayed in red are currently being output from the Sensor to the external devices. You can turn the signals ON and OFF by clicking the display to test the outputs.

• Operation on the Touch Finder

Use the following menu command to display the Setup Display on the Touch Finder.

- ▶ **[In/Out] – [I/O monitor] – [I/O monitor]**

Changing the STGOUT Signal Output Conditions

You can change the output polarity, the output time, and the output timing of the STGOUT signal. The STGOUT signal controls the external lighting.

Changing the Output Polarity of the STGOUT Signal

- ▶ **Multiview Explorer: [Scene] – Scene number**
→ **Edit Pane: [Image] Icon – [Setup menu] – [Lighting control] – [Strobe output polarity]**

- 1** You can set the control operation for external lighting for the status of the STGOUT signal.

Item	Description
Positive (default)	The STGOUT signal is turned ON to light the external lighting.
Negative	The STGOUT signal is turned OFF to light the external lighting.

- **Operation on the Touch Finder**

Use one of the following menu commands to display the Setup Display on the Touch Finder.

- ▶ **[Image]** – **[Camera setting]** – **[▶]** – **[Lighting control]**

Changing the Output Time of the Strobe Output Signal

- ▶ **Multiview Explorer: [Scene] – Scene number**
→ **Edit Pane: [Image] Icon – [Setup menu]**

- 1 Connect the Sensor to the external lighting with the STGOUT signal.**
- 2 Click [Lighting control].**
- 3 Change the strobe output time to adjust the brightness.**

Increasing the strobe output time beyond the shutter speed will not increase the brightness any further.

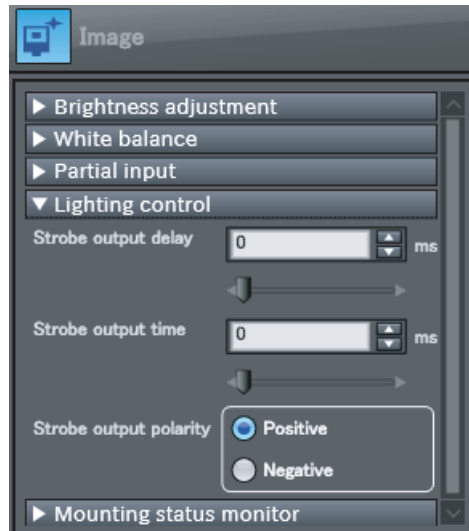

- **Operation on the Touch Finder**

Use the following menu command to display the Setup Display on the Touch Finder.

- ▶ **[Image]** – **[Camera setting]** – **[◀]** – **[Lighting control]**

Changing the Output Timing of the STGOUT Signal

You can offset when the external lighting is turned ON after the STGOUT signal is input.

► **Multiview Explorer: [Scene] – Scene number**

→ **Edit Pane:**  (Image) Icon – [Setup menu] – [Lighting control]

- 1 In [Strobe output delay], enter the delay time for turning ON the external lighting after the STGOUT signal is input.

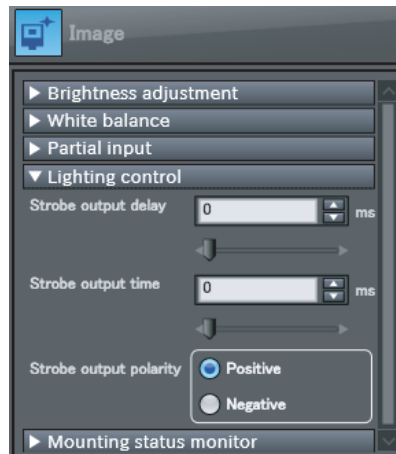

Important

When the strobe polarity is set to “Negative,” a delay of about 200 to 300 μs occurs from when the TRIG signal is input until the STGOUT signal goes low. When a high-speed shutter is used, use the Controller with the strobe polarity set to “Positive.”

Strobe Trigger Output Signal (STGOUT)

The SHTOUT signal turns ON in sync with the trigger input signal from an external device.

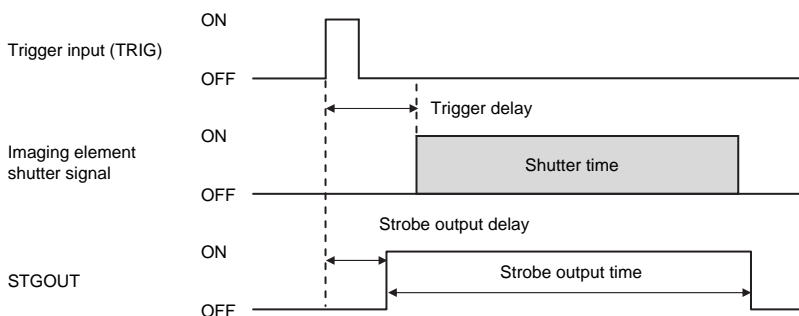

Strobe output polarity: Positive

Resetting the Ring Counter Value

You can use the encoder counter reset signal (EFC_RST) to reset the ring counter value.

Important

The encoder is reset immediately when the encoder counter reset signal turns ON. Stop the encoder before you reset it. If you turn ON the encoder counter reset signal while the encoder is rotating, the encoder may be reset a few pulses from the intended location.

8-2 EtherCAT Connection

Overview of EtherCAT Networks

EtherCAT (Ethernet Control Automation Technology) is a high-performance industrial network system based on Ethernet system and can realize faster and more efficient communications.

Each node achieves a short communications cycle time by transmitting Ethernet frames at high speed.

Furthermore, even though EtherCAT is a unique protocol, it offers excellent general-purpose applicability. For example, you can use Ethernet cables because EtherCAT utilizes standard Ethernet technology for the physical layer. And the effectiveness of EtherCAT can be fully utilized not only in large control systems that require high processing speeds and system integrity, but also in small and medium control systems.

Features of EtherCAT

EtherCAT has the following features.

- Extremely high-speed communications with speed of 100 Mbps

It dramatically shortens the I/O response time from generation of input signals to transmission of output signals. By fully utilizing the optimized Ethernet frame bandwidth to transfer data using a high-speed repeat method, it is possible to efficiently transmit a wide variety of data.

- Extremely High Compatibility with Ethernet

EtherCAT is an open network with extremely high compatibility with conventional Ethernet systems.

Structure of EtherCAT

EtherCAT does not send data to individual slave nodes on the network, instead, it passes Ethernet frames through all of the slave nodes.

When frame passes through a slave node, the slave node reads and writes data in the areas allocated to it in the frames in a few nanoseconds.

Ethernet frames sent from the EtherCAT Master Unit go through all the EtherCAT Slave Units without stopping on the way. Once they reach the final Slave Unit, they are sent back from the final Slave Unit, pass through all Slave Units again, and return to the EtherCAT Master Unit.

With this structure, EtherCAT secures high-speed and real-time data transmission.

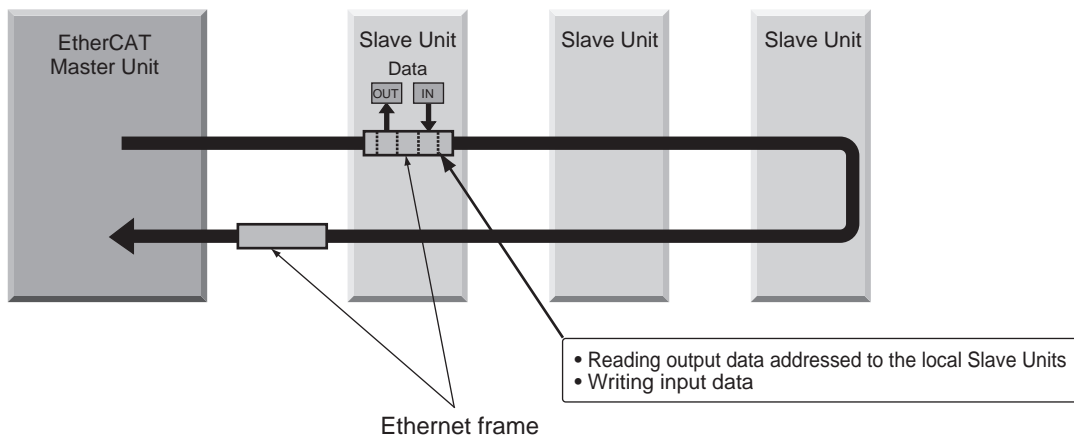

It is the "EtherCAT telegram" stored directly in an Ethernet frame that exchanges data regularly between the EtherCAT Master Unit and Slave Units.

Each "EtherCAT telegram" is configured with telegram header (data length, including address of one or more Slave Units, etc.), data, working counter (check bit).

When an Ethernet frame is compared to a "train", an EtherCAT telegram can be considered as "railway car."

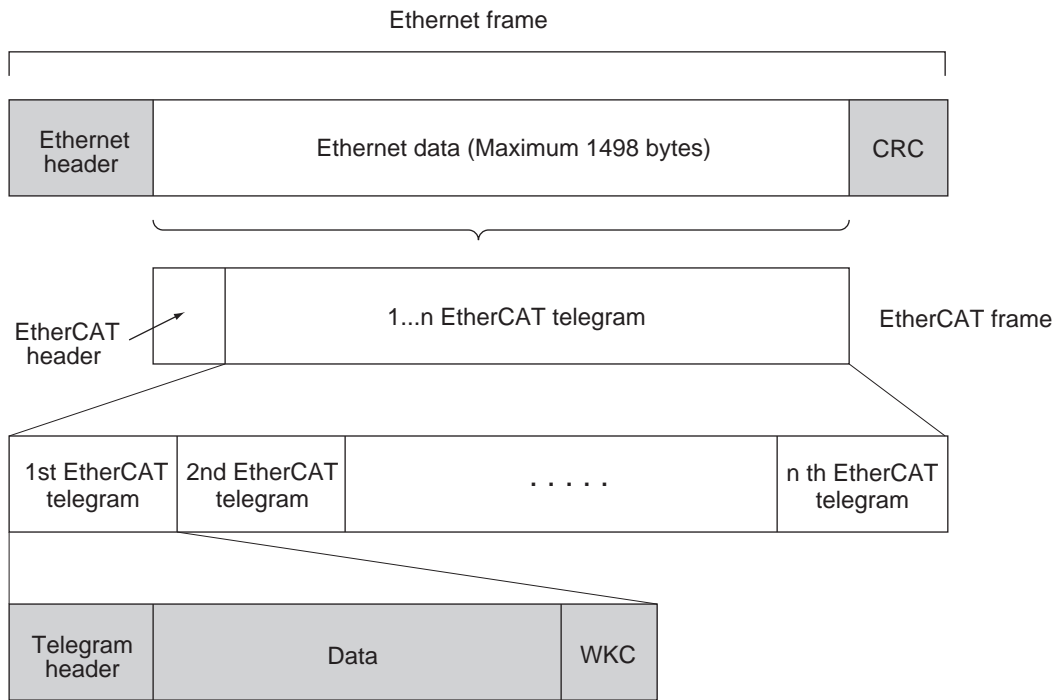

WKC : Working counter

Communications Types of EtherCAT

EtherCAT provides the following two types of communication functions.

PDO communications are always updating data per communication cycle on EtherCAT, while SDO communications are processed in between those updates.

- Process data communications functions (PDO communications)

This communication function is used to transfer process data in real time in a fixed-cycle.

By mapping logical process data space to each node by the EtherCAT Master Unit, it achieves fixed-cycle communications among the EtherCAT Master Unit and Slave Units.

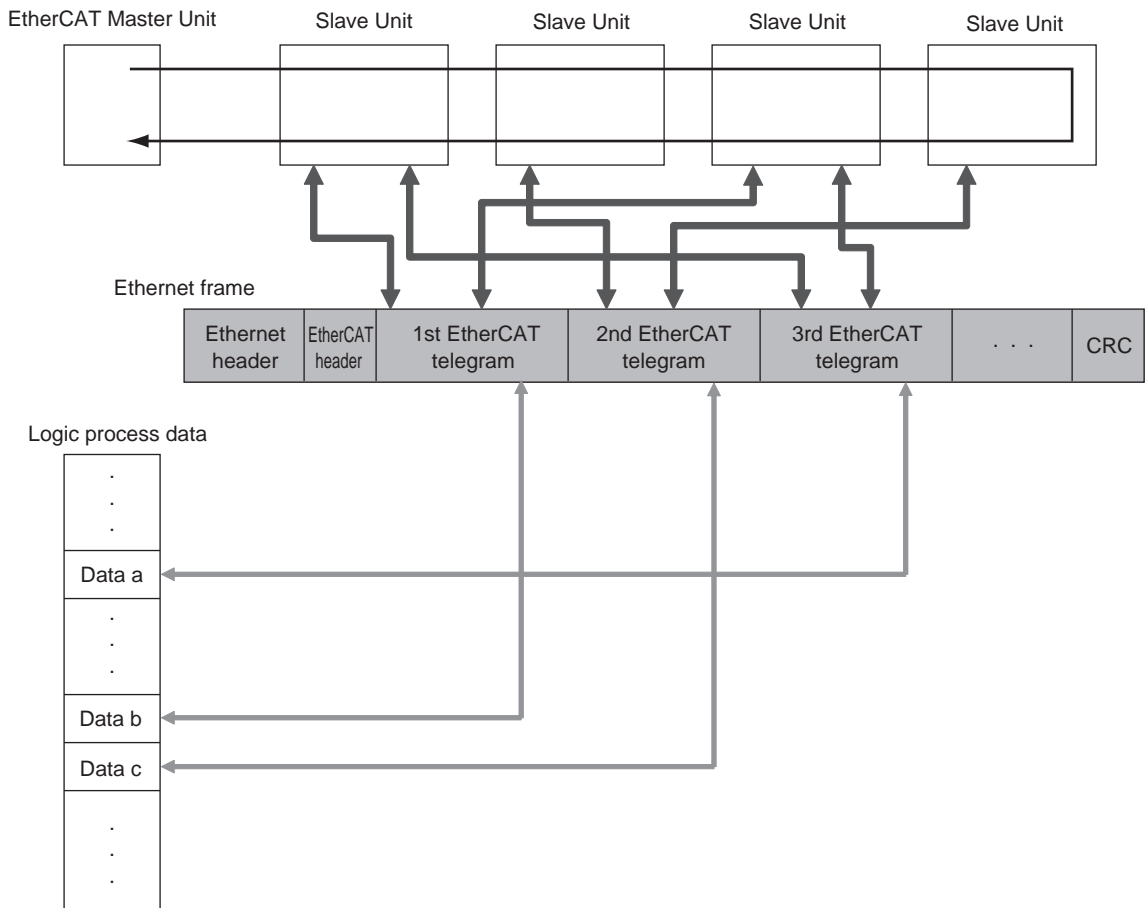

● Mailbox communications functions (SDO communications)

It refers to message communications.

At any timing, the EtherCAT Master Unit transmits commands to Slave Units and the Slave Units return responses to the EtherCAT Master Unit.

It performs the following data communications:

- Read and write process data

FQ-M Communications for an EtherCAT Connection

You can use EtherCAT to communicate between the EtherCAT master and the Vision Sensor to control operation with command/response communications or to output data after measurements. With an NJ-series Controller-series CPU Unit and an EtherCAT connection, you can use the Sysmac Studio Standard Edition to register the FQ-M in the EtherCAT slave configuration in the Edit Network Configuration Tab Page. Refer to the *Sysmac Studio Version 1 Operation Manual* (Cat. No. W504) for details on registering slaves.

Important

If you enable EtherCAT output for EtherCAT communications, PLC link communications will be disabled.

 Enabling EtherCAT Outputs p. 234

● Command/Response Communications

EtherCAT communications uses process data objects (PDOs) to perform cyclic PDO communications. Command/response control signals are handled by storing control commands from the master in the Vision Sensor and storing responses from the Vision Sensor to the master in the Controller's I/O ports or I/O memory.*1 This allows you to control the operation of the Vision Sensor (e.g., perform continuous measurements or change the scene) without using communications instructions.

*1: NJ-series Controllers use I/O ports. CJ-series PLCs use I/O memory. The following description applies to NJ-series Controllers.

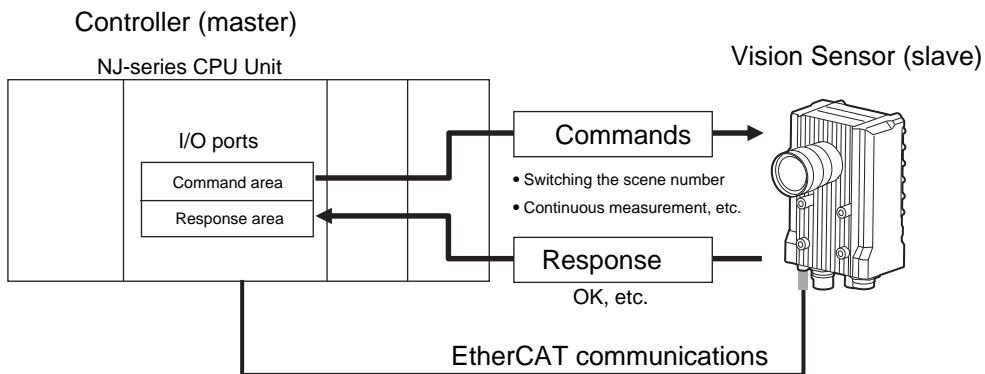

After you write a control command to an I/O port, such as Vision Command, you can turn ON the Control Command Execution (EXE) Bit to send the control command to the Vision Sensor via EtherCAT. The Vision Sensor executes the control command and sends a response back to the Controller via EtherCAT. The Controller stores the response in an I/O port, such as Vision Response.

● Data Output after Measurements

Immediately after executing measurements, the Vision Sensor will automatically output the data for the measurements that are specified for output in advance to the Vision Data Output I/O ports in the output area. This enables you to easily transfer the measurement results data for inspection items to the Controller. When handshaking is enabled, the data can be output from the Vision Sensor only when the condition to receive that data are met at the Controller.

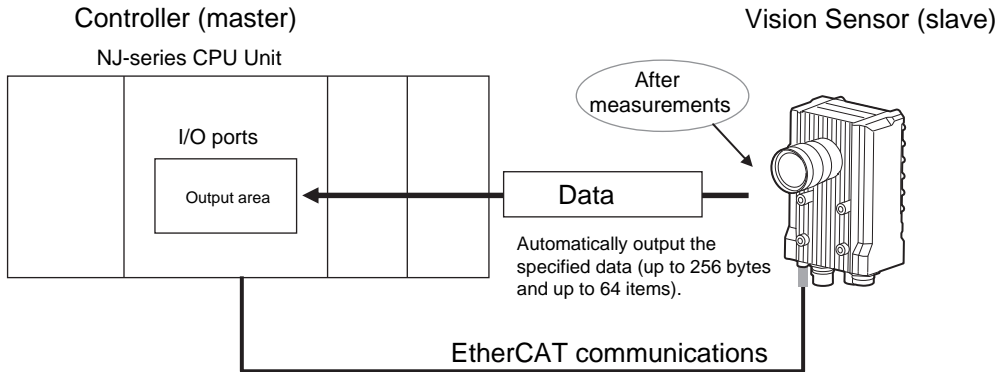

You must specify in advance the data to output after measurement is performed (up to 256 bytes and up to 64 items). After a single measurement or continuous measurements, the data is automatically stored in the I/O port in the Data Output Area of the Controller via EtherCAT. Refer to the following page for the data output setting method.

 Setting Up EtherCAT Communications p. 234

EtherCAT communications uses I/O ports in the following four areas to perform communications. The I/O ports in the Sysmac Error Status Area are used only when connected to a NJ-series CPU Unit.

Command/response communications	1. Command area I/O port	These are the I/O ports to which you write control commands for the Vision Sensor to execute.
	2. Response area I/O port	These are the I/O ports to which the Vision Sensor writes the results of control commands executed from the Command Area.
Data output after measurements	3. Output area I/O port	These are the I/O ports to which the Vision Sensor writes output data for measurements after an inspection is performed.
Error status	4. I/O ports in Sysmac Error Status Area	These are the I/O ports to which the Vision Sensor writes error status.

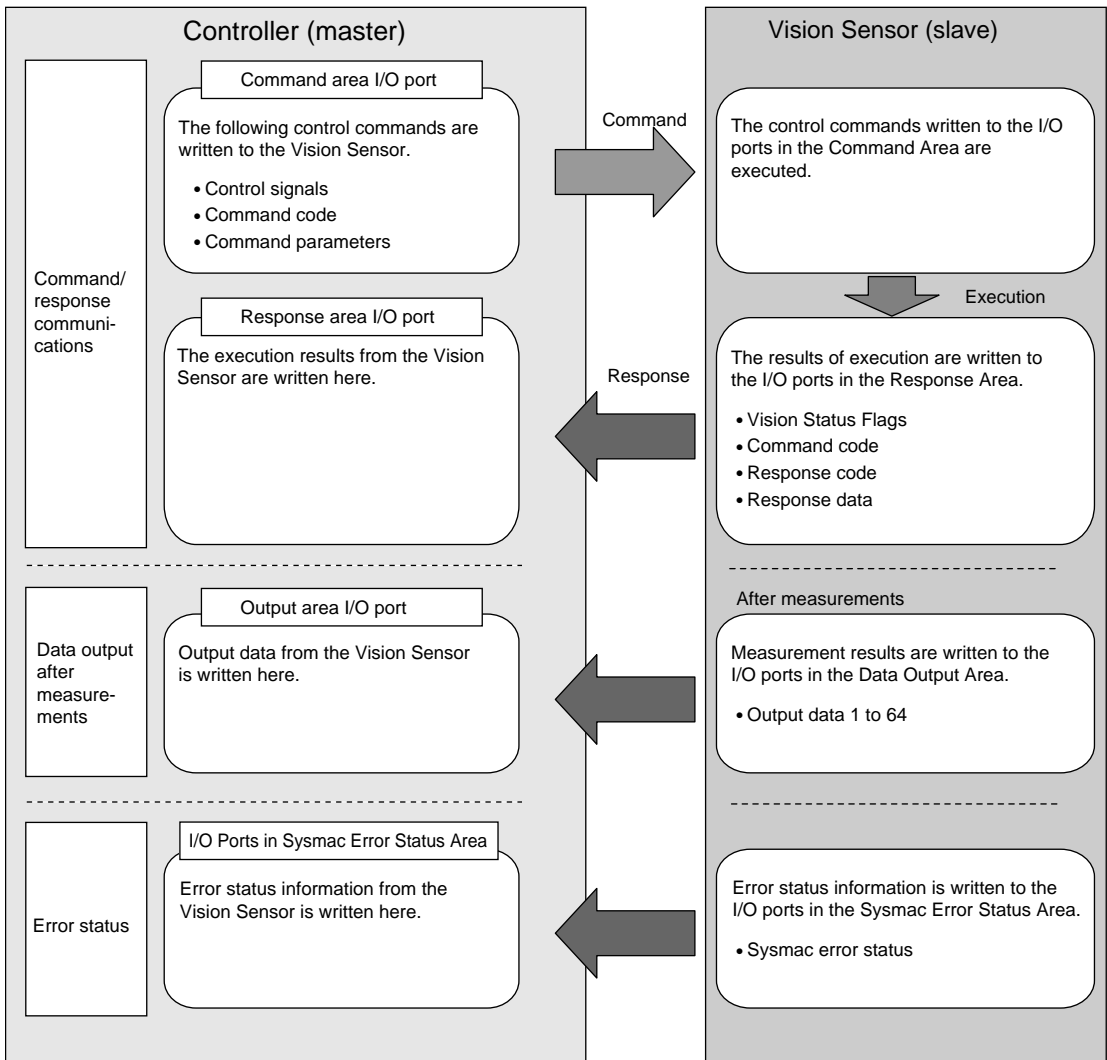

Setting Up EtherCAT Communications

Initial Settings for EtherCAT Communications

You must set the data output size, output handshake, and output controls to perform EtherCAT communications.

- **Multiview Explorer: [Device group] – Sensor name – [System] – [System data] (Double-click)**
 → **Edit Pane:**  **[EtherCAT] Icon**

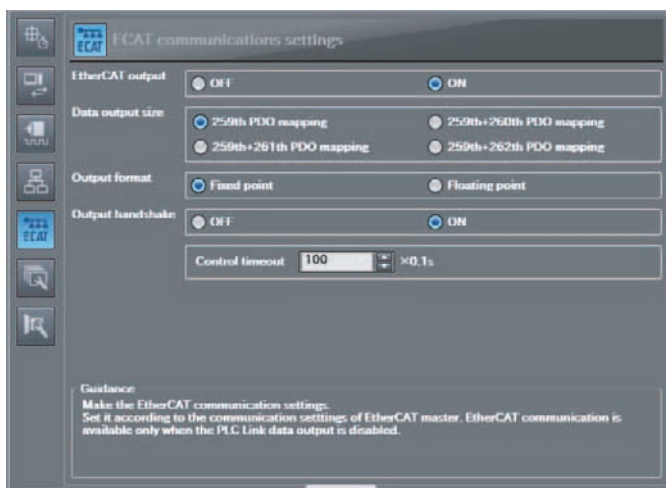

The following items can be set.

Item	Description	Setting range
EtherCAT output	Specify whether to enable EtherCAT communications. If you enable EtherCAT communications, PLC link communications will be disabled. Select [-] for  [Ethernet communication] – [EtherCAT/PLC link data output setting] – [Communication method].	OFF or ON
Data output size	Select the size of the output area. Allows you to change the size of data to output at one time.	<ul style="list-style-type: none"> • 259th sending PDO mapping: 32 bytes • 259th+260th sending PDO mapping: 64 bytes • 259th+261th sending PDO mapping: 128 bytes • 259th+262th sending PDO mapping: 256 bytes
Output handshake	Enables or disables handshaking. <ul style="list-style-type: none"> • ON: Outputs data when the DSA signal after the Controller turns ON. • OFF: Outputs data regardless of the signal state from the Controller. 	OFF or ON Default: OFF
Output control	Output cycle (with no handshaking)	Set the output cycle. 2 to 5,000 ms Default: 10 ms
	The output time of GATE signal (with no handshaking)	Set the output time of the GATE signal. 1 to 1,000 ms Default: 5 ms
	Timeout	Sets the timeout time. 100 to 12,000 ms Default: 10,000 ms

Important

- Changes to settings are not applied until the Vision Sensor is restarted. Therefore, save the settings and then restart the Vision Sensor.
 - 📖 5-5 Saving Data to the Sensor p. 161
 - 📖 Restarting the Sensor p. 210
- When a CJ1W-NC□8□ CJ-series Position Control Unit is connected via EtherCAT, do not change the setting of the data output size. Use the default setting (259th sending PDO mapping (32 bytes)).

Setting the Data To Output Automatically after Measurements

You can set the data to output automatically after measurements. (You can set up to 64 data items.)

Data That Can Be Output

You can set up to 32 items of data (data 0 to data 31) to output.

The measurement data from inspection items that can be output and the calculation results from the expression settings can be output. For the data that can be output, refer to the *Measurement Data That Can Be Used for External Outputs and Calculations* for each inspection item.

Checking EtherCAT Communications Settings

You can check the current EtherCAT communications settings.

- ▶ **Multiview Explorer: [Device group] – Sensor name – [Scene] – Scene data number (Double-click)**
 - **Edit Pane:  (Output) Icon – [Communication settings]**

If you click the [Output] Button while setting up inspection items, the following Output Setting Main Window is displayed.

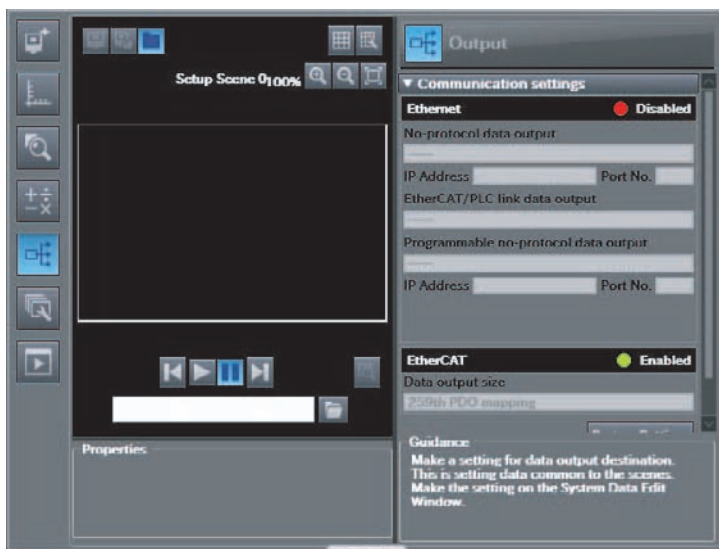

Item	Description
Communication settings	<p>The settings of the following parameters in the system data are displayed.</p> <p>1. EtherCAT setting status Enabled (green): EtherCAT output is enabled. Disabled (red): EtherCAT output is OFF.</p> <p>2. The following EtherCAT output parameters</p> <ul style="list-style-type: none"> • Data output size • Output format
Properties	The properties of the output data are displayed.

Note

If EtherCAT is not set in the output destination settings, click the [System settings] Button and make the initial settings for EtherCAT communications in the EtherCAT Dialog Box.

Allocating Output Data

- ▶ **Multiview Explorer: [Device group] – Sensor name – [Scene] – Scene data number (Double-click)**

→ **Edit Pane:  (Output) Icon – [No-protocol data output]**

- 1 **Right-click the output data number to set in the output data list under [No-protocol data output] and select [Edit].**

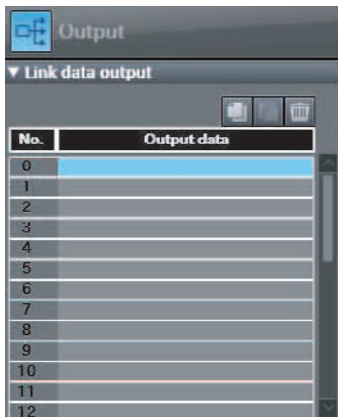

The following Output Dialog Box is displayed.

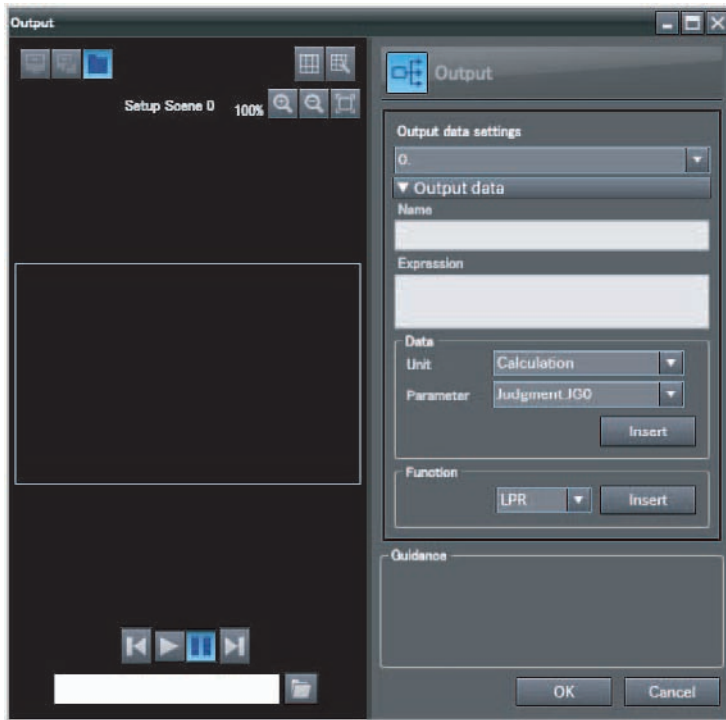

2 Set the data to output in the Output Dialog Box.

Item	Description
Output data settings	The number of the output data that was selected for setting is displayed.
Name	You can change the name of the output data. Max. number of characters: 15
Expression	Registers the output data item or multiple data output function. Examples: IO.X LPR(0, 3, IO.X, IO.Y) LPC(0, IO.C, IO.X, IO.Y)
Unit	You can insert parameters selected from Units and parameters into expressions.
Unit	Select one of the following. <ul style="list-style-type: none"> An inspection item that has the output item to use for the output data. Calculation
Parameter	Select the output item from the selected unit. Example: If the Search inspection item was selected, you can select either of the following: Judgement results: Judgement JG or Correlation: Corre. CR

Item	Description
Function	<p>The following functions can be inserted.</p> <ul style="list-style-type: none"> In Multiple Data Output Mode, select one of the following types of multiple data output functions. <ul style="list-style-type: none"> Data logging order: LPR function The measurement data is output in order. Format: LPR (<i>start_number,number_of_data,data_A, data_B,data_C...</i>) Output Example: LPR(0,3,I0.X,I0.Y,I0.Z) X0,Y0,Z0,X1,Y1,Z1,X2,Y2,Z2 Detection point order: LPC function Outputs data for each detected measurement point. Format: LPC (<i>start_number,number_of_data,data_A, data_B,data_C...</i>) Output Example: LPC(0,3,I0.X,I0.Y,I0.Z) X0,X1,X2,Y0,Y1,Y2,Z0, Z1, Z2 You can specify up to five data items as the above LPR and LPC functions arguments. Encoder Value Output Function <ul style="list-style-type: none"> Encoder Value Output: ECNT function The encoder value is output. Format: ECNT(argument) Output Example: ECNT(0) 0: Ring counter value at measurement trigger 1: Ring counter value at calculation 2: Trigger counter value at calculation

3 Click the [OK] Button.

4 Set the output format.

Set the output format in [Output format] under [EtherCAT/PLC link data output setting].



Item	Description	Setting range
Output format	Sets the output format for numerical data.	Floating point or fixed point Default: Floating point

● Expression Setting Example

This example registers an expression to output the following inspection results for data 0.

Inspection item: 0 Search

Parameters to output: Position X, Position Y, Reference SX, and Reference SY

Multi-point output setting: Multi-point output Check Box selected, Count = 4

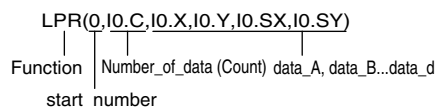

Output Results

The expression that is registered for data 0 assigns the data for 16 items (64 bytes) in the output area as shown below.

Output area data	Assigned data
Output data 0 (4 bytes)	I0.X[0] (Position X 1st point)
Output data 1 (4 bytes)	I0.Y[0] (Position Y 1st point)
Output data 2 (4 bytes)	I0.SX[0] (Reference SX 1st point)
Output data 3 (4 bytes)	I0.SY[0] (Reference SY 1st point)
Output data 4 (4 bytes)	I0.X[1] (Position X 2nd point)
Output data 5 (4 bytes)	I0.Y[1] (Position Y 2nd point)
Output data 6 (4 bytes)	I0.SX[1] (Reference SX 2nd point)
Output data 7 (4 bytes)	I0.SY[1] (Reference SY 2nd point)
Output data 8 (4 bytes)	I0.X[2] (Position X 3rd point)
Output data 9 (4 bytes)	I0.Y[2] (Position Y 3rd point)
Output data 10 (4 bytes)	I0.SX[2] (Reference SX 3rd point)
Output data 11 (4 bytes)	I0.SY[2] (Reference SY 3rd point)
Output data 12 (4 bytes)	I0.X[3] (Position X 4th point)
Output data 13 (4 bytes)	I0.Y[3] (Position Y 4th point)
Output data 14 (4 bytes)	I0.SX[3] (Reference SX 4th point)
Output data 15 (4 bytes)	I0.SY[3] (Reference SY 4th point)

Note

The inspection results will be output according to the sorting method that is set for multi-point output for the inspection item.

● Output Area Size and the Output Data Size

When more than one inspection result is output, the size of the data that is actually output for the data output settings could exceed the size of the output area.

If that occurs, increase the set value of the data output size setting or adjust the output data settings so that specified data output size is not exceeded.

If the size of data that is output does exceed the set value of the data output size setting, the remaining data will be output separately.

Example

Output data size: 256 bytes (Data output size setting: 259th+262th sending PDO mapping)

Data Output Settings

Output data	Setting
Data 0	I0.X[0] Inspection item 0: Position X for Search
Data 1	I0.Y[0] Inspection item 0: Position Y for Search

Output data	Setting	
Data 2	LPC (0,30,I1.X,I1.Y)	Inspection item 1: Position X 1st point for Shape Search . . . Inspection item 1: Position X 30th point for Shape Search Inspection item 1: Position Y 1st point for Shape Search . . . Inspection item 1: Position Y 30th point for Shape Search
Data 3	LPR (0,10,I2.X,I2.Y)	Inspection item 2: Position X 1st point for Shape Search Inspection item 2: Position Y 1st point for Shape Search . . . Inspection item 2: Position X 10th point for Shape Search Inspection item 2: Position Y 10th point for Shape Search

The specified output data is output to the output area as shown below.
 The output data that exceeds the set value of the data output size setting (256 bytes) is output separately.

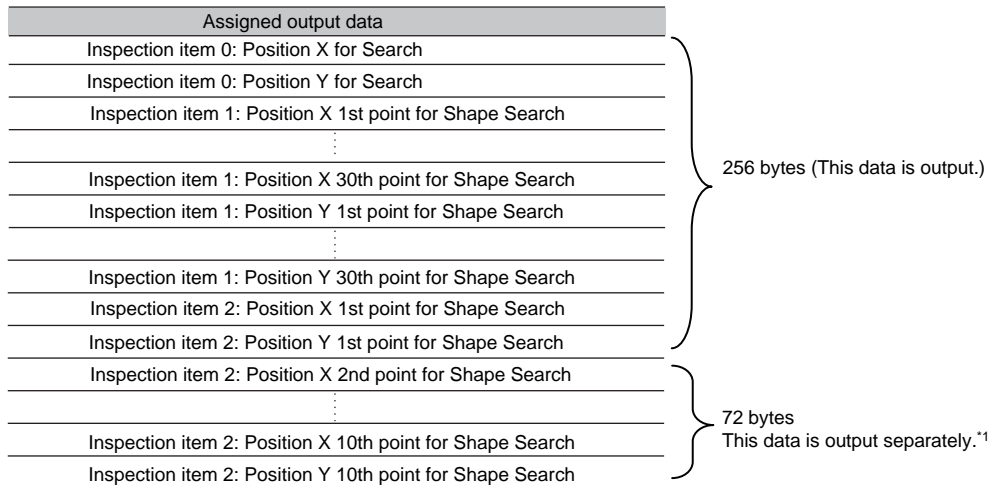

*1 If the size of the specified output data exceeds the set value of the data output size setting, the data is output separately as shown below.

Data output size setting: 256 bytes

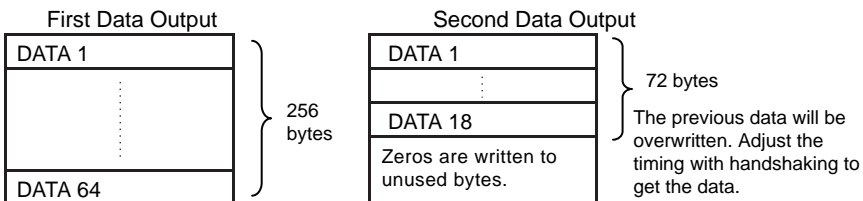

I/O Ports by Area (PDO Mapping) and Memory Assignments

When Connected to an NJ-series Controller

This section describes the I/O ports in the Command, Response, Data Output, and Sysmac Error Status Areas.

Refer to the following section for the sizes, data types, default values, and other information on the I/O ports.



Vision Sensor Specific Objects p. 457

● Command Area I/O Ports

Controller (Master) to Vision Sensor (Slave)

I/O port name	Signal	Signal name	Function
Vision Control Flag		Control Signals	
EXE	EXE	Control Command Execution Bit	<p>Turn ON this signal from the Controller to send a control command for the Vision Sensor to execute.</p> <p>Set the control command code and parameters before you turn ON this signal.</p> <p>Turn OFF the EXE signal from the Controller when the Control Command Completed (FLG) signal from the Vision Sensor turns ON.</p>
TRIG	TRIG	Execute Measurement	<p>Turn ON this signal from the Controller to send a command to execute a measurement.</p> <p>This signal returns to OFF when the Command Execution Active (BUSY) signal goes ON.</p>
DSA	DSA	Data Output Request Bit * This signal is used only when the Output Handshake parameter is set to ON.	<p>Turn ON this signal from the Controller to request data output. When this signal turns ON, the Vision Sensor outputs data.</p> <p>Turn OFF the DSA signal from the Controller when the Data Output Completed (GATE) signal from the Vision Sensor turns ON.</p>
ERCLR	ERCLR	Clear Error	<p>Turn ON this signal to turn OFF the error (ERR) signal from the Vision Sensor.</p> <p>Turn OFF this signal from the Controller when the error (ERR) signal goes OFF.</p>
Vision Command	Command code	Command code	This I/O port stores the command code.
Vision Command Parameter 1 to 3	Parameters 1 to 3	Command parameters	These I/O ports store the command parameters.

● Response area I/O port

Vision Sensor (Slave) to Controller (Master)

I/O port name	Signal	Signal name	Function
Vision Status Flag		Status Signals	
FLG	FLG	Control Command Completed	<p>This signal turns ON when the Vision Sensor completes execution of the control command. This signal turns ON after the control command code, response code, and response data have been stored.</p> <p>This signal automatically turns OFF when the EXE signal from the Controller turns OFF.</p>
BUSY	BUSY	Command Execution Active	<p>This signal is ON while the Vision Sensor cannot execute a control command.</p> <p>This signal is OFF while the Vision Sensor can execute a control command.</p>
READY	READY	Ready	<p>This signal turns OFF when the Vision Sensor cannot execute a control command.</p> <p>This signal turns ON when the Vision Sensor can execute a control command.</p>
OR	OR	Overall judgement	<p>This signal turns ON when the overall judgement is NG.</p> <p>This signal turns OFF when overall judgement is OK.</p>
ERR	ERR	Error	<p>This signal turns ON when an error is detected in the Vision Sensor.</p> <p>This signal is OFF while the Vision Sensor is operating normally.</p>
RUN	RUN	Run Mode	<p>This signal is ON while the Vision Sensor is in Run Mode.</p> <p>This signal is OFF while the Vision Sensor is not in Run Mode.</p>
GATE	GATE	Data Output Completed * This signal is used only when the Output Handshake parameter is set to ON.	<p>This signal turns ON when the Vision Sensor finishes outputting data.</p> <p>If handshaking is enabled, the GATE signal turns OFF automatically when you turn OFF the Data Output Request Bit (DSA) signal from the Controller.</p>
Vision Response	Command code	Command code	This I/O port returns the command code that was executed.
Vision Response Code	Response code	Response code	This I/O port contains the response code of the executed command.
Vision Response Data	Response data	Response data	This I/O port contains the response data of the executed command.
Vision extended data	For future expansion	For future expansion	A value of 0 is always stored.

Note

- The following setting is required to enable the TRIG signal.



Changing the Type of Measurement Trigger to an EtherCAT Trigger p. 79

- You can change the output timing of the BUSY signal for measurements.



Adjusting the End Timing of the BUSY Output p. 223

● Output Area I/O Ports

Vision Sensor (Slave) to Controller (Master)

If output data is registered that exceeds the data output size in the EtherCAT settings, the data is divided up and output across multiple cycles.

I/O port name	Signal	Signal name	Data output size	Output data size
Vision Data Output 1 to 8	DATA1 to DATA8	Output data 1 to 8	32 bytes	These I/O ports output the output data for the output data specified for the data output method.
Vision Data Output 1 to 16	DATA1 to DATA16	Output data 1 to 16	64 bytes	
Vision Data Output 1 to 32	DATA1 to DATA32	Output data 1 to 32	128 bytes	
Vision Data Output 1 to 64	DATA1 to DATA64	Output data 1 to 64	256 bytes	

● I/O Ports in Sysmac Error Status Area

Vision Sensor (Slave) to Controller (Master)

The Sysmac Error Status is mapped only when connected to an NJ-series Controller.

I/O port name	Signal	Signal name	Function
Sysmac Error Status	Sysmac Error Status	Sysmac Error Status	Gives the Sysmac error status.
Observation	Observation	Observation Error	This signal turns ON when an observation error occurs in the Vision Sensor.
Minor Fault	Minor Fault	Minor Fault Level Error	This signal turns ON when a minor fault level error occurs in the Vision Sensor.

Assigning Device Variables to I/O Ports (PDO Mapping)

When connected to an NJ-series CPU Unit, the data for PDO communications in the Vision Sensor is displayed with I/O port names on the Sysmac Studio. You can assign device variables to the I/O ports in the Sysmac Studio I/O map to perform programming and monitoring.

- **Multiview Explorer (Connected to NJ-series CPU Unit): [Configurations and Setup] – [I/O Map] (Double-click)**

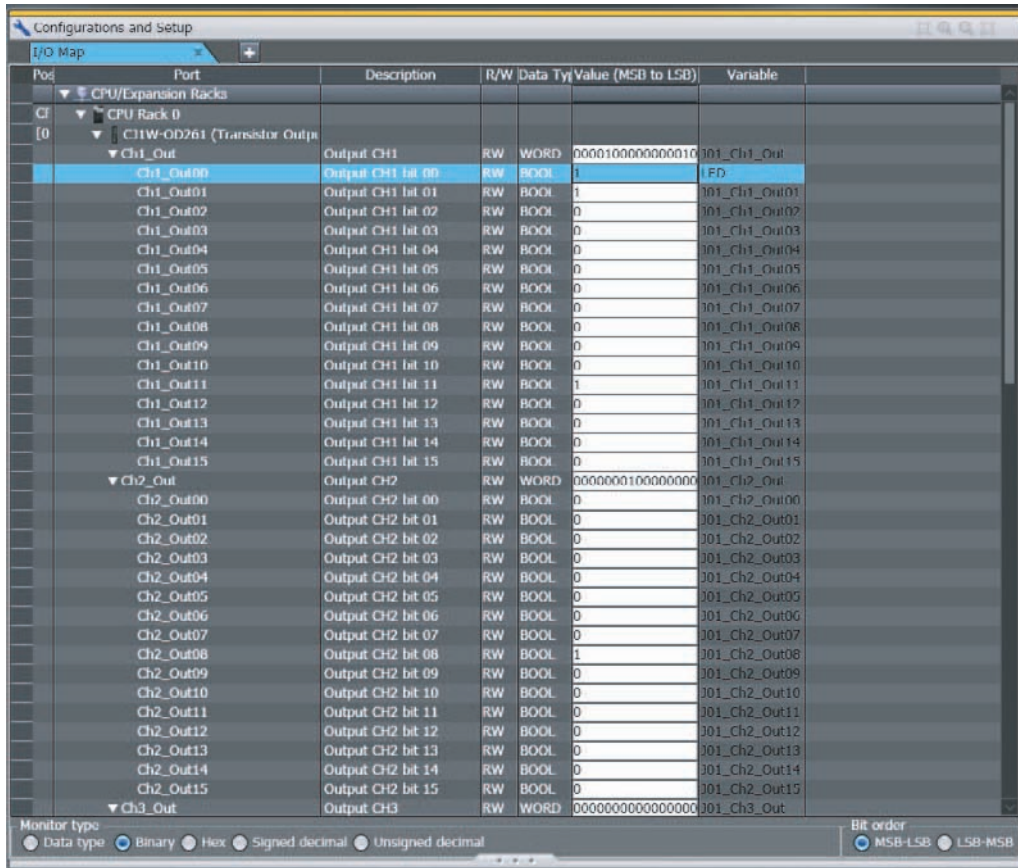

Pod	Port	Description	R/W	Data Type	Value (MSB to LSB)	Variable	
[0]	CPU/Expansion Racks						
	CPU Rack 0						
	C31W-OD261 (Transistor Output)						
	Ch1_Out						
		Ch1_Out00	Output CH1	RW	WORD	0000100000000010	I01_Ch1_Out
		Ch1_Out01	Output CH1 bit 00	RW	BOOL	1	I_PD
		Ch1_Out02	Output CH1 bit 01	RW	BOOL	0	I01_Ch1_Out01
		Ch1_Out03	Output CH1 bit 02	RW	BOOL	0	I01_Ch1_Out02
		Ch1_Out04	Output CH1 bit 03	RW	BOOL	0	I01_Ch1_Out03
		Ch1_Out05	Output CH1 bit 04	RW	BOOL	0	I01_Ch1_Out04
		Ch1_Out06	Output CH1 bit 05	RW	BOOL	0	I01_Ch1_Out05
		Ch1_Out07	Output CH1 bit 06	RW	BOOL	0	I01_Ch1_Out06
		Ch1_Out08	Output CH1 bit 07	RW	BOOL	0	I01_Ch1_Out07
		Ch1_Out09	Output CH1 bit 08	RW	BOOL	0	I01_Ch1_Out08
		Ch1_Out10	Output CH1 bit 09	RW	BOOL	0	I01_Ch1_Out09
		Ch1_Out11	Output CH1 bit 10	RW	BOOL	0	I01_Ch1_Out10
		Ch1_Out12	Output CH1 bit 11	RW	BOOL	1	I01_Ch1_Out11
		Ch1_Out13	Output CH1 bit 12	RW	BOOL	0	I01_Ch1_Out12
		Ch1_Out14	Output CH1 bit 13	RW	BOOL	0	I01_Ch1_Out13
		Ch1_Out15	Output CH1 bit 14	RW	BOOL	0	I01_Ch1_Out14
		Ch2_Out	Output CH2	RW	WORD	0000000100000000	I01_Ch2_Out
		Ch2_Out00	Output CH2 bit 00	RW	BOOL	0	I01_Ch2_Out00
		Ch2_Out01	Output CH2 bit 01	RW	BOOL	0	I01_Ch2_Out01
		Ch2_Out02	Output CH2 bit 02	RW	BOOL	0	I01_Ch2_Out02
		Ch2_Out03	Output CH2 bit 03	RW	BOOL	0	I01_Ch2_Out03
		Ch2_Out04	Output CH2 bit 04	RW	BOOL	0	I01_Ch2_Out04
		Ch2_Out05	Output CH2 bit 05	RW	BOOL	0	I01_Ch2_Out05
		Ch2_Out06	Output CH2 bit 06	RW	BOOL	0	I01_Ch2_Out06
		Ch2_Out07	Output CH2 bit 07	RW	BOOL	0	I01_Ch2_Out07
		Ch2_Out08	Output CH2 bit 08	RW	BOOL	1	I01_Ch2_Out08
		Ch2_Out09	Output CH2 bit 09	RW	BOOL	0	I01_Ch2_Out09
		Ch2_Out10	Output CH2 bit 10	RW	BOOL	0	I01_Ch2_Out10
		Ch2_Out11	Output CH2 bit 11	RW	BOOL	0	I01_Ch2_Out11
		Ch2_Out12	Output CH2 bit 12	RW	BOOL	0	I01_Ch2_Out12
		Ch2_Out13	Output CH2 bit 13	RW	BOOL	0	I01_Ch2_Out13
		Ch2_Out14	Output CH2 bit 14	RW	BOOL	0	I01_Ch2_Out14
		Ch2_Out15	Output CH2 bit 15	RW	BOOL	0	I01_Ch2_Out15
		Ch3_Out	Output CH3	RW	WORD	0000000000000000	I01_Ch3_Out

Right-click a slave or I/O port in the I/O map and select [Create Device Variable]. The device variable name is automatically created as a combination of the device name and the I/O port name. You can also select an I/O port and enter a variable name in the [Variable] column.

You can also select a registered variable from the variable table to use as a device variable. Refer to the *Sysmac Studio Version 1 Operation Manual* (Cat. No. W504) for details on registering device variables.

When Connected to a CJ-series PLC

This section describes the I/O memory assignments for the Command, Response, and Data Output Areas.

● Command Area

PLC (Master) to Vision Sensor (Slave)

First word	Bits																Contents
	15	14	13	12	11	10	9	8	7	6	5	4	3	2	1	0	
+0	ERCLR	Resv	Resv	Resv	Resv	Resv	Resv	Resv	Resv	Resv	Resv	Resv	Resv	Resv	TRIG	EXE	Control signals (32 bits)
+1	Resv	Resv	Resv	Resv	Resv	Resv	Resv	Resv	Resv	Resv	Resv	Resv	Resv	Resv	Resv	DSA	
+2	Command code																Command code (32 bits)
+3																	
+4	Parameter 1																Parameter 1 (32 bits)
+5																	
+6	Parameter 2																Parameter 2 (32 bits)
+7																	
+8	Parameter 3																Parameter 3 (32 bits)
+9																	

Signal	Signal name	Function
EXE	Control Command Execution Bit	Turn ON this signal from the PLC to send a control command for the Vision Sensor to execute. Set the control command code and parameters before you turn ON this signal.
		Turn OFF the EXE signal from the PLC when the Control Command Completed (FLG) signal from the Vision Sensor turns ON.
TRIG	Execute Measurement	Turn ON this signal from the PLC to send a command to execute a measurement.
		This signal returns to OFF when the Command Execution Active (BUSY) signal goes ON.
DSA	Data Output Request Bit * This signal is used only when the Output Handshake parameter is set to ON.	Turn ON this signal from the PLC to request data output. When this signal turns ON, the Vision Sensor outputs data.
		Turn OFF the DSA signal from the PLC when the Data Output Completed (GATE) signal from the Vision Sensor turns ON.
ERCLR	Clear Error	Turn ON this signal to turn OFF the error (ERR) signal from the Vision Sensor.
		Turn OFF this signal from the PLC when the error (ERR) signal goes OFF.
Command code	Command code	This I/O port stores the command code.
Parameters 1 to 3	Command parameters	These I/O ports store the command parameters.

● Response Area

Vision Sensor (Slave) to PLC (Master)

First word	Bits																Contents
	15	14	13	12	11	10	9	8	7	6	5	4	3	2	1	0	
+0	ERR	Resv	Resv	Resv	Resv	Resv	Resv	Resv	Resv	Resv	Resv	RUN	OR	READY	BUSY	FLG	Vision Status Flags (32 bits)
+1	Resv	Resv	Resv	Resv	Resv	Resv	Resv	Resv	Resv	Resv	Resv	Resv	Resv	Resv	Resv	GATE	
+2	Command code																Command code (32 bits)
+3																	
+4	Response code																Response code (32 bits)
+5																	
+6	Response data																Response data (32 bits)
+7																	
+8	Extended region																Vision extended data (32 bits)
+9																	

Signal	Signal name	Function
FLG	Control Command Completed	This signal turns ON when the Vision Sensor completes execution of the control command. (This signal turns ON after the control command code, response code, and response data have been stored.)
		This signal automatically turns OFF when the Control Command Execution Bit (EXE) is turned OFF by the user (PLC).
BUSY	Command Execution Active	This signal is ON while the Vision Sensor cannot execute a control command.
		This signal is OFF while the Vision Sensor can execute a control command.
READY	Ready	This signal turns OFF when the Vision Sensor cannot execute a control command.
		This signal turns ON when the Vision Sensor can execute a control command.
OR	Overall judgement	This signal turns ON when the overall judgement is NG.
		This signal turns OFF when total judgement is OK.
ERR	Error	This signal turns ON when an error is detected in the Vision Sensor.
		This signal is OFF while the Vision Sensor is operating normally.
RUN	Run Mode	This signal is ON while the Vision Sensor is in Run Mode.
		This signal is OFF while the Vision Sensor is not in Run Mode.
GATE	Data Output Completed * This signal is used only when the Output Handshake parameter is set to ON.	This signal turns ON when the Vision Sensor finishes outputting data.
		If handshaking is enabled, the GATE signal turns OFF automatically when you turn OFF the Data Output Request (DSA) signal from the PLC.
Command code	Command code	This I/O port returns the command code that was executed.
Response code	Response code	This I/O port contains the response code of the executed command.

Signal	Signal name	Function
Response data	Response data	This I/O port contains the response data of the executed command.

Note

- The following setting is required to enable the TRIG signal.



Changing the Type of Measurement Trigger to an EtherCAT Trigger p. 79

● Output Area

The data output area is assigned in the I/O memory area immediately after the response area.

Vision Sensor (Slave) to PLC (Master)

First word	Bits																Contents
	15	14	13	12	11	10	9	8	7	6	5	4	3	2	1	0	
+10	DATA1																Output data 1 (32 bits)
+11																	
+12	DATA2																Output data 2 (32 bits)
+13																	
+14	DATA3																Output data 3 (32 bits)
+15																	
+16	DATA4																Output data 4 (32 bits)
+17																	
+18	DATA5																Output data 5 (32 bits)
+19																	
+20	DATA6																Output data 6 (32 bits)
+21																	
+22	DATA7																Output data 7 (32 bits)
+23																	
+24	DATA8																Output data 8 (32 bits)
+25																	

Signal	Signal name	Function
DATA1-DATA8	Output data 1 to 8	These I/O ports output the output data for the output data specified for the data output method.

Note

If the size of data that is output exceeds the set value of the data output size setting, the data will be output separately.



Allocating Output Data p. 236

I/O Memory Assignment Method (PDO Mapping)

If you connect the Vision Sensor to a CJ-series PLC, the OMRON CJ1W-NC□82 Position Control Unit is used as the EtherCAT master. This section describes the assignments in the I/O memory of the PLC for the Command, Response, and Data Output Areas for the Vision Sensor.

The areas for the Vision Sensor correspond to the areas for the Position Control Unit as shown in the following table.

Vision Sensor area	Position Control Unit area	Maximum number of words
Command area	Remote I/O Output Memory Area	10
Response area	Remote I/O Input Memory Area	10
Output area	Remote I/O Input Memory Area	16

The I/O memory assignment method is described below.

1. Network Settings

Double-click **I/O Table and Unit Setup** in the CX-Programmer, right-click **CJ1W-NC□82**, and select **Edit SIO Unit Parameters**.

2. Setting Common Parameters

The Support Software for Position Control Units will start. Set the areas and the first words for the Remote I/O Output Memory Area, the Axis Status Memory Area, and the Remote I/O Input Memory Area.

3. Checking the Remote I/O Area

Select [Network] and then click the [Remote I/O Assignment] Tab to check the I/O addresses that are set for remote I/O. (You can manually change the input offset and output offset.) In the following example, CIO 3800 is set as the first word of the remote I/O output area and CIO 3900 is set as the first word of the remote I/O input area.

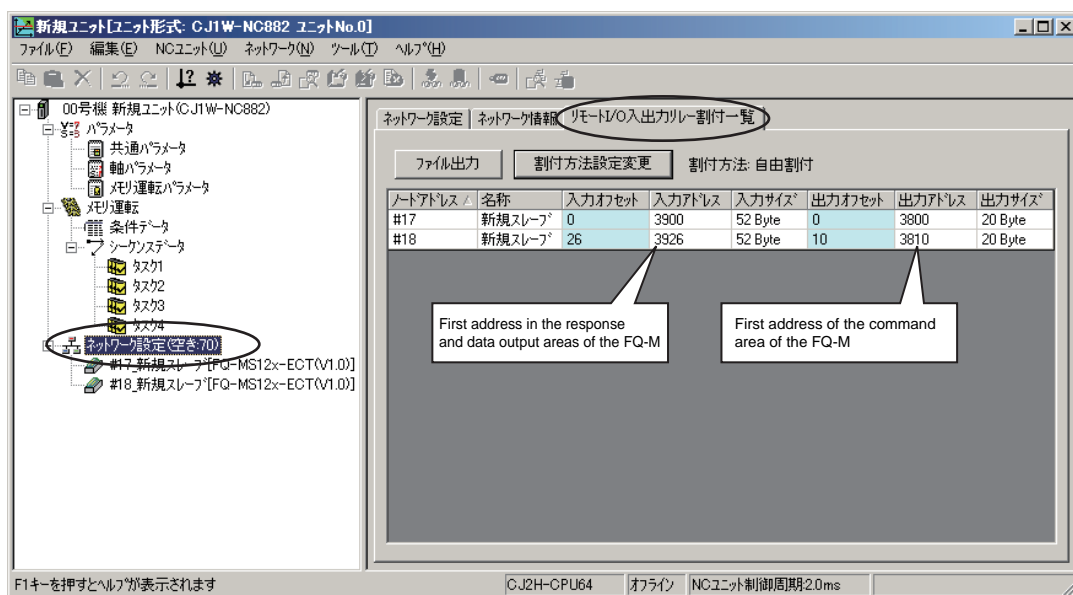

The memory map for the above example is shown below.

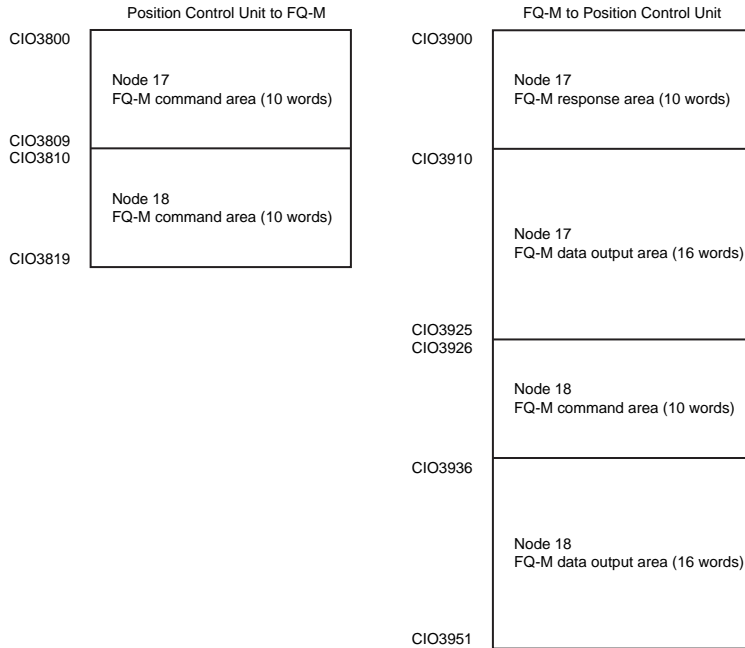

For the Position Control Unit, the areas are set only for node 17 (which has the first area for each of the three memory areas).

To access data from another node from a ladder program, add the correct offset from the first word of the first area for node 17 and access the resulting address.

Refer to the *CJ-series Position Control Units Operation Manual* (Cat. No. W487) for details on I/O memory assignment methods.

If you connect more than one FQ-M Sensor to an OMRON Position Control Unit, the following addresses in the memory map are assigned in order for the I/O areas.

Set the node address setting switches on the Sensors to 0 to automatically set up the network. Node addresses 17 and higher will be automatically set for the remote I/O.

Commands

This section describes the EtherCAT commands.

● Measurement Control Commands

Command code in command area (hex)	Command name	Function	Reference
0010 1020	Start Continuous Measurements	Executes continuous measurements.	p. 251
0010 1030	End Continuous Measurements	Ends continuous measurements.	p. 251

● Utility Commands

Command code in command area (hex)	Command name	Function	Reference
0010 2010	Clear Measurement Values	Clears all measurement result values.	p. 252
0010 2020	Clear Data Output Buffer	Clears all data in the data output buffer.	p. 252
0010 2030	Reset Encoder Counter	Resets the encoder counter.	p. 253
0010 3010	Save Data in Sensor	Saves the current system data and scene groups in the Sensor.	p. 253
0010 4010	Re-register Model	Registers the model again.	p. 254
0010 F010	Reset	Resets the Vision Sensor.	p. 254
0020 5000	Get Latest Error Information	Acquires the latest error information.	p. 254

● Scene Control Commands

Command code in command area (hex)	Command name	Function	Reference
0020 1000	Get Scene Number	Acquires the current scene number.	p. 255
0030 1000	Select Scene	Changes to the specified scene number.	p. 255

● Data Acquisition/Setting Commands

Command code in command area (hex)	Command name	Function	Reference
0040 1020	Get Inspection Item Data	Acquires the inspection item data.	p. 256
0050 1020	Set Inspection Item Data	Sets the inspection item data to the specified data.	p. 257
0040 3000	Get Software Version Information	Acquires the software version.	p. 257
0020 6000	Get Encoder Counter	Acquires the encoder counter.	p. 258
0030 6000	Set Encoder Counter	Sets the encoder counter.	p. 259

Command Details

● Start Continuous Measurements (Command Code: 0010 1020 (hex))

Command (Controller to Vision Sensor)

First word of command area (hex)	Bits				Contents
	12 to 15	8 to 11	4 to 7	0 to 3	
+2	0001	0000	0010	0000	Command code (32 bits)
+3	0000	0000	0001	0000	

Response (Vision Sensor to Controller)

First word of response area (hex)	Bits				Contents
	12 to 15	8 to 11	4 to 7	0 to 3	
+2	0001	0000	0010	0000	Command code (32 bits)
+3	0000	0000	0001	0000	The command code for which the response applies is stored.
+4	0000	0000	0000	0000	Response code (32 bits)
+5	0000	0000	0000	0000	Command execution result 0: OK, FFFFFFFF: NG

● End Continuous Measurements (Command Code: 0010 1030 (hex))

Command (Controller to Vision Sensor)

First word of command area (hex)	Bits				Contents
	12 to 15	8 to 11	4 to 7	0 to 3	
+2	0001	0000	0011	0000	Command code (32 bits)
+3	0000	0000	0001	0000	

Response (Vision Sensor to Controller)

First word of response area (hex)	Bits				Contents
	12 to 15	8 to 11	4 to 7	0 to 3	
+2	0001	0000	0011	0000	Command code (32 bits)
+3	0000	0000	0001	0000	The command code for which the response applies is stored.
+4	0000	0000	0000	0000	Response code (32 bits)
+5	0000	0000	0000	0000	Command execution result 0: OK, FFFFFFFF: NG

Note

Set data output to output the measurement results.
If data output is not set, only the command response is output.



Setting the Data To Output Automatically after Measurements: p. 235

● Clear Measurement Values (Command Code: 0010 2010 (hex))

Command (Controller to Vision Sensor)

First word of command area (hex)	Bits				Contents
	12 to 15	8 to 11	4 to 7	0 to 3	
+2	0010	0000	0001	0000	Command code (32 bits)
+3	0000	0000	0001	0000	

Response (Vision Sensor to Controller)

First word of response area (hex)	Bits				Contents
	12 to 15	8 to 11	4 to 7	0 to 3	
+2	0010	0000	0001	0000	Command code (32 bits)
+3	0000	0000	0001	0000	The command code for which the response applies is stored.
+4	0000	0000	0000	0000	Response code (32 bits)
+5	0000	0000	0000	0000	Command execution result 0: OK, FFFFFFFF: NG

● Clear Data Output Buffer (Command Code: 0010 2020 (hex))

Command (Controller to Vision Sensor)

First word of command area (hex)	Bits				Contents
	12 to 15	8 to 11	4 to 7	0 to 3	
+2	0010	0000	0010	0000	Command code (32 bits)
+3	0000	0000	0001	0000	

Response (Vision Sensor to Controller)

First word of response area (hex)	Bits				Contents
	12 to 15	8 to 11	4 to 7	0 to 3	
+2	0010	0000	0010	0000	Command code (32 bits)
+3	0000	0000	0001	0000	The command code for which the response applies is stored.
+4	0000	0000	0000	0000	Response code (32 bits)
+5	0000	0000	0000	0000	Command execution result 0: OK, FFFFFFFF: NG

● Reset Encoder Counter (Command Code: 0010 2030 (hex))

Command (Controller to Vision Sensor)

First word of command area (hex)	Bits				Contents
	12 to 15	8 to 11	4 to 7	0 to 3	
+2	0010	0000	0011	0000	Command code (32 bits)
+3	0000	0000	0001	0000	
+4	0000	0000	0000	0000	Parameter 1 Reset target (32 bits) 0: Reset the trigger counter and ring counter. 1: Reset the ring counter. 2: Reset the trigger counter.
+5	0000	0000	0000	0000	

Response (Vision Sensor to Controller)

First word of response area (hex)	Bits				Contents
	12 to 15	8 to 11	4 to 7	0 to 3	
+2	0100	0000	0001	0000	Command code (32 bits)
+3	0000	0000	0101	0000	The command code for which the response applies is stored.
+4	0000	0000	0000	0000	Response code (32 bits)
+5	0000	0000	0000	0000	Command execution result 0: OK, FFFFFFFF: NG

● Save Data in Sensor (Command Code: 0010 3010 (hex))

Command (Controller to Vision Sensor)

First word of command area (hex)	Bits				Contents
	12 to 15	8 to 11	4 to 7	0 to 3	
+2	0011	0000	0001	0000	Command code (32 bits)
+3	0000	0000	0001	0000	

Response (Vision Sensor to Controller)

First word of response area (hex)	Bits				Contents
	12 to 15	8 to 11	4 to 7	0 to 3	
+2	0011	0000	0001	0000	Command code (32 bits)
+3	0000	0000	0001	0000	The command code for which the response applies is stored.
+4	0000	0000	0000	0000	Response code (32 bits)
+5	0000	0000	0000	0000	Command execution result 0: OK, FFFFFFFF: NG

● Reregister Model (Command Code: 0010 4010 (hex))

Command (Controller to Vision Sensor)

First word of command area (hex)	Bits				Contents
	12 to 15	8 to 11	4 to 7	0 to 3	
+2	0100	0000	0001	0000	Command code (32 bits)
+3	0000	0000	0001	0000	

Response (Vision Sensor to Controller)

First word of response area (hex)	Bits				Contents
	12 to 15	8 to 11	4 to 7	0 to 3	
+2	0100	0000	0001	0000	Command code (32 bits)
+3	0000	0000	0001	0000	The command code for which the response applies is stored.
+4	0000	0000	0000	0000	Response code (32 bits)
+5	0000	0000	0000	0000	Command execution result 0: OK, FFFFFFFF: NG

● Reset (Command Code: 0010 F010 (hex))

Command (Controller to Vision Sensor)

First word of command area (hex)	Bits				Contents
	12 to 15	8 to 11	4 to 7	0 to 3	
+2	1111	0000	0001	0000	Command code (32 bits)
+3	0000	0000	0001	0000	

Response (Vision Sensor to Controller)

First word of response area (hex)	Bits				Contents
	12 to 15	8 to 11	4 to 7	0 to 3	
There is no response for a reset operation.					

● Get Latest Error Information (Command Code: 0020 5000 (hex))

Command (Controller to Vision Sensor)

First word of command area (hex)	Bits				Contents
	12 to 15	8 to 11	4 to 7	0 to 3	
+2	0101	0000	0000	0000	Command code (32 bits)
+3	0000	0000	0010	0000	

Response (Vision Sensor to Controller)

First word of response area (hex)	Bits				Contents
	12 to 15	8 to 11	4 to 7	0 to 3	
+2	0101	0000	0000	0000	Command code (32 bits) The command code for which the response applies is stored.
+3	0000	0000	0010	0000	
+4	0000	0000	0000	0000	Response code (32 bits) Command execution result 0: OK, FFFFFFFF: NG
+5	0000	0000	0000	0000	
+6	0000	0000	0000	0000	Response data (32-bit signed integer) Latest error code
+7	0000	0000	0000	0000	

 Section 11 Troubleshooting p. 381

● Get Scene Number (Command Code: 0020 1000 (hex))

Command (Controller to Vision Sensor)

First word of command area (hex)	Bits				Contents
	12 to 15	8 to 11	4 to 7	0 to 3	
+2	0001	0000	0000	0000	Command code (32 bits)
+3	0000	0000	0010	0000	

Response (Vision Sensor to Controller)

First word of response area (hex)	Bits				Contents
	12 to 15	8 to 11	4 to 7	0 to 3	
+2	0001	0000	0000	0000	Command code (32 bits) The command code for which the response applies is stored.
+3	0000	0000	0010	0000	
+4	0000	0000	0000	0000	Response code (32 bits) Command execution result 0: OK, FFFFFFFF: NG
+5	0000	0000	0000	0000	
+6	0000	0000	0000	0000	Response data (32-bit signed integer) Acquired scene number
+7	0000	0000	0000	0000	

● Select Scene (Command Code: 0030 1000 (hex))

Command (Controller to Vision Sensor)

First word of command area (hex)	Bits				Contents
	12 to 15	8 to 11	4 to 7	0 to 3	
+2	0001	0000	0000	0000	Command code (32 bits)
+3	0000	0000	0011	0000	
+4	0000	0000	0000	0000	Parameter 1 Scene number (32 bits)
+5	0000	0000	0000	0000	

Response (Vision Sensor to Controller)

First word of response area (hex)	Bits				Contents
	12 to 15	8 to 11	4 to 7	0 to 3	
+2	0001	0000	0000	0000	Command code (32 bits) The command code for which the response applies is stored.
+3	0000	0000	0011	0000	
+4	0000	0000	0000	0000	Response code (32 bits)
+5	0000	0000	0000	0000	Command execution result 0: OK, FFFFFFFF: NG

● Get Inspection Item Data (Command Code: 0040 1020 (hex))

Command (Controller to Vision Sensor)

First word of command area (hex)	Bits				Contents
	12 to 15	8 to 11	4 to 7	0 to 3	
+2	0001	0000	0010	0000	Command code (32 bits)
+3	0000	0000	0100	0000	
+4	0000	0000	0000	0000	Parameter 1
+5	0000	0000	0000	0000	Inspection item number (32-bit unsigned integer)
+6	0000	0000	0000	0000	Parameter 2
+7	0000	0000	0000	0000	External; access number (32-bit unsigned integer)  12-2 External Reference Parameters p. 412

Response (Vision Sensor to Controller)

First word of response area (hex)	Bits				Contents
	12 to 15	8 to 11	4 to 7	0 to 3	
+2	0001	0000	0010	0000	Command code (32 bits) The command code for which the response applies is stored.
+3	0000	0000	0100	0000	
+4	0000	0000	0000	0000	Response code (32 bits)
+5	0000	0000	0000	0000	Command execution result 0: OK, FFFFFFFF: NG
+6	0000	0000	0000	0000	Response data
+7	0000	0000	0000	0000	Acquired data (32-bit signed integer: 1,000 times the value)

● Set Inspection Item Data (Command Code: 0050 1020 (hex))

Command (Controller to Vision Sensor)

First word of command area (hex)	Bits				Contents
	12 to 15	8 to 11	4 to 7	0 to 3	
+2	0001	0000	0010	0000	Command code (32 bits)
+3	0000	0000	0101	0000	
+4	0000	0000	0000	0000	Parameter 1 Inspection item number (32-bit unsigned integer)
+5	0000	0000	0000	0000	
+6	0000	0000	0000	0000	Parameter 2 External access number (32-bit unsigned integer)  12-2 External Reference Parameters p. 412
+7	0000	0000	0000	0000	
+8	0000	0000	0000	0000	Parameter 3 Value to set (32-bit signed integer: 1,000 times the value)
+9	0000	0000	0000	0000	

Response (Vision Sensor to Controller)

First word of response area (hex)	Bits				Contents
	12 to 15	8 to 11	4 to 7	0 to 3	
+2	0001	0000	0010	0000	Command code (32 bits)
+3	0000	0000	0101	0000	The command code for which the response applies is stored.
+4	0000	0000	0000	0000	Response code (32 bits)
+5	0000	0000	0000	0000	Command execution result 0: OK, FFFFFFFF: NG

● Get Software Version Information (Command Code: 0040 3000 (hex))

Command (Controller to Vision Sensor)

First word of command area (hex)	Bits				Contents
	12 to 15	8 to 11	4 to 7	0 to 3	
+2	0011	0000	0000	0000	Command code (32 bits)
+3	0000	0000	0100	0000	

Response (Vision Sensor to Controller)

First word of response area (hex)	Bits				Contents
	12 to 15	8 to 11	4 to 7	0 to 3	
+2	0011	0000	0000	0000	Command code (32 bits) The command code for which the response applies is stored.
+3	0000	0000	0100	0000	
+4	0000	0000	0000	0000	Response code (32 bits) Command execution result 0: OK, FFFFFFFF: NG
+5	0000	0000	0000	0000	
+6	0000	0000	0000	0000	Response data (32-bit signed integer) Software version (DINT: 1,000 times the value)
+7	0000	0000	0000	0000	

● Get Ring Counter (Command Code: 0020 6000 (hex))

Command (Controller to Vision Sensor)

First word of command area (hex)	Bits				Contents
	12 to 15	8 to 11	4 to 7	0 to 3	
+2	0110	0000	0000	0000	Command code (32 bits)
+3	0000	0000	0010	0000	
+4	0000	0000	0000	0000	Parameter 1 Counter timing (32-bit unsigned integer) 0: Current ring counter value at command execution 1: Ring counter value at most recent trigger
+5	0000	0000	0000	0000	

Response (Vision Sensor to Controller)

First word of response area (hex)	Bits				Contents
	12 to 15	8 to 11	4 to 7	0 to 3	
+2	0001	0000	0100	0000	Command code (32 bits) The command code for which the response applies is stored.
+3	0000	0000	0100	0000	
+4	0000	0000	0000	0000	Response code (32 bits) Command execution result 0: OK, FFFFFFFF: NG
+5	0000	0000	0000	0000	
+6	0000	0000	0000	0000	Response data (32-bit signed integer) Acquired data
+7	0000	0000	0000	0000	

● Set Ring Counter (Command Code: 0030 6000 (hex))

Command (Controller to Vision Sensor)

First word of command area (hex)	Bits				Contents
	12 to 15	8 to 11	4 to 7	0 to 3	
+2	0110	0000	0000	0000	Command code (32 bits)
+3	0000	0000	0011	0000	
+4	0000	0000	0000	0000	Parameter 1 Set value for ring counter
+5	0000	0000	0000	0000	

Response (Vision Sensor to Controller)

First word of response area (hex)	Bits				Contents
	12 to 15	8 to 11	4 to 7	0 to 3	
+2	0100	0000	0001	0000	Command code (32 bits)
+3	0000	0000	0101	0000	The command code for which the response applies is stored.
+4	0000	0000	0000	0000	Response code (32 bits)
+5	0000	0000	0000	0000	Command execution result 0: OK, FFFFFFFF: NG

Timing Chart for EtherCAT Communications

● Performing Measurements with the TRIG Signal

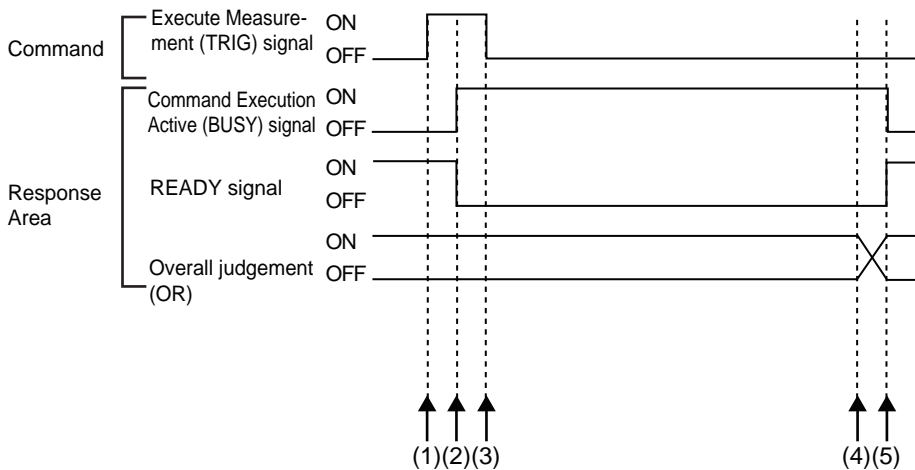

- (1) Measurement starts when the TRIG signal turns ON while the BUSY signal is OFF.
- (2) The BUSY signal turns ON when measurement begins.
- (3) The TRIG signal turns OFF when the BUSY signal turns ON.
- (4) The OR of the measurement results is output when measurements are completed.
- (5) The BUSY signal turns OFF when the BUSY output condition is met.

● Execution of Control Commands Other Than Continuous Measurements with the Control Command Execution Bit (EXE) Signal

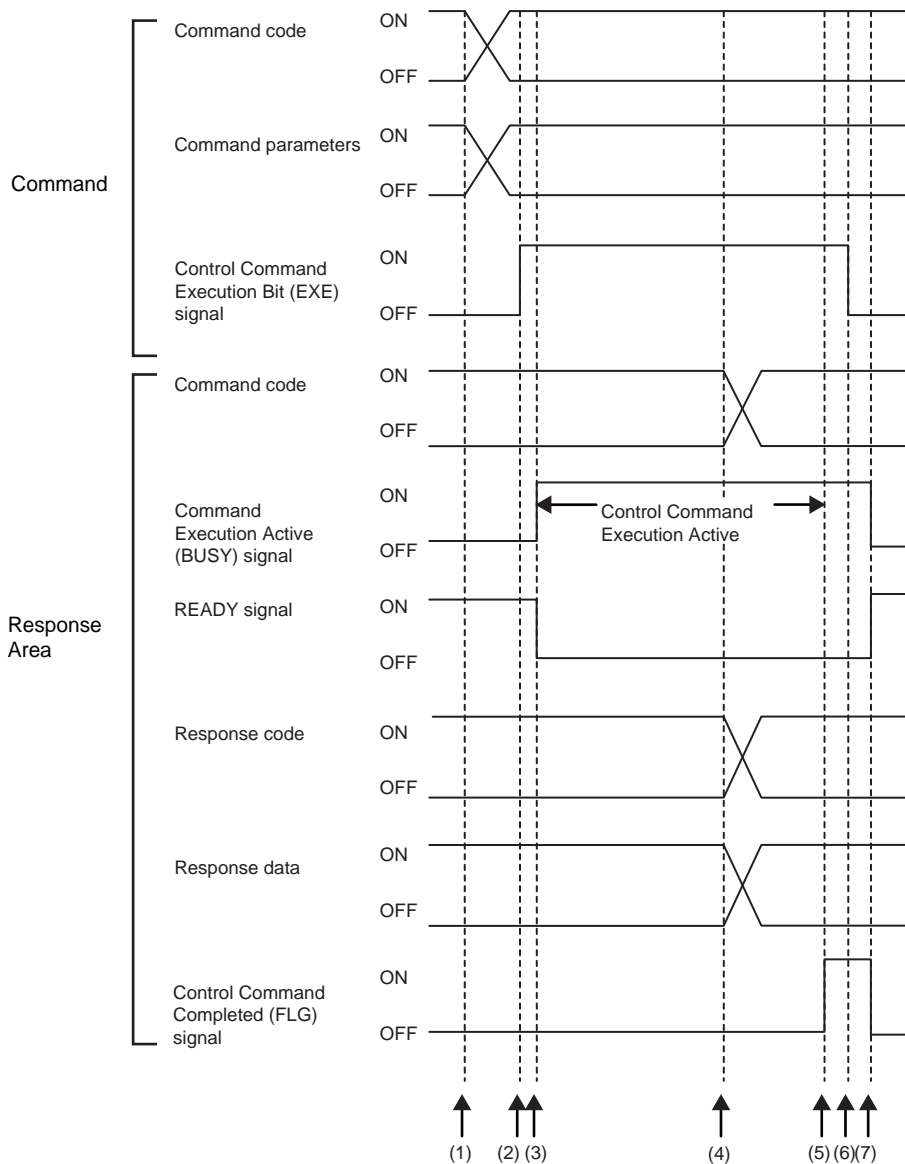

- (1) Set the command code and the command parameters from the master while the BUSY signal is OFF.
- (2) The Controller turns ON the Control Command Execution Bit (EXE) signal. The execution command is sent to the Vision Sensor.
- (3) When the Vision Sensor receives the execution command, the Command Execution Active (BUSY) signal turns ON, the READY signal turns OFF, and the command is executed.
- (4) The command code, response code, and response data are set when the Vision Sensor completes execution of the command.
- (5) The Control Command Completed (FLG) signal turns ON.
- (6) When the master detects that the Control Command Completed (FLG) signal is ON, it turns OFF the Control Command Execution Bit (EXE) signal.
- (7) When the Vision Sensor detects that the Control Command Execution Bit (EXE) signal is OFF, it automatically turns OFF the Control Command Completed (FLG) signal and the Command Execution Active (BUSY) signal, and turns ON the READY signal.

● Execution of Control Commands for Continuous Measurements with the Control Command Execution Bit (EXE) Signal

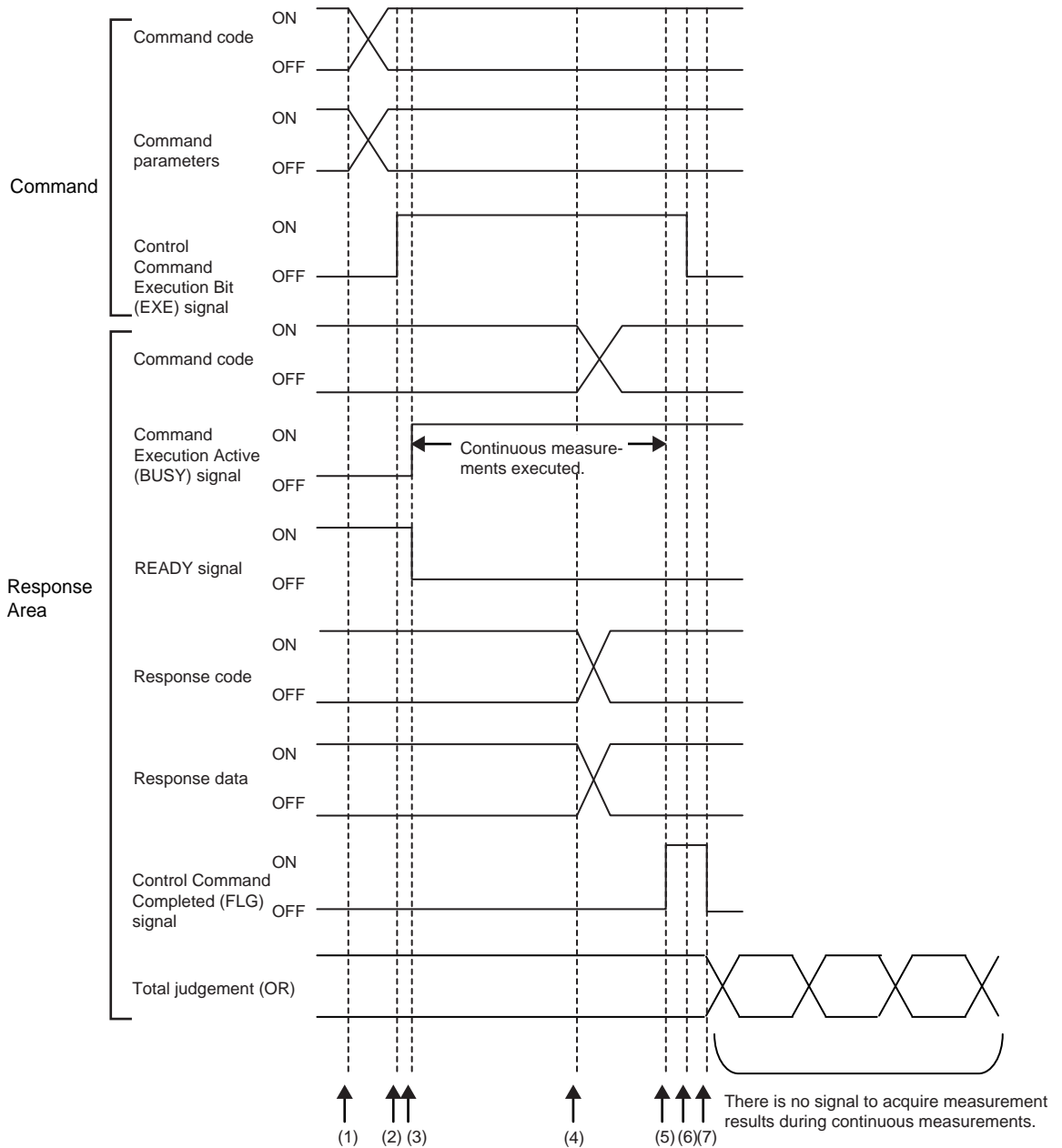

- (1) Set the Start Continuous Measurements command code and the command parameters from the master while the BUSY signal is OFF.
- (2) The Controller turns ON the Control Command Execution Bit (EXE) signal. The execution command is sent to the Vision Sensor.
- (3) When the Vision Sensor receives the execution command, the Command Execution Active (BUSY) signal turns ON, the READY signal turns OFF, and the command is executed. Continuous measurements start at this time.
- (4) The command code, response code, and response data are set when the Vision Sensor completes execution of the command.
- (5) The Control Command Completed (FLG) signal turns ON.
- (6) When the master detects that the Control Command Completed (FLG) signal is ON, it turns OFF the Control Command Execution Bit (EXE) signal.
- (7) When the Vision Sensor detects that the Control Command Execution Bit (EXE) signal is OFF, it automatically turns OFF the Control Command Completed (FLG) signal. The BUSY signal remains ON until continuous measurements are completed.
- (8) During continuous measurements, an OR of the measurement results is output each time a measurement is completed.

Note

During execution of continuous measurements, the BUSY signal remains ON. The Vision Sensor will acknowledge the EXE signal only after the End Continuous Measurements command is executed.

● Data Output after Measurements When Handshaking Is Enabled

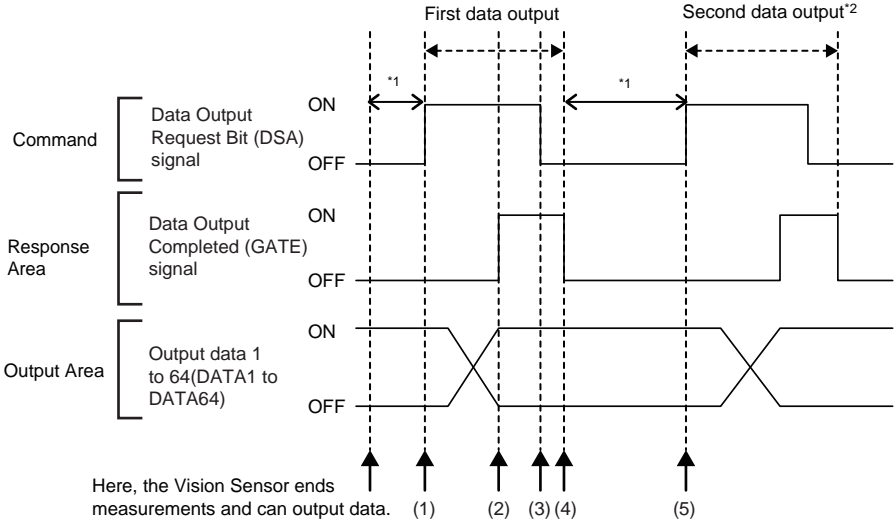

- (1) After measurements are completed, the Data Output Request Bit (DSA) signal is turned ON by the master and a request is made to the Vision Sensor to output the data.
- (2) The Vision Sensor outputs the data. After the data is output, the Data Output Completed (GATE) signal turns ON.
- (3) The master confirms that the Data Output Completed (GATE) signal has turned ON, loads the data, and turns OFF the Data Output Request Bit (DSA) signal.
- (4) When the Vision Sensor detects that the Control Command Execution Bit (EXE) signal is OFF, it automatically turns OFF the Control Command Completed (FLG) signal and the Command Execution Active (BUSY) signal.
- (5) The Data Output Request Bit (DSA) signal is turned ON from the master and a request is made to output the data.

*1 If the data output request signal is not manipulated within the control timeout time (100 to 120,000 ms) in the EtherCAT settings, and data output error will occur and the ERR signal will turn ON. When the ERRCLR signal is turned ON, the ERR signal will turn OFF. However, if a timeout occurs again, the ERR signal will turn ON again. Therefore, correctly request data output (DSA control) or execute a Clear Data Output Buffer command.

*2 Indicates that the data to output is separated and output more than once.

● Data Output after Measurements When Handshaking Is Disabled

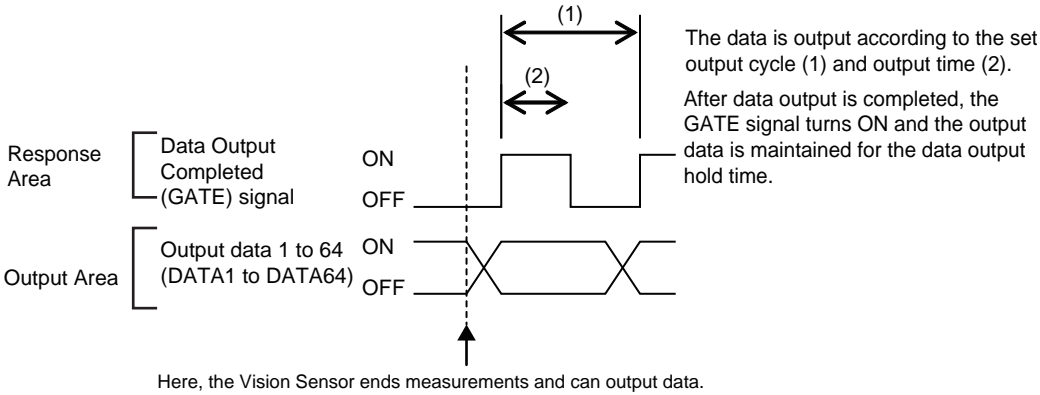

Sample EtherCAT Ladder Programming

● Command/Response Communications

The following sample program is used to perform continuous measurements.

The continuous measurements command (lower bytes: #1020, upper bytes: #0010) is sent to the Vision Sensor.

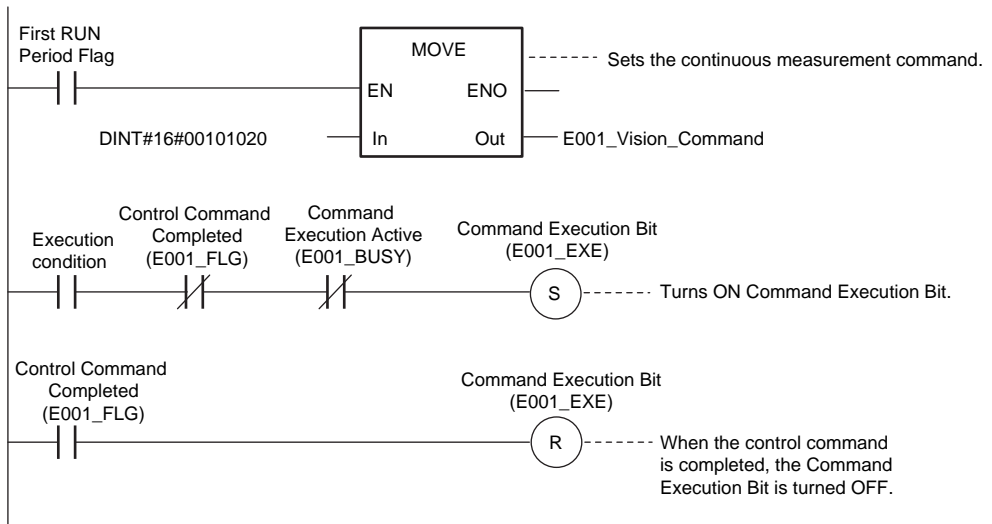

Important

Create the ladder program to control the TRIG signal so that it does not turn ON while the BUSY signal is ON. If not, a TRIG input error will occur and the ERROR signal will turn ON.

● Data Output after Measurements When Handshaking Is Enabled

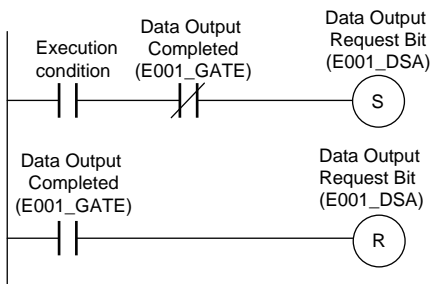

Sysmac Device Features

The control device product designed according to standardized communications and user interface specifications for OMRON control devices are called a Sysmac Device.

And the features available with such a Device is called Sysmac Device Features.

This section describes the features the FQ-M series Vision Sensor provides when combined with a Machine Automation Controller such as NJ series and automation software.

Sysmac Error Status

Because, in Sysmac Devices, errors that may occur in slaves are systematized, you can check the causes and remedies for errors with a common procedure.

The status of an error can be monitored in the Sysmac Error Status (2002-01 hex). To display the error status detected by the FQ-M series Vision Sensor in Sysmac Studio, the Sysmac Error Status (2002-01 hex) must be mapped to the PDO. Sysmac Studio, by default, uses the 512th transmit PDO Mapping assignment to map the Sysmac Error Status (2002-01 hex) automatically to the PDO.

Note

- For the Sysmac Error status (2002-01 hex), refer to 12-5 Object Dictionary p. 446.
- For errors displayed in Sysmac Studio, refer to *NJ-series Troubleshooting Manual* (Cat. No. W503).

Saving the Node Address Setting

When the node address switch setting is "00" (Software Setup mode), the node address value you set in Sysmac Studio is enabled. If the node address switches are set to any other value, the value that is set on the switches is used as the node address.

In the Software Setup mode, in Sysmac Studio, execute [Write Slave Node Address] on the [EtherCAT Edit] screen to save the slave node address setting in the nonvolatile memory of the FQ-M series Vision Sensor.

● Software Setting

The set value saved as Slave Information Interface (SII) information in the nonvolatile memory of the slave is the node address.

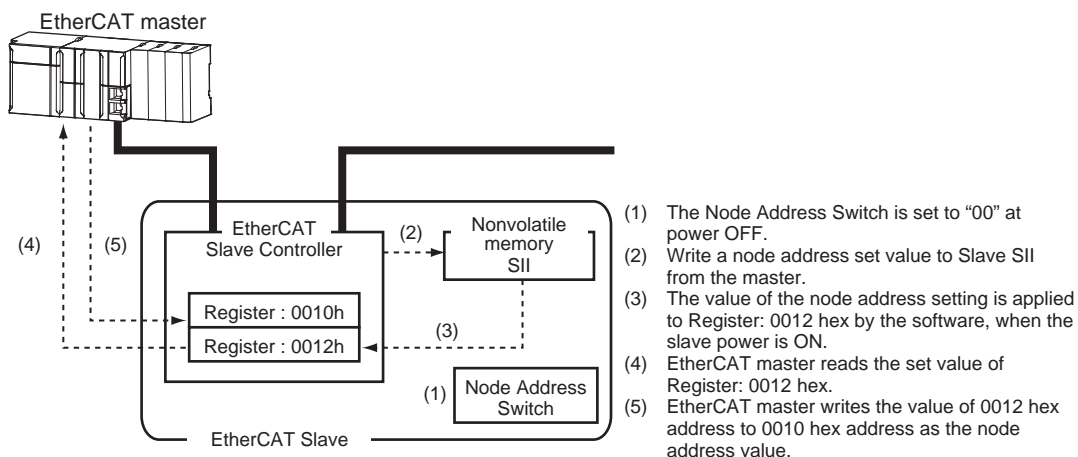

● Node Address Switch Setting

The value set on the node address switches is the node address.

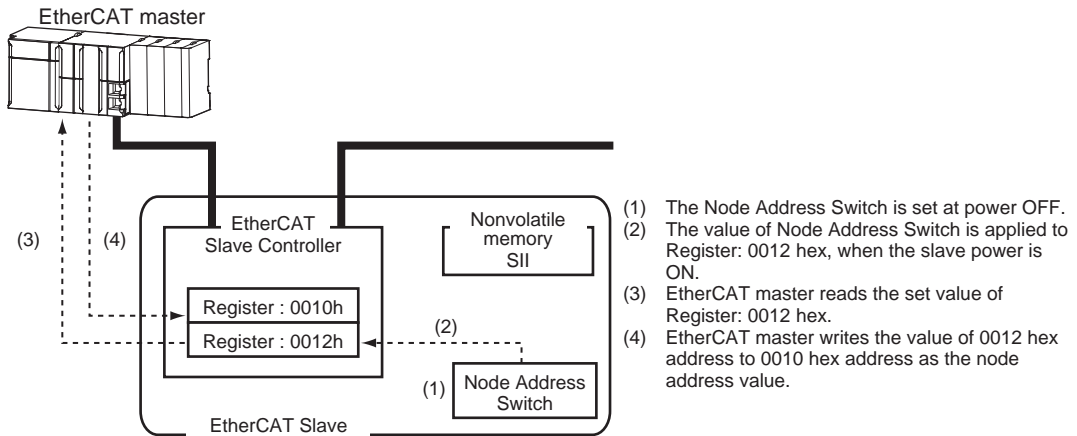

Serial Number Display

The serial number saved in the nonvolatile memory of the Vision Sensor is displayed in the Serial Number (1018-04 hex). Controllers that support Sysmac Device Features can use this serial number to check the network configuration. To enable this check, in Sysmac Studio, set [Serial No. Check Condition] to [Set Value = Actual Unit] on the [EtherCAT Edit] screen. If the set condition is not met, a Network Configuration Check Error will occur.

Note

This network configuration check detects any slave devices that have been replaced, which prevents you from forgetting to set parameters on those slaves.

Compliance with ESI Specification (ETG.2000 S (R) V1.0.1)

The ESI Specification is a set of specifications that define the entries required in an EtherCAT Slave Information (ESI) file.

SII Data Check

The Slave Information Interface (SII) is an interface area in the nonvolatile memory of an EtherCAT slave that stores the configuration information specific to that EtherCAT slave.

Sysmac Device EtherCAT slaves check the SII information from the slave side.

If one of these slaves finds that SII information with which it cannot operate was written, it generates an SII Check Error (Error No. 88.3). If this error persists even after turning OFF and then ON the power again, contact your OMRON sales representative.

Important

Do not use third-party or any other configuration tools to edit the SII information.

8-3 PLC Link Connections

You can use a PLC Link to communicate between the PLC and the Vision Sensor to perform control via command/response communications or to output data after measurements. You can use these communications methods simultaneously. A PLC Link can be used only when [EtherCAT] for EtherCAT communications is set to [OFF].

● Command/Response Communications

For PLC Link communications, command/response control signals are handled by storing control commands from the PLC to the Vision Sensor and responses from the Vision Sensor to the PLC in the I/O memory of the PLC. This allows you to control the operation of the Vision Sensor (e.g., perform single inspections or change the scene) without using communications instructions.

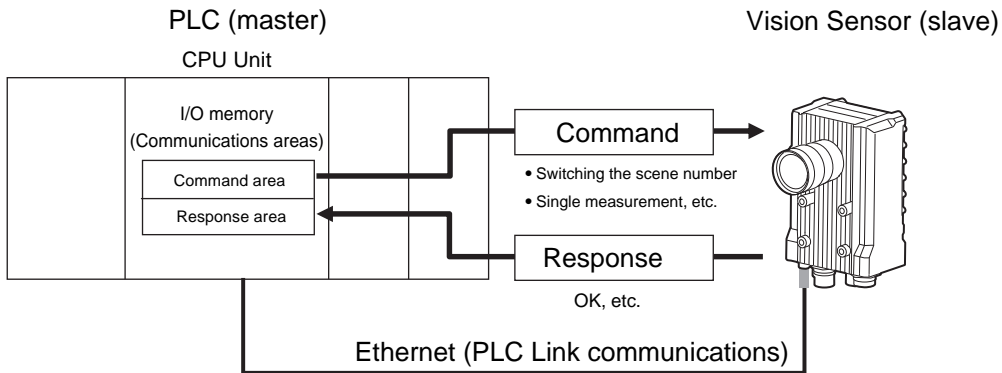

After you write a control command to the specified Command Area in the I/O memory of the PLC, you can turn ON the Command Execution (EXE) Bit to send the control command to the Vision Sensor via Ethernet. The Vision Sensor executes the control command and sends a response back to the PLC via Ethernet. The PLC stores the response in the specified Response Area in I/O memory.

● Data Output after Measurements

Immediately after a single measurement or continuous measurements, the Vision Sensor will automatically output to the specified I/O memory in the PLC the data for measurements that are specified for output in advance. This enables you to easily transfer the measurement results data for inspection items to the PLC. When handshaking is enabled, the data can be output from the Vision Sensor only when the condition to receive that data are met at the PLC.

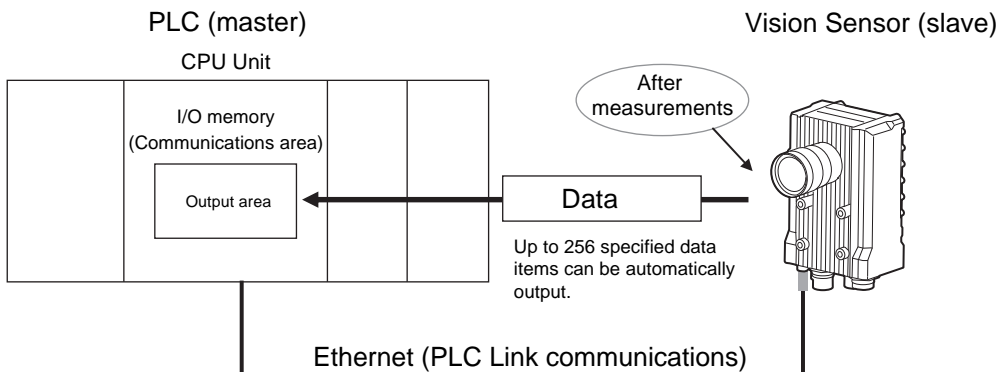

You must specify in advance the data to output after measurements. You must also specify in advance the Output Area in I/O memory to store the data in the PLC. After a single measurement or continuous measurements, the data is automatically stored in the Output Area of the PLC via Ethernet.

For PLC Link communications, the following three communications areas are set in the PLC to perform communications.

Command/response communications	1. Command area	This is the area to which you write control commands for the Vision Sensor to execute.
	2. Response area	This is the area to which the Vision Sensor writes the results of control commands executed from the Command Area.
Data output after measurements	3. Output area	This is the area to which the Vision Sensor writes output data for measurements after an inspection is performed.

You can set the area and address settings in the communications specifications of the Vision Sensor to assign the above three communications areas in the I/O memory of the PLC.

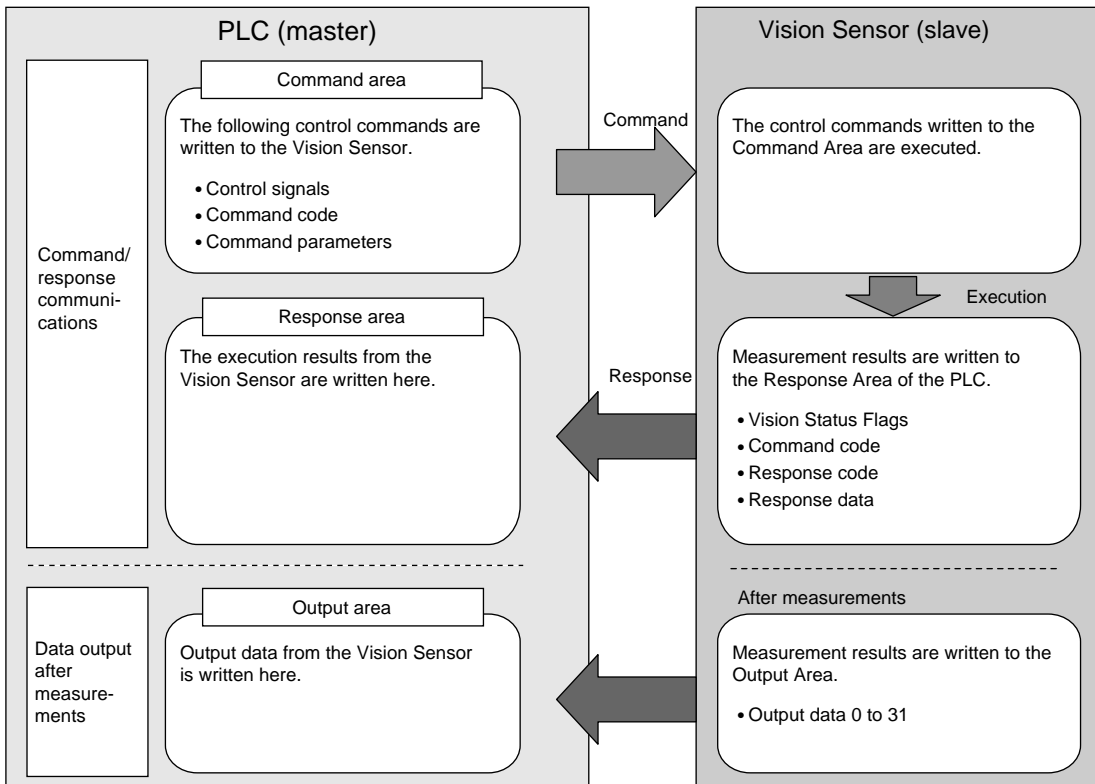

Note

A PLC Link uses three link areas to perform communications: the Command Area, Response Area, and Output Area. A PLC Link is not the same as the Serial PLC Link protocol that is used to connect OMRON PLCs together with a serial cable.

Important

An FQ-M Sensor operates as a TCP server. Therefore, the TCP connection must be made from the PLC. Refer to the manual for the PLC for TCP connection methods.

- The port number on the FQ-M Vision Sensor is always 9877.

PLC Link-compatible Models

● OMRON

Series	CPU	Interface	
		Built-in port in CPU Unit	Ethernet Unit
SYSMAC CJ2	CJ2, CJ2M	Supported (Built-in port only)	CJ1W-EIP21, CJ1W-ETN21
SYSMAC CJ1	CJ1H, CJ1G	---	CJ1W-EIP21, CJ1W-ETN21
	CJ1M	Supported (Built-in port only)	CJ1W-EIP21, CJ1W-ETN21
SYSMAC CS	CS1H, CS1D, CS1G	---	CS1W-EIP21, CS1W-ETN21
SYSMAC CP1	CP1L	Supported (Built-in port only)	---
	CP1H	---	CJ1W-EIP21, CJ1W-ETN21
SYSMAC One	NSJ	---	NSJW-ETN21

● Mitsubishi Electric Corporation

Series	Model name	CPU name	CPU	Interface	
				Built-in port in CPU Unit	Ethernet Unit
MELSEC-QnU	Universal model	QnUDECPU	Q03UDECPU, Q04UDEHCPU, Q06UDEHCPU, Q10UDEHCPU, Q13UDEHCPU, Q20UDEHCPU, Q26UDEHCPU	Supported	QJ71E71-100, QJ71E71-B2, QJ71E71-B5
		QnUDCPU	Q03UDCPU, Q04UDHCPU, Q06UDHCPU, Q10UDHCPU, Q13UDHCPU, Q20UDHCPU, Q26UDHCPU	---	
		QnUCPU	Q00UJCPU, Q00UCPU, Q01UCPU, Q02UCPU	---	
	Basic model	QnCPU	Q00JCPU, Q00CPU, Q01CPU	---	
MELSEC-Q	High-performance model	QCPU	Q02CPU, Q02HCPU, Q06HCPU, Q12HCPU, Q25HCPU	---	

Series	Model name	CPU name	CPU	Interface	
				Built-in port in CPU Unit	Ethernet Unit
MELSEC-QnAS	---	---	Q2ASCPU, Q2ASCPU-S1, Q2ASHCPU, Q2ASHCPU-S1	---	A1SJ71QE71N3-T

Setting Up PLC Link Communications

Setting Network Settings in the Sensor

This section describes how to set the network settings in the Vision Sensor.

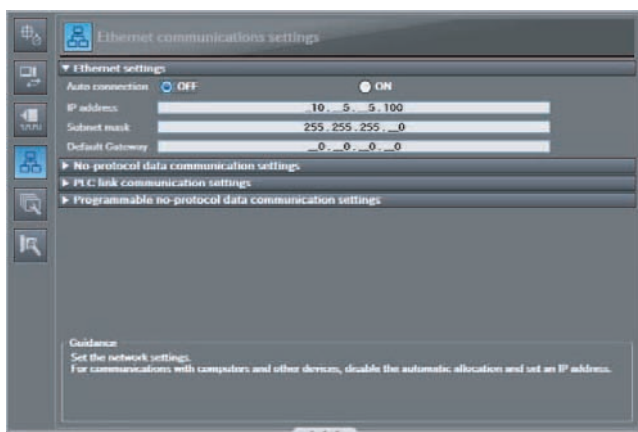

- ▶ **Multiview Explorer: [Device group] – Sensor name – [System] – [System data] (Double-click)**
 → **Edit Pane:  (Ethernet communications settings) Icon – [Ethernet settings]**



The following items can be set.

Item	Description	Setting range
Auto connection	Select whether the IP address is assigned automatically. To communicate with a PLC or other external device, set [Auto connection] to OFF and set the IP address setting described below.	OFF or ON Default: ON
IP address	Set the IP address of the Vision Sensor.	a: 1 to 223, b: 0 to 255, c: 0 to 255, d: 1 to 254 Default: 10.5.5.100
Subnet mask	Set the subnet mask.	0.0.0.0 to 255.255.255.255 Default: 255.255.255.0
Default Gateway	Sets the default gateway.	0.0.0.0 to 255.255.255.255 Default: 0.0.0.0

Important

- Changes to settings are not applied until the Vision Sensor is restarted. Therefore, save the settings and then restart the Vision Sensor.
 -  5-5 Saving Data to the Sensor p. 161
 -  Restarting the Sensor p. 210
- The port number on the FQ-M Vision Sensor is always 9877.

Initial Settings for PLC Link Communications

You must set the IP address of the PLC to connect to, assign the Command Area, Response Area, and Output Area, and make other settings to perform PLC Link communications.

- **Multiview Explorer: [Device group] – Sensor name – [System] – [System data] (Double-click)**
 → **Edit Pane:**  (Ethernet communications settings) Icon – [PLC link communication settings]

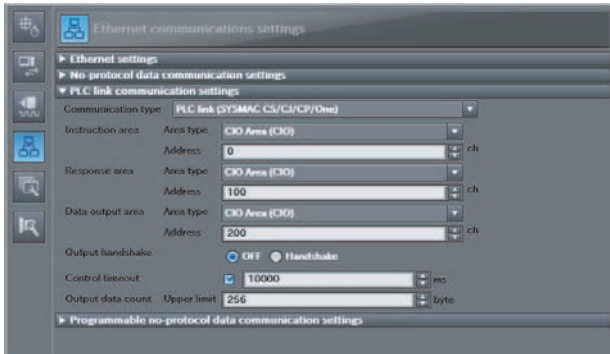

The following items can be set.

Item	Description	Setting range
Communication type	Select the communications method. You can select the communications method only when [EtherCAT] under the EtherCAT settings is set to [OFF].	<ul style="list-style-type: none"> • PLC Link (SYSMAC CS/CJ/CP/One) • PLC Link (MELSEC QnU/Q/QnAS) • — (Default: —)
Command area kind	Select the area for the Command Area in the PLC.	If PLC Link (SYSMAC CS/CJ/CP/One) is selected: <ul style="list-style-type: none"> • CIO Area (CIO) • Work Area (WR) • Holding Bit Area (HR) • Auxiliary Bit Area (AR) • DM Area (DM) • EM Area (EMO) to (EMC) • Default: CIO Area (CIO) If PLC Link (MELSEC QnU/Q/QnAS) is selected: <ul style="list-style-type: none"> • Data registers • File registers • Link registers • Default: Data registers
Command area address	Set the first address of the command area in the PLC.	0 to 99,999 Default: 0
Response area kind	Set the PLC memory area for the response area.	Same as for the Command Area.
Response area address	Set the first address of the response area in the PLC.	0 to 99,999 Default: 100
Data Output area kind	Set the PLC memory area for the output area.	Same as for the Command Area.

Item	Description	Setting range
Output area address	Set the first address of the output area in the PLC.	0 to 99,999 Default: 200
Output control	Enables or disables handshaking. <ul style="list-style-type: none"> • Handshake: Data is output when the DSA signal from the PLC turns ON. • None: Data is output regardless of the signal state from the PLC. 	None or Handshake Default: None
Timeout (only when handshaking is enabled)	Sets the time for a timeout error to occur in 1-ms increments when handshaking is used. <div style="border: 1px solid black; padding: 2px; margin: 5px 0;"> <p>Note</p> </div> <hr/> <p>If the PLC does not retrieve the data even after the timeout time is exceeded, the Vision Sensor adds error information to the error log.</p>	100 to 120,000ms Default: 10,000 ms
Number of output data upper value	Sets the maximum data size that can be output at one time through PLC Link communications. The size is set in bytes. Any data that exceeds the set value is discarded.	32 to 1,024 bytes Default: 256 bytes

• Operation on the Touch Finder

Use the following menu command to display the Setup Display on the Touch Finder.

▶  **(Setup Mode) – [Sensor settings] – [Network]**

Important

- Changes to settings are not applied until the Vision Sensor is restarted. Therefore, save the settings and then restart the Vision Sensor.

 5-5 Saving Data to the Sensor p. 161

 Restarting the Sensor p. 210

Setting the Data To Output Automatically after Measurements

You can set the data to output automatically after measurements. (You can set up to 32 data items.)

Data That Can Be Output

You can output up to 32 data items (data 0 to data 31). The measurement data from inspection items that can be output and the calculation results from the expression settings can be output. For data that can be output, refer to the *Measurement Data That Can Be Used for External Outputs and Calculations* for each inspection item.

Checking PLC Link Communications Settings

You can check the current PLC Link communications settings.

▶ **Multiview Explorer: [Device group] – Sensor name – [Scene] – Scene data number (Double-click)**

→ **Edit Pane:  (Output) Icon – [Communication settings]**

If you click the [Output] Button while setting up inspection items, the following Output Setting Main Window is display.

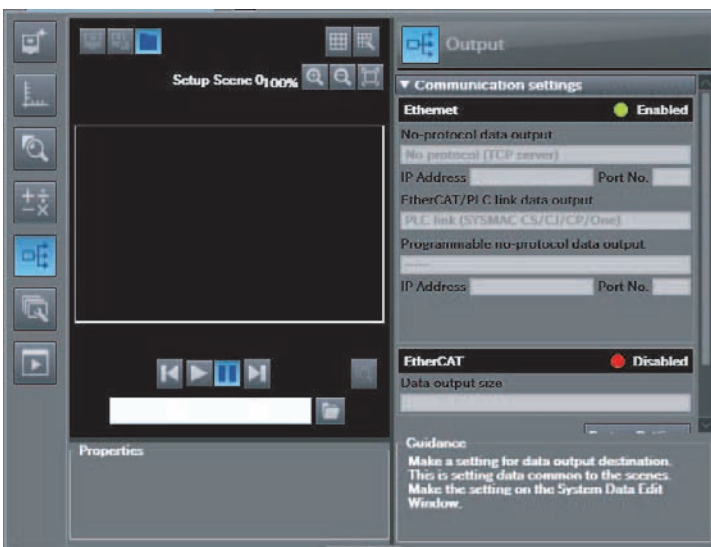

Item	Description
Output destination settings	<p>The settings of the following parameters in the system data are displayed.</p> <ol style="list-style-type: none"> 1. Ethernet Setting Status <ul style="list-style-type: none"> Enabled (green): Output no-protocol data, output link data, or programmable no-protocol data is selected as the communications method. Disabled (red): All settings are disabled. 2. The following output no-protocol data, output link data, programmable no-protocol data parameters: <ul style="list-style-type: none"> • Communication method • IP address • Port number
Output properties	<p>The properties of the output data that is selected in the data output list are displayed.</p>

Note

If outputting link data is not set in the output destination settings, click the [Edit system data] Button and make the initial settings for PLC Link communications in the Ethernet Communication Dialog Box.

Allocating Output Data

- ▶ **Multiview Explorer:** [Device group] – Sensor name – [Scene] – Scene data number (Double-click)
 - **Edit Pane:**  (Output) Icon – [No-protocol data output]
- 1** In the Output Settings Main Pane, right-click the output data number to set in the output data list under [No-protocol data output] and select [Edit].

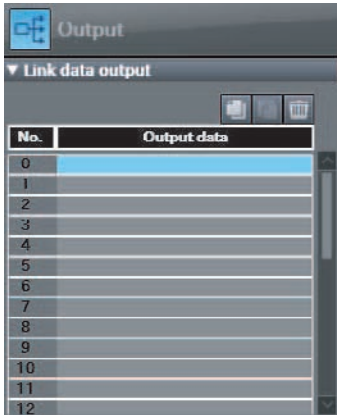

The following Output Dialog Box is displayed.

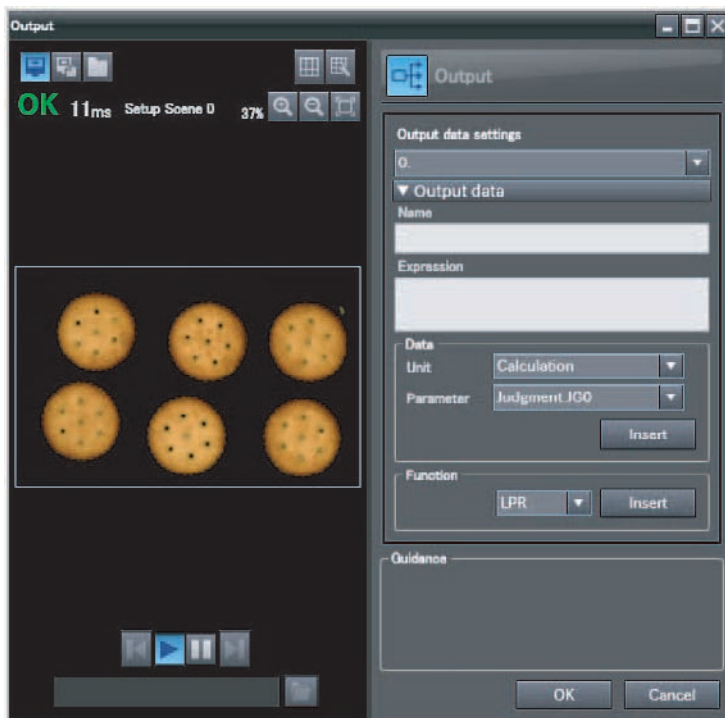

2 Set the data to output in the Output Dialog Box.

Item	Description
Output data settings	The number of the output data that was selected for setting is displayed.
Name	You can change the name of the output data. Max. number of characters: 15
Expression	Registers the output data item or multiple data output function. Examples: I0.X LPR(0, 3, I0.X, I0.Y) LPC(0, I0.C, I0.X, I0.Y)
Data	You can insert parameters selected from Units and parameters into expressions.
Unit	Select one of the following. An inspection item that has the output item to use for the output data. Calculation
Parameter	Select the output item from the selected unit. Example: If the Search inspection item was selected, you can select either of the following: Judgement results: Judgement JG or Correlation: Corre. CR
Function	The following functions can be inserted. <ul style="list-style-type: none"> In Multiple Data Output Mode, select one of the following types of multiple data output functions. <ul style="list-style-type: none"> Data logging order: LPR function The measurement data is output in order. Format: LPR (<i>start_number,number_of_data,data_A, data_B,data_C...</i>) Output Example: LPR(0,3,I0.X,I0.Y,I0.Z) X0,Y0,Z0,X1,Y1,Z1,X2,Y2,Z2 Detection point order: LPC function Outputs data for each detected measurement point. Format: LPC (<i>start_number,number_of_data,data_A, data_B,data_C...</i>) Output Example: LPC(0,3,I0.X,I0.Y,I0.Z) X0,X1,X2,Y0,Y1,Y2,Z0, Z1, Z2,,, You can specify up to five data items as the above LPR and LPC functions arguments. Encoder Value Output Function <ul style="list-style-type: none"> Encoder Value Output: ECNT function The encoder value is output. Format: ECNT(argument) Output Example: ECNT(0) 0: Ring counter value at measurement trigger 1: Ring counter value at calculation 2: Trigger counter value at calculation

3 Click the [OK] Button.

4 Set the output format.

Set the output format in [Output format] under [EtherCAT/PLC link data output setting].



Item	Description	Setting range
Output format	Sets the output format for numerical data.	Floating point or fixed point Default: Floating point

● Expression Setting Example

This example registers an expression to output the following inspection results for data 0.

Inspection item: 0 Search

Parameters to output: Position X, Position Y, Reference SX, and Reference SY

Multi-point output setting: Multi-point output Check Box selected, Count = 4

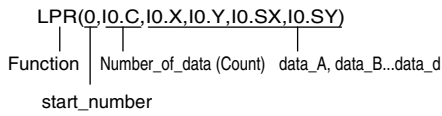

Output Results

The expression that is registered for data 0 assigns the data for 16 items (64 bytes) in the output area as shown below.

Output area data	Assigned data
Output data 0 (4 bytes)	I0.X[0] (Position X 1st point)
Output data 1 (4 bytes)	I0.Y[0] (Position Y 1st point)
Output data 2 (4 bytes)	I0.SX[0] (Reference SX 1st point)
Output data 3 (4 bytes)	I0.SY[0] (Reference SY 1st point)
Output data 4 (4 bytes)	I0.X[1] (Position X 2nd point)
Output data 5 (4 bytes)	I0.Y[1] (Position Y 2nd)
Output data 6 (4 bytes)	I0.SX[1] (Reference SX 2nd point)
Output data 7 (4 bytes)	I0.SY[1] (Reference SY 2nd point)
Output data 8 (4 bytes)	I0.X[2] (Position X 3rd)
Output data 9 (4 bytes)	I0.Y[2] (Position Y 3rd)
Output data 10 (4 bytes)	I0.SX[2] (Reference SX 3rd point)
Output data 11 (4 bytes)	I0.SY[2] (Reference SY 3rd point)
Output data 12 (4 bytes)	I0.X[3] (Position X 4th)
Output data 13 (4 bytes)	I0.Y[3] (Position Y 4th)
Output data 14 (4 bytes)	I0.SX[3] (Reference SX 4th point)
Output data 15 (4 bytes)	I0.SY[3] (Reference SY 4th point)

Note

The inspection results will be output according to the sorting method that is set for multi-point output for the inspection item.

● Output Data Size and Number of Output Data Upper Value Setting

When more than one inspection result is output, the size of the data that is output for the data output settings could exceed the limit that is set in the number of output data upper value setting.

If that occurs, increase the set value of the number of output data upper value setting or adjust the output data settings so that data output size is not exceeded.

If the size of data that is output does exceed the set value of the number of output data upper value setting, the remaining data will be discarded.

Example

Output data size: 328 bytes

Number of output data upper value setting: 256 bytes

Data Output Settings

Output data	Setting	
Data 0	I0.X[0]	Inspection item 0: Position X for Search
Data 1	I0.Y[0]	Inspection item 0: Position Y for Search
Data 2	LPC (0,30,I1.X,I1.Y)	Inspection item 1: Position X 1st point for Shape Search Inspection item 1: Position X 30th point for Shape Search Inspection item 1: Position Y 1st point for Shape Search Inspection item 1: Position Y 30th point for Shape Search
Data 3	LPR (0,10,I2.X,I2.Y)	Inspection item 2: Position X 1st point for Shape Search Inspection item 2: Position Y 1st point for Shape Search Inspection item 2: Position X 10th point for Shape Search Inspection item 2: Position Y 10th point for Shape Search

} 328 bytes

The output data that is assigned is output to the output area as shown below.

Any output data that exceeds the set value of the number of output data upper value setting (256 bytes) is discarded.

Offset from first address in output area	Output data	Assigned output data
+0	Output data 0 (4 bytes)	Inspection item 0: Position X for Search
+1		
+2	Output data 1 (4 bytes)	Inspection item 0: Position Y for Search
+3		
+4	Output data 2 (4 bytes)	Inspection item 1: Position X 1st point for Shape Search
+5		
...
+62	Output data 31 (4 bytes)	Inspection item 1: Position X 30th point for Shape Search
+63		
+64	Output data 32 (4 bytes)	Inspection item 1: Position Y 1st point for Shape Search
+65		
...
+122	Output data 61 (4 bytes)	Inspection item 1: Position Y 30th point for Shape Search
+123		
+124	Output data 62 (4 bytes)	Inspection item 2: Position X 1st point for Shape Search
+125		
+126	Output data 63 (4 bytes)	Inspection item 2: Position Y 1st point for Shape Search
+127		
+128	Output data 64 (4 bytes)	Inspection item 2: Position X 2nd point for Shape Search
+129		
...
+160	Output data 80 (4 bytes)	Inspection item 2: Position X 10th point for Shape Search
+161		
+162	Output data 81 (4 bytes)	Inspection item 2: Position Y 10th point for Shape Search
+163		

} 256 bytes
(This data is output.)

} 72 bytes
The data that exceeds the set upper limit is discarded.

Memory Assignments for PLC Link Communications

This section describes the assignments for the Command, Response, and Data Output Areas.

● Command Area

PLC (Master) to Vision Sensor (Slave)

First word	Bits																Contents
	15	14	13	12	11	10	9	8	7	6	5	4	3	2	1	0	
+0	ERRCLR	Resv	Resv	Resv	Resv	Resv	Resv	Resv	Resv	Resv	Resv	Resv	Resv	Resv	Resv	EXE	Control signals (32 bits)
+1	Resv	Resv	Resv	Resv	Resv	Resv	Resv	Resv	Resv	Resv	Resv	Resv	Resv	Resv	Resv	DSA	
+2	Command code																Command code (32 bits)
+3																	
+4	Parameter 1																Parameter (integer)
+5																	
+6	Parameter 2																Spare (integer)
+7																	
+8	Parameter 3																Spare (integer)
+9																	

Signal	Signal name	Function	Application
EXE	Control Command Execution Bit	Turn ON this signal from the PLC to send a control command for the Vision Sensor to execute.	Command/response communications
		Turn OFF the EXE signal from the PLC when the Control Command Completed (FLG) signal from the Vision Sensor turns ON. (Set the control command code and parameters before you turn ON this signal.)	
DSA	Data Output Request Bit	Turn ON this signal from the PLC to request data output. When this signal turns ON, the Vision Sensor outputs data.	Data output after measurements
		Turn OFF the DSA signal from the PLC when the Data Output Completed (GATE) signal from the Vision Sensor turns ON.	
ERRCLR	Clear Error	Turn ON this signal to turn OFF the error (ERR) signal from the Vision Sensor.	Command/Response Communications
		Turn OFF this signal from PLC when the error (ERR) signal goes OFF.	
Command code	Command code	This I/O port stores the command code.	Command/Response Communications
Parameters 1 to 3	Command parameters	These I/O ports store the command parameters.	

● Response Area

Vision Sensor (Slave) to PLC (Master)

First word	Bits																Contents
	15	14	13	12	11	10	9	8	7	6	5	4	3	2	1	0	
+0	ERR	Resv	Resv	Resv	Resv	Resv	Resv	Resv	Resv	Resv	Resv	Resv	Resv	READY	BUSY	FLG	Control signals (32 bits)
+1	Resv	Resv	Resv	Resv	Resv	Resv	Resv	Resv	Resv	Resv	Resv	Resv	Resv	Resv	Resv	GATE	
+2	Command code																Command code (32 bits)
+3																	
+4	Response code																Response code (32 bits)
+5																	
+6	Response data																Response data (32 bits)
+7																	

Signal	Signal name	Function	Application
FLG	Control Command Completed	This signal turns ON when the Vision Sensor completes execution of the control command.	Command/response communications
		This signal automatically turns OFF when the Control Command Execution Bit (EXE) signal from the PLC turns OFF. This signal turns ON after the control command code, response code, and response data have been stored.	
BUSY	Command Execution Active	This signal is ON while the Vision Sensor is executing a control command.	
		It is OFF while the Vision Sensor is not executing a control command.	
READY	Ready	This signal turns ON when the Vision Sensor can execute a command.	Command/response communications
		This signal turns OFF when the Vision Sensor cannot execute a command.	
ERR	Error	This signal turns ON when an error is detected in the Vision Sensor.	Command/response communications
		This signal turns OFF when the Clear Error (ERRCLR) signal from the PLC turns ON.	
GATE	Data Output Completed	This signal turns ON when the Vision Sensor finishes outputting data.	Data output after measurements
		If handshaking is enabled, the GATE signal turns OFF automatically when you turn OFF the Data Output Request (DSA) signal from the PLC.	
Command code	Command code	This I/O port returns the command code that was executed.	Command/response communications
Response code	Response code	This I/O port contains the response code of the executed command.	
Response data	Response data	This I/O port contains the response data of the executed command.	

● Output Area

Vision Sensor (Slave) to PLC (Master)

First word	Bits																Contents
	15	14	13	12	11	10	9	8	7	6	5	4	3	2	1	0	
+0	DATA 0																Output data 0 (32 bits)
+1																	
⋮	⋮																⋮
⋮																	
+14	DATA 7																Output data 7 (32 bits)
+15																	
⋮	⋮																⋮
⋮																	
+128	DATA 63																Output data 63 (32 bits)
+219																	
⋮	⋮																⋮
⋮																	
+512	DATA 255																Output data 255 (32 bits)
+513																	

Signal	Signal name	Function	Application
DATA0-255	Output data 0 to 255	These I/O ports output the output data that is specified for the data output method. The range of the data that can be output is determined by the set value of the number of output data upper value setting as follows: Minimum setting (32 bytes): Output data 0 to 7 Default setting (256 bytes): Output data 0 to 63 Maximum setting (1,024 bytes): Output data 0 to 255	Data output after measurements

Note

If the size of data that is output exceeds the set value of the number of output data upper value setting, the remaining data will be discarded.

 Allocating Output Data p. 236

Command Tables for PLC Link Communications

This section describes the commands used in PLC Link communications.

● Measurement Control Commands

First word of command area (hex)		Command name	Function	Reference
+2	+3			
1010	0010	Single Measurement	Performs a single measurement.	p. 283
1020	0010	Start Continuous Measurements	Executes continuous measurements.	p. 284
1030	0010	End Continuous Measurements	Ends continuous measurements.	p. 284

● Utility Commands

First word of command area (hex)		Command name	Function	Reference
+2	+3			
2010	0010	Clear Measurement Values	Clears all measurement result values.	p. 285
2030	0010	Reset Encoder Counter	Resets the encoder counter.	p. 285
3010	0010	Save Data in Sensor	Saves the current system data and scene groups in the Sensor.	p. 286
4010	0010	Re-register Model	Registers the model again.	p. 286
F010	0010	Reset	Resets the Vision Sensor.	p. 286
5000	0020	Get Latest Error Information	Acquires the latest error information.	p. 287

● Scene Control Commands

First word of command area (hex)		Command name	Function	Reference
+2	+3			
1000	0020	Get Scene Number	Acquires the current scene number.	p. 287
1000	0030	Select Scene	Changes to the specified scene number.	p. 288

● Data Acquisition/Setting Commands

First word of command area (hex)		Command name	Function	Reference
+2	+3			
1020	0040	Get Inspection Item Data	Acquires the inspection item data.	p. 288
1020	0050	Set Inspection Item Data	Sets the inspection item data to the specified data.	p. 289
3000	0040	Get Software Version Information	Acquires the software version.	p. 290
6000	0020	Get Ring Counter	Acquires the ring counter value.	p. 290
6000	0030	Set Ring Counter	Sets the ring counter value.	p. 291

Command Details

● Single Measurement (Command Code: 1010 0010)

Command (PLC to Vision Sensor)

First word of command area (hex)	Bits				Contents
	12 to 15	8 to 11	4 to 7	0 to 3	
+2	0001	0000	0001	0000	Command code: 4-byte binary data
+3	0000	0000	0001	0000	

Response (Vision Sensor to PLC)

First word of response area (hex)	Bits				Contents
	12 to 15	8 to 11	4 to 7	0 to 3	
+2	0001	0000	0001	0000	Command code The command code for which the response applies is stored.
+3	0000	0000	0001	0000	
+4	0000	0000	0000	0000	Response code Command execution result 0: OK, FFFFFFFF: NG
+5	0000	0000	0000	0000	

Note

The measurement results are written to the output area if data output is set.
The measurement results are not output if data output is not set.



Setting the Data To Output Automatically after Measurements: p. 273

● Start Continuous Measurements (Command Code: 1020 0010)

Command (PLC to Vision Sensor)

First word of command area (hex)	Bits				Contents
	12 to 15	8 to 11	4 to 7	0 to 3	
+2	0001	0000	0010	0000	Command code
+3	0000	0000	0001	0000	

Response (Vision Sensor to PLC)

First word of response area (hex)	Bits				Contents
	12 to 15	8 to 11	4 to 7	0 to 3	
+2	0001	0000	0010	0000	Command code
+3	0000	0000	0001	0000	The command code for which the response applies is stored.
+4	0000	0000	0000	0000	Response code
+5	0000	0000	0000	0000	Command execution result 0: OK, FFFFFFFF: NG

Note

The measurement results are written to the output area if data output is set.
The measurement results are not output if data output is not set.



Setting the Data To Output Automatically after Measurements: p. 273

● End Continuous Measurements (Command Code: 1030 0010)

Command (PLC to Vision Sensor)

First word of command area (hex)	Bits				Contents
	12 to 15	8 to 11	4 to 7	0 to 3	
+2	0001	0000	0011	0000	Command code
+3	0000	0000	0001	0000	

Response (Vision Sensor to PLC)

First word of response area (hex)	Bits				Contents
	12 to 15	8 to 11	4 to 7	0 to 3	
+2	0001	0000	0011	0000	Command code
+3	0000	0000	0001	0000	The command code for which the response applies is stored.
+4	0000	0000	0000	0000	Response code
+5	0000	0000	0000	0000	Command execution result 0: OK, FFFFFFFF: NG

● Clear Measurement Values (Command Code: 2010 0010)

Command (PLC to Vision Sensor)

First word of command area (hex)	Bits				Contents
	12 to 15	8 to 11	4 to 7	0 to 3	
+2	0010	0000	0001	0000	Command code
+3	0000	0000	0001	0000	

Response (Vision Sensor to PLC)

First word of response area (hex)	Bits				Contents
	12 to 15	8 to 11	4 to 7	0 to 3	
+2	0010	0000	0001	0000	Command code The command code for which the response applies is stored.
+3	0000	0000	0001	0000	
+4	0000	0000	0000	0000	Response code Command execution result 0: OK, FFFFFFFF: NG
+5	0000	0000	0000	0000	

● Reset Encoder Counter (Command Code: 2030 0010)

Command (PLC to Vision Sensor)

First word of command area (hex)	Bits				Contents
	12 to 15	8 to 11	4 to 7	0 to 3	
+2	0000	0010	0000	0011	Command code
+3	0000	0000	0001	0000	
+4	0000	0000	0000	0000	Reset target 0: Reset the trigger counter and ring counter. 1: Reset the ring counter. 2: Reset the trigger counter.
+5	0000	0000	0000	0000	

Response (Vision Sensor to PLC)

First word of response area (hex)	Bits				Contents
	12 to 15	8 to 11	4 to 7	0 to 3	
+2	0001	0000	0000	0000	Command code The command code for which the response applies is stored.
+3	0000	0000	0011	0000	
+4	0000	0000	0000	0000	Response code Command execution result 0: OK, FFFFFFFF: NG
+5	0000	0000	0000	0000	

● Save Data in Sensor (Command Code: 3010 0010)

Command (PLC to Vision Sensor)

First word of command area (hex)	Bits				Contents
	12 to 15	8 to 11	4 to 7	0 to 3	
+2	0011	0000	0001	0000	Command code
+3	0000	0000	0001	0000	

Response (Vision Sensor to PLC)

First word of response area (hex)	Bits				Contents
	12 to 15	8 to 11	4 to 7	0 to 3	
+2	0011	0000	0001	0000	Command code
+3	0000	0000	0001	0000	The command code for which the response applies is stored.
+4	0000	0000	0000	0000	Response code
+5	0000	0000	0000	0000	Command execution result 0: OK, FFFFFFFF: NG

● Reregister Model (Command Code: 4010 0010)

Command (PLC to Vision Sensor)

First word of command area (hex)	Bits				Contents
	12 to 15	8 to 11	4 to 7	0 to 3	
+2	0100	0000	0001	0000	Command code
+3	0000	0000	0001	0000	

Response (Vision Sensor to PLC)

First word of response area (hex)	Bits				Contents
	12 to 15	8 to 11	4 to 7	0 to 3	
+2	0100	0000	0001	0000	Command code
+3	0000	0000	0001	0000	The command code for which the response applies is stored.
+4	0000	0000	0000	0000	Response code
+5	0000	0000	0000	0000	Command execution result 0: OK, FFFFFFFF: NG

● Reset Vision Sensor (Command Code: F010 0010)

Command (PLC to Vision Sensor)

First word of command area (hex)	Bits				Contents
	12 to 15	8 to 11	4 to 7	0 to 3	
+2	1111	0000	0001	0000	Command code
+3	0000	0000	0001	0000	

Response (Vision Sensor to PLC)

First word of response area (hex)	Bits				Contents
	12 to 15	8 to 11	4 to 7	0 to 3	

There is no response for a reset operation.

● Get Latest Error Information (Command Code: 5000 0020)

Command (PLC to Vision Sensor)

First word of command area (hex)	Bits				Contents
	12 to 15	8 to 11	4 to 7	0 to 3	
+2	0101	0000	0000	0000	Command code
+3	0000	0000	0010	0000	

Response (Vision Sensor to PLC)

First word of response area (hex)	Bits				Contents
	12 to 15	8 to 11	4 to 7	0 to 3	
+2	0101	0000	0000	0000	Command code
+3	0000	0000	0010	0000	The command code for which the response applies is stored.
+4	0000	0000	0000	0000	Response code
+5	0000	0000	0000	0000	Command execution result 0: OK, -1: NG
+6	0000	0000	0000	0000	Response data
+7	0000	0000	0000	0000	Latest error code  Errors Stored in the Error History p. 388

● Get Scene Number (Command Code: 1000 0020)

Command (PLC to Vision Sensor)

First word of command area (hex)	Bits				Contents
	12 to 15	8 to 11	4 to 7	0 to 3	
+2	0001	0000	0000	0000	Command code
+3	0000	0000	0010	0000	

Response (Vision Sensor to PLC)

First word of response area (hex)	Bits				Contents
	12 to 15	8 to 11	4 to 7	0 to 3	
+2	0001	0000	0000	0000	Command code The command code for which the response applies is stored.
+3	0000	0000	0010	0000	
+4	0000	0000	0000	0000	Response code Command execution result 0: OK, FFFFFFFF: NG
+5	0000	0000	0000	0000	
+6	0000	0000	0000	0000	Response data Acquired scene number
+7	0000	0000	0000	0000	

● Select Scene (Command Code: 1000 0030)

Command (PLC to Vision Sensor)

First word of command area (hex)	Bits				Contents
	12 to 15	8 to 11	4 to 7	0 to 3	
+2	0001	0000	0000	0000	Command code
+3	0000	0000	0011	0000	
+4	0000	0000	0000	0000	Scene number
+5	0000	0000	0000	0000	

Response (Vision Sensor to PLC)

First word of response area (hex)	Bits				Contents
	12 to 15	8 to 11	4 to 7	0 to 3	
+2	0001	0000	0000	0000	Command code The command code for which the response applies is stored.
+3	0000	0000	0011	0000	
+4	0000	0000	0000	0000	Response code Command execution result 0: OK, FFFFFFFF: NG
+5	0000	0000	0000	0000	

● Get Inspection Item Data (Command Code: 1020 0040)

Command (PLC to Vision Sensor)

First word of command area (hex)	Bits				Contents
	12 to 15	8 to 11	4 to 7	0 to 3	
+2	0001	0000	0010	0000	Command code
+3	0000	0000	0100	0000	
+4	0000	0000	0000	0000	Unit number
+5	0000	0000	0000	0000	
+6	0000	0000	0000	0000	Data number
+7	0000	0000	0000	0000	

Response (Vision Sensor to PLC)

First word of response area (hex)	Bits				Contents
	12 to 15	8 to 11	4 to 7	0 to 3	
+2	0001	0000	0010	0000	Command code The command code for which the response applies is stored.
+3	0000	0000	0100	0000	
+4	0000	0000	0000	0000	Response code Command execution result 0: OK, FFFFFFFF: NG
+5	0000	0000	0000	0000	
+6	0000	0000	0000	0000	Acquired data (1,000 times the value)
+7	0000	0000	0000	0000	

● Set Inspection Item Data (Command Code: 1020 0050)

Command (PLC to Vision Sensor)

First word of command area (hex)	Bits				Contents
	12 to 15	8 to 11	4 to 7	0 to 3	
+2	0001	0000	0010	0000	Command code
+3	0000	0000	0101	0000	
+4	0000	0000	0000	0000	Unit number
+5	0000	0000	0000	0000	
+6	0000	0000	0000	0000	Data number
+7	0000	0000	0000	0000	
+8	0000	0000	0000	0000	Value to set (1,000 times the value)
+9	0000	0000	0000	0000	

Response (Vision Sensor to PLC)

First word of response area (hex)	Bits				Contents
	12 to 15	8 to 11	4 to 7	0 to 3	
+2	0001	0000	0010	0000	Command code The command code for which the response applies is stored.
+3	0000	0000	0101	0000	
+4	0000	0000	0000	0000	Response code Command execution result 0: OK, FFFFFFFF: NG
+5	0000	0000	0000	0000	

● Get Software Version Information (Command Code: 3000 0040)

Command (PLC to Vision Sensor)

First word of command area (hex)	Bits				Contents
	12 to 15	8 to 11	4 to 7	0 to 3	
+2	0011	0000	0000	0000	Command code
+3	0000	0000	0100	0000	

Response (Vision Sensor to PLC)

First word of response area (hex)	Bits				Contents
	12 to 15	8 to 11	4 to 7	0 to 3	
+2	0011	0000	0000	0000	Command code The command code for which the response applies is stored.
+3	0000	0000	0100	0000	
+4	0000	0000	0000	0000	Response code
+5	0000	0000	0000	0000	Command execution result 0: OK, FFFFFFFF: NG
+6	0000	0000	0000	0000	Response data
+7	0000	0000	0000	0000	Software version (DINT: 1,000 times the value)

● Get Ring Counter (Command Code: 6000 0020)

Command (PLC to Vision Sensor)

First word of command area (hex)	Bits				Contents
	12 to 15	8 to 11	4 to 7	0 to 3	
+2	0110	0000	0000	0000	Command code
+3	0000	0000	0010	0000	
+4	0000	0000	0000	0000	Counter timing 0: Current ring counter value at command execution 1: Ring counter value at trigger
+5	0000	0000	0000	0000	

Response (Vision Sensor to PLC)

First word of response area (hex)	Bits				Contents
	12 to 15	8 to 11	4 to 7	0 to 3	
+2	0110	0000	0000	0000	Command code The command code for which the response applies is stored.
+3	0000	0000	0010	0000	
+4	0000	0000	0000	0000	Response code
+5	0000	0000	0000	0000	Command execution result 0: OK, FFFFFFFF: NG
+6	0000	0000	0000	0000	Acquired data
+7	0000	0000	0000	0000	

● Set Ring Counter (Command Code: 6000 0030)

Command (PLC to Vision Sensor)

First word of command area (hex)	Bits				Contents
	12 to 15	8 to 11	4 to 7	0 to 3	
+2	0110	0000	0000	0000	Command code
+3	0000	0000	0011	0000	
+4	0000	0000	0000	0000	Value to set
+5	0000	0000	0000	0000	

Response (Vision Sensor to PLC)

First word of response area (hex)	Bits				Contents
	12 to 15	8 to 11	4 to 7	0 to 3	
+2	0110	0000	0000	0000	Command code
+3	0000	0000	0011	0000	The command code for which the response applies is stored.
+4	0000	0000	0000	0000	Response code
+5	0000	0000	0000	0000	Command execution result 0: OK, FFFFFFFF: NG

Timing Chart for PLC Link Communications

● Command/Response Communications

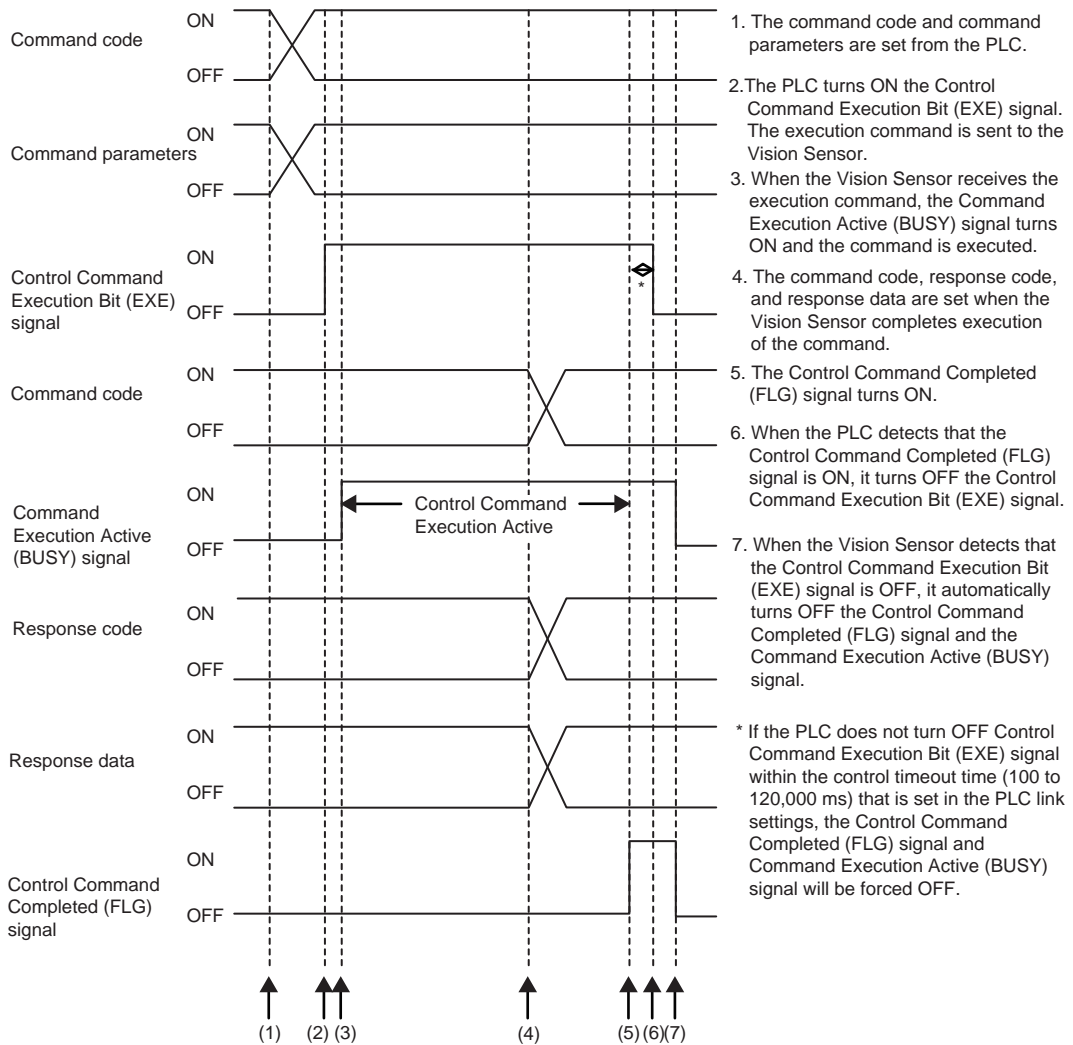

● Data Output after Measurements When Handshaking Is Enabled

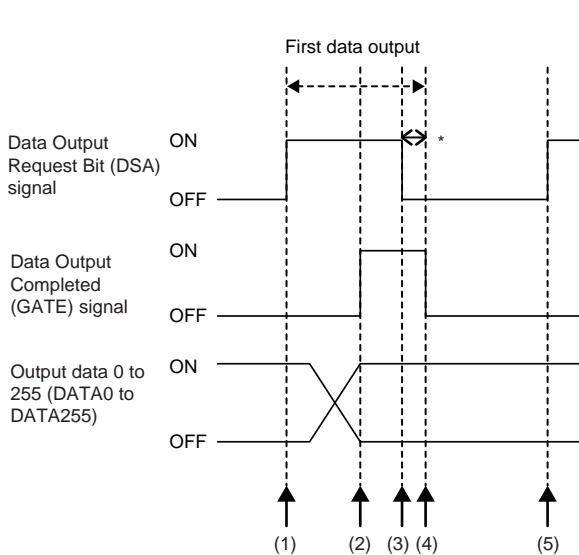

1. When the PLC is ready to received output data, the Data Output Request Bit (DSA) is turned ON from the PLC and a request is made to the Vision Sensor to output the data.
2. The Vision Sensor outputs the data. After the data is output, the Data Output Completed (GATE) signal turns ON.
3. The PLC confirms that the Data Output Completed (GATE) signal has turned ON, loads the data, and turns OFF the Data Output Request Bit (DSA) signal.
4. When the Vision Sensor detects that the Control Command Execution Bit (EXE) signal is OFF, it automatically turns OFF the Control Command Completed (FLG) signal and the Command Execution Active (BUSY) signal.
5. The Data Output Request Bit (DSA) signal is turned ON from the PLC and a request is made to output the following data.

* If the Data Output Request Bit (DSA) signal is not turned OFF within the control timeout time (100 to 120,000 ms) that is set in the PLC Link settings, the Data Output Completed (GATE) signal is forced OFF and data output is completed.

● Data Output after Measurements When Handshaking Is Disabled

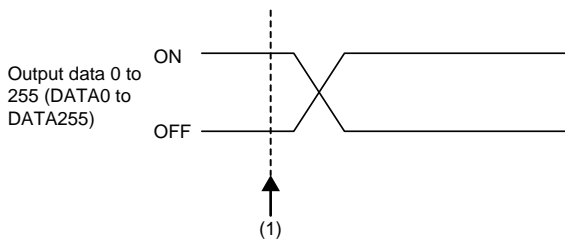

1. Data is output automatically when the Vision Sensor completes a measurement.
- * The PLC turns ON the Control Command Completed (FLG) signal and then gets the output data.

Sample Ladder Programming

● Command/Response Communications

The following sample program is used to perform single measurements. The single measurements command (lower bytes: #1010, upper bytes: #0010) is sent to the Vision Sensor.

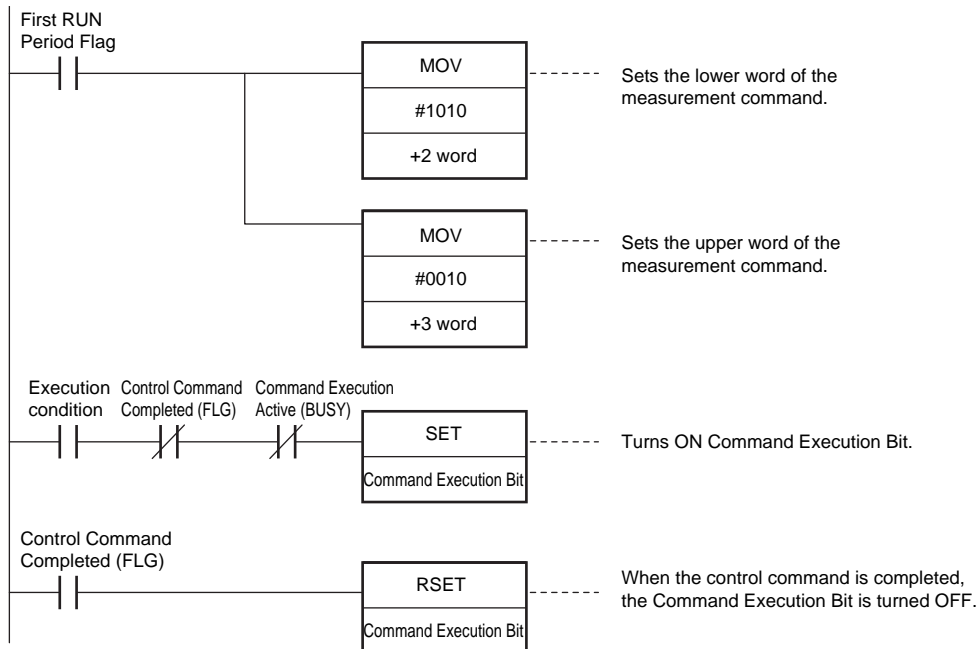

Important

Create the ladder program to control the TRIG signal so that it does not turn ON while the BUSY signal is ON. If not, a TRIG input error will occur and the ERROR signal will turn ON.

Note

PLC Link commands cannot be executed while the Command Execution Active (BUSY) parallel communications signal is ON during execution for the parallel measurement trigger input (TRIG signal). Execute PLC Link commands while the Command Execution Active (BUSY) parallel communications signal is OFF. You can also perform measurements with the measurement trigger input (TRIG signal) in parallel I/O and use PLC Link communications to output data.

● Data Output after Measurements When Handshaking Is Enabled

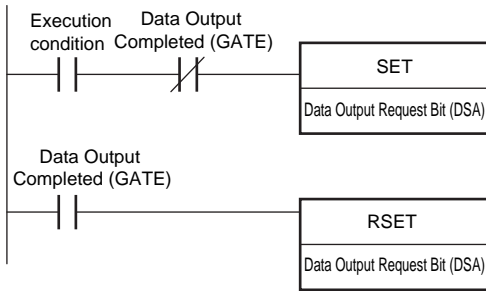

8-4 No-protocol Connections

You can use no-protocol communications between an external device (such as a PLC) and the Vision Sensor to perform control from the external device via command/response communications or to output data after measurements. You can use these communications methods simultaneously.

● Command/Response Communications

With no-protocol communications, the external device sends a control command to the Vision Sensor and receives a response back from the Vision Sensor. This allows you to control the operation of the Vision Sensor (e.g., perform single measurements or change the scene).

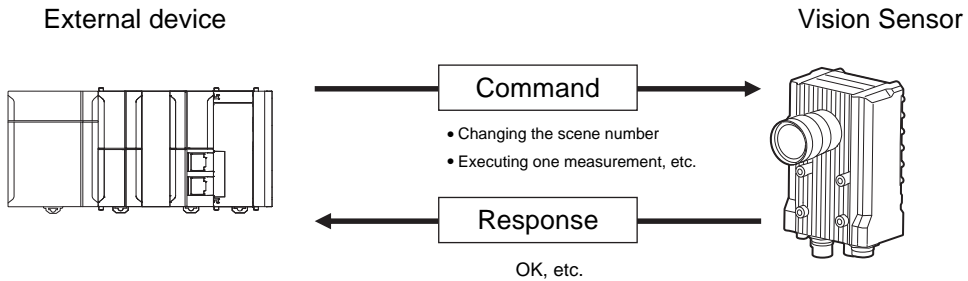

The external device sends a command as an ASCII string (e.g., "MEASURE" for a single measurement). The Vision Sensor then returns a response such as "OK", "NG", or some value.

● Data Output after Measurements

Immediately after a single or continuous measurement, the Vision Sensor will automatically output to an external device (e.g., a PLC) the data for measurements that are specified for output in advance. This enables you to easily transfer the measurement results data for inspection items to the external device.

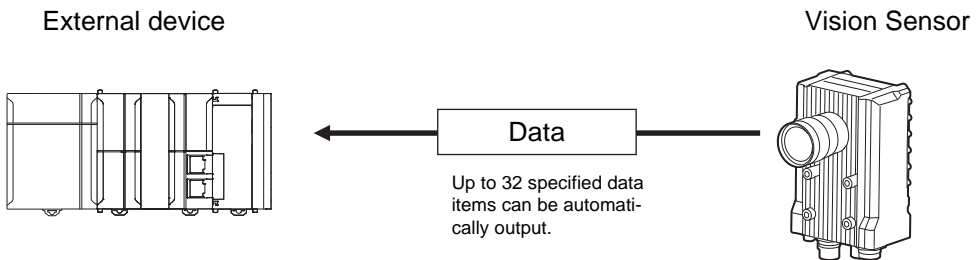

You must specify in advance the data to output (up to 32 items) after measurements. That data is sent to the external device in either ASCII or binary format through a continuous serial connection. There is no handshaking from the external device to confirm if it can receive the data.

Setting Up No-protocol Communications

Setting Network Settings in the Sensor

This section describes how to set the network settings in the Vision Sensor.

- ▶ **Multiview Explorer: [Device group] – Sensor name – [System] – [System data] (Double-click)**
→ **Edit Pane:  (Ethernet communication settings) Icon – [Ethernet settings]**

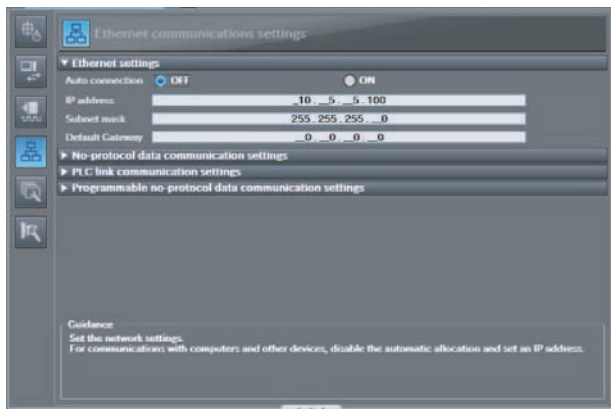

The following items can be set.

Item	Description	Setting range
Auto connection	Select whether the IP address is assigned automatically. To communicate with a PLC or other external device, set [Auto connection] to OFF and set the IP address setting described below.	OFF or ON Default: ON
IP address	Set the IP address of the Vision Sensor.	a: 1 to 223, b: 0 to 255, c: 0 to 255, d: 1 to 254 Default: 10.5.5.100
Subnet mask	Set the subnet mask.	0.0.0.0 to 255.255.255.255 Default: 255.255.255.0
Default gateway	Sets the default gateway.	0.0.0.0 to 255.255.255.255 Default: 0.0.0.0

• Operation on the Touch Finder

Use the following menu command to display the Setup Display on the Touch Finder.

- ▶  **(Setup Mode) – [Sensor settings] – [Network]**

Initial Settings for No-protocol Communications

You must set the communications method, destination IP address, and I/O port number of the destination external device to perform no-protocol communications.

- ▶ **Multiview Explorer: [Device group] – Sensor name – [System] – [System data] (Double-click)**
→ **Edit Pane:  (Ethernet communication settings) Icon – [No-Protocol data communication setting]**

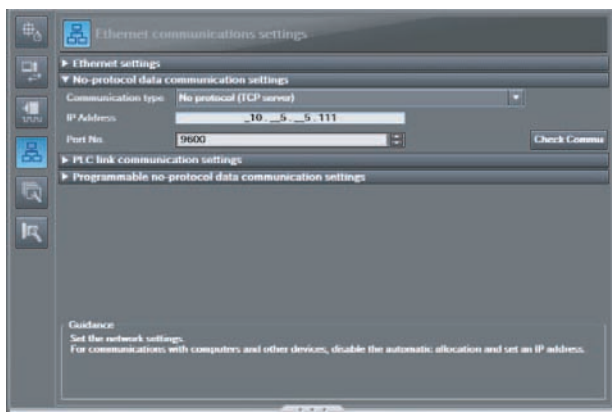

The following items can be set.

Item	Description	Setting range
Communication type	Select the communications method.	<ul style="list-style-type: none"> • No protocol (TCP server) • No protocol (TCP client) • _____ (Default: _____)
IP address	Set the IP address of the external device at the connection destination. Set it in the form a.b.c.d. <div style="border: 1px solid black; padding: 5px; margin-top: 10px;"> <p>Note</p> <p>If you connect an external OMRON CS/CJ-series PLC to Ethernet, the following default IP address is assigned to the PLC.</p> <ul style="list-style-type: none"> • IP address: 192.168.250.node_address </div>	a: 1 to 253, b: 0 to 255, c: 0 to 255, d: 0 to 255 Default: 10.5.5.1
Port No.	Set the I/O port number of the external device at the connection destination. Set the value to between 0 and 65,535. <div style="margin-top: 10px;"> <p>Click the [Confirmation] Button to confirm establishment of communications in the IP layer between the external device at the connection destination (e.g., a PLC) and the Vision Sensor as given below. The following text is displayed:</p> <ul style="list-style-type: none"> • If a connection is confirmed: [Connection: OK] (green text) • If a connection is not confirmed: [Connection: NG] (red text) </div>	0 to 65,535 Default: 9,600

Important

When no-protocol communications (TCP server) is specified, the port number on the FQ-M Vision Sensor is always 9876.

Setting the Data To Output Automatically after Measurements

You can set the data to output automatically after measurements. (You can set up to 32 data items.)

Data That Can Be Output

You can output up to 32 data items (data 0 to data 31).

The measurement data from inspection items that can be output and the calculation results from the expression settings can be output. For data that can be output, refer to the *Measurement Data That Can Be Used for External Outputs and Calculations* for each inspection item.

Checking No-protocol Communications Settings

You can check the current no-protocol communications settings.

- ▶ **Multiview Explorer: [Device group] – Sensor name – [Scene] – Scene data number (Double-click)**

→ **Edit Pane:  (Output) Icon – [Communication settings]**

If you click the [Output] Button while setting up inspection items, the following Output Setting Main Window is display.

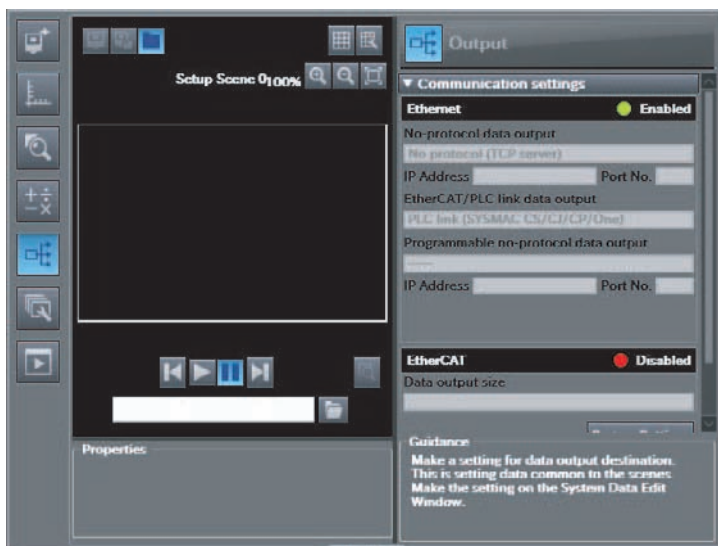

Item	Description
Output destination settings	<p>The settings of the following parameters in the system data are displayed.</p> <ol style="list-style-type: none"> 1. Ethernet Setting Status <ul style="list-style-type: none"> Enabled (green): Output no-protocol data, output link data, or programmable no-protocol data is selected as the communications method. Disabled (red): All settings are disabled. 2. The following output no-protocol data, output link data, programmable no-protocol data parameters: <ul style="list-style-type: none"> • Communication method • IP address • Port number
Output properties	The properties of the output data that is selected in the data output list are displayed.

Note

If outputting no-protocol data is not set in the output destination settings, click the [Edit system data] Button and make the initial settings for no-protocol communications on the Ethernet Communication Dialog Box.

Allocating Output Data

- ▶ Multiview Explorer: [Device group] – Sensor name – [Scene] – Scene data number (Double-click)
→ Edit Pane:  [Output] Icon – [No-protocol data output]
- 1 In the Output Settings Main Window, right-click the output data number to set in the output data list under [Output no-protocol data] and select [Edit].

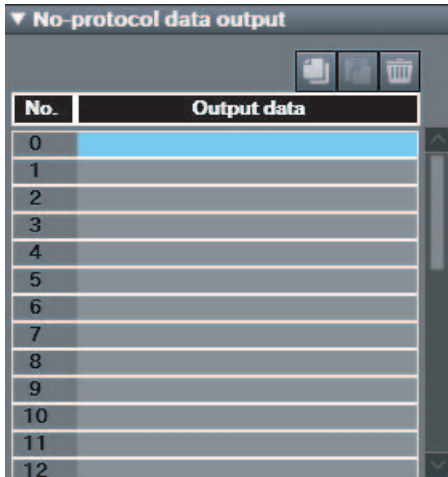

The following Output Dialog Box is displayed.

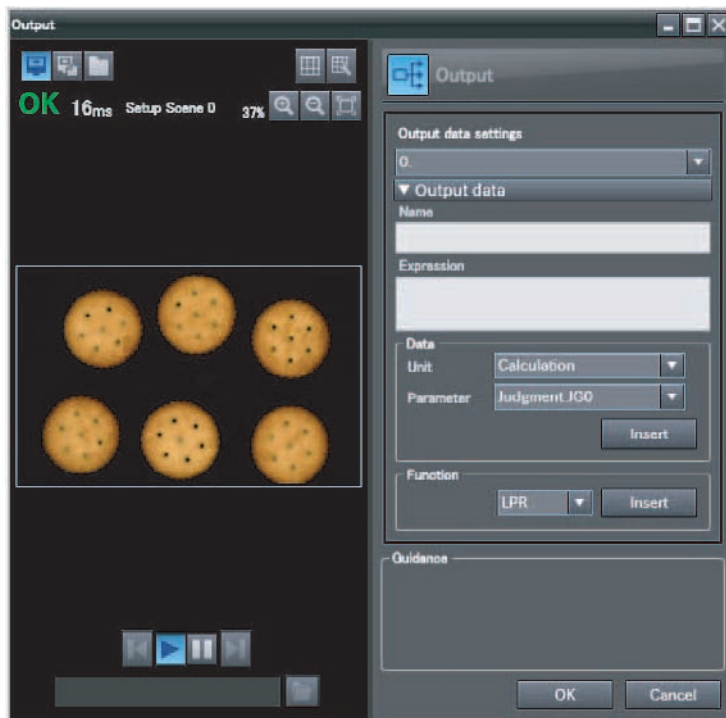

- 2 Set the data to output in the Output Dialog Box.

Item	Description				
Output data settings	The number of the output data that was selected for setting is displayed.				
Name	You can change the name of the output data. Max. number of characters: 15				
Expression	Registers the output data item or multiple data output function. Examples: I0.X LPR(0, 3, I0.X, I0.Y) LPC(0, I0.C, I0.X, I0.Y)				
Data	You can insert parameters selected from Units and parameters into expressions.				
	<table border="1"> <tr> <td>Unit</td> <td>Select one of the following. <ul style="list-style-type: none"> • An inspection item that has the output item to use for the output data. • Calculation </td> </tr> <tr> <td>Parameter</td> <td>Select the output item from the selected unit. Example: If the Search inspection item was selected, you can select either of the following: Judgement results: Judgement JG or Correlation: Corre. CR</td> </tr> </table>	Unit	Select one of the following. <ul style="list-style-type: none"> • An inspection item that has the output item to use for the output data. • Calculation 	Parameter	Select the output item from the selected unit. Example: If the Search inspection item was selected, you can select either of the following: Judgement results: Judgement JG or Correlation: Corre. CR
Unit	Select one of the following. <ul style="list-style-type: none"> • An inspection item that has the output item to use for the output data. • Calculation 				
Parameter	Select the output item from the selected unit. Example: If the Search inspection item was selected, you can select either of the following: Judgement results: Judgement JG or Correlation: Corre. CR				
Function	<p>The following functions can be inserted.</p> <ul style="list-style-type: none"> • In Multiple Data Output Mode, select one of the following types of multiple data output functions. <ul style="list-style-type: none"> • Data logging order: LPR function The measurement data is output in order. Format: LPR (<i>start_number,number_of_data,data_A, data_B,data_C...</i>) Output Example: LPR(0,3,I0.X,I0.Y,I0.Z) X0,Y0,Z0,X1,Y1,Z1,X2,Y2,Z2 • Detection point order: LPC function Outputs data for each detected measurement point. Format: LPC (<i>start_number,number_of_data,data_A, data_B,data_C...</i>) Output Example: LPC(0,3,I0.X,I0.Y,I0.Z) X0,X1,X2,Y0,Y1,Y2,Z0, Z1, Z2,, You can specify up to five data items as the above LPR and LPC functions arguments. • Encoder Value Output Function <ul style="list-style-type: none"> • Encoder Value Output: ECNT function The encoder value is output. Format: ECNT(argument) Output Example: ECNT(0) 0: Ring counter value at measurement trigger 1: Ring counter value at calculation 2: Trigger counter value at calculation 				

3 Click the [OK] Button.

4 Set the output format.

Set the output format for [Output format] under [No-protocol data output].

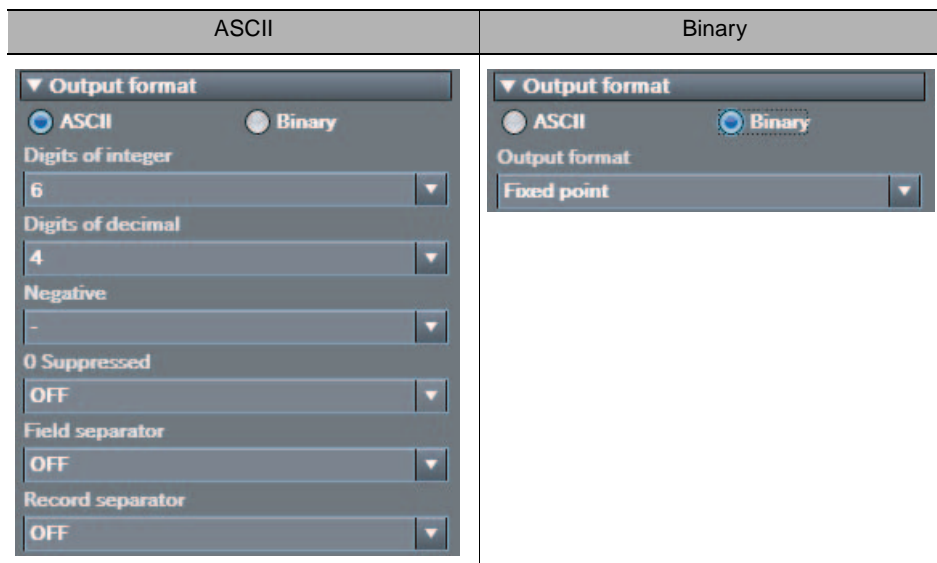

Item		Description	Setting range
Data format		Sets the data format.	ASCII or Binary Default: ASCII
For ASCII	Digits of integer	Sets the number of digits in the integer part of the number.	1 to 10 digits Default: 6 digits
	Digits of decimal	Set the number of digits in the integer part.	0 to 4 digits Default: 4 digits
	Negative	Sets the way to express negative numbers.	- or 8 Default: -
	0 Suppressed	Sets whether to use zero suppression.	OFF or ON Default: OFF
	Field separator	Sets the field separator.	OFF, comma, tab, space, CR, LF, CR+LF, or Semicolon Default: OFF
	Record separator	Sets the record separator.	OFF, comma, tab, space, CR, LF, CR+LF, or Semicolon Default: OFF
For Binary	Output format	Sets the output format for numerical data.	Floating point or fixed point Default: Floating point

• When Output Format Is ASCII

Set the parameters for integer digits, decimal digits, negative numbers, 0 suppression, the field separator, and the record separator.

• Output Format

Measured value of data 0	,	Measured value of data 1	,	...	Measured value of data 7	CR
--------------------------	---	--------------------------	---	-----	--------------------------	----

Note

The data output method, digits, and data separators can be changed as needed.

Example: Integer digits: 5, decimal digits: 3, negative number expression: -, zero suppressed: none, field separator: comma, record separator: CR

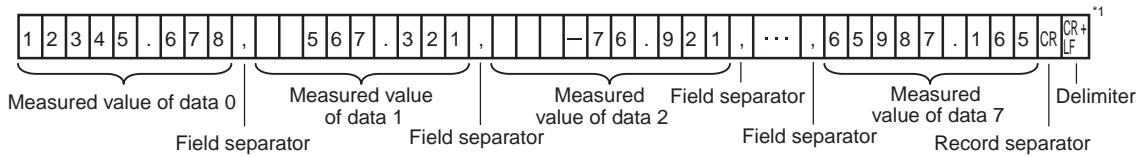

*1 Because the record separator is set to CR, only one record is output for each measurement. A blank line (CR: delimiter) will therefore be entered after the record separator. If you do not want a blank line, set the record separator to None.

Note

The field separator is not output unless the data continues.

The following range of values can be output.

$$-999,999,999.9999 \leq \text{Measured value} \leq 999,999,999.9999$$

If the measured value is lower than -999,999,999.9999, then -999,999,999.9999 is output.

If the measured value is higher than 999,999,999.9999, then 999,999,999.9999 is output.

The following values are output if JG (Judge) is set.

OK: 0

NG: -1

Note

Data that is output after measurement is output until the last data even after the measurement is finished. Data output is not interrupted midway.

• When Output Format Is Binary

Set the numerical expression.

Select either fixed decimal or floating-point decimal.

• Output Format

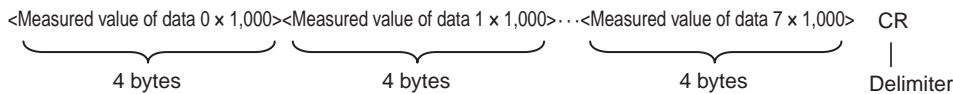

The measurement data multiplied by 1,000 is output continuously at 4 bytes per data. Negative numbers are output as two's complements.

Example: When Data 0 Is 256.324 and Data 1 Is -1.000.

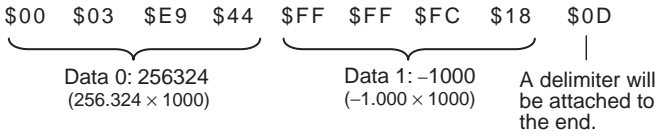

Note

Binary output does not use data separators, i.e., field separators or record separators. These separators are used only for ASCII output.

The following range of values can be output.

$$-2,147,483.648 \leq \text{Measured value} \leq 2,147,483.647$$

If the measured value is lower than -2,147,483.648, then -2,147,483.648 is output.

If the measured value is higher than 2,147,483.648, then 2,147,483.648 is output.

The following values are output if JG (Judge) is set.

OK: 0 (0 × 1000)

NG: -1000 (-1 × 1000)

Note

Data that is output after measurement is output until the last data even after the measurement is finished. Data output is not interrupted midway.

Controlling the Sensor from an External Device (Procedure for No-protocol Command/Response Communications)

Command Format

This section describes the command format for no-protocol communications.

Commands defined in the command list can be used.

Set commands and parameters in ASCII.

If the command has an argument parameter, set the parameter after inserting a space (0x20).

If it has multiple parameters, insert a space before each parameter.

Place a delimiter at the end of the command. No space is required before the delimiter.

The delimiter is always CR.

<Command Format>

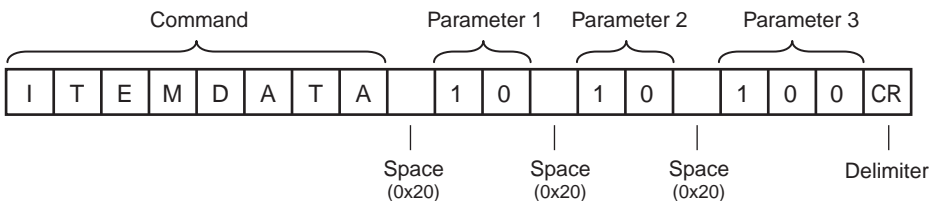

<Response Format>

If a parameter is attached, the parameter and delimiter are output when the command is processed normally, and the command execution result is OK. A delimiter is inserted at the end of the response.

The delimiter is always CR.

Command Execution Result

Parameter

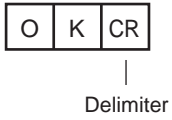
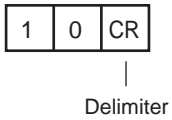

If the command is not processed normally, the command execution result is NG.

Command Execution Result

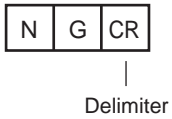

An error occurs in the following cases.

- A non-existent command was specified.
- The number of parameters is incorrect.
- The parameter range is incorrect.
- The parameter content is incorrect.
- Operation could not be performed normally for the operation command.

Command List

The following table lists the no-protocol commands.

Commands that can be used in no-protocol Ethernet communications are listed below.

Type of command	Command	Abbreviation	Function	Reference
Scene control commands	SCENE	S	Acquires the current scene number.	p. 308
	SCENE <i>Scene_number</i>	S <i>Scene_number</i>	Changes the scene number being used.	p. 309
Measurement control commands	MEASURE	M	Executes one measurement.	p. 310
	MEASURE/C	M/C	Starts continuous measurements.	p. 311
	MEASURE/E	M/E	Ends continuous measurements.	p. 312
Data acquisition/setting commands	ITEMDATA <i>Inspection_item_number</i> <i>External_reference_data_number</i>	ID <i>Inspection_item_number</i> <i>External_reference_data_number</i>	Acquires the inspection item data.	p. 313
	ITEMDATA <i>Inspection_item_number</i> <i>External_reference_data_number</i> <i>Set_value</i>	ID <i>Inspection_item_number</i> <i>External_reference_data_number</i> <i>Set_value</i>	Sets the inspection item data.	p. 314
Model re-registration command	MODEL	None	Re-registers the models for registered Search and Shape Search inspection items.	p. 315
Setting acquisition command	VERGET/S	None	Acquires the version information of the Sensor software.	p. 316
	VERGET/H	None	Acquires the Sensor model information.	p. 317
	ERRGET	None	Acquires the latest error code of the Sensor.	p. 318
Utility commands	CLRMEAS	None	Clears the measurement values.	p. 319
	CLRERR	None	Clears the error output status (error signal and error indicator).	p. 320
	RESET	None	Restarts the Sensor.	p. 320
Encoder control commands	ENCRESET	None	Resets the encoder trigger counter and ring counter.	p. 321
	ENCFCGET	None	Acquires the counter value of the encoder's ring counter.	p. 322
	ENCFCSET	None	Sets the counter value of the encoder's ring counter.	p. 323

Command Details

Scene Control Commands

● SCENE or S

Acquire Scene Number

This command acquires the scene number currently being used.

<Command Format>

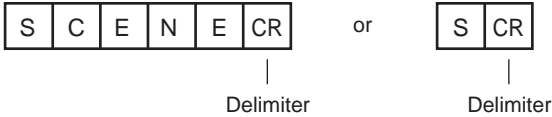

<Response Format>

When the Command Is Processed Normally

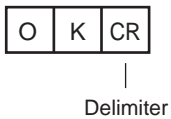
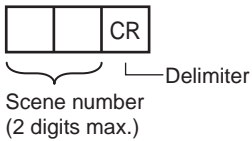

When the Command Is Not Processed Normally

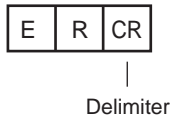

<Parameter Descriptions>

Scene number	The acquired scene number (currently used scene number) is returned.
--------------	--

Example:

When Scene 0 Is Being Used

<Command>



<Response>

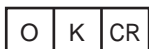
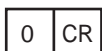

Change Scene Number

This command changes the scene number to use.

<Command Format>

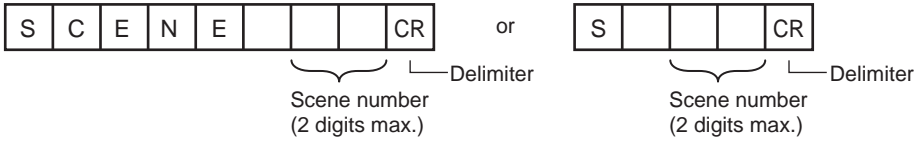

<Response Format>

When the Command Is Processed Normally

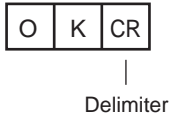

When the Command Is Not Processed Normally

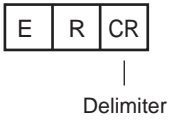

<Parameter Descriptions>

Scene number	Specifies the scene number (0 to 31) to change to.
--------------	--

Measurement Control and Measurement Acquisition Commands

● MEASURE or M

Execute Measurement

This command executes one measurement.

If data output is not set, only the measurement is performed.

If data output is set, the measurement is performed and the result is returned as response data.

<Command Format>

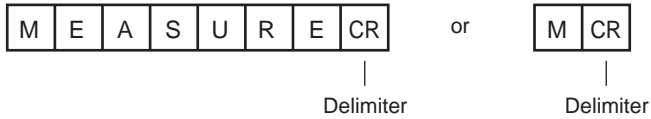

<Response Format>

When the Command Is Processed Normally



|
Delimiter

When the Command Is Not Processed Normally



|
Delimiter

<Parameter Descriptions>

Measurement result	<p>The measurement result is output as the response when data output is set. The measurement result is not output when data output is not set.</p> <p> Setting the Data To Output Automatically after Measurements: p. 299</p>
--------------------	--

Start Continuous Measurements

This command starts continuous measurements.

If data output is not set, only continuous measurement is performed.

If data output is set, continuous measurement is performed and the results corresponding to the number of measurements made are returned as response data.

<Command Format>

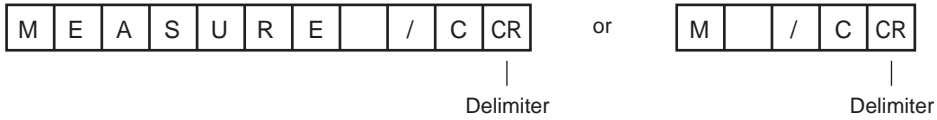

<Response Format>

When the Command Is Processed Normally

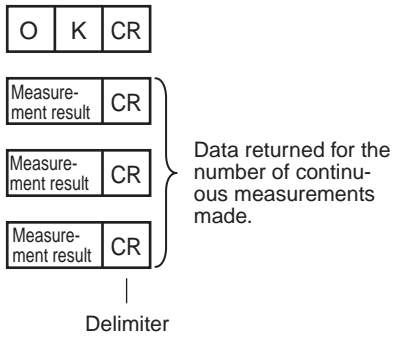

When the Command Is Not Processed Normally

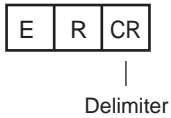

<Parameter Descriptions>

Measurement result	<p>The measurement results corresponding to the number of measurements made are output when data output is set.</p> <p>The measurement result is not output when data output is not set.</p> <p> Setting the Data To Output Automatically after Measurements: p. 299</p>
--------------------	--

Data Acquisition/Setting Commands

● ITEM DATA or ID

Acquire Inspection Item Data

This command acquires the parameters and measurement values of the specified inspection item.

<Command Format>

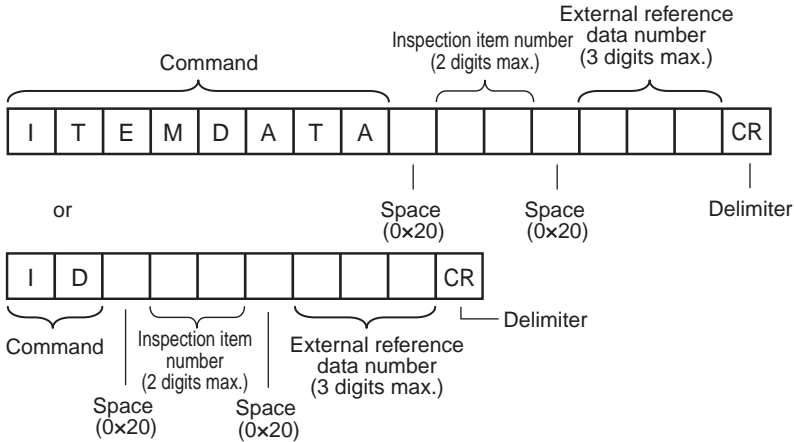

<Response Format>

When the Command Is Processed Normally

Acquired value CR

OK CR



Delimiter

When the Command Is Not Processed Normally

ER CR

Delimiter

<Parameter Descriptions>

Inspection item number	Specifies the inspection item number. (0 to 31)
External reference data number	Specifies the external reference data number. (0 to 999)  p. 412
Acquired value	Returns the data for the specified inspection item.  p. 412

Set Inspection Item Data

This command sets the parameters and measurement values of the specified inspection item.

<Command Format>

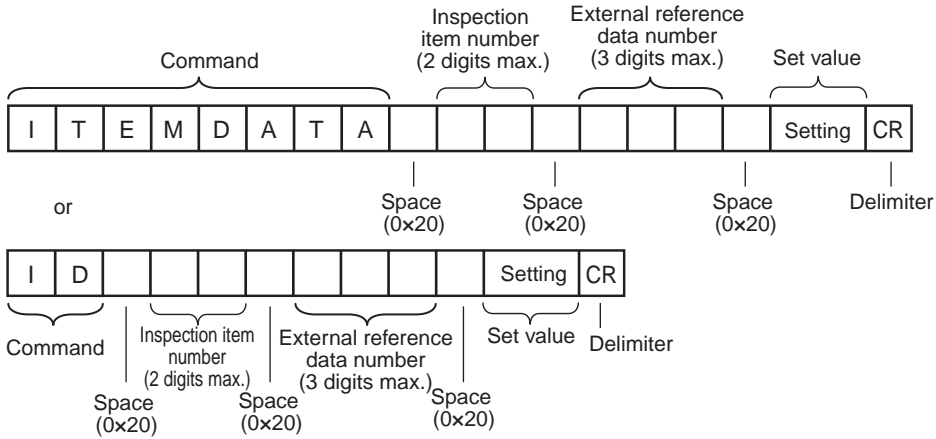

<Response Format>

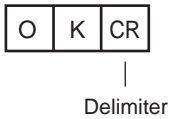

When the Command Is Processed Normally

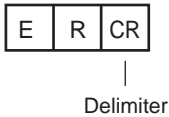

When the Command Is Not Processed Normally



<Parameter Descriptions>

Inspection item number	Specifies the inspection item number. (0 to 31)
External reference data number	Specifies the external reference data number. (0 to 999)  p. 412
Acquired value	Returns the data for the specified inspection item.  p. 412

● MODEL

Re-register Models

This command re-registers the models for registered Search inspection items.

<Command Format>

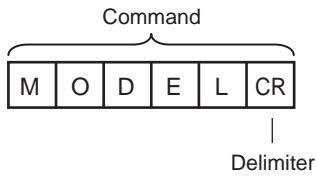

<Response Format>

When the Command Is Processed Normally

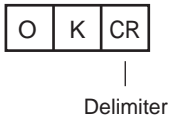

When the Command Is Not Processed Normally

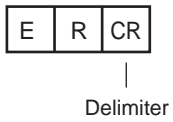

● VERGET

Acquire Software Version

This command acquires the version information of the Sensor software.

<Command Format>

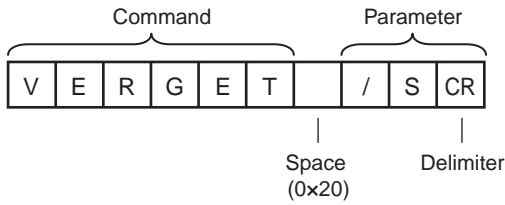

<Response Format>

When the Command Is Processed Normally

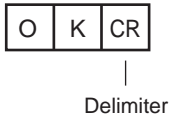
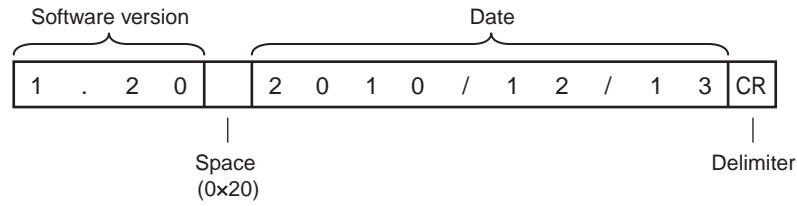

When the Command Is Not Processed Normally

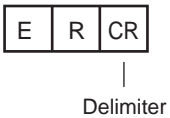

<Parameter Descriptions>

Software version	Returns the software version. Example: When the software version is 1.20, the response is 1.20.
Date	Returns the date. Example: When the date is 13 December 2010, the response is 2010/12/13.

Acquire Sensor Model

This command acquires the Sensor model.

<Command Format>

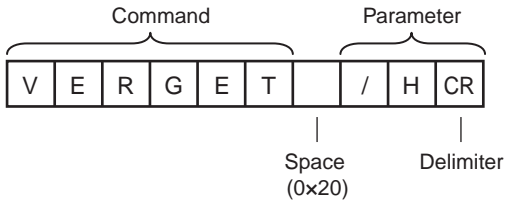

<Response Format>

When the Command Is Processed Normally

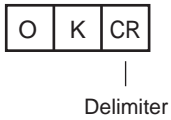
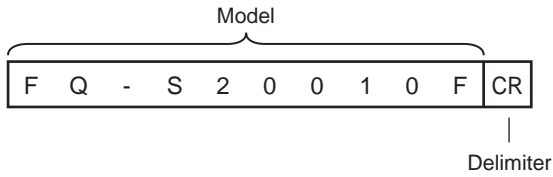

When the Command Is Not Processed Normally

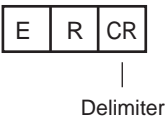

<Parameter Descriptions>

Model	Returns the model. Example: When the model is FQ-S20010F, the response is FQ-S20010F.
-------	--

● ERRGET

Acquire Error Information

This command acquires the latest error code from the Sensor.

<Command Format>

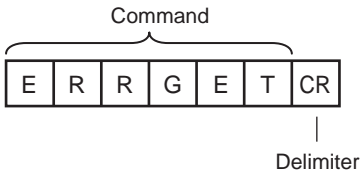

<Response Format>

When the Command Is Processed Normally

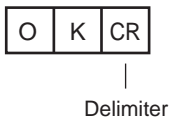
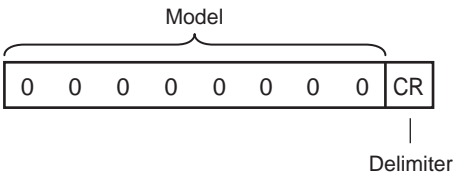

When the Command Is Not Processed Normally

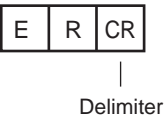

<Parameter Descriptions>

Error code	Returns the latest error code. If there is no error history, the response is 00000000.  Error List p. 391
------------	---

● CLRMEAS

Clear Measurement Values

This command clears the measurement values.

<Command Format>

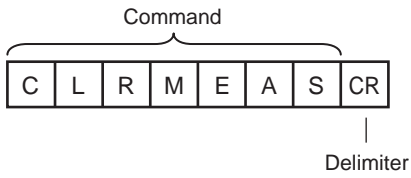

<Response Format>

When the Command Is Processed Normally

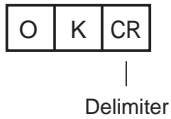

When the Command Is Not Processed Normally

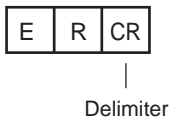

● CLRERR

Clear Errors

This command clears the error output status (error output and error indicator).

<Command Format>

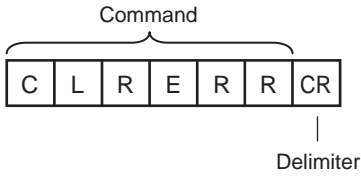

<Response Format>

When the Command Is Processed Normally

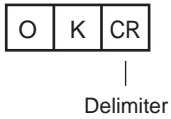

When the Command Is Not Processed Normally

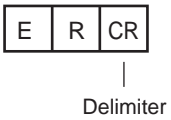

● RESET

Resets the Sensor

This command resets the Sensor.

<Command Format>

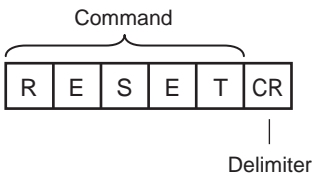

<Response Format>

When the Command Is Processed Normally

If process is completed normally, the Sensor is restarted. There is therefore no response.

When the Command Is Not Processed Normally

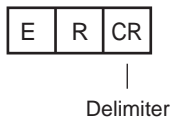

● ENCRESET

Reset Encoder Trigger Counter and Ring Counter

This command resets the encoder trigger counter and ring counter.

<Command Format>

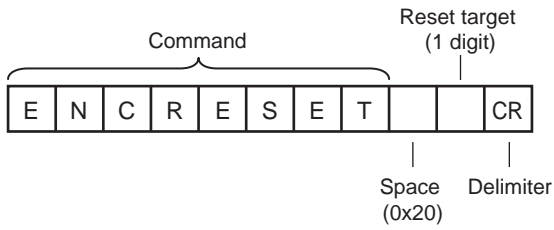

<Response Format>

When the Command Is Processed Normally

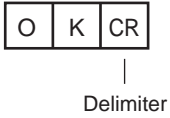

When the Command Is Not Processed Normally

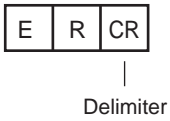

<Parameter Descriptions>

Reset target	Specify the counters to reset. 0: Encoder trigger counter and ring counter 1: Ring counter 2: Trigger counter
--------------	--

● ENCFCGET

Get Encoder Ring Counter Value

This command acquires the ring counter value of the encoder.

<Command Format>

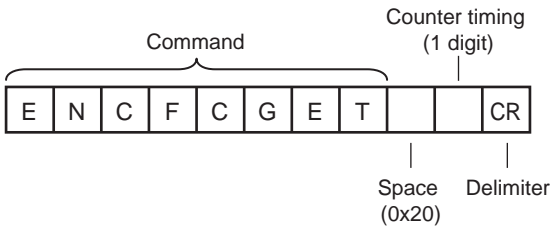

<Response Format>

When the Command Is Processed Normally

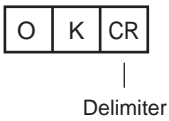
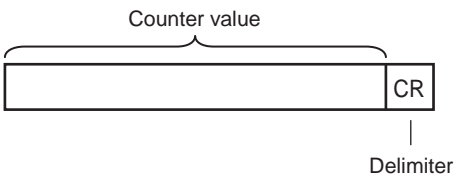

When the Command Is Not Processed Normally

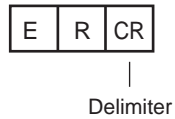

<Parameter Descriptions>

Counter timing	Specify when to acquire the ring counter value. 0: Current counter value 1: Counter value at the trigger
Counter value	The counter value is returned.

● ENCF CSET

Set Ring Counter Value

This command sets the ring counter value of the encoder.

<Command Format>

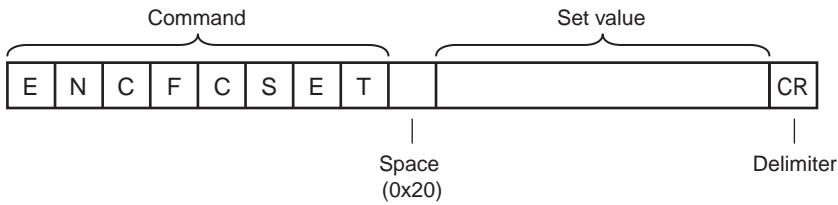

<Response Format>

When the Command Is Processed Normally

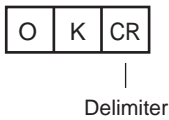

When the Command Is Not Processed Normally

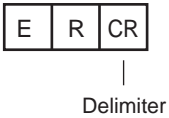

<Parameter Descriptions>

Parameter	Specify the ring counter value of the encoder.
-----------	--

Communications Example

An example of the communications log when a computer is connected and communications is performed with a no-protocol command from a terminal application is shown below.

Example 1: Changing Scenes (Scene number 1 is specified.)

```
S_1
OK
```

Example 2: Acquiring inspection item data (Acquires the judgement result for a search registered to inspection item 10.)

```
ITEMDATA_100
0
OK
```

Example 3: Measurement when Data Output Is Not Set

```
M
OK
```

Example 4: Measurement when Data Output Is Set

```
M
OK
    1.0000    0.0000    0.0000    306.0000
M
OK
    2.0000    0.0000    0.0000    0.0000
```

8-5 Connecting with the Programmable No-protocol Communications

You can use programmable no-protocol communications to communicate between an external device and the Vision Sensor to output data in the specified format after measurements are completed.

● Data Output after Measurements

Immediately after a single measurement or continuous measurements, the Vision Sensor will automatically output to an external device (e.g., a Robot Controller) data in the preset format. This enables you to transfer the measurement results data for inspection items to the Robot Controller.

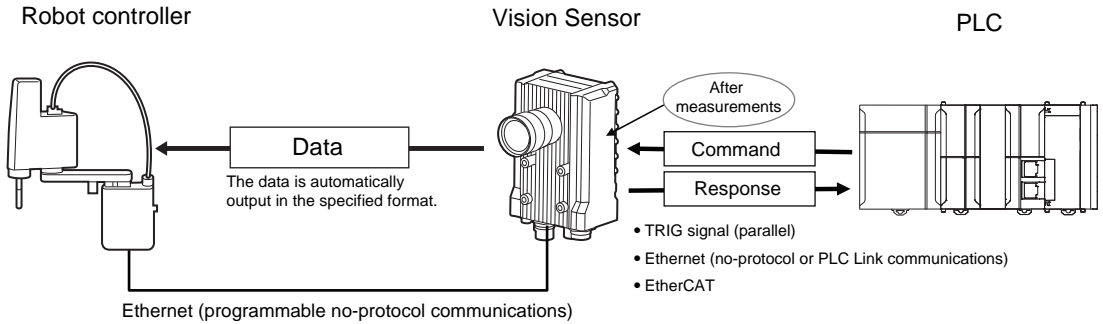

You can output commands to directly control a robot by combining text strings.

Note

Only ASCII data can be output. Binary data output is not supported.

Setting Up Programmable No-protocol Communications

Setting Network Settings in the Sensor

This section describes how to set the network settings in the Vision Sensor.

- ▶ **Multiview Explorer: [Device group] – Sensor name – [System] – [System data] (Double-click)**

→ **Edit Pane:  [Ethernet communications settings] Icon – [Ethernet settings]**

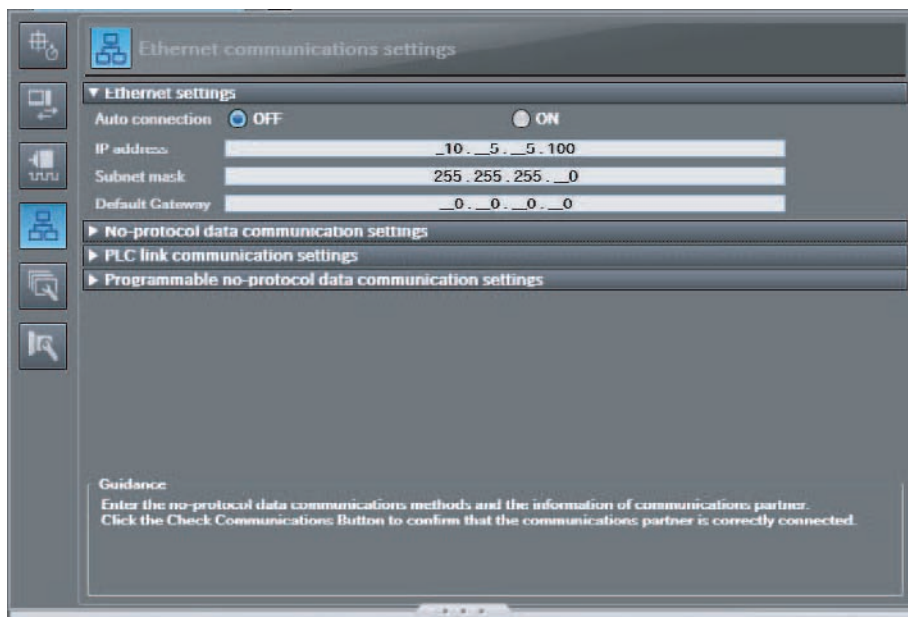

The following items can be set.

Item	Description	Setting range
Auto connection	Select whether the IP address is assigned automatically. To communicate with a PLC or other external device, set [Auto connection] to OFF and set the IP address setting described below.	OFF or ON Default: ON
IP address	Set the IP address of the Vision Sensor.	a: 1 to 223, b: 0 to 255, c: 0 to 255, d: 1 to 254 Default: 10.5.5.100
Subnet mask	Set the subnet mask.	0.0.0.0 to 255.255.255.255 Default: 255.255.255.0
Default Gateway	Sets the default gateway.	0.0.0.0 to 255.255.255.255 Default: 0.0.0.0

• Operation on the Touch Finder

Use the following menu command to display the Setup Display on the Touch Finder.

- ▶  **(Setup Mode) – [Sensor settings] – [Network]**

Initial Settings for the Programmable No-protocol

You must set the communications method, IP address, and I/O port number for the destination external device (e.g., Robot Controller) to perform programmable no-protocol communications. You can output results to up to three external devices.

- ▶ **Multiview Explorer: [Device group] – Sensor name – [System] – [System data] (Double-click)**
 → **Edit Pane: [Ethernet communications settings] Icon – [Programmable no-protocol data communication settings]**

When the [communication type] is set to “TCP client”

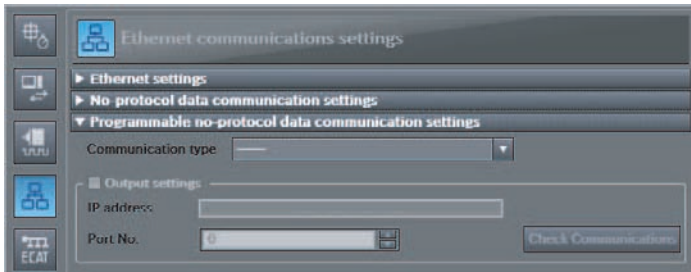

When the [communication type] is set to “TCP server”

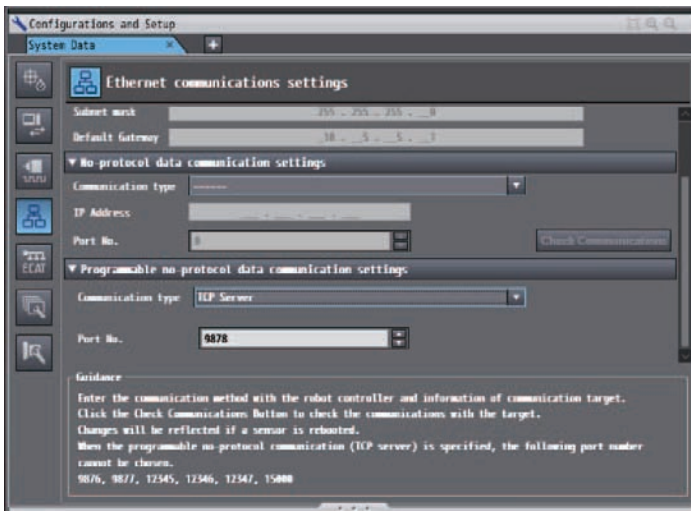

The following items can be set.

Item	Description	Setting range
Communication type	Select the communications method.	<ul style="list-style-type: none"> • —— • TCP client • TCP Server (Default: ——)

Item		Description	Setting range
Output settings (when the [communication type] is set to "TCP client")	IP address	Set the IP address of the external device (e.g., Robot Controller) at the connection destination. Set it in the form a.b.c.d.	a: 1 to 253, b: 0 to 255, c: 0 to 255, d: 0 to 255 Default: 10.5.5.111
	Port No.	Set the I/O port number of the external device (e.g., Robot Controller) at the connection destination. Set the value to between 0 and 65,535.	0 to 65,535 Default: 9,600
		Click the [Confirmation] Button to confirm establishment of communications in the IP layer between the external device at the connection destination (e.g., Robot Controller) and the Vision Sensor as given below. The following text is displayed: <ul style="list-style-type: none"> • If a connection is confirmed: [Connection: OK] (green text) • If a connection is not confirmed: [Connection: NG] (red text) 	
Port No. (when the [communication type] is set to "TCP server")	Set the port number of the TCP server.	0 to 65,536 Default: 9,878	

Important

- When the [communication type] is set to "TCP server," the following port numbers are reserved and cannot be used: 9876, 9877, 12345, 12346, 12347, and 15000
- The port number is initialized when you switch from TCP client to TCP server, or vice versa. Reset the port number whenever you switch the [communication type].

Setting the Data To Output Automatically after Measurements

You can set the data to output automatically after measurements. (You can set up to 32 data items.)

Output Data

● Parameters

The following three parameters are output in programmable no-protocol communications.

1. Output format parameter
2. Argument parameter
3. Array parameter (optional)

Tags are added to these parameter.

The format for each parameter is *Tag=XXX*.

XXX is replaced with the specified parameter.

You must set in advance the format of the data to output after measurement is performed.

The specified format is entered from the keyboard for the [Expression] in the [Output] area.

After the measurements are completed, the data is sent to external device (e.g., Robot Controller) through a continuous serial connection.

Specification Format

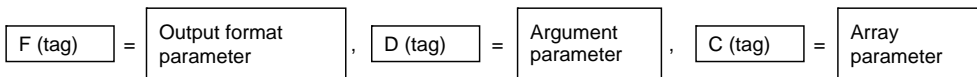

1. Output Format Parameters

Tag: F

You can enable displaying the output results by defining formatted text strings as the output format with the argument parameters for tag D.

The format for the formatted text strings is as follows:

%[Flag][Minimum field width][.Precision]Conversion specifier

* Items in square brackets can be omitted.

	Signed decimal integer	Signed decimal fraction
Conversion specifier	d	f
Minimum field width	Minimum number of characters (limit: 10 characters)	Minimum number of characters (limit: 15 characters)
Precision	Minimum number of digits (limit: 10 digits)	Minimum number of digits below the decimal (limit: 4) * Four digits is used if this item is omitted.

Flag	Meaning
0 (zero)	If the number of output characters is less than the minimum field width, 0 is output.

Any text string can be used for tag F.

2. Argument Parameters

Tag: D

Set the output format for the argument.

You can specify for arguments the results of inspection items that can be used in calculation expressions and the results of calculation expressions.



12-2 External Reference Parameters p. 412

Multiple arguments are separated with commas.

To specify an array for a parameter that contains more than one result, place square brackets after the parameter. (Example: X[])

Specify an array index, place the index inside the brackets. (Example: X[1])

The following functions can be used for the arguments.

Item	Meaning
ECNT(<i>argument</i>)	Argument of 0: Ring counter value at measurement trigger Argument of 1: Ring counter value at calculation Argument of 2: Trigger counter value at calculation
FIDX(<i>argument</i>)	Argument of 0: Start from 0 and count up 1 at a time. Argument of 1: Count up according to the contents specified by tag C.

3. Array parameter

Tag: C

To use the argument parameter for tag D as an array parameter, specify the array information.

This tag can be omitted.

The parts of the array information are separated with a comma and consist of the following three items.

Output start number, Number of steps, Number of outputs

Item	Meaning	Default when omitted
Output start number	The starting index of the array.	0
Number of steps	The number of steps in the array (the increment/ decrement width of the array argument). * Negative values can be set.	1
Number of outputs	The number of output data items.	1

Checking Programmable No-protocol Communications Settings

You can check the current programmable no-protocol communications settings.

► **Multiview Explorer: [Device group] – Sensor name – [Scene] – Scene data number (Double-click)**

→ **Edit Pane: [Output] Icon – [Communication settings]**

If you click the [Output] Button while setting up inspection items, the following Output Setting Main Window is display.

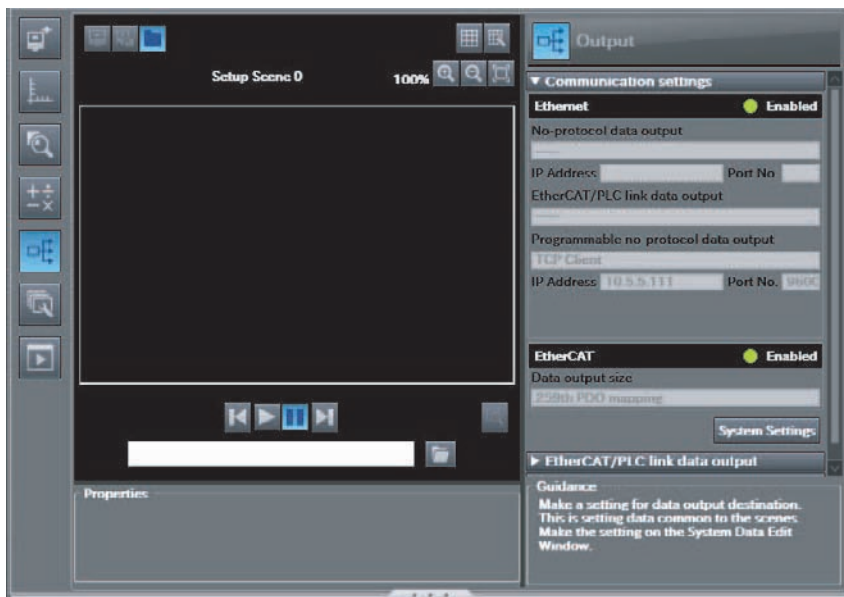

Item	Description						
Communication settings	<p>The settings of the following parameters in the system data are displayed.</p> <ol style="list-style-type: none"> Ethernet Setting Status <ul style="list-style-type: none"> Enabled (green): Output no-protocol data, output link data, or programmable no-protocol data is selected as the communications method. Disabled (red): All settings are disabled. The following output no-protocol data, output link data, programmable no-protocol data parameters: <ul style="list-style-type: none"> • Communication method • IP address • Port number 						
Output Properties	<p>The properties of the data output list are displayed.</p> <table border="1"> <thead> <tr> <th colspan="2">Properties</th> </tr> <tr> <th>Output data type</th> <th>Programmable no-protocol data output</th> </tr> </thead> <tbody> <tr> <td>0.10.X</td> <td>F="%d",D="10.X"</td> </tr> </tbody> </table>	Properties		Output data type	Programmable no-protocol data output	0.10.X	F="%d",D="10.X"
Properties							
Output data type	Programmable no-protocol data output						
0.10.X	F="%d",D="10.X"						

Note

If programmable no-protocol data is not set in the output destination settings, click the [Edit system data] Button and make the initial settings for programmable no-protocol communications in the Ethernet Communication Dialog Box.

Allocating Output Data

- ▶ **Multiview Explorer: [Device group] – Sensor name – [Scene] – Scene data number (Double-click)**

→ **Edit Pane: [Output] Icon – [Programmable no-protocol data]**

- 1** In the Output Settings Main Pane, right-click the output data number to set in the output data list under [Programmable no-protocol data] and select [Edit].

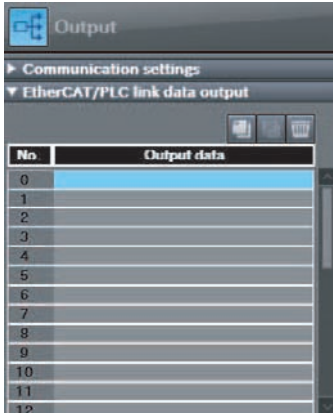

The following Output Dialog Box is displayed.

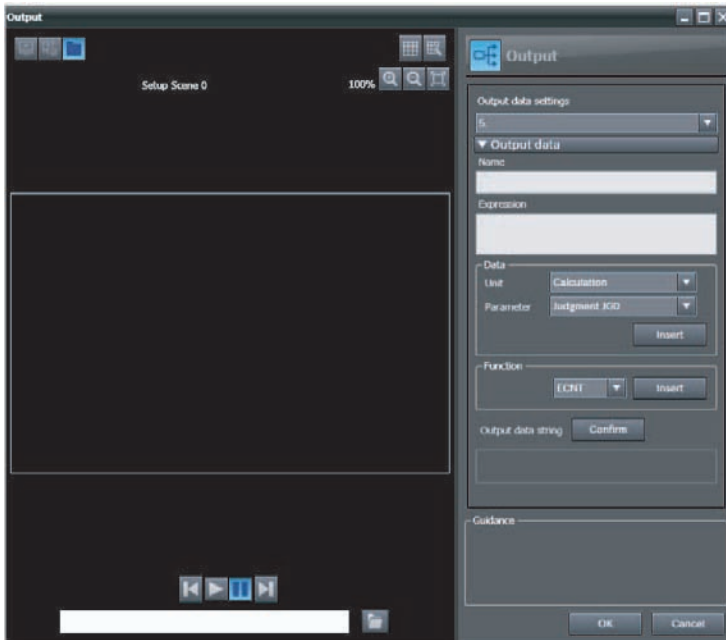

- 2** Set the data to output in the Output Dialog Box.

Item	Description
Output data settings	The number of the output data that was selected for setting is displayed.
Name	You can change the name of the output data. Max. number of characters: 15

Item	Description
Expression	Enter the output data for the specified format from the keyboard. Max. number of characters: 255 + NULL Default: NULL
Data	You can insert parameters selected from Units and parameters into expressions.
Unit	Select one of the following. <ul style="list-style-type: none"> • An inspection item that has the output item to use for the output data. • Calculation
Parameter	Select the output item from the selected unit. Example: If the Search inspection item was selected, you can select either of the following: Judgement results: Judgement JG or Correlation: Corre. CR
Function	The following functions can be inserted in Tag D. <ul style="list-style-type: none"> • Encoder Value Output Function <ul style="list-style-type: none"> • Encoder Value Output: ECNT function The encoder value is output. Format: ECNT(argument) Output Example: ECNT(0) 0: Ring counter value at measurement trigger 1: Ring counter value at calculation 2: Trigger counter value at calculation • Function That Outputs the Value Resulting from Counting Up from the Specified Value <ul style="list-style-type: none"> • Function that outputs the value resulting from counting up from the specified value: FIDX The value that results from counting up from the specified value is output. Format: FIDX(argument) Output Example: 0: Start from 0 and count up 1 at a time. 1: Count up according to the array parameter that is specified for tag C.

3 Click the [Confirm] Button for the output data text string.

The output data entered in the expression is displayed under the [Confirm] Button so that you can check it.

4 Click the [OK] Button.

5 Set the output format.

Set the output format in [Output format] under [Programmable no-protocol data].



Item	Description	Setting range
Field separator	Sets the field separator.	OFF, Comma, Tab, Space, CR, LF, CR+LF, or Semicolon Default: OFF
Record separator	Sets the record separator.	OFF, comma, tab, space, CR, LF, CR+LF, or Semicolon Default: OFF

Field separator: The separator between parameters
 Record separator: The separator between measurements

The record separator is inserted at the end of output data 2. A field separator is inserted between each output value if you have enabled multiple output within the output data.

Example: Integer digits: 5, decimal digits: 3, field separator: comma, record separator: CR

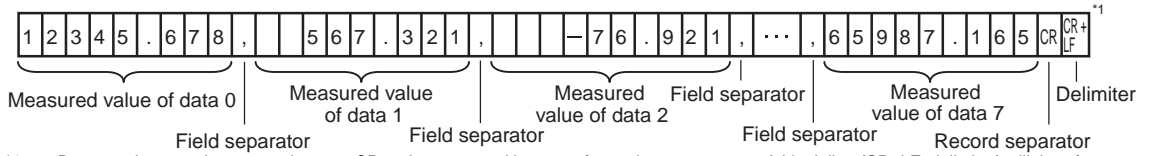

*1 Because the record separator is set to CR, only one record is output for each measurement, A blank line (CR+LF: delimiter) will therefore be entered after the record separator. If you do not want a blank line, set the record separator to OFF.

Note

If data is output as an array for one output data, a field separator is inserted between consecutive array elements.

● Examples of Signed Decimal Integers

The following examples are for when inspection item 0 is set to the Search inspection item, the search X coordinate is -123.456 and the search Y coordinate is -456.789. The field and record separators are set to "OFF."

Example When the Minimum Field Width and Precision Are Not Used

F="%d",D="I0.X" ⇒ "-123"<CR+LF>

Examples When the Minimum Field Width (Minimum Number of Characters) Is Used

F="%5d",D="I0.X" ⇒ "*-123"<CR+LF> Note: A space is added to make five characters.

F="%05d",D="I0.X" ⇒ "-0123"<CR+LF> Note: A zero is added instead of a space.

F="%2d",D="I0.X" ⇒ "-123"<CR+LF> Note: If two characters is insufficient, the required number of characters (three) is output.

Examples When the Precision (Minimum Number of Digits) Is Used

F="%.6d",D="I0.X" ⇒ "-000123"<CR+LF> Note: Six digits are output. Zeros are added if required to make six digits.

F="%.2d",D="I0.X" ⇒ "-123" <CR+LF> Note: If two digits is insufficient, the required number of digits (three) is output.

Example When the Minimum Field Width and Precision Are Used

F="%10.6d",D="I0.X" ⇒ "***-000123"<CR+LF> Note: If ten characters and six digits are specified, three spaces and three zeros are added.

Example with Specified Text Strings

F="X is %d",D="I0.X" ⇒ "X is -123"<CR+LF> Note: The specified text string is output.

Example of Rounding Off the Digits below the Decimal Point

F="%d",D="I0.Y" ⇒ "-457"<CR+LF> Note: The decimal portion of -456.789 is rounded off.

Example of Outputting More Than One Value

F="X is %d, Y is %d",D="I0.X,I0.Y" ⇒ "X is -123, Y is -457"<CR+LF>

● Examples of Signed Decimal Fractions

The following examples are for when inspection item 0 is set to the Search inspection item, the search X coordinate is -123.456 and the search Y coordinate is -456.789. The field and record separators are set to "OFF."

Example When the Minimum Field Width and Precision Are Not Used

F="%d",D="I0.Y" ⇒ "-123.4560"<CR+LF> Note: If the precision (number of digits below the decimal point) is not specified, four digits are output. Zeros are added if there are not enough digits.

Examples When the Minimum Field Width (Minimum Number of Characters) Is Used

F="%10f",D="I0.X" ⇒ "*-123.4560"<CR+LF> Note: A space is added to make ten characters.

F="%06f",D="I0.X" ⇒ "-0123.4560"<CR+LF> Note: A zero is added instead of a space.

F="%2f",D="I0.X" ⇒ "-123.4560"<CR+LF> Note: If two characters is insufficient, the required number of characters (nine) is output.

Examples When the Precision (Number of Digits Below Decimal Point) Is Used

F="%.3f",D="I0.X" ⇒ "-123.456"<CR+LF> Note: Three digits below the decimal point are output.

F="%.2f",D="I0.X" ⇒ "-123.46"<CR+LF> Note: If two digits below the decimal is specified, the digits below the thousandths digit are rounded off.

Example When the Minimum Field Width and Precision Are Used

F="%10.3f",D="I0.X" ⇒ "***-123.456"<CR+LF> Note: If ten characters and six digits below the decimal are specified, two spaces are added.

Examples with Specified Text Strings

F="X is %f",D="I0.X" ⇒ "X is -123.4560"<CR+LF> Note: The specified text string is output.

F="\X is %f",D="I0.X" ⇒ "\X is -123.4560"<CR+LF> Note: The specified text string is output.

Example of Outputting More Than One Value

F="X is %f, Y is %f",D="I0.X,I0.Y" ⇒ "X is -123.4560, Y is -456.7890"<CR+LF>

● Examples of Outputting Array Data and the FIDX() and ECNT() Functions

The following examples are for when inspection item 0 is set to the Search inspection item, and the following results are obtained.

Three images were detected.

Correlation: 90, X coordinate: 111.111, Y coordinate: 222.222

Correlation: 80, X coordinate: 333.333, Y coordinate: 444.444

Correlation: 70, X coordinate: 555.555, Y coordinate: 666.666

* The results are sorted in the descending order of correlations.

Example of Outputting Data without Specifying Array Indices

F="%f %f",D="I0.X,I0.Y" ⇒ "111.1110 222.2220"<CR+LF> Note: If an array index is not specified, the first data in the array is output. The field and record separators are set to "OFF."

Example of Outputting Data Specifying Array Index 1

F="%f %f",D="I0.X[0],I0.Y[0]" ⇒ "111.1110 222.2220"<CR+LF> Note: Same as above.

Example of Outputting Data Specifying Array Index 2

F="%f %f",D="I0.X[1],I0.Y[1]" ⇒ "333.3330 444.4440"<CR+LF> Note: Same as above.

Example of Outputting Two Array Elements from the Start of the Array

F="%f %f",D="I0.X[],I0.Y[]",C="0,1,2" ⇒ Note: Here, CR is used as the field separator. The record separator is set to "OFF."
"111.1110 222.2220"<CR>
"333.3330 444.4440"<CR><CR+LF>

Example of Outputting Two Array Elements from the Second Element of the Array

F="%f %f",D="I0.X[],I0.Y[]",C="1,1,2" ⇒ Note: Here, CR is used as the field separator. The record separator is set to "OFF."
"333.3330 444.4440"<CR>
"555.5550 666.6660"<CR><CR+LF>

Example of Outputting the First and Third Elements But Not the Second Element of an Array

F="%f %f",D="I0.X[],I0.Y[]",C="0,2,2" ⇒ Note: Here, CR is used as the field separator. The record separator is set to "OFF."
"111.1110 222.2220"<CR>
"555.5550 666.6660"<CR><CR+LF>

Example of Outputting the Data for More Than One Detected Image

F="%f %f",D="I0.X[],I0.Y[]",C="0,1,I0.C" ⇒ Note: Here, CR is used as the field separator. The record separator is set to "OFF"
 "111.1110 222.2220"<CR>
 "333.3330 444.4440"<CR>
 "555.5550 666.6660"<CR><CR+LF>

Example Using FIDX(0)

F="%d %f %f",D="FIDX(0),I0.X[],I0.Y[]",C="0,1,I0.C" ⇒ Note: Here, CR is used as the field separator. The record separator is set to "OFF"
 "0 111.1110 222.2220"<CR>
 "1 333.3330 444.4440"<CR>
 "2 555.5550 666.6660"<CR><CR+LF>

Example Using FIDX(1)

F="%d %f %f",D="FIDX(1),I0.X[],I0.Y[]",C="1,1,2" ⇒ Note: Here, CR is used as the field separator. The record separator is set to "OFF"
 "1 333.3330 444.4440"<CR>
 "2 555.5550 666.6660"<CR><CR+LF>

Example Using ECNT(0)

F="%d",D="ECNT(0)" ⇒ "1234"<CR+LF> Note: In this example, the ring counter was 1234 at the measurement trigger.

● **Output Specification Example**

Measurement Results

- Inspection item (number): Search (0)
- Number of detections: 4
- Detection results: (X,Y)=(0,0)(1,2)(3,4)(5,6)

Output Format

- ASCII output (fixed)
- Field separator: Comma
- Record separator: CR

Output Settings

- Data 0: F="COUNT=%03d",D="I0.C"
- Data 1: F="@P%03d=%0.3f,%0.3f",D="FIDX(0),I0.X[],I0.Y[]",C="0,1,I0.C"

* I0.C: Search_count I0.X[]: X_measurement_result I0.Y[]: Y_measurement_result

 12-2 External Reference Parameters p. 412

Output Data

Data 0 output	C	O	U	N	T	=	0	0	4	,								
Data 1 output	@	P	0	0	1	=	0	.	0	0	0	,	0	.	0	0	0	,
	@	P	0	0	2	=	1	.	0	0	0	,	2	.	0	0	0	,
	@	P	0	0	3	=	3	.	0	0	0	,	4	.	0	0	0	,
	@	P	0	0	4	=	5	.	0	0	0	,	6	.	0	0	0	CR
CR+LF																		

● **Restrictions**

- There is a limit to the number of characters per field.
 Maximum number of characters per field: 2,048 characters
- If the string that is created for the output format exceeds the maximum number of characters, the portion of the string after 2,048 characters is not output.

8-6 Using the Encoder Input

The Vision Sensor can accept an encoder input. You can use the encoder input to control the measurement timing and perform synchronized control with an external robot or other device. There are three primary patterns for controlling the measurement timing with an encoder.

Pattern 1

Workpieces are placed on a rotating table at specified rotation angles. In this case, the trigger is created after a specified angle of rotation and the counter is reset after a full rotation (phase Z).

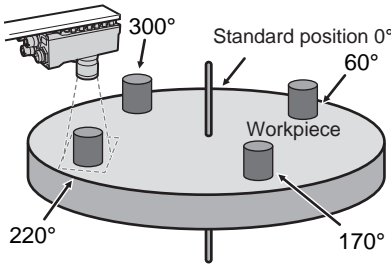

Pattern 2

A timing sensor is placed on a conveyor. This timing sensor takes an image of any workpiece that it detects. In this case, a trigger is created when the conveyor moves a certain distance after the timing sensor detects a workpiece. The counter is reset when the sensor detects a workpiece.

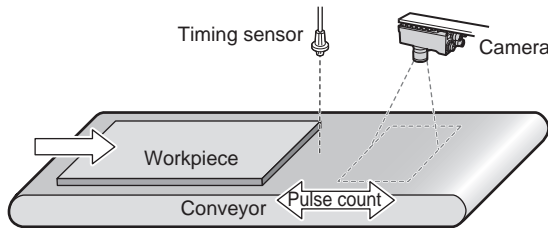

Pattern 3

Many workpieces are placed along a conveyor at different spacings. In this case, a trigger is created every time the conveyor moves a certain distance (e.g., 1/2 the field of vision). The counter is reset every time a trigger is created.

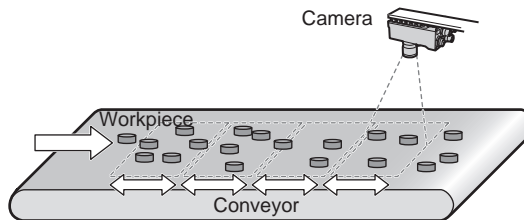

Controlling Measurement Timing with an Encoder Input

The work flow for controlling measurement timing with the encoder input is described below.

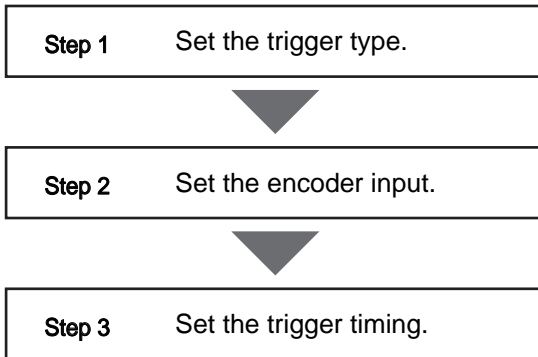

Step 1 Set the trigger type.

- ▶ **Multiview Explorer: [System] – [System data] (Double-click)**
→ Edit Pane:  (Trigger settings) Icon

- 1 Select [Encoder trigger] from the [Trigger type] list.

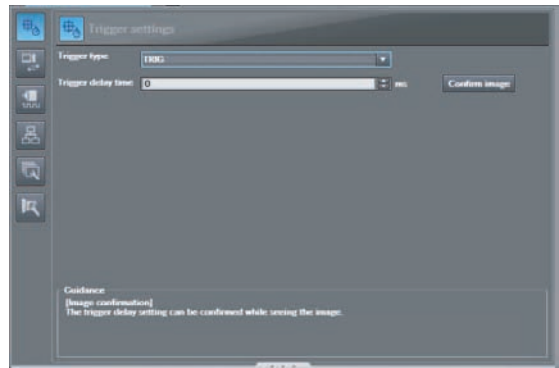

Step 2 Set the encoder input.

- **Multiview Explorer:** [System] – [System data] (double-click)
 → **Edit Pane:**  (Encoder Settings) Icon – [Common encoder settings]

- 1 Select [Direction of rotation].
- 2 Select either OFF or ON for the [Reverse-turn trigger detection].
- 3 Select the multiplier from the [Multiplication] list. This setting must be the same as the setting for the Robot Controller.
- 4 Set the [Hunting width].
- 5 Set the [Backlash width].

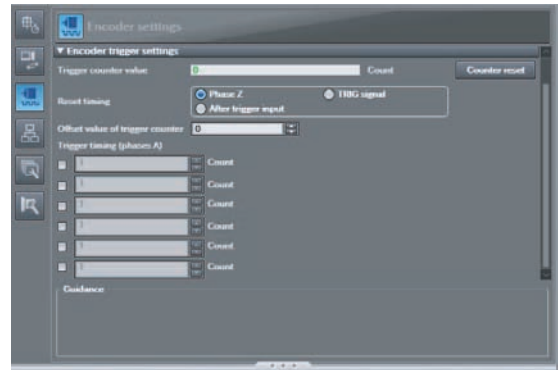

Parameter	Range	Description
Direction of rotation	CW (Clockwise) CCW (Counter-clockwise)	Specifies the direction to count up. CW: Count up when rotating clockwise. (Count down in the opposite direction.) CCW: Count up when rotating counterclockwise. (Count down in the opposite direction.)
Reverse-turn trigger detection	OFF ON	Specifies whether to create the trigger when rotating in the opposite direction. OFF: Do not create the trigger when rotating in the opposite direction. ON: Create the trigger when rotating in the opposite direction.
Multiplication	1x 2x 4x	Sets the multiplier for the input pulse count. This setting must be the same as the setting for the Robot Controller. 1x: Creates a pulse on the rising edge of phase A. 2x: Creates a pulse on the rising edge and falling edge of phase A. 4x: Creates a pulse on the rising edge and falling edge of phase A and phase B.
Hunting width	0 to 65,535	Specifies the width of hunting cap in the Servo. 0: No hunting processing
Backlash width	0 to 65,535	Specifies the backlash width in the gears. 0: No backlash processing
Terminating resistance	OFF ON	Turns the encoder terminating resistance ON or OFF. For normal 1:1 communications, turn OFF the terminating resistance for an open collector and turn it ON for a line driver. When branching with line drivers, turn OFF the terminating resistance.

Step 3 Set the trigger timing.

- ▶ **Multiview Explorer:** [System] – [System data] (double-click)
 → **Edit Pane:**  (Encoder Settings) Icon – [Encoder trigger settings]

- 1** Select the reset timing for the counter in [Reset timing].
- 2** Set the offset in [Offset value of trigger counter].
- 3** Set the counter value at which to create a trigger in [Trigger timing (phases A)].
- 4** Click the [Counter reset] Button to reset the trigger counter.

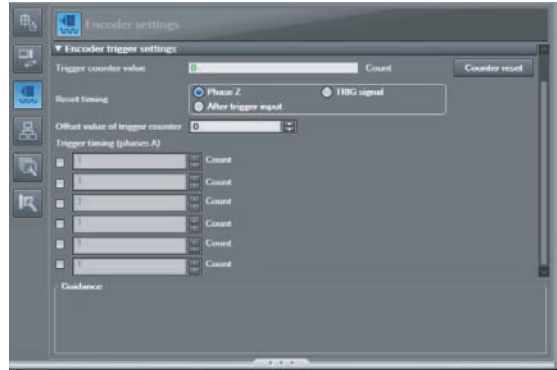

Parameter	Range	Description
Reset timing	Phase Z: Pattern 1	Resets the counter on phase Z.
	TRIG signal: Pattern 2	Resets the counter when an external TRIG signal is received.
	After trigger input: Pattern 3	Resets the counter after the trigger is created.
Offset value of trigger counter	-32,768 to +32,768	Sets the trigger counter value to add as an offset when resetting the counter.
Trigger timing	0 to 1,000,000,000	Sets the points at which to create the trigger. Up to six points can be set. If you select phase Z for the reset timing, a maximum of 6 points can be set. If you select to reset the counter for the TRIG signal or after a trigger occurs, you can set only one point.

Enabling Synchronized Control by Outputting the Encoder Value

You can synchronize the ring counter for the Vision Sensor with the counter of an external device (PLC, Robot Controller, etc.) that you need to synchronize with. This way, the Vision Sensor and the external device will have the same encoder counter value. This allows you to create synchronized information between the Sensor and the external device. The external device connected to the Vision Sensor can then use this information to perform synchronized control.

Encoder value type	Description
Image timing	Outputs the encoder value when an image is taken.

Note



Outputting Measurement Results to External Devices p. 238, p. 276, p. 302, p. 333

Setting the Ring Counter

- 1 Set the [Maximum value of ring counter] to the same value as the setting on the Robot Controller.
- 2 Set the [Offset value of ring counter].
- 3 Click the [Counter reset] Button to reset the counter.

Note

You can also input the ring counter value directly.

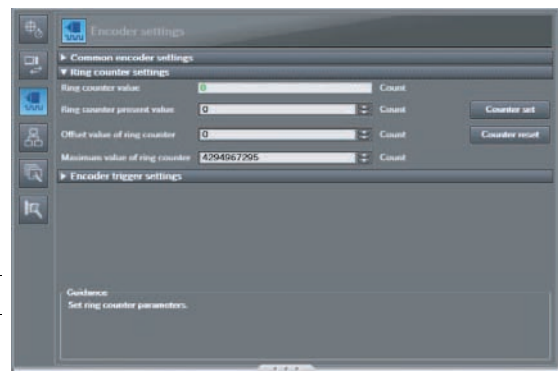

Parameter	Range	Description
Maximum value of ring counter	0 to 1,000,000,000	Sets the maximum value of the ring counter. This value must be the same as the encoder counter in the Robot Controller.
Offset value of ring counter	0 to 65,535	Sets the value of the ring counter when it is reset. If the encoder counter in the Robot Controller cannot be reset, this value must be set to match the current value.

MEMO

Calibration

9-1 Calibration	346
9-2 Calibration for Conveyor Tracking	347
9-3 General-purpose Calibration	356
9-4 Direct Input	368

9-1 Calibration

Calibration is used to convert Camera coordinates into real coordinates. The Vision Sensor supports the following two types of calibration.

- **General-purpose Calibration**

This type of calibration converts the Camera coordinates of the Vision Sensor to real coordinates with the same origin. Therefore, you can then output the detected position in the actual coordinates.

- **Calibration for Conveyor Tracking**

This type of calibration uses an encoder to convert the Camera coordinates of the Vision Sensor to coordinates for the robot placed on the same conveyor as the Sensor. You can use this type of calibration to determine the position detected by the Vision Sensor in robot coordinates. Therefore, you can then output the detected position in robot coordinates.

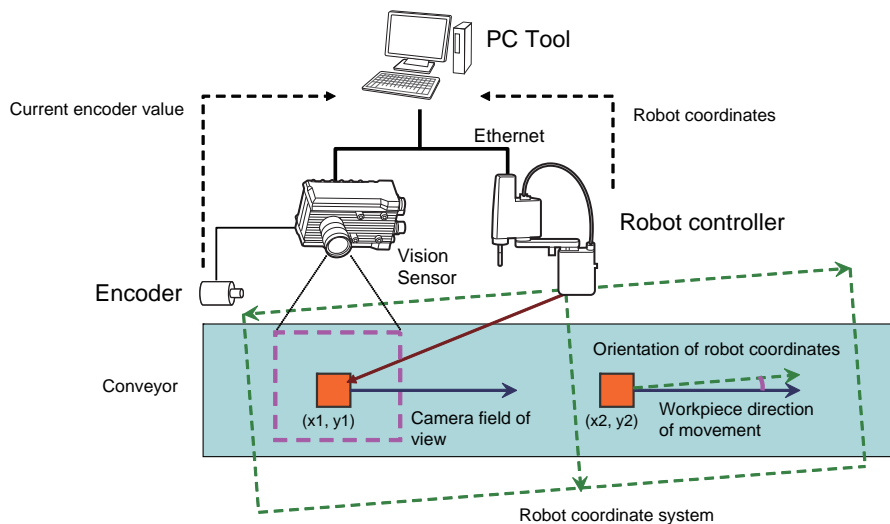

Type	Description	Execution method	Description
Calibration for Conveyor Tracking	Converts to robot coordinates on the same conveyor. This type of calibration is for conveyor tracking that uses an encoder.	Batch sampling	A specified calibration target is used for batch calibration.
		Point specification	Calibration is performed by sampling standard positions that you set.
General-purpose Calibration	Converts the coordinates to real coordinates with the same origin.	Batch sampling	A specified calibration target is used for batch calibration.
		Point specification	Calibration is performed by sampling standard positions that you set.
		Sequential sampling	Performs sequential calibration while moving a mark that you set.
		Direct input	Enter the calibration values directly.

9-2 Calibration for Conveyor Tracking

Calibration for conveyor tracking uses an encoder connected to the Vision Sensor to convert Camera coordinates to robot coordinates.

You can perform calibration for conveyor tracking in the following two ways. The calibration flow for both methods are given below.

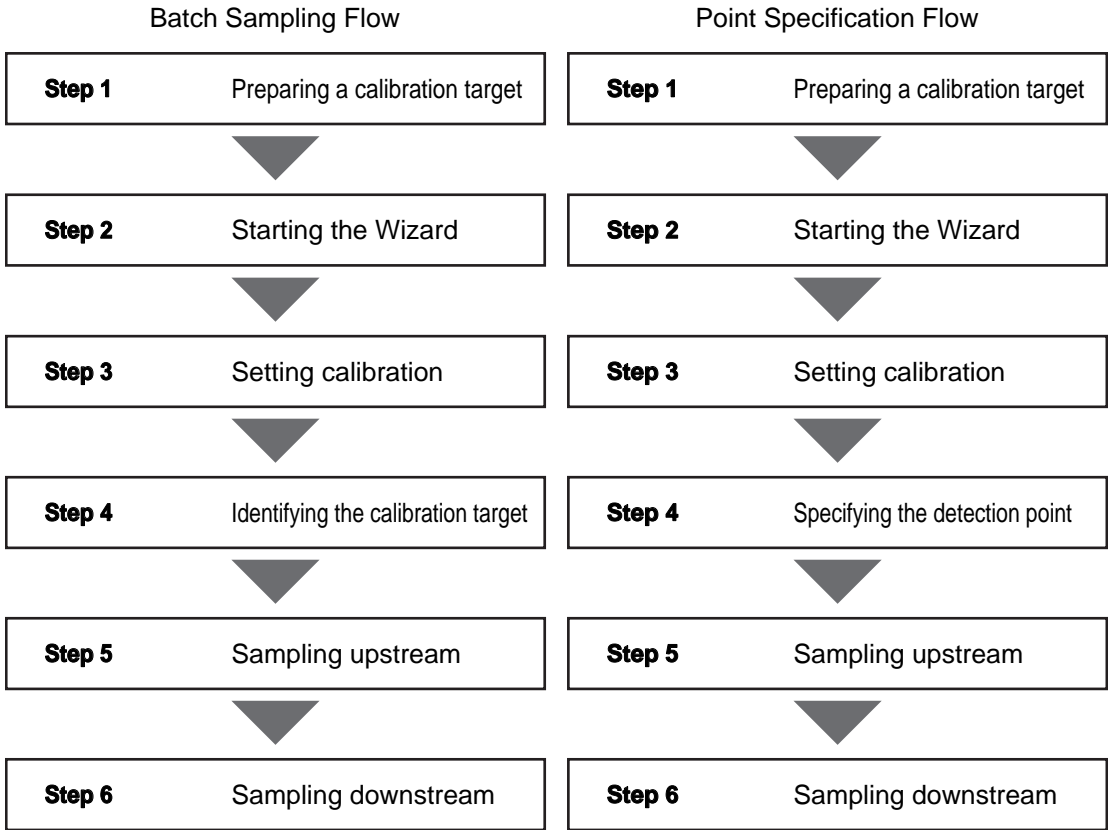

Important

Setting the Maximum Value of the Ring Counter

Before you start the Calibration Wizard, set the maximum value of the ring counter to the upper limit of 1,000,000,000. Otherwise, calibration will not be performed correctly. After you end or cancel the Calibration Wizard, return the setting of the maximum value of the ring counter to the original value. Otherwise, conveyor tracking will not operate correctly.

 Setting the Maximum Value of the Ring Counter p. 332

Batch Sampling Calibration

Step 1 Preparing a Calibration Target

- 1 Print a calibration target that is the size of the field of view of the Camera.
- 2 Place the calibration target into the Camera's field of view.

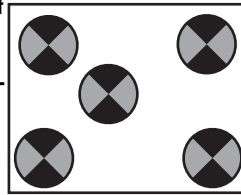

Step 2 Starting the Wizard

- 1 Select [New Calibration] from the [Calibration pattern] list to start the Calibration Wizard.

Important

Before you start the Calibration Wizard, set the maximum value of the ring counter to the upper limit of 1,000,000,000.

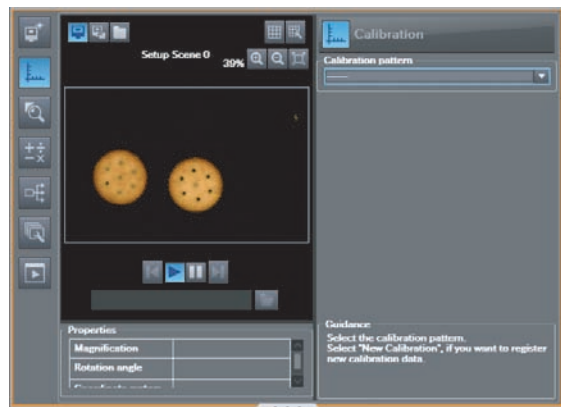

Step 3 Setting Calibration

- 1 Enter the name of the calibration in the [Name] field.
- 2 Click [Batch sampling] for Conveyor Tracking.
- 3 Click the [Next] Button.

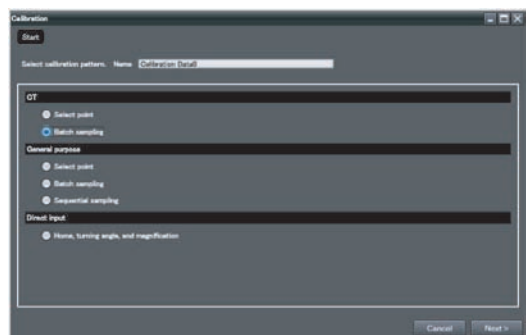

4 Click the number of sampling points to select it.

In this example, we use 4 sampling points.

5 Specify the input method for robot coordinates.

To enter a value with the keyboard, select the [Key input only] Option. Select the [Read the data via Ethernet] Option when inputting Robot Controller data via Ethernet. Enter the type, IP address, and port number of the Robot Controller. After you enter the IP address, click [Communications test] to confirm that communications are working properly.

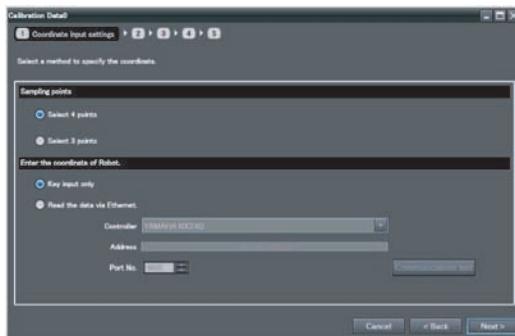

Note

If a YRC Robot Controller is connected, set the [Controller] Field to [Programmable no-protocol data output].

6 Click the [Next] Button.

Type	Description
Address	If your Controller is a trajexia, set the IP address of the Controller.

Step 4 Identifying the Calibration Target

1 Adjust the calibration target position so that all five target marks are visible.

If necessary, adjust the Camera so that the calibration targets are clearly visible.

2 Click the [Next] Button.

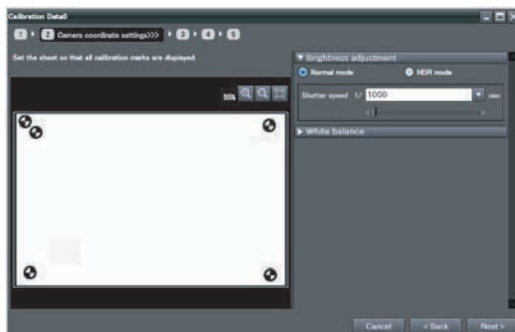

3 Make sure that all five marks can be detected.

If they cannot be properly detected, adjust the Camera.

Note

You cannot click the [Next] Button in the Wizard if there are any problems with the settings.

4 Click the [Next] Button.

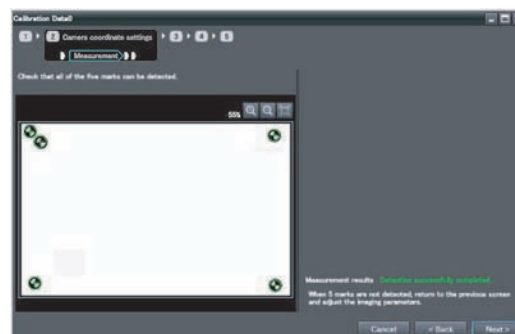

- 5 Click the [Read] Button to acquire the encoder value.
- 6 Click the [Next] Button.

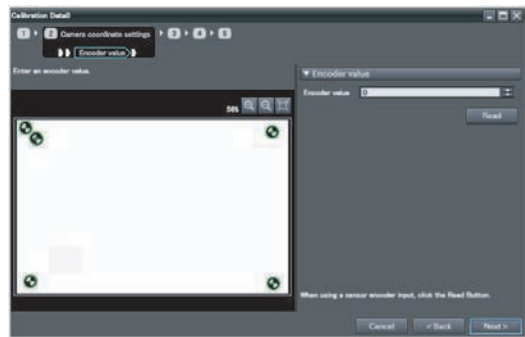

Parameter	Range	Description
Encoder value	0 to 1,000,000,000	Sets the current encoder value.

Step 5 Sampling Upstream

- 1 Move the conveyor and place the calibration target so that it is at the start of the operating range of the robot on the conveyor.
- 2 Click the [Next] Button.

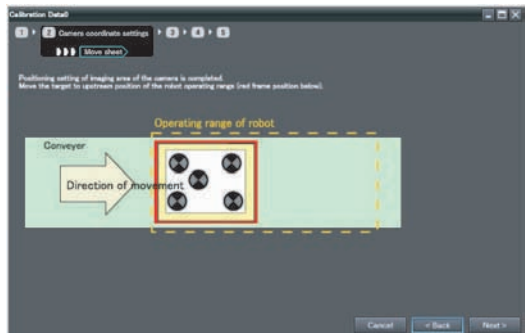

- 3 Move the center of the robot hand to the center of the cross of the first mark on the calibration target.
- 4 Enter the X and Y coordinates of the robot in the [Robot coordinates] field.
Read the coordinates of the robot from the robot's teaching pendant and enter them from the keyboard. To obtain the coordinates of the robot over the network, click the [Read] Button.

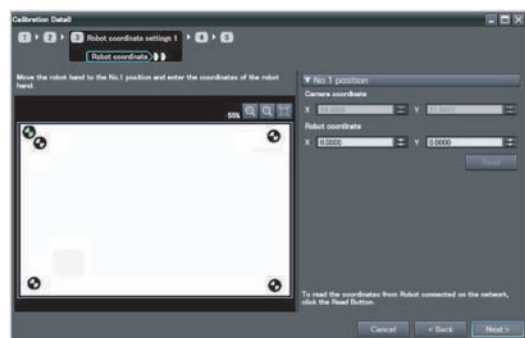

- 5 Click the [Next] Button.

Item	Parameter	Range	Description
Robot coordinates	X	-99,999.9999 to 99,999.9999	Set the X coordinate of the control device.
	Y	-99,999.9999 to 99,999.9999	Set the Y coordinate of the control device.

6 Repeat steps 3 and 4 for the number of marks specified in the [Sampling points] field.

In this example we will perform these steps for marks 2 through 4.

7 Click the [Read] Button to obtain the encoder value.

8 Click the [Next] Button.

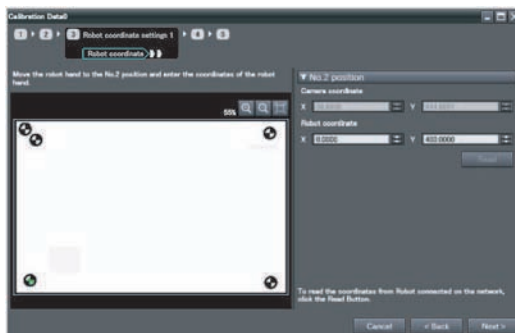

Parameter	Range	Description
Encoder value	0 to 1,000,000,000	Sets the current encoder value.

Step 6 Sampling Downstream

1 Move the conveyor and place the calibration target so that it is at the end of the operating range of the robot on the conveyor.

2 Click the [Next] Button.

Note

If you select [Input the value directly] and enter values for the [X Distance per 1 encoder pulse] and [Y Distance per 1 encoder pulse], steps 1 through 7 are not necessary.

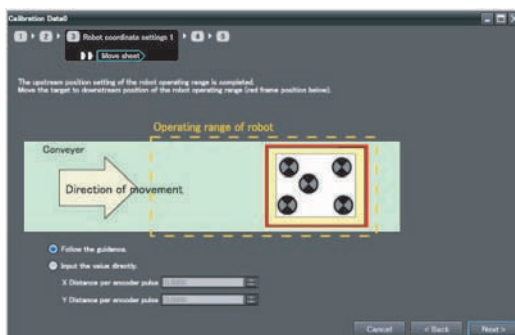

3 Move the center of the robot hand to the center of the cross of the first mark on the calibration target.

4 Enter the X and Y coordinates of the robot in the [Robot coordinates] field.

Read the coordinates of the robot from the robot's teaching pendant and enter them from the keyboard. To obtain the coordinates of the robot over the network, click the [Read] Button.

5 Click the [Next] Button.

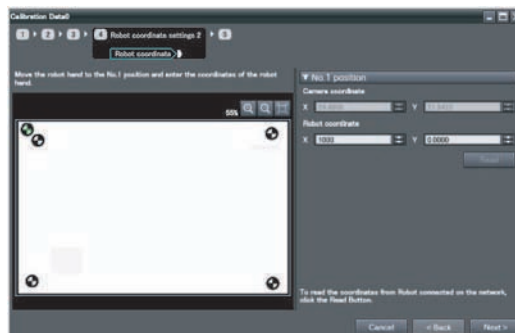

Item	Parameter	Range	Description
Robot coordinates	X	-99,999.9999 to 99,999.9999	Set the X coordinate of the control device.
	Y	-99,999.9999 to 99,999.9999	Set the Y coordinate of the control device.

- 6 Click the [Read] Button to obtain the encoder value.
- 7 Click the [Next] Button.

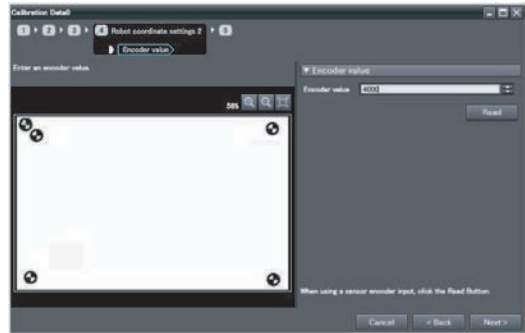

Parameter	Range	Description
Encoder value	0 to 1,000,000,000	Sets the current encoder value.

- 8 Check the results of the calibration.
- 9 Click the [Exit] Button to close the Wizard.

Important

- After you end or cancel the Calibration Wizard, return the setting of the maximum value of the ring counter to the original value.
- The error that is maintained for calibration is the average of the distance between the following two points.
 - The camera coordinates that were used to calculate calibration coefficients A to F converted to robot coordinates using calibration coefficients A to F
 - The robot coordinates that were used to calculate the calibration coefficients A to F

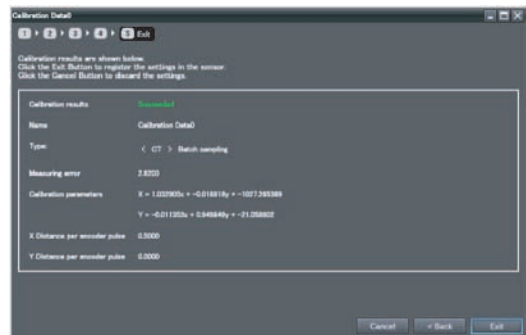

Point Specification Calibration

In this type of calibration, the user specifies each target mark detection point used for calibration. For example, we will use a calibration target with four crosses as shown in the figure on the right. Then, we will specify the intersections of each cross A through D on top of the image and obtain the Camera coordinates of the target mark detection points. The method used to obtain robot coordinates is the same as that used for batch sampling.

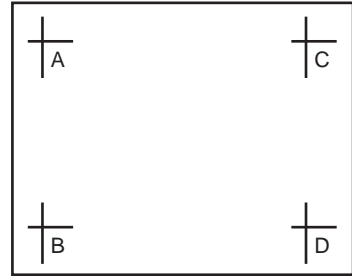

Step 1 Preparing a Calibration Target

Prepare at least 3 calibration targets according to the size of the field of view.

Step 2 Starting the Wizard

Start the Wizard in the PC Tool.

 Step 2 Starting the Wizard p. 348

Important

Before you start the Calibration Wizard, set the maximum value of the ring counter to the upper limit of 1,000,000,000.

Step 3 Setting Calibration

Select [Select point] for Conveyor Tracking under the calibration settings.

- 1 Enter the name of the calibration in the [Name] field.
- 2 Click [Select point] under Conveyor Tracking.
- 3 Click the [Next] Button.

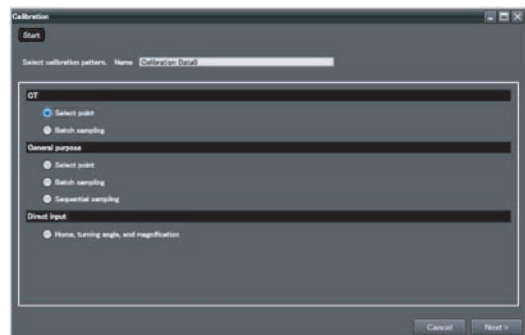

- Click the number of sampling points to select it.

In this example, we use 4 sampling points.

- Specify the input method for robot coordinates.

To enter a value with the keyboard, select the [Key input only] Option. Select the [Read the data via Ethernet] Option when inputting Robot Controller data via Ethernet. Enter the type, IP address, and port number of the Robot Controller. After you enter the IP address, click [Communications test] to confirm that communications are working properly.

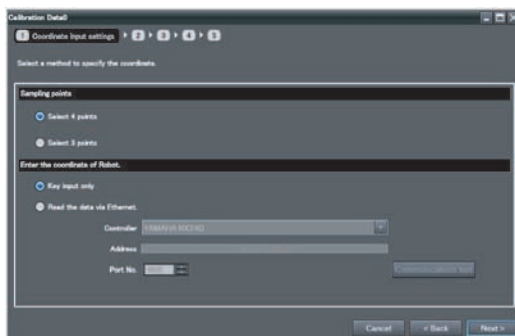

Note

If a YRC Robot Controller is connected, set the [Controller] Field to [Programmable no-protocol data output].

- Click the [Next] Button.

Type	Description
Address	If your Controller is a trajexia, set the IP address of the Controller.

Step 4 Specifying the Detection Point

Specify detection points A through D on the display and obtain the Camera coordinates for those detection points.

- Adjust the calibration target position so that the target marks are visible..

If necessary, adjust the Camera so that the calibration targets are clearly visible.

- Click the [Next] Button.

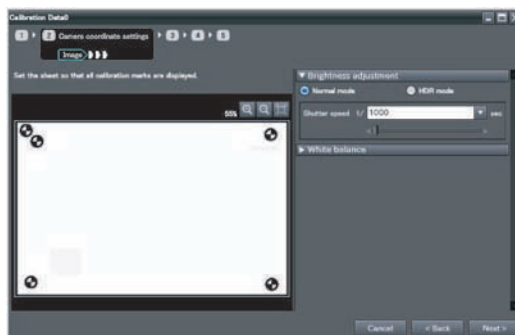

- Click the position of the first mark on the image or enter the position in Camera coordinates (X, Y) directly.

- Click the [Next] Button.

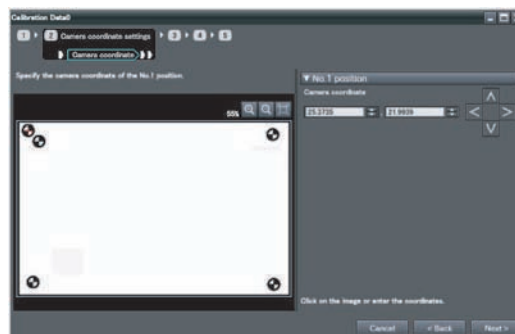

- Repeat steps 3 and 4 for the number of marks specified in the [Sampling points] field.

In this example we will perform these steps for marks 2 through 4.

- Click the [Read] Button to acquire the encoder value.
- Click the [Next] Button.

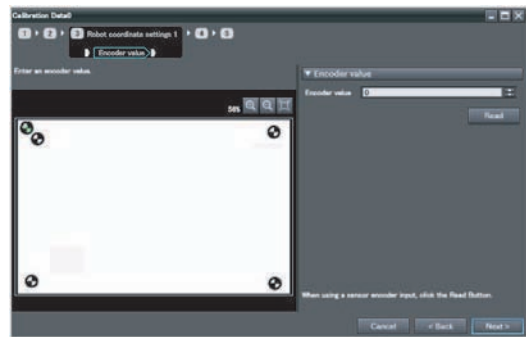

Item	Parameter	Range	Description
Camera coordinates	X	0 to 99,999.9999	Set the X coordinate of the Camera.
	Y	0 to 99,999.9999	Set the Y coordinate of the Camera.
Encoder value		0 to 1,000,000,000	Sets the current encoder value.

Step 5 Sampling Upstream

Place the calibration target at the start of the operating range of the robot, specify the detection points of the target mark with the robot, and obtain the robot coordinates.

 Step 5 Sampling Upstream p. 350

Step 6 Sampling Downstream

Place the calibration target at the end of the operating range of the robot, specify the detection points of the target mark with the robot, and obtain the robot coordinates.

 Step 6 Sampling Downstream p. 351

Important

After you end or cancel the Calibration Wizard, return the setting of the maximum value of the ring counter to the original value.

9-3 General-purpose Calibration

General-purpose Calibration

Three calibration methods are supported.

The calibration flow for these methods are given below.

Batch Sampling Flow

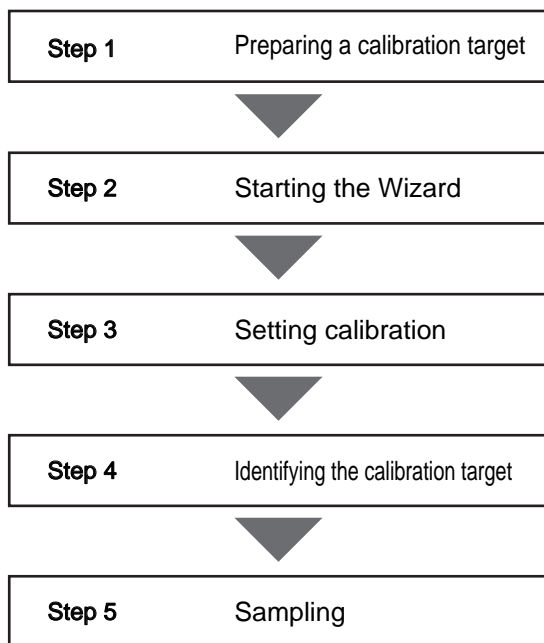

Point Specification Flow

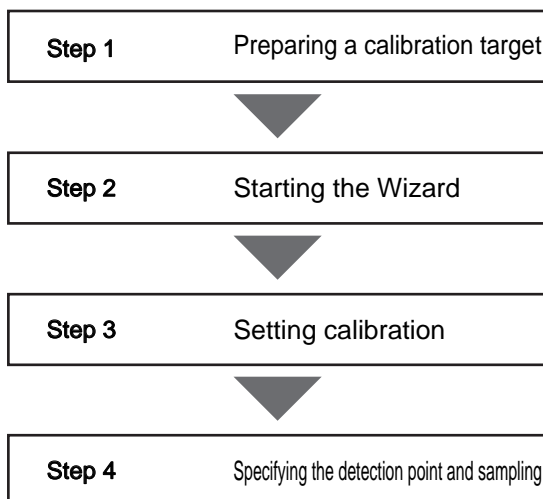

Sequential Sampling Flow

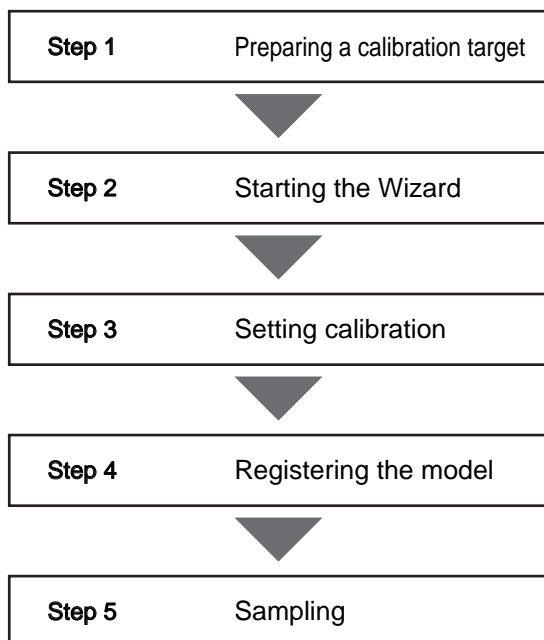

Batch Sampling Calibration

Calibration with batch sampling uses special target markers to calibrate in the same way as for batch sampling calibration for conveyor tracking. Unlike calibration for conveyor tracking, an encoder input is not used.

Step 1 Preparing a Calibration Target

Print out a special calibration target that is sufficient for the size of the field of view.

 Step 1 Preparing a Calibration Target p. 348

Step 2 Starting the Wizard

Start the Wizard in the PC Tool.

 Step 2 Starting the Wizard p. 348

Step 3 Setting Calibration

Select [Batch sampling] in the calibration settings.

- 1 Enter the name of the calibration in the [Name] field.
- 2 Select [Batch sampling] in the [General purpose] area.
- 3 Click the [Next] Button.

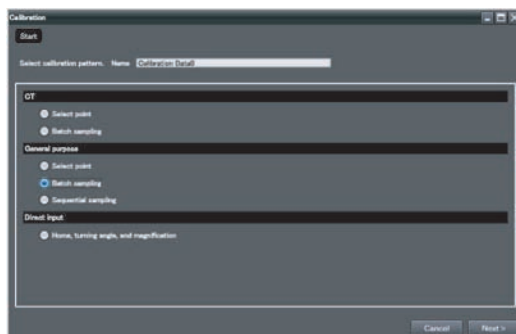

- 4 Select the number of sampling points. In this example, we use 4 sampling points.
- 5 Select the input method for coordinates after calibration.

Select [Key input only] to enter the coordinates from the keyboard.

Select the [Read the data via Ethernet] Option when inputting Robot Controller data via Ethernet.

Enter the type, IP address, and port number of the Robot Controller.

After you enter the IP address, click [Communications test] to confirm that communications are working properly.

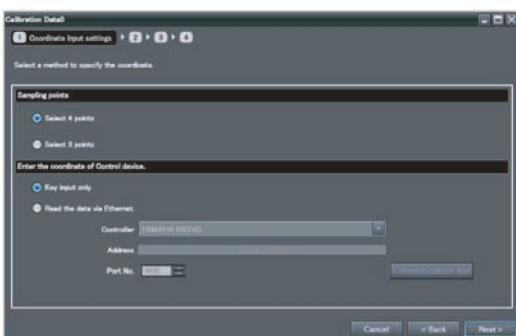

Note

If a YRC Robot Controller is connected, set the [Controller] Field to [Programmable no-protocol data output].

- 6 Click the [Next] Button.

Item	Description
Address	If your Controller is a Trajexia, set the IP address of the Controller.

Step 4 Identifying the Calibration Target

The special calibration target is recognized and the coordinates of the detected points are obtained automatically.

1 Adjust the calibration target position so that all five target marks are visible.

If necessary, adjust the Camera so that the calibration targets are clearly visible.

2 Click the [Next] Button.

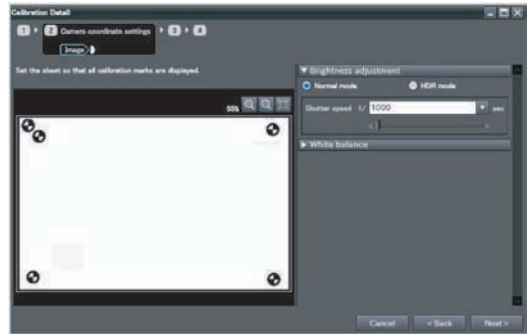

3 Make sure that all five marks are detected.

If they cannot be properly detected, adjust the Camera.

4 Click the [Next] Button.

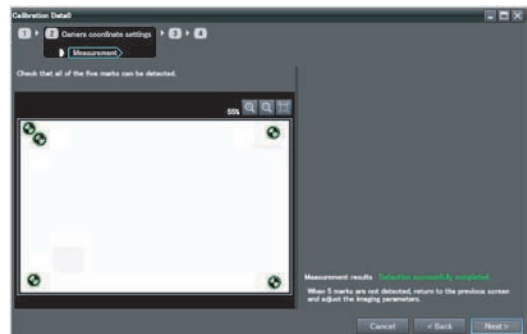

Step 5 Sampling

The coordinates of the detected points on the target marks after calibration are obtained.

1 Enter the X and Y coordinates after calibration in the [Coordinates of control device] fields.

To obtain the coordinates after calibration over the network, click the [Read] Button.

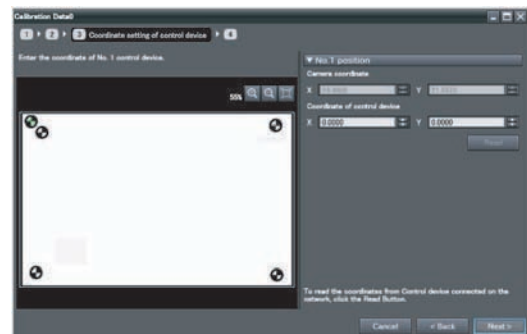

2 Click the [Next] Button.

Item	Parameter	Range	Description
Coordinates of control device	X	-99999.9999 to 99999.9999	Set the X coordinate of the control device.
	Y	-99999.9999 to 9999.9999	Set the Y coordinate of the control device.

3 Repeat steps 3 and 4 for the number of marks specified in the [Sampling points] field.

In this example, we perform these steps for marks 2 through 4.

4 Click the [Next] Button.

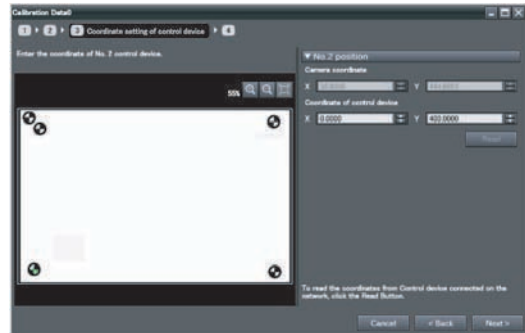

5 Check the results of the calibration.

6 Click the [Exit] Button to close the Wizard.

Important

- The error that is maintained for calibration is the average of the distance between the following two points.
 - The camera coordinates that were used to calculate calibration coefficients A to F converted to robot coordinates using calibration coefficients A to F
 - The robot coordinates that were used to calculate the calibration coefficients A to F



Point Specification Calibration

Calibration with point specification uses special target markers prepared by the user to calibrate in the same way as for point specification calibration for conveyor tracking. Unlike calibration for conveyor tracking, an encoder input is not used.

Step 1 Preparing a Calibration Target

Prepare at least 3 calibration targets that are sufficient for the size of the field of view.

 Step 1 Preparing a Calibration Target p. 348

Step 2 Starting the Wizard

Start the Wizard in the PC Tool.

 Step 2 Starting the Wizard p. 348

Step 3 Setting Calibration

Select [Select point] in the calibration settings as follows:

- 1** Enter the name of the calibration in the [Name] field.
- 2** Select [Select point] in the [General purpose] area.
- 3** Click the [Next] Button.

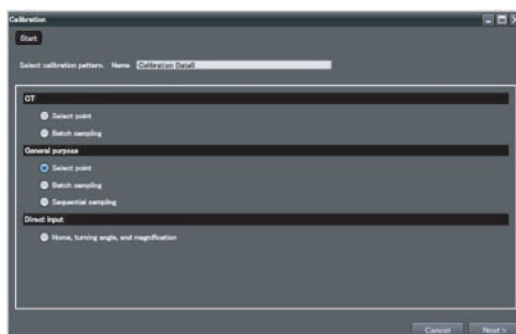

4 Change the [Sampling points] with the slider.

In this example, we use 4 sampling points.

5 Select the input method for coordinates after calibration.

Select [Key input only] to enter the coordinates from the keyboard.

Select the [Read the data via Ethernet] Option when inputting Robot Controller data via Ethernet.

Enter the type, IP address, and port number of the Robot Controller.

After you enter the IP address, click [Communications test] to confirm that communications are working properly.

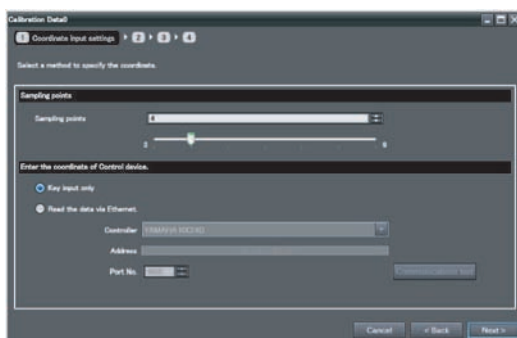

Note

If a YRC Robot Controller is connected, set the [Controller] Field to [Programmable no-protocol data output].

6 Click the [Next] Button.

Item	Description
Address	If your Controller is a Trajexia, set the IP address of the Controller.

Step 4 Specifying the Detection Point and Sampling

1. Specify the detected points on the target marks on the display to obtain the Camera coordinates.
2. Specify the detected points on the target marks after calibration.
3. Repeat the above two steps for all of the target marks on the calibration target.

1 Adjust the calibration target position so that the target marks are visible.

If necessary, adjust the Camera so that the calibration targets are clearly visible.

2 Click the [Next] Button.

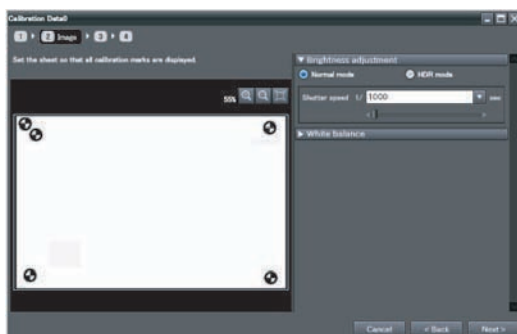

3 Click the position of the first mark on the image or enter the position in Camera coordinates (X, Y) directly.

4 Click the [Next] Button.

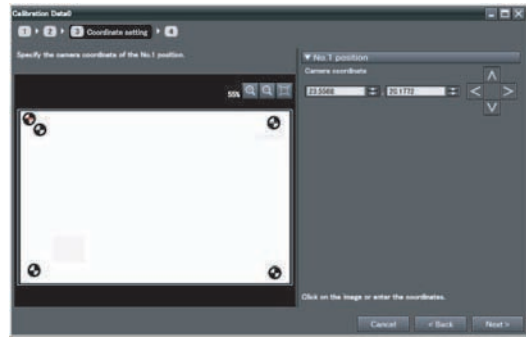

5 Enter the X and Y coordinates after calibration in the [Coordinates of control device] fields.

To obtain the coordinates after calibration over the network, click the [Read] Button.

6 Click the [Next] Button.

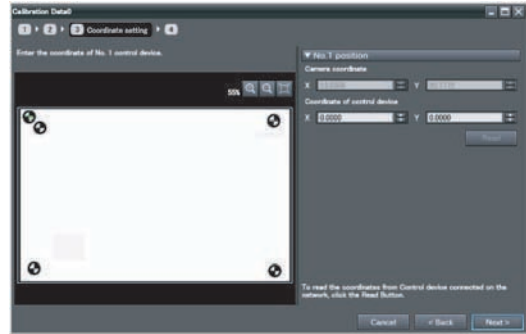

Item	Parameter	Range	Description
Camera coordinates	X	0 to 99999.9999	Set the X coordinate of the Camera.
	Y	0 to 99999.9999	Set the Y coordinate of the Camera.
[Coordinates of control device]	X	-99999.9999 to 99999.9999	Set the X coordinate of the control device.
	Y	-99999.9999 to 9999.9999	Set the Y coordinate of the control device.

7 Repeat steps 3 to 6 for the number of marks specified in the [Sampling points] field.

In this example, we perform these steps for marks 2 through 4.

8 Click the [Next] Button.

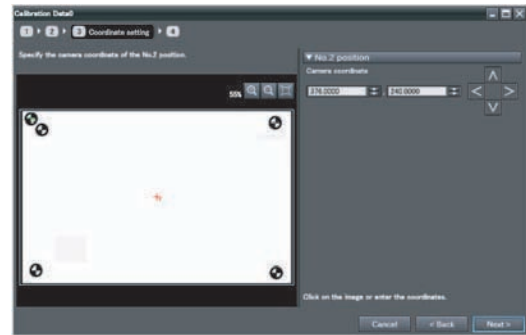

9 Check the results of the calibration.

10 Click the [Exit] Button to close the Wizard.

Important

- The error that is maintained for calibration is the average of the distance between the following two points.
 - The camera coordinates that were used to calculate calibration coefficients A to F converted to robot coordinates using calibration coefficients A to F
 - The robot coordinates that were used to calculate the calibration coefficients A to F

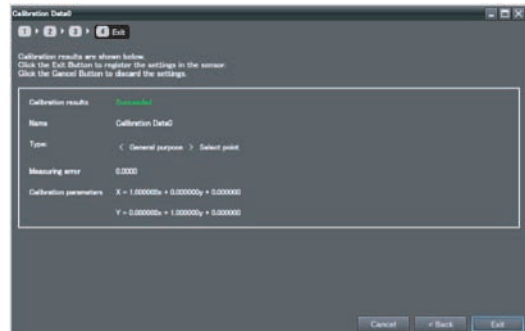

Sequential Sampling Calibration

With sequential sampling, a sample workpiece prepared by the user, such as an actual workpiece, is used for calibration. Anything can be used as long as the workpiece image can be registered as a model and searching is possible. Sampling is performed for one workpiece in various locations in the field of view, and the Camera coordinate and robot coordinates are obtained to calibrate the system.

Step 1 Preparing a Calibration Target

Prepare one calibration target, such as a workpiece or mark.

 Step 1 Preparing a Calibration Target p. 348

Note

Sequential sampling allows you to set any model as a calibration target.

Step 2 Starting the Wizard

Start the Wizard in the PC Tool.

 Step 2 Starting the Wizard p. 348

Step 3 Setting Calibration

Select [Sequential sampling] in the calibration settings.

- 1 Enter the name of the calibration in the [Name] field.
- 2 Select [Sequential sampling] in the [General purpose] area.
- 3 Click the [Next] Button.

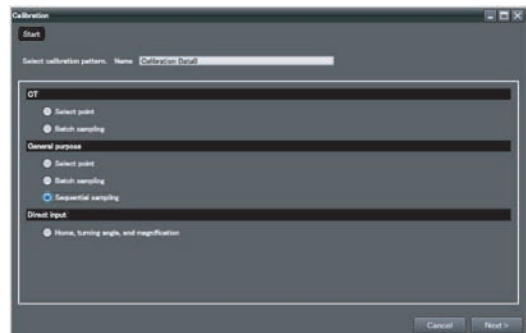

4 Change the [Sampling points] with the slider.

In this example, we use 4 sampling points.

5 Select the input method for coordinates after calibration.

Select [Key input only] to enter the coordinates from the keyboard.

Select the [Read the data via Ethernet] Option when inputting Robot Controller data via Ethernet.

Enter the type, IP address, and port number of the Robot Controller.

After you enter the IP address, click [Communications test] to confirm that communications are working properly.

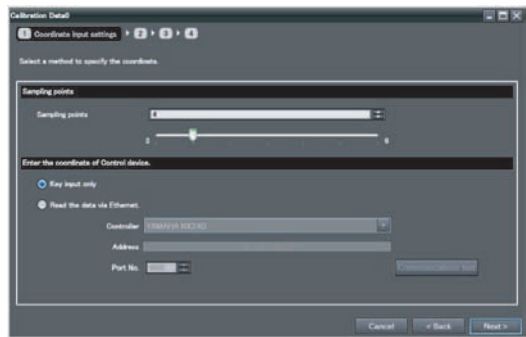

Note

If a YRC Robot Controller is connected, set the [Controller] Field to [Programmable no-protocol data output].

6 Click the [Next] Button.

Item	Description
Address	If your Controller is a Trajexia, set the IP address of the Controller.

Step 4 Registering the Model

Register a target model from a workpiece or mark, and then set the detection points.

- 1 **Adjust the calibration target position so that the target marks are visible.**

If necessary, adjust the Camera so that the calibration targets are clearly visible.

- 2 **Click the [Next] Button.**

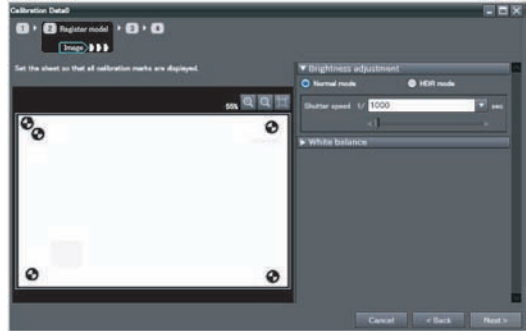

- 3 **Register the target marks as a model image using teaching.**

Note

The setting methods for teaching are the same as for the Search inspection item.

 Teaching p. 89

- 4 **Click the [Next] Button.**

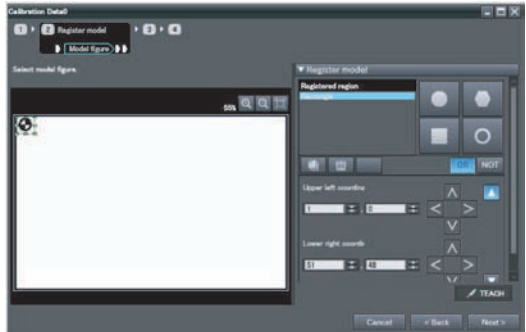

- 5 **Register the Camera coordinates of the sample workpiece (i.e., target marks or any workpiece) as the detection points.**

- 6 **Click the [Next] Button.**

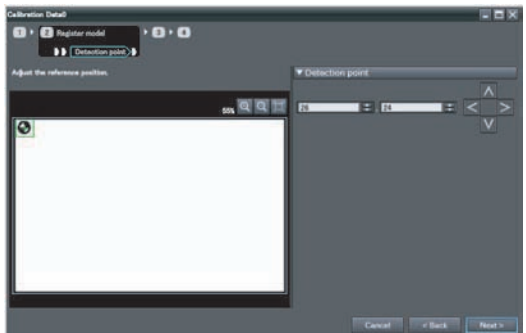

- 7 **Make sure that the sample marks are detected.**

If they are not detected correctly, adjust the candidate level or register the model again.

- 8 **Click the [Next] Button.**

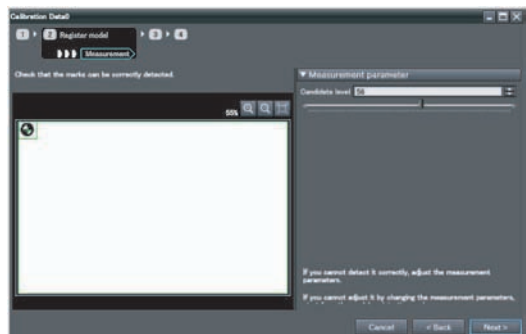

Step 5 Sampling

1. Place the target on one point in the field of view.
2. Obtain the Camera coordinates of the target mark (obtained automatically by the Search inspection item).
3. Obtain the coordinates of the detected points on the target marks after calibration.
4. Perform the above three steps for all of the sampling points in the field of view (four in this example).

1 Register the Camera coordinates (X, Y) for the first point.

To automatically obtain the Camera coordinates from the displayed image, click the [Measurement] Button.

2 Click the [Next] Button.

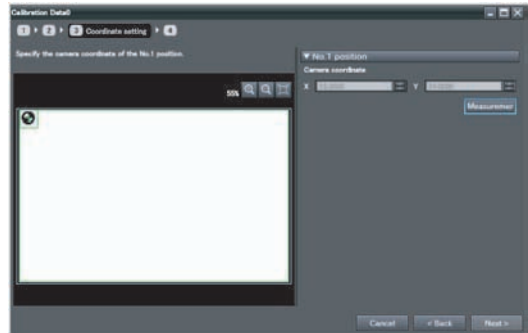

3 Enter the X and Y coordinates after calibration in the [Coordinates of control device] fields.

To obtain the coordinates after calibration over the network, click the [Read] Button.

4 Click the [Next] Button.

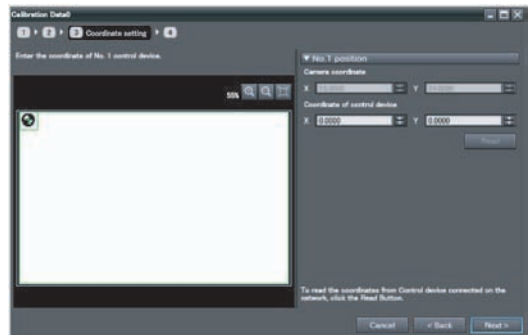

Item	Parameter	Range	Description
Camera coordinates	X	0 to 99999.9999	Set the X coordinate of the Camera.
	Y	0 to 99999.9999	Set the Y coordinate of the Camera.
Coordinates of control device	X	-99999.9999 to 99999.9999	Set the X coordinate of the robot.
	Y	-99999.9999 to 9999.9999	Set the Y coordinate of the robot.

5 Repeat the above four steps for marks 2 to 4.

6 Click the [Next] Button.

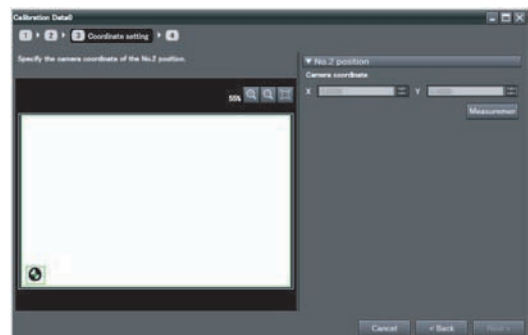

7 Check the results of the calibration.

8 Click the [Exit] Button to close the Wizard.

Important

- The error that is maintained for calibration is the average of the distance between the following two points.
 - The camera coordinates that were used to calculate calibration coefficients A to F converted to robot coordinates using calibration coefficients A to F
 - The robot coordinates that were used to calculate the calibration coefficients A to F

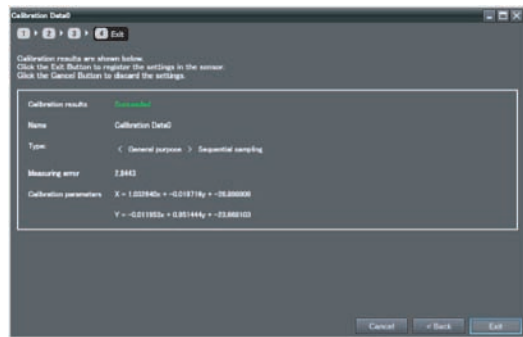

9-4 Direct Input

Specify the calibration coordinates for the robot and the Camera directly from the position of the origin, the coordinate magnification, and the coordinate rotation angle. The flow for direct input is given below.

Step 1 Starting the Wizard

 Step 2 Starting the Wizard p. 348

Step 2 Setting Calibration

- 1 Enter the name of the calibration in the [Name] field.
- 2 Click [Home, turning angle, and magnification] for direct entry.
- 3 Click the [Next] Button.

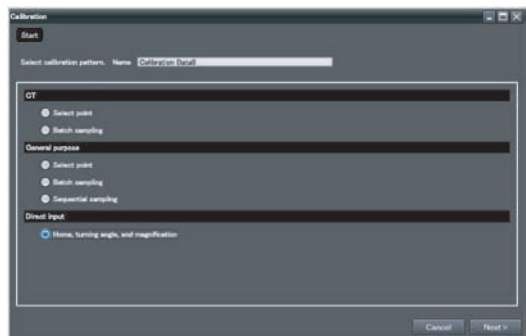

Step 3 Enter the Calibration Information

- 1 Enter the Camera coordinates and the coordinates after calibration.

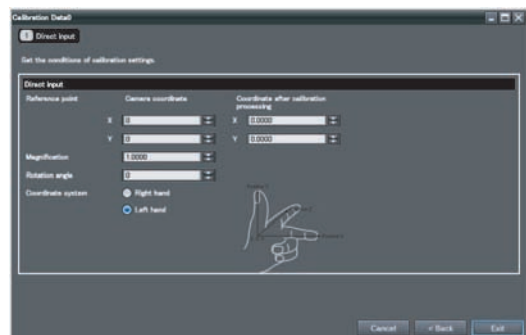

The settings parameters are listed in the following table.

Parameter	Range of value	Description
Position X of camera coordinates	-9,999.9999 to 9,999.9999	Set the X coordinate of standard position in the Camera coordinate system.
Position Y of camera coordinates	-9,999.9999 to 9,999.9999	Set the Y coordinate of standard position in the Camera coordinate system.
Position X after calibration processing	-9,999.9999 to 9,999.9999	Set the X coordinate of standard position in the converted coordinate system. This is the value of the X coordinate of the position after calibration (i.e., in robot coordinates) that correspond to position X of Camera coordinates.
Position Y after calibration processing	-9,999.9999 to 9,999.9999	Set the Y coordinate of standard position in the converted coordinate system. This is the value of the Y coordinate of the position after calibration (i.e., in robot coordinates) that correspond to position Y of Camera coordinates.
Magnification	0.0001 to 9,999.9999	Specifies how many pixels to replace individual pixels with for magnification.
Rotation angle	-180 to 180	Sets the rotational offset of the robot coordinates in relation to the Camera coordinates.
Coordinate system	Right-hand or Left-hand	Sets the coordinate system for the position after calibration processing (robot coordinates).

MEMO

Offline Settings

10-1 Offline Setup.....	372
10-2 Starting a Project in Offline Mode	373
10-3 Changing between Online and Offline	374
10-4 Offline Simulation of Sensor Measurement Operations.....	375
10-5 Offline Debugging of the Sensor Control Program and Sensor Operation	376

10-1 Offline Setup

With the PC Tool, you can change settings offline without connecting to the Vision Sensor. Parameters set offline can be saved as project data, just like online settings, and conditions set offline can be transferred to any specified Sensor.

When you change settings offline, you must use image files stored on your computer. You can perform basically any settings that you can when online. However, the following parameters modify the displayed image when you are online, but they will not modify the displayed image when you are offline.

Item		Reference
Image settings	Brightness setting	p. 74
	White balance	p. 78
	Partial input	p. 159
	Lighting controls	p. 226, p. 227
	Strobe controller settings	p. 73

The following functions are disabled during offline setup.

Item		Reference
System	Image display for trigger delay settings	p. 80
Monitor	File logging	p. 191
Calibration	Wizard settings for calibration other than with direct input	p. 346

10-2 Starting a Project in Offline Mode

To start a project in Offline Mode, select [Enter the type] on the Select Sensor Dialog Box after you create a project, then select the sensor type and version.

You cannot change the sensor type and version after you select them.

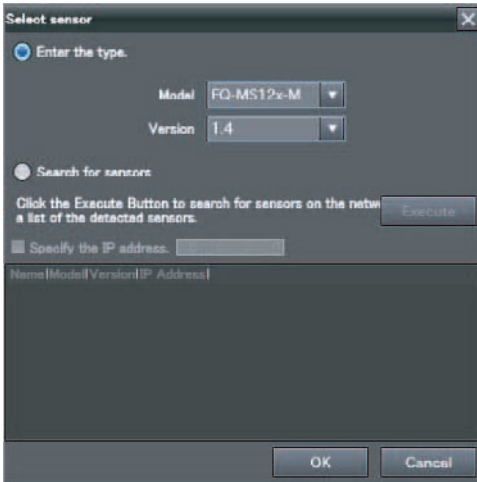

10-3 Changing between Online and Offline

Before you go offline, save all settings and parameter changes to the Sensor's internal memory. Saving your project does not save the data in the Sensor.

You can use the following two methods to change between offline and online.

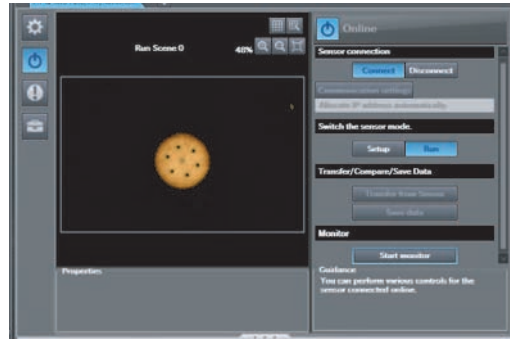

- ▶ **Multiview Explorer: Right-click the Sensor model – [Offline/Disconnect] or [Online/Connect]**
- ▶ **Multiview Explorer: [Device group] – Sensor model**
→ **Edit Pane:  (Online) Icon – [Sensor connection] – [Connect] or [Disconnect]**

- 1 To go offline, select [Disconnect]. To go online, select [Connect].**



- 2 When you select [Connect], the Connect to Sensor Dialog Box is displayed.**
- 3 When you select [Connect], you must synchronize the data between the Sensor and the project.**
Follow the guidance and synchronize the data.

Note

-  Saving Settings in the Sensor p. 161
-  Saving a Project p. 59

10-4 Offline Simulation of Sensor Measurement Operations





You can simulate measurements offline without connecting to the Vision Sensor. You can use external image files and perform measurements under the conditions set in the offline settings, then display the results of those measurements. You can use the following procedure to select the image data for measurement.

- 1 Click the file folder icon below the image display and select an image file.



- 2 Measurement is performed on the displayed image. You can click the file button and select another image file in the same folder to change to that image file.



Operation button	Item	Description
	Live display	Measures and displays every image file in the folder in order.
	Freeze display	Measures and displays only the selected images.
	Next	Measures and displays the next image file in the folder.
	Previous	Measures and displays the previous image file in the folder.

Note

The processing time for offline measurements is not the same as the processing time for the Sensor. If you want to check the processing time, you must perform the measurements online.

10-5 Offline Debugging of the Sensor Control Program and Sensor Operation

If an EtherCAT system is configured, you can perform a linked simulation between the sequence control of an NJ-series Controller and the operation of an FQ-M Sensor. This allows you to debug operation offline from when measurements and other processing is performed for control signals, such as measurement triggers, through the output of processing results.

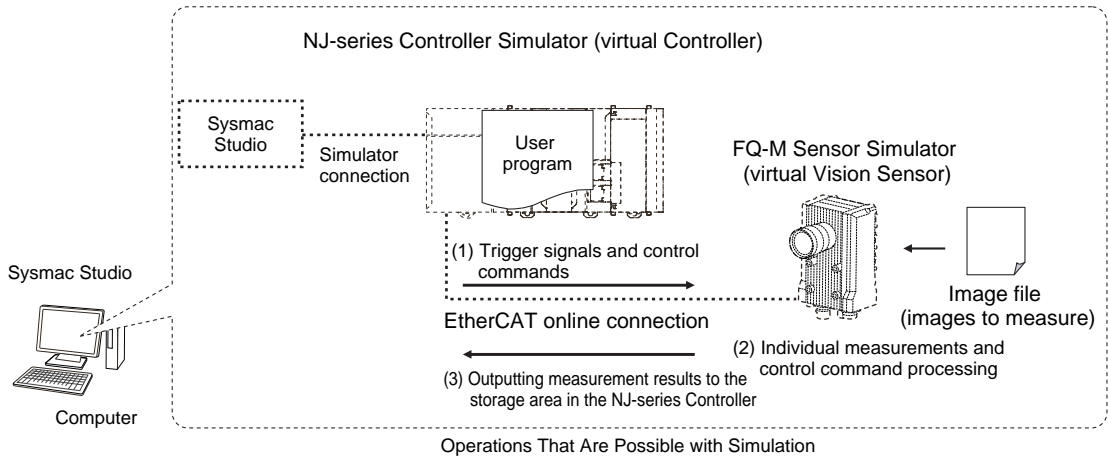

The following table shows the items in the PDO mapping that you can debug offline.

Item	Description	Support	Remarks	
Command area	Measurement execution	Measurement execution request	Supported.	
	Command execution	Continuous measurement start request	Supported.	
		Continuous measurement end request	Supported.	
		Measurement value clear request	Supported.	
		Data output buffer clear request	Supported.	
		Sensor save request	Supported.	
		Model re-registration request	Supported.	
		Reset request	Supported.	
		Scene number acquisition request	Supported.	
		Latest error information acquisition request	Supported.	
		Scene change request	Supported.	
		Inspection item data output request	Supported.	
		EtherCAT data output data acquisition request	Supported.	
		Realtime encoder value acquisition request	Not supported.	A value of 0 is always output.
		Software version acquisition request	Supported.	
		System data acquisition request	Supported.	
		Encoder information acquisition request	Supported.	
		Inspection item data setting request	Supported.	
		EtherCAT data output data acquisition request	Supported.	
	System data setting request	Supported.		
Encoder data setting request	Supported.			
Data output request	Data output request	Supported.		
Clearing errors	Error clear request	Supported.		

Item		Description	Support	Remarks
Response area	FLG	Command Completed signal	Supported.	
	BUSY	Command Execution Active signal	Supported.	
	READY	Ready signal	Supported.	
	OR	Overall Judgement	Supported.	
	ERR	Error signal	Supported.	
	RUN	Run Mode signal	Supported.	
	GATE	Data Output Completed signal	Supported.	
Data area	32 bytes		Partially supported.	A value of 0 is always output for the encoder value. The results of Sensor simulation are output for other values.
	64 bytes		Partially supported.	
	128 bytes		Partially supported.	
	256 bytes		Partially supported.	

Note

Logging is not supported offline.

Note

Simulation of Sensor measurement operations and other processing is performed for image files that are prepared in advance.



Selecting the Image File to Measure p.378

Important

Simulation is possible only on the Standard Edition of the Sysmac Studio.

Registering the FQ-M as an EtherCAT Slave

You use the Sysmac Studio (Standard Edition) to add the FQ-M to the EtherCAT slave configuration. Refer to the *Sysmac Studio Version 1 Operation Manual* (Cat. No. W504) for details on registering slaves. Only simplified procedures are provided here.

- **Opening the Edit EtherCAT Configuration Tab Page**

▶ **Multiview Explorer: [Configurations and Setup] – [EtherCAT] (Double-click)**

- **Registering a Slave Offline (Building the Network Configuration)**

1 Use either of the following methods to add an FQ-M slave to the master.

- Drag [FQ-MS□□□-ECT] or [FQ-MS□□□-M-ECT] from the [Toolbox] to the master in the Edit Network Configuration Tab Page.
- Select the master in the Edit Network Configuration Dialog Box and then double-click [FQ-MS□□□-ECT] or [FQ-MS□□□-M-ECT] in the [Toolbox].

- 2 Select the FQ-M that was added to the Edit Network Configuration Tab Page and change the node address of the FQ-M to the node address that is set on the FQ-M hardware switches.

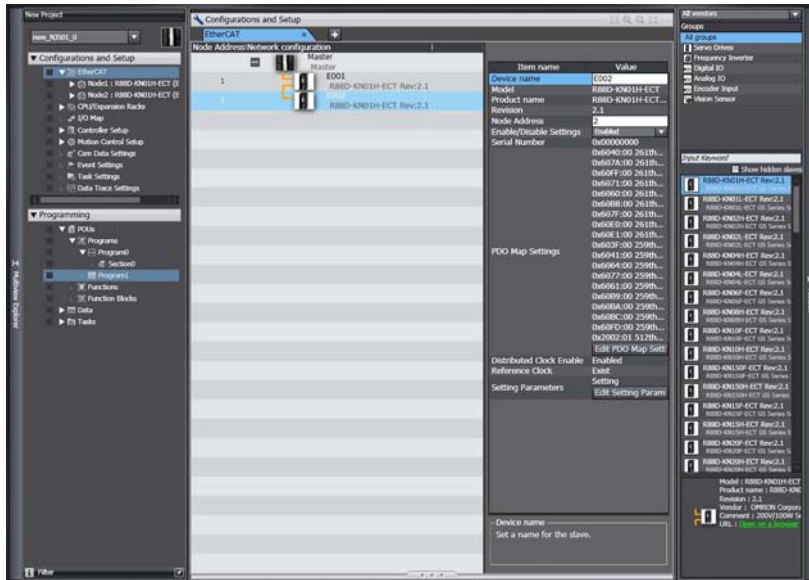

Setting Up the FQ-M

Set up the inspections in the FQ-M, e.g., set the inspection items.

- 1 Double-click the FQ-M that was added to the Edit Network Configuration Tab Page. The FQ-M Setup Pane is displayed for the Edit Pane. Make all of the required settings.



Executing the Simulation

- 1 Write and build the user program that will operate the machine. Refer to the *Sysmac Studio Version 1 Operation Manual* (Cat. No. W504) for details on programming.
- 2 Change to Run Mode Right-click [FQ-MS12x...] in the Edit Network Configuration Tab Page and change to Run Mode.

3 Start the monitor.

Right-click [FQ-MS12x...] in the Edit Network Configuration Tab Page and select [Start monitor].

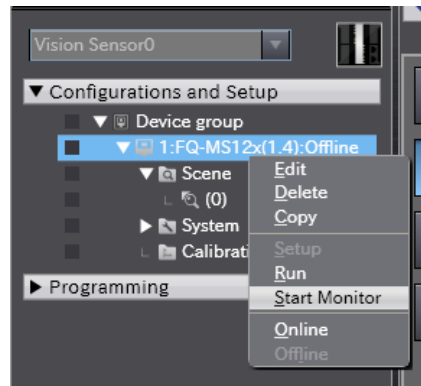

4 Set the FQ-M and then specify the measurement image to use for offline debugging.

Click the image file selection icon and select an image.



5 Select [Simulation] – [Execute].

The simulation will start.

After the Simulator is connected, the NJ-series Controller and FQ-M Simulator will be internally connected online via EtherCAT and the NJ-series Controller will enter RUN mode.

Refer to the *Sysmac Studio Version 1 Operation Manual* (Cat. No. W504) for the operating procedures for the Simulator.

6 When control bits are manipulated from the sequence controls to execute measurements, the measurement results are displayed in the [Monitoring] area so that you can check them.

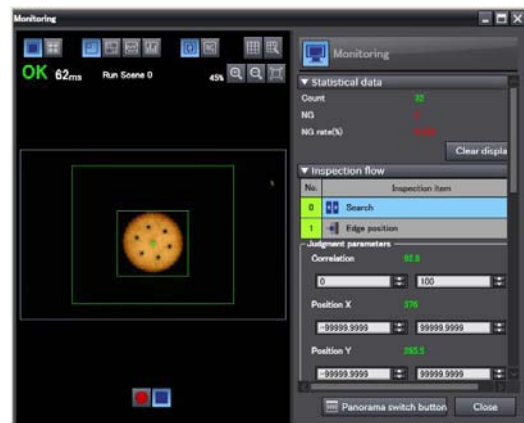

MEMO

Troubleshooting

11-1 Error Histories	382
11-2 Error Messages	390
11-3 Basic Troubleshooting	391

11-1 Error Histories

Error histories are stored with the PC Tool and in the Sensor and in the Touch Finder. Up to 100 errors will be stored in the error history in the Sensor or Touch Finder. The method for checking the error history in the Sensor depends on how the Sensor is connected.



EtherCAT Connection (Sysmac Error Status)

The Sysmac Studio Standard Version displays errors that occur in the EtherCAT system (including Sensor errors) as Sysmac error status.

Sysmac Error Status Table

This section provides a table of Sysmac error status that is related to the Sensor and describes the event codes. Refer to the *NJ-series Troubleshooting Manual* (Cat. No. W503) for details on event codes.

Levels: Maj: Major fault level, Par: Partial fault level, Min: Minor fault level, Obs: Observation, Info: Information

Event code	Event name	Meaning	Assumed cause	Level*1					Reference
				Maj	Prt	Min	Obs	Infor	
78080000 hex 	TRIG Input Error	A TRIG signal was input when the BUSY signal for Sensor measurement was ON.	<ul style="list-style-type: none"> A TRIG signal was input when the BUSY signal for Sensor measurement was ON. Chattering occurred for a contact input. 			✓			p. 385
780A0000 hex 	Scene Data Error	The scene data to switch to is corrupted.	<ul style="list-style-type: none"> The power supply was interrupted when the scene data to switch to was saved. 			✓			p. 385
780B0000 hex 	Model Error	A model was re-registered with an image with low contrast.	<ul style="list-style-type: none"> A model was re-registered with an image with low contrast. 			✓			p. 386
780C0000 hex	Logging Error	Some data was not saved when logging data to files on an SD card.	<ul style="list-style-type: none"> Too much data to log in files occurred in a short period of time, and writing to the SD card could not keep up. 			✓			p. 386
780D0000 hex	Output Timeout	A timeout occurred in data output handshaking control for measurement results.	<ul style="list-style-type: none"> The data output handshaking controls in the program (i.e., the ON/OFF timing of the DSA signal) are not correct. The output control timeout time is too short in comparison with the program processing time. 			✓			p. 387
780E0000 hex	Output Size Error	The data output size setting and the PDO mapping setting do not agree.	<ul style="list-style-type: none"> The EtherCAT data output size setting in the Sensor and the PDO mapping setting in the EtherCAT master do not agree. 			✓			p. 387

Note:  If an error with this mark occurs, the ERROR operation indicator will light and the ERROR signal will turn ON.

*1: Major Fault Level

- These errors prevent control operations for the entire Controller. If a major fault level error is detected, user program execution is stopped immediately and the loads for all slaves (including remote I/O) are turned OFF. You cannot reset major fault level errors from the user program, the Sysmac Studio, or an NS-series PT. To recover from a major fault level error, remove the cause of the error, and either cycle the power supply to the Controller or reset the Controller from the Sysmac Studio.
- Partial Fault Level
These errors prevent control operations in a certain function module in the Controller. The NJ-series CPU Unit continues to execute the user program even after a partial fault level error occurs. After you remove the cause of the error, execute one of the following to return to normal status.
 - Reset the error from the user program, the Sysmac Studio, or an NS-series PT.

- Cycle the power supply to the Controller.
- Reset the Controller from the Sysmac Studio.
- Minor Fault Level
These errors prevent part of the control operations in a certain function module in the Controller. The troubleshooting for minor fault level errors is the same as the processing for partial fault level errors.
- Observations
These errors do not affect the control operations of the Controller. Observations serve as warnings to the user so that the error does not develop into an error at a higher level.
- Information
Events that are classified as information do not indicate errors.

Checking Sysmac Error Status

You can use the troubleshooting functions of the Sysmac Studio Standard Version to check the Sysmac error status. Refer to the *NJ-series Troubleshooting Manual* (Cat. No. W503) for information on troubleshooting functions.

- 1 Select [Troubleshooting] from the Tools Menu while online. You can also click the [Troubleshooting] Button in the toolbar.

The following Troubleshooting Dialog Box is displayed.

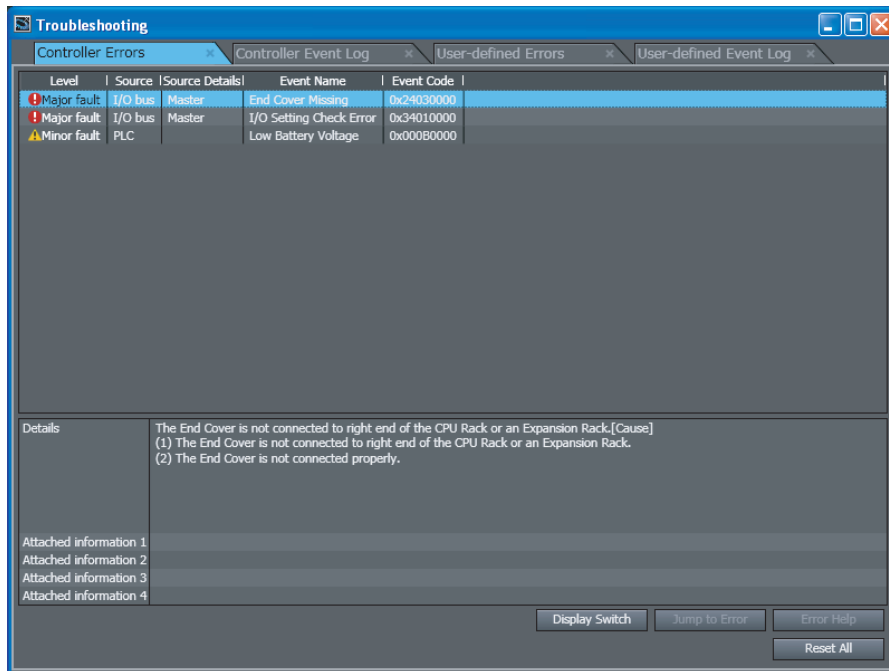

- 2 Click the [Controller Errors] Tab.

A list of the current Sysmac error status and corresponding event codes will be displayed.

Clearing the Sysmac Error Status

Remove the cause of the error and then click the [Reset All] Button on the [Controller Errors] Tab Page of the [Troubleshooting] Pane.

Note

Even if you reset the Sysmac error status, the errors will remain on the [Controller Event Log] Tab Page.

Error Descriptions

The items that are used to describe individual errors (events) are described in the following copy of an error table.

Event name	Gives the name of the error.		Event code	Gives the code of the error.		
Meaning	Gives a short description of the error.					
Source	Gives the source of the error.		Source details	Gives details on the source of the error.	Detection timing	Tells when the error is detected.
Error attributes	Level	Tells the level of influence on control. ^{*1}	Recovery	Gives the recovery method. ^{*2}	Log category	Tells which log the error is saved in. ^{*3}
Effects	User program	Tells what will happen to execution of the user program. ^{*4}	Operation	Provides special information on the operation that results from the error.		
Indicators	This is the status of the indicators for the EtherCAT port that is built into the NJ-series Controller. Indicator status is given only for errors in the EtherCAT Master Function Module and the EtherNet/IP Function Module.					
System-defined variables	Variable		Data type		Name	
	Lists the variable names, data types, and meanings for system-defined variables that provide direct error notification, that are directly affected by the error, or that contain settings that cause the error.					
Cause and correction	Assumed cause		Correction		Prevention	
	Lists the possible causes, corrections, and preventive measures for the error.					
Attached information	This is the attached information that is displayed by the Sysmac Studio or an NS-series PT.					
Precautions/Remarks	Provides precautions, restrictions, and supplemental information.					

*1 One of the following:

Major fault: Major fault level
 Partial fault: Partial fault level
 Minor fault: Minor fault level
 Observation
 Information

*2 One of the following:

Automatic recovery: Normal status is restored automatically when the cause of the error is removed.
 Error reset: Normal status is restored when the error is reset after the cause of the error is removed.
 Cycle the power supply: Normal status is restored when the power supply to the Controller is turned OFF and then back ON after the cause of the error is removed.
 Controller reset: Normal status is restored when the Controller is reset after the cause of the error is removed.
 Depends on cause: The recovery method depends on the cause of the error.

*3 One of the following:

System: System event log
 Access: Access event log

*4 One of the following:

Continues: Execution of the user program will continue.
 Stops: Execution of the user program stops.
 Starts: Execution of the user program starts.

Event name	TRIG Input Error			Event code	78080000 hex	
Meaning	A TRIG signal was input when the BUSY signal for Sensor measurement was ON.					
Source	EtherCAT Master Function Module		Source details	Slave	Detection timing	When TRIG signal turns ON
Error attributes	Level	Minor fault	Recovery	Error reset (after resetting the error in the slave)	Log category	System
Effects	User program	Continues.	Operation	The TRIG signal is disabled and measurements do not start.		
Indicators	EtherCAT NET RUN		EtherCAT NET ERR		EtherCAT LINK/ACT	
	---		---		---	
System-defined variables	Variable		Data type		Name	
	None		---		---	
Cause and correction	Assumed cause		Correction		Prevention	
	A TRIG signal was input when the BUSY signal for Sensor measurement was ON.		Correct the program so that a TRIG signal is not input while the BUSY signal is ON.		Write the program so that a TRIG signal is not input while the BUSY signal for Sensor measurement is ON.	
	Chattering occurred for a contact input.		Use a no-contact output device (e.g., SSR or PLC transistor) instead of a contact output device (e.g., relay).		Use no-contact output devices (e.g., SSR or PLC transistors) to prevent chattering.	
Attached information	None					
Precautions/Remarks	None					

Event name	Scene Data Error			Event code	780A0000 hex	
Meaning	The scene data to switch to is corrupted.					
Source	EtherCAT Master Function Module		Source details	Slave	Detection timing	When the scene is changed
Error attributes	Level	Minor fault	Recovery	Error reset (after resetting the error in the slave)	Log category	System
Effects	User program	Continues.	Operation	The data for the destination scene is initialized and then the scene is switched to. The initialized scene data is used for operation until the data for the destination scene is set.		
Indicators	EtherCAT NET RUN		EtherCAT NET ERR		EtherCAT LINK/ACT	
	---		---		---	
System-defined variables	Variable		Data type		Name	
	None		---		---	
Cause and correction	Assumed cause		Correction		Prevention	
	The power supply was interrupted when the scene data to switch to was saved.		Reset the scene to switch to.		Do not turn OFF the power supply during save processing for the scene data.	
Attached information	None					
Precautions/Remarks	None					

Event name	Model Error		Event code	780B0000 hex		
Meaning	A model was re-registered with an image with low contrast.					
Source	EtherCAT Master Function Module		Source details	Slave	Detection timing	When model re-registration command is executed
Error attributes	Level	Minor fault	Recovery	Error reset (after resetting the error in the slave)	Log category	System
Effects	User program	Continues	Operation	There is no longer a registered model and the Search inspection item will continue to fail until a model is registered again.		
Indicators	EtherCAT NET RUN		EtherCAT NET ERR		EtherCAT LINK/ACT	
	---		---		---	
System-defined variables	Variable		Data type		Name	
	None		---		---	
Cause and correction	Assumed cause		Correction		Prevention	
	A model was re-registered with an image with low contrast.		Re-register the model with an image with high contrast.		Re-register models with images with high contrast.	
Attached information	None					
Precautions/Remarks	None					

Event name	Logging Error		Event code	780C0000 hex		
Meaning	Some data was not saved when logging data to files on an SD card.					
Source	EtherCAT Master Function Module		Source details	Slave	Detection timing	When file logging is executed
Error attributes	Level	Minor fault	Recovery	Error reset (after resetting the error in the slave)	Log category	System
Effects	User program	Continues.	Operation	Logging data with the file logging process will continue to fail until the problem is corrected.		
Indicators	EtherCAT NET RUN		EtherCAT NET ERR		EtherCAT LINK/ACT	
	---		---		---	
System-defined variables	Variable		Data type		Name	
	None		---		---	
Cause and correction	Assumed cause		Correction		Prevention	
	Too much data to log in files occurred in a short period of time, and writing to the SD card could not keep up.		Increase the interval between measurements or change the BUSY output condition to "End of data logging" or "End of image logging."		Set a suitable interval between measurements or set the BUSY output condition to "End of data logging" or "End of image logging."	
Attached information	None					
Precautions/Remarks	If logging fails due to a problem with the SD card (such as insufficient capacity or a lock), a record is stored only in the error history of the Touch Finder.					



Event name	Output Timeout		Event code	780D0000 hex		
Meaning	A timeout occurred in data output handshaking control for measurement results.					
Source	EtherCAT Master Function Module		Source details	Slave	Detection timing	At measurement result output
Error attributes	Level	Minor fault	Recovery	Error reset (after resetting the error in the slave)	Log category	System
Effects	User program	Continues	Operation	Data is not output to the EtherCAT master and it is stored in the Sensor. When the DSA signal turns ON, the stored data is output to the EtherCAT master.		
Indicators	EtherCAT NET RUN		EtherCAT NET ERR		EtherCAT LINK/ACT	
	---		---		---	
System-defined variables	Variable		Data type		Name	
	None		---		---	
Cause and correction	Assumed cause		Correction		Prevention	
	The data output handshaking controls in the program (i.e., the ON/OFF timing of the DSA signal) are not correct.		Correct the data output handshaking controls in the program (i.e., the ON/OFF timing of the DSA signal).		Create the data output handshaking controls in the program (i.e., the ON/OFF timing of the DSA signal).	
	The output control timeout time is too short in comparison with the program processing time.		Correct the timeout time so that it is suitable for the program processing time.		Set the timeout time so that it is suitable for the program processing time.	
Attached information	None					
Precautions/Remarks	None					

Event name	Output Size Error		Event code	780E0000 hex		
Meaning	The data output size setting and the PDO mapping setting do not agree.					
Source	EtherCAT Master Function Module		Source details	Slave	Detection timing	At measurement result output
Error attributes	Level	Minor fault	Recovery	Error reset (after resetting the error in the slave)	Log category	System
Effects	User program	Continues.	Operation	The data is not output to the EtherCAT master.		
Indicators	EtherCAT NET RUN		EtherCAT NET ERR		EtherCAT LINK/ACT	
	---		---		---	
System-defined variables	Variable		Data type		Name	
	None		---		---	
Cause and correction	Assumed cause		Correction		Prevention	
	The EtherCAT data output size setting in the Sensor and the PDO mapping setting in the EtherCAT master do not agree.		Correct either the data output size setting or the PDO mapping setting.		Set the EtherCAT data output size setting in the Sensor and the PDO mapping setting in the EtherCAT master so that they agree.	
Attached information	None					
Precautions/Remarks	None					

Errors for Ethernet (No-protocol or PLC Link) Connections

The following table lists the Sensor errors that are saved in the Sensor or Touch Finder.



Errors Stored in the Error History

Error in error history	Cause	Points to check	Measures to perform
TRIG Input Error  (Error code: 01040302)	A TRIG signal was input when the BUSY signal for Sensor measurement was ON.	<ul style="list-style-type: none"> Check the program in the PLC or other host to see if an interlock or similar measure has been implemented. If a relay or other device with contacts is being used as the input device, see if chattering has occurred. 	<ul style="list-style-type: none"> Program interlocks to control the TRIG so that they do not turn ON while the BUSY signal is ON. Switch from a device with contacts (e.g., relay) to a device without contacts (e.g., SSR or PLC transistor output).
IN Input Error  (Error code: 11020900)	A no-protocol command or PLC link command was input when the BUSY signal was ON.	<ul style="list-style-type: none"> Is an interlock or other counter-measure provided, e.g., in a ladder program in the PLC? 	<ul style="list-style-type: none"> Program interlocks, such as in a ladder program, so that no-protocol commands and PLC link commands are not input while the BUSY signal is ON.
Scene Data Error (Error code: 01030800)	The scene data to switch to is corrupted.	---	The scene data to be switched to is corrupted. Reset the scene data from the beginning.
Model Error  (Error code: 01050405, 01050500)	A model was re-registered with an image with low contrast.	Check the image to see if the contrast is too low to register the model.	Increase the image contrast and try again to register the model.
Logging Error (Error code: 02160702, 02160703)	Some data was not saved when logging data to files on an SD card.	Check to see if the BUSY output parameter is set to <i>Measurement</i> .	Too much data to log in files occurred in a short period of time, and writing to the SD card could not keep up.
Output Timeout (Error code: 11090101)	A timeout occurred in data output handshaking control for measurement results.	<ul style="list-style-type: none"> The data output handshaking controls in the program (i.e., the ON/OFF timing of the DSA signal) are not correct. The output control timeout time is too short in comparison with the program processing time. 	<ul style="list-style-type: none"> Correct the data output handshaking controls in the program (i.e., the ON/OFF timing of the DSA signal). Correct the timeout time so that it is suitable for the program processing time.
Output Size Error (Error code: 11090803)	The data output size setting and the PDO mapping setting do not agree.	The EtherCAT data output size setting in the Sensor and the PDO mapping setting in the EtherCAT master do not agree.	Correct either the data output size setting or the PDO mapping setting.

Note:  If an error that is indicated by this icon occurs, the ERROR operation indicator will light and the ERROR signal will turn ON.

Note

You cannot check the error codes from the Touch Finder. Use the command to acquire the most recent error information for the connection method.

- EtherCAT  p. 254
- PLC Link  p. 287
- No-protocol Communications  p. 318

Checking the Error Histories

Using the PC Tool

- ▶ **Multiview Explorer: [Device Group] – Sensor name (Double-click)**
→ **Edit Pane: [Error history]**

Using the Touch Finder

On the Touch Finder, you can check the history of errors detected by the Sensor and those detected by the Touch Finder.

- **Checking the History of Errors That Have Occurred in the Sensor**

- ▶  **(Setup Mode) – [Sensor settings] – [Error history] – [View history]**

Errors will be displayed in order with the most recent ones on top.

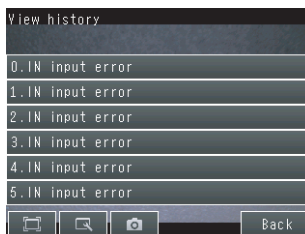

- **Checking the Log of Errors That Have Occurred in the Touch Finder**

- ▶  **(Setup Mode or Run Mode) – [TF settings] – [Error history] – [View history]**

Clearing the Error Histories

Using the PC Tool

- ▶ **Multiview Explorer: [Device Group] – Sensor name (Double-click)**
→ **Edit Pane: [Error history] – [Clear]**

Using the Touch Finder

On the Touch Finder, you can clear the history of errors detected by the Sensor and those detected by the Touch Finder.

- **Deleting the History of Errors That Were Detected in the Sensor**

- ▶  **(Setup Mode) – [Sensor settings] – [Error history] – [Delete history]**

- **Deleting the History of Errors That Were Detected in the Touch Finder**

- ▶  **(Setup Mode or Run Mode) – [TF settings] – [Error history] – [Delete history]**

11-2 Error Messages

If an error occurs while making settings on the Touch Finder, an error message will appear on the display. For these errors, the ERR indicator on the Sensor will not light, the ERROR signal will not be output, and the error will not be recorded in the error history.

Follow the instructions that are given in the error message.

If the following messages appear, the hardware may be faulty.

Contact your OMRON representative.

- System error.
- Application system error. Please reboot.
- Failed to startup.

11-3 Basic Troubleshooting

Problem	Measures to perform	Reference
The Sensor or Touch Finder will not start.	Check the power supply capacity to see if it is sufficient.	---
The Sensor cannot be detected.	Check the Ethernet cable to see if it is connected correctly.	---
	Check the Ethernet settings to see if they are correct between the devices.	p. 270, p. 297, p. 326
	Check if there are any Sensors that were not detected by the Sensor connection check.	---
	Check the communications cable to see if it is disconnected.	---
	Check the switching hubs to see if any of them are faulty. (If switching hubs are used.)	---
	The PC Tool and Touch Finder cannot be connected at the same time. If the PC Tool or Touch Finder is already connected to the Sensor, disconnect it.	---
The results display is not updated.	Check to see if the TRIG signal is being correctly input to the Sensor.	p. 225
	Check to see if the most recent NG result is being displayed.	p. 187
Updating the results display is slow.	If other devices are connected to the same network as the Sensor, disconnect the other devices from the network and check the update speed. If the update speed returns to normal, check the specifications of the disconnected devices and take suitable measures.	---
	If there are power lines running in parallel with the Ethernet cable or if there are inverters or other sources of noise near the communications cable, separate the communications cable from them and check the update speed. Noise may be adversely affecting the communications response.	---
Data is not logged properly.	Check to see if the logging setting in the Sensor are correct.	p. 191
	If logging to an SD card is not possible, check the available space on the SD card and check to see if the SD card is write-protected.	p. 206
The ERROR indicator lights.	Check the error history to see what error has occurred and take suitable measures.	p. 382
EtherCAT communications are not possible.	Check to see if the node address setting switches are set correctly. Check to see if the IN and OUT EtherCAT connectors are connected correctly.	---
Encoder pulses cannot be detected.	Check to see if the encoder is wired correctly. Check to see if the encoder input parameters are set correctly.	---
The measurement trigger is not input.	Check to see if the measurement trigger is set correctly.	---

MEMO

Appendices

12-1 Function List	394
12-2 External Reference Parameters	412
12-3 Specifications and Dimensions	428
12-4 Upgrading Sensor and Touch Finder Firmware	445
12-5 Object Dictionary	446

12-1 Function List

Command		Description	Setting range	Data	Reference	
Project	New Project	Project name	Sets the name of the project data.	---	Project	p. 49
		Author	Sets the project author.	---	Project	
		Comment	Sets a comment for the project data.	---	Project	
		Category	Sets the category for the Unit to add to the project.	---	Project	
		Device	Sets the model name of the Unit that was selected with the category setting.	---	Project	
		Create	Creates the project data.	---	---	
	Open Project	Delete	Deletes the project data.	---	---	---
		Open	Opens project data.	---	---	p. 49
	Import	Import	Imports project data for management.	---	---	---
	Export	Export	Exports project data.	---	---	---
	License	License	Used to input the license number of the Sysmac Studio Standard Edition or Sysmac Studio Vision Edition (SYSMAC-VE001L).	---	---	---
Add sensors	Enter the type.	Inserts the specified Sensor into the project in Offline Mode.	---	---	p. 49, p. 373	
	Search for sensors	Automatically searches for Sensors on the network and inserts them into the project.	---	---		
	Specify the IP address.	Used to specify the IP address of a Sensor to connect to that Sensor online and insert it into the project.	a.b.c.d a: 1 to 223 b: 0 to 255 c: 0 to 255 d: 1 to 254	Scene		
Menu bar	File	Save	Saves the project.	---	---	p. 59
		Close	Closes the project.	---	---	---
		Import	Saves the project as an external file.	---	---	p. 60
		Export	Imports an exported file so that it can be edited on the PC Tool.	---	---	p. 59
		Print	Prints settings data.	---	---	p. 205
		Print settings	Used to set printer attributes (e.g., margins).	---	---	---
		Exit	Closes the PC Tool.	---	---	---

Command		Description	Setting range	Data	Reference	
Menu bar	Edit	Copy	Copies the selected item (scene data, system data, or calibration data).	---	---	p. 54, p. 182
		Paste	Pastes the copied item.	---	---	p. 54
		Delete	Deletes the selected item (scene data or calibration data).	---	---	p. 54, p. 182
	Help	Help contents	Displays help.	---	---	p. 211
		Version	Displays version information about the PC Tool.	---	---	p. 211
Toolbar		Copy	Copies the selected item (scene data, system data, or calibration data).	---	---	p. 54, p. 182
		Paste	Pastes the copied item.	---	---	p. 54
		Delete	Deletes the selected item (scene data or calibration data).	---	---	p. 54, p. 182
Toolbox		Search	Registers a Search inspection item.	---	---	p. 86, p. 88
		Shape Search	Registers a Shape Search inspection item.	---	---	p. 86, p. 125
		Labeling	Registers a Labeling inspection item.	---	---	p. 86, p. 113
		Edge Position	Registers an Edge Position inspection item.	---	---	p. 86, p. 105
Explorer Pane	Device group	Add FQ-M	Inserts a Sensor into the project.	---	---	p. 54, p. 65
		Paste	Pastes a copied Sensor into the project.	---	---	
	Sensor model	Edit	Displays the Main Pane for the Edit Pane.	---	---	p. 54, p. 55
		Delete	Deletes the Sensor from the project.	---	---	p. 54
		Copy	Copies the Sensor.	---	---	
		Setup	When online, changes the Sensor to Setup Mode.	---	---	p. 23, p. 54
		Run	When online, changes the Sensor to Run Mode.	---	---	p. 23, p. 54, p. 164
		Start monitor	Opens the Monitor Pane.	---	---	p. 54, p. 150, p. 168, p. 378
		Online	Makes an online connection to the Sensor.	---	---	p. 54, p. 65, p. 66, p. 374
		Offline	Disconnects the online Sensor and places the PC Tool offline.	---	---	p. 54, p. 65, p. 374

Command			Description	Setting range	Data	Reference	
Explorer Pane	Scene group	Add Scene data	Adds new scene data to the scene group.	---	---	p. 54, p. 203	
		Paste	Adds the copied scene data to the scene group.	---	---		
	Scene data	Edit	Displays the Scene Data Edit Pane for the Edit Pane.	---	Scene	p. 54, p. 55, p. 56, p. 203	
		Copy	Copies the scene data.	---	Scene		
		Delete	Deletes the scene data.	---	Scene		
		Rename	Renames the scene.	15 characters max.	Scene		p. 182
	System data	Edit	Displays the System Data Edit Pane for the Edit Pane.	---	System	p. 54, p. 55, p. 56, p. 203	
		Copy	Copies the system data.	---	System		
		Paste	Overwrites the system data.	---	System		
	Calibration group	Add Calibration data	Adds new calibration data to the calibration group.	---	---	p. 54, p. 55, p. 203	
		Paste	Adds the copied calibration data to the calibration group.	---	---		
	Calibration data	Edit	Displays the Calibration Data Edit Pane for the Edit Pane.	---	Calibration	p. 54, p. 55, p. 203	
		Copy	Copies the calibration data.	---	Calibration		
		Delete	Deletes calibration data.	---	Calibration		
Rename		Changes the name of the calibration data.	15 characters max.	Calibration	p. 182		
Main Pane	General settings	Sensor Information	Name	Renames the Sensor.	15 characters max.	Scene	p. 210
			Model	Displays model information on the Sensor.	---	Scene	p. 210
			Version	Displays version information on the Sensor.	---	Scene	p. 210
	Online	Sensor connection	Connection/Disconnect	Changes the connection status (online or offline) of the Sensor.	---	---	p. 374
			Communication settings	Sets the conditions for communications with the Sensor.	---	---	p. 273
		Switch the sensor mode.	Run mode/Setting mode	Changes the Sensor mode (Run or Setup Mode).	---		p. 66
		Data transfer and collation and preservation	Transfer [Sensor → PC]	Transfers project data from an online Sensor to the computer.	---		p. 201
			Transfer [PC → Sensor]	Transfers the project data to the online Sensor.	---		---
			Save data	Saves all Sensor data to the Sensor's flash memory.	---		p. 161
		Monitor	Start monitor	Opens the Monitoring Pane used to monitor measurement results.	---		p. 168
		Error history	Update	Displays the error history of an online Sensor.	---		p. 383
			Delete	Clears the error history of an online Sensor.	---		p. 383

Command		Description		Setting range	Data	Reference			
Main Pane	Support software	Sensor setup	Restart	Restarts an online Sensor.	---		p. 211		
			Initialize	Initializes an online Sensor.	---		p. 211		
			Update firmware	Updates the firmware of an online Sensor.	---		p. 445		
		Sensor data	Read	Imports external file data (scene data, system data, calibration data, or all Sensor data) as data that can be read by the Touch Finder.	---	---		p. 205	
			Save	Exports project data (scene data, system data, calibration data, and all Sensor data) to an external file as data that can be read by the Touch Finder.	---	---		p. 204	
		Print	Sensor parameter	Prints out the Sensor scene and system data.	---	---		p. 205	
			The mark for calibration	Prints out a calibration pattern that is used to perform conveyor tracking calibration.	---			p. 70	
		Help	Help display	Displays help.	---			p. 211	
		Edit scene	Image	Brightness adjust	Brightness adjustment	Changes the brightness adjustment mode (Normal or HDR Mode).	Normal Mode (default) or HDR Mode	Scene	p. 76
					Shutter speed	Sets the shutter speed for Normal Mode.	1/10 to 1/30,000 s (default: 1/1,000)	Scene	p. 74, p. 75
Brightness	Sets the brightness level of the image for HDR Mode.				1 to 100	Scene	p. 74, p. 75		
HDR Level	Sets the HDR level to one of four levels for HDR Mode.				OFF, HDR:1, HDR:2, HDR:3, HDR:4	Scene	p. 76		
White balance	R			Corrects the RGB ratio when the coloring of an image is not correct.	0.001 to 7.999	Scene	p. 78		
	G				0.001 to 7.999	Scene			
	B				0.001 to 7.999	Scene			
Partial input	Start point, End point			Narrows the image input range.	752 × 8 to 752 × 480	Scene	p. 159		
Lighting control	Strobe output delay			Sets the delay time for the strobe output signal (STGOUT) in response to the trigger signal.	0 to 65,535 ms (default: 0 ms)	Scene	p. 227		
	Strobe output time			Sets the output time of the strobe output signal (STGOUT).	0 to 65,535 ms (default: 1,000 ms)	Scene	p. 226		
	Strobe output polarity			Sets the output polarity of the strobe output signal (STGOUT).	Positive (default) or Negative	Scene	p. 225		
Strobe controller settings	Used channel			Sets the channel to use when connected to a Strobe Controller.	CH0 to CH7 (default), CH0 to CH3, or CH4 to CH7	Scene	---		
	Light mode			Sets the lighting mode to use when connected to a Strobe Controller.	Off, Trigger Sync (default)	Scene	p. 73		
	Adjust light intensity 0 to 7			Sets the light intensity for each channel when connected to a Strobe Controller.	1 to 400 (default: 1)	Scene	p. 73		
Calibration	Calibration pattern			Sets a registered calibration pattern.	Unregistered (default), New Calibration, or Calibration Data 0 to 3	Scene	p. 348		

Command				Description	Setting range	Data	Reference		
Edit scene	Search	Model region	Edit	Add	Used to specify the shape of the model region to register as the model from a combination of shapes.	Rectangle, Ellipse, Wide circle, or Polygon	Scene	p. 99	
				Delete		---	Scene	p. 100	
				Copy		---	Scene	---	
				OR/NOT		OR (default) or NOT	Scene	p. 101	
				One/All		One (default) or All	Scene	---	
			Parameter	Rotation	Sets the angle range for the registered model.	OFF (default) or ON	Scene	p. 98	
				Rotation range		-180 to 180	Scene	p. 98	
			Measurement region		Edit Measurement region	Moves the measurement region or adjusts the size of the measurement region.	---	Scene	p. 91
			Detection Point		Detection point X	Sets the coordinate to output. Sets the offset for the registered model region.	-99,999.9999 to 99,999.9999 (Default: Center of the model)	Scene	p. 91
					Detection point Y			Scene	
		Measurement condition	Extraction condition	Sub-pixel	Sub-pixel	Changes to a mode that can calculate the measurement position output with floating point precision.	OFF (default) or ON	Scene	p. 92
					Candidate level	Sets the detection target to only objects with a correlation above the specified candidate level.	0 to 100 (default: 60)	Scene	p. 94
					Position X	Sets the detection target to only objects with a position in the specified range.	-99,999.9999 to 99,999.9999 (Defaults: Lower limit: -99,999.9999, Upper limit: 99,999.9999)	Scene	p. 94
					Position Y			-99,999.9999 to 99,999.9999 (Defaults: Lower limit: -99,999.9999, Upper limit: 99,999.9999)	
					Measure angle	-180 to 180 (Defaults: Lower limit: -180, Upper limit: 180)	Scene		
				Multi-point output	Multi-point output	Sets whether to output only the result with the highest correlation, or to output all results that meet the specified extraction conditions.	OFF (default) or ON	Scene	p. 93
					Sorting method	Sets the sort condition to use when multiple measurement results meet the extraction conditions.	Ascending order of correlation value, descending order of correlation value (default), ascending order of position X, descending order of position X, ascending order of position Y, or descending order of position Y	Scene	
					Count	Sets the maximum number of data for external output from the sorted results.	1 to 32 (default: 32)	Scene	
				Remove duplication	Remove duplication	Enables deleting results that are repeated from the previous measurement when an encoder input is used to perform conveyor tracking calibration.	OFF (default) or ON	Scene	p. 95
					Judgement distance	Sets the judgement distance information to use when repetition judgement is performed.	0 to 1,000 (default: 0)	Scene	

Command				Description	Setting range	Data	Reference					
Edit scene	Search	Measurement condition	Grip interference check	Sets whether or not to execute the [Grip interference check].	OFF (default) or ON	Scene	p. 96					
			Grip area level	Sets the threshold for executing the grip interference check.	0 to 100 (default: 80)	Scene	p. 97					
		Judgment parameters	Detection No.	If you enabled the output of multiple results, you can specify the results to display.	---	Scene	p. 90					
			Correlation	Sets the correlation OK range.	0 to 100 (Defaults: Lower limit: 0, Upper limit: 100)	Scene						
		Judgement conditions	Position X	Sets the position OK range.		-99,999.9999 to 99,999.9999 (Defaults: Lower limit: -99,999.9999, Upper limit: 99,999.9999)	Scene	p. 94				
			Position Y				Scene					
			Angle				Scene					
			Count				Scene		p. 93			
		Set color	Color extraction range 0 to 3	Color extraction range 0 to 3	Specifies the colors to extract with the grip interference check function. You can specify up to four colors. These parameters can only be set when there is a color camera connected.	OFF or ON (default)	Scene	p. 117				
							Hue 0 to 3 (H)		0 to 359	Scene		
							Saturation 0 to 3 (S)		0 to 255	Scene		
							Brightness 0 to 3 (V)		0 to 255	Scene		
	Exclude 0 to 3						OFF (default) or ON		Scene			
	Reverse						OFF (default) or ON		Scene			
	Binary	Binary level	Binary level	Specifies the brightness range to extract with the grip interference check function. These parameters can only be set when there is monochrome camera connected.	0 to 255 (Defaults: Lower limit: 128, Upper limit: 255)	Scene	p. 114					
						Reverse		OFF (default) or ON	Scene	p. 117		
	Grip region	Insp. region	Insp. region	Moves the grip region or adjusts the size of the grip region.	---	Scene	p. 97					
						Display setting		Extraction image type	Allows you to change how the extraction color is displayed.	All color image or binary image	Scene	p. 117
								Select the background color	Allows you to change how colors other than the extraction color are displayed.	Black, White, Red, Green, or Blue	Scene	
						Shape Search		Model region	Edit	Add	Used to specify the shape of the model region to register as the model from a combination of shapes.	Rectangle, Ellipse, Wide circle, or Polygon
Delete	---	Scene										
Copy	---	Scene										
OR/NOT	OR (default) or NOT	Scene										
One/All	One (default) or All	Scene										
Parameter	Rotation	Rotation	Sets the angle range for the registered model.	OFF (default) or ON	Scene		p. 134					
		Rotation range	-180 to 180	Scene								

Command		Description		Setting range	Data	Reference	
Edit scene	Shape Search	Measurement region	Insp. region	Moves the measurement region or adjusts the size of the measurement region.	---	Scene	p. 135
		Detection point	Detection coordinate X	Sets the coordinate to output. Sets the offset for the registered model region.	-99,999.9999 to 99,999.9999 Center of the model (default)	Scene	p. 128
	Detection coordinate Y		-99,999.9999 to 99,999.9999 Center of the model (default)		Scene		
	Measurement condition	Extraction condition	Candidate level	Sets the detection target to only objects with a correlation above the specified candidate level.	0 to 100 (default: 60)	Scene	p. 130
			Position X	Sets the detection target to only objects with a position in the specified range.	-99,999.9999 to 99,999.9999 (Defaults: Lower limit: -99,999.9999, Upper limit: 99,999.9999)	Scene	
			Position Y		-99,999.9999 to 99,999.9999 (Defaults: Lower limit: -99,999.9999, Upper limit: 99,999.9999)	Scene	
	Multi-point output	Sorting method		Sets the sort condition to use when multiple measurement results meet the extraction conditions.	Ascending order of correlation value, descending order of correlation value (default), ascending order of position X, descending order of position X, ascending order of position Y, or descending order of position Y	Scene	p. 129
			Count	Sets the maximum number of data for external output from the sorted results.	1 to 32 (default: 32)	Scene	
	Remove duplication	Remove duplication		Enables deleting results that are repeated from the previous measurement when an encoder input is used to perform conveyor tracking calibration.	OFF (default) or ON	Scene	p. 131
			Judgement distance	Sets the judgement distance information to use when repetition judgement is performed.	0 to 1,000 (default: 0)	Scene	
	Grip interference check	Grip interference check	Grip interference check	Sets whether or not to execute the [Grip interference check].	OFF (default) or ON	Scene	p. 132
			Grip area level	Sets the threshold for executing the grip interference check.	0 to 100 (default: 80)	Scene	p. 133
	Judgment parameters	Detection No.		If you enabled the output of multiple results, you can specify the results to display.	---	Scene	p. 127
			Correlation	Sets the correlation OK range.	0 to 100 (Defaults: Lower limit: 0, Upper limit: 100)	Scene	
			Position X	Sets the position OK range.	(Defaults: Lower limit: -99,999.9999, Upper limit: 99,999.9999)	Scene	
			Position Y		(Defaults: Lower limit: -99,999.9999, Upper limit: 99,999.9999)	Scene	

Command		Description		Setting range	Data	Reference		
Edit scene	Shape Search	Judgment parameters	Angle	Sets the angle OK range.	-180 to 180 (Defaults: Lower limit: -180, Upper limit: 180)	Scene	p. 127	
			Count	Sets the count OK range.	0 to 32 (default: 0)	Scene	p. 129	
		Set color	Color extraction range 0 to 3	Specifies the colors to extract with the grip interference check function. You can specify up to four colors. These parameters can only be set when there is a color camera connected.	OFF or ON (default)	Scene	p. 117	
			Hue 0 to 3 (H)		0 to 359	Scene		
			Saturation 0 to 3 (S)		0 to 255	Scene		
			Brightness 0 to 3 (V)		0 to 255	Scene		
			Exclude 0 to 3		Sets which of the specified colors not to extract.	OFF (default) or ON		Scene
			Reverse		Allows you to inversely specify the color extraction range. This setting applies to all four colors.	OFF (default) or ON		Scene
		Binary	Binary level	Specifies the brightness range to extract with the grip interference check function. These parameters can only be set when there is monochrome camera connected.	0 to 255 (Defaults: Lower limit: 128, Upper limit: 255)	Scene	p. 114	
			Reverse		OFF (default) or ON	Scene	p. 117	
		Grip region	Insp. region	Moves the grip region or adjusts the size of the grip region.	---	Scene	p. 133	
		Display setting	Extraction image type	Allows you to change how the extraction color is displayed.	All color image or binary image	Scene	p. 117	
			Select the background color	Allows you to change how colors other than the extraction color are displayed.	Black, White, Red, Green, or Blue	Scene		
		Edge position	Measurement region	Measurement region	Moves the measurement region or adjusts the size of the measurement region.	---	Scene	p. 111
			Set edge color	Set edge color	Specifies the detection color to use to find the edge position. These parameters can be set only when a color camera is connected.	OFF (default) or ON	Scene	p. 110
				R		0 to 255	Scene	
				G		0 to 255	Scene	
B	0 to 255			Scene				
Density change	Sets the detection direction (Color IN or Color OUT) for the edge to detect.		Color IN (default) or Color OUT	Scene				
Judgment parameters	Edge threshold		Sets the color density change level of the edge.	0 to 100 (default: 50)	Scene	p. 107		
	Noise threshold		Sets the color density change level to treat as noise.	0 to 422 (default: 10)	Scene	p. 108		
	Density change		Sets the detection direction (Dark -> Light or Light -> Dark) for the edge to detect. These parameters can be set only when a monochrome camera is connected.	Light -> Dark (default) or Dark -> Light	Scene	p. 111		
	Measurement methods		Sets the edge measurement method. Displayed only when a monochrome camera is connected.	0: Projection method or 1: Differentiation method	Scene			

Command				Description	Setting range	Data	Reference	
Edit scene	Edge position	Judgement conditions	Position X	Sets the position OK range.	-99,999.9999 to 99,999.9999 (Defaults: Lower limit: -99,999.9999, Upper limit: 99,999.9999)	Scene	p. 107	
			Position Y		-99,999.9999 to 99,999.9999 (Defaults: Lower limit: -99,999.9999, Upper limit: 99,999.9999)	Scene		
Labeling	Set color		Color extraction range 0 to 3	Sets the colors to extract as labels. You can specify up to four colors. These parameters can be set only when a color camera is connected.	OFF or ON (default)	Scene	p. 117	
			Hue 0 to 3 (H)		0 to 359	Scene		
			Saturation 0 to 3 (S)		0 to 255	Scene		
			Brightness 0 to 3 (V)		0 to 255	Scene		
			Exclude 0 to 3		Sets which of the specified colors not to extract.	OFF (default) or ON		Scene
			Reverse		Allows you to inversely specify the color extraction range. This setting applies to all four colors.	OFF (default) or ON		Scene
	Binary		Binary level	Specifies the brightness range to extract as labels. These parameters can be set only when a monochrome camera is connected.	0 to 255 (Defaults: Lower limit: 128, Upper limit: 255)	Scene	p. 114	
			Reverse		OFF (default) or ON	Scene	p. 117	
	Measurement region	Edit	Add	Used to specify the measurement region as a combination of shapes.	Rectangle, Ellipse, Wide circle, or Polygon	Scene	p. 122	
			Delete		---	Scene		
			Copy		---	Scene		
			OR/NOT		OR (default) or NOT	Scene		
			One/All		One (default) or All	Scene		
Measurement conditions	Labeling condition	Filling up holes	Enables filling holes.	OFF (default) or ON	Scene	p. 118		
		Outside trimming	Enables cutting out images.	OFF (default) or ON	Scene			
		Sorting method	Sets the sort condition to use for extracted labels.	Ascending order of area, descending order of area (default), ascending order of gravity X, descending order of gravity X, ascending order of gravity Y, or descending order of gravity Y	Scene	p. 120		
		Count	Sets the maximum number of labels to detect.	1 to 100	Scene			

Command				Description	Setting range	Data	Reference	
Edit scene	Labeling	Measurement conditions	Extraction condition	Sets the area range to extract as a label.	0.0000 to 99,999.9999 (Defaults: Lower limit: 0, Upper limit: 99,999.9999)	Scene	p. 119	
			Gravity X	Sets the position range from which to extract labels.	-99,999.9999 to 99,999.9999 (Defaults: Lower limit: -99,999.9999, Upper limit: 99,999.9999)	Scene		
			Gravity Y		-99,999.9999 to 99,999.9999 (Defaults: Lower limit: -99,999.9999, Upper limit: 99,999.9999)	Scene		
		Removal duplication	Removal duplication	Enables deleting results that are repeated from the previous measurement when an encoder input is used to perform conveyor tracking calibration.	OFF (default) or ON	Scene	p. 121	
			Judgement distance	Sets the judgement distance information to use when repetition judgement is performed.	0 to 1,000 (default: 0)	Scene		
		Judgment parameters		Number of labels	Sets the OK range for the number of labels.	0 to 100 (Defaults: Lower limit: 0, Upper limit: 100)	Scene	p. 116
				Total label area	Sets the label total area OK range.	0.0000 to 999,999,999.9999 (Defaults: Lower limit: 0, Upper limit: 999,999,999.9999)	Scene	
	Area			Sets the area OK range.	0.0000 to 999,999,999.9999 (Defaults: Lower limit: 0, Upper limit: 999,999,999.9999)	Scene		
	Gravity center X			Sets the position OK range.	-99,999.9999 to 99,999.9999 (Defaults: Lower limit: -99,999.9999, Upper limit: 99,999.9999)	Scene		
	Gravity center Y				-99,999.9999 to 99,999.9999 (Defaults: Lower limit: -99,999.9999, Upper limit: 99,999.9999)	Scene		
	Elliptic major angle			Sets the elliptic major angle OK range.	-180 to 180 (Defaults: Lower limit: -180, Upper limit: 180)	Scene		
	Display setting		Extraction image type	Allows you to change how the extraction color is displayed.	All color image or binary image	Scene	p. 117	
			Select the background color	Allows you to change how colors other than the extraction color are displayed.	Black, White, Red, Green, or Blue	Scene		

Command		Description		Setting range	Data	Reference	
Edit scene	Calculation	Calculations 0 to 31	Name	Sets the name of the expression.	15 characters max.	Scene	p. 140
			Expression	Used to set the expression. Expression symbols: () / * - , + T J G Functions: SIN, COS, ATAN, AND, OR, NOT, ABS, MAX, MIN, MOD, SQRT, ANGL, DIST, and ECNT	---	Scene	
			Judgment parameters	Sets the judgement conditions for calculation results.	-999,999,999.9999 to 999,999,999.9999 (Defaults: Lower limit: -999,999,999.9999, Upper limit: 999,999,999.999)	Scene	p. 145
Output scene	No-protocol data output	Output format for ASCII	Data type	Sets the data format to ASCII or binary.	ASCII (default) or Binary	Scene	p. 303
			Digits of integer	Sets the number of digits in the integer part of the number, including the sign. For integers, the plus sign is not output. Example: When four digits is set, "-5963" is output as "-.999".	1 to 10 (default: 6)	Scene	
			Digits of decimal	Sets the number of digits to output after the decimal. If the number of digits is set to 0, the decimal part is rounded off before the value is output.	0 to 4 (default: 4)	Scene	
			Negative	Sets what to output for the sign when a number is negative.	- (default) or 8	Scene	
			0 Suppressed	Sets how to format numbers in the output data when the left digits are blank. Yes: Inserts zeros for any blank digits. No: Inserts spaces for any blank digits. Example: Digits of integer setting: 5 digits Digits of decimal setting: 3 digits If the data is 100.000: ON: 00100.000 OFF: __100.000 ("_" represents a space.)	ON or OFF (default)	Scene	p. 303
			Field separator	Sets the delimiter between individual output data.	OFF (default), comma, tab, space, CR, LF, CR+LF, or Semicolon	Scene	
			Record separator	Sets the delimiter between sets of output data.	OFF (default), comma, tab, space, CR, LF, CR+LF, Semicolon	Scene	
Output format for binary	Output format	Sets the decimal output form when the output format is set to binary. For fixed point data, the data is output as its original value multiplied by 1,000.	Floating point or Fixed point (default)	Scene			

Command			Description		Setting range	Data	Reference			
Edit scene	Output	No-protocol data output	Outputs 0 to 31	Name	Sets the name of the output data.	15 characters max.	Scene	p. 302		
				Expression	Used to set the output data. You can output multiple pieces of data as a group with the LPR and LPC functions. Example: The following example outputs the measurement results as two groups of data: Correlation of Item 0: IO.CR[0], IO.CR[1] Position X of Item 0: IO.X[0], IO.X[1] Position Y of Item 0: IO.Y[0], IO.Y[1] The data is output as follows for LPR(0, 3, IO.CR, IO.X, IO.Y): IO.CR[0], IO.X[0], IO.Y[0], IO.CR[1], IO.X[1], IO.Y[1] The data is output as follows for LPC(0, 3, IO.CR, IO.X, IO.Y): IO.CR[0], IO.CR[1], IO.X[0], IO.X[1], IO.Y[0], IO.Y[1]	---	Scene			
		Programmable no-protocol data output	Output format	Field separator	Sets the delimiter between individual output data.	None (default), comma, tab, space, CR, LF, CR+LF, or Semicolon	Scene	p. 333		
				Record separator	Sets the delimiter between sets of output data.	None (default), comma, tab, space, CR, LF, CR+LF, or Semicolon	Scene			
			Outputs 0 to 31	Name	Sets the name of the output data.	15 characters max.	Scene	p. 333		
				Expression	Used to set the output data. You can use F, D, and C tags to flexibly output results, including text.	---	Scene			
		Ether-CAT/PLC link data output	Output format	Output format	Sets the decimal output form. For fixed point data, the data is output as its original value multiplied by 1,000.	Floating point or Fixed point (default)	Scene	p. 276		
			Outputs 0 to 31	Name	Sets the name of the output data.	15 characters max.	Scene	p. 276		
		Expression		Used to set the output data. In the same way as for outputting no-protocol data, you can output multiple pieces of data as a group with the LPR and LPC functions.	---	Scene				
		Edit scene	Logging	Logging item	Search	Logging	Sets whether to log the Search inspection item.	OFF or ON (default)	Scene	p. 201
						Judgement	Sets whether to log parameters.	OFF or ON (default)	Scene	
						Count		OFF or ON (default)	Scene	
Correlation						OFF or ON (default)	Scene			
Position X						OFF or ON (default)	Scene			
Position Y						OFF or ON (default)	Scene			
Angle						OFF or ON (default)	Scene			
Upper limit of logging count						OFF or ON (default)	Scene			

Command			Description		Setting range	Data	Reference		
Edit scene	Logging	Logging item	Labeling	Logging	Sets whether to the Labeling inspection item.	OFF or ON (default)	Scene	p. 201	
				Judgement	Sets whether to log parameters.	OFF or ON (default)	Scene		
				Number of labels		OFF or ON (default)	Scene		
				Total label area		OFF or ON (default)	Scene		
				Area		OFF or ON (default)	Scene		
				Gravity center X		OFF or ON (default)	Scene		
				Gravity center Y		OFF or ON (default)	Scene		
				Elliptic major angle		OFF or ON (default)	Scene		
				Upper limit of logging count		OFF or ON (default)	Scene		
			Shape Search	Logging	Sets whether to log the Shape Search inspection item.	OFF or ON (default)	Scene		p. 201
				Judgement	Sets whether to log parameters.	OFF or ON (default)	Scene		
				Count		OFF or ON (default)	Scene		
				Correlation		OFF or ON (default)	Scene		
				Position X		OFF or ON (default)	Scene		
				Position Y		OFF or ON (default)	Scene		
		Angle			OFF or ON (default)	Scene			
		Upper limit of logging count			OFF or ON (default)	Scene			
		Edge position	Logging	Sets whether to log the Edge Position inspection item.	OFF or ON (default)	Scene			
			Judgment	Sets whether to log parameters.	OFF or ON (default)	Scene			
			Position X		OFF or ON (default)	Scene			
			Position Y		OFF or ON (default)	Scene			
		Calculation	Logging	Sets whether to log calculations.	OFF or ON (default)	Scene			
			Log overall judgement	Sets whether to reflect the calculation results in the overall judgement.	OFF or ON (default)	Scene			
			Log judgement	Sets whether to log judgement results.	OFF or ON (default)	Scene			
			Judgments 0 to 31	Sets whether to log individual judgement results 0 through 31.	OFF or ON (default)	Scene			
			Log calculation	Sets whether to log calculation results.	OFF or ON (default)	Scene			
			Results 0 to 31	Sets whether to log individual calculation results 0 through 31.	OFF or ON (default)	Scene			
System	Trigger settings	Select trigger	Trigger type	Sets the trigger type to use for measurements.	TRIG (default), EtherCat trigger, or Encoder trigger	System	p. 79		
			Trigger delay time	Sets the trigger delay time.	0 to 163 ms (default: 0)	System	p. 80		

Command		Description		Setting range	Data	Reference	
System	I/O	OUT allocation	OUT0	Assigns what to output with OUT0.	OR (default) or OR0 to OR31	System	p. 218
			OUT1	Assigns what to output with OUT1.	BUSY (default) or OR0 to OR31	System	
			OUT2	Assigns what to output with OUT2.	ERROR (default) or OR0 to OR31	System	
			OUT3	Assigns what to output with OUT3.	SHTOUT (default) or OR0 to OR31	System	
			OUT4	Assigns what to output with OUT4.	STGOUT (default) or OR0 to OR31	System	
		BUSY output settings	Output condition	Sets when to turn OFF the BUSY signal after the measurement process begins.	Measurement (default), Data logging, Image logging, or Result display	System	p. 223
			Output polarity	Sets the ON condition for the BUSY signal.	BUSY: ON (default), READY: ON	System	p. 222
		OR output settings	Output polarity	Sets the ON condition for the OR signal.	OK: ON or NG: ON (default)	System	p. 222
			Output mode	Sets the output timing for the judgement result.	One-shot output or Level output (default)	System	p. 221
			One-shot output delay	When one-shot output mode is selected, this parameter sets the delay from when measurement processing is completed until when the OR signal turns ON.	0 to 1,000 ms (default: 0 ms)	System	
	One-shot output time		When one-shot output mode is selected, this parameter sets the time to turn the OR signal OFF.	1 to 1,000 ms (default: 5 ms)	System		
	Encoder settings	Common encoder settings	Multiplication	Sets the multiplier for the encoder input pulse count.	1x (default), 2x, or 4x	System	p. 340
			Direction of rotation	Specifies the direction to count up for the encoder.	CW (Clockwise) (default), CCW (Counterclockwise)	System	p. 340
			Reverse-turn trigger detection	Specifies whether to create the trigger when rotating in the opposite direction.	OFF (default) or ON	System	p. 340
			Terminating resistance	Turns the encoder terminating resistance ON or OFF.	OFF (default) or ON	System	p. 340
			Hunting width	Specifies the hunting width of the encoder.	0 to 65,535 (default: 0) 0: No hunting processing	System	p. 340
			Backlash width	Specifies the backlash width of the encoder.	0 to 65,535 (default: 0) 0: No backlash processing	System	p. 340
Ring counter settings		Offset value	Sets the value of the ring counter when it is reset.	0 to 65,535 (default: 0)	System	p. 342	
		Maximum value	Sets the maximum value of the ring counter. This value must be the same as the encoder counter in the Robot Controller.	0 to 1,000,000,000 (default: 1,000,000,000)	System	p. 342	
System	Encoder settings	Encoder trigger settings	Reset timing	Specifies the timing to reset the encoder trigger counter.	Z phase (default), TRIG signal, or after trigger is input	System	p. 341
			Offset value of trigger counter	Sets the value of the trigger counter when it is reset.	-32,768 to 32,767 (Default: 0)	System	p. 341
			Use Trigger Counter 1 to 6 Flags	Specifies the timing to create the trigger.	OFF (default) or ON	System	p. 341
			Trigger counters 1 to 6		1 to 1,000,000,000 (Default: 1)	System	p. 341

Command			Description	Setting range	Data	Reference	
System	Ethernet communication settings	Ethernet settings	Auto connection	Sets whether an IP address is assigned to the Sensor automatically.	OFF (default) or ON	System	p. 297
		IP address	Enter the IP address of the Sensor. (This setting is enabled only when auto connection is set to OFF.)	a.b.c.d a: 1 to 223 b: 0 to 255 c: 0 to 255 d: 1 to 254 (Default: 10.5.5.100)	System	p. 297	
		Subnet mask	Specifies the subnet mask address. (This setting is enabled only when auto connection is set to OFF.)	0.0.0.0 to 255.255.255.255 (Default: 255.255.255.0)	System	p. 297	
		Default Gateway	Specifies the default gateway address. (This setting is enabled only when auto connection is set to OFF.)	0.0.0.0 to 255.255.255.255 (Default: 0.0.0.0)	System	p. 297	
	No-protocol data communication settings	Communication type	Specifies the communications method to use to output no-protocol data.	None (default), Normal (TCP Server), or Normal (TCP Client)	System	p. 298	
		IP Address	Specifies the IP address to which to output no-protocol data. * Setting is not possible if the communications method is set to "TCP server."	a.b.c.d a: 1 to 223 b: 0 to 255 c: 0 to 255 d: 1 to 254 (Default: 10.5.5.111)	System	p. 298	
		Port No.	Specifies the output port number. * Setting is not possible if the communications method is set to "Normal (TCP server)."	0 to 65,535 (Default: 9,600)	System	p. 298	
	PLC link communication settings	Communication type	Specifies the communications method to use for PLC Link outputs. This can be selected only when the EtherCAT output is set to OFF.	None (default), PLC link (SYSMAC CS/CJ/CP/ONE), PLC link (MELSEC QnU/Q/QnAS)	System	p. 271	
		Instruction area type	Specifies the area to write command data to the Sensor. Control inputs, command codes, and command parameters are written to this area.	PLC Link (SYSMAC CS/CJ/CP/One) CIO Area (CIO) (default), Work Area (WR), Holding Bit Area (HR), Auxiliary Bit Area (AR), DM Area (DM), or EM Area (EM0 to EMC) PLC Link (MELSEC QnU/Q/QnAS) Data registers File registers Link registers	System	p. 272	
		Instruction area address	Specifies the address of the first word in the command area.	0 to 99,999 (Default: 0)	System	p. 272	
		Response area type	Specifies the area to write execution results from the Sensor. (Control outputs, command codes, response codes, and response data)	CIO Area (CIO) (default), Work Area (WR), Holding Bit Area (HR), Auxiliary Bit Area (AR), DM Area (DM), or EM Area (EM0 to EMC)	System	p. 272	
		Response area address	Specifies the address of the first word in the response area.	0 to 99,999 (Default: 100)	System	p. 272	

Command		Description	Setting range	Data	Reference			
System	Ethernet communication settings	PLC link communication settings	Output area type	Specifies the area to write output data from measurements. Output data 0 to 255	CIO Area (CIO) (default) Work Area (WR) Holding Bit Area (HR) Auxiliary Bit Area (AR) DM Area (DM) EM Area (EM0) EM Area (EM1) : EM Area (EMC)	System	p. 272	
			Output area address	Specifies the address of the first word in the output area.	0 to 99,999 (Default: 200)	System	p. 272	
			Output control	Sets whether to establish an interlock with the PLC when data is output. None: Data is output regardless of the signal status from the PLC. Handshake: Data is output only after confirming the DSA signal from the PLC.	None (default) or Handshake	System	p. 272	
			Control timeout	Specifies the timeout time when handshaking is enabled.	100 to 120,000 ms (Default: 10,000 ms)	System	p. 272	
			Upper limit of output data count	Specifies the maximum number of output data.	32 to 1,024 bytes (Default: 256)	System	p. 272	
	Programmable no-protocol data communication settings	Communication type	Communication type	Specifies the communications method to use for programmable no-protocol I/O.	None (default), TCP client, or TCP server	System	p. 327	
			Output setting (when the [communication type] is set to "TCP client")	Output settings	Specifies whether to output Output Setting.	OFF or ON (default)	System	p. 328
				IP address	Specifies the IP address of the output destination for Robot Controller data.	a.b.c.d a: 1 to 223 b: 0 to 255 c: 0 to 255 d: 1 to 254 (Default: 10.5.5.111)	System	p. 328
				Port No.	Specifies the output port number.	0 to 65,535 (Default: 9,600)	System	p. 328
			Port No. (when the [communication type] is set to "TCP server")	Port No.	Used to specify the port number	0 to 65,536 (Default: 9,878)	System	p. 328
	EtherCAT communication settings	EtherCAT communication	EtherCAT communication	Sets whether to perform data output via EtherCAT. You can output EtherCAT data if outputting no-protocol link data is disabled.	OFF (default) or ON	System	p. 234	
			Data output size	Specifies the size of the data output region. Allows you to change the size of data to output at one time. Set this value according to the size of the data output region of the EtherCAT master PDO.	259th PDO mapping (default) 259th+260th PDO mapping 259th+261th PDO mapping 259th+262th PDO mapping	System	p. 234	
			Output handshake	Sets whether to establish an interlock with the EtherCAT master when data is output. OFF: Data is output regardless of the signal status from the EtherCAT master. ON: Data is output only after confirming the DSA signal from the EtherCAT master.	OFF or Handshake (default)	System	p. 234	

Command		Description		Setting range	Data	Reference	
System	EtherCAT communication settings	For when the output control setting is set to "None."	Output cycle	Specifies the cycle to output EtherCAT data when handshaking is disabled.	2 to 5,000 ms (Default: 10 ms)	System	p. 234
			Output time of GATE signal	Specifies the output time of the GATE signal when handshaking is disabled.	1 to 1,000 ms (Default: 5 ms)	System	p. 234
		For when the output control setting is set to "Handshake."	Control time-out time	Specifies the timeout time when handshaking is enabled.	100 to 120,000 ms (Default: 10,000 ms)	System	p. 234
	Log settings		Statistical data	Sets whether to record the number of measurements and the number of NG overall judgements.	Do not show (default) or Show	System	p. 199
			Image data	Sets the condition to log measurement image data.	Save all, Save only NG items, or None (default)	System	p. 192
			Measurement data	Resets the log data without turning OFF the power supply.	All, Only NG, or None (default)	System	p. 192
	Sensor settings	Startup mode	Startup mode	Select whether the startup scene number is set manually. When startup scene control is set to OFF, the Sensor starts with the same scene number as when the data was saved.	OFF (default) or ON	System	p. 182
			Startup scene	Sets the scene number to use at startup.	0 to 31 (Default: 0)	System	p. 182
		Password settings	Password settings	Specifies whether to enable (ON) or disable (OFF) the password.	OFF (default) or ON	System	p. 208
			Password	Sets the password.	15 characters max.	System	p. 208
	Adjustment judgement	Adjustment judgement	Sets whether to adjust judgement parameters in Run Mode.	OFF (default) or ON	System	p. 176	
Calibration scene data	Wizard settings		CT batch sampling	Performs conveyor tracking calibration with an encoder input. Special calibration marks are used to automatically detect target marks and calculate the calibration parameters.	---	---	p. 348
			CT select point	Performs conveyor tracking calibration with an encoder input. The specified calibration marks are used and position information is entered directly to calculate the calibration parameters.	---	---	p. 353
			General purpose batch sampling	Special calibration marks are used to automatically detect target marks and calculate the calibration parameters.	---	---	p. 357
			General purpose sequential sampling	The specified calibration marks are registered as a model, and the result of the position detection performed on those marks is used to calculate the calibration parameters.	---	---	p. 363

Command			Description	Setting range	Data	Reference
Calibration scene data	Wizard settings	General purpose select point	The specified calibration marks are used and position information is entered directly to calculate the calibration parameters.	---	---	p. 360
		Direct input	The calibration parameters are calculated by specifying the standard position, magnification, rotation angle, and coordinates.	---	---	p. 368
	Parameter settings	Coefficient A	Allows you to view and edit calibration parameters.	-99,999,999.999999 to 99,999,999.999999 (Defaults: 1)	Calibration	---
		Coefficient B		-99,999,999.999999 to 99,999,999.999999 (Defaults: 0)	Calibration	---
		Coefficient C		-99,999,999.999999 to 99,999,999.999999 (Defaults: 0)	Calibration	---
		Coefficient D		-99,999,999.999999 to 99,999,999.999999 (Defaults: 0)	Calibration	---
		Coefficient E		-99,999,999.999999 to 99,999,999.999999 (Defaults: 1)	Calibration	---
		Coefficient F		-99,999,999.999999 to 99,999,999.999999 (Defaults: 0)	Calibration	---
		X Distance per encoder pulse		Allows you to view and edit the distance moved per encoder input pulse.	-99,999.9999 to 99,999.9999	Calibration
Y Distance per encoder pulse	-99,999.9999 to 99,999.9999	Calibration				

12-2 External Reference Parameters

Search

External reference number	Category	Data name	Setting/Acquisition	Data range	Default	Expression text string	Logged data/Judgement parameter	
0	Measurement result	Judgement	Acquisition only	-2: No judgement (not measured), 0: Judgement is OK -1: Judgement is NG -13: Teaching not performed error -14: Figure not registered error -15: Out of range error	-2	JG	Logged data	
5		Correlation	Acquisition only	0 to 100	0	CR[0] to CR[31]	Logged data	
6		Position X	Acquisition only	-99,999.9999 to 99,999.9999	0	X[0] to X[31]	Logged data	
7		Position Y	Acquisition only	-99,999.9999 to 99,999.9999	0	Y[0] to Y[31]	Logged data	
8		Measure angle	Acquisition only	-180 to 180	0	TH[0] to TH[31]	Logged data	
9		Reference X	Acquisition only	-99,999.9999 to 99,999.9999	0	SX	---	
10		Reference Y	Acquisition only	-99,999.9999 to 99,999.9999	0	SY	---	
11		Reference angle	Acquisition only	-180 to 180	0	ST	---	
12		Detection point coordinate X	Acquisition only	-99999.9999 to 99999.9999	0	RX	---	
13		Detection point coordinate Y	Acquisition only	-99,999.9999 to 99,999.9999	0	RY	---	
14		Count	Acquisition only	0 to 32	0	C	Logged data	
121		Model region	Rotation	Acquisition only	0: No, 1: Yes	0	---	---
122			Rotation angle upper limit	Acquisition only	-180 to 180	180	---	---
123			Rotation angle lower limit	Acquisition only	-180 to 180	-180	---	---
132	Detection coordinate	Detection point X	Acquisition only	-99,999.9999 to 99,999.9999	0	---	---	
133		Detection point Y	Acquisition only	-99,999.9999 to 99,999.9999	0	---	---	
134	Measurement condition	Sub-pixel	Acquisition only	0: No, 1: Yes	0	---	---	
135		Candidate level	Acquisition only	0 to 100	60	---	---	

External reference number	Category	Data name	Setting/Acquisition	Data range	Default	Expression text string	Logged data/Judgement parameter	
136	Judgement conditions	Judgement upper limit for search coordinate X	Setting/Acquisition	-99,999.9999 to 99,999.9999	99999.9999	---	Adjust judgement	
137		Judgement lower limit for search coordinate X	Setting/Acquisition	-99,999.9999 to 99,999.9999	-99999.9999	---	Adjust judgement	
138		Judgement upper limit for search coordinate Y	Setting/Acquisition	-99,999.9999 to 99,999.9999	99999.9999	---	Adjust judgement	
139		Judgement lower limit for search coordinate Y	Setting/Acquisition	-99,999.9999 to 99,999.9999	-99999.9999	---	Adjust judgement	
140		Judgement upper limit for search angle	Setting/Acquisition	-180 to 180	180	---	Adjust judgement	
141		Judgement lower limit for search angle	Setting/Acquisition	-180 to 180	-180	---	Adjust judgement	
142		Judgement upper limit for correlation	Setting/Acquisition	0 to 100	100	---	Adjust judgement	
143		Judgement lower limit for correlation	Setting/Acquisition	0 to 100	0	---	Adjust judgement	
146		Sort condition	Setting/Acquisition	For Multiple Searches 0: Ascending order of correlation value, 1: Descending order of correlation value, 2: Ascending order of position X, 3: Descending order of position X, 4: Ascending order of position Y, 5: Descending order of position Y	1	---	---	
148		Judgement upper limit for detection count	Setting/Acquisition	0 to 32	32	---	Adjust judgement	
149		Judgement lower limit for detection count	Setting/Acquisition	0 to 32	0	---	Adjust judgement	
150		Measurement condition	Multiple output	Setting/Acquisition	0: No, 1: Yes	0	---	---
152			Extraction condition, X upper limit	Setting/Acquisition	-99,999.9999 to 99,999.9999	99999.9999	---	---
153			Extraction condition, X lower limit	Setting/Acquisition	-99,999.9999 to 99,999.9999	-99999.9999	---	---
154	Extraction condition, Y upper limit		Setting/Acquisition	-99,999.9999 to 99,999.9999	99999.9999	---	---	
155	Extraction condition, Y lower limit		Setting/Acquisition	-99,999.9999 to 99,999.9999	-99999.9999	---	---	
156	Extraction condition, angle upper limit		Setting/Acquisition	-180 to 180	180	---	---	
157	Extraction condition, angle lower limit		Setting/Acquisition	-180 to 180	-180	---	---	
158	Repetition removal		Setting/Acquisition	0: Repetition removal OFF, 1: Repetition removal ON	0	---	---	

External reference number	Category	Data name	Setting/Acquisition	Data range	Default	Expression text string	Logged data/Judgement parameter
159	Measurement condition	Judgement distance	Setting/Acquisition	0 to 99,999.99999	0	---	---
160		Detection count	Setting/Acquisition	1 to 32	32	---	---
200		Grip interference check	Setting/Acquisition	0: OFF, 1: ON	0	---	---
201		Grip interference check reference area	Setting/Acquisition	0 to 999,999,999	0	---	---
202		Grip area level	Setting/Acquisition	0 to 100	80	---	---
210	Extracted image display condition	Background color	Setting/Acquisition	0: Black, 1: White, 2: Red, 3: Green, or 4: Blue	0	---	---
211	Set color Binary	Area color inversion	Setting/Acquisition	0: None or 1: Enabled	0	---	---
212	Binary	Binary level upper limit	Setting/Acquisition	0 to 255	255	---	---
213		Binary level lower limit	Setting/Acquisition	0 to 255	128	---	---
214	Extracted image display condition	Binary image display	Setting/Acquisition	0: No binary image display, 1: Binary image display	1	---	---
215		Image type	Setting/Acquisition	0: Measurement image, 1: Color extraction image, 2: Selected color image, 3: Binary image after extraction	1	---	---
260+Nx10 (N=0 to 3)	Set color	Registered color usage flag N	Setting/Acquisition	0: Not used, 1: Used	1(N=0), 0(N=1 to 3)	---	---
261+Nx10 (N=0 to 3)		Registered color OR/NOT flag N	Setting/Acquisition	0: OR, 1: NOT	0	---	---
262+Nx10 (N=0 to 3)		Registered color maximum hue N	Setting/Acquisition	0 to 359	359	---	---
263+Nx10 (N=0 to 3)		Registered color minimum hue N	Setting/Acquisition	0 to 359	0	---	---
264+Nx10 (N=0 to 3)		Registered color maximum saturation N	Setting/Acquisition	0 to 255	255	---	---
265+Nx10 (N=0 to 3)		Registered color minimum saturation N	Setting/Acquisition	0 to 255	0	---	---
266+Nx10 (N=0 to 3)		Registered color maximum brightness N	Setting/Acquisition	0 to 255	255	---	---
267+Nx10 (N=0 to 3)		Registered color minimum brightness N	Setting/Acquisition	0 to 255	0	---	---

External reference number	Category	Data name	Setting/Acquisition	Data range	Default	Expression text string	Logged data/Judgement parameter
300	Logging conditions	Number of data log records	Setting/Acquisition	0 to 32	32	---	---
310		Data logging switch for entire unit	Setting/Acquisition	0: Data logging OFF, 1: Data logging ON	1	---	---
311		Data logging switch for judgement	Setting/Acquisition	0: Data logging OFF, 1: Data logging ON	1	---	---
312		Data logging switch for correlation	Setting/Acquisition	0: Data logging OFF, 1: Data logging ON	1	---	---
313		Data logging switch for position X	Setting/Acquisition	0: Data logging OFF, 1: Data logging ON	1	---	---
314	Logging conditions	Data logging switch for position Y	Setting/Acquisition	0: Data logging OFF, 1: Data logging ON	1	---	---
315		Data logging switch for measurement angle	Setting/Acquisition	0: Data logging OFF, 1: Data logging ON	1	---	---
321		Data logging switch for detection count	Setting/Acquisition	0: Data logging OFF, 1: Data logging ON	1	---	---

Edge Position

External reference number	Category	Data name	Setting/ Acquisition	Data range	Default	Expression text string	Logged data/ Judgement parameter
0	Measurement result	Judgement	Acquisition only	-2: No judgement (not measured), 0: Judgement is OK -1: Judgement is NG -13: Teaching not performed error -14: Figure not registered error -15: Out of range error	-2	JG	Logged data
5		Edge position X	Acquisition only	-99,999.9999 to 99,999.9999	0	X	Logged data
6		Edge position Y	Acquisition only	-99,999.9999 to 99,999.9999	0	Y	Logged data
7		Standard position X	Acquisition only	-99,999.9999 to 99,999.9999	0	SX	---
8		Standard position Y	Acquisition only	-99,999.9999 to 99,999.9999	0	SY	---
120	Set color	Set color	Setting/ Acquisition	0: No edge color specification, 1: Edge color specification	0	---	---
121		Edge color red	Setting/ Acquisition	0 to 255	255	---	---
122		Edge color green	Setting/ Acquisition	0 to 255	255	---	---
123		Edge color blue	Setting/ Acquisition	0 to 255	255	---	---
127		Detection mode	Setting/ Acquisition	Edge Detection Mode Parameter 0: Color IN, 1:Color OUT	0	---	---
132	Measurement condition	Edge level	Setting/ Acquisition	0 to 100	50	---	---
133		Noise level	Setting/ Acquisition	0 to 442	5	---	---
136	Judgement conditions	Edge position X upper limit	Setting/ Acquisition	-99,999.9999 to 99,999.9999	99999.9999	---	Adjust judgement
137		Edge position X lower limit	Setting/ Acquisition	-99,999.9999 to 99,999.9999	-99999.9999	---	Adjust judgement
138		Edge position Y upper limit	Setting/ Acquisition	-99,999.9999 to 99,999.9999	99999.9999	---	Adjust judgement
139		Edge position Y lower limit	Setting/ Acquisition	-99,999.9999 to 99,999.9999	-99999.9999	---	Adjust judgement
140	Measurement condition	Detection mode for Monochrome Sensor	Setting/ Acquisition	0: Light → Dark, 1: Dark → Light	0	---	---
144		Measurement method for Monochrome Sensor	Setting/ Acquisition	0: Projection method, 1: Differentiation method	0	---	---

External reference number	Category	Data name	Setting/ Acquisition	Data range	Default	Expression text string	Logged data/ Judgement parameter
310	Logging conditions	Data logging switch for entire unit	Setting/ Acquisition	0: Data logging OFF, 1: Data logging ON	1	---	---
311		Data logging switch for judgement	Setting/ Acquisition	0: Data logging OFF, 1: Data logging ON	1	---	---
312		Data logging switch for detected edge position X	Setting/ Acquisition	0: Data logging OFF, 1: Data logging ON	1	---	---
313		Data logging switch for detected edge position Y	Setting/ Acquisition	0: Data logging OFF, 1: Data logging ON	1	---	---

Labeling

External reference number	Category	Data name	Setting/ Acquisition	Data range	Default	Expression text string	Logged data/ Judgement parameters
0	Measurement result	Judgement	Acquisition only	-2: No judgement (not measured), 0: Judgement is OK -1: Judgement is NG -13: Teaching not performed error -14: Figure not registered error -15: Out of range error	-2	JG	Logged data
5		# of label	Acquisition only	0 to 100	0	L	Logged data
6		Area	Acquisition only	0 to 999,999,999.9999	0	AR[0] to AR[99]	Logged data
7		Gravity coordinate X	Acquisition only	-99,999.9999 to 99,999.9999	0	X[0] to X[99]	Logged data
8		Gravity coordinate Y	Acquisition only	-99,999.9999 to 99,999.9999	0	Y[0] to Y[99]	Logged data
9		Reference area	Acquisition only	0 to 999,999,999.9999	0	SA	---
10		Reference position X	Acquisition only	-99,999.9999 to 99,999.9999	0	SX	---
11		Reference position Y	Acquisition only	-99,999.9999 to 99,999.9999	0	SY	---
15		Total area	Acquisition only	0 to 999,999,999.9999	0	TAR	Logged data
55		Elliptic major angle	Acquisition only	-180 to 180	0	ATH[0] to ATH[99]	Logged data
127		Extracted image display condition	Background color	Setting/ Acquisition	0: Black, 1: White, 2: Red, 3: Green, or 4: Blue	0	---
131	Set color	Inversion Flag	Setting/ Acquisition	0: Do not invert, 1: Invert	0	---	---
	Binary					---	---
132	Measurement conditions	Filling up holes	Setting/ Acquisition	0: No, 1: Yes	0	---	---
133		Outside trimming	Setting/ Acquisition	0: No, 1: Yes	0	---	---
136		Sort condition	Setting/ Acquisition	0: Ascending order of area, 1: Descending order of area, 2: Ascending order of gravity X, 3: Descending order of gravity X, 4: Ascending order of gravity Y, 5: Descending order of gravity Y	1	---	---
146	Binary level	Binary level upper limit	Setting/ Acquisition	0 to 255	255	---	---
147		Binary level lower limit	Setting/ Acquisition	0 to 255	128	---	---
148	Extracted image display condition	Binary image display	Setting/ Acquisition	0: No binary image display, 1: Binary image display	1	---	---
149		Image type	Setting/ Acquisition	0: Measurement image, 1: Color extraction image, 2: Selected color image 3: Binary image after extraction	1	---	---

External reference number	Category	Data name	Setting/ Acquisition	Data range	Default	Expression text string	Logged data/ Judgement parameters
154	Measurement conditions	Repetition removal	Setting/ Acquisition	0: Repetition removal OFF, 1: Repetition removal ON	0	---	---
155		Judgement distance	Setting/ Acquisition	0 to 99,999.9999	0	---	---
156		Extraction condition, detection count	Setting/ Acquisition	0 to 100	100	---	---
160	Set color	Registered color usage flag 0	Setting/ Acquisition	0: Not used, 1: Used	1	---	---
161		Registered color exclusion flag 0	Setting/ Acquisition	0: OR, 1: NOT	0	---	---
162		Registered color maximum hue 0	Setting/ Acquisition	0 to 359	359	---	---
163		Registered color minimum hue 0	Setting/ Acquisition	0 to 359	0	---	---
164		Registered color maximum saturation 0	Setting/ Acquisition	0 to 255	255	---	---
165		Registered color minimum saturation 0	Setting/ Acquisition	0 to 255	0	---	---
166		Registered color maximum brightness 0	Setting/ Acquisition	0 to 255	255	---	---
167		Registered color minimum brightness 0	Setting/ Acquisition	0 to 255	0	---	---
170		Registered color usage flag 1	Setting/ Acquisition	0: Not used, 1: Used	0	---	---
171		Registered color exclusion flag 1	Setting/ Acquisition	0: OR, 1: NOT	0	---	---
172		Registered color maximum hue 1	Setting/ Acquisition	0 to 359	359	---	---
173		Registered color minimum hue 1	Setting/ Acquisition	0 to 359	0	---	---
174		Registered color maximum saturation 1	Setting/ Acquisition	0 to 255	255	---	---
175		Registered color minimum saturation 1	Setting/ Acquisition	0 to 255	0	---	---
176		Registered color maximum brightness 1	Setting/ Acquisition	0 to 255	255	---	---
177		Registered color minimum brightness 1	Setting/ Acquisition	0 to 255	0	---	---
180	Registered color usage flag 2	Setting/ Acquisition	0: Not used, 1: Used	0	---	---	
181	Registered color exclusion flag 2	Setting/ Acquisition	0: OR, 1: NOT	0	---	---	
182	Registered color maximum hue 2	Setting/ Acquisition	0 to 359	359	---	---	
183	Registered color minimum hue 2	Setting/ Acquisition	0 to 359	0	---	---	

External reference number	Category	Data name	Setting/ Acquisition	Data range	Default	Expression text string	Logged data/ Judgement parameters
184	Set color	Registered color maximum saturation 2	Setting/ Acquisition	0 to 255	255	---	---
185		Registered color minimum saturation 2	Setting/ Acquisition	0 to 255	0	---	---
186		Registered color maximum brightness 2	Setting/ Acquisition	0 to 255	255	---	---
187		Registered color minimum brightness 2	Setting/ Acquisition	0 to 255	0	---	---
190		Registered color usage flag 3	Setting/ Acquisition	0: Not used, 1: Used	0	---	---
191		Registered color exclusion flag 3	Setting/ Acquisition	0: OR, 1: NOT	0	---	---
192		Registered color maximum hue 3	Setting/ Acquisition	0 to 359	359	---	---
193		Registered color minimum hue 3	Setting/ Acquisition	0 to 359	0	---	---
194		Registered color maximum saturation 3	Setting/ Acquisition	0 to 255	255	---	---
195		Registered color minimum saturation 3	Setting/ Acquisition	0 to 255	0	---	---
196		Registered color maximum brightness 3	Setting/ Acquisition	0 to 255	255	---	---
300		Logging conditions	Number of data log records	Setting/ Acquisition	1 to 100	100	---
310	Data logging switch for entire unit		Setting/ Acquisition	0: Data logging OFF, 1: Data logging ON	1	---	---
311	Data logging switch for judgement		Setting/ Acquisition	0: Data logging OFF, 1: Data logging ON	1	---	---
312	Data logging switch for number of labels		Setting/ Acquisition	0: Data logging OFF, 1: Data logging ON	1	---	---
313	Data logging switch for area		Setting/ Acquisition	0: Data logging OFF, 1: Data logging ON	1	---	---
314	Data logging switch for gravity X		Setting/ Acquisition	0: Data logging OFF, 1: Data logging ON	1	---	---
315	Data logging switch for gravity Y		Setting/ Acquisition	0: Data logging OFF, 1: Data logging ON	1	---	---
319	Data logging switch for total label area		Setting/ Acquisition	0: Data logging OFF, 1: Data logging ON	1	---	---
326	Data logging switch for elliptic major angle		Setting/ Acquisition	0: Data logging OFF, 1: Data logging ON	1	---	---

External reference number	Category	Data name	Setting/ Acquisition	Data range	Default	Expression text string	Logged data/ Judgement parameters
503	Measurement conditions	Extraction condition, area upper limit	Setting/ Acquisition	0 to 999,999,999.9999	999999999.9999	---	---
504		Extraction condition, area lower limit	Setting/ Acquisition	0 to 999,999,999.9999	0	---	---
513		Extraction condition, gravity X upper limit	Setting/ Acquisition	-99,999.9999 to 99,999.9999	99999.9999	---	---
514		Extraction condition, gravity X lower limit	Setting/ Acquisition	-99,999.9999 to 99,999.9999	-99999.9999	---	---
523		Extraction condition, gravity Y upper limit	Setting/ Acquisition	-99,999.9999 to 99,999.9999	99999.9999	---	---
524		Extraction condition, gravity Y lower limit	Setting/ Acquisition	-99,999.9999 to 99,999.9999	-99999.9999	---	---
602		Judgement parameters	Judgement condition, number of labels upper limit	Setting/ Acquisition	0 to 100	100	---
603	Judgement condition, number of labels lower limit		Setting/ Acquisition	0 to 100	0	---	Adjust judgement
612	Judgement condition, total label area upper limit		Setting/ Acquisition	0 to 999,999,999.9999	999999999.9999	---	Adjust judgement
613	Judgement condition, total label area lower limit		Setting/ Acquisition	0 to 999,999,999.9999	0	---	Adjust judgement
622	Judgement condition, area upper limit		Setting/ Acquisition	0 to 999,999,999.9999	999999999.9999	---	Adjust judgement
623	Judgement condition, area lower limit		Setting/ Acquisition	0 to 999,999,999.9999	0	---	Adjust judgement
632	Judgement condition, gravity X upper limit		Setting/ Acquisition	-99,999.9999 to 99,999.9999	99999.9999	---	Adjust judgement
633	Judgement condition, gravity X lower limit		Setting/ Acquisition	-99,999.9999 to 99,999.9999	-99999.9999	---	Adjust judgement
642	Judgement condition, gravity Y upper limit		Setting/ Acquisition	-99,999.9999 to 99,999.9999	99999.9999	---	Adjust judgement
643	Judgement condition, gravity Y lower limit		Setting/ Acquisition	-99,999.9999 to 99,999.9999	-99999.9999	---	Adjust judgement
652	Judgement condition, elliptic major angle upper limit		Setting/ Acquisition	-180 to 180	180	---	Adjust judgement
653	Judgement condition, elliptic major angle lower limit		Setting/ Acquisition	-180 to 180	-180	---	Adjust judgement

Shape Search

External reference number	Category	Data name	Setting/ Acquisition	Data range	Default	Expression text string	Logged data/ Judgement parameter	
0	Measurement result	Judgement	Acquisition only	-2: No judgement (not measured), 0: Judgement is OK -1: Judgement is NG -13: Teaching not performed error -14: Figure not registered error -15: Out of range error	-2	JG	Logged data	
5		Correlation	Acquisition only	0 to 100	0	CR[0] to CR[31]	Logged data	
6		Position X	Acquisition only	-99,999.9999 to 99,999.9999	0	X[0] to X[31]	Logged data	
7		Position Y	Acquisition only	-99,999.9999 to 99,999.9999	0	Y[0] to Y[31]	Logged data	
8		Measurement angle TH	Acquisition only	-180 to 180	0	TH[0] to TH[31]	Logged data	
9		Reference position X	Acquisition only	-99,999.9999 to 99,999.9999	0	SX	---	
10		Reference position Y	Acquisition only	-99,999.9999 to 99,999.9999	0	SY	---	
11		Reference angle	Acquisition only	-180 to 180	0	ST	---	
12		Detection point coordinate X	Acquisition only	-99,999.9999 to 99,999.9999	0	RX	---	
13		Detection point coordinate Y	Acquisition only	-99,999.9999 to 99,999.9999	0	RY	---	
14		Count	Acquisition only	0 to 32	0	C	Logged data	
120		Model region	Rotation	Setting/ Acquisition	0: No, 1: Yes	0	---	---
121			Rotation angle upper limit	Setting/ Acquisition	-180 to 180	180	---	---
122			Rotation angle lower limit	Setting/ Acquisition	-180 to 180	-180	---	---
133	Measurement condition	Candidate level	Setting/ Acquisition	0 to 100	60	---	---	
134	Detection point coordinate	Detection point X	Setting/ Acquisition	-99,999.9999 to 99,999.9999	0	---	---	
135		Detection point Y	Setting/ Acquisition	-99,999.9999 to 99,999.9999	0	---	---	
136	Measurement condition	Sort condition	Setting/ Acquisition	0: Ascending order of correlation value, 1: Descending order of correlation value, 2: Ascending order of position X, 3: Descending order of position X, 4: Ascending order of position Y, 5: Descending order of position Y	1	---	---	

External reference number	Category	Data name	Setting/ Acquisition	Data range	Default	Expression text string	Logged data/ Judgement parameter
138	Judgement parameters	Judgement upper limit for correlation	Setting/ Acquisition	0 to 100	100	---	Judgement parameter
139		Judgement lower limit for correlation	Setting/ Acquisition	0 to 100	60	---	Judgement parameter
140		Judgement upper limit for detection count	Setting/ Acquisition	0 to 32	32	---	Judgement parameter
141		Judgement lower limit for detection count	Setting/ Acquisition	0 to 32	0	---	Judgement parameter
142		Judgement upper limit for search coordinate X	Setting/ Acquisition	-99,999.9999 to 99,999.9999	99999.9999	---	Judgement parameter
143		Judgement lower limit for search coordinate X	Setting/ Acquisition	-99,999.9999 to 99,999.9999	-99999.9999	---	Judgement parameter
144		Judgement upper limit for search coordinate Y	Setting/ Acquisition	-99,999.9999 to 99,999.9999	99999.9999	---	Judgement parameter
145		Judgement lower limit for search coordinate Y	Setting/ Acquisition	-99,999.9999 to 99,999.9999	-99999.9999	---	Judgement parameter
146		Judgement upper limit for search angle	Setting/ Acquisition	-180 to 180	180	---	Judgement parameter
147		Judgement lower limit for search angle	Setting/ Acquisition	-180 to 180	-180	---	Judgement parameter
152	Measurement conditions	Extraction condition, X upper limit	Setting/ Acquisition	-99,999.9999 to 99,999.9999	99999.9999	---	Judgement parameter
153		Extraction condition, X lower limit	Setting/ Acquisition	-99,999.9999 to 99,999.9999	-99999.9999	---	Judgement parameter
154		Extraction condition, Y upper limit	Setting/ Acquisition	-99,999.9999 to 99,999.9999	99999.9999	---	Judgement parameter
155		Extraction condition, Y lower limit	Setting/ Acquisition	-99,999.9999 to 99,999.9999	-99999.9999	---	Judgement parameter
156		Extraction condition, angle upper limit	Setting/ Acquisition	-180 to 180	180	---	Judgement parameter
157		Extraction condition, angle lower limit	Setting/ Acquisition	-180 to 180	-180	---	Judgement parameter
158		Repetition removal	Setting/ Acquisition	0: Repetition removal OFF, 1: Repetition removal ON	0	---	---
159		Repetition judgement distance	Setting/ Acquisition	0 to 99,999.9999	0	---	---
160		Image type	Setting/ Acquisition	0: Measurement image, 1: Color extraction image, 2: Selected color image, 3: Binary image after extraction	0	---	---
161		Extraction condition, detection count	Setting/ Acquisition	1 to 32	32	---	---
200	Grip interference check	Setting/ Acquisition	0: OFF, 1: ON	0	---	---	

External reference number	Category	Data name	Setting/ Acquisition	Data range	Default	Expression text string	Logged data/ Judgement parameter
201	Measurement conditions	Grip interference check reference area	Setting/ Acquisition	0 to 999,999,999	0	---	---
202		Grip area level	Setting/ Acquisition	0 to 100	80	---	---
210	Extracted image display condition	Background color	Setting/ Acquisition	0: Black, 1: White, 2: Red, 3: Green, or 4: Blue	0	---	---
211	Set color	Area color inversion	Setting/ Acquisition	0: None or 1: Enabled	0	---	---
	Binary						
212	Binary	Binary level upper limit	Setting/ Acquisition	0 to 255	255	---	---
213		Binary level lower limit	Setting/ Acquisition	0 to 255	128	---	---
214	Extracted image display condition	Binary image display	Setting/ Acquisition	0: No binary image display, 1: Binary image display	1	---	---
260+Nx10 (N=0 to 3)	Set color	Registered color usage flag N	Setting/ Acquisition	0: Not used, 1: Used	1(N=0), 0(N=1 to 3)	---	---
261+Nx10 (N=0 to 3)		Registered color OR/NOT flag N	Setting/ Acquisition	0: OR, 1: NOT	0	---	---
262+Nx10 (N=0 to 3)		Registered color maximum hue N	Setting/ Acquisition	0 to 359	359	---	---
263+Nx10 (N=0 to 3)		Registered color minimum hue N	Setting/ Acquisition	0 to 359	0	---	---
264+Nx10 (N=0 to 3)		Registered color maximum saturation N	Setting/ Acquisition	0 to 255	255	---	---
265+Nx10 (N=0 to 3)		Registered color minimum saturation N	Setting/ Acquisition	0 to 255	0	---	---
266+Nx10 (N=0 to 3)		Registered color maximum brightness N	Setting/ Acquisition	0 to 255	255	---	---
267+Nx10 (N=0 to 3)		Registered color minimum brightness N	Setting/ Acquisition	0 to 255	0	---	---

External reference number	Category	Data name	Setting/ Acquisition	Data range	Default	Expression text string	Logged data/ Judgement parameter
300	Logging conditions	Number of data log records upper limit	Setting/ Acquisition	1 to 32	32	---	---
310		Data logging switch for entire unit	Setting/ Acquisition	0: Data logging OFF, 1: Data logging ON	1	---	---
311		Data logging switch for judgement	Setting/ Acquisition	0: Data logging OFF, 1: Data logging ON	1	---	---
312		Data logging switch for correlation	Setting/ Acquisition	0: Data logging OFF, 1: Data logging ON	1	---	---
313		Data logging switch for position X	Setting/ Acquisition	0: Data logging OFF, 1: Data logging ON	1	---	---
314		Data logging switch for position Y	Setting/ Acquisition	0: Data logging OFF, 1: Data logging ON	1	---	---
315		Data logging switch for measurement angle	Setting/ Acquisition	0: Data logging OFF, 1: Data logging ON	1	---	---
321		Data logging switch for detection count	Setting/ Acquisition	0: Data logging OFF, 1: Data logging ON	1	---	---

Calculations

External reference number	Category	Data name	Setting/ Acquisition	Data range	Default	Expression text string	Logged data/ Judgement parameter	
0	Measurement result	Judgement result	Acquisition only	-2: No judgement (not measured), 0: Judgement is OK, -1: Judgement is NG	-2	JG	Logged data	
5		Calculation result 0	Acquisition only	-999,999,999.9999 to 999,999,999.9999	0	D[0]	Logged data	
6		Calculation result 1	Acquisition only	-999,999,999.9999 to 999,999,999.9999	0	D[1]	Logged data	
7		Calculation result 2	Acquisition only	-999,999,999.9999 to 999,999,999.9999	0	D[2]	Logged data	
⋮		⋮	⋮	⋮	⋮	⋮	⋮	
36		Calculation result 31	Acquisition only	-999,999,999.9999 to 999,999,999.9999	0	D[31]	Logged data	
55		Individual judgement result 0	Acquisition only	-2: No judgement (not measured), 0: Judgement is OK, -1: Judgement is NG	-2	JG[0]	Logged data	
56		Individual judgement result 1	Acquisition only	-2: No judgement (not measured), 0: Judgement is OK, -1: Judgement is NG	-2	JG[1]	Logged data	
57		Individual judgement result 2	Acquisition only	-2: No judgement (not measured), 0: Judgement is OK, -1: Judgement is NG	-2	JG[2]	Logged data	
⋮		⋮	⋮	⋮	⋮	⋮	⋮	
86		Individual judgement result 31	Acquisition only	-2: No judgement (not measured), 0: Judgement is OK, -1: Judgement is NG	-2	JG[31]	Logged data	
103		Set conditions	Reflect to total judgement	Setting/ Acquisition	0: Yes, 1: No	0	---	---
150			Expression 0	Setting/ Acquisition	---	---	---	---
151			Expression 1	Setting/ Acquisition	---	---	---	---
152			Expression 2	Setting/ Acquisition	---	---	---	---
⋮	⋮		⋮	⋮	⋮	⋮	⋮	
181	Expression 31		Setting/ Acquisition	---	---	---	---	
250	Comment 0		Setting/ Acquisition	---	---	---	---	
251	Comment 1		Setting/ Acquisition	---	---	---	---	
252	Comment 2		Setting/ Acquisition	---	---	---	---	
⋮	⋮		⋮	⋮	⋮	⋮	⋮	
281	Comment 31		Setting/ Acquisition	---	---	---	---	

External reference number	Category	Data name	Setting/ Acquisition	Data range	Default	Expression text string	Logged data/ Judgement parameter
300	Judgement parameters	Judgement condition 0 upper limit	Setting/ Acquisition	-999,999,999.9999 to 999,999,999.9999	999,999,999.9999	---	Adjust judgement
301		Judgement condition 1 upper limit	Setting/ Acquisition	-999,999,999.9999 to 999,999,999.9999	999,999,999.9999	---	Adjust judgement
302		Judgement condition 2 upper limit	Setting/ Acquisition	-999999999.9999 to 999999999.9999	999,999,999.9999	---	Adjust judgement
⋮		⋮	⋮	⋮	⋮	⋮	⋮
331		Judgement condition 31 upper limit	Setting/ Acquisition	-999,999,999.9999 to 999,999,999.9999	999,999,999.9999	---	Adjust judgement
350		Judgement condition 0 lower limit	Setting/ Acquisition	-999,999,999.9999 to 999,999,999.9999	-999,999,999.9999	---	Adjust judgement
351		Judgement condition 1 lower limit	Setting/ Acquisition	-999,999,999.9999 to 999,999,999.9999	-999,999,999.9999	---	Adjust judgement
352		Judgement condition 2 lower limit	Setting/ Acquisition	-999,999,999.9999 to 999,999,999.9999	-999,999,999.9999	---	Adjust judgement
⋮		⋮	⋮	⋮	⋮	⋮	⋮
381		Judgement condition 31 lower limit	Setting/ Acquisition	-999,999,999.9999 to 999,999,999.9999	-999,999,999.9999	---	Adjust judgement
410	Logging conditions	Data logging switch for all calculations	Setting/ Acquisition	0: Log, 1: Do not log	1	---	---
411		Data logging switch for overall judgement results	Setting/ Acquisition	0: Log, 1: Do not log	1	---	---
412		Data logging switch for all calculation results	Setting/ Acquisition	0: Log, 1: Do not log	1	---	---
500		Data logging switch for individual judgement 0	Setting/ Acquisition	0: Log, 1: Do not log	1	---	---
501		Data logging switch for individual judgement 1	Setting/ Acquisition	0: Log, 1: Do not log	1	---	---
502		Data logging switch for individual judgement 2	Setting/ Acquisition	0: Log, 1: Do not log	1	---	---
⋮		⋮	⋮	⋮	⋮	⋮	⋮
531		Data logging switch for individual judgement 31	Setting/ Acquisition	0: Log, 1: Do not log	1	---	---
550		Data logging switch for calculation result 0	Setting/ Acquisition	0: Log, 1: Do not log	---	---	---
551		Data logging switch for calculation result 1	Setting/ Acquisition	0: Log, 1: Do not log	---	---	---
552		Data logging switch for calculation result 2	Setting/ Acquisition	0: Log, 1: Do not log	---	---	---
⋮		⋮	⋮	⋮	⋮	⋮	⋮
581		Data logging switch for calculation result 31	Setting/ Acquisition	0: Log, 1: Do not log	---	---	---

12-3 Specifications and Dimensions

Vision Sensors

Specifications

Item		Type	EtherCAT communication function not provided		EtherCAT communication function provided	
			Color	Monochrome	Color	Monochrome
Model	NPN		FQ-MS120	FQ-MS120-M	FQ-MS120-ECT	FQ-MS120-M-ECT
	PNP		FQ-MS125	FQ-MS125-M	FQ-MS125-ECT	FQ-MS125-M-ECT
Field of vision, Installation distance		Selecting a lens according to the field of vision and installation distance. Refer to the "Optical Chart" page.				
Main functions	Inspection items	Shape search, Search, Labeling, Edge position				
	Number of simultaneous inspections	32				
	Number of registered scenes	32				
Image input	Image processing method	Real color	Monochrome	Real color	Monochrome	
	Image elements	1/3-inch color CMOS	1/3-inch monochrome CMOS	1/3-inch color CMOS	1/3-inch monochrome CMOS	
	Image filter	High dynamic range (HDR) and white balance	High dynamic range (HDR)	High dynamic range (HDR) and white balance	High dynamic range (HDR)	
	Shutter	Electronic shutter; select shutter speeds from 1/10 to 1/30000 (sec)				
	Processing resolution	752 (H) × 480 (V)				
	Pixel size	6.0 (μm) × 6.0 (μm)				
	Frame rate (image read time)	60 fps (16.7 ms)				
External Lightings	Connecting method	Connection via a strobe light controller				
	Connectable lighting	FL series				
Data logging	Measurement data	In Sensor: Max. 32000 items (If a Touch Finder is used, results can be saved up to the capacity of an SD card.)				
	Images	In Sensor: 20 images (If a Touch Finder is used, results can be saved up to the capacity of an SD card.)				
Measurement trigger		I/O trigger, Encoder trigger, Communications trigger (Ethernet No-protocol, PLC Link, or EtherCAT)				

Item	Type	EtherCAT communication function not provided		EtherCAT communication function provided	
		Color	Monochrome	Color	Monochrome
I/O specifications	Input signals	9 signals <ul style="list-style-type: none"> • Single measurement input (TRIG) • Error clear input (IN0) • Encoder counter reset input (IN1) • Encoder input (A±, B±, Z±) Refer to <i>Table 1</i> for the input specifications. Refer to <i>Table 2</i> for the encoder pulse input specifications.			
	Output signals	5 signals <ul style="list-style-type: none"> • OUT0 Overall judgement output (OR) • OUT1 Control output (BUSY) • OUT2 Error output (ERROR) • OUT3 (Shutter output: SHTOUT) • OUT4 (Strobe trigger output: STGOUT) The five output signals can be allocated for the judgements of individual inspection items. Refer to <i>Table 3</i> for the output specifications.			
	Ethernet specifications	100BASE-TX/10BASE-TX			
	EtherCAT specifications	---		Dedicated protocol for EtherCAT 100BASE-TX	
	Connection method	Special connector cables		• Power supply and I/O: 1 special connector I/O cable • Touch Finder, Computer and Ethernet: 1 Ethernet cable • EtherCAT: 2 EtherCAT cable	
LED display		<ul style="list-style-type: none"> • OR: Judgment result indicator (color: orange) • ERR: Error indicator (color: red) • BUSY: BUSY indicator (color: green) • ETN: Ethernet communications indicator (color: orange) 			
	EtherCAT display	---		<ul style="list-style-type: none"> • L/A IN (Link/Activity IN) × 1 (color: green) • L/A OUT (Link/Activity OUT) × 1 (color: green) • RUN × 1 (color: green) • ERR × 1 (color: red) 	
Ratings	Power supply voltage	21.6 to 26.4 VDC (including ripple)			
	Insulation resistance	Between all lead wires and case: 0.5 MΩ (at 250 V)			
	Current consumption	450mA max. (When the FL-series Strobe controller and lighting are used.) 250mA max. (When external lighting is not used.)			
Environmental immunity	Ambient temperature range	Operating: 0 to +50°C, Storage: -20 to +65°C (with no icing or condensation)			
	Ambient humidity range	Operating and storage: 35% to 85% (with no icing or condensation)			
	Ambient atmosphere	No corrosive gas			
	Vibration resistance (destruction)	10 to 150 Hz, single amplitude: 0.35 mm, X/Y/Z directions, 8 min each, 10 times			
	Shock resistance (destruction)	150 m/s ² 3 times each in 6 direction (up, down, right, left, forward, and backward)			
	Degree of protection	IEC 60529 IP40			
Materials	Case: aluminium die casting, Rear cover: aluminium plate				
Weight	Approx. 390 g (Sensor only)			Approx. 480 g (Sensor only)	
Accessories	Instruction Manual				

Table 1: I/O Specifications

Input Specifications

TRIG, ERROR CLR, and EFC RST Signals

Mode	NPN	PNP
Input voltage	24 VDC \pm 10%	24 VDC \pm 10%
Input current	7 mA typical (at 24 VDC)	7 mA typical (at 24 VDC)
ON voltage/OFF current	19 V min./3 mA min.	19 V min./3 mA min.
OFF voltage/OFF current	5 V max./1 mA max.	5 V max./1 mA max.
ON delay	0.1 ms max.	0.1 ms max.
OFF delay	0.1 ms max.	0.1 ms max.
Internal circuit diagram		

- *1 ON Current/ON Voltage
The voltage or current at which the signal changes from OFF to ON.
The ON voltage applies to the electrical potential between COM_I and each input terminal.
- *2 OFF Current/OFF Voltage
The voltage or current at which the signal changes from ON to OFF.
The OFF voltage applies to the electrical potential between COM_I and each input terminal.

Table 2: Encoder Input Specifications

Encoder with Open-collector Output

Pulse Input Specifications

Item		Specifications		
Input voltage		24 VDC \pm 10%	12 VDC \pm 10%	5 VDC \pm 5%
Input current		4.8 mA typical (at 24 VDC)	2.4 mA typical (at 12 VDC)	1.0 mA typical (at 5 VDC)
NPN	ON voltage ^{*1}	4.8 V max.	2.4 V max.	1.0 V max.
	OFF voltage ^{*2}	19.2 V min.	9.6 V min.	4.0 V min.
PNP	ON voltage ^{*1}	19.2 V min.	9.6 V min.	4.0 V min.
	OFF voltage ^{*2}	4.8 V max.	2.4 V max.	1.0 V max.
Maximum response frequency ^{*3}		50 kHz (with the FQ-MWD005 or FQ-MWDL005 I/O Cable)		
		20 kHz (with the FQ-MWD010 or FQ-MWDL010 I/O Cable)		
Input impedance		5.1 kΩ		

- *1: ON voltage: The voltage at which the signal changes from OFF to ON. The ON voltage applies to the electrical potential between the power supply ground terminal of the encoder and each input terminal.
- *2: OFF voltage: The voltage at which the signal changes from ON to OFF. The ON voltage applies to the electrical potential between the power supply ground terminal of the encoder and each input terminal.
- *3: The measurement conditions are shown in the following figure.

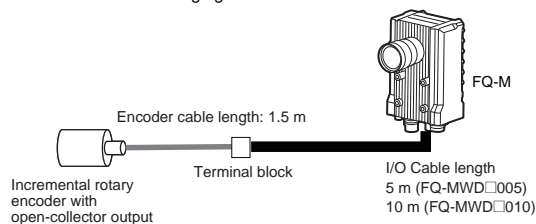

Pulse Input Timing Specifications

Encoder Phases A, B, and Z
Input Pulse Duty: 50%

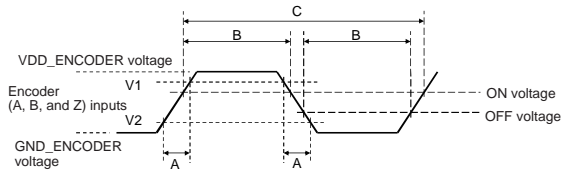

- * The graph shows the input waveform for a PNP encoder.
- * The V1 voltage is $VDD_ENCODER \times 0.9$.
- * The V2 voltage is $VDD_ENCODER \times 0.1$.
- * A is the signal rise/fall time.
- * B is the input ON/OFF time.
- * C is the input pulse cycle time.

Encoder Phases A and B
Input Phase Difference

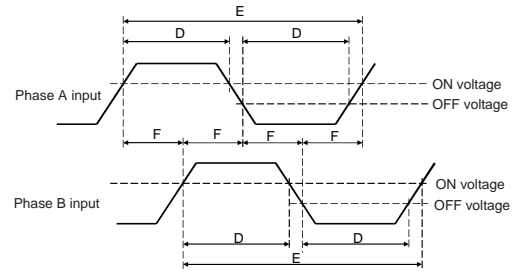

- * The graph shows the input waveform for a PNP encoder.
- * D is the input ON/OFF time.
- * E is the input pulse cycle time.
- * F is the phase lag time.

I/O Cable length	Timing conditions					
	A	B	C	D	E	F
5 m	<25 μ s	>10 μ s	>20 μ s	>10 μ s	>20 μ s	>3 μ s
10 m	<9 μ s	>25 μ s	>50 μ s	>25 μ s	>50 μ s	>6 μ s

Encoder with Line-driver Output

Pulse Input Specifications

Item	Specification
Input voltage	EIA RS-422-A line-driver level
Input impedance ^{*1}	120 $\Omega \pm 5\%$
Differential input voltage	0.2 V min.
Hysteresis voltage	50 mV
Maximum response frequency ^{*2}	200 kHz (with 5-m (FQ-MWD□005) or 10-m (FQ-MWD□010) I/O Cable)

*1: When terminating resistance is used.

*2: The measurement conditions are shown below.

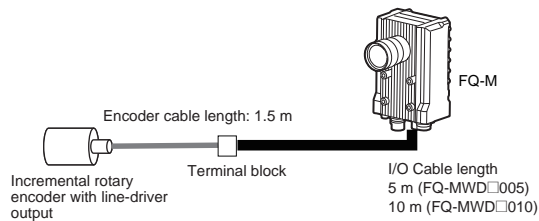

Pulse Input Timing Specifications

Encoder Phases A, B, and Z
Input Pulse Duty: 50%

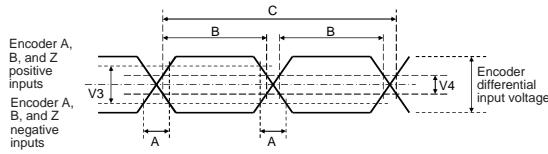

- * The V3 voltage is encoder differential input voltage $\times 0.6$.
- * The V4 voltage is hysteresis voltage (50 mV).
- * A is the signal rise/fall time.
- * B is the input ON/OFF time.
- * C is the input pulse cycle time.

Encoder Phases A and B
Input Phase Difference

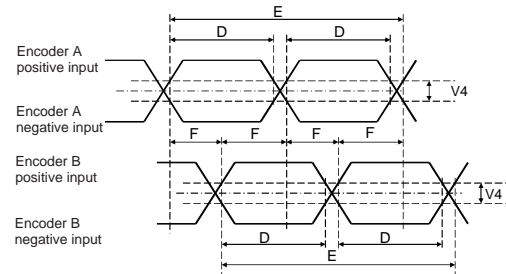

- * The V4 voltage is hysteresis voltage (50 mV).
- * D is the input ON/OFF time.
- * E is the input pulse cycle time.
- * F is the phase lag time.

I/O Cable length	Timing conditions					
	A	B	C	D	E	F
5 or 10 m	<25 μ s	>2.5 μ s	>5.0 μ s	>2.5 μ s	>5.0 μ s	>0.625 μ s

Table 3: Output Specifications

OR, BUSY, ERROR, SHTOUT, and STGOUT Signals

Mode	NPN	PNP
Output voltage	21.6 to 30 VDC	21.6 to 30 VDC
Load current	50 mA max.	50 mA max.
ON residual voltage	1.2 V max.	1.2 V max.
OFF leakage current	0.1 mA max.	0.1 mA max.
Internal circuit diagram		

Important

Connect loads that match the output specifications. The Sensor will fail if the output terminals are short-circuited.

Dimensions

FQ-MS120/-MS120-M
FQ-MS125/-MS125-M

(Unit: mm)

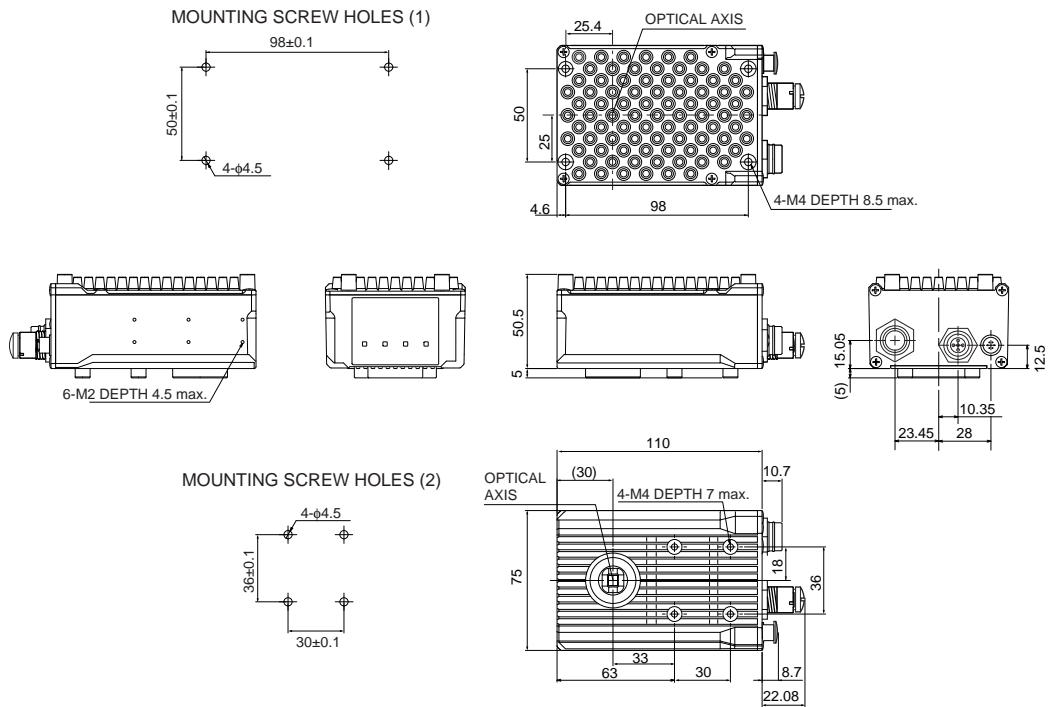

FQ-MS120-ECT/-MS120-M-ECT
FQ-MS125-ECT/-MS125-M-ECT

(Unit: mm)

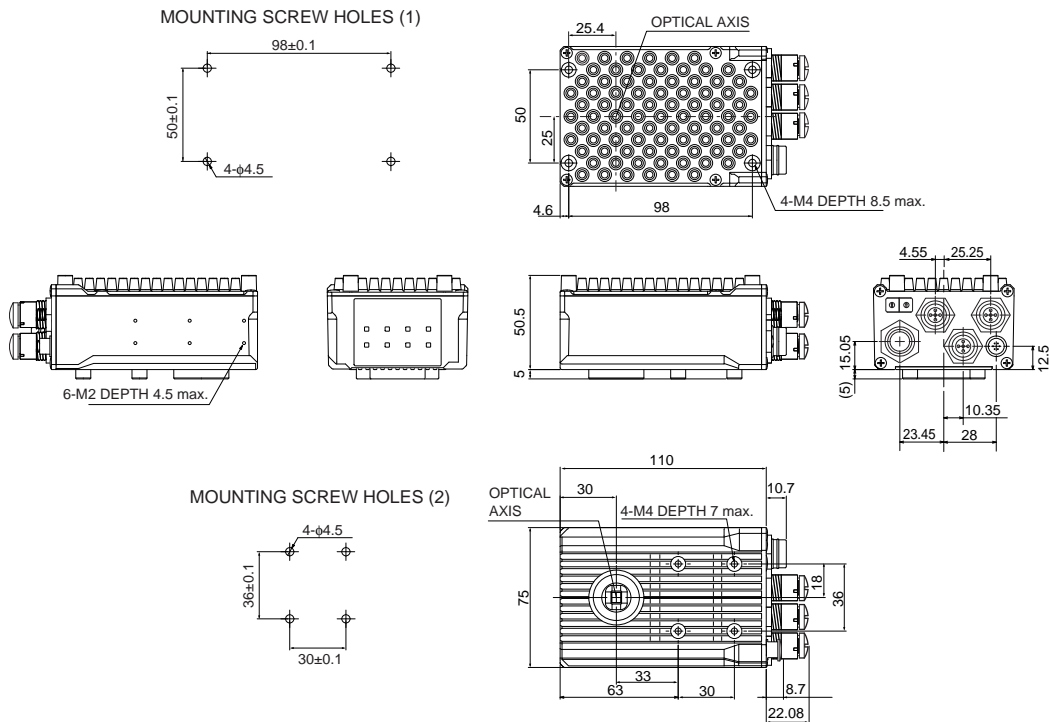

EtherCAT Communications Specifications

Item	Specifications
Communications standard	IEC 61158 Type12
Physical layer	100BASE-TX (IEEE802.3)
Connector	M12 × 2 E-CAT IN : EtherCAT (IN) E-CAT OUT : EtherCAT (OUT)
Communications media	Use the cables for FQ-MWN□□, or FQ-WN□□ series.
Communications distance	Use the communication cable within the length of FQ-MWN□□ or FQ-WN□□ series cables.
Process data	Variable PDO Mapping
Mailbox (CoE)	Emergency messages, SDO requests, SDO responses, and SDO information
Distributed clock	Synchronization with DC mode 1
LED display	L/A IN (Link/Activity IN) × 1 L/A OUT (Link/Activity OUT) × 1 RUN × 1 ERR × 1

Touch Finders

Specifications

Item		Model with DC power supply		Model with AC/DC/battery power supply		
		FQ-MD30		FQ-MD31		
Number of connectable Sensors		2 max.				
Main functions	Types of measurement displays		Last result display, Last NG display, trend monitor, histograms			
	Types of display images		Through, frozen, zoom-in, and zoom-out images			
	Data logging		Measurement results, measured images			
	Menu language		English or Japanese			
Indications	LCD	Display device	3.5-inch TFT color LCD			
		Pixels	320 × 240			
		Display colors	16,777,216			
	Backlight	Life expectancy *1	50,000 hours at 25°C			
		Brightness adjustment	Provided			
		Screen saver	Provided			
	Indicators		Power indicator (color: green): POWER Error indicator (color: red): ERROR SD card access indicator (color: yellow): SD ACCESS	Power indicator (color: green): POWER Error indicator (color: red): ERROR SD card access indicator (color: yellow): SD ACCESS Charge indicator (color: orange): CHARGE		
Operation interface	Touch screen	Method	Resistance film			
		Life expectancy *2	1,000,000 operations			
External interface	Ethernet		100 BASE-TX/10 BASE-T			
	SD card		OMRON HMC-SD291 SD Card or SDHC-compliant, Class 4 or higher card recommended.			
Ratings	Power supply voltage		DC power connection: 20.4 to 26.4 VDC (including ripple)	DC power connection: 20.4 to 26.4 VDC (including ripple) AC adapter connection: 100 to 240 VAC, 50/60 Hz Battery connection: FQ-BAT1 Battery (1 cell, 3.7 V)		
	Continuous operation on Battery *3		---	1.5 h		
	Current consumption		DC power connection: 0.2 A			
	Insulation resistance		Between all lead wires and case: 0.5 MΩ (at 250 V)			

Important

The FQ-MD30 and FQ-MD31 are used exclusively for FQ-M-series Sensors. You cannot connect them to FQ-S-series Sensors.

Item		Model with DC power supply	Model with AC/DC/battery power supply
		FQ-MD30	FQ-MD31
Environmental immunity	Ambient temperature range	Operating: 0 to +50°C Storage: -25 to +65°C (with no icing or condensation)	Operating: 0 to +50°C when mounted to DIN Track or panel 0 to +40°C when operated on a Battery Storage: -25 to +65°C (with no icing or condensation)
	Ambient humidity range	Operating and storage: 35% to 85% (with no condensation)	
	Ambient atmosphere	No corrosive gas	
	Vibration resistance (destruction)	10 to 150 Hz, single amplitude: 0.35 mm, X/Y/Z directions 8 min each, 10 times	
	Shock resistance (destruction)	150 m/s ² 3 times each in 6 direction (up, down, right, left, forward, and backward)	
	Degree of protection	IEC 60529 IP20	
Dimensions		95 × 85 × 33 mm	
Materials		Case: ABS	
Weight		Approx. 270 g (without Battery and hand strap)	
Accessories		Touch Pen (FQ-XT), Instruction Manual	

*1 This is a guideline for the time required for the brightness to diminish to half the initial brightness at room temperature and humidity. No guarantee is implied. The life of the backlight is greatly affected by the ambient temperature and humidity. It will be shorter at lower or higher temperatures.

*2 This value is only a guideline. No guarantee is implied. The value will be affected by operating conditions.

*3 This value is only a guideline. No guarantee is implied. The value will be affected by the operating environment and operating conditions.

• Battery Specifications

Item	FQ-BAT1
Battery type	Secondary lithium ion battery
Nominal capacity	1800 mAh
Rated voltage	3.7 V
Dimensions	35.3 × 53.1 × 11.4 mm
Ambient temperature range	Operating: 0 to +40°C Storage: -25 to +65°C (with no icing or condensation)
Ambient humidity range	Operating and storage: 35% to 85% (with no condensation)
Charging method	Charged in Touch Finder (FQ-MD31). AC adapter (FQ-AC□) is required.
Charging time *1	2.0 h
Battery backup life *2	300 charging cycles
Weight	50 g max.

*1 This value is only a guideline. No guarantee is implied. The value will be affected by operating conditions.

*2 This is a guideline for the time required for the capacity of the Battery to be reduced to 60% of the initial capacity. No guarantee is implied. The value will be affected by the operating environment and operating conditions.

Dimensions

- FQ-MD30/-MD31

(Unit: mm)

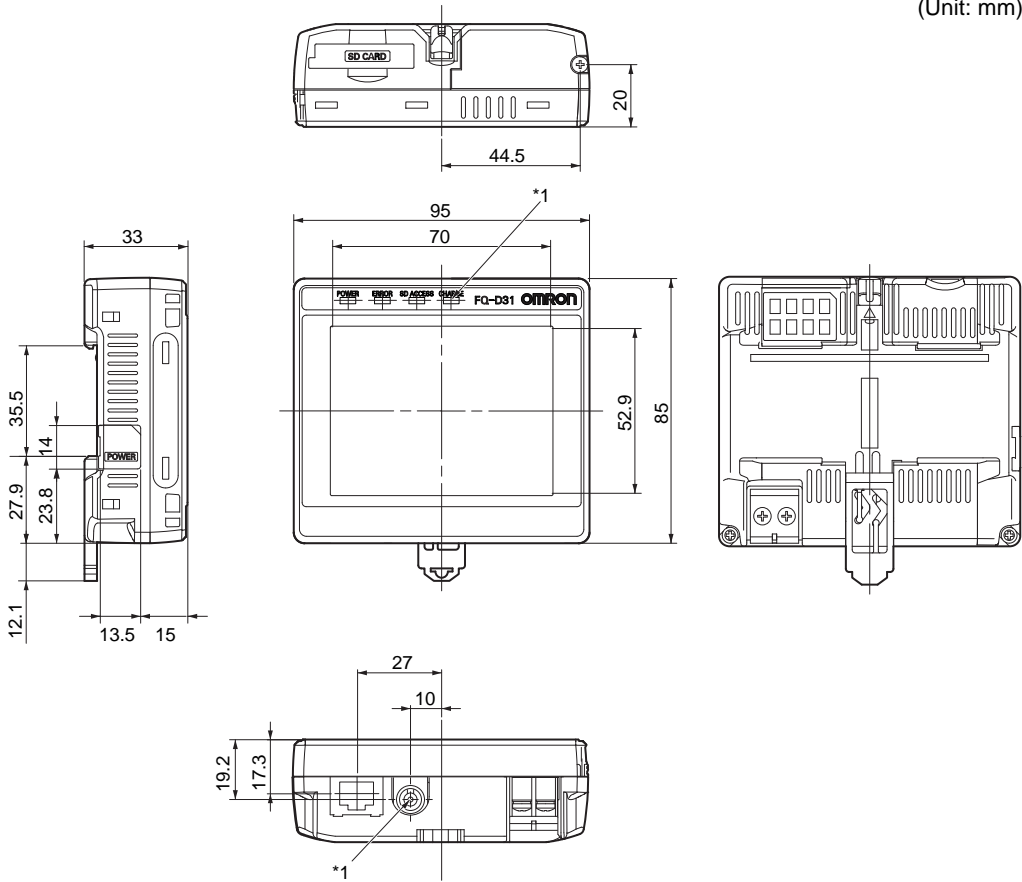

*1: Provided on the FQ-MD31 only.

- Panel Mounting Adapter (FQ-XPM)

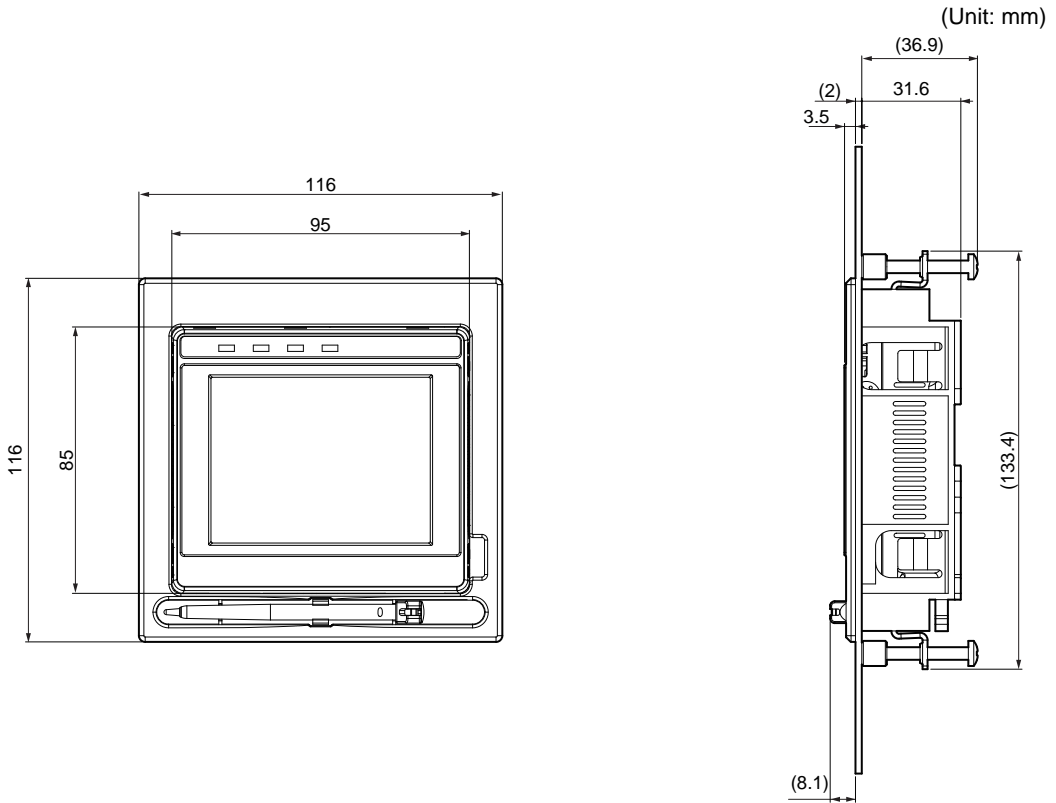

- Panel cutout dimensions

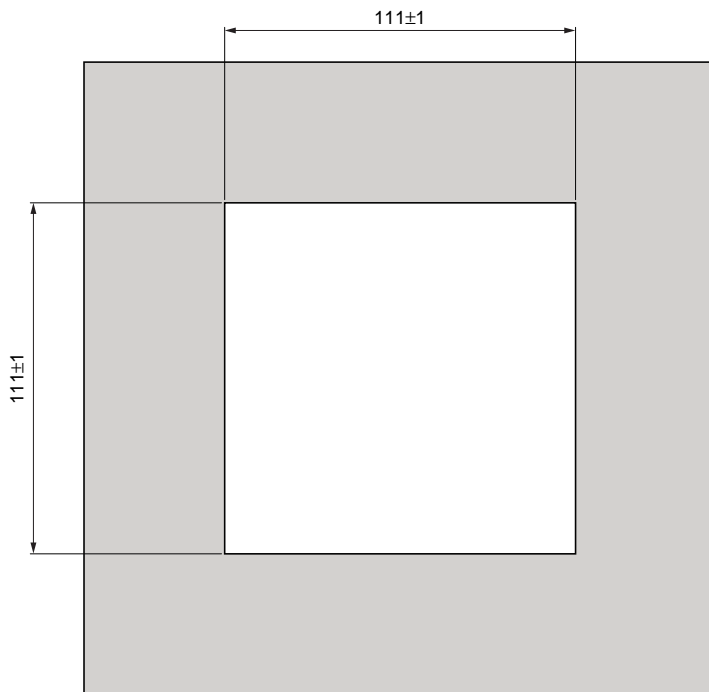

Sysmac Studio

Item	Requirement
Operating system (OS) ^{*1} Japanese or English system	Windows XP (Service Pack 3 or higher, 32-bit version)/Vista (32-bit version)/7 (32-bit/64-bit version)/8 (32-bit/64-bit version)
CPU	Windows computers with Celeron 540 (1.8 GHz) or faster CPU. Core i5 M520 (2.4 GHz) or equivalent or faster recommended
Main memory	2GB min.
Hard disk	At least 1.6 GB of available space ^{*2}
Display	XGA 1024 . 768, 1600 million colors. WXGA 1280 . 800 min. recommended
Disk drive	DVD-ROM drive
Communications ports	USB 2.0 port or Ethernet port

*1 Sysmac Studio Operating System Precaution: System requirements and hard disk space may vary with the system environment.

*2 To use the file logging function, additional memory area to save the logging data is necessary.

Options

Specifications

• Straight Ethernet/EtherCAT Cables (M12/RJ45)

Item	FQ-WN005	FQ-WN010
Cable length	5 m	10 m
Cable type	Robot cable	
Minimum bending radius	40 mm	
Weight	310 g	620 g

• Angled Ethernet/EtherCAT Cables (M12/RJ45)

Item	FQ-MWNL005	FQ-MWNL010
Cable length	5 m	10 m
Cable type	Robot cable	
Minimum bending radius	50 mm	
Weight	320 g	620 g

• Straight EtherCAT Cables (M12/M12)

Item	FQ-MWNE005	FQ-MWNE010
Cable length	5 m	10 m
Cable type	Robot cable	
Minimum bending radius	40 mm	
Weight	310 g	620 g

• Angled EtherCAT Cables (M12/M12)

Item	FQ-MWNE005	FQ-MWNE010
Cable length	5 m	10 m
Cable type	Robot cable	
Minimum bending radius	50 mm	
Weight	310 g	620 g

• Straight I/O Cables

Item	FQ-MWD005	FQ-MWD010
Cable length	5 m	10 m
Cable type	Robot cable	
Wire size	Power supply	AWG24
Cable diameter	Other wires	AWG28 to AWG24
Minimum bending radius	51 mm	
Weight	520 g	1,040 g

• Angled I/O Cables

Item		FQ-MWDL005	FQ-MWDL010
Cable length		5 m	10 m
Cable type		Robot cable	
Wire size	Power supply	AWG24	
Cable diameter	Other wires	AWG28 to AWG24	
Minimum bending radius		51 mm	
Weight		540 g	1,080 g

• AC Adapter

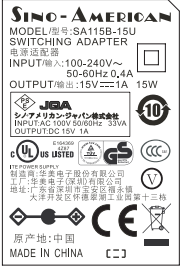
Item	Model	FQ-AC1
Input voltage		100 to 240 VAC (90 to 264 VAC), 50/60 Hz
Input current		0.3 mA max.
Output voltage		15 VDC±20%
Output current		1 A max.
Ambient temperature range		Operating: 0 to 40°C Storage: -20 to 65°C (with no icing or condensation)
Ambient humidity range		Operating and storage: 35% to 80% (with no condensation)
Material		Case: PPE
Cable length		1.5 m
Dimensions		78 × 50 × 30 mm (without power cable)
Weight		Approx. 270 g
Contents of label on AC Adapter		 <p>SINO-AMERICAN MODEL/型号: SA115B-15U SWITCHING ADAPTER 开关电源适配器 INPUT/输入: 100-240V~ 50-60Hz 0.4A OUTPUT/输出: 15V=1A 15W</p> <p>JSA シニアリカン・ジャパン株式会社 INPUT: AC 100V-240V 50/60Hz 0.4A OUTPUT: DC 15V 1A</p> <p>UL us ultritec CCC GS V</p> <p>SHANGHAI SINO-AMERICAN ELECTRIC CO., LTD. 上海申安电气有限公司 地址: 上海市浦东新区川沙新镇川沙路1333号 上海开安电源适配器有限公司 邮编: 201203</p> <p>原产地: 中国 MADE IN CHINA</p>

Dimensions

• For EtherCAT and Ethernet Cable

Straight type (M12/RJ45)

FQ-WN005/010

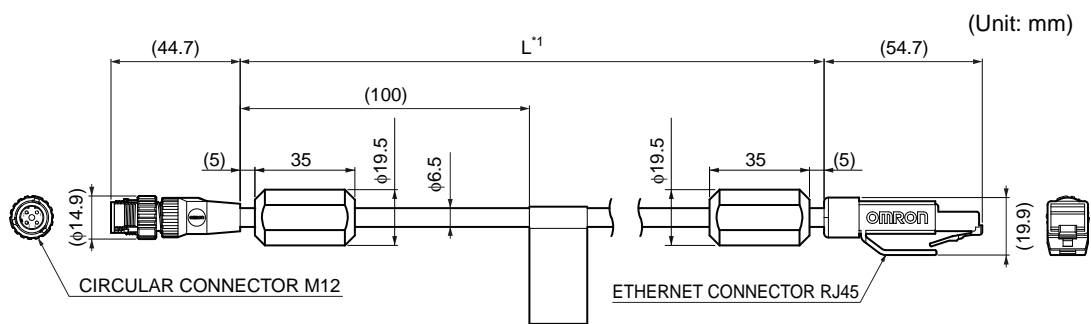

*1: The cable length is given in the following table.

Model	L
FQ-WN005	5 m
FQ-WN010	10 m

Angle: M12/Straight: RJ45
FQ-MWNL005/010

(Unit: mm)

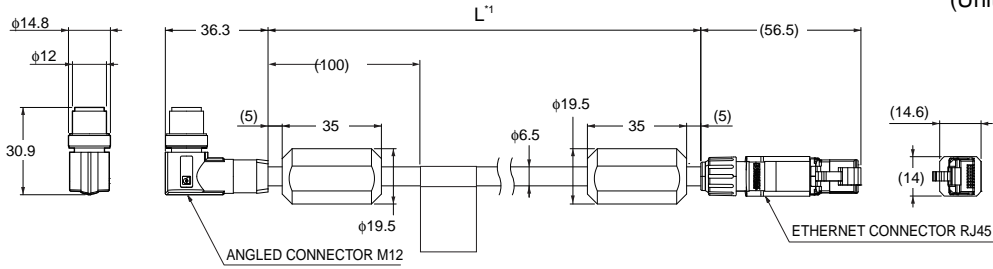

*1: The cable length is given in the following table.

Model	L
FQ-MWNL005	5 m
FQ-MWNL010	10 m

• For EtherCAT Cable

Straight type (M12/M12)

FQ-MWNE005/010

(Unit: mm)

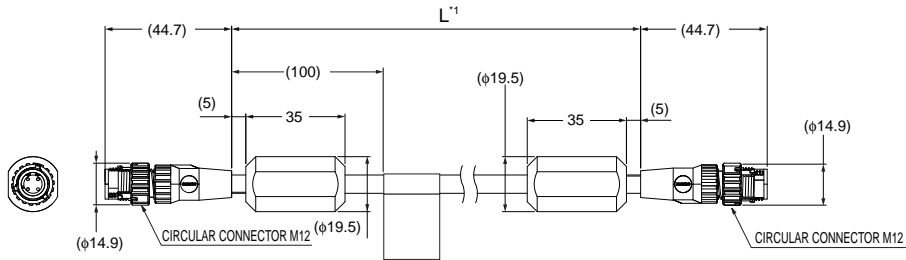

*1: The cable length is given in the following table.

Model	L
FQ-MWNE005	5 m
FQ-MWNE010	10 m

Angle type (M12/M12)

FQ-MWNEL005/010

(Unit: mm)

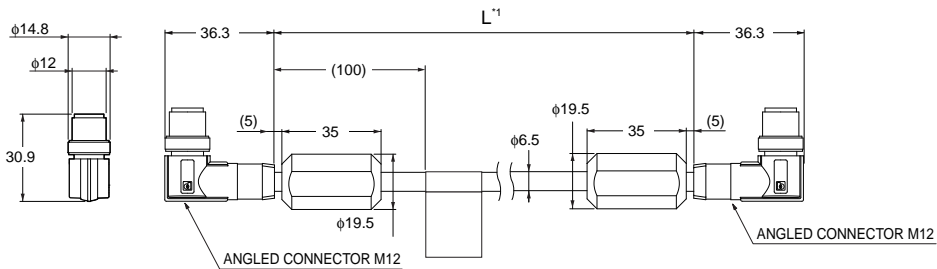

*1: The cable length is given in the following table.

Model	L
FQ-MWNEL005	5 m
FQ-MWNEL010	10 m

• I/O Cables

Straight type

FQ-MWD005/010

(Unit: mm)

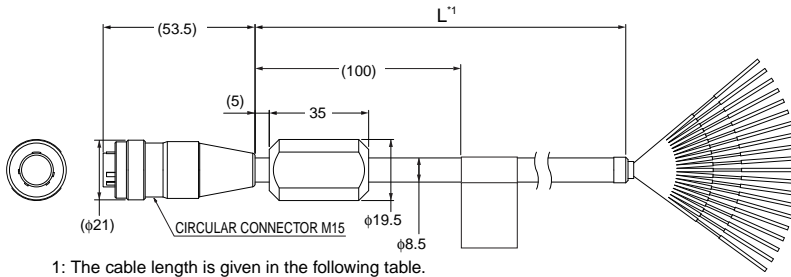

*1: The cable length is given in the following table.

Model	L
FQ-MWD005	5 m
FQ-MWD010	10 m

Angle type (M12/M12)

FQ-MWDL005/010

(Unit: mm)

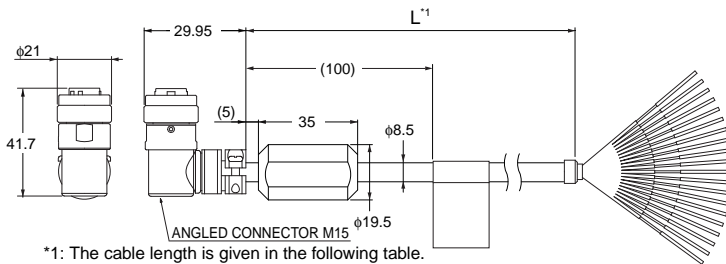

*1: The cable length is given in the following table.

Model	L
FQ-MWDL005	5 m
FQ-MWDL010	10 m

• AC Adapter

FQ-AC1

(Unit: mm)

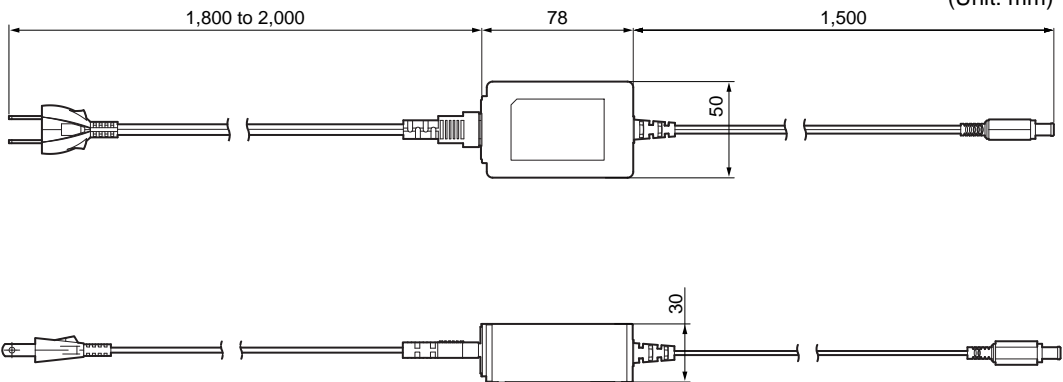

12-4 Upgrading Sensor and Touch Finder Firmware



Ask your OMRON representative for information on obtaining the most recent firmware versions.
After you obtain the more recent firmware, use the following procedure to update the firmware you are using.

• Updating from the Sysmac Studio

- ▶ **Multiview Explorer: Double-click the Sensor model.**
→ **Edit Pane: [Tool] – [Update firmware]**

1 Select the folder that contains the firmware data.

• Updating from the Touch Finder

- 1** Place the update file that you obtained directly in the root folder of the SD card.
- 2** Insert an SD card into the Touch Finder.
- 3** To update the software in the Sensor, press  (Setup Mode) - [Sensor settings] - [Update].
- 4** To update the software in the Touch Finder, press  (Setup Mode) - [TF settings] - [Update].

The software will be updated automatically.

Important

Do not turn OFF the power supply until updating the software has been completed.
The Sensor or Touch Finder may not start normally if power is turned OFF during the update.

12-5 Object Dictionary

Object Dictionary Area

The CAN application protocol over EtherCAT (CoE) protocol uses the object dictionary of CAN application protocol as its base. Each object is assigned with an index of four-digit hexadecimal value. The indexes are configured in the areas below.

Indexes	Area	Contents
0000 hex-0FFF hex	Data Type area	Definitions of data types
1000 hex-1FFF hex	CoE Communications area	Definitions of variables that can be used by all servers for designated communications
2000 hex-2FFF hex	Manufacturer Specific area 1	Variables defined for all OMRON products
3000 hex-5FFF hex	Manufacturer Specific area 2	Variables defined for FQ-M series EtherCAT Slave Units
6000 hex-9FFF hex	Device Profile area	Not supported
A000 hex-FFFF hex	Reserved area	Area reserved for future use

Data Types

This profile uses the following data types.

Data Types	Code	Size	Range
Boolean	BOOL	1 bit	true(1), false(0)
Unsigned8	U8	1 byte	0 to 255
Unsigned16	U16	2 bytes	0 to 65535
Unsigned32	U32	4 bytes	0 to 4294967295
Integer8	INT8	1 byte	-128 to 127
Integer16	INT16	2 bytes	-32768 to 32767
Integer32	INT32	4 bytes	-2147483648 to 2147483647
Visible string	VS	-	-

Object Description Format

In this manual, objects are described in the following format.

Object description format

<Index>	<Object name>		
Range: <Setting range>	Unit: <Unit>	Default: <Default setting>	Attribute: <Data attribute>
Size: <Size>	Access: <Access>	PDO map: <Possible/Not possible>	

Object description format with sub-indexes

<Index>	<Object name>		
Sub-index 0			
Range: <Setting range>	Unit: <Unit>	Default: <Default setting>	Attribute: <Data attribute>
Size: <Size>	Access: <Access>	PDO map: <Possible/Not possible>	
•			
•			
•			
Sub-index N			
Range: <Setting range>	Unit: <Unit>	Default: <Default setting>	Attribute: <Data attribute>
Size: <Size>	Access: <Access>	PDO map: <Possible/Not possible>	

The following values are indicated within the pointed brackets <>.

Indexes	An object index given by a four-digit hexadecimal number
Object name	The object name
Range	The possible range of settings
Unit	Physical unit
Default	Default value set before product shipment
Attribute	The timing when a change is updated in a writable object A: Always enabled B: Timing of count stop → operation (Encoder Input Slave Unit only) C: Timing of pre-operational state → safe-operational state D: Timing of pre-operational state → init state R: Updated after the power supply is reset -: Read only
Size	The object size is given in bytes
Access	Indicates whether the object is read only, or read and write RO: Read only RW: Read and write
PDO map	Indicates the PDO mapping possibility

Communication Objects

1000 hex	Device Type		
Range: –	Unit: –	Default: 00000000 hex	Attribute: –
Size: 4 bytes (U32)	Access: RO	PDO map: Not possible	

- The FQ-M Sensors do not have a device profile.

1001 hex	Error Register		
Range: –	Unit: –	Default: 00 hex	Attribute: –
Size: 1 byte (U8)	Access: RO	PDO map: Not possible	

- Indicates the error type that occurs in a Slave Unit.
- The error kind is allocated in each bit as follows.
It becomes "0:There is no error" and "1:The error is occurring".

Bits	Name	Bits	Name
0	Generic error	4	Communications error
1	Current error	5	Device profile specific error
2	Voltage error	6	(Reserved)
3	Temperature error	7	Manufacturer specific error

1008 hex	Manufacturer Device Name		
Range: –	Unit: –	Default: Differ by Slave Unit types*	Attribute: –
Size: 20 bytes (VS)	Access: RO	PDO map: Not possible	

- Indicates the Slave Unit model number.

1009 hex	Manufacturer Hardware Version		
Range: –	Unit: –	Default: Differ by Slave Unit types*	Attribute: –
Size: 20 bytes (VS)	Access: RO	PDO map: Not possible	

- Indicates the version of the Slave Unit hardware.

100A hex	Manufacturer Software Version		
Range: –	Unit: –	Default: Differ by Slave Unit types*	Attribute: –
Size: 20 bytes (VS)	Access: RO	PDO map: Not possible	

- Indicates the version of the Slave Unit software.

* The default settings of device type, device name, hardware version, and software version vary by the Slave Unit Types.

Model	Manufacture device name	Manufacture hardware version	Manufacture software version
FQ-MS120-ECT	FQ-MS12x-ECT	Space (20 hex) of 20 characters	"V1.00 " (Space (20 hex) of 15 characters)
FQ-MS125-ECT			
FQ-MS120-M-ECT	FQ-MS12x-M-ECT		
FQ-MS125-M-ECT			

1011 hex	Restore Default Parameters		
Sub-index 0: Number of entries			
Range: –	Unit: –	Default: 01 hex	Attribute: –
Size: 1 byte (U8)	Access: RO	PDO map: Not possible	
Sub-index 1: Restore Default Parameters			
Range: –	Unit: –	Default: 00000001 hex	Attribute: A
Size: 4 bytes (U32)	Access: RW	PDO map: Not possible	

- Resets the parameters to their default values.
- The parameter is reset only when a specific value is written to sub-index 1. This prevents parameter values from being accidentally overwritten.
- The specific value is "load".

MSB		LSB	
d	a	o	l
64 hex	61 hex	6F hex	6C hex

- The ABORT code is displayed if a value other than the specific is written.
- A value 0000 0001 hex (command valid) is indicated when reading.
- The FQ-M Sensors do not support this parameter.

1018 hex	Identity Object		
Sub-index 0: Number of entries			
Range: –	Unit: –	Default: 04 hex	Attribute: –
Size: 1 byte (U8)	Access: RO	PDO map: Not possible	
Sub-index 1: Vendor ID			
Range: –	Unit: –	Default: 00000083 hex	Attribute: –
Size: 4 bytes (U32)	Access: RO	PDO map: Not possible	
Sub-index 2: Product Code			
Range: –	Unit: –	Default: Differ by Slave Unit types*	Attribute: –
Size: 4 bytes (U32)	Access: RO	PDO map: Not possible	
Sub-index 3: Revision Number			
Range: –	Unit: –	Default: Differ by Slave Unit types*	Attribute: –
Size: 4 bytes (U32)	Access: RO	PDO map: Not possible	
Sub-index 4: Serial Number			
Range: –	Unit: –	Default: Each Unit	Attribute: –
Size: 4 bytes (U32)	Access: RO	PDO map: Not possible	

- Indicates the device information.
- Sub-index 1 (Vendor ID) gives the manufacturer identifier.
- Sub-index 2 (Product Code) gives the value assigned to each Slave Unit type.
- Sub-index 3 (Revision Number) gives the Unit revision number.
 - Bits 0 to 15: Minor revision number of the device
 - Bits 16 to 31: Major revision number of the device
- Sub-index 4 (Serial Number) gives a serial number for each product.
- For unit version 1.0, the serial number is always shown as 00000000 hex.

* The table below shows the identity object values by Slave Unit types.

Model	Product Code(hex)	Revision Number(hex)
FQ-MS120-ECT	00000062	00010000
FQ-MS125-ECT		
FQ-MS120-M-ECT	00000063	00010000
FQ-MS125-M-ECT		

10F3 hex	Diagnosis History		
Sub-index 0: Number of entries			
Range: –	Unit: –	Default: 0D hex	Attribute: –
Size: 1 byte (U8)	Access: RO	PDO map: Not possible	
Sub-index 1: Maximum Messages			
Range: –	Unit: –	Default: 00 hex	Attribute: –
Size: 1 byte (U8)	Access: RO	PDO map: Not possible	
Sub-index 2: Newest Message			
Range: –	Unit: –	Default: –	Attribute: –
Size: 1 byte (U8)	Access: RO	PDO map: Not possible	
Sub-index 5: Flags			
Range: 0000 hex- 0001 hex	Unit: –	Default: 0000 hex	Attribute: –
Size: 2 bytes (U16)	Access: RW	PDO map: Not possible	
Sub-index 6 to 13: Diagnosis Message 1-8			
Range: –	Unit: –	Default: –	Attribute: –
Size: 23 bytes (VS)	Access: RO	PDO map: Not possible	

- This object indicates up to 8 diagnosis histories. It also sets whether to notify emergency messages or not.
- Sub-index 1 (Maximum Messages) gives the number of error messages.
- Sub-index 2 (Newest Messages) gives the sub-index number the latest message in the diagnosis history.
- Sub-index 5 (Flags) is the control flag of diagnosis history. It specifies whether or not to notify error messages via emergency messages. Setting 0001 hex means to notify. It is set to 0001 hex (Emergency notify) when power is turned ON. At startup, the setting is 0000 hex (no emergency notification).
- Sub-indexes 6 to 13 (Diagnosis messages 1 to 8) indicate the diagnosis history.
From sub-index 6 (Diagnosis message 1) to sub-index 13 (Diagnosis message 8) are stored 8 errors. The 9th error and onward are stored from the sub-index 6 (Diagnosis message 1) again.
- The FQ-M Sensors support only the flags.

PDO Mapping Object

Indexes 1600 hex to 17FF hex are used for Receive PDO mapping, and indexes 1A00 hex to 1BFF hex are used for Transmit PDO mapping. Sub-indexes after sub-index 1 provide information about the application object being mapped.

31	16	15	8	7	0
Indexes			Sub Indexes		Bit length
MSB			LSB		

- Bits 0 to 7 : Bit length of the mapped object.
(For example, for 32 bits, 20 hex is given.)
- Bits 8 to 15 : Sub-index of the mapped object.
- Bits 16 to 31 : Index of the mapped object.

16FF hex	256th receive PDO Mapping		
Sub-index 0: Number of objects			
Range: –	Unit: –	Default: 01 hex	Attribute: –
Size: 1 byte (U8)	Access: RO	PDO map: Not possible	
Sub-index 1: 1st Output Object to be mapped			
Range: –	Unit: –	Default: 30000120 hex	Attribute: –
Size: 4 bytes (U32)	Access: RO	PDO map: Not possible	

- This object gives the mapping for an application that uses vision sensor functions.
- 3000h (Vision Control Flag) is mapped in 4 bytes.
- This object is excluded by 1700h (257th receive PDO Mapping)

1700 hex	257th receive PDO Mapping		
Sub-index 0: Number of objects			
Range: –	Unit: –	Default: 20 hex	
Size: 1 byte (U8)	Access: RO	PDO map: Not possible	
Sub-index 1-32: 1st-32th Output Object to be mapped			
Range: –	Unit: –	Default: 30000201-30002101 hex	
Size: 4 bytes (U32)	Access: RO	PDO map: Not possible	

- This object gives the mapping for an application that uses vision sensor functions.
- 3000h (Vision Control Flag) is mapped in 1 bit.
- This object is excluded by 16FFh (257th receive PDO Mapping)

1701 hex	258th receive PDO Mapping		
Sub-index 0: Number of objects			
Range: –	Unit: –	Default: 04 hex	
Size: 1 byte (U8)	Access: RO	PDO map: Not possible	
Sub-index 1: 1st Output Object to be mapped			
Range: –	Unit: –	Default: 30020020 hex	
Size: 4 byte (U32)	Access: RO	PDO map: Not possible	
Sub-index 2: 2nd Output Object to be mapped			
Range: –	Unit: –	Default: 30100120 hex	
Size: 4 byte (U32)	Access: RO	PDO map: Not possible	
Sub-index 3: 3rd Output Object to be mapped			
Range: –	Unit: –	Default: 30100220 hex	
Size: 4 byte (U32)	Access: RO	PDO map: Not possible	
Sub-index 4: 4th Output Object to be mapped			
Range: –	Unit: –	Default: 30100320 hex	
Size: 4 bytes (U32)	Access: RO	PDO map: Not possible	

- This object gives the mapping for an application that uses vision sensor functions.
- 3002h (Vision Command)
- 3010h (Vision Command Parameter1-3)

1AFF hex	256th transmit PDO Mapping		
Sub-index 0: Number of objects			
Range: –	Unit: –	Default: 01 hex	
Size: 1 byte (U8)	Access: RO	PDO map: Not possible	
Sub-index 1: 1st Input Object to be mapped			
Range: –	Unit: –	Default: 30010120 hex	
Size: 4 bytes (U32)	Access: RO	PDO map: Not possible	

- This object gives the mapping for an application that uses vision sensor functions.
- 3001h (Vision Status Flag) is mapped in 4 bytes.
- This object is excluded by 1B700h (257th transmit PDO Mapping)

1B00 hex	257th transmit PDO Mapping		
Sub-index 0: Number of objects			
Range: –	Unit: –	Default: 20 hex	
Size: 1 byte (U8)	Access: RO	PDO map: Not possible	
Sub-index 1-32: 1st-32th Output Object to be mapped			
Range: –	Unit: –	Default: 30010201-30012101 hex	
Size: 4 bytes (U32)	Access: RO	PDO map: Not possible	

- This object gives the mapping for an application that uses vision sensor functions.
- 3001h (Vision Status Flag) is mapped in 1 bit.
- This object is excluded by 1AFFh (256th transmit PDO Mapping)

1B01 hex	258th transmit PDO Mapping		
Sub-index 0: Number of objects			
Range: –	Unit: –	Default: 04 hex	
Size: 1 byte (U8)	Access: RO		PDO map: Not possible
Sub-index 1: 1st Output Object to be mapped			
Range: –	Unit: –	Default: 30030020 hex	
Size: 4 byte (U32)	Access: RO		PDO map: Not possible
Sub-index 2: 2nd Output Object to be mapped			
Range: –	Unit: –	Default: 30040020 hex	
Size: 4 byte (U32)	Access: RO		PDO map: Not possible
Sub-index 3: 3rd Output Object to be mapped			
Range: –	Unit: –	Default: 30050120 hex	
Size: 4 byte (U32)	Access: RO		PDO map: Not possible
Sub-index 4: 4th Output Object to be mapped			
Range: –	Unit: –	Default: 30060020 hex	
Size: 4 bytes (U32)	Access: RO		PDO map: Not possible

• This object gives the mapping for an application that uses vision sensor functions.

- 3003h (Vision Response)
- 3004h (Vision Response Code)
- 3005h (Vision Response Data1)
- 3006h (Vision Extended Data)

1B02 hex	259th transmit PDO Mapping		
Sub-index 0: Number of objects			
Range: –	Unit: –	Default: 08 hex	
Size: 1 byte (U8)	Access: RO		PDO map: Not possible
Sub-index 1-8: 1st-8th Input Object to be mapped			
Range: –	Unit: –	Default: 30200120-30200820 hex	
Size: 4 bytes (U32)	Access: RO		PDO map: Not possible

• This object gives the mapping for an application that uses vision sensor functions.

- 3020h (Vision Data Output1-8)

1B03 hex	260th transmit PDO Mapping		
Sub-index 0: Number of objects			
Range: –	Unit: –	Default: 08 hex	
Size: 1 byte (U8)	Access: RO		PDO map: Not possible
Sub-index 1-8: 1st-8th Input Object to be mapped			
Range: –	Unit: –	Default: 30200920-30201020 hex	
Size: 4 bytes (U32)	Access: RO		PDO map: Not possible

• This object gives the mapping for an application that uses vision sensor functions.

- 3020h (Vision Data Output9-16)
- This object is excluded by 1B04h (261th transmit PDO Mapping) and 1B05h (262th transmit PDO Mapping)

1B04 hex	261th transmit PDO Mapping		
Sub-index 0: Number of objects			
Range: –	Unit: –	Default: 18 hex	
Size: 1 byte (U8)	Access: RO		PDO map: Not possible
Sub-index 1-24: 1st-24th Input Object to be mapped			
Range: –	Unit: –	Default: 30200920-30202020 hex	
Size: 4 bytes (U32)	Access: RO		PDO map: Not possible

• This object gives the mapping for an application that uses vision sensor functions.

- 3020h (Vision Data Output9-32)
- This object is excluded by 1B03h (260th transmit PDO Mapping) and 1B05h (262th transmit PDO Mapping)

1B05 hex	262th transmit PDO Mapping		
Sub-index 0: Number of objects			
Range: –	Unit: –	Default: 38 hex	
Size: 1 byte (U8)	Access: RO	PDO map: Not possible	
Sub-index 1-56: 1st-56th Input Object to be mapped			
Range: –	Unit: –	Default: 30200920-30204020 hex	
Size: 4 bytes (U32)	Access: RO	PDO map: Not possible	

- This object gives the mapping for an application that uses vision sensor functions.
- 3020h (Vision Data Output9-64)
- This object is excluded by 1B03h (260th transmit PDO Mapping) and 1B04h (261th transmit PDO Mapping)

1BFF hex	512th transmit PDO Mapping		
Sub-index 0: Number of objects in this PDO			
Range: –	Unit: –	Default: 01 hex	Attribute: –
Size: 1 byte (U8)	Access: RO	PDO map: Not possible	
Sub-index 1: 1st Input Object to be mapped			
Range:–	Unit: –	Default: 20020108 hex	Attribute: –
Size: 4 bytes (U32)	Access: RO	PDO map: Not possible	

- This object gives the mapping for notification of errors that are detected in the Slave Unit.
- The mapping includes 2002 hex-01 hex (Sysmac Error Status).
- When connected to an NJ-series Machine Automation Controller, 1C13 hex (Sync manager 3 PDO assignment) is assigned to this object.

This object is automatically assigned in the default settings of the Sysmac Studio.

Sync Manager Communication Object

The communication memory of EtherCAT is set by the objects from 1C00 hex to 1C13 hex.

1C00 hex	Sync Manager Communication Type		
Sub-index 0: Number of used SM channels			
Range: –	Unit: –	Default: 04 hex	Attribute: –
Size: 1 byte (U8)	Access: RO	PDO map: Not possible	
Sub-index 1: Communication Type Sync Manager 0			
Range: –	Unit: –	Default: 01 hex	Attribute: –
Size: 4 bytes (U8)	Access: RO	PDO map: Not possible	
Sub-index 2: Communication Type Sync Manager 1			
Range: –	Unit: –	Default: 02 hex	Attribute: –
Size: 4 bytes (U8)	Access: RO	PDO map: Not possible	
Sub-index 3: Communication Type Sync Manager 2			
Range: -	Unit: -	Default: 03 hex	Attribute: -
Size: 4 bytes (U8)	Access: RO	PDO map: Not possible	
Sub-index 4: Communication Type Sync Manager 3			
Range: -	Unit: -	Default: 04 hex	Attribute: -
Size: 4 bytes (U8)	Access: RO	PDO map: Not possible	

- The sync manager has the following settings.
 - SM0: Mailbox receive (EtherCAT Master Unit to Slave Unit)
 - SM1: Mailbox transmit (EtherCAT Slave Unit to Master Unit)
 - SM2: Process data output (EtherCAT Master Unit to Slave Unit)
 - SM3: Process data input (EtherCAT Slave Unit to Master Unit)

1C10 hex	Sync Manager 0 PDO Assignment		
Sub-index 0: Number of assigned PDOs			
Range: 00 hex	Unit: –	Default: 00 hex	Attribute: –
Size: 1 byte (U8)	Access: RO	PDO map: Not possible	

- It indicates the number of PDO mappings used by this sync manager.
- Mailbox reception sync manager does not have PDOs.

1C11 hex	Sync Manager 1 PDO Assignment		
Sub-index 0: Number of assigned PDOs			
Range: 00 hex	Unit: –	Default: 00 hex	Attribute: –
Size: 1 byte (U8)	Access: RO	PDO map: Not possible	

- It indicates the number of PDO mappings used by this sync manager.
- Mailbox transmit sync manager does not have PDOs.

1C12 hex	Sync Manager 2 PDO Assignment		
Sub-index 0: Number of assigned PDOs			
Range: –	Unit: –	Default: 02 hex	Attribute: –
Size: 1 byte (U8)	Access: RW*	PDO map: Not possible	
Sub-index 1-2: 1st-2nd PDO Mapping Object Index of assigned 2nd PDO			
Range: –	Unit: –	Default: Differ by Slave Unit types*	Attribute: –
Size: 2 bytes (U16)	Access: RW*	PDO map: Not possible	

- If a receive PDO is not provided, R0 is used.
- It indicates the RxPDOs used by this sync manager.

1C13 hex	Sync Manager 3 PDO Assignment		
Sub-index 0: Number of assigned PDOs			
Range: –	Unit: –	Default: 05 hex	Attribute: –
Size: 1 byte (U8)	Access: RW*	PDO map: Not possible	
Sub-index 1-5: 1st-5th PDO Mapping Object Index of assigned PDO			
Range: –	Unit: –	Default: Differ by Slave Unit types*	Attribute: –
Size: 2 bytes (U16)	Access: RW*	PDO map: Not possible	

* "RO" is set if there is no TxPDO.

- It indicates the TxPDOs used by this sync manager.

* The default settings for Sync Manager 2 PDO Assignment and Sync Manager 3 PDO Assignment are different for OMRON software and software from other companies. The default settings are given in the following table.

• Default Settings for Sysmac Studio (NJ Series)

Model	FQ-MSxxx-x-ECT (all of models)		
Sync manager 2 PDO assignment (hex)	Number of assignment RxPDO		02 hex
	Assigned PDO	1	16FF hex (256th receive PDO Mapping)
		2	1701 hex (258th receive PDO Mapping)
Sync manager 3 PDO assignment (hex)	Number of assignment RxPDO		04 hex
	Assigned PDO	1	1AFF hex (256th transmit PDO Mapping)
		2	1B01 hex (258th transmit PDO Mapping)
		3	1B02 hex (259th transmit PDO Mapping)
		4	---
		5	1BFF hex (512th transmit PDO Mapping)

There is normally no reason to change the default settings.

To transfer more than 32 bytes of data (4 bytes × 8 data items) at the same time from the FQ-M Sensor to an NJ-series Controller, change the following PDO mapping settings.

(The default setting can be used to separate the data and transfer it in more than one transfer operation from the FQ-M to the NJ-series Controller using handshaking.)

Model	FQ-MSxxx-x-ECT (all of models)	
Sync manager 2 PDO assignment (Hex)	Number of assignment RxPDO	02Hex
	Assigned RxPDO	1 16FFHex (256th receive PDO Mapping)
		2 1701Hex (258th receive PDO Mapping)
Sync manager 3 PDO assignment (Hex)	Number of assignment RxPDO	04Hex
	Assigned RxPDO	1 1AFFHex (256th transmit PDO Mapping)
		2 1B01Hex (258th transmit PDO Mapping)
		3 1B02Hex (259th transmit PDO Mapping)
		4 -
		5 1BFFHex (512th transmit PLU Mapping)
14 -		

assigned PDO	Size of output data from FQ-M
---	32bytes(4bytes * 8data)
1B03 hex (260th transmit PDO Mapping)	64bytes(4bytes * 16data)
1B04 hex (261st transmit PDO Mapping)	128bytes(4bytes * 32data)
1B05 hex (262nd transmit PDO Mapping)	256bytes(4bytes * 64data)

• **Default Settings for CX-Programmer (CJ Series with Position Control Unit (NC8□□))**

Model	FQ-MSxxx-x-ECT (all of models)	
Sync manager 2 PDO assignment (hex)	Number of assignment RxPDO	02 hex
	Assigned PDO	1 16FF hex (256th receive PDO Mapping)
		2 1701 hex (258th receive PDO Mapping)
Sync manager 3 PDO assignment (hex)	Number of assignment RxPDO	03 hex
	Assigned PDO	1 1AFF hex (256th transmit PDO Mapping)
		2 1B01 hex (258th transmit PDO Mapping)
		3 1B02 hex (259th transmit PDO Mapping)
		4 ---
		5 ---

The default settings cannot be changed with the CX-Programmer.

To transfer more than 32 bytes of data (4 bytes × 8 data items) from the FQ-M Sensor to an CJ-series Controller, separate the data and transfer it in more than one transfer operation by using handshaking.

• **Software from Other Companies**

Model	FQ-MSxxx-x-ECT (all of models)	
Sync manager 2 PDO assignment (hex)	Number of assignment RxPDO	02 hex
	Assigned PDO	1 1700 hex (257th receive PDO Mapping)
		2 1701 hex (258th receive PDO Mapping)
Sync manager 3 PDO assignment (hex)	Number of assignment RxPDO	03 hex
	Assigned PDO	1 1B00 hex (257th transmit PDO Mapping)
		2 1B01 hex (258th transmit PDO Mapping)
		3 1B02 hex (259th transmit PDO Mapping)
		4 ---
		5 ---

To transfer more than 32 bytes of data (4 bytes × 8 data items) from the FQ-M Sensor to an EtherCAT master, separate the data and transfer it in more than one transfer operation by using handshaking.

Model	FQ-MSxxx-x-ECT (all of models)	
Sync manager 2 PDO assignment (Hex)	Number of assignment RxPDO	02Hex
	Assigned PDO	1 1700Hex (257h receive PDO Mapping)
		2 1701Hex (258th receive PDO Mapping)
Sync manager 3 PDO assignment (Hex)	Number of assignment RxPDO	03Hex
	Assigned PDO	1 1B00Hex (257h transmit PDO Mapping)
		2 1B01Hex (258th transmit PDO Mapping)
		3 1B02Hex (259th transmit PDO Mapping)
		4 -
		5 -
14 -		

assigned PDO	Size of output data from FQ-M
---	32bytes(4bytes * 8data)
1B03 hex (260th transmit PDO Mapping)	64bytes(4bytes * 16data)
1B04 hex (261st transmit PDO Mapping)	128bytes(4bytes * 32data)
1B05 hex (262nd transmit PDO Mapping)	256bytes(4bytes * 64data)

Manufacturer Specific Objects

This section explains the CiA401 generic I/O module device profile implemented in FQ-M-series EtherCAT Slave Units and the objects specially mounted in FQ-M-series EtherCAT Slave Units.

Common Objects for Sysmac Devices

• Manufacturer Specific area 1

2100 hex	Error History Clear		
Range: –	Unit: –	Default: 00000000 hex	Attribute: A
Size: 4 bytes (U32)	Access: RW	PDO map: Not possible	

- This object clears diagnosis history of 10F3 hex (Diagnosis History).
- It clears the history only when specific values are written. The specific value is "elcl".

MSB			LSB
l	c	l	e
6C hex	63 hex	6C hex	65 hex

Writing values other than this is invalid.

2002 hex	Sysmac Error		
Sub-index 0: Number of entries			
Range: –	Unit: –	Default: 02 hex	Attribute: –
Size: 1 byte (U8)	Access: RO	PDO map: Not possible	
Sub-index 1: Sysmac Error Status			
Range: –	Unit: –	Default: 00 hex	Attribute: –
Size: 1 byte (U8)	Access: RO	PDO map: Possible	
Sub-index 2: Sysmac Error Status Clear			
Range: –	Unit: –	Default: 00 hex	Attribute: A
Size: 1 byte (U8)	Access: RW	PDO map: Not possible	

- The mapping is used for Sysmac error status notification and to clear Sysmac error status.
- Sub-index 1: Sysmac Error Status
 - This object is for notification of errors that are detected in the Slave Unit.
 - When connected to an NJ-series Machine Automation Controller, map this object to a PDO.
- Sub-index 2: Sysmac Error Status Clear
 - This object is used by the Controller (a Sysmac device) to reset errors that occur in Slave Units.

Note

In the default Sysmac Studio settings, sub-index 1 (Sysmac Error Status) is automatically mapped to a PDO because 1BFF hex (512th transmit PDO Mapping) is assigned.

2200 hex	Communication Error Setting		
Range: 00 hex to 0F hex	Unit: number of sequences	Default: 01 hex	Attribute: C
Size: 1 byte (U8)	Access: RW	PDO map: Not possible	

- Object mounted only on Slave Units operating in the DC mode.
- The number of sequences for detecting communications errors is set with this object.
- The setting range is from 00 to 0F hex and the number of detections is "the set number of times + 1."
- Rewriting value is possible at operation in the DC mode, but the operation is performed with the value set when shifting from the pre-operational state to safe-operational state. Note that at this point, the rewritten value is read.

Note

With the default setting of 01 hex, an error is detected if communications errors occur twice in a row.

2201 hex	Sync Not Received Timeout Setting		
Range: 0000 hex to 0258 hex	Unit: s	Default: 0000 hex	Attribute: C
Size: 2 bytes (U16)	Access: RW	PDO map: Not possible	

- Object mounted only on Slave Units operating in the DC mode.
- This object is used to set the standby time until the first synchronization interrupt signal (SYNC0) is input after shifting to the safe-operational state (state where a DC mode is confirmed).
- If the first interrupt signal (SYNC0) is not input at all within this setting time, a synchronization error occurs.
- The setting range is from 0000 hex to 0258 hex (600s) and operation is performed at 120s when 0000 hex is set.
- Rewriting value is possible at operation in the DC mode, but the operation is performed with the value set when shifting from the pre-operational state to safe-operational state. Note that at this point, the rewritten value is read.

Vision Sensor Specific Objects

• Manufacturer Specific area 2

3000 hex	Vision Control Flag		
Sub-index 0: Number of entries			
Range: –	Unit: –	Default: 21 hex	
Size: 1 byte (U8)	Access: RO	PDO map: Not possible	
Sub-index 1: Vision Control Flag			
Range: –	Unit: –	Default: 00000000 hex	
Size: 4 byte (U32)	Access: RW	PDO map: Possible	
Sub-index 2: EXE Bit			
Range: True(1) or False(0)	Unit: –	Default: False(0)	
Size: 1 bit (BOOL)	Access: RW	PDO map: Possible	
Sub-index 3: TRIG Bit			
Range: True(1) or False(0)	Unit: –	Default: False(0)	
Size: 1 bit (BOOL)	Access: RW	PDO map: Possible	
Sub-index 4-16: Control Reserve Bit02-14			
Range: True(1) or False(0)	Unit: –	Default: False(0)	
Size: 1 bit (BOOL)	Access: RW	PDO map: Possible	
Sub-index 17: ERCLR Bit			
Range: True(1) or False(0)	Unit: –	Default: False(0)	
Size: 1 bit (BOOL)	Access: RW	PDO map: Possible	
Sub-index 18: DSA Bit			
Range: True(1) or False(0)	Unit: –	Default: False(0)	
Size: 1 bit (BOOL)	Access: RW	PDO map: Possible	
Sub-index 19-33: Control Reserve Bit17-31			
Range: True(1) or False(0)	Unit: –	Default: False(0)	
Size: 1 bit (BOOL)	Access: RW	PDO map: Possible	

- This object gives the control for vision sensor functions.
- EXE bit: Turn this on to execute the commands.
- TRIG bit: Turn this on to execute the measurement.
- ERCLR bit: Turn this on to clear the ERR bit (3001h Sub-index17).
- DSA bit: Turn this on to request the output data.
- If the Sysmac Studio or CX-Programmer is used, a subindex of 1 is mapped, including all bits of EXE, TRIG, ERCLR, and DSA.

3001 hex	Vision Status Flag		
Sub-index 0: Number of entries			
Range: –	Unit: –	Default: 21 hex	
Size: 1 byte (U8)	Access: RO	PDO map: Not possible	
Sub-index 1: Vision Status Flag			
Range: –	Unit: –	Default: *differ by the status when starting	
Size: 4 byte (U32)	Access: RO	PDO map: Possible	
Sub-index 2: FLG Bit			
Range: True(1) or False(0)	Unit: –	Default: False(0)	
Size: 1 bit (BOOL)	Access: RO	PDO map: Possible	
Sub-index 3: BUSY Bit			
Range: True(1) or False(0)	Unit: –	Default: *differ by the status when starting	
Size: 1 bit (BOOL)	Access: RO	PDO map: Possible	
Sub-index 4: READY Bit			
Range: True(1) or False(0)	Unit: –	Default: *differ by the status when starting	
Size: 1 bit (BOOL)	Access: RO	PDO map: Possible	
Sub-index 5: OR Bit			
Range: True(1) or False(0)	Unit: –	Default: False(0)	
Size: 1 bit (BOOL)	Access: RO	PDO map: Possible	
Sub-index 6: RUN Bit			
Range: True(1) or False(0)	Unit: –	Default: *differ by the status when starting	
Size: 1 bit (BOOL)	Access: RO	PDO map: Possible	
Sub-index 7-16: Control Reserve Bit05-14			
Range: True(1) or False(0)	Unit: –	Default: False(0)	
Size: 1 bit (BOOL)	Access: RO	PDO map: Possible	
Sub-index 17: ERR Bit			
Range: True(1) or False(0)	Unit: –	Default: *differ by the status when starting	
Size: 1 bit (BOOL)	Access: RO	PDO map: Possible	
Sub-index 18: GATE Bit			
Range: True(1) or False(0)	Unit: –	Default: False(0)	
Size: 1 bit (BOOL)	Access: RO	PDO map: Possible	
Sub-index 19-33: Control Reserve Bit17-31			
Range: True(1) or False(0)	Unit: –	Default: False(0)	
Size: 1 bit (BOOL)	Access: RO	PDO map: Possible	

- This object gives the status for vision sensor functions.
- FLG bit: This is turned on when the command is completed.
- BUSY bit: This is turned on when the controller is measuring or the command is executed.
- READY bit: This is turned on when the TRIG signal can be input.
- OR bit: This is turned on when the overall judgment result is NG.
- RUN bit: This is turned on when the controller is RUN mode.
- ERR bit: This is turned on when the controller error is detected.
- GATE bit: This is turned on when the data output is completed.
- If the Sysmac Studio or CX-Programmer is used, a subindex of 1 is mapped, including all bits of FLG, BUSY, READY, OR, RUN, ERR, and GATE.

3002 hex	Vision Command		
Range: –	Unit: –	Default: 00000000 hex	
Size: 4 byte (U32)	Access: RW	PDO map: Possible	

- Stores the command code such as "Change scene".

3003 hex	Vision Response		
Range: –	Unit: –	Default: 00000000 hex	
Size: 4 byte (U32)	Access: RO	PDO map: Possible	

- The executed command code is stored.

3004 hex	Vision Response Code		
Range: –	Unit: –	Default: 00000000 hex	
Size: 4 byte (U32)	Access: RO	PDO map: Possible	
• The response code is stored when the command is completed. (OK: 00000000 hex, NG: FFFFFFFF hex)			
3005 hex	Vision Response Data		
Sub-index 0: Number of entries			
Range: –	Unit: –	Default: 01 hex	
Size: 1 byte (U8)	Access: RO	PDO map: Not possible	
Sub-index 1: Vision Response Data1			
Range: –	Unit: –	Default: 00000000 hex	
Size: 4 byte (INT32)	Access: RO	PDO map: Possible	
• The response data is stored the command is completed. (e.g. the scene number is stored when the command "Get scene number".)			
3006 hex	Vision Extended Data		
Range: –	Unit: –	Default: 00000000 hex	
Size: 4 byte (INT32)	Access: RO	PDO map: Possible	
• This object is not supported.			
3010 hex	Vision Command Parameter		
Sub-index 0: Number of entries			
Range: –	Unit: –	Default: 01 hex	
Size: 1 byte (U8)	Access: RO	PDO map: Not possible	
Sub-index 1: Vision Command Parameter1			
Range: –	Unit: –	Default: 00000000 hex	
Size: 4 byte (U32)	Access: RW	PDO map: Possible	
Sub-index 2: Vision Command Parameter2			
Range: –	Unit: –	Default: 00000000 hex	
Size: 4 byte (U32)	Access: RW	PDO map: Possible	
Sub-index 3: Vision Command Parameter3			
Range: –	Unit: –	Default: 00000000 hex	
Size: 4 byte (INT32)	Access: RW	PDO map: Possible	
• Store the parameter of the command. (e.g. the scene number is stored when the command "Switch scene".)			
3020 hex	Vision Data Output		
Sub-index 0: Number of entries			
Range: –	Unit: –	Default: 40 hex	
Size: 1 byte (U8)	Access: RO	PDO map: Not possible	
Sub-index 1-64: Vision Data Output1-64			
Range: –	Unit: –	Default: 00000000 hex	
Size: 4 byte (INT32)	Access: RO	PDO map: Possible	
• The output data are stored.			

Index

A	
AC Adapter	442
AC power supply connector	
Touch Finder	31
adjusting judgement parameters	
during operation	176
all region	172
all results/region	171
all sensor data	206
auto connect	51
auto display	154, 157, 173, 175

B	
backing up Sensor data to an external file	204
basic troubleshooting	391
battery	46
battery remaining	212
BKD	61, 204, 206
BMP	206
Brightness adjust	74
brightness level	190
BUSY	41
BUSY polarity	
BUSY: ON	222
READY: ON	222
BUSY signal	214

C	
calculation	138
calibration	346
calibration data	204
calibration for conveyor tracking	347
calibration group data	204
calibration scene data	61
calibration scene group data	61
camera input	172
candidate level	130
captured images	206
capturing the currently visible display	209
CGP	61, 204
change the line process	180
changing scene names	182
changing the BUSY signal output condition	222
changing the file format	202
checking a list of all inspection item results	160
checking Sysmac error status	383
checking the error histories	389
checking versions	210
CLB	61, 204
clearing the error histories	389
clearing the Sysmac error status	383
C-mount lens fitting	29
color palette	114
color palette	117
COM_I	40

common terminal	41
COM_O	41
copying scenes	182
correcting the touch screen positions	
of the Touch Finder	212
correlation	88, 90, 125, 127
count	129
CSV	206

D	
DC power supply connector	
Touch Finder	31
decimal symbol	193
deleting logged data	203
deleting scenes	182
dimensions	428
direct input	368
display language	212
display pattern	172
display range	154, 157, 174, 175

E	
ECAT ERROR	29
ECAT RUN	29
ECO mode	190
edge threshold	108
Edit Pane	55
EFC RST	40
ENCODER	40
encoder input	339
ERROR	29, 41
ERROR CLR	40
error descriptions	384
error history	388
error messages	390
ERROR Signal	224
errors in teaching	
edge position	112
labeling	124
search	104
shape search	137
errors stored in the error history	388
ESI specification	265
EtherCAT	228
EtherCAT input connector	29
EtherCAT operation indicators	29
EtherCAT output connector	29
EtherCAT telegram	229
Ethernet connector	29
Ethernet port	
Touch Finder	31
ETN	29
Explorer Pane	53
exportable and importable file types	61
exporting projects	59
external lighting	73, 81
external reference parameters	412
external trigger	215

F	
field separator	193
file format	197, 202
file logging	191
focus	69
formatting SD cards	207
frozen image	185
function list	394

G	
general-purpose calibration	356
general-purpose Ethernet cable	28
GND	40
GND ENCODER	40
graphics	171
graphics + details	171
grip area level	97, 133
grip interference check	96, 132
guide lines	72, 189

H	
HDR function	76
help	211
hiding the menu	190
high dynamic range	76
histogram	155, 171, 174

I	
I/O Cable	40
I/O connector	29
icons	56
IFZ	206
image data	191, 206
image input speed	159
image zoom	183
images	
displaying last NG image	187
importing projects	60
individual judgement	218
initializing	210
inspection items	84
deletion	87
edge position	105
labeling	113
registration	86
search	88
shape search	125
installing the Sensor	32
installing the Sysmac Studio	48

L	
L/A IN	29
L/A OUT	29
labeling condition	120
language	212
LCD backlight	190
lens models	34
lens selection	33
level output	221
lighting connector	29
lighting control	225
live image	184

logging	191
---------	-----

M	
macro rings	35
Main Window	52
masking	101
measurement data	191
measurement process operation indicators	29
measurement region	102, 135
measurement takt time	158
measurement trigger	79
menu bar	52
model	88, 125
mounting	
control panel	37
DIN Track	37
mounting holes	29
MSD	204, 206
multi-point output	93

N	
node address setting switches	29
No-protocol	296
no-protocol command	305
NPN	42
number of data	154, 157, 174, 175

O	
object dictionary	447
offline debugging	376
offline setup	372
offline simulation	375
one-shot output	221
One-shot output delay	221
operation	163
operation indicators	
CHARGE	31
ERROR	31
POWER	31
SD ACCESS	31
Touch Finder	31
OR	29, 41
OR signal	214
OUT0	41
OUT1	41
OUT2	41
OUT3	41
OUT4	41
output mode	221
output polarity	222
NG: ON	222
OK: ON	222
output time	221
overall judgement	217

P	
Panel Mounting Adapter	438
mounting	37
panorama display	170
parallel I/O	214
password	208
PC Tool	28

PLC Link	266	shutter output	41
PNP	42	shutter speed and brightness of	
position compensation	172	the Sensor	74
power supply switch		SMC	61
Touch Finder	31	Special EtherCAT Cable	28
preventing mutual interference of		specifications	428
multiple Sensors	82	starting a project	49
printing a calibration pattern	70	starting and stopping logging	193
programmable no-protocol		startup display	172
communications	325	startup mode	182
project data	61	startup scene	182
R		statistical data	171, 202
recent results logging	199	statistical data and measurement data	206
re-measuring	151	STGOUT	41
remove duplication	95, 121, 131	STGOUT signal	225
resetting the ring counter value	227	straps	38
restarting	210	Strobe Controller mounting holes	29
Robot Controller	28	strobe trigger output	41
rotation range	98, 134	Switching Hub	28
Run Mode	58	SYD	61, 204, 206
Run Mode display	164	Sysmac device	264
S		Sysmac error status	264, 382
saved image	186	Sysmac Studio Standard Edition	28
saving a project	59	Sysmac Studio Vision Edition	28
saving data	161	system configuration	26
saving the node address setting	264	T	
scene data	61, 204, 206	test measurements	
scene group data	61, 204, 206	performing	150
scenes	180	toolbar	52
changing scene names	182	toolbox	52
copying scenes	182	Touch Finder data	204, 206
deleting scenes	182	trend monitor	152, 171, 173
SCN	61, 204, 206	TRIG	40
SD card		TRIG signal	214
available space	207	U	
formatting	207	updating	446
information	207	updating the display and measurement	
slot	31	results for NG measurement results	187
selecting a Sensor for configuration	64	user interface	52
selecting the data to log	201	V	
Sensor all data	61	VDD ENCODER	40
Sensor all information	204	W	
Sensor monitor	172	white balance	78
Sensor name	210	wiring	40
Sensor system data	61, 204, 206	Touch Finder	45
serial number display	265		
setting the data to log	192		
setting the data to output automatically			
after measurements	235, 273, 299, 329		
setting the time on the Touch Finder	212		
setting up EtherCAT communications	234		
setting up no-protocol communications	297		
setting up PLC Link communications	270		
setting up programmable no-protocol			
communications	326		
Setup Mode	58		
returning to Setup Mode	167		
SGP	61, 204, 206		
SHIELD ENCODER	40		
SHTOUT	41		

Revision History

A manual revision code appears as a suffix to the catalog number at the bottom of the front and back covers of this manual.

Cat. No. Z314-E1-03

↑
Revision code

Revision code	Date	Revised contents
01	October 2011	Original production
01A	March 2012	Minor corrections
02	August 2012	Added a grip interference check and other functions compatible with Ver. 1.50
03	December 2013	Minor corrections for compatibility with Windows 8

MEMO

OMRON Corporation Industrial Automation Company

Tokyo, JAPAN

Contact: www.ia.omron.com

Regional Headquarters

OMRON EUROPE B.V.

Wegalaan 67-69-2132 JD Hoofddorp
The Netherlands

Tel: (31)2356-81-300/Fax: (31)2356-81-388

OMRON ELECTRONICS LLC

One Commerce Drive Schaumburg,
IL 60173-5302 U.S.A.

Tel: (1) 847-843-7900/Fax: (1) 847-843-7787

OMRON ASIA PACIFIC PTE. LTD.

No. 438A Alexandra Road # 05-05/08 (Lobby 2),
Alexandra Technopark,
Singapore 119967

Tel: (65) 6835-3011/Fax: (65) 6835-2711

OMRON (CHINA) CO., LTD.

Room 2211, Bank of China Tower,
200 Yin Cheng Zhong Road,
PuDong New Area, Shanghai, 200120, China

Tel: (86) 21-5037-2222/Fax: (86) 21-5037-2200

Authorized Distributor:

© OMRON Corporation 2011 All Rights Reserved.
In the interest of product improvement,
specifications are subject to change without notice.

Cat. No. Z314-E1-03

1213