

NEW

OMRON

Safety Guard Switching Unit G9SX-GS



Making Hazardous Operations Safe and Productive

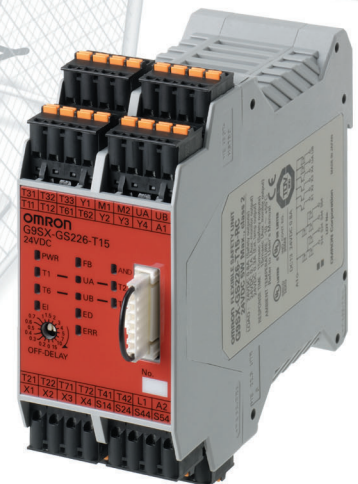

realizing

Making Hazardous Operations Safe and Productive

This new addition to the model of Flexible Safety Unit G9SX series makes it easier to build in safety and protection for **hazardous operations required on production sites.**

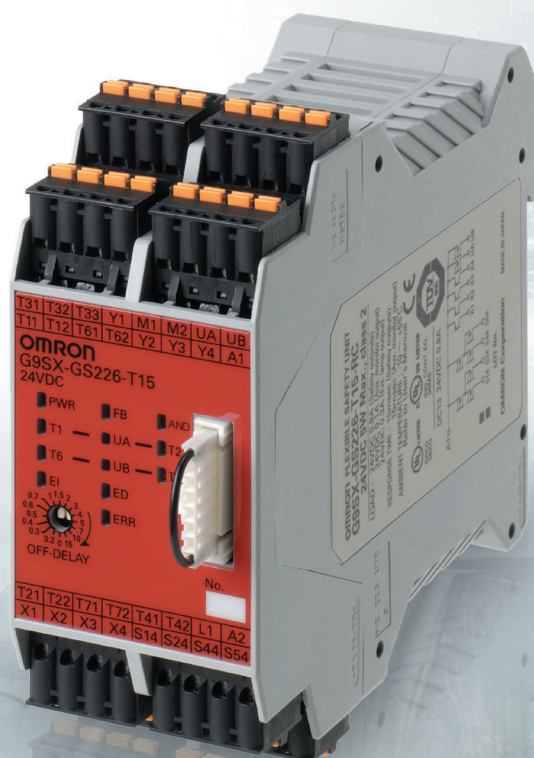

The guiding principle in providing safety for operators is to physically separate operators from the machinery. In actual practice, however, there are many cases where operators must work close to an operating machine. This sets the scene for accidents to occur.

In these cases, the G9SX-GS supports both safety and productivity.

Do you have these hazardous operations?

Case1: Coordinated operation of worker and machine

During production work, what kind of safety measures should be used when an operator works together with a machine?

The key → Auto Switching Function

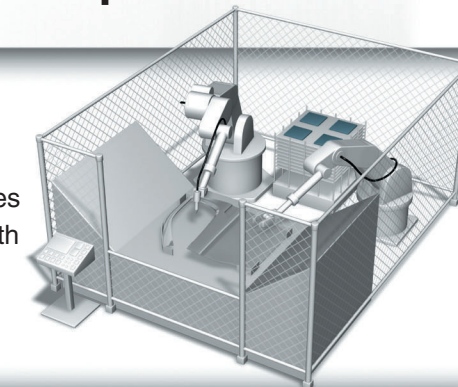

Case2: Limited operation

During maintenance and setup work, it is sometimes necessary to operate a machine with the protective door open. What kind of safety measures should be used?

The key → Manual Switching Function

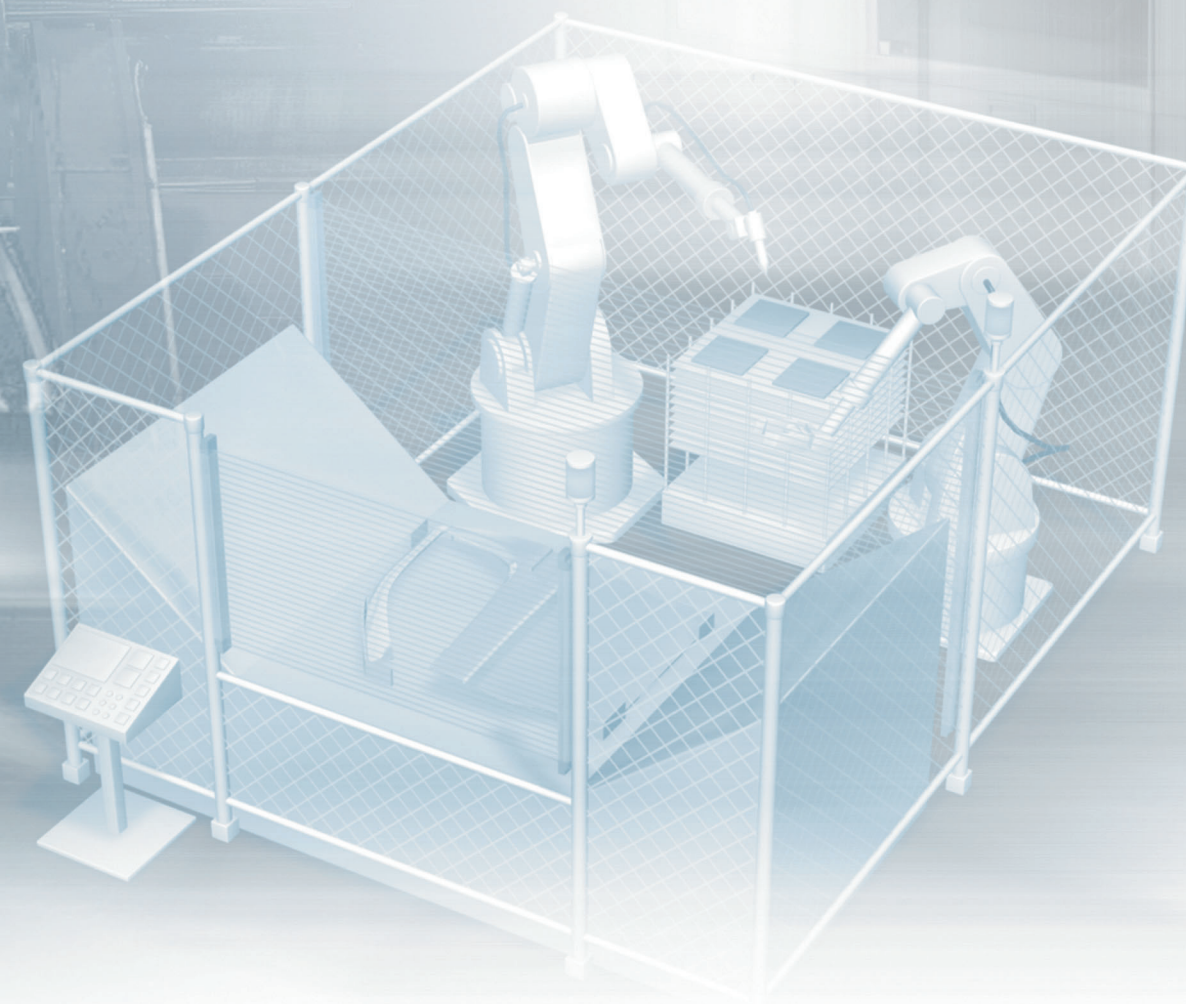

Case1: Coordinated operation of worker and machine

Auto Switching ensures safety for coordinated operations.

There are always hazards when operators work together with machines. The Auto Switching Function of the G9SX-GS contributes to both worker safety and productivity without requiring expensive equipment or programming.



Example: Manufacturing automotive parts

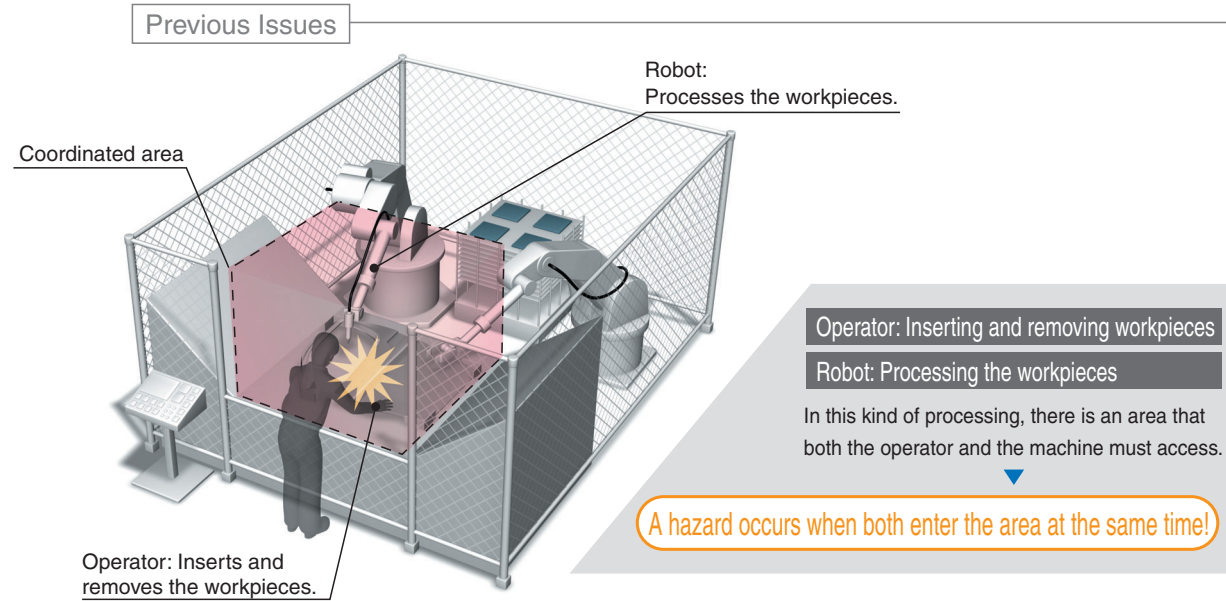

With the G9SX-GS

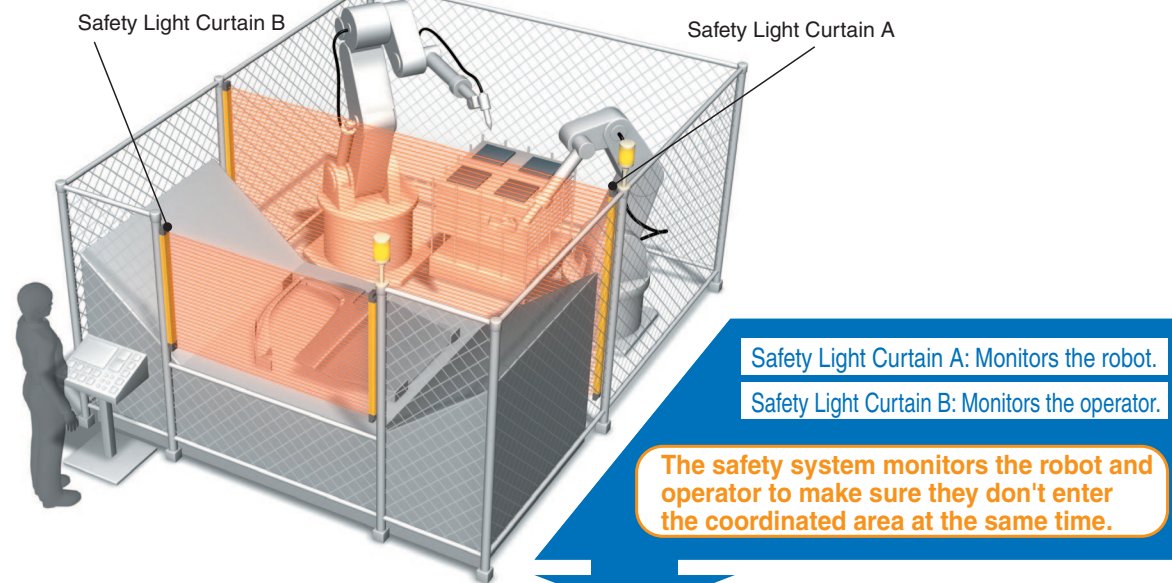

The Auto Switching Function of the G9SX-GS supports both operator safety and productivity.

Auto Switching Function

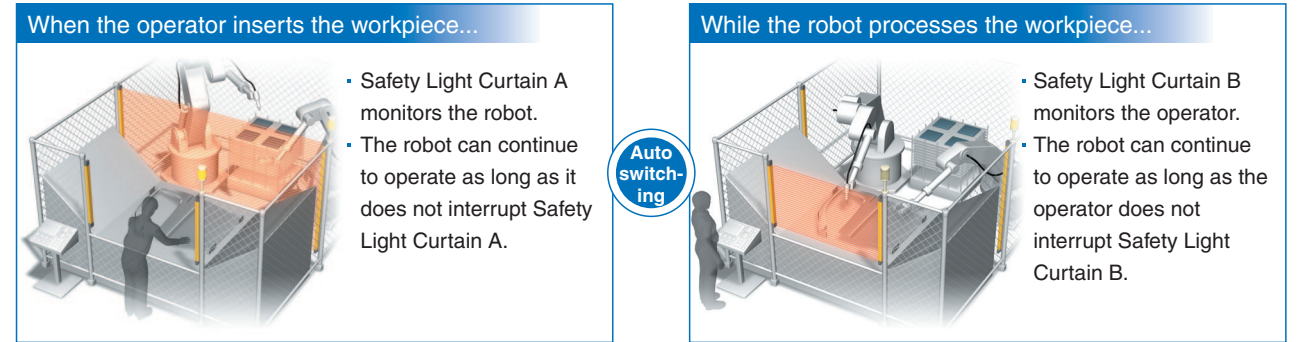

Note: If the operator is able to completely enter the zone inside Safety Light Curtain B, a presence detection device, such as a Safety Mat, is necessary as an additional safety measure.

Operating Example

Operator interrupts Safety Light Curtain B ▶ Safety Light Curtain A is enabled
Robot interrupts Safety Light Curtain A ▶ Safety Light Curtain B is enabled

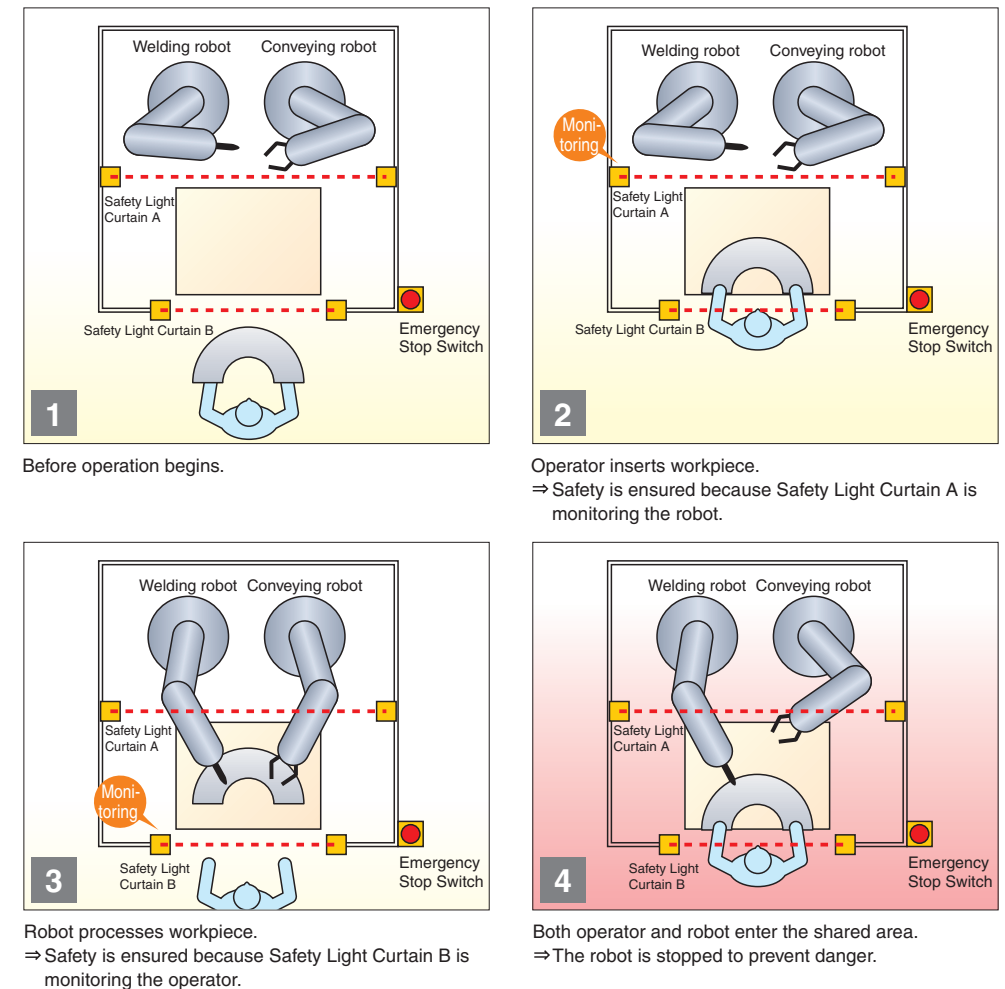

Note: As shown here, the G9SX-GS serves as a controller to safely switch two sets of Safety Light Curtains.

Case2: Limited operation

Manual Switching ensures safety for limited operations.

Performing maintenance and other limited operations can be hazardous because doors that are ordinarily closed for safety purposes are opened while operations continue. The Manual Switching Function of the G9SX-GS provides worker safety in situations like this.



G9SX-GS

Example: Manufacturing flat-panel displays

Previous Issues

Limited operations
 Operator: Performing maintenance
 Machine: Operates when necessary

There is an area that both the operator and the moving parts of the machine must access.

A hazard occurs when the Door Switch is bypassed!

With the G9SX-GS

Normal operating mode:
Door Switch monitors the door.

Maintenance mode:
Limit Switch monitors the hazard source.

A safe area is ensured during maintenance.

The Manual Switching Function of the G9SX-GS ensures safety during limited operations like maintenance and cleaning.

Manual Switching Function

During normal operation...

- The Door Switch monitors the opening and closing of the door during normal operation.
- The machine is able to operate while the door is closed.

During maintenance...

- The Limit Switch monitors the conveyor cart position during maintenance.
- The machine is able to operate while the conveyor cart is in a specified area.

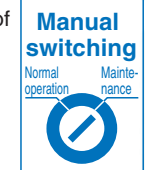

Operating Example

Operator selects normal operating mode ▶ Door Switch is enabled, Limit Switch is disabled
 Operator selects maintenance mode ▶ Door Switch is disabled, Limit Switch is enabled

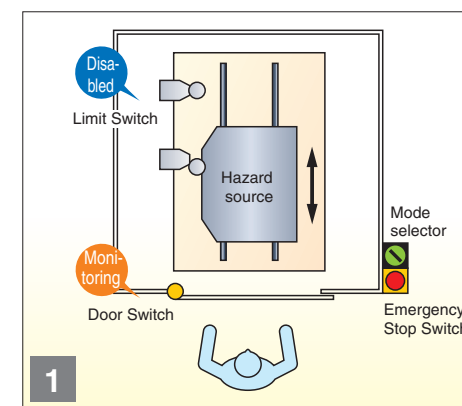

During normal operation.
 ⇒ Door Switch monitors door opening/closing.

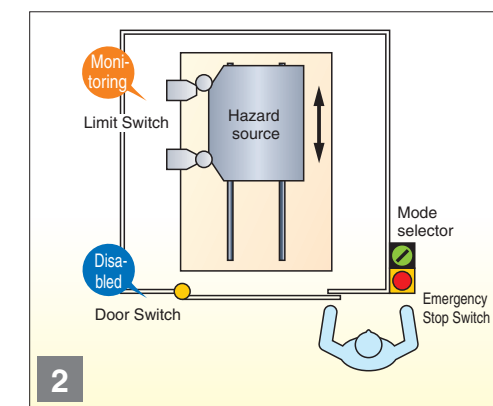

Operator switches to maintenance mode.
 ⇒ Even though the Door Switch is disabled, safety is ensured because the Limit Switch monitors the conveyor cart position.

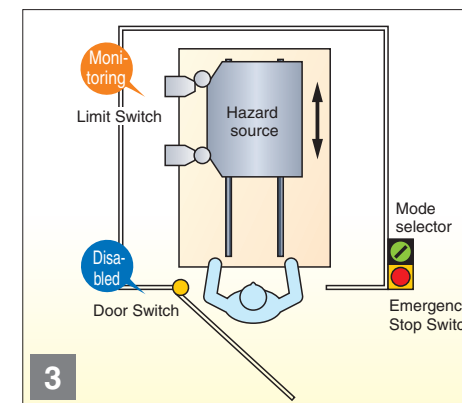

Operator opens the door to perform maintenance.
 ⇒ Safety is ensured because the Limit Switch monitors the conveyor cart position.

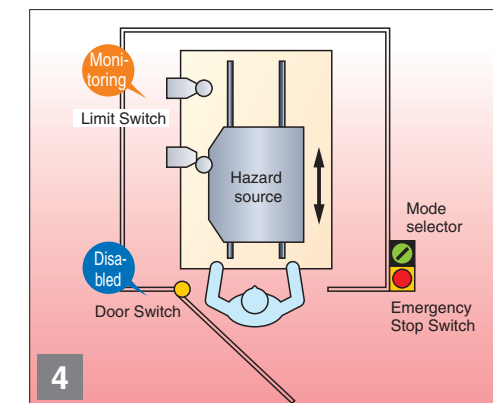

Limit Switch is turned OFF in maintenance mode.
 ⇒ The conveyor cart is stopped to prevent danger.

Note: As shown here, the G9SX-GS serves as a controller to safely switch the Door Switch and the Limit Switch.

System Configuration Examples

G9SX-GS

Auto Switching Function

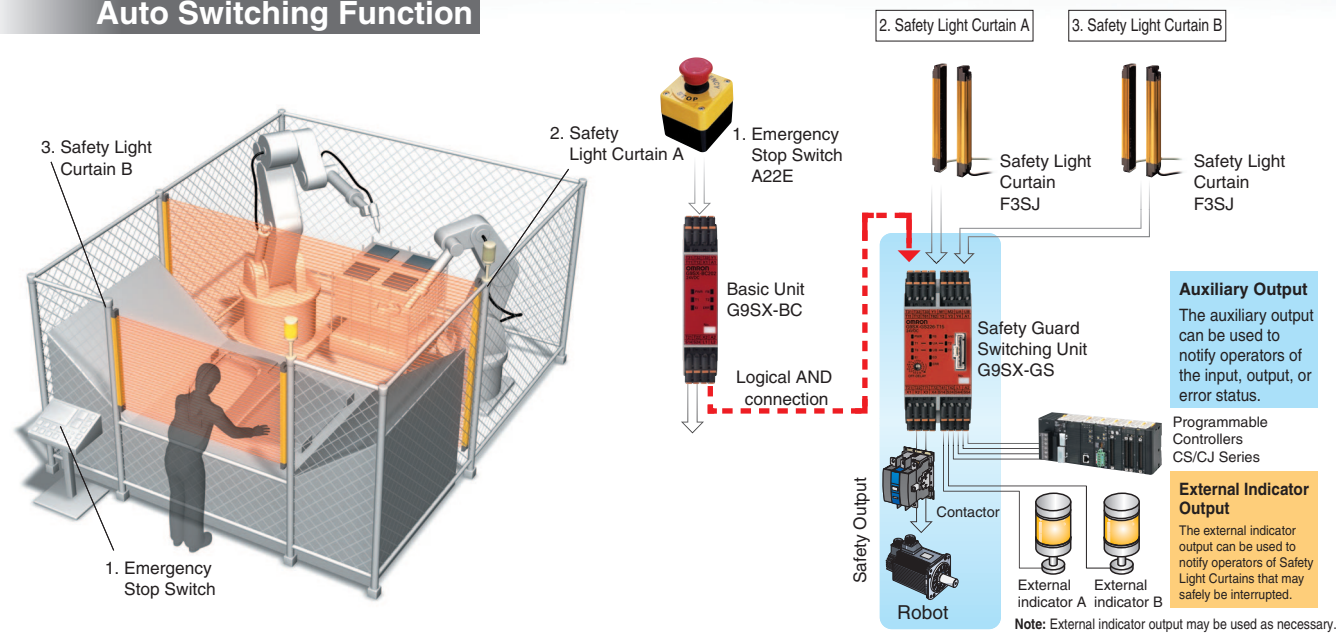

Manual Switching Function

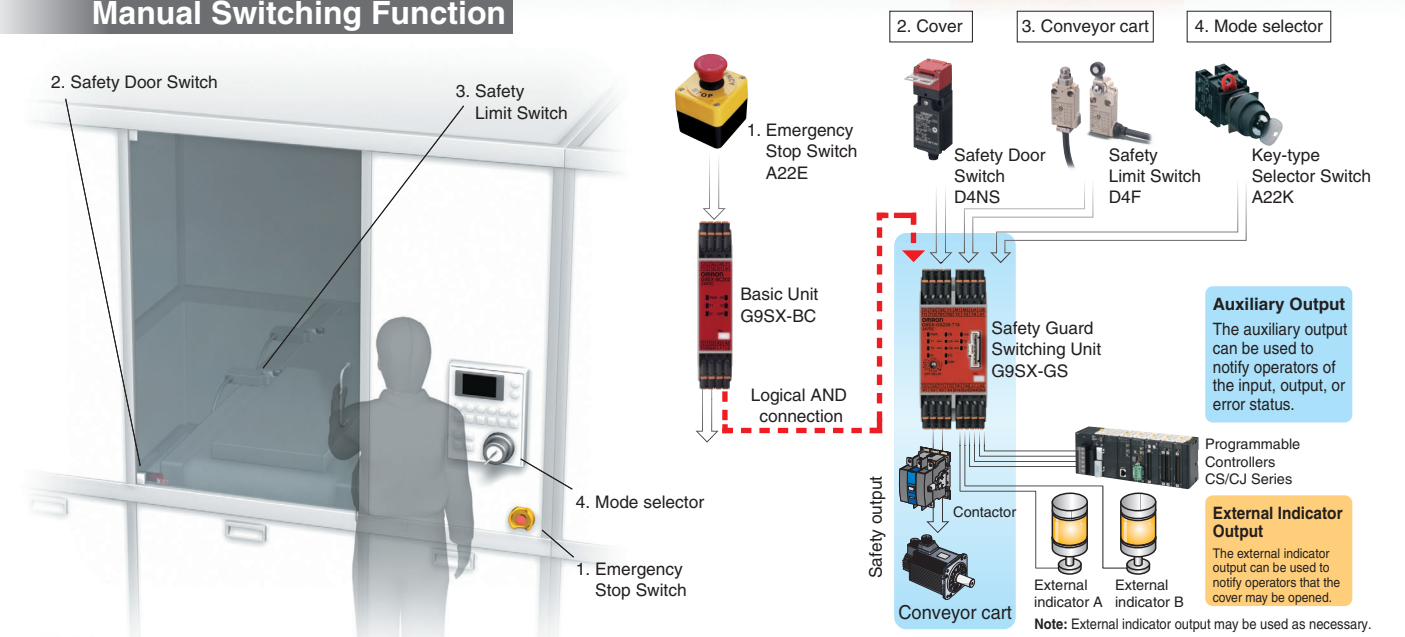

	Working condition	External indicator	G9SX-GS			
			Safety input	Safety output	Monitor output	External indicator
Normal operation	<p>1</p>	OK to work	Safety input A ON	Safety output ON	Input A monitor ON	Indicator A ON
	<p>2</p>	OK to work	Safety input A ON	Safety output ON	Input A monitor ON	Indicator A OFF
	<p>3</p>	Not OK to work	Safety input A OFF	Safety output ON	Input A monitor OFF	Indicator A ON
Hazardous condition	<p>4</p>	Not OK to work	Safety input A OFF	Safety output OFF	Input A monitor OFF	Indicator A OFF

	Working condition	External indicator	G9SX-GS				
			Safety input	Safety output	Mode selector	Monitor output	External indicator
Normal operation	<p>1</p>	Not OK to open	Safety input A Disabled	Safety output ON	Normal operating mode ON	Input A monitor OFF	Indicator A ON
	<p>2</p>	OK to open	Safety input A ON	Safety output ON	Maintenance mode ON	Input A monitor ON	Indicator A OFF
	<p>3</p>	OK to open	Safety input A ON	Safety output ON	Maintenance mode ON	Input A monitor ON	Indicator A OFF
Hazardous condition	<p>4</p>	OK to open	Safety input A OFF	Safety output OFF	Maintenance mode ON	Input A monitor OFF	Indicator A ON

Application Examples

G9SX-GS

Manufacturing Automotive Parts

Auto Switching

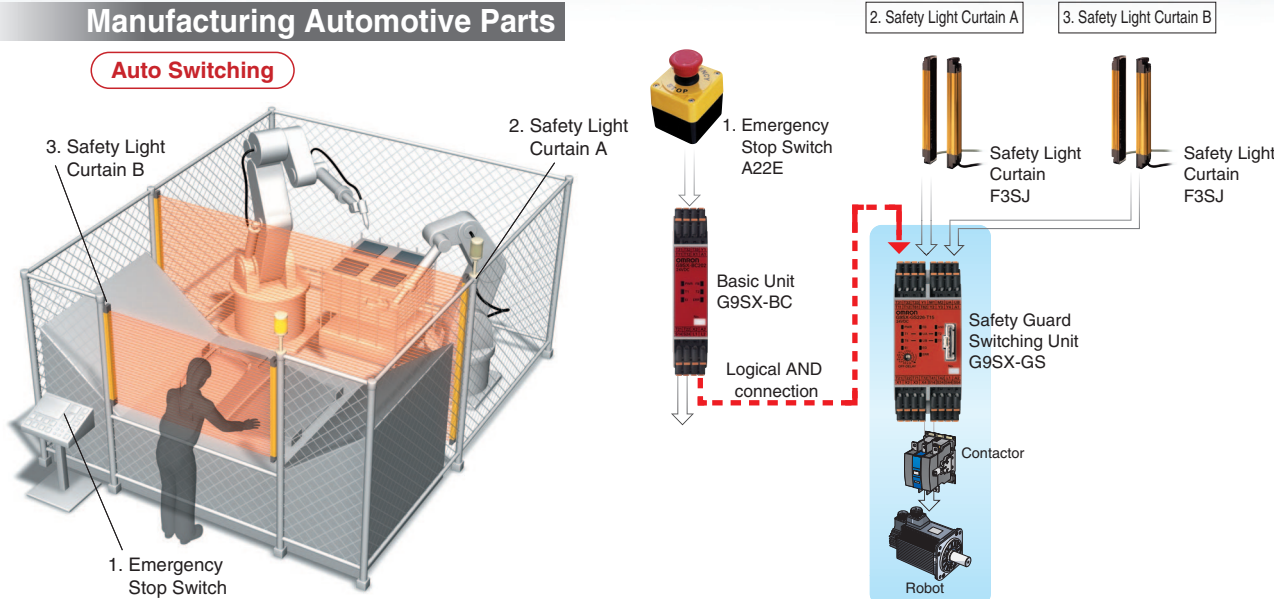

- Emergency Stop Switch** — When pressed, processing will stop.
- Safety Light Curtain A**
- Safety Light Curtain B** — When both are interrupted simultaneously, processing will stop.

Refer to pages 33 and 34 for wiring details and timing charts.

Manufacturing Flat-panel Displays -- Part 2

Manual Switching

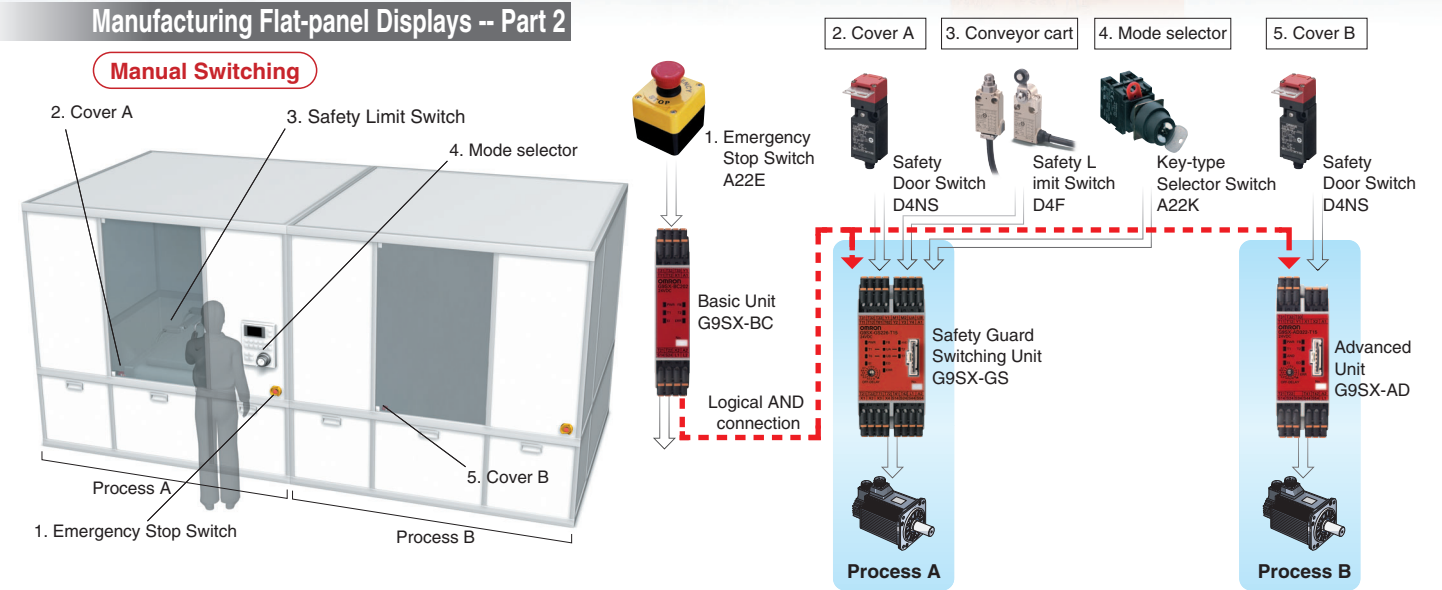

- Normal operating mode**
- Emergency Stop Switch** — When pressed, both processes will stop.
- Cover A** — When cover A is opened, process A will stop.
- Conveyor cart** — Process A will operate regardless of the conveyor cart position.
- Cover B** — When cover B is opened, process B will stop.

- Maintenance mode**
- Emergency Stop Switch** — When pressed, both processes will stop.
- Cover A** — Process A will operate regardless of whether cover A is opened or closed.
- Conveyor cart** — When the conveyor cart moves away from its safe position, process A will stop.
- Cover B** — When cover B is opened, process B will stop.

Refer to pages 37 and 38 for wiring details and timing charts.

Manufacturing Flat-panel Displays -- Part 1

Manual Switching

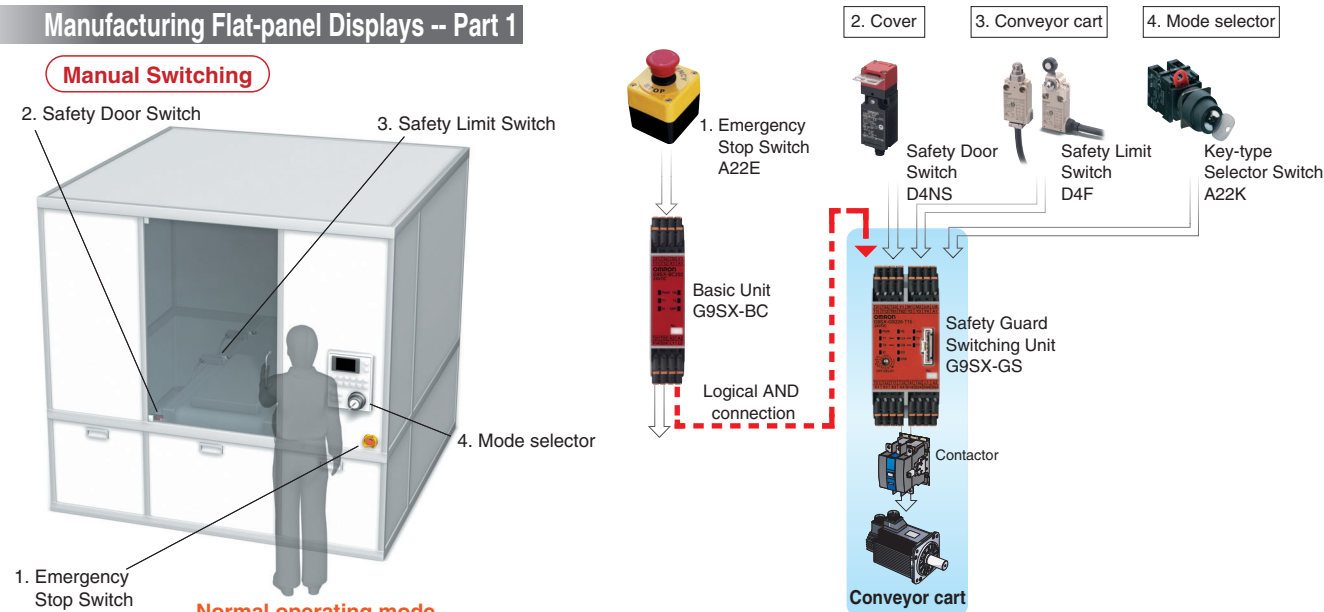

- Normal operating mode**
- Emergency Stop Switch** — When pressed, processing will stop.
- Cover** — When the cover is opened, processing will stop.
- Conveyor cart** — Processing will continue regardless of the conveyor cart position.

- Maintenance mode**
- Emergency Stop Switch** — When pressed, processing will stop.
- Cover** — Processing will continue regardless of whether the cover is opened or closed.
- Conveyor cart** — When the conveyor cart moves away from its safe position, processing will stop.

Refer to pages 35 and 36 for wiring details and timing charts.

Safety Guard Switching Unit G9SX-GS

A Safety Measure for Hazardous Operations That Does Not Lower Productivity



- Two functions support two types of application:
 - Auto switching: For applications where operators work together with machines
 - Manual switching: For applications with limited operations
- External indicator outputs enable indicating the switching status of two safety input devices.
- Auxiliary outputs enable monitoring of safety inputs, safety outputs, and errors.
- Detailed LED indications enable easy diagnosis.
- Logical AND connection allows complicated applications in combination with other G9SX-series Units.
- Certification for compliance with IEC/EN 61508 (SIL3), IEC/EN 62061 (SIL3), and EN 954-1 (category 4).

Note: Refer to *Safety Precautions* on page 26.

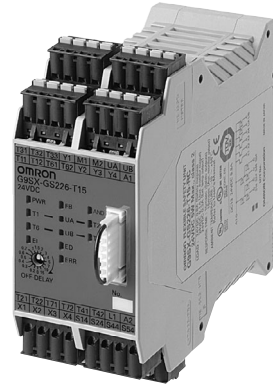

NEW

Model Number Structure

■ Model Number Legend

G9SX- - -

1 2 3 4 5 6

1. Functions

- GS: Safety Guard Switching Unit
- EX: Expansion Unit

2. Output Configuration (Instantaneous Safety Outputs)

- 0: None
- 2: 2 outputs
- 4: 4 outputs

3. Output Configuration (OFF-delayed Safety Outputs)

- 0: None
- 2: 2 outputs
- 4: 4 outputs

4. Output Configuration (Auxiliary Outputs)

- 1: 1 output
- 6: 6 outputs

5. Max. OFF-delay Time

- Safety Guard Switching Unit
 - T15: 15 s
- Expansion Unit
 - No indicator: No OFF delay
 - T: OFF delay

6. Terminal Block Type

- RT: Screw terminals
- RC: Spring-cage terminals

Ordering Information

■ List of Models

Safety Guard Switching Unit

Safety outputs (See note 3.)		Auxiliary outputs (See note 4.)	Logical AND connection		Max. OFF-delay time (See note 1.)	Rated voltage	Terminal block type	Model
Instantaneous	OFF-delayed (See note 2.)		Inputs	Outputs				
2 (semiconductor)	2 (semiconductor)	6 (semiconductor)	1 (semiconductor)	1 (semiconductor)	15 s	24 VDC	Screw terminals	G9SX-GS226-T15-RT
							Spring-cage terminals	G9SX-GS226-T15-RC

- Note:** 1. The OFF-delay time can be set in 16 steps as follows:
T15: 0, 0.2, 0.3, 0.4, 0.5, 0.6, 0.7, 1, 1.5, 2, 3, 4, 5, 7, 10, or 15 s
2. The OFF-delayed output becomes an instantaneous output by setting the OFF-delay time to 0 s.
3. P channel MOS FET transistor output
4. PNP transistor output (except for the external indicator outputs, which are P channel MOS FET transistor outputs)

Expansion Unit

Safety outputs		Auxiliary outputs (See note 1.)	OFF-delay time	Rated voltage	Terminal block type	Model
Instantaneous	OFF-delayed					
4 PST-NO (contact)	---	1 (semiconductor)	---	24 VDC	Screw terminals	G9SX-EX401-RT
			(See note 2.)		Spring-cage terminals	G9SX-EX401-RC
---	4 PST-NO (contact)				Screw terminals	G9SX-EX041-T-RT
					Spring-cage terminals	G9SX-EX041-T-RC

- Note:** 1. PNP transistor output
2. The OFF-delay time is synchronized to the OFF-delay time setting in the connected Unit (G9SX-GS226-T15-□).

Specifications

■ Ratings

Power Input

Item	G9SX-GS226-T15-□	G9SX-EX-□
Rated supply voltage	24 VDC	
Operating voltage range	-15% to 10% of rated supply voltage	
Rated power consumption (See note.)	5 W max.	2 W max.

Note: Power consumption of loads not included.

Inputs

Item	G9SX-GS226-T15-□
Safety inputs	Operating voltage: 20.4 VDC to 26.4 VDC, Internal impedance: Approx. 2.8 kΩ (See note.)
Mode selector input	
Feedback/reset input	

Note: Provide a current equal to or higher than that of the minimum applicable load of the connected input control device.

Outputs

Item	G9SX-GS226-T15-□
Instantaneous safety outputs (See note 1.) OFF-delayed safety outputs (See note 1.)	P channel MOS FET transistor outputs Load current: 0.8 A DC max. (See note 2.)
Auxiliary outputs (for input, output, and error monitoring)	PNP transistor outputs Load current: 100 mA max.
External indicator outputs	P channel MOS FET transistor outputs Connectable indicators <ul style="list-style-type: none"> • Incandescent lamp: 24 VDC, 3 to 7 W • LED lamp: 10 to 300 mA DC

Note: 1. While safety outputs are in the ON state, the following signal sequence is output continuously for diagnosis. When using the safety outputs as input signals to control devices (i.e. Programmable Controllers), consider the OFF pulse shown below.

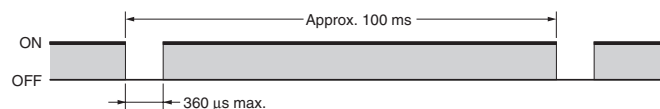

2. The following derating is required when Units are mounted side-by-side.
G9SX-GS226-T15-□: 0.4 A max. load current

Expansion Unit

Item	G9SX-EX-□
Rated load	250 VAC, 3 A / 30 VDC, 3 A (resistive load)
Rated carry current	3 A
Maximum switching voltage	250 VAC, 125 VDC

■ Characteristics

Item		G9SX-GS226-T15-□	G9SX-EX-□
Overvoltage category (IEC/EN 60664-1)		II	II (Safety relay outputs 13 to 43 and 14 to 44: III)
Operating time (OFF to ON state) (See note 1.)		50 ms max. (Safety input: ON) (See note 2.) 100 ms max. (Logical AND connection input: ON) (See note 3.)	30 ms max. (See note 4.)
Response time (ON to OFF state) (See note 1.)		15 ms max.	10 ms max. (See note 4.)
Allowable switching time for mode selector input (See notes 5 and 7.)		450 ms max.	---
Response time for switching operating modes (See notes 6 and 7.)		50 ms max.	---
ON-state residual voltage		3.0 V max. for safety outputs, auxiliary outputs, and external indicator outputs	
OFF-state leakage current		0.1 mA max. for safety outputs and auxiliary outputs, 1 mA max. for external indicator outputs	
Maximum wiring length of safety input and logical AND input		100 m max. (External connection impedance: 100 Ω max. and 10 nF max.)	
Reset input time (Reset button pressing time)		100 ms min.	
Accuracy of OFF-delay time (See note 8.)		Within ± 5% of the set value	
Insulation resistance	Between logical AND connection terminals, and power supply input terminals and other input and output terminals connected together	20 MΩ min. (at 100 VDC)	---
	Between all terminals connected together and DIN track		100 MΩ min. (at 500 VDC)
Dielectric strength	Between logical AND connection terminals, and power supply input terminals and other input and output terminals connected together	500 VAC for 1 min	---
	Between all terminals connected together and DIN track		1,200 VAC for 1 min
	Between different poles of outputs	---	2,200 VAC for 1 min
	Between safety relay outputs connected together and other terminals connected together	---	
Vibration resistance		Frequency: 10 to 55 to 10 Hz, 0.375-mm single amplitude (0.75-mm double amplitude)	
Shock resistance	Destruction	300 m/s ²	
	Malfunction	100 m/s ²	
Durability	Electrical	---	100,000 cycles min. (rated load, switching frequency: 1,800 cycles/hour)
	Mechanical	---	5,000,000 cycles min. (switching frequency: 7,200 cycles/hour)
Ambient operating temperature		-10 to 55°C (with no icing or condensation)	
Ambient operating humidity		25% to 85%	
Terminal tightening torque (See note 9.)		0.5 N·m	
Weight		Approx. 240 g	Approx. 165 g

- Note:**
- When two or more Units are connected by logical AND, the operating time and response time are the sum total of the operating times and response times, respectively, of all the Units connected by logical AND.
 - Represents the operating time when the safety input turns ON with all other conditions set.
 - Represents the operating time when the logical AND input turns ON with all other conditions set.
 - This does not include the operating time or response time of Safety Guard Switching Units that are connected.
 - This is the allowable switching time for the operating mode selector. If switching takes more than 450 ms, the G9SX-GS□ will detect an error.
 - This is the time required for the safety input to actually switch to an activated condition after the mode selector input is switched.

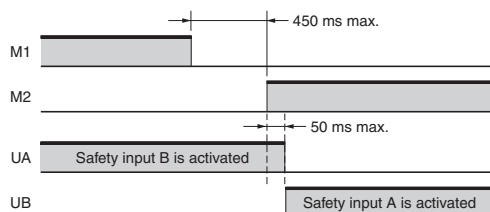

7. Only when the G9SX-GS□ is used with manual switching.
8. This does not include the operating time or response time of internal relays in the G9SX-EX-□.
9. For the G9SX-□-RT (with screw terminals) only.

Logical AND Connection

Item	G9SX-GS226-T15-□	G9SX-EX-□
Number of Units connected per logical AND output	4 Units max.	---
Total number of Units connected by logical AND (See note 1.)	20 Units max.	---
Number of Units connected in series by logical AND	5 Units max.	---
Max. number of Expansion Units connected (See note 2.)	---	5 Units max.
Maximum cable length for logical AND input	100 m max.	---

- Note:** 1. The number of G9SX-EX401-□ Expansion Units or G9SX-EX041-T-□ Expansion Units (OFF-delayed Model) not included.
 2. G9SX-EX401-□ Expansion Units and G9SX-EX041-T-□ Expansion Units (OFF-delayed Model) can be mixed.

Connections

Internal Connection

G9SX-GS226-T15□ (Safety Guard Switching Unit)

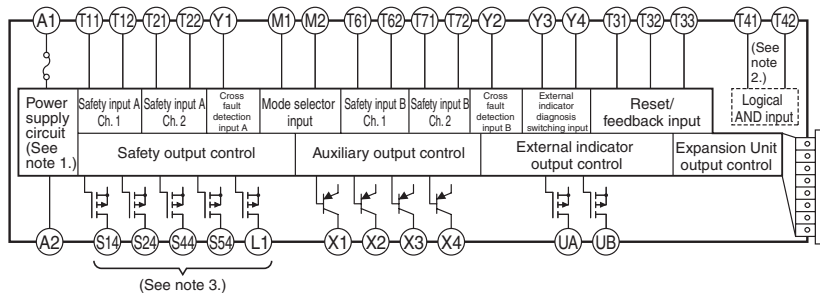

- Note:** 1. Internal power supply circuit is not isolated.
 2. Logical AND input is isolated.
 3. Outputs S14 to S54 and L1 are internally redundant.

G9SX-EX401-□/G9SX-EX041-T-□ (Expansion Unit/Expansion Unit with OFF Delay)

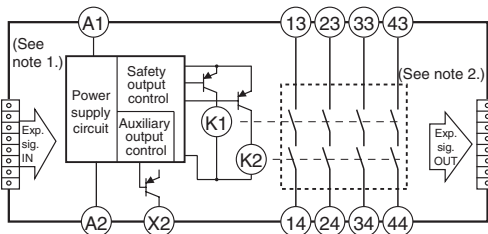

- Note:** 1. Internal power supply circuit is not isolated.
 2. Relay outputs are isolated.

Dimensions

Note: All units are in millimeters unless otherwise indicated.

Safety Guard Switching Unit

G9SX-GS226-T15-□

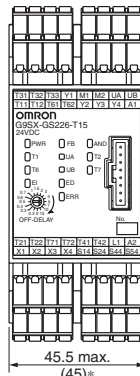
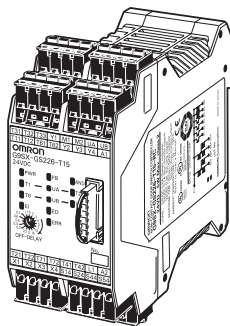

* Typical dimension

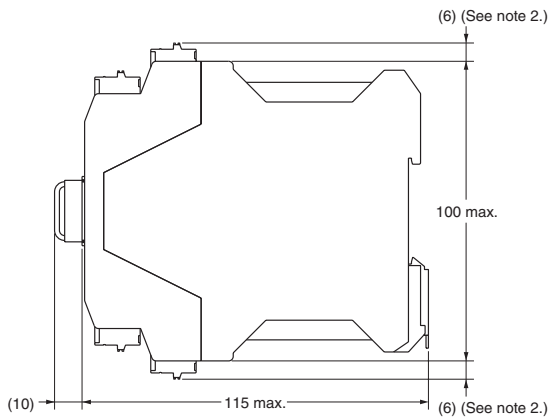

Note: 1. Above outline drawing is for -RC terminal type.
2. For -RC terminal type only.

Terminal arrangement

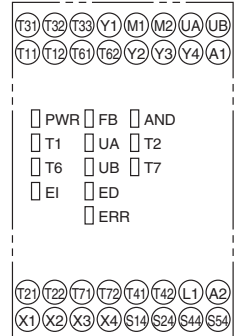

Expansion Unit

G9SX-EX401-□

Expansion Unit (OFF-delayed Model)

G9SX-EX041-T-□

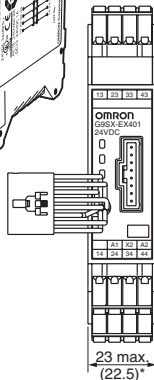
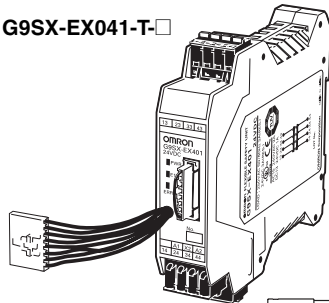

* Typical dimension

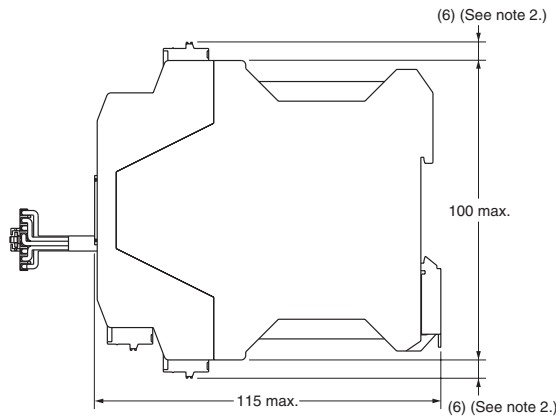

Note: 1. Above outline drawing is for -RC terminal type.
2. For -RC terminal type only.

Terminal arrangement

G9SX-EX401-□
(Expansion Unit)

G9SX-EX041-T-□
(Expansion Unit
with OFF Delay)

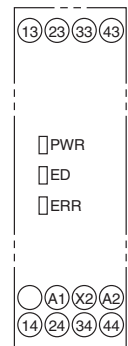
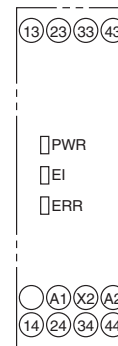

■ Wiring of Inputs and Outputs

Signal name	Terminal name	Description of operation	Wiring
Power supply input	A1, A2	The power supply input terminals for the G9SX-GS□. Connect the power source to the A1 and A2 terminals.	Connect the power supply plus (24 VDC) to the A1 terminal. Connect the power supply minus (GND) to the A2 terminal.
Safety input A, channel 1	T11, T12	Using Auto Switching: For the safety output to go to the ON state, both channels 1 and 2 of safety input A must be in the ON state, channels 1 and 2 of safety input B must be in the ON state.	Corresponds to Safety Category 2
Safety input A, channel 2	T21, T22	Using Manual Switching: For the safety output to go to the ON state when safety input A is activated, both channels 1 and 2 of safety input A must be in the ON state (for maintenance mode).	Corresponds to Safety Category 3
Safety input B, channel 1	T61, T62	For the safety output to go to the ON state when safety input B is activated, both channels 1 and 2 of safety input B must be in the ON state (for normal operating mode).	Corresponds to Safety Category 2
Safety input B, channel 2	T71, T72	For the safety output to go to the ON state when safety input B is activated, both channels 1 and 2 of safety input B must be in the ON state (for normal operating mode).	Corresponds to Safety Category 3
Feedback/reset input	T31, T32, T33	For the safety output to go to the ON state, the ON state signal must be input to T33. Otherwise the safety outputs cannot be in the ON state.	Auto reset
		For the safety output to go to the ON state, the signal input to T32 must change from the OFF state to the ON state, and then to the OFF state. Otherwise the safety outputs cannot be in the ON state.	Manual reset
Logical AND connection input	T41, T42	A logical AND connection means that one Unit (Unit A) outputs a safety signal "a" to a subsequent Unit (Unit B) and Unit B calculates the logical AND of "a" and safety signal "b." In the example shown at the right, the logical AND connection results in a safety output of "a AND b" for Unit B. Connect L1 of Unit A and T41 of Unit B to the power supply negative terminal (GND) of Unit A and T42 of Unit B. For the safety output to go to the ON state in the subsequent Unit, its logical AND connection preset switch must be set to AND (enabled) and the HIGH state signal must be input to T41 of the subsequent Unit.	
Mode selector input	M1, M2	When manual switching is selected, the SPST-NO/SPST-NC input enables the input of either safety input A or safety input B. The relationship of the safety input enable state and the mode selector input is as follows: M1 = ON, M2 = OFF: Safety input B is enabled (normal operating mode) M1 = OFF, M2 = ON: Safety input A is enabled (maintenance mode)	Keep the circuits open when using auto switching.
Cross fault detection inputs	Y1, Y2	Selects the mode for the failure detecting (cross fault detecting) function for the safety inputs of G9SX-GS□ corresponding to the connection of the cross fault detection input.	Keep Y1 open when using T11 and T21 (wiring to enable cross fault detection). Keep Y2 open when using T61 and T71 (wiring to enable cross fault detection). Connect Y1 to 24 VDC when not using T11 and T21 (wiring to disable cross fault detection, or when connecting safety sensors). Connect Y2 to 24 VDC when not using T61 and T71 (wiring to disable cross fault detection, or when connecting safety sensors).

Signal name	Terminal name	Description of operation	Wiring
External indicator diagnosis switching inputs	Y3, Y4	Enables or disables error detection for the external indicator outputs of the G9SX-GS□.	Keep Y3 open when detecting errors for UA. Keep Y4 open when detecting errors for UB. Connect Y3 to 24 VDC when not detecting errors for UA. Connect Y4 to 24 VDC when not detecting errors for UB.
Instantaneous safety outputs	S14, S24	Turns ON/OFF according to the state of the safety inputs, feedback/reset input, and logical AND connection input. During OFF-delay state, the instantaneous safety outputs cannot turn ON.	Keep these outputs open when not used.
OFF-delayed safety outputs	S44, S54	OFF-delayed safety outputs. The OFF-delay time is set by the OFF-delay preset switch. When the delay time is set to zero, these outputs can be used as instantaneous safety outputs.	Keep these outputs open when not used.
Logical connection output	L1	Outputs a signal of the same logic as the instantaneous safety outputs.	Keep this output open when not used.
Auxiliary monitor output	X1	Outputs a signal of the same logic as the instantaneous safety outputs	Keep this output open when not used.
Auxiliary error output	X2	Outputs when the error indicator is lit or blinking.	Keep this output open when not used.
Auxiliary monitor outputs	X3, X4	X3 outputs a signal that is synchronized with and has the same logic as the input state of safety input A. X4 outputs a signal that is synchronized with and has the same logic as the input state of safety input B.	Keep these outputs open when not used.
External indicator outputs	UA, UB	Outputs the disabled state of the safety input. UA outputs a signal that is synchronized and has the same logic as the disabled state of safety input A. UB outputs a signal that is synchronized and has the same logic as the disabled state of safety input B.	Keep these outputs open when not used.

■ Connecting Safety Sensors and G9SX-GS□

1. To input the control output from safety sensors to the G9SX-GS□, the Y1 terminal must be connected to 24 VDC when the control output is connected to channel A. Likewise, the Y2 terminal must be connected to 24 VDC when the control output is connected to channel B. The G9SX-GS□ will detect a connection error if these terminals are not connected to 24 VDC.
2. In many cases, safety sensor outputs include an OFF-shot pulse for self diagnosis.

The following condition of test pulse is applicable as safety inputs for the G9SX.

- OFF-shot pulse width of the sensor, during the ON-state: 340 μs max.

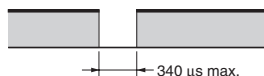

Operation

■ Functions

Auto Switching Function

The following table shows the relationship between the safety inputs and safety outputs of the G9SX-GS□ when auto switching is selected.

Safety input A	ON	ON	OFF	OFF
Safety input B	ON	OFF	ON	OFF
Safety output	ON	ON	ON	OFF

- Note:** 1. If the logical AND connection input is enabled, it must be ON as a necessary condition for the above table.
 2. Select either auto reset or manual reset for the reset mode, depending on the operation of the application.

Manual Switching Function

As shown in the following table, the relationship between the safety inputs and safety outputs of the G9SX-GS□ depends on the setting of the connected mode selector when manual switching is selected.

Mode Selector = Normal Operating Mode (M1 = ON, M2 = OFF)

Safety input A	ON	ON	OFF	OFF
Safety input B	ON	OFF	ON	OFF
Safety output	ON	OFF	ON	OFF

Mode Selector = Maintenance Mode (M1 = OFF, M2 = ON)

Safety input A	ON	ON	OFF	OFF
Safety input B	ON	OFF	ON	OFF
Safety output	ON	ON	OFF	OFF

- Note:** 1. If the logical AND connection input is enabled, it must be ON as a necessary condition for the above table.
 2. Select either auto reset or manual reset for the reset mode, depending on the operation of the application.

Logical AND Connection

The logical AND connection means that one Unit (Unit A) outputs a safety signal "a" to a subsequent Unit (Unit B) and Unit B calculates the logical AND between safety signal "a" and safety signal "b." In the example shown below, the logical AND connection results in a safety output of "a AND b" for Unit B.

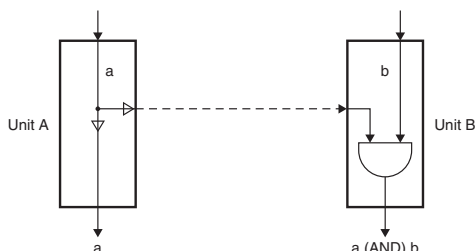

Note: For details on the logical AND connection, refer to the *G9SX-series Flexible Safety Unit catalog* (Cat. No. J150).

External Indicator Outputs

The operator can be notified of two safety input states (enabled/disabled) by connecting external indicator outputs UA and UB to indicators. External indicator outputs UA and UB turn ON when safety inputs A and B, respectively, are disabled, and turn OFF when safety inputs A and B, respectively, are enabled.

Auto Switching Selected

External indicator output	Description of operation	Output ON condition
UA	Safety input A is disabled.	Safety input B is ON.
UB	Safety input B is disabled.	Safety input A is ON.

Manual Switching Selected

External indicator output	Description of operation	Output ON condition
UA	Safety input A is disabled.	Mode selector switch must be set to normal operating mode.
UB	Safety input B is disabled.	Mode selector switch must be set to maintenance mode.

Note: Fault of external indicators can be detected. (Refer to page 22.)

Auxiliary Outputs

Auxiliary outputs X1 to X4 can be used to notify the operator of input, output, and error states, as shown in the following table.

Terminal name	Signal name	Output ON condition
X1	Auxiliary monitor output	X1 is ON when the instantaneous safety output is ON.
X2	Auxiliary error output	X2 is ON when the error LED is lit or flashing.
X3	Input A monitor	X3 is ON when safety input A is ON.
X4	Input B monitor	X4 is ON when safety input B is ON.

Connecting Expansion Units

- The G9SX-EX and G9SX-EX-T Expansion Units can be connected to the G9SX-GS226-T15-□ to increase the number of safety outputs.
- A maximum of five Expansion Units can be connected to one G9SX-GS226-T15-□. This may be a combination of the G9SX-EX Instantaneous Expansion Unit and the G9SX-EX-T OFF-delayed Expansion Unit.
- Remove the terminating connector from the receptacle on the G9SX-GS226-T15-□ and insert the Expansion Unit cable connector into the receptacle. Insert the terminating connector into the receptacle on the Expansion Unit at the very end (rightmost).
- When Expansion Units are connected to the G9SX-GS226-T15-□, make sure that power is supplied to every Expansion Unit. (Refer to the following diagram for actual Expansion Unit connections.)

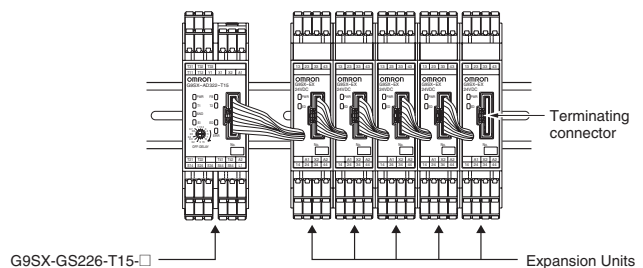

Setting Procedure

1. Switching Function

Auto or manual switching is set by using the Switching Function setting switch on the bottom of the G9SX-GS□. Set the switch to *Auto* for auto switching and *Manual* for manual switching.

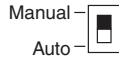

For manual switching, connect the mode selector as shown in the following table.

Switching function	Mode selector connection
Auto switching	
Manual switching	<p>M1 ON, M2 OFF: Normal operating mode M1 OFF, M2 ON: Maintenance mode</p>

2. Reset Mode

Set the reset mode using feedback/reset input terminals T31, T32, and T33.

Auto reset mode is selected when terminal T32 is shorted to 24 V and manual reset mode is selected when terminal T33 is shorted to 24 V.

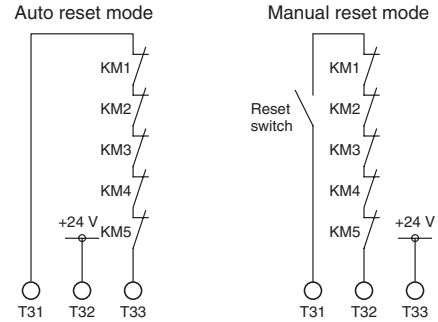

3. Cross Fault Detection

When connecting a Door Switch or other safety input device, you can use Y1 or Y2 to switch the cross fault detection setting.

When Y1 is open, short-circuit failures are detected between safety inputs T11-T12 and T21-T22. When Y2 is open, short-circuit failures are detected between safety inputs T61-T62 and T71-T72. When a cross fault is detected, the following will occur.

1. The safety outputs and logical AND output will be locked out.
2. The LED error indicator will light.
3. The error output (auxiliary output) will turn ON.

When a safety sensor, such as a Safety Light Curtain, is connected to safety input A, connect Y1 to 24 V. When a safety sensor is connected to safety input B, connect Y2 to 24 V. If they are not connected to 24 V, the G9SX-GS□ will detect an error.

Cross fault detection	Equivalent safety category	Safety input A	Safety input B
OFF	Corresponds to Safety Category 2		
	Corresponds to Safety Category 3		
ON	Corresponds to Safety Category 4		

Note: When a Type 4 safety sensor is connected, a system with Safety Category 3 connection described above is equivalent to Safety Category 4 because cross fault detection is done by the safety sensor.

4. Diagnostic Checks of External Indicators

Diagnostic checks of external indicators connected to external indicator outputs UA and UB can be switched with Y3 and Y4, respectively. Enabling the diagnostic check makes it possible to detect indicator burnout or wiring errors.

If there is no indicator connected to external indicator output UA, connect Y3 to 24 V. If there is no indicator connected to external indicator output UB, connect Y4 to 24 V. If they are not connected to 24 V, the G9SX-GS□ will detect an error.

External indicator output	Diagnostic check enabled	Diagnostic check disabled
UA		
UB		

Note: Diagnostic checks cannot be made for LED indicators. Disable the diagnostic check if using LED indicators.

5. Setting Logical AND Connection

When connecting two or more Units using a logical AND connection, set the logical AND connection preset switch on the Unit that is on the input side to AND.

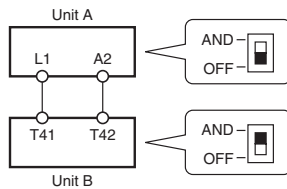

- Note 1:** A setting error will occur and Unit B will lock out if the logical AND setting switch on Unit B is set to OFF.
- Note 2:** Set the logical AND setting switch on Unit A to OFF, otherwise the Unit A output will not turn ON.

6. Setting the OFF-delay Time

The OFF-delay preset time is set from the OFF-delay time preset switch (1 each on the front and back of the Unit).

Normal operation will only occur if both switches are identically set. An error will occur if the switches are not identically set.

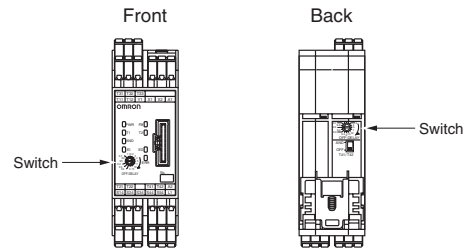

Refer to the following illustration for details on setting switch positions.

G9SX-GS226-T15-□

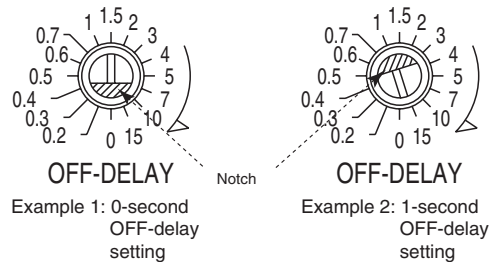

LED Indicators

Marking	Color	Name	G9SX-GS	G9SX-EX	G9SX-EX-T	Function	Reference
PWR	Green	Power supply indicator	○	○	○	Lit while power is supplied.	(See note.)
T1	Orange	Safety input A, channel 1 indicator	○	---	---	Lit while a HIGH state signal is input to T12. Blinks when an error relating to safety input A channel 1 occurs.	
T2	Orange	Safety input A, channel 2 indicator	○	---	---	Lit while a HIGH state signal is input to T22. Blinks when an error relating to safety input A channel 2 occurs.	
T6	Orange	Safety input B, channel 1 indicator	○	---	---	Lit while a HIGH state signal is input to T62. Blinks when an error relating to safety input B channel 1 occurs.	
T7	Orange	Safety input B, channel 2 indicator	○	---	---	Lit while a HIGH state signal is input to T72. Blinks when an error relating to safety input B channel 2 occurs.	
FB	Orange	Feedback/reset input indicator	○	---	---	Lit in the following cases: • With automatic reset while a HIGH state signal is input to T33. • With manual reset while a HIGH state signal is input to T32. Blinks when an error relating to feedback/reset input occurs.	
AND	Orange	Logical AND input indicator	○	---	---	Lit while a HIGH state signal is input to T41. Blinks when an error relating to logical AND connection input occurs.	
EI	Orange	Safety output indicator	○	○	---	Lit while the Instantaneous safety outputs (S14, S24) are in the ON-state. Blinks when an error relating to the instantaneous safety output occurs.	
ED	Orange	OFF-delayed safety output indicator	○	---	○	Lit while OFF-delayed safety outputs (S44, S54) are in the ON-state. Blinks when an error relating to OFF-delayed safety output occurs.	
UA	Orange	Safety input A disabled state indicator	○	---	---	Lit while the input of safety input A (T12, T22) is disabled. Blinks when an error relating to the external indicator (UA) occurs.	
UB	Orange	Safety input B disabled state indicator	○	---	---	Lit while the input of safety input B (T62, T72) is disabled. Blinks when an error relating to the external indicator (UB) occurs.	
ERR	Red	Error indicator	○	○	○	Lights or blinks when an error occurs.	

Note: Refer to *Fault Detection* on the next page for details.

Settings Indication (at Power ON)









Settings for the G9SX-GS□ can be checked by the orange indicators for approx. 3 seconds after the power is turned ON. During this settings indication period, the ERR indicator will light, however the auxiliary error output will remain OFF





Indicator	Item	Setting position	Indicator status	Setting mode	Setting status
T1	Cross fault detection mode for safety input A	Y1 terminal	Lit	Enabled	Y1 = open
			Not lit	Disabled	Y1 = 24 VDC
T6	Cross fault detection mode for safety input B	Y2 terminal	Lit	Enabled	Y2 = open
			Not lit	Disabled	Y2 = 24 VDC
FB	Reset mode	T33 or T32 terminal	Lit	Manual reset mode	T33 = 24 VDC
			Not lit	Auto reset mode	T32 = 24 VDC
AND	Logical AND connection input mode	Logical AND connection preset switch	Lit	Enabled	"AND"
			Not lit	Disabled	"OFF"
UA, UB	Switching Function	Switching Function setting switch	Lit	Manual switching	"Manual"
			Not lit	Auto switching	"Auto"

Fault Detection

When the G9SX-GS□ detects a fault, the ERR indicator and/or other indicators light or blink to inform the user about the fault. Check and take necessary measures referring to the following table, and then re-supply power to the G9SX-GS□.

Safety Guard Switching Unit

ERR indicator	Other indicator	Fault	Expected causes of the fault	Check points and measures to take	
 Blinks	---	Fault due to electro-magnetic disturbance or of internal circuits.	<ol style="list-style-type: none"> Excessive electromagnetic disturbance Failure of the internal circuit 	<ol style="list-style-type: none"> Check the disturbance level around the G9SX-GS□ and the related system. Replace with a new product. 	
 Lights	 T1 blinks	Fault involved with safety input A, channel 1	<ol style="list-style-type: none"> Failure involving the wiring of safety input A channel 1 Incorrect setting of cross fault detection input Failure of the circuit of safety input A channel 1 	<ol style="list-style-type: none"> Check the wiring to T11 and T12. Check the wiring to Y1. Replace with a new product. 	
	 T2 blinks	Fault involved with safety input A, channel 2	<ol style="list-style-type: none"> Failure involving the wiring of safety input A channel 2 Incorrect setting of cross fault detection input Failure of the circuit of safety input A channel 2 	<ol style="list-style-type: none"> Check the wiring to T21 and T22. Check the wiring to Y1. Replace with a new product. 	
	 T6 blinks	Fault involved with safety input B, channel 1	<ol style="list-style-type: none"> Failure involving the wiring of safety input B channel 1 Incorrect setting of cross fault detection input Failure of the circuit of safety input B channel 1 	<ol style="list-style-type: none"> Check the wiring to T61 and T62. Check the wiring to Y2. Replace with a new product. 	
	 T7 blinks	Fault involved with safety input B, channel 2	<ol style="list-style-type: none"> Failure involving the wiring of safety input B channel 2 Incorrect setting of cross fault detection input Failure of the circuit of safety input B channel 2 	<ol style="list-style-type: none"> Check the wiring to T71 and T72. Check the wiring to Y2. Replace with a new product. 	
	 FB blinks		Faults involved with feedback/reset input	<ol style="list-style-type: none"> Failures involving the wiring of feedback/reset input. Failures of the circuit of feedback/reset input 	<ol style="list-style-type: none"> Check the wiring to T31, T32 and T33. Replace with a new product.
			Fault in Expansion Unit	<ol style="list-style-type: none"> Improper feedback signals from Expansion Unit Abnormal supply voltage to Expansion Unit Failure of the circuit of safety relay contact outputs 	<ol style="list-style-type: none"> Check the connecting cable of Expansion Unit and the connection of the terminating connector Check the supply voltage to Expansion Unit. <p>Note: Make sure that all Expansion units' PWR indicators are lit.</p> <ol style="list-style-type: none"> Replace the Expansion Unit with a new one.
	 EI blinks		Fault involved with instantaneous safety outputs or logical connection outputs or auxiliary monitor output	<ol style="list-style-type: none"> Failure involving the wiring of instantaneous safety outputs Failure of the circuit of Instantaneous safety outputs Failure involving the wiring of the logical connection output Failure of the circuit of the logical connection output Impermissible high ambient temperature 	<ol style="list-style-type: none"> Check the wiring to S14 and S24. Replace with a new product. Check the wiring to L1. Replace with a new product. Check the ambient temperature and spacing around the G9SX-GS□.
	 ED blinks		Fault involved with OFF-delayed safety outputs	<ol style="list-style-type: none"> Failure involving the wiring of OFF-delayed safety relay contact outputs Incorrect set values for OFF-delay time Failure of the circuit of OFF-delayed safety relay contact outputs Impermissible high ambient temperature 	<ol style="list-style-type: none"> Check the wiring to S44 and S54. Confirm the set values of the OFF-delay time preset switches on the front and back of the Unit. Replace with a new product. Check the ambient temperature and spacing around the G9SX-GS□.

ERR indicator	Other indicator	Fault	Expected causes of the fault	Check points and measures to take
● Lights	 AND blinks	Fault involved with logical AND connection input	1) Failure involving the wiring of the logical AND connection input 2) Incorrect setting for the logical AND connection input 3) Failure of the circuit of the logical AND connection input	1) Check the wiring to T41 and T42. Note: Make sure that the wiring length for the T41, T42 terminal is less than 100 meters. Note: Make sure that the logical AND connection signal is branched for less than 4 units. 2) Confirm the set value of the logical AND connection preset switch. 3) Replace with a new product.
	 UA blinks	Fault involved with the external indicator output (UA)	1) Failure involving the wiring of the external indicator output 2) Failure involving the wiring of the external indicator diagnosis switching input 3) Failure of the circuit of the external indicator output 4) Failure of the external indicator	1) Check the wiring to UA. 2) Check the wiring to Y3. Note: When no indicator is connected, or an LED indicator is connected, connect Y3 to 24 V. 3) Replace with a new product. 4) Replace the connected external indicator.
	 UB blinks	Fault involved with the external indicator output (UB)	1) Failure involving the wiring of the external indicator output 2) Failure involving the wiring of the external indicator diagnosis switching input 3) Failure of the circuit of the external indicator output 4) Failure of the external indicator	1) Check the wiring to UB. 2) Check the wiring to Y4. Note: When no indicator is connected, or an LED indicator is connected, connect Y4 to 24 V. 3) Replace with a new product. 4) Replace the connected external indicator.
	 UA and UB alternately blink	Fault involved with the Switching Function	1) Failure involving the setting of the Switching Function setting switch 2) Failure involving the wiring of the mode selector input 3) Failure involving the circuit of the mode selector input 4) Failure involving the mode selector switching time	1) Check the setting of the Switching Function setting switch. 2) Check the wiring to M1 and M2. 3) Replace with a new product. 4) Check the signal switching time of the mode selector input (M1, M2).
	 All indicators except PWR blink	Supply voltage outside the rated value	1) Supply voltage outside the rated value	1) Check the supply voltage to the Units.

When indicators other than the ERR indicator blink, check and take necessary actions referring to the following table.

ERR indicator	Other indicators	Fault	Expected cause of the fault	Check points and measures to take
○ Off	T1	Safety input A mismatch	The input status between safety input A channel 1 and safety input A channel 2 is different, due to contact failure or a short circuit of safety input device(s) or a wiring fault.	Check the wiring from safety input devices to the G9SX-GS□. Or check the input sequence of safety input devices. After removing the fault, turn both safety input A channels 1 and 2 to the OFF state.
	T2			
	T6	Safety input B mismatch	The input status between safety input B channel 1 and safety input B channel 2 is different, due to contact failure or a short circuit of safety input device(s) or a wiring fault.	
	T7			

(Expansion Unit)

ERR indicator	Other indicators	Fault	Expected cause of the faults	Check points and measures to take
● Lights	---	Fault involved with safety relay outputs of Expansion Units	1) Welding of relay contacts 2) Failure of the internal circuit	Replace with a new product.

Safety Precautions

Refer to *Precautions for All Relays* on pages B-9 to B-22, and *Precautions for All Relays with Forcibly Guided Contacts* on page 460 in the *Safety Components Series Catalog* (Cat. No. Y106) for more detailed information.

⚠ WARNING

Serious injury may possibly occur due to malfunction of safety outputs.

Do not connect loads that are beyond the rating of the safety outputs.



Serious injury may possibly occur due to loss of safety functions.

Wire the G9SX properly so that the safety outputs do not short-circuit with the Unit power supply or load power supply.



Serious injury may possibly occur due to malfunction of safety outputs.

Add a circuit to protect against back electromotive force when connecting inductive loads to safety outputs.



Serious injury may possibly occur due to loss of safety functions. Use appropriate control devices as given in the following table.



Control device	Requirements
Door interlocking switches or limit switches	Use approved devices with a direct opening mechanism complying with IEC/EN 60947-5-1 and capable of switching micro loads of 24 VDC, 5 mA.
Safety Sensors	Use approved devices complying with the relevant product standards, laws, and regulations in the country where they are used. Consult a certification body to assess that the entire system satisfies the required safety category level.
Relays with forcibly guided contacts	Use approved devices with forcibly guided contacts complying with EN 50205. For feedback purposes, use devices with contacts capable of switching micro loads of 24 VDC, 5 mA.
Contactors	Use contactors with a forcibly guided mechanism to input the signal to the feedback/reset input of the G9SX through the NC contact of the contactor. For feedback purposes, use devices with contacts capable of switching micro loads of 24 VDC, 5 mA. Failure to open the contacts of a contactor cannot be detected by monitoring its auxiliary NC contact without a forcibly guided mechanism.
Emergency stop switches	Do not connect an emergency stop switch to the G9SX-GS□.
Other devices	Evaluate whether devices used are appropriate to satisfy the requirements of the safety category level.

Serious injury may possibly occur due to loss of safety functions. Construct an appropriate safety system as shown in the following table.

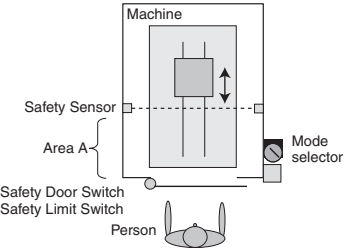

Switching function	Auto switching
Safety system configuration example	<p>The diagram illustrates a safety system configuration. A machine is shown at the top. Below it, two safety sensors, Safety Sensor A and Safety Sensor B, are positioned to define a rectangular area labeled 'Area A'. A person is shown at the bottom, near the sensors. The machine is positioned such that it can reach into Area A.</p>
Safety precautions	<ol style="list-style-type: none"> 1. Select Safety Sensors that satisfy the following condition: Diameter of the smallest detectable object < Diameter of the object to be detected 2. Install the Safety Sensors so that they satisfy the following conditions: <ol style="list-style-type: none"> (1) Use Safety Sensor A to detect the entry of the machine into area A, and Safety Sensor B to detect the entry of a person into area A. (2) Make sure that the machine can reach area A only by passing through Safety Sensor A, and that a person can reach area A only by passing through Safety Sensor B. 3. Provide a protective structure to prevent a person from passing completely through Safety Sensor B and stepping into area A. If this is not possible, install a sensor that will detect the presence of a person inside area A and prevent the machine from being restarted while the person is inside area A. 4. Provide a sufficient safety distance (S1) considering the entry speed of a person and a sufficient safety distance (S2) considering the entry speed of the machine. For details, refer to <i>Safety Distance</i> on page 28.

Switching function	Manual switching
<p>Safety system configuration example</p>	 <p>The diagram shows a machine with a vertical moving part. A Safety Sensor is located at the top of the machine's travel path. A dashed line indicates Area A, which is the space between the Safety Sensor and the machine's base. A Safety Door Switch is located on the left side of the machine. A Safety Limit Switch is located at the bottom of the machine. A Mode selector is located on the right side of the machine. A Person is shown at the bottom of the machine, near the Safety Limit Switch.</p>
<p>Safety precautions</p>	<ol style="list-style-type: none"> 1. Select Safety Sensors that satisfy the following condition: Diameter of the smallest detectable object < Diameter of the object to be detected 2. Install the Safety Sensors so that they satisfy the following conditions: <ol style="list-style-type: none"> (1) Use the Safety Sensor to detect the entry of the machine into area A. (2) Make sure that the machine can reach area A only by passing through the Safety Sensor. 3. Provide a protective structure to prevent a person from stepping into area A when the door is opened. If this is not possible, install a sensor that will detect the presence of a person inside area A and prevent the machine from being restarted while the person is inside area A. 4. Provide a sufficient safety distance (S2) considering the entry speed of the machine. For details, refer to <i>Safety Distance</i> on page 28. 5. Position the mode selector in a location where it cannot be operated from inside area A.

Safety Distance

The safety distance is the minimum distance that must be provided between the safety input device and a machine's hazardous part to stop the hazardous part before a person or object reaches it. The safety distance varies according to the standards of each country and the specifications of each machine. In addition, the calculation of the safety distance differs if the direction of approach is not perpendicular to the detection zone of the safety input device. Always refer to the relevant standards.

Safety Distance Concepts

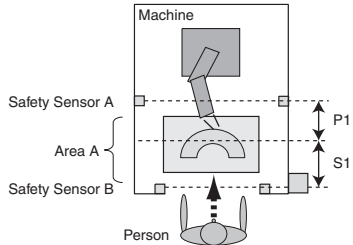
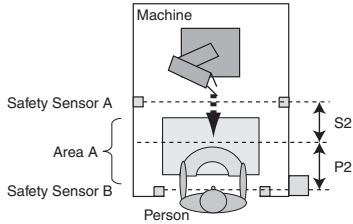
<p>When a person approaches a hazard (machine)</p>	
	<ul style="list-style-type: none"> • S1: Safety distance 1 • P1: The closest that a machine can come to a person while operating (the boundary of the machine's operating area)
<p>When a hazard (machine) approaches a person</p>	
	<ul style="list-style-type: none"> • S2: Safety distance 2 • P2: The closest that a part of a person can come to a machine.

Safety Distance Calculation Examples (Reference)

<p>Calculating the safety distance specified by international standard ISO 13855-2002 (European standard EN 999-1999)</p>	<p>If a person approaches the detection zone perpendicularly, calculate the safety distance as shown below.</p> $S1 = K1 \times T + C$ $S2 = K2 \times T + C$ <p>S1: Safety distance 1 S2: Safety distance 2 K1: Approach speed of a person to the detection zone (area A) K2: Maximum approach speed of a machine to the detection zone (area A) T: Total response time of the machine and G9SX system C: Additional distance calculated by the detection capability (the diameter of the smallest detectable object) of the Safety Sensor.</p>
<p>Calculating the safety distance specified by American standard ANSI B11.19</p>	<p>If a person approaches the detection zone perpendicularly, calculate the safety distance as shown below.</p> $S1 = K1 \times (Ts + Tc + Tr + Tbm) + Dpf$ $S2 = K2 \times (Ts + Tc + Tr + Tbm) + Dpf$ <p>S1: Safety distance 1 S2: Safety distance 2 K1: Approach speed of a person to the detection zone (area A) K2: Maximum approach speed of a machine to the detection zone (area A) Ts: Machine's stop time (s) Tr: Response time of the G9SX system from ON to OFF (s) Tc: Machine control circuit's maximum response time required to activate its brake (s) Tbm: Additional time (s) Dpf: Additional distance</p>

1. To determine the approach speed K1, consider all factors, including the operator's physical abilities.
2. To determine the maximum approach speed K2, consult with a notified body or other authoritative institutes.
3. The response time of a machine is the time from when the machine receives a stop signal to the time when the machine's hazardous part stops. Measure the response time on the actual system. Also, periodically check that the machine's response time has not changed.
4. For information on the response time of the G9SX system, refer to item 11 of *Precautions for Correct Use* on page 30.

■ Precautions for Safe Use

1. Use the G9SX-GS□ within an enclosure with IP54 protection or higher as specified by IEC/EN 60529.
2. Incorrect wiring may lead to loss of safety functions. Wire conductors correctly and verify the operation of the G9SX-GS□ before operating the system in which the G9SX-GS□ is incorporated.
3. Do not apply DC voltages exceeding the rated voltages, or any AC voltages to the G9SX-GS□ power supply input.
4. Use a DC power supply that satisfies the following requirements to prevent electric shock.
 - A DC power supply with double or reinforced insulation, for example, according to IEC/EN 60950 or EN 50178 or a transformer according to IEC/EN 61558.
 - A DC power supply that satisfies the requirements for class 2 circuits or limited voltage/current circuits stated in UL 508.
5. Apply the specified voltages to G9SX-GS□ inputs. Applying inappropriate voltages may cause the G9SX-GS□ to fail to perform its specified functions, which may lead to the loss of safety functions, damage to the G9SX-GS□, or burning.
6. Be sure to correctly connect safety input devices to safety input A and safety input B to ensure proper operation of the safety functions.
7. The auxiliary error output, auxiliary monitoring output, and external indicator output are NOT safety outputs. Do not use them as safety outputs. Such incorrect use will cause loss of the safety functions of G9SX-GS□ and its relevant system. Also the logical AND connection output can be used only for logical AND connections between G9SX-□ Units.
8. When setting the Switching Function, be sure to consider safety control requirements, safety level and safety category of the entire system.
9. After installing the G9SX-GS□, qualified personnel must confirm the installation, and must conduct test operations and maintenance. The personnel must be qualified and authorized to secure the safety on each phase of design, installation, running, maintenance, and disposal of system.
10. A person in charge who is familiar to the machine in which G9SX-GS□ is to be installed must conduct and verify the installation.
11. A qualified personnel who has a thorough understanding of the installed machine must switch the mode selector input. For example, a Switching Unit with Key must be used for the mode selector, and the key must be managed and used in such a way that the machine cannot be operated by unauthorized persons.
12. Perform daily and 6-month inspections on the G9SX-GS□. Otherwise, the system may fail to work properly, resulting in serious injury.
13. Do not dismantle, repair, or modify the G9SX-GS□. Doing so may lead to the loss of its safety functions.
14. Use only appropriate components or devices complying with relevant safety standards corresponding to the required level of the safety category. Conformity to the requirements of the safety category is determined as an entire system. It is recommended to consult a certification body regarding assessment of conformity to the required safety level.
15. OMRON shall not be responsible for conformity with any safety standards for the customer's overall system.
16. Disconnect the G9SX-GS□ from the power supply when wiring to prevent electric shock or unexpected operation.
17. Be careful not to pinch your fingers when attaching terminal sockets to the plugs on the G9SX-GS□.
18. Do not use the G9SX-GS□ in places that are subject to combustible or explosive gases.

■ Precautions for Correct Use

1. Handle with care
Do not drop G9SX to the ground or expose to excessive vibration or mechanical shocks. G9SX may be damaged and may not function properly.
2. Conditions of storage
Do not store in such conditions stated below.
 - a. In direct sunlight
 - b. At ambient temperatures out of the range of -10 to 55°C.
 - c. At relative humidity out of the range of 25% to 85% or under such temperature change that causes condensation.
 - d. In corrosive or combustible gases
 - e. With vibration or mechanical shocks out of the rated values.
 - f. Under splashing of water, oil, chemicals
 - g. In the atmosphere containing dust, saline or metal powder.
G9SX may be damaged and may not function properly.
3. Mounting
Mount G9SX to DIN track with attachments (PFP-M, not incorporated to this product), not to drop off the track by vibration or other force especially when the length of DIN track is short compared to the widths of G9SX.
4. Following spacing around G9SX should be available to apply rated current to outputs of G9SX and for enough ventilation and wiring:
 - a. At least 25 mm beside side faces of the Advanced Unit (G9SXAD322-□/G9SX-ADA222-□) and side faces of the Basic Unit.
 - b. At least 50 mm above top face of G9SX and below bottom face of G9SX.

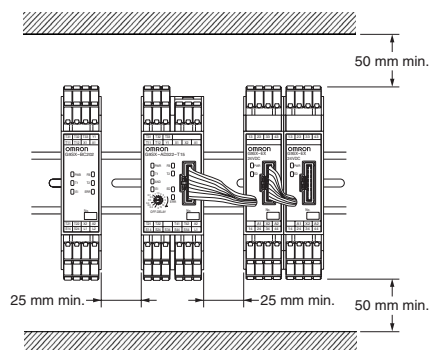

5. Wiring

(1) G9SX-GS□

- Wire the G9SX-GS□ as described below.

Solid wire	0.2 to 2.5 mm ² (AWG24 to AWG12)
Stranded wire	0.2 to 2.5 mm ² (AWG24 to AWG12)

- Strip no more than 7 mm of insulation from the end of the wire.
- It is recommended that stranded wire be covered with insulated 0.25- to 2.5-mm² ferrules before connecting it.

(2) G9SX-GS□-RT (with Screw Terminals)

- Tighten each screw to 0.5 to 0.6 N·m or the G9SX-GS□-RT may malfunction or generate heat.

(3) Wiring for a Logical AND Connection

- Use a 2-conductor cable or shielded cable to wire a logical AND connection between Units.

6. Connecting Expansion Units (G9SX-EX□-□):

- (1) Remove the termination connector from the G9SX-GS□, and insert the connector of the Expansion Unit into the G9SX-GS□ to connect it.

- (2) Insert the termination connector into the last Expansion Unit as viewed from the G9SX-GS□. When the G9SX-GS□ is used without any Expansion Units, do not remove the termination connector from the G9SX-GS□.
 - (3) Do not remove the termination connector while the system is operating.
 - (4) Before applying the power supply voltage, confirm that the connecting sockets and plugs are locked.
 - (5) Make sure that all connected Expansion Units are supplied with power within 10 s after the power to the G9SX-GS□ is turned ON. Otherwise, the G9SX-GS□ will detect a power supply error for the Expansion Units.
7. Use a mode selector that has an SPST-NO + SPST-NC contact form (e.g., OMRON's A22K-□-11).
 8. Use cables with a length of 100 m maximum to connect the safety inputs, feedback/reset input, logical AND connection input, logical AND output, or mode selector inputs.
 9. Set the time duration of OFF-delay to an appropriate value that does not cause the loss of safety function of system.
 10. Logical connection between Units: (Refer to *Functions* on page 20.)
 - a. When using Logical AND connection inputs, set the logical connection input for the Advanced Units that will receive the input to AND "Enable logical AND input".
 - b. Be sure to wire the logical connection input correctly with respect to the logical connection output of the Advanced Unit or Basic Unit.
 - d. Use two-conductor cable or shielded cable for wiring the logical connections between Units.
 11. To determine the safety distance to hazards, take into account the delay of safety outputs caused by the following times:
 - (1) Response time of safety inputs
 - (2) Response time of logical AND connection input
(Also consider the precaution in "Note" below)
 - (3) Preset OFF-delay time
 - (4) Accuracy of OFF-delay time

Note: When connecting multiple Units with logical AND connections, the operating time and response time after logical AND connection inputs will be the sum of the operating times and response times of the Units that are connected in series by logical AND connections.
 12. Start entire system after more than 5s have passed since applying supply voltage to all G9SXs in the system.
 13. Power Supply
 - (1) The G9SX-GS□ may malfunction due to electromagnetic disturbances. Be sure to connect terminal A2 to ground.
 - (2) When sharing a power supply with a Safety Light Curtain, use a power supply that will not fail for a momentary power interruption of 20 ms or less.
 14. Devices connected to G9SX may operate unexpectedly. When replacing G9SX, disconnect it from power supply.
 15. Adhesion of solvent such as alcohol, thinner, trichloroethane or gasoline on the product should be avoided. Such solvents make the marking on G9SX illegible and cause deterioration of parts.

Category of EN 954-1

In the condition shown in Application Examples, G9SX can be used for the corresponding categories up to category 4. This does NOT mean that G9SX can always be used for required category under all the similar conditions and situations. Conformity to the categories must be assessed as a whole system. When using G9SX for safety categories, be sure to confirm the conformity as a whole system.

Safety Categories (EN 954-1)

1. Input signals to both safety inputs (T11-T12, T21-T22, T61-T62, and T71-T72).
2. Input signals to the safety inputs (T11-T12, T21-T22, T61-T62, and T71-T72) through switches equipped with a direct opening mechanism.
When using limit switches, at least one of them must have a direct opening mechanism.
3. When connecting a Safety Sensor to the G9SX-GS□, use a TYPE 4 Safety Sensor.
4. Input the signal through the contactor's N.C. contact to the Feedback/Reset input (T31-T32 for manual reset, or T31-T33 for auto reset). (Refer to *Application Examples*.)
5. Keep the cross fault detection mode input (Y1 and Y2) open. However, when connecting devices that have a self-diagnosis function, such as Safety Sensors, apply 24 VDC to Y1 or Y2.
6. Be sure to connect A2 to ground.
7. When using a G9SX-EX□-□ Expansion Unit, connect fuses with a current rating of 3.15 A maximum to the safety relay outputs to prevent the contacts from welding.

Compliance with International Standards

G9SX-GS226-T15-□/G9SX-EX-□

- Approved by TÜV Product Service
EN 50178
IEC/EN 60204-1
EN 954-1 Cat.4
IEC/EN 61508 SIL3
IEC/EN 62061 SIL3
IEC/EN 61000-6-2
IEC/EN 61000-6-4
- Approved by UL
UL 508
UL 1998
NFPA 79
IEC 61508
CAN/CSA C22.2 No.142

Application Examples

G9SX-BC202 (24 VDC) (2-channel Emergency Stop Switch Input/Manual Reset) + G9SX-GS226-T15 (24 VDC) (Two 2-channel Safety Sensor Inputs/Auto Reset/Auto Switching)

- Note: 1.** This example corresponds to category 4 (EN 954-1). For details, refer to *Safety Categories (EN 954-1)*.
- 2.** Diagnostic checks of the external indicators connected to external indicator outputs UA and UB can be switched with Y3 and Y4, respectively.

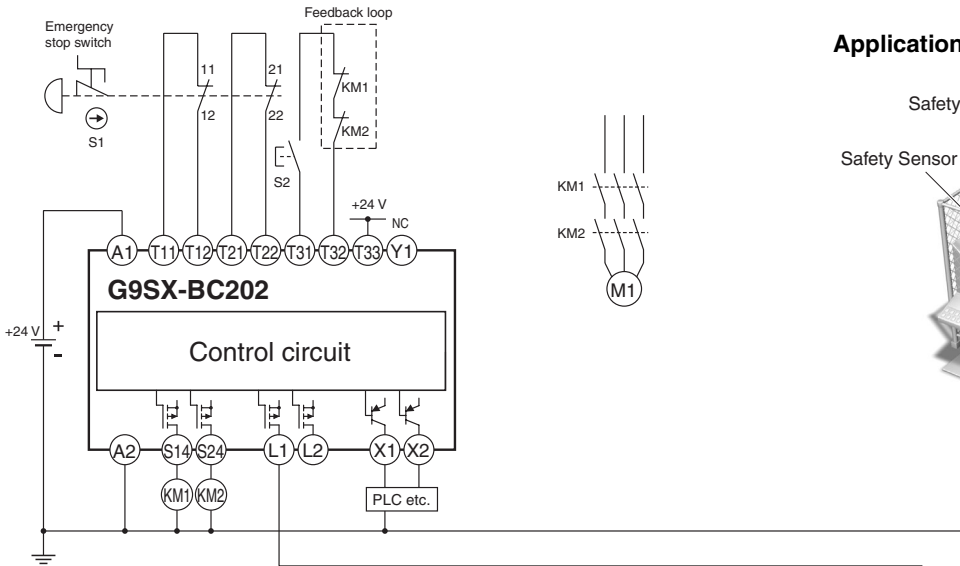

Application Examples

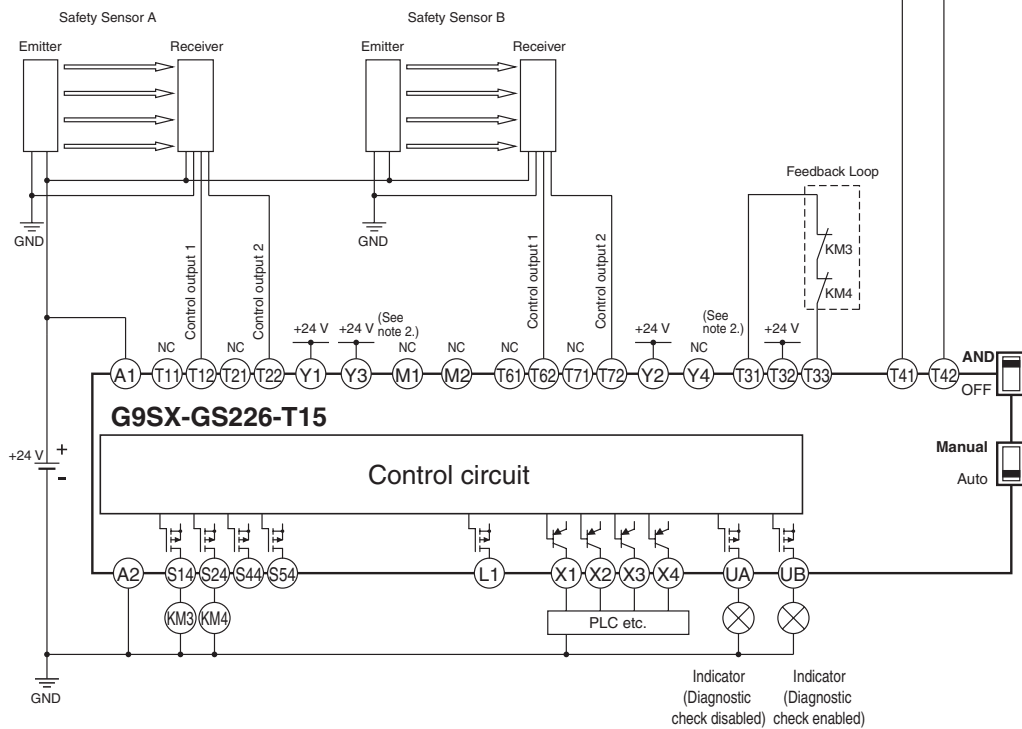
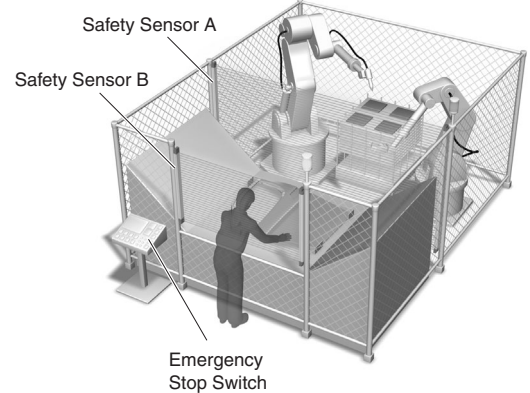

Timing Chart 1

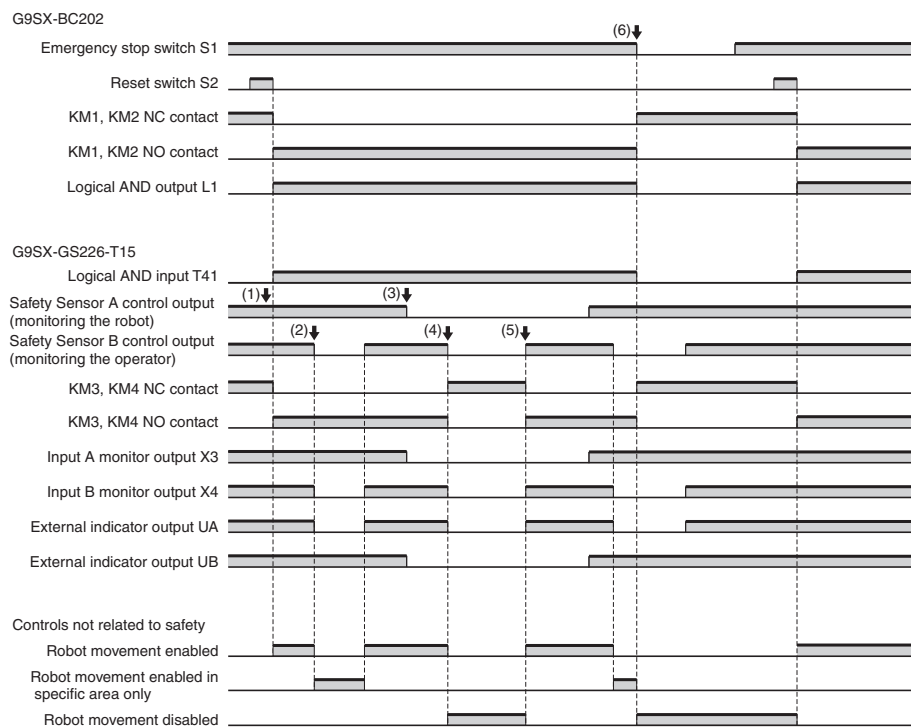

- (1) Prior to operation start
- (2) Operator inserts workpiece
- (3) Robot processes workpiece
- (4) Both operator and robot enter the coordinated area: Only the G9SX-GS stops.
- (5) The G9SX-GS restarts.
- (6) Emergency stop button pressed: All units stop.

G9SX-BC202 (24 VDC) (2-channel Emergency Stop Switch Input/Manual Reset) + G9SX-GS226-T15 (24 VDC) (Safety Limit Switch, 2-channel Safety Door Switch Inputs/Manual Reset/Manual Switching)

- Note:** 1. This example corresponds to category 4 (EN 954-1). For details, refer to *Safety Categories (EN 954-1)*.
 2. Diagnostic checks for the external indicators connected to external indicator outputs UA and UB can be switched with Y3 and Y4, respectively.

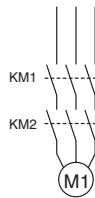
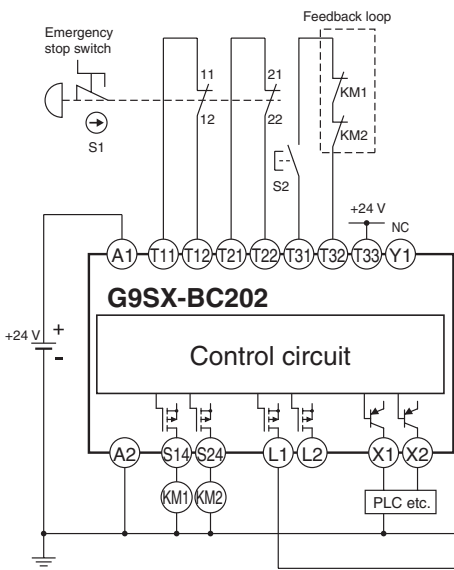

Application Examples

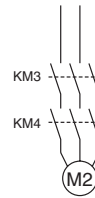
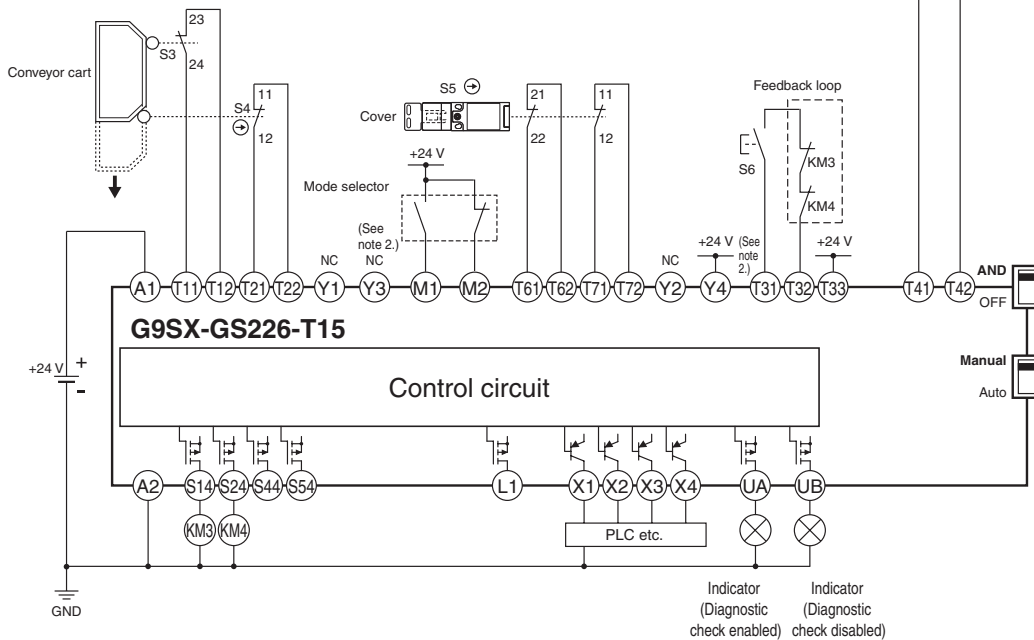
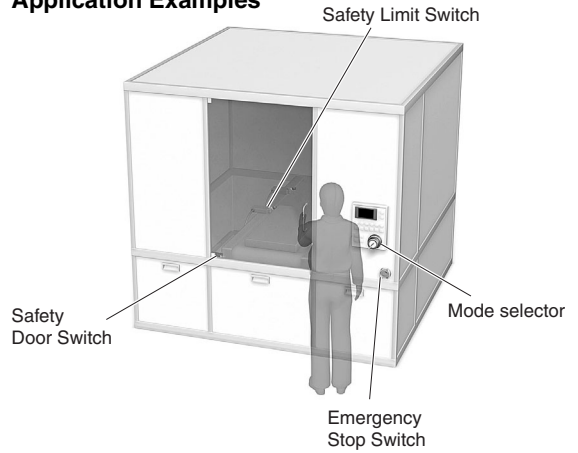

Timing Chart 2

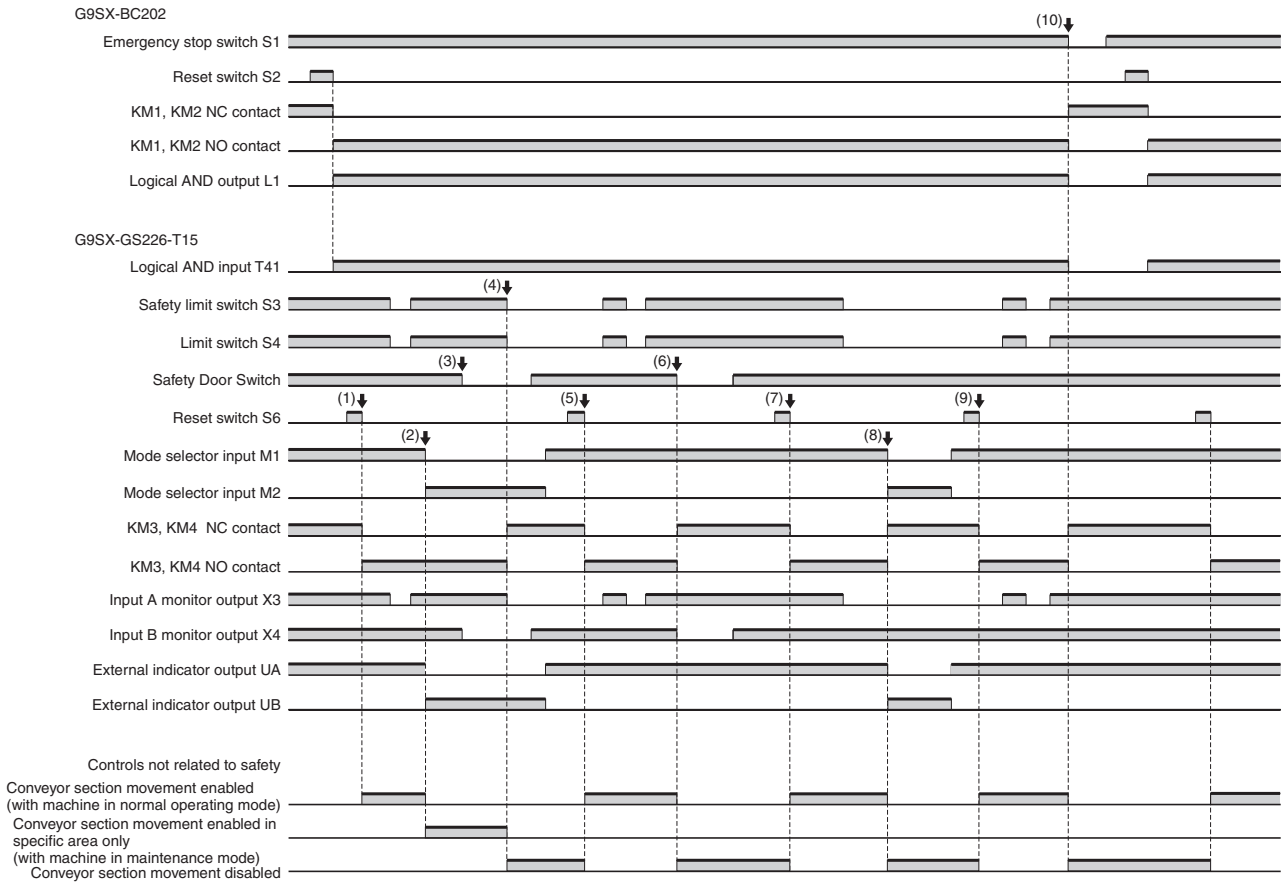

- (1) Start the G9SX-GS in normal operating mode.
- (2) Switch to maintenance mode.
- (3) The operator opens the door and performs maintenance.
- (4) When Safety Limit Switch S3 and Limit Switch S4 are turned OFF in maintenance mode, the G9SX-GS stops.
- (5) After the door is closed and the operating mode is switched to normal operating mode, restart the G9SX-GS.
- (6) When the door is opened during normal operating mode, the G9SX-GS stops.
- (7) Close the door and restart the G9SX-GS.
- (8) When the operating mode is switched to maintenance mode while Safety Limit Switch S3 and Limit Switch S4 are turned OFF, the G9SX-GS stops.
- (9) Switch to normal operating mode, and when the door is closed, restart the G9SX-GS.
- (10) Emergency stop button pressed: All units stop.

Note: 1. In this example, press reset switch S2, confirm that the G9SX-BC has started operating, then press reset switch S6.
2. To use the set value of the mode selector for control, use external indicator output UA for control and external indicator output UB for the operator's indication. In this case, disable the diagnostic check of the external indicator output UA.

**G9SX-BC202 (24 VDC) (2-channel Emergency Stop Switch Input/Manual Reset) +
G9SX-GS226-T15 (24 VDC) (Safety Limit Switch, 2-channel Safety Door Switch Inputs/Manual Reset/Manual Switching) +
G9SX-AD322-T15 (24 VDC) (2-channel Safety Door Switch Input/Manual Reset)**

Note: 1. This example corresponds to category 4 (EN 954-1).
For details, refer to *Safety Categories (EN 954-1)*.

2. Diagnostic checks for the external indicators connected to external indicator outputs UA and UB can be switched with Y3 and Y4 respectively.

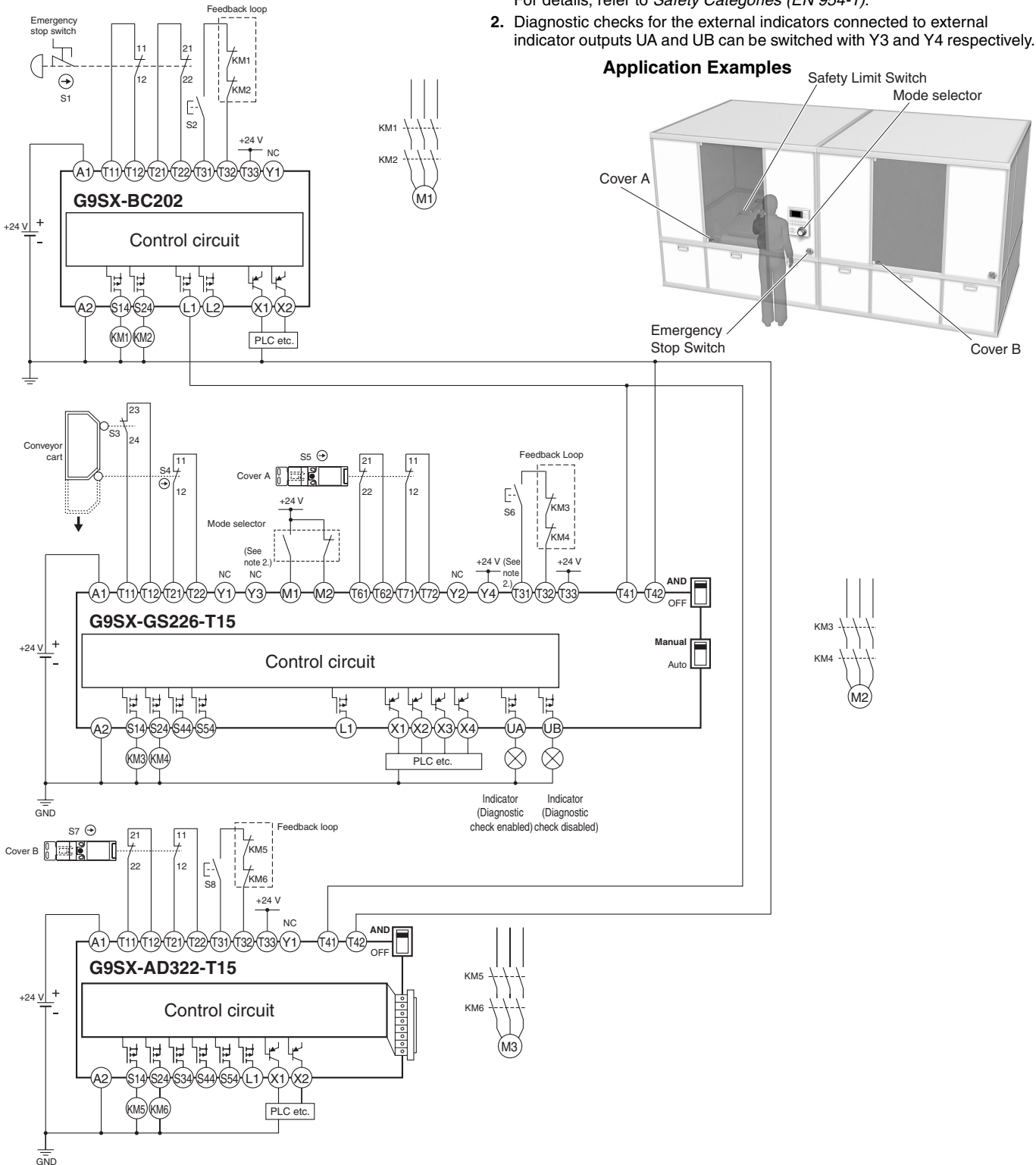

Timing Chart 3

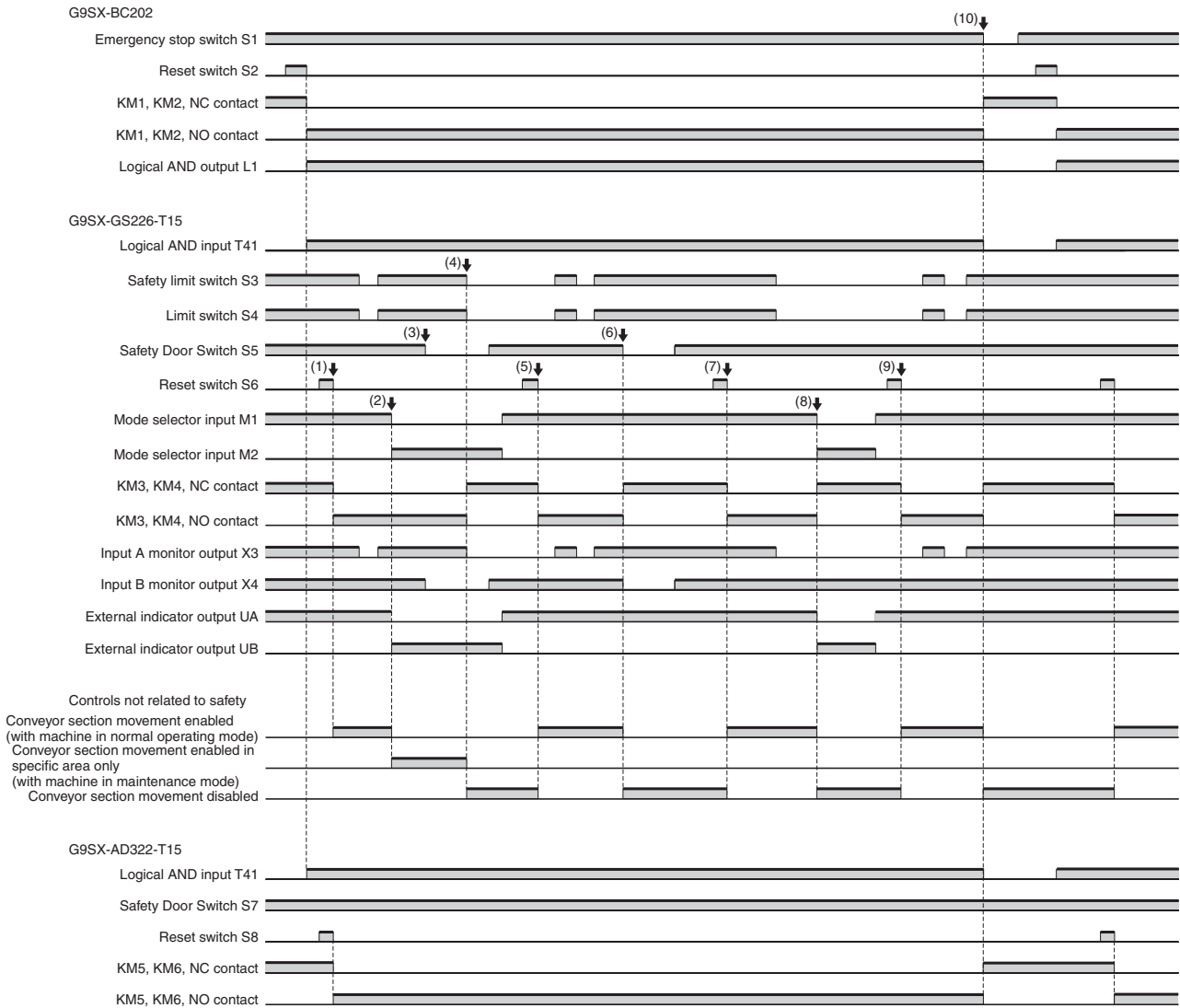

- (1) Start the G9SX-GS in normal operating mode
- (2) Switch to maintenance mode.
- (3) The operator opens the door and performs maintenance.
- (4) When Safety Limit Switch S3 and Limit Switch S4 are turned OFF in maintenance mode, the G9SX-GS stops.
- (5) After the door is closed and the operating mode is switched to normal operating mode, restart the G9SX-GS.
- (6) When the door is opened during normal operating mode, the G9SX-GS stops.
- (7) Close the door and restart the G9SX-GS.
- (8) When the operating mode is switched to maintenance mode while Safety Limit Switch S3 and Limit Switch S4 are turned OFF, the G9SX-GS stops.
- (9) Switch to normal operating mode, and when the door is closed, restart the G9SX-GS.
- (10) Emergency stop button pressed: All units stop.

Note: 1. In this example, press reset switch S2, confirm that the G9SX-BC has started operating, then press reset switch S6 and S8.
 2. To use the set value of the mode selector for control, use external indicator output UA for control and external indicator output UB for the operator's indication. In this case, disable the diagnostic check of the external indicator output UA.

MEMO

A large grid of dashed lines for taking notes, consisting of 20 columns and 20 rows.

READ AND UNDERSTAND THIS CATALOG

Please read and understand this catalog before purchasing the products. Please consult your OMRON representative if you have any questions or comments.

Warranty and Limitations of Liability

WARRANTY

OMRON's exclusive warranty is that the products are free from defects in materials and workmanship for a period of one year (or other period if specified) from date of sale by OMRON.

OMRON MAKES NO WARRANTY OR REPRESENTATION, EXPRESS OR IMPLIED, REGARDING NON-INFRINGEMENT, MERCHANTABILITY, OR FITNESS FOR PARTICULAR PURPOSE OF THE PRODUCTS. ANY BUYER OR USER ACKNOWLEDGES THAT THE BUYER OR USER ALONE HAS DETERMINED THAT THE PRODUCTS WILL SUITABLY MEET THE REQUIREMENTS OF THEIR INTENDED USE. OMRON DISCLAIMS ALL OTHER WARRANTIES, EXPRESS OR IMPLIED.

LIMITATIONS OF LIABILITY

OMRON SHALL NOT BE RESPONSIBLE FOR SPECIAL, INDIRECT, OR CONSEQUENTIAL DAMAGES, LOSS OF PROFITS OR COMMERCIAL LOSS IN ANY WAY CONNECTED WITH THE PRODUCTS, WHETHER SUCH CLAIM IS BASED ON CONTRACT, WARRANTY, NEGLIGENCE, OR STRICT LIABILITY.

In no event shall responsibility of OMRON for any act exceed the individual price of the product on which liability is asserted.

IN NO EVENT SHALL OMRON BE RESPONSIBLE FOR WARRANTY, REPAIR, OR OTHER CLAIMS REGARDING THE PRODUCTS UNLESS OMRON'S ANALYSIS CONFIRMS THAT THE PRODUCTS WERE PROPERLY HANDLED, STORED, INSTALLED, AND MAINTAINED AND NOT SUBJECT TO CONTAMINATION, ABUSE, MISUSE, OR INAPPROPRIATE MODIFICATION OR REPAIR.

Application Considerations

SUITABILITY FOR USE

OMRON shall not be responsible for conformity with any standards, codes, or regulations that apply to the combination of products in the customer's application or use of the product.

At the customer's request, OMRON will provide applicable third party certification documents identifying ratings and limitations of use that apply to the products. This information by itself is not sufficient for a complete determination of the suitability of the products in combination with the end product, machine, system, or other application or use.

The following are some examples of applications for which particular attention must be given. This is not intended to be an exhaustive list of all possible uses of the products, nor is it intended to imply that the uses listed may be suitable for the products:

- Outdoor use, uses involving potential chemical contamination or electrical interference, or conditions or uses not described in this document.
- Nuclear energy control systems, combustion systems, railroad systems, aviation systems, medical equipment, amusement machines, vehicles, safety equipment, and installations subject to separate industry or government regulations.
- Systems, machines, and equipment that could present a risk to life or property.

Please know and observe all prohibitions of use applicable to the products.

NEVER USE THE PRODUCTS FOR AN APPLICATION INVOLVING SERIOUS RISK TO LIFE OR PROPERTY WITHOUT ENSURING THAT THE SYSTEM AS A WHOLE HAS BEEN DESIGNED TO ADDRESS THE RISKS, AND THAT THE OMRON PRODUCT IS PROPERLY RATED AND INSTALLED FOR THE INTENDED USE WITHIN THE OVERALL EQUIPMENT OR SYSTEM.

Disclaimers

CHANGE IN SPECIFICATIONS

Product specifications and accessories may be changed at any time based on improvements and other reasons.

It is our practice to change model numbers when published ratings or features are changed, or when significant construction changes are made. However, some specifications of the product may be changed without any notice. When in doubt, special model numbers may be assigned to fix or establish key specifications for your application on your request. Please consult with your OMRON representative at any time to confirm actual specifications of purchased products.

DIMENSIONS AND WEIGHTS

Dimensions and weights are nominal and are not to be used for manufacturing purposes, even when tolerances are shown.

ERRORS AND OMISSIONS

The information in this document has been carefully checked and is believed to be accurate; however, no responsibility is assumed for clerical, typographical, or proofreading errors, or omissions.

PERFORMANCE DATA

Performance data given in this catalog is provided as a guide for the user in determining suitability and does not constitute a warranty. It may represent the result of OMRON's test conditions, and the users must correlate it to actual application requirements. Actual performance is subject to the OMRON Warranty and Limitations of Liability.

PROGRAMMABLE PRODUCTS

OMRON shall not be responsible for the user's programming of a programmable product, or any consequence thereof.

Copyright and Copy Permission

COPYRIGHT AND COPY PERMISSION

This document shall not be copied for sales or promotions without permission.

This document is protected by copyright and is intended solely for use in conjunction with the product. Please notify us before copying or reproducing this document in any manner, for any other purpose. If copying or transmitting this document to another, please copy or transmit it in its entirety.

OMRON Corporation
Industrial Automation Company

Safety Devices Division
Shiokoji Horikawa, Shimogyo-ku,
Kyoto, 600-8530 Japan
Tel: (81)75-344-7093/Fax: (81)75-344-8197

Regional Headquarters

OMRON EUROPE B.V.
Wegalaan 67-69, NL-2132 JD Hoofddorp
The Netherlands
Tel: (31)2356-81-300/Fax: (31)2356-81-388

OMRON SCIENTIFIC TECHNOLOGIES INC.

6550 Dumbarton Circle, Fremont
CA 94555-3605 U.S.A
Tel: (1)510-608-3400/Fax: (1)510-744-1442

OMRON ASIA PACIFIC PTE. LTD.

83 Clemenceau Avenue,
#11-01, UE Square,
239920 Singapore
Tel: (65)6835-3011/Fax: (65)6835-2711

OMRON (CHINA) CO., LTD.

Room 2211, Bank of China Tower,
200 Yin Cheng Road (M),
Shanghai, 200120 China
Tel: (86)21-5037-2222/Fax: (86)21-5037-2200

Authorized Distributor:

Note: Specifications subject to change without notice.

Cat. No. J167-E1-01
Printed in Japan
0407-0.5M (0407) (C)