

1/16 DIN, Digital-Set Timer with
0.1 Second to 9,990 Hours Range

- 8 field-selectable operation modes
- Universal AC/DC supply voltage timers available
- Operations include ON-delay, Repeat cycle, Signal Interval/OFF-delay, Signal-OFF delay (I and II), Interval, Cycle and Signal ON-delay/OFF-delay
- Selectable no-voltage start, reset, gate and check inputs expand capabilities
- Time remaining LCD bar graph and LCD output status indicator
- Panel mounting adapters, sockets, and accessories may be ordered separately



Ordering Information

■ TIMERS

Add the supply voltage to the part number when you order ON-delay only timers H3CA-8 and H3CA-8H. For example, **H3CA-8H-AC/100/110/120**.

Timing function		8 field-selectable functions		ON-delay only	
Contact type	Time limit	SPDT	SPDT	SPDT	DPDT
	Instantaneous	–	–	SPDT	–
Terminal form		11-pin round socket	Front mounted screw terminals	8-pin round socket	
Part number		H3CA-A	H3CA-FA	H3CA-8H	H3CA-8
Supply voltages	AC	24 to 240 V, 50/60 Hz or		Specify 24 V, 100/110/120 V, or 200/220/240 V; 50/60 Hz	
	DC	12 to 240 V		Specify 12 V, 24 V, 48 V or 110 V	

■ ACCESSORIES

Description		Part number	
Sockets	H3CA-A timer	Bottom surface or track mounting, top screw terminals	P2CF-11
		Back mounting, for use with Y92F-30 mounting adapter, bottom screw terminals	P3GA-11
	H3CA-8, H3CA-8H timers	Bottom surface or track mounting, top screw terminals	P2CF-08
		Back mounting, for use with Y92F-30 mounting adapter, bottom screw terminals	P3G-08
Panel mounting adapters	Fits behind panel, ideal for side by side installation. Use P3G-□□ sockets.		Y92F-30
	Installs through panel front; timer face fits bezel, rear of timer clips to adapter. Use P3G-□□ sockets. Fits 65-66 mm (2.56 - 2.59 in) x 52-53 (2.04 x 2.09 in) panel cutout. Charcoal gray face plate measures 88 H x 58 W mm (3.46 x 2.28 in).		Y92F-70
	Installs through panel front; timer face fits bezel, rear of timer clips to adapter. Use P3G-□□ sockets. Fits 55 x 45 mm (2.17 x 1.77 in) panel cutout. Charcoal gray face plate measures 58 H x 50 W mm (2.28 x 1.97 in).		Y92F-71
Protective cover	Hard plastic cover; not for use with Y92F-70 or Y92F-71 panel adapters.		Y92A-48B
	Soft plastic cover; not for use with Y92F-70 or Y92F-71 panel adapters.		Y92A-48D
Mounting track	DIN rail, 50 cm (1.64 ft) length		PFP-50N
	DIN rail, 1 m (3.28 ft) length		PFP-100N
	End plate		PFP-M
	Spacer		PFP-S

■ RANGE AND OPERATION MODE SELECTION

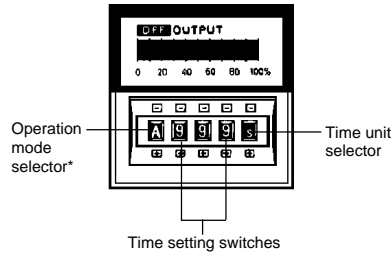

Time unit	Timing range
0.1 s	0.1 to 99.9 seconds
s	1 to 999 seconds
0.1 m	0.1 to 99.9 minutes
m	1 to 999 minutes
0.1 h	0.1 to 99.9 hours
h	1 to 999 hours
10 h	10 to 9990 hours

Mode	Operation
A	ON-delay
B	Repeat cycle
C	Signal Interval/OFF-delay
D	Signal OFF-delay I
E	Interval
F	Cycle
G	Signal ON-delay/OFF-delay
H	Signal OFF-delay II

Note: *Operation mode selector not included with ON-delay only models.

Specifications

Part number		H3CA-A	H3CA-FA	H3CA-8H	H3CA-8
Supply voltage	AC	24 to 240 V, 50/60 Hz		24 V, 100/110/120 V, 200/220/240 V; 50/60 Hz	
	DC	12 to 240 V		12 V, 24 V, 48 V, 110 V, (permissible ripple factor: 20% max. using single-phase, full-wave rectified power sources)	
Operating voltage		90 to 110% of rated voltage			
Power consumption	AC	3 VA		10 VA	
	DC	3 W		2W	
Timing functions		8 field-selectable modes: ON-delay, Repeat cycle, Signal Interval/OFF-delay, Signal ON/OFF-delay, Signal OFF-delay (I and II), Interval and Cycle		ON-delay only	
Start, reset, gate inputs		No voltage	No voltage	–	–
Control output	Type	SPDT		SPDT	DPDT
	Time limit	Instantaneous		–	–
	Max. load	3 A, 250 VAC (p.f. = 1)			
	Min. load	10 mA, 5 VDC			
Repeat accuracy		±0.3%, ±0.05 sec (includes variation due to voltage and temperature changes)			
Setting error		±0.5%, ±0.05 sec			
Resetting system		Power-OFF, external and self-reset		Power-OFF	
Resetting time		0.5 sec max.		0.1 sec max.	
Indicators		Time Remaining (LCD bar graph), Output Status (LCD message)			
Materials		Plastic case			
Mounting		Panel, track, surface			
Connections		11-pin round socket	Terminal screws	8-pin round socket	
Weight		110 g (3.9 oz)	190 g (6.7 oz)	110 g (3.9 oz)	
Approvals		UL/CSA/SEV			
Operating ambient temperature		-10° to 55°C (14° to 131°F)			
Humidity		35 to 85% RH			
Vibration	Mechanical durability	10 to 55 Hz; 0.75 mm (0.03 in) double amplitude			
	Malfunction durability	10 to 55 Hz; 0.5 mm (0.02 in) double amplitude			
Shock	Mechanical durability	100 G			
	Malfunction durability	10 G			
Variation due to voltage change		See "Repeat Accuracy"			
Variation due to temperature change		See "Repeat Accuracy"			
Insulation resistance		100 MΩ min. at 500 VDC			
Dielectric strength		2,000 VAC, 50/60 Hz for 1 minute between current-carrying and non-current-carrying parts and between contact and control circuit 1,000 VAC, 50/60 Hz for 1 minute between non-continuous contacts			
Service life	Mechanical	10 million operations minimum (under no load, at 1,800 operations/hour)			
	Electrical	100,000 operations minimum at maximum ratings			

Engineering Data

■ ELECTRICAL SERVICE LIFE

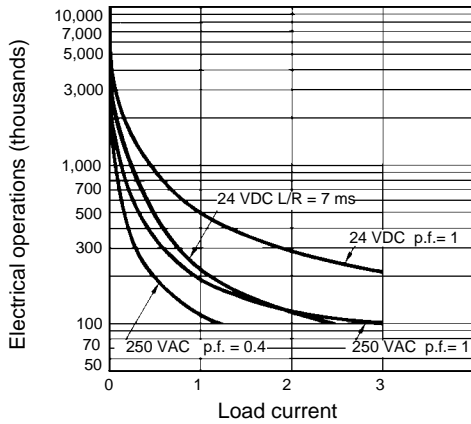

Timing Charts

In the schematic diagrams, each **thick line** indicates the external wiring necessary for the selected operation.

■ H3CA-A, H3CA-FA

Mode A ON-Delay

Power-ON Start/Power-OFF Reset

The start terminals are connected. Timing starts when power is applied. The output is energized when the accumulated time equals the set time. The output remains energized until power is disconnected or a reset input is applied.

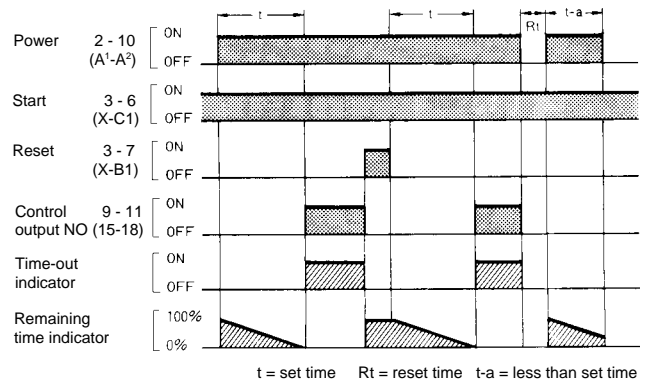
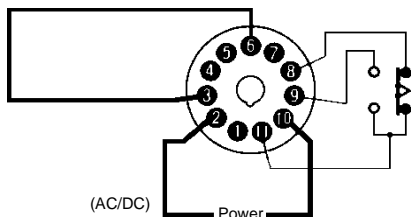

Signal Start

Power is applied continuously. Timing starts at the leading edge of the start input. The output is energized when the accumulated time equals the set time. Subsequent start signals during or after timing will not be accepted. The output relay will remain energized until a reset input is applied or power is interrupted.

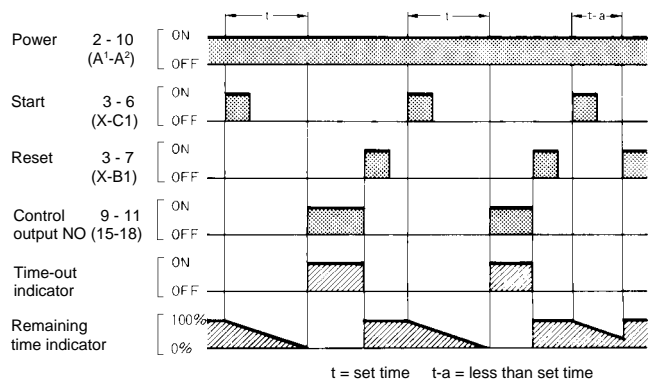
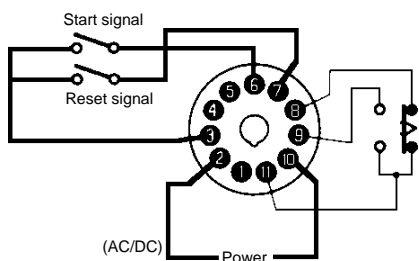

In the schematic diagrams, each **thick line** indicates the external wiring necessary for the selected operation.

Mode B Repeat Cycle

Signal Start

Power is continuously applied. The OFF/ON cycle is initiated at the leading edge of the start input. The output relay will be OFF for the set time and then ON for the set time. This cycle will be repeated until a reset input is applied or power is disconnected.

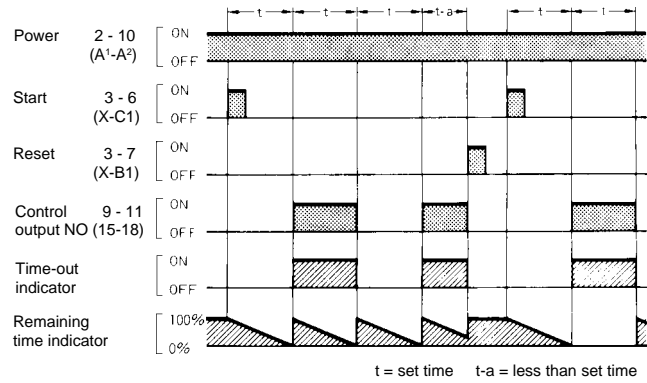
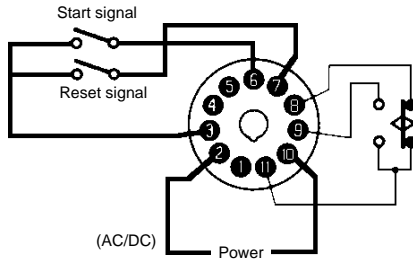

Power-ON Start/Power-OFF Reset

The start terminals are connected. Timing starts when power is applied. The output relay will be OFF for the set time and then ON for the set time. This cycle will be repeated until a reset input is applied or power is disconnected.

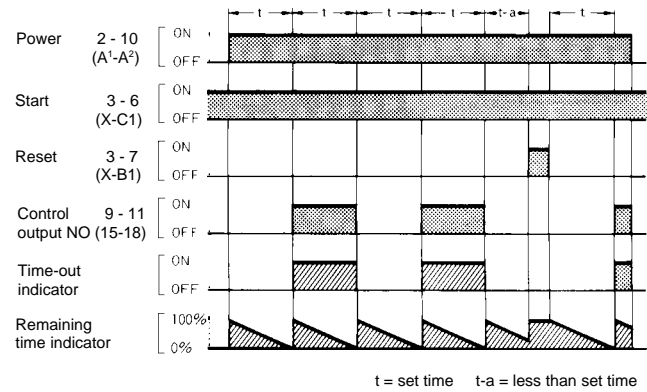
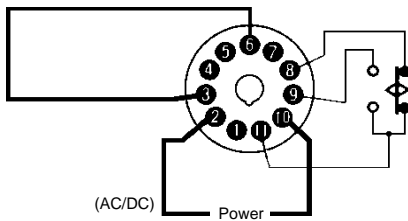

Mode C Signal Interval/OFF-Delay

Power is continuously applied. Timing begins on both the leading and trailing edges of the start input. The output relay is energized during timing. Once the timer has timed out from the trailing edge, it resets and is ready for subsequent start inputs.

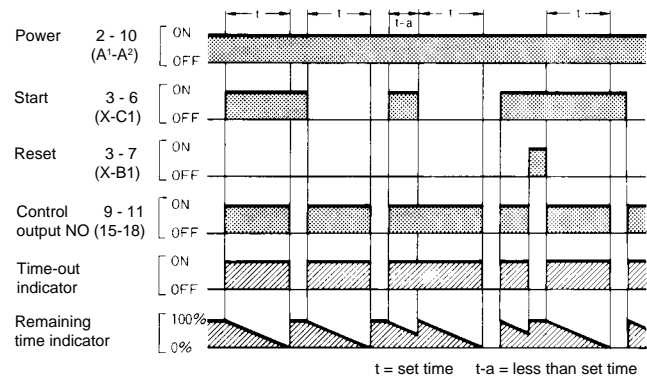
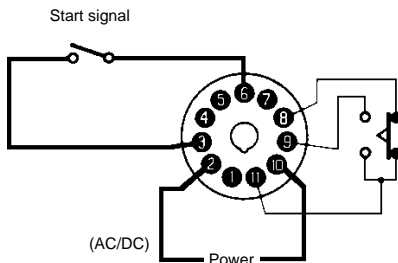

In the schematic diagrams, each **thick line** indicates the external wiring necessary for the selected operation.

Mode D Signal OFF-Delay (I)

Power is continuously applied. The output relay is energized at the leading edge of the start input. Timing starts at the trailing edge of the start input. The output relay is de-energized when the accumulated time equals the set time.

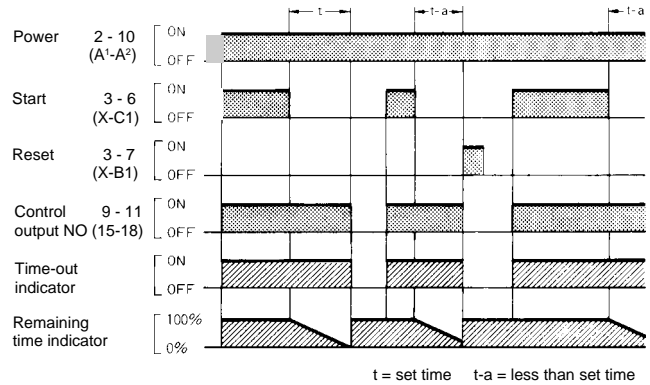
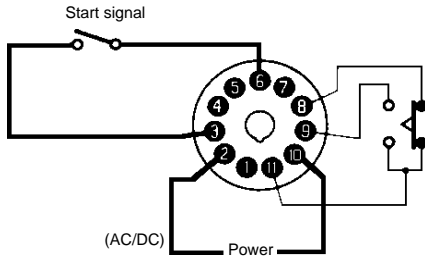

Mode E Interval

Signal Start

Power is applied continuously. Timing starts at the leading edge of the start input. The output relay is only energized during timing. The timer is reset when power is disconnected or a reset input is applied.

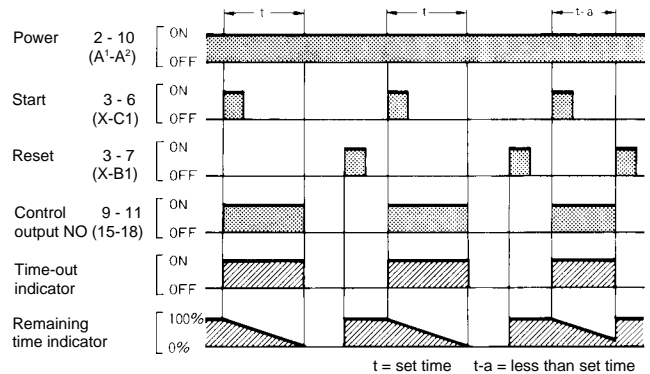
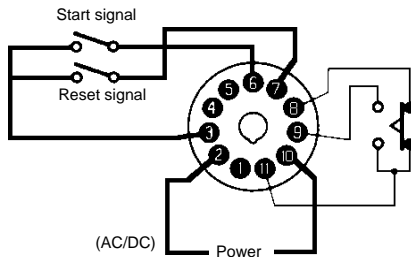

Power-ON Start/Power-OFF reset

The start terminals are connected. Timing starts when power is applied. The output relay is only energized during timing. The timer is reset when power is disconnected or a reset input is applied.

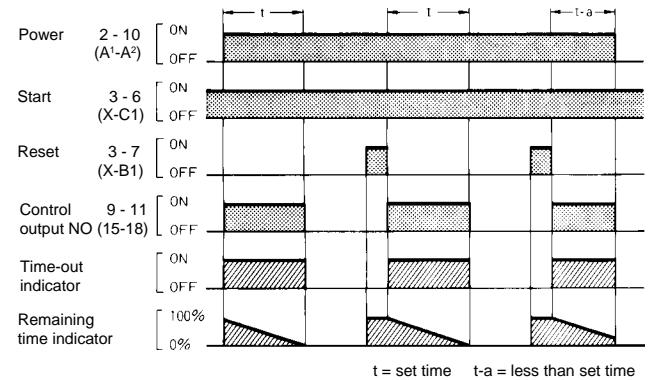
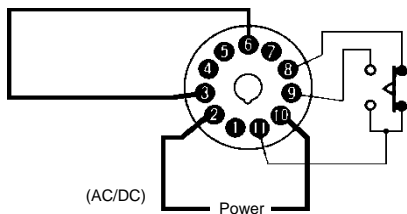

In the schematic diagrams, each **thick line** indicates the external wiring necessary for the selected operation.

Mode F Cycle One-Shot

Power-ON Short/Power-OFF Reset

The start terminals are connected. Timing starts when power is applied. The output relay will be OFF for the set time and then ON for the set time. The timer is reset when power is disconnected or a reset input is applied.

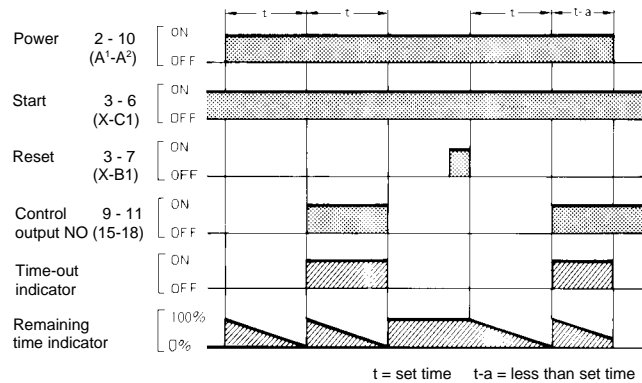
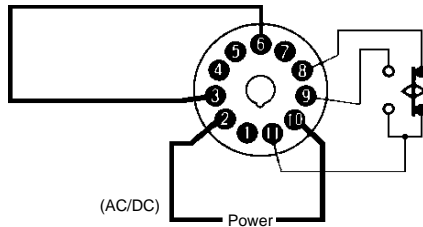

Signal Start

Power is applied continuously. The OFF/ON cycle is initiated at the leading edge of the start input. The output relay will be OFF for the set time and then ON for the set time. The timer is reset when power is disconnected or a reset input is applied.

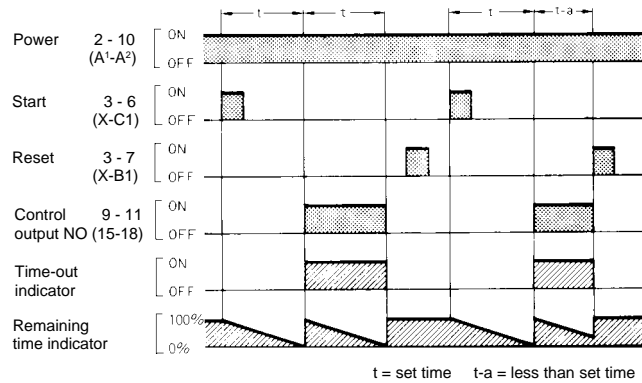
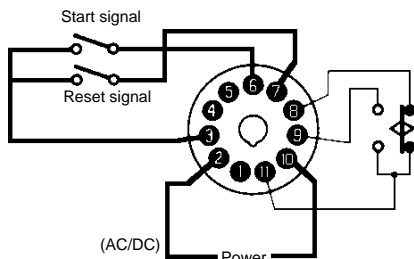

Mode G Signal ON-delay/OFF-delay

Power is continuously applied. Timing begins on both the leading and trailing edges of the start input. The output relay is energized when the accumulated time from the leading edge equals the set time. It is also energized for the set amount of time from the trailing edge of the start input.

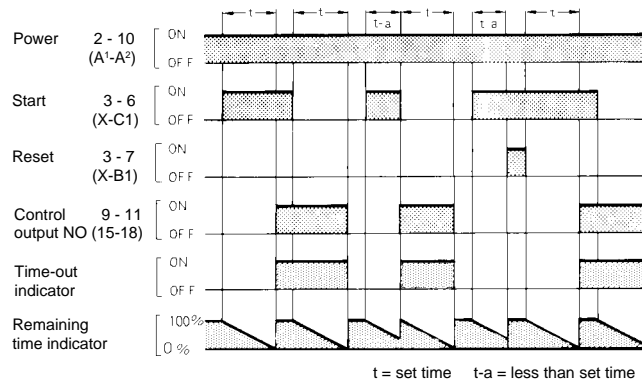
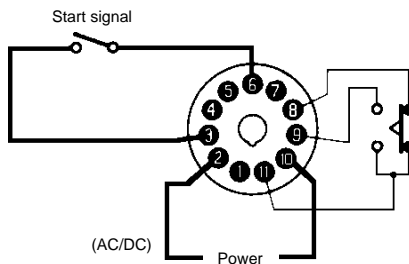

In the schematic diagrams, each **thick line** indicates the external wiring necessary for the selected operation.

Mode H Signal OFF-Delay (II)

Power is continuously applied. Timing starts at the trailing edge of the start input. The output relay is energized during timing.

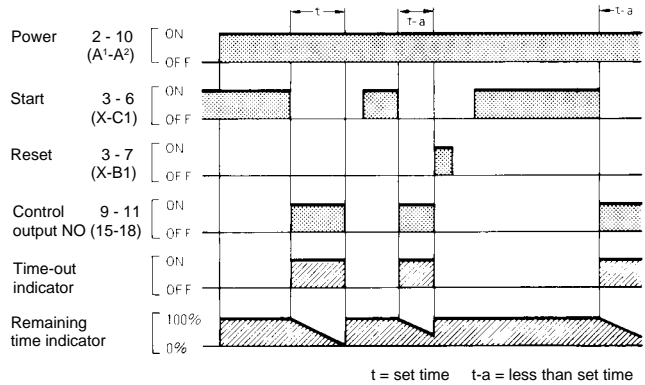
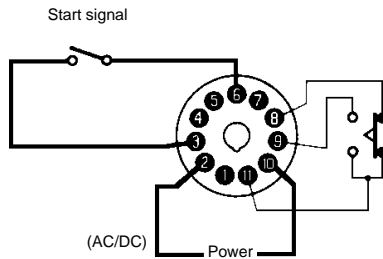

■ H3CA-8

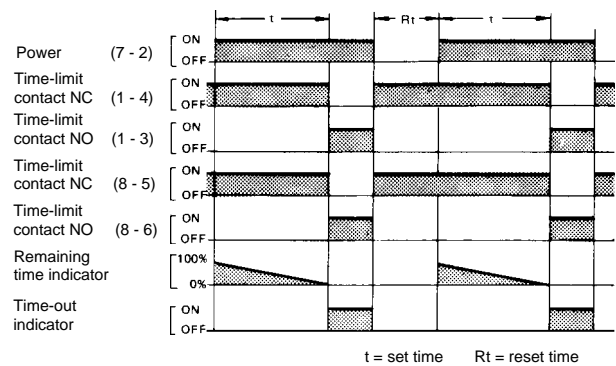
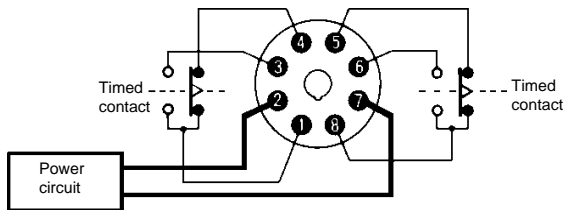

■ H3CA-8H

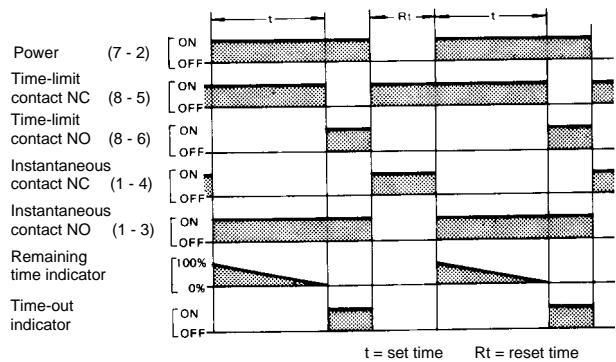
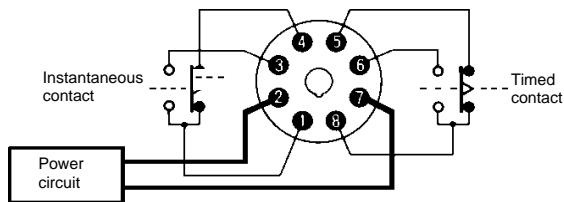

Dimensions

Unit: mm (inch)

■ TIMERS

H3CA-A

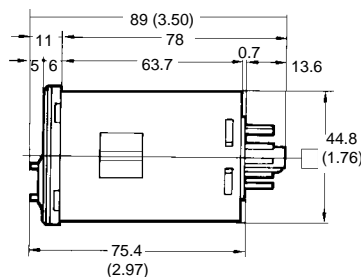
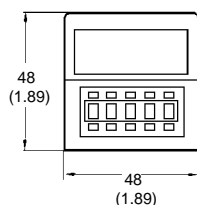
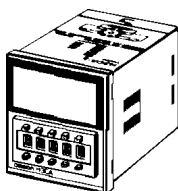

Panel cutout

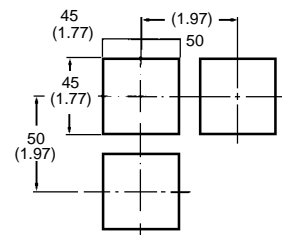

Note: Recommended panel thickness is 1 to 3.2 mm.

Panel cutout conforms to DIN 43700.

In the schematic diagrams, each **thick line** indicates the external wiring necessary for the selected operation.

■ H3CA-FA

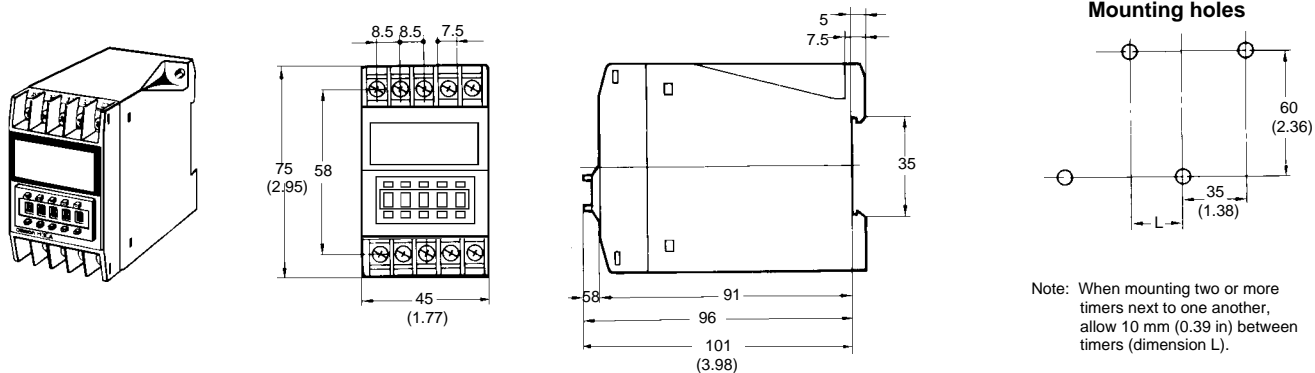

■ H3CA-8, H3CA-8H

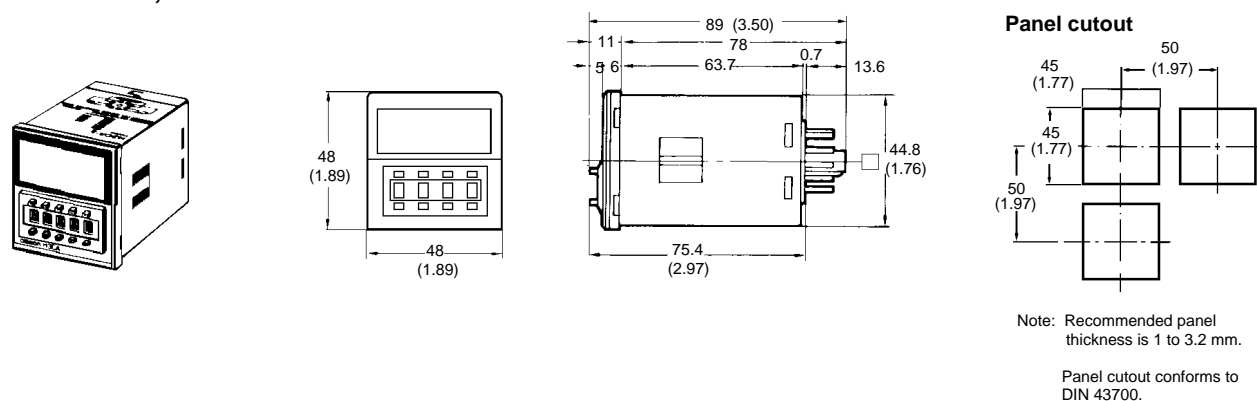

■ SOCKETS

11-Pin Sockets for H3CA-A

P2CF-11 Bottom surface or track mounting socket

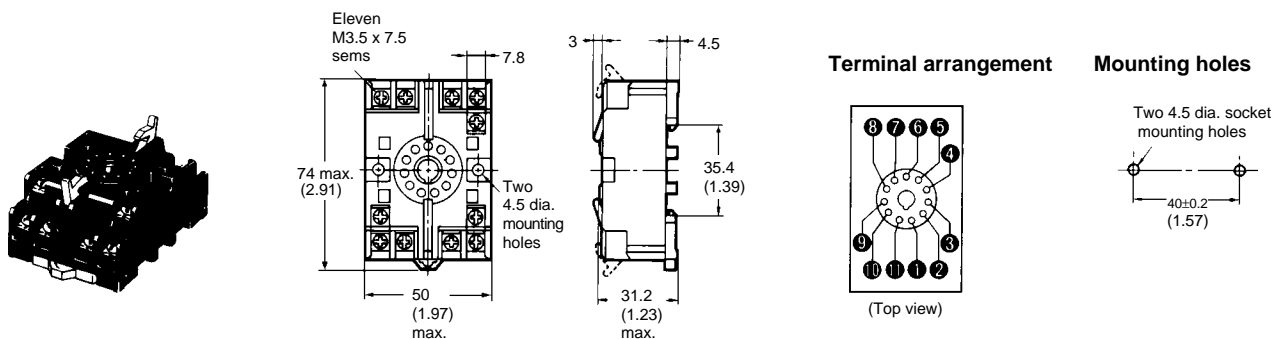

P3GA-11 Back Mounting Socket

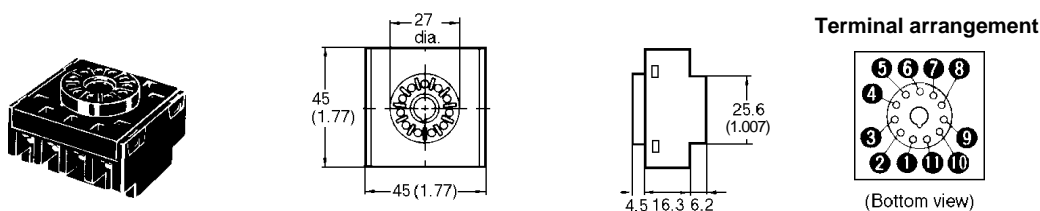

8-Pin Sockets for H3CA-8, H3CA-8H

P2CF-08 Bottom surface or track mounting

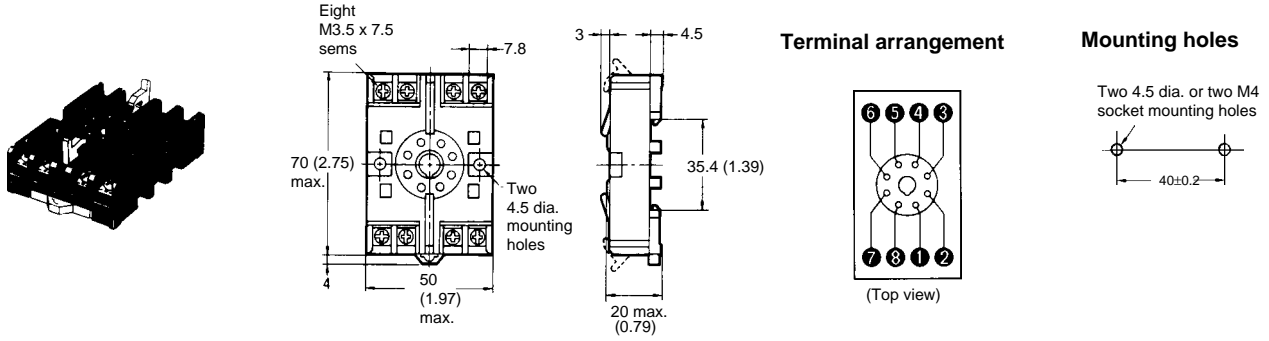

P3G-08 Back mounting socket

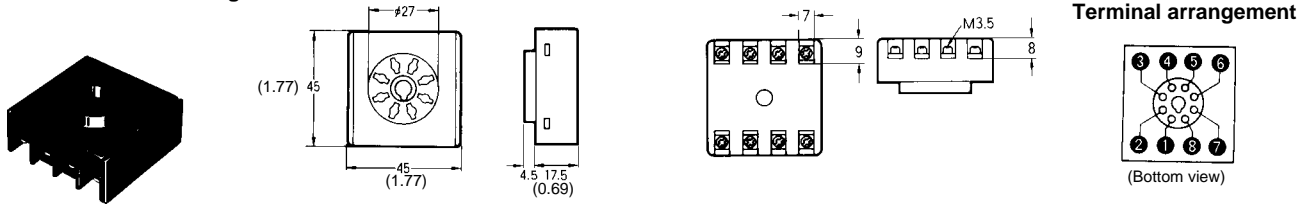

■ PANEL MOUNTING ADAPTERS

For H3CA, H3CA-8, H3CA-8H

Y92F-30 Mounting Adapter

Adapter installs behind the panel. It is ideal for side by side installation. Use P3GA-11 or P3G-08 sockets.

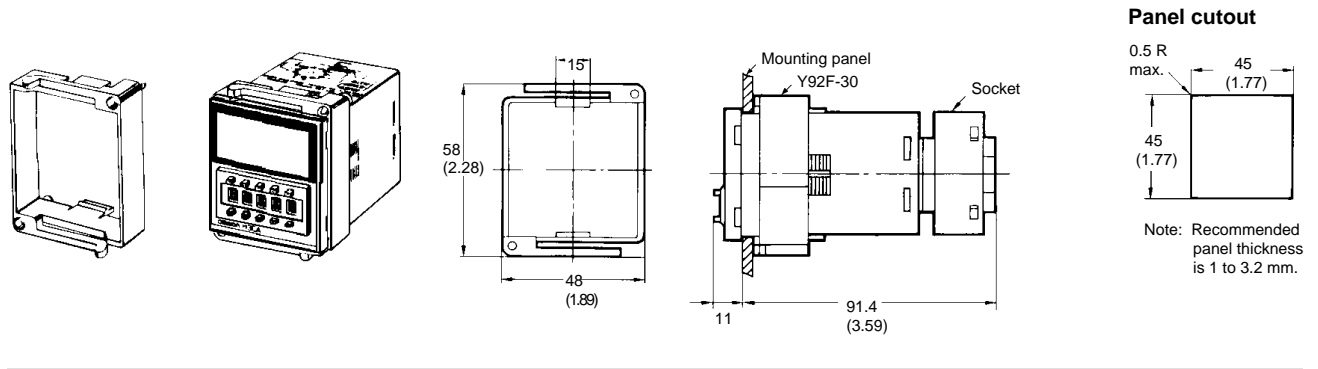

Y92F-70 Mounting Adapter

Charcoal gray panel adapter installs through panel front. Timer fits bezel, rear of timer clips to adapter. Use P3GA-11 or P3G-08 sockets.

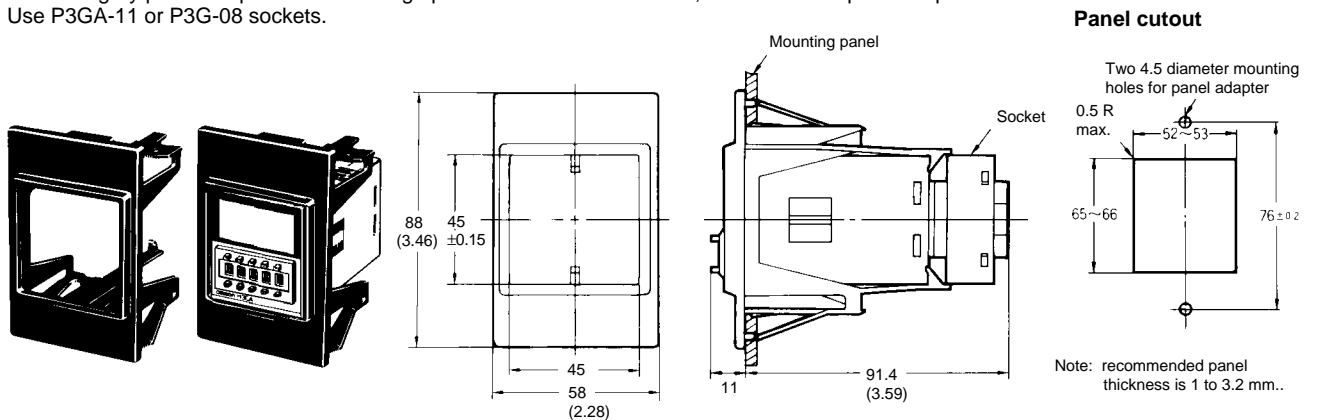

Y92F-71 Mounting Adapter

Charcoal gray panel adapter installs through panel front. Timer face fits bezel, rear of timer clips to adapter. Use P3GA-11 or P3G-08.

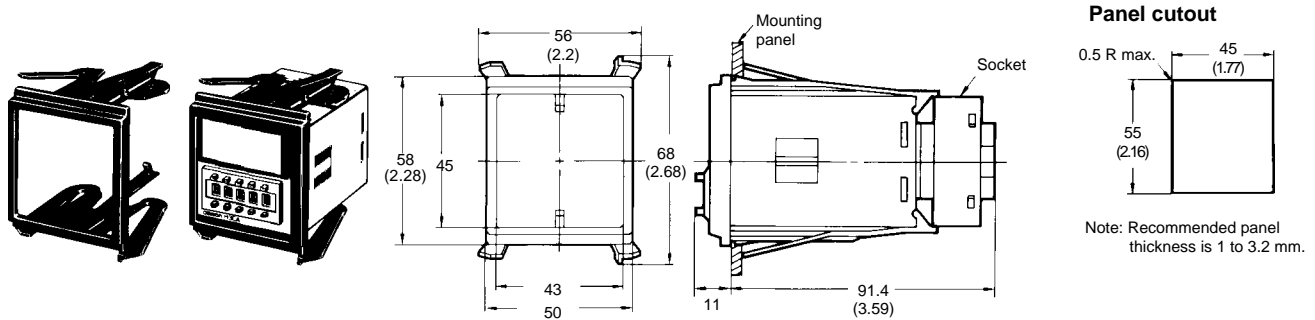

PROTECTIVE COVERS

Y92A-48B Hard Plastic Cover

Y92A-48D Soft Plastic Cover

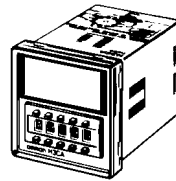
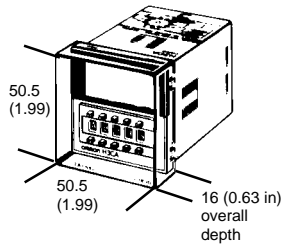

Hard plastic cover Y92A-48B and soft plastic cover Y92A-48D snap onto the front of the timer to protect against dust and water. The Y92A-48B hard plastic cover prevents accidental resetting. Y92A-48D soft plastic cover fits snugly over the front and allows settings to be changed. These covers are intended for use in areas where unusual service conditions do not exist.

MOUNTING TRACK AND ACCESSORIES

PFP-100N/PFP-50N DIN Rail

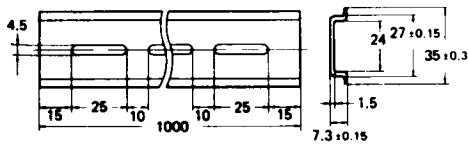

PFP-M End Plate

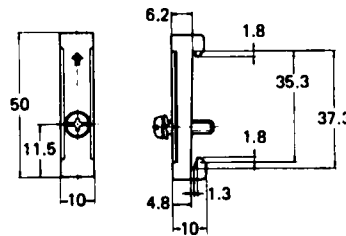

PFP-S Spacer

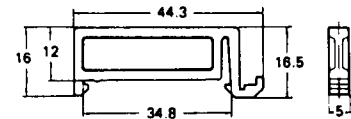

Connections

Part number	Input terminal numbers (no-voltage only)					Power supply terminal numbers		Output terminal numbers			
	Gate	Start	Reset	Check	COM	AC (common), DC-	AC (hot), DC+	Type	COM	NC	NO
H3CA-A	5	6	7	4	3	2	10	Timed contact	11	8	9
H3CA-FA	D1	C1	B1	E1	X	A2	A1	Timed contact	15	16	18
H3CA-8H	-	-	-	-	-	2	7	Instantaneous	1	4	3
								Timed contact	8	5	6
H3CA-8	-	-	-	-	-	2	7	Timed contact	1	4	3
								Timed contact	8	5	6

CONTACT SIGNAL INPUTS

Input Signal Requirements

Resistance	1 KΩ max.
Residual voltage	1 V max. when the contact makes
Contact material	Gold-plated contacts recommended

H3CA-A

- Start input contact between terminals 3 and 6.
- Reset input contact between terminals 3 and 7.
- Gate input contact between terminals 3 and 5.
- Check input contact between terminals 3 and 4.

H3CA-FA

- Start input contact between terminals X and C1.
- Reset input contact between terminals X and B1.
- Gate input contact between terminals X and D1.
- Check input contact between terminals X and E1.

H3CA-A

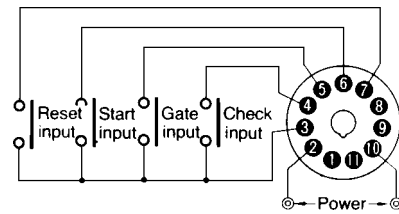

H3CA-FA

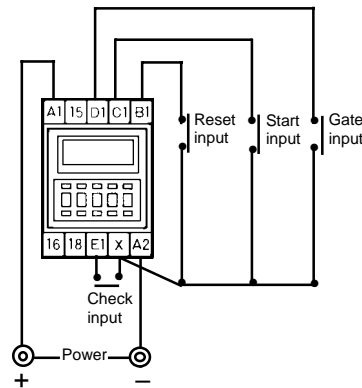

SOLID-STATE SIGNAL INPUTS

Input Signal Requirements

Input type	Open collector transistor
Voltage when collector is OFF	20 V min.
Saturated voltage when transistor is ON	1 V max.
Collector current	50 mA max.
Input current between collector and base	0.5 μA max.
Resistance when transistor is ON	1 KΩ max.
Residual voltage when transistor is ON	1 V max.
Resistance when transistor is OFF	200 KΩ min.

H3CA-A and H3CA-FA

Solid-state input terminal connections are the same as those for contact signal inputs.

Solid-State Inputs (Not Open Collector Type)

Proximity and photoelectric sensors often have NPN or PNP type solid-state output circuits and rated supply voltages ranging from 6 to 30 VDC. These signals are applied to the timer according to the diagram below.

Solid-state circuit (proximity sensor, proximity sensor, etc.)

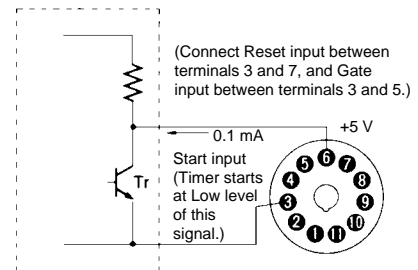

CUMULATIVE TIMING

Using the Gate Input with ON-Delay

When the gate signal is closed, timing is temporarily stopped. When the gate signal opens, timing resumes at the point of interruption. The gate input terminal permits the timer to sum up times t_1 and t_2 as shown in the timing chart.

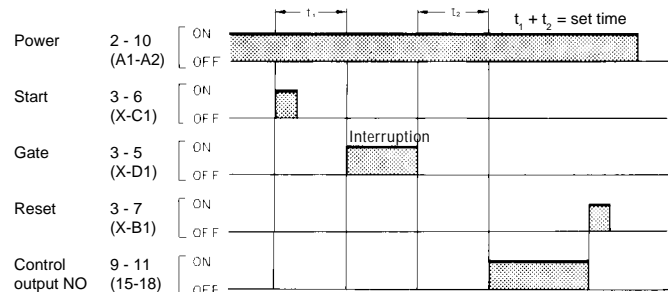

■ CHECK INPUT

ON-Delay Operation

When a no-voltage input signal is applied to the timer during the lapse of a set time, the remaining set time will become 0 and the timer will enter the next control state. Also, while the Check Signal is applied, the elapsed time measurement of the set time is not performed. The Check input is especially useful where ON-delay override may be desirable.

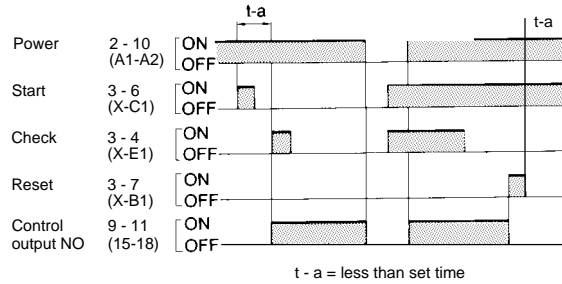

Repeat Cycle Operation

The Check input signal in Repeat cycle mode allows the timer to be used like a binary flip-flop or alternating relay. Set an unattainable time, such as 999 hours. Apply the no-voltage Check input to shift output status from ON to OFF, or vice-versa. Jumper terminals 3 and 6 (X and C1) to short the start function. The Check input then controls the output relay like a flip-flop or alternating relay. This may be used to alternate wear on main and secondary equipment such as pumps.

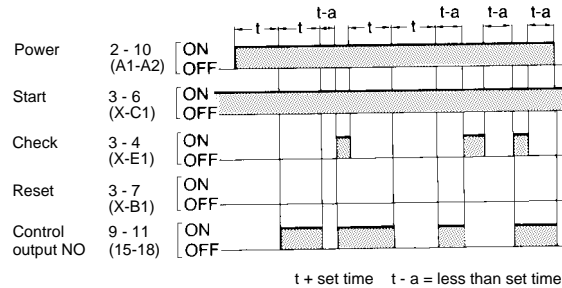

Installation

■ PROPER INPUT CONNECTIONS (H3CA-A, H3CA-FA)

The neutral or common of the power supply is connected to terminal 2 (A2) of the timer. Terminal 10 (A1) should be connected to the "hot" or positive of the power supply. Do not apply voltage to Check, Gate, Start and Reset inputs. These are no-voltage type inputs.

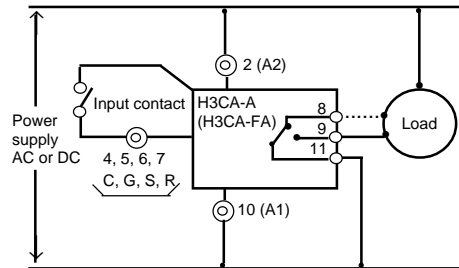

■ PROPER OUTPUT CONNECTIONS

Design your control circuit using the output relay contacts to switch the load. **Never switch a load with the contact that is being used as an input signal.** The timer's circuitry may be damaged.

■ PARALLEL CONNECTIONS

Parallel connection of two or more Omron Timers is possible as shown by the diagram to the right.

This will allow the simultaneous start or restart of multiple timers using a single switch for the Start Input and a single switch for the Reset Input.

It is possible to wire only up to 4 timers in this manner. Wiring more than 4 results in poor performance due to excessive voltage drop.

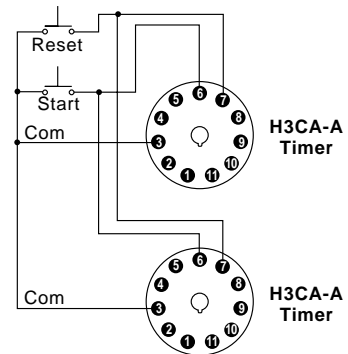

Operation

■ SELECTING TIME RANGE

Use the rightmost pushwheel switch to select the time range. Use the three center pushwheel switches to select the time setting between 000 and 999. For ranges with 0.1 time units, the decimal point is assumed to be between middle and right digits.

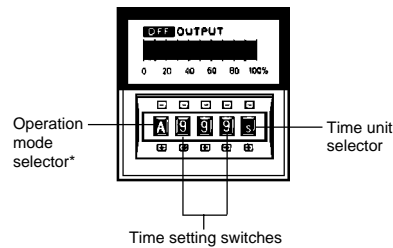

Time unit	Timing range
0.1 s	0.1 to 99.9 seconds
s	1 to 999 seconds
0.1 m	0.1 to 99.9 minutes
m	1 to 999 minutes
0.1 h	0.1 to 99.9 hours
h	1 to 999 hours
10 h	10 to 9990 hours

Note: *Operation mode selector not included with ON-delay timers.

■ SELECTING OPERATION MODES (H3CA-A, H3CA-FA)

The operation mode is selected by the leftmost pushwheel switch.

Mode	Operation
A	ON-delay
B	Repeat cycle
C	Signal Interval/OFF-delay
D	Signal OFF-delay I
E	Interval
F	Cycle
G	Signal ON-delay/OFF-delay
H	Signal OFF-delay II

■ CAUTIONS

Do not change the time unit or time range while the timer is in operation. Otherwise, the timer may malfunction or be damaged. Be sure to turn off the power supply to the timer before changing any of the selections.

Mounting

■ PANEL MOUNTING

Using Y92F-30 Adapter

Insert the timer through the panel cutout. Push the Y92F-30 adapter from the rear of the timer as far forward toward the panel as possible. Wire the P3G□-□□ socket, then push it onto the rear of the timer. Then, tighten the two retaining screws. To release the adapter, lift the tab at the rear of the adapter.

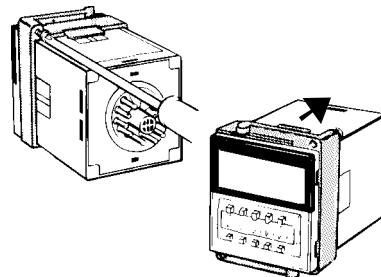

Several timers may be mounted close together using Y92F-30 adapter as shown here. When mounting two or more timers in a vertical line, arrange the adapters so that their molded tabs are positioned on the right and left sides. When mounting two or more timers in a horizontal line, arrange the adapters so that their molded tabs are positioned on the top and bottom sides.

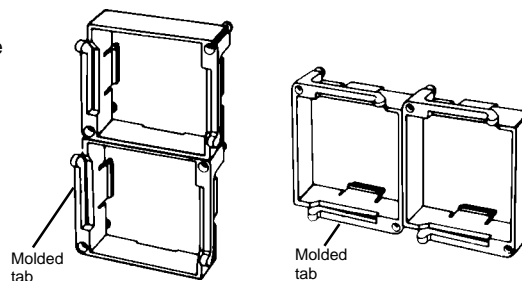

Panel cutout for side-by-side mounting of two timers

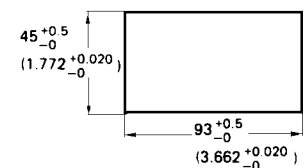

Using Y92F-70 and Y92F-71 Adapters

Install the H3CA timer, face first, into the back side of the Y92F-70 or Y92F-71 adapter so the bezel fits snugly. Be sure the retaining clips at the back of the adapter fit into the slots on either side of the timer. Compress the top and bottom tabs of the adapter then push the adapter through the front side of the panel cutout. Be sure the tabs extend after installation for a secure fit.

To remove the timer from the adapter, unclip the two retaining clips at the back of the adapter. To remove the adapter and timer from the panel as a unit, compress the tabs behind the panel and push the unit out the front of the panel.

Installation

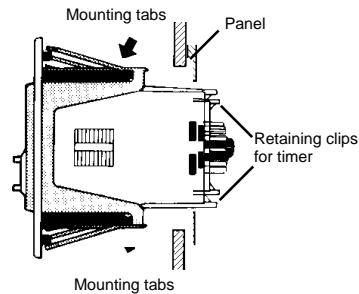

Removal

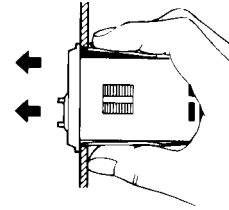

■ TRACK MOUNTING

H3CA-FA with Built-In Track Adapter

Mounting

First hook part "A" on the rear of the timer onto an edge of the track. Then, press the timer in direction "B" until the latch on the bottom rear of the timer locks securely.

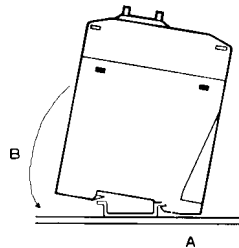

Removal

Pull the latch "C" with a flat-blade screwdriver and remove the timer from the mounting track.

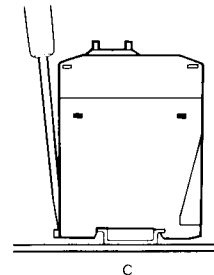

P2CF-□□ Socket

For H3CA-A, H3CA-8 and H3CA-8H

Mounting

The P2CF-□□ socket has two hooks that secure the timer to the socket. Be sure to allow at least 20 mm (0.79 in) clearance above and below the socket to gain access and to release the hooks for servicing and maintenance. Insert timer into the socket. Latch hooks. Then clip rear of the socket to the track. Push the bottom onto the track until the latch hooks securely.

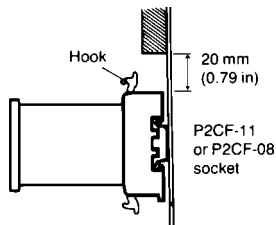

Removal

Pull the latch on the socket with a flat-blade screwdriver and remove the timer and socket as one unit.

NOTE: ALL DIMENSIONS ARE IN MILLIMETERS. To convert millimeters into inches divide by 25.4.

OMRON

Omron Europe B.V. EMA-ISD, tel:+31 23 5681390, fax:+31 23 5681397, <http://www.eu.omron.com/ema>