

OMRON

Ultra Small Multi-code Reader

V400-R2 Series

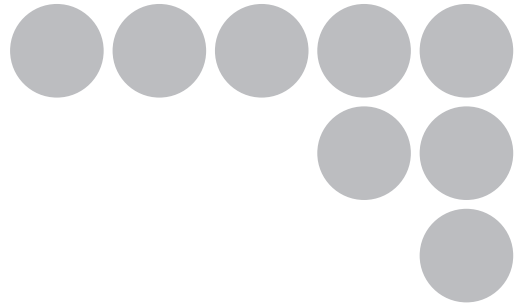

User's Manual



Cat. No. Z333-E1-02

Introduction

Thank you for purchasing the OMRON V400-R2 series.

This manual describes the functions, performance, and application methods of the V400-R2 series.

This manual is intended for personnel with knowledge of electrical systems. Be sure to read and understand this manual thoroughly before using the product, and keep this manual in an easily accessible location for quick reference when required.

Introduction	Terms and Conditions Agreement (Be sure to read this.)	Introduction
Section 1	Product Overview	Section 1
Section 2	Introduction Procedure	Section 2
Section 3	Basic Knowledge of Operation	Section 3
Section 4	Setting Method	Section 4
Section 5	Appendix	Section 5

Multi-code Reader User's Manual

V400-R2 series

Terms and Conditions Agreement

Warranty, Limitations of Liability

Warranties

- **Exclusive Warrant**

Omron's exclusive warranty is that the Products will be free from defects in materials and workmanship for a period of twelve months from the date of sale by Omron (or such other period expressed in writing by Omron). Omron disclaims all other warranties, express or implied.

- **Limitations**

OMRON MAKES NO WARRANTY OR REPRESENTATION, EXPRESS OR IMPLIED, ABOUT NON-INFRINGEMENT, MERCHANTABILITY OR FITNESS FOR A PARTICULAR PURPOSE OF THE PRODUCTS. BUYER ACKNOWLEDGES THAT IT ALONE HAS DETERMINED THAT THE PRODUCTS WILL SUITABLY MEET THE REQUIREMENTS OF THEIR INTENDED USE.

Omron further disclaims all warranties and responsibility of any type for claims or expenses based on infringement by the Products or otherwise of any intellectual property right.

- **Buyer Remedy**

OMRON MAKES NO WARRANTY OR REPRESENTATION, EXPRESS OR IMPLIED, ABOUT Omron's sole obligation hereunder shall be, at Omron's election, to (i) replace (in the form originally shipped with Buyer responsible for labor charges for removal or replacement thereof) the non-complying Product, (ii) repair the non-complying Product, or (iii) repay or credit Buyer an amount equal to the purchase price of the non-complying Product; provided that in no event shall Omron be responsible for warranty, repair, indemnity or any other claims or expenses regarding the Products unless Omron's analysis confirms that the Products were properly handled, stored, installed and maintained and not subject to contamination, abuse, misuse or inappropriate modification. Return of any Products by Buyer must be approved in writing by Omron before shipment. Omron Companies shall not be liable for the suitability or unsuitability or the results from the use of Products in combination with any electrical or electronic components, circuits, system assemblies or any other materials or substances or environments. Any advice, recommendations or information given orally or in writing, are not to be construed as an amendment or addition to the above warranty.

Omron further disclaims all warranties and responsibility of any type for claims or expenses based on infringement by the Products or otherwise of any intellectual property right.

See <http://www.omron.com/global/>

or contact your Omron representative for published information. LIMITATIONS OF LIABILITY

Limitation on Liability; Etc

OMRON COMPANIES SHALL NOT BE LIABLE FOR SPECIAL, INDIRECT, INCIDENTAL, OR CONSEQUENTIAL DAMAGES, LOSS OF PROFITS OR PRODUCTION OR COMMERCIAL LOSS IN ANY WAY CONNECTED WITH THE PRODUCTS, WHETHER SUCH CLAIM IS BASED IN CONTRACT, WARRANTY, NEGLIGENCE OR STRICT LIABILITY.

Further, in no event shall liability of Omron Companies exceed the individual price of the Product on which liability is asserted.

Application Considerations

Suitability of Use

Omron Companies shall not be responsible for conformity with any standards, codes or regulations which apply to the combination of the Product in the Buyer's application or use of the Product. At Buyer's request, Omron will provide applicable third party certification documents identifying ratings and limitations of use which apply to the Product. This information by itself is not sufficient for a complete determination of the suitability of the Product in combination with the end product, machine, system, or other application or use. Buyer shall be solely responsible for determining appropriateness of the particular Product with respect to Buyer's application, product or system. Buyer shall take application responsibility in all cases.

NEVER USE THE PRODUCT FOR AN APPLICATION INVOLVING SERIOUS RISK TO LIFE OR PROPERTY WITHOUT ENSURING THAT THE SYSTEM AS A WHOLE HAS BEEN DESIGNED TO ADDRESS THE RISKS, AND THAT THE OMRON PRODUCT(S) IS PROPERLY RATED AND INSTALLED FOR THE INTENDED USE WITHIN THE OVERALL EQUIPMENT OR SYSTEM.

Programmable Products

Omron Companies shall not be responsible for the user's programming of a programmable Product, or any consequence thereof.

Disclaimers

Performance Data

Data presented in Omron Company websites, catalogs and other materials is provided as a guide for the user in determining suitability and does not constitute a warranty. It may represent the result of Omron's test conditions, and the user must correlate it to actual application requirements. Actual performance is subject to the Omron's Warranty and Limitations of Liability.

Change in Specifications

Product specifications and accessories may be changed at any time based on improvements and other reasons. It is our practice to change part numbers when published ratings or features are changed, or when significant construction changes are made. However, some specifications of the Product may be changed without any notice. When in doubt, special part numbers may be assigned to fix or establish key specifications for your application. Please consult with your Omron's representative at any time to confirm actual specifications of purchased Product.

Errors and Omissions

Information presented by Omron Companies has been checked and is believed to be accurate; however, no responsibility is assumed for clerical, typographical or proofreading errors or omissions.

Safety Precautions

- Meanings of safety symbols

In this operation manual, precautions are indicated using the following symbols and signal words to ensure safe use of the V400-R2 series. The precautions indicated by these symbols and signal words are important to ensure safety and must be observed.

The symbols and signal words are as follows:



Indicates a potentially hazardous situation which, if not avoided, will result in minor or moderate injury, or may result in serious injury or death. Additionally there may be significant property damage.

- Meanings of alert symbols



Indicates general prohibitions for which there is no specific symbol.

- Warning display



This product is not designed or rated for ensuring safety of persons.
Do not use it for such purposes.



Regulations and Standards

This product complies with the following standards.

LED safety standard	IEC 62471-1:2006 Risk exempt group
EN standard (CE mark)	EN55022/EN55024

Precautions for Safe Use

Observe the following precautions to ensure safe use of the product.

1. Installation Environment

- Do not use the product in environments containing flammable or explosive gases.
- Do not use the product in environments containing corrosive or combustible gases.
- Do not use the product in environments containing dust, salt, or metallic powders.
- Do not use the product in environments containing droplets, water or mist, oil or chemical agents.
- Do not use the product in environments that may be affected by a CRT's flashing or other ambient light.
- Do not install or use the product outdoors.
- For the purpose of ensuring safe operation and maintenance, do not install the product close to high-voltage devices or electrically powered devices.

2. Power Supply and Wiring

- To assure noise and insulation resistance, be sure to use S8VS-01505 (made by OMRON) as a driving power supply.
- Do not connect a voltage or AC power supply that has a voltage exceeding the rating voltage (5 V \pm 10%).
- Avoid reverse connection of power supply. Do not short circuit a load on OK/NG output signal (open collector).
- Avoid applying a load that exceeds the rating.
- Be sure to turn the power OFF before connecting or disconnecting a cable. Connecting or disconnecting a cable while the power is ON may cause failure.
- Connect different cables from high-voltage or power cables to the product. If the same cable or duct is used, electromagnetic induction may result, which may result in malfunction or damage.
- Tighten the fixing screws at the torque specified in this manual.

3. Communication with Upper Equipment

- Check that the product has started up, and then start communication with upper equipment.
- Indefinite signals may be generated from the upper interface while the product starts up. Clear the receive buffer of the devices before starting initial operation.

4. Other

- Do not use the product in a safety circuit for nuclear or life-support systems.
- Never attempt to disassemble, repair, modify, deform by applying pressure, or burn the product.
- Dispose of the product as industrial waste.
- If the product becomes extremely hot, or abnormal odors or smoke are emitted, stop using the product immediately, turn the power OFF, and consult with your OMRON representative.

Precautions for Correct Use

Always observe the following precautions to prevent operation failures, malfunctions, and adverse effects on performance and equipment.

1. Installation location

- The product must not be installed in a place:
 - where ambient temperature is outside the range defined in the specifications,
 - where a rapid temperature change (dew condensation) occurs,
 - where ambient humidity is outside the range defined in the specifications,
 - where direct vibration or shock may affect the product,
 - where exposed to intense ambient light (laser, arc welding, or UV light),
 - where exposed to direct sunlight or heat from heating appliances, and
 - where a strong magnetic or electric field exists.

- Because of the protection rating described in the manual, avoid using locations containing:
 - corrosive or combustible gases,
 - dust, salt, or metallic powders,
 - droplets, water mist, oil or chemical agents.

2. Power supply, connection, and wiring

- Be sure to use S8VS-01505 (made by OMRON) as a driving power supply.
- Do not install the product in a location where a high-voltage device is installed.
- Be sure to use the supplied insulation board to assure the noise resistance.
- After connecting the cables, check that the correct power supply is used, that there is no load short-circuiting or other inappropriate connections, and that the load current is correct before turning the power ON. Faulty wiring may be the cause of failure.
- Use a wrist strap or other similar device to avoid electrostatic charge when you touch terminals and signal lines within a connector, and to avoid damage due to static electricity.
- Try to keep the length of the power cable to a minimum (less than 3 m).

3. Labels

- For labels with a highly gloss surface, reading errors may occur because of regular reflection of the LED light. If this occurs, provide a skew angle of 15° against the label.

4. Cleaning of the reading window

- Install the product so that the front area of the reading window is free of dust and oil droplets.

If dust or oil droplets are found, clean the surface using the following method.

- Blow large particles off using a blower brush (for camera lenses).
Do not blow using your own breath.
- Gently wipe off small particles using a soft cloth (lens wiper) moistened with a small amount of alcohol. Avoid vigorous wiping. Scratches on the reading window may result in reading errors.

How to Use This Manual

Part names of a code

In this manual, each part of a code is described as follows.

Bar code

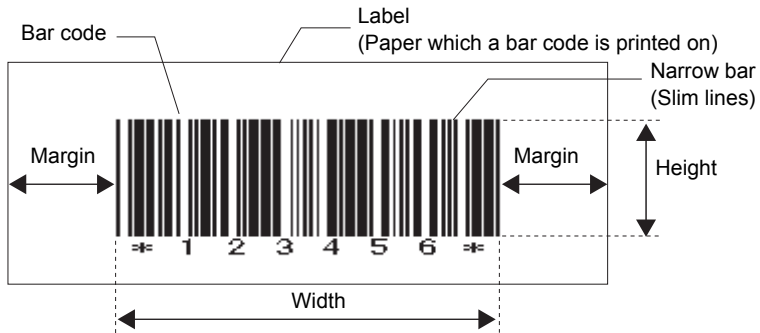

2D code

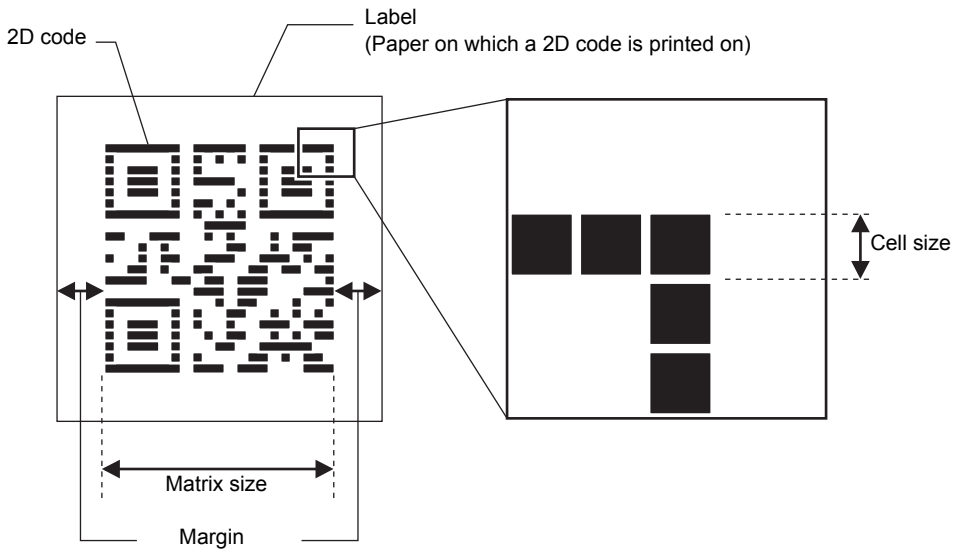

Page format

Section 2
Introduction Procedure

Preparation

This section describes the setting method based on preliminary examination. Perform a test to check whether the intended code is read and set the reading conditions for the purpose.

Testing

You can check how stably the intended code can be read. Read the code at rest ten times and calculate the reading rate.

■ **Entering the reading rate measurement mode**

- Place the code in the reading position.
- Input the command "[X]U8".
The reader enters the reading rate measurement mode. The reading rate in every 10 reading operations is measured.
- To exit the reading rate measurement mode, restart the reader.
The reader returns to the normal measurement mode.
Do not execute write command "Z2" to nonvolatile memory.
A sample setting condition is overwritten and stored, which erases the already set reading condition.

Output format

In reading rate measurement mode, the reading rate in every 10 reading operations is output continuously to the upper equipment.

10/10
ABCDEF—

The number of times of successful decoding (no verification)
10 reading tries

Correct reading data

Communication data format

Header	SPACE	*	*	1	0	/	1	0	SPACE	*	*	SPACE	Footer
	[2AH]	[2AH]	[2AH]	[31H]	[31H]	[2FH]	[31H]	[31H]	[20H]	[2AH]	[2AH]	[20H]	

Header Correct reading data Footer

Footer

V400-R2 series
User's Manual 35

Operation procedure and additional explanation

Shows the operation procedure.

Tips and reference pages that may be useful during operation are indicated with a mark.



* This page does not actually exist.

Visual Aids



CHECK!

Indicates points that are important for using product functions or in application procedures.



Indicates page numbers providing related information.



Indicates information helpful for problem solving or explanation of technical terms.

Copyrights and Trademarks

- QR Code is a registered trademark of DENSO WAVE INCORPORATED in JAPAN and other countries.
- Other system names and product names that appear in this manual are the trademarks or registered trademarks of the respective companies.

Contents



Introduction	
Terms and Conditions Agreement	2
Warranty, Limitations of Liability	2
Application Considerations	3
Disclaimers	3
Safety Precautions	4
Regulations and Standards	5
Precautions for Safe Use	6
Precautions for Correct Use	8
How to Use This Manual	10
Visual Aids	12
Contents	13
Section 1 Product Overview	15
Features	16
Basic Configuration	18
Part Names and Functions	19
Section 2 Introduction Procedure	21
Introduction Flow Chart	22
Preliminary Examination	24
Wiring and Connection	31
Preparation	37
Installation and Reading	42
Section 3 Basic Knowledge of Operation	45
Operation Flow Chart	46
Communication Data Format	52

Section 4	Setting Method	55
	How to Use a Menu Sheet/Command	56
	Menu Sheet/Command List	58
Section 5	Appendix	99
	Maintenance	100
	Troubleshooting	101
	Specifications and External Dimension	102
	ASCII Code Table	108
	Quick-Reference Tables of Data Capacities	109

Section 1

Product Overview

This section explains the features, ratings, and performance of this product.

 Features	16
 Basic Configuration	18
 Part Names and Functions	19

Features

This product is an ultra-compact, setup-free multi-code reader that reads most 2D and 1D symbols on paper or labels. Various types of information can be managed efficiently by using it with a PC and programmable controllers.

- A setup-free multi-code reader that recognizes most 1D and 2D codes printed on paper or labels

It can read various 1D and 2D codes without requiring special settings.

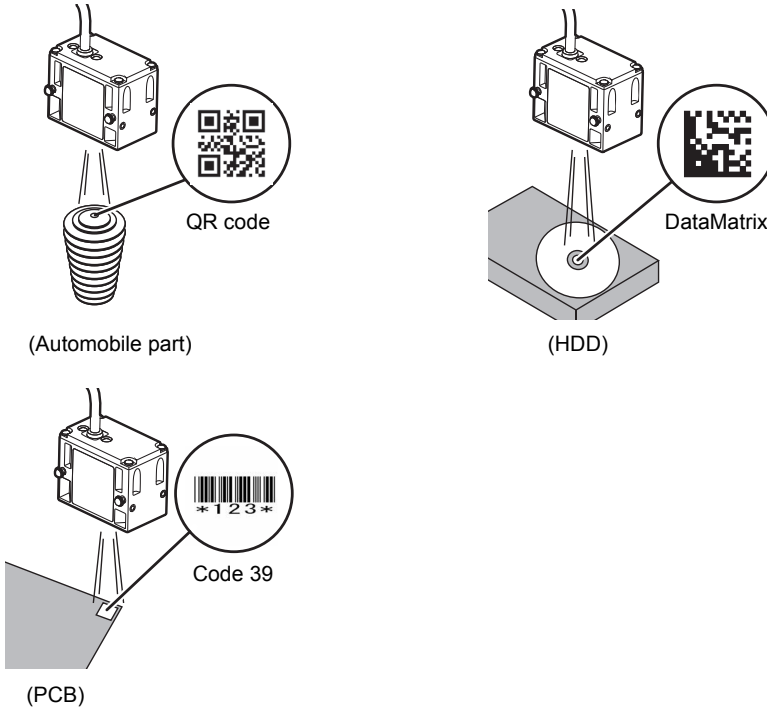

- A 0.36-mega pixel CMOS image sensor

Readable barcodes and 2-dimensional barcodes are shown below.

Model	bar codes	2D codes
V400-R2CF65	0.076 mm	0.169 mm
V400-R2CF125	0.127 mm	0.212 mm

- Green LED aiming function

The green LED aiming function quickly recognizes the area to be read.

- Ultra-compact body for highly flexible installation

The main body is very small, only 41.1 mm × 33 mm × 24 mm.

The front and side view types are available to suit your installation environment.

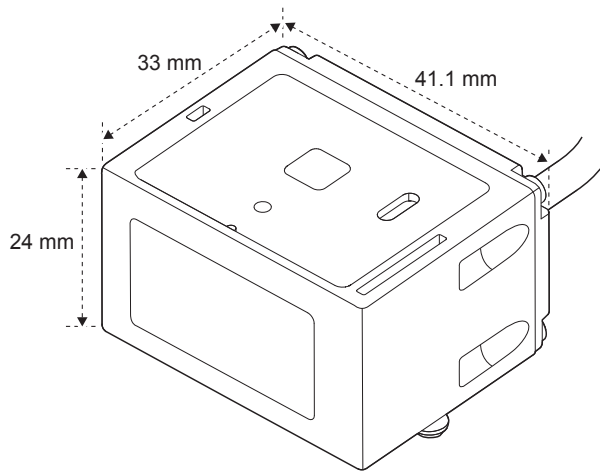

V400-R2 series

Basic Configuration

This product is used by connecting with upper equipment such as a PC and programmable controllers.

The upper equipment receives the information this product reads, and records and verifies it with the registered information.

The cable has a connector at the end. Use the appropriate connecting cable for the upper equipment.

Multi-code reader
V400-R2 series

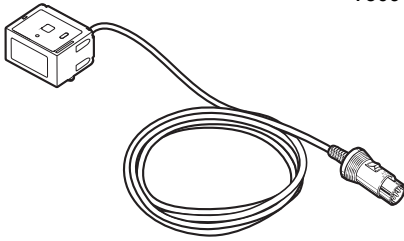

Cable for connecting PC/AT compatible
V509-W011D

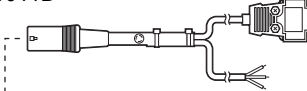

PC/AT compatible



p.33

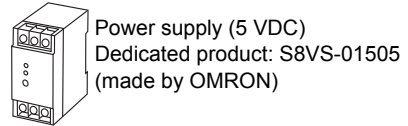

Programmable controller

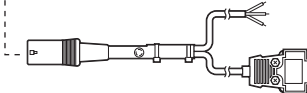

Programmable controller made by OMRON p.34
Connecting cable
V509-W011

Part Names and Functions

This section explains the names and functions of each part.

V400-R2 series

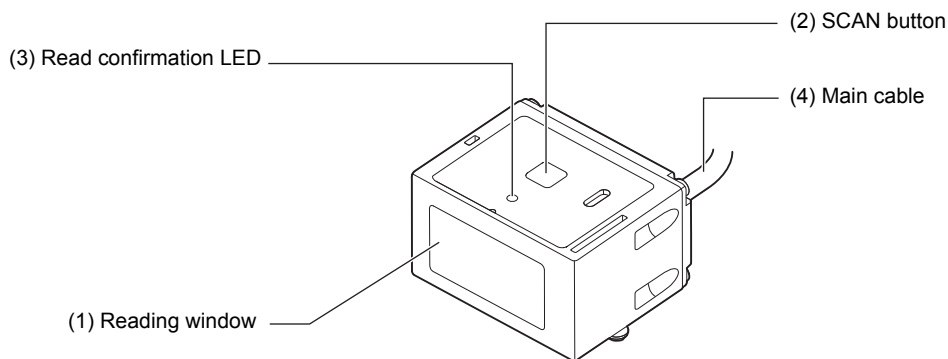

No.	Part name	Function
(1)	Reading window	Aiming light and illumination LED light is emitted from here for capturing images.
(2)	SCAN button	The button for performing a reading test. Pressing it once performs reading once.
(3)	Read confirmation LED	LED (green) illuminates when reading is successful.
(4)	Main cable	Connected to a cable for connecting PC/AT compatible or a programmable controller made by OMRON. The length is 1.5 m.

MEMO

Section 2

Introduction Procedure

A flow chart of preliminary examination, installation, and introduction of the product is as shown below.

☒ Introduction Flow Chart	22
☒ Preliminary Examination	24
☒ Wiring and Connection	31
☒ Preparation	37
☒ Installation and Reading	42

Introduction Flow Chart

A flow chart of preliminary examination, installation, and introduction of the product is as shown below.

Preliminary examination

Check the type, width, height, and the number of digits of 2D codes and bar codes.

- p.24 Supported code list
- p.27 Reading range performance
- p.29 Reading angle performance



Wiring and connection

Complete wiring.

- p.31 Pin arrangement and input/output circuit

Connect peripheral equipment.

- p.33 Example of connection with a PC
- p.34 Example of connection with programmable controller (CS1)

Turn on the power switch.

Preparation

Press the SCAN button to check whether the code is read.

- p.37 Testing

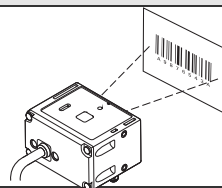

Investigate the reading timing.

- p.38 Investigation into the reading timing
- p.46 Basic operation flow chart

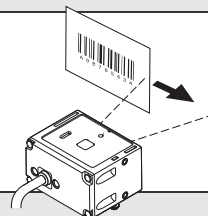

Set the reading condition corresponding to the purpose.

- p.39 Setting the reading conditions
- p.58 Menu Sheet/Command List

Installation
and reading

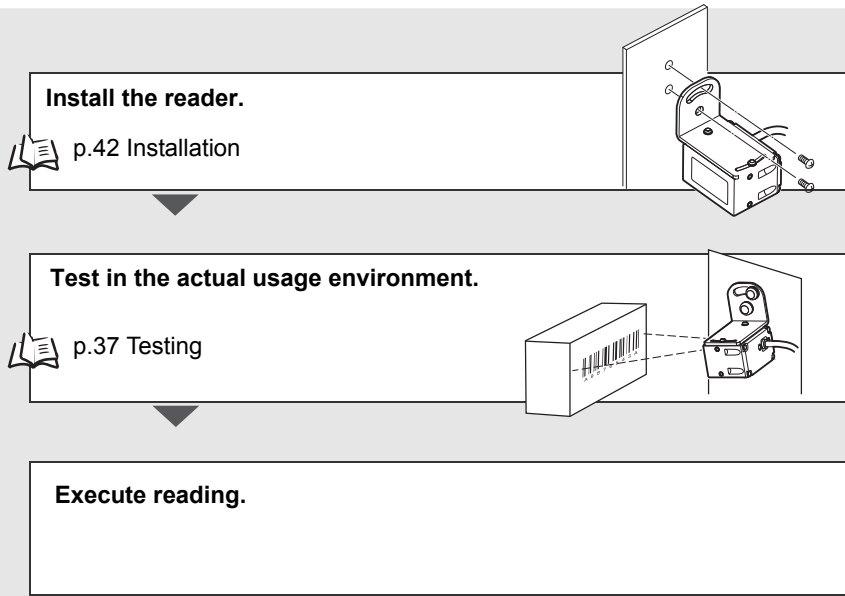

In case of trouble:

I do not know the communication specification.
p.52 Communication Data Format

I cannot understand the operation flow.
p.46 Operation Flow Chart

Preliminary Examination

The following are typical specifications you should consider.

Check the type, width, height, and the number of digits of 2D codes and bar codes while considering the supported codes, reading range performance, and reading angle performance.

Supported code list

■ 2D code

▪ DataMatrix



- ECC200
- 10 × 10 to 64 × 64
- 8 × 18 to 16 × 48

▪ QR code



- Models 1 and 2
- 21 × 21 to 57 × 57
- (Versions 1 to 10)

▪ Micro QR code



- 11 × 11 to 17 × 17

▪ PDF417



▪ Micro PDF417



▪ Aztec Code



▪ Maxi Code



▪ Codablock-F

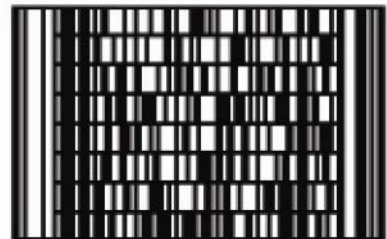

■ Bar codes

- JAN/EAN and UPC



- CODE39



- Industrial2of5(STF)



- Codabar(NW-7)



- CODE93



- ITF



- CODE128



■ GS1 DataBar (RSS)

- GS1 DataBar Omni-directional



- GS1 DataBar Truncated



- GS1 DataBar Stacked



- GS1 DataBar Limited



- GS1 DataBar Expanded



- GS1 DataBar Composite



Reading range performance

Explained with examples of following conditions:

- Contrast: MRD 63% (PCS = 0.9)
- Installation condition: Pitch angle $\alpha = 0^\circ$, skew angle $\beta = 15^\circ$
Tilt angle $\gamma = 0^\circ$, curvature $R = \infty$
- Reading rate: 90% or more in 10 tries



The reading range is a reference value, not a guaranteed value.

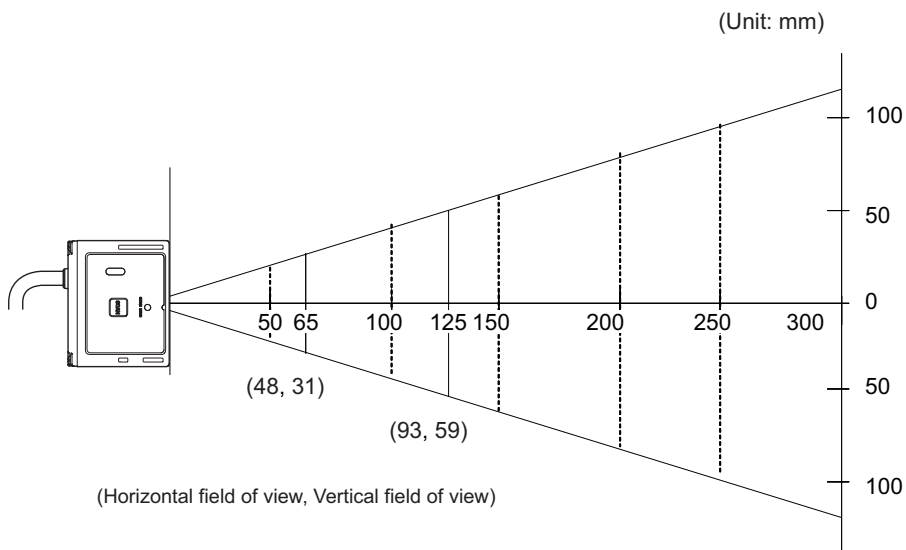

▪ **V400-R2CF125**

2D code (typical example)

Code types	Resolution	Reading distance	Field-of-view size at reading distance
QR Code	0.212	90 to 115	67 × 42 to 85 × 54
	0.381	55 to 195	41 × 26 to 144 × 91
Data Matrix	0.254	75 to 145	55 × 33 to 107 × 68
PDF417	0.169	80 to 140	59 × 38 to 104 × 66
	0.254	60 to 195	44 × 28 to 144 × 91

Bar code (typical example)

Code types	Resolution	Reading distance	Field-of-view size at reading distance
Code39	0.127	85 to 125	63 × 47 to 92 × 59
	0.254	65 to 205	48 × 31 to 152 × 96
	0.508	60 to 295	44 × 28 to 218 × 138
Code128	0.2	75 to 185	55 × 35 to 137 × 87
UPC	0.33	50 to 220	37 × 23 to 163 × 103

▪ **V400-R2CF65**

2D code (typical example)

Code types	Resolution	Reading distance	Field-of-view size at reading distance
QR Code	0.169	60 to 80	44 × 28 to 59 × 38
	0.381	35 to 115	26 × 16 to 85 × 54
Data Matrix	0.212	55 to 90	41 × 26 to 67 × 42
PDF417	0.127	55 to 80	41 × 26 to 59 × 38
	0.254	55 to 115	41 × 26 to 85 × 54

2D code (typical example)

Code types	Resolution	Reading distance	Field-of-view size at reading distance
Code39	0.076	60 to 65	44 × 28 to 48 × 31
	0.127	55 to 85	41 × 26 to 63 × 40
	0.254	50 to 115	37 × 23 to 85 × 54
Code128	0.18	45 to 100	33 × 21 to 74 × 47
UPC	0.33	45 to 120	33 × 21 to 89 × 56

Reading angle performance

■ Pitch angle (α)

In the following conditions, readable up to $\alpha = 50^\circ$ on either side.

- Code: Resolution = 0.330 mm, UPC (12 digits), PCS = 0.9
- Reading distance: 65 mm (V400-R2CF65) or 125 mm (V400-R2CF125) from the case end
- Installation condition: Skew angle $\beta = 15^\circ$, tilt angle $\gamma = 0^\circ$, curvature $R = \infty$

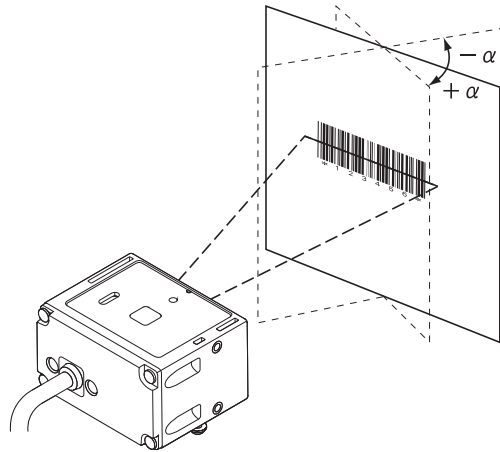

■ Skew angle (β)

In the following conditions, readable up to $\beta = +/-50^\circ$.

- Code: Resolution = 0.330 mm, UPC (12 digits), PCS = 0.9
- Reading distance: 65 mm (V400-R2CF65) or 125 mm (V400-R2CF125) from the case end
- Installation condition: Pitch angle $\alpha = 0^\circ$, tilt angle $\gamma = 0^\circ$, curvature $R = \infty$

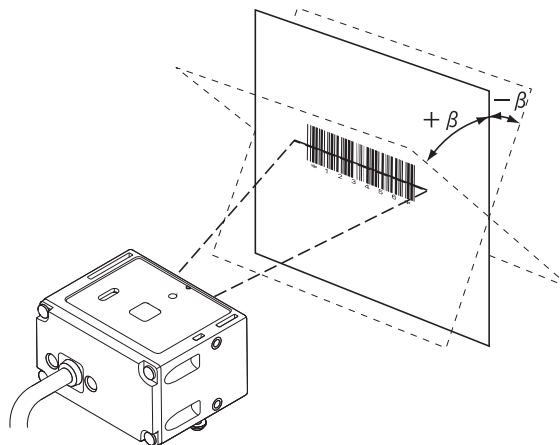

Reading performance for bar codes on a highly gloss surface such as glossy paper or a card case may be impaired because reflected illumination LED light or room illumination light enters the reading window.

If reflected illumination LED light is the culprit, reading performance can be improved by providing an angle of about 15° in the skew direction.

■ Tilt angle

Readable at all angles.

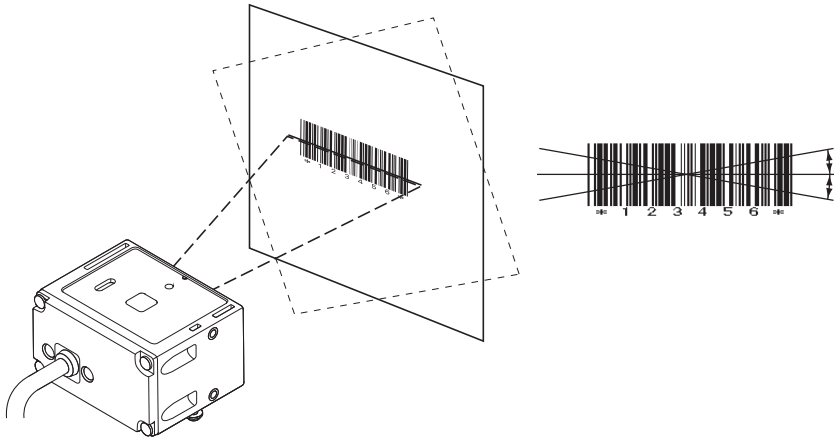

■ Curvature

In the following conditions, 12-digit UPC codes can be read within a range of $R \geq 20$.

- Code: 12-digit UPC, resolution = 0.33 mm, PCS = 0.9
- Reading distance: 65 mm (V400-R2CF65) or 105 mm (V400-R2CF65) from the case end
- Installation condition: Pitch angle $\alpha = 0^\circ$, skew angle $\beta = 15^\circ$, tilt angle $\gamma = 0^\circ$

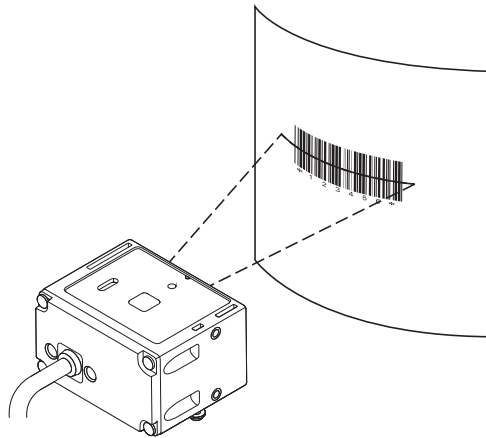

Wiring and Connection

This section explains the pin arrangement, the input/output circuit, and the method of connection to upper equipment.

Pin arrangement and input/output circuit

Pin arrangement

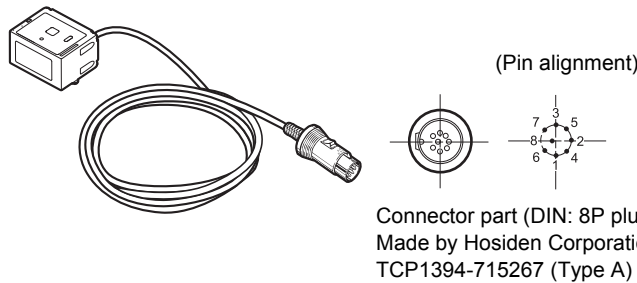

Connection with upper equipment p.33, p.34

Wire color	Pin No.	Signal name	Function	Signal direction	
				Reader	Upper equipment
Green	1	SD	Transmission data	→	→
White	2	RD	Received data	←	←
Gray	3	RS	Transmission request	→	→
Blue	4	CS	Transmission allowed	←	←
Brown	5	TRIG	External trigger signal	←	←
-	6	NC	Not connected		
Black	7	S.GND	0 V	←	→
Red	8	VCC	Power supply	←	External
Yellow	-(Note)	OK	READ OK output	→	External
Orange	-(Note)	NG	READ NG output	→	External

When you make a connection cable, use the following connectors.

Recommended parts for the connector

Usage	Manufacturer	Model
For cable relay	Hosiden Corporation	TCS8587-0170477
For panel installation	Hosiden Corporation	TCS1080-0120177



The OK and NG output lines are not connected to the DIN 8-pin connector. To use the OK and NG outputs, cut the cables.

Input/output circuit

▪ **External trigger signal input circuit**

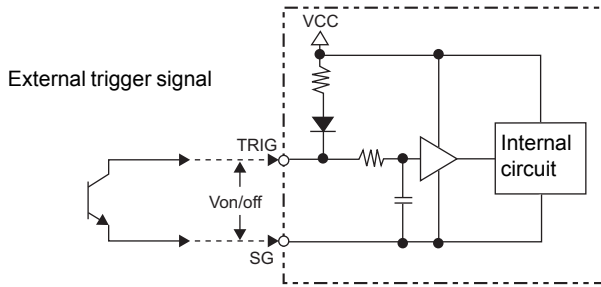

Item	Minimum value	Maximum value
Terminal voltage Von when a transistor is turned on	0 V	0.8 V
Terminal voltage Voff when a transistor is turned off	2 V	5.5 V

▪ **READ OK/NG signal output circuit**

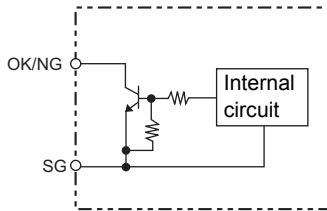

Item	Specification
Output system	NPN open collector
Rated load	24 VDC 30 mA
Leak current at OFF	0.5 mA or less
Residual voltage at ON	1 V or less

Example of connection with a PC

Example of connection with PC/AT compatible is explained.

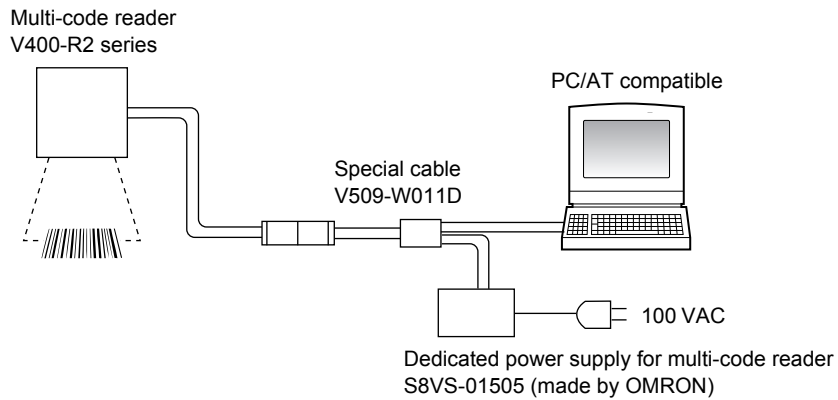

■ Wiring

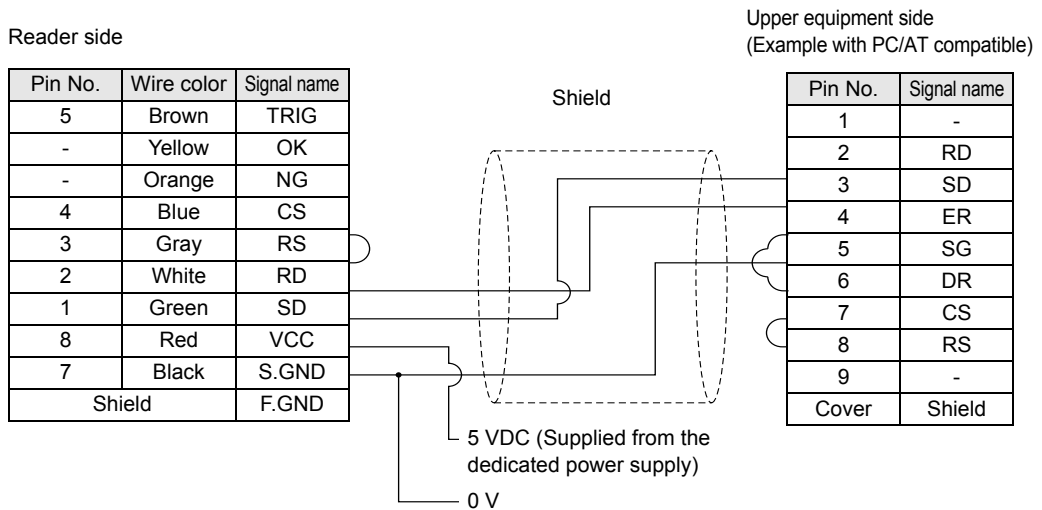

Communication with upper equipment

Check that the product has started up, and then start communication with upper equipment.

Indefinite signals may be generated from the upper interface while the product starts up. Clear the receive buffer of the devices before starting initial operation.

Example of connection with programmable controller (CS1)

Connection with programmable controller CS1 (made by OMRON) is explained.

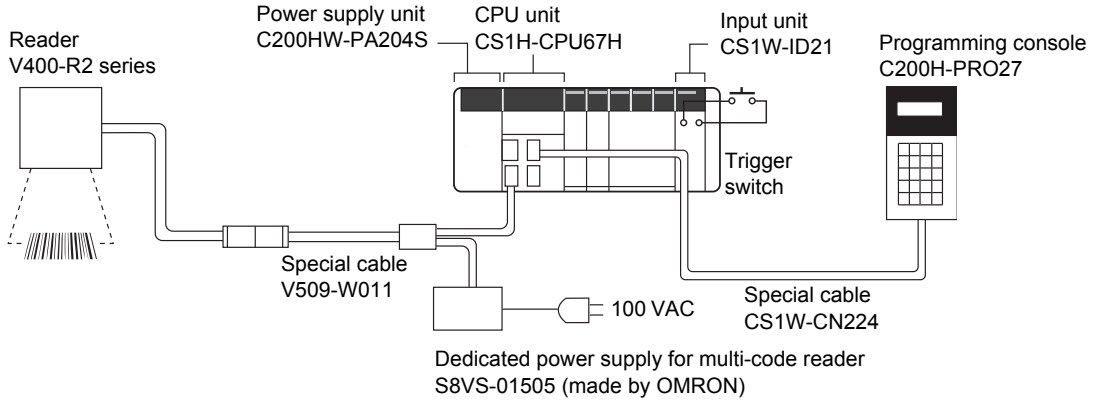

Connect the connection cable of this reader to RS-232C port of the CPU unit.

■ Wiring

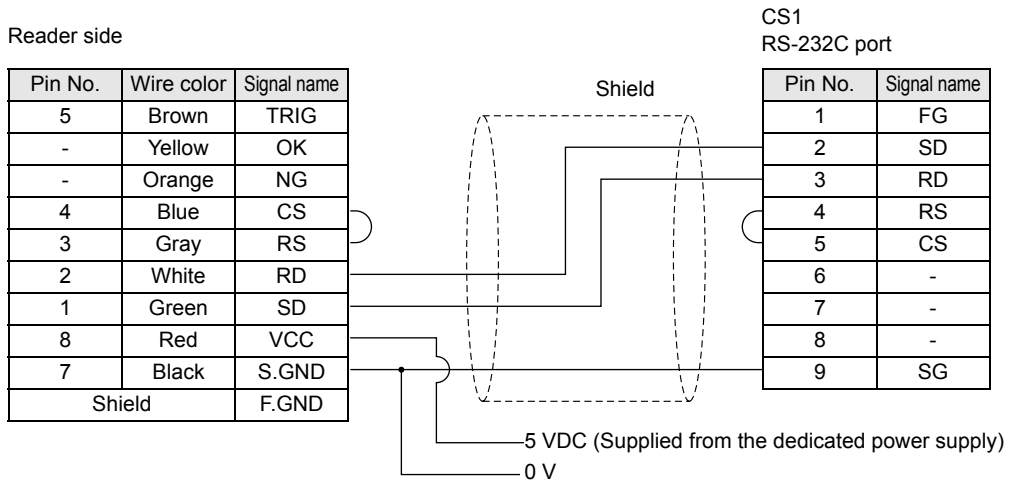

■ Settings on the reader

Specify the settings as follows to establish communication with the programmable controller.

Setting item	Setting content	Command
Communication speed	9600 bps	(Factory default setting)
Data length	8 bits	(Factory default setting)
Parity	None	(Factory default setting)
Stop bit	1 bit	(Factory default setting)
Header	None	(Factory default setting)
Footer	CR	(Factory default setting)
Reading valid time	Trigger + 2 sec.	(Factory default setting)
Process failed reading	Transmits "NL" when no label is found Transmits "ND" when reading has failed	TH0N0L T10N0D

■ Settings on OMRON programmable controller CS1

For information about the detailed setting method, refer to the operation manual of your programmable controller.

Setting item	Setting content
Dip switch of CPU unit	OFF
Program controller system settings	160[830E]
	161[0006]
	162[0000]
	164[000D]
	165[0100]
DM setting	Set [1B5A] to DM00100 (Memorize "[ESC]Z" of the ASCII code)

■ Program controller system settings - Details

160	b15	Presence of the arbitrary communication setting	"1"	Arbitrary setting
	b11-8	Serial communication mode	"11"	Nonprocedural
	b3	Data length	"4"	8 bits
	b2	Stop bit	"1"	1 bit
	b1-0	Parity	"01"	None
161	b7-0	Communication speed	0×06	9600 bps
162	b15-0	Transmission delay time	0×0000	No delay
164	b15-8	Start code	0×00	None
	b7-0	End code	0×0D	CR
165	b12	Presence of the start code	"0"	None
	b9-8	Presence of the end code	"01"	The end code is present

* 0×00 means a hexadecimal number, and "0" means a binary number.

■ **Example of program**

When the trigger switch is turned on, the reader executes the reading operation and stores the read data to DM (data memory) of CS1.

The content is displayed on the programming console.

When the code cannot be read within the duration which is set beforehand (2 sec. in this example), “NL” or “ND” is transmitted.

To check the read data with the programming console, press “Clear > FUN > Monitor” in this order.

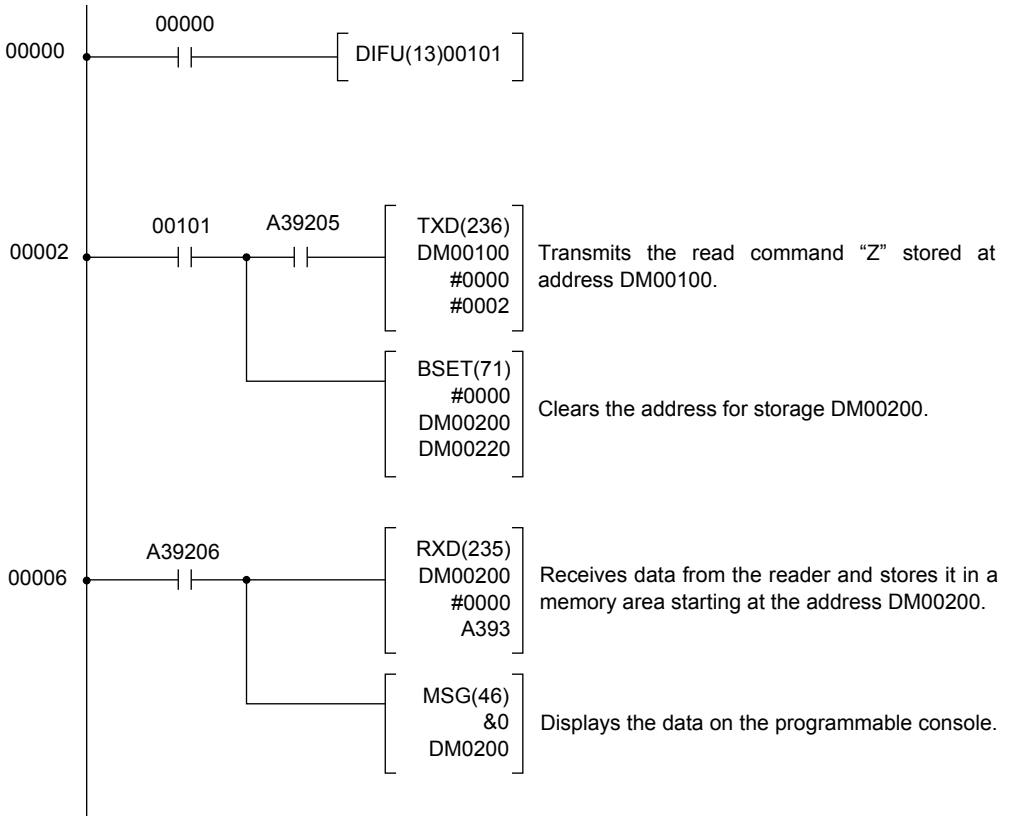

Communication with upper equipment

Check that the product has started up, and then start communication with upper equipment.

Indefinite signals may be generated from the upper interface while the product starts up. Clear the receive buffer of the devices before starting initial operation.

Preparation

This section describes the setting method based on preliminary examination. Perform a test to check whether the intended code is read and set the reading conditions for the purpose.

Testing

You can check how stably the intended code can be read.
Read the code at rest ten times and calculate the reading rate.

■ Entering the reading rate measurement mode

1. Place the code in the reading position.

2. Input the command “[XU8”.

The reader enters the reading rate measurement mode.
The reading rate in every 10 reading operations is measured.

3. To exit the reading rate measurement mode, restart the reader.

The reader returns to the normal measurement mode.

Do not execute write command “Z2” to nonvolatile memory.
A sample setting condition is overwritten and stored, which erases the already set reading condition.



■ Output format

In reading rate measurement mode, the reading rate in every 10 reading operations is output continuously to the upper equipment.

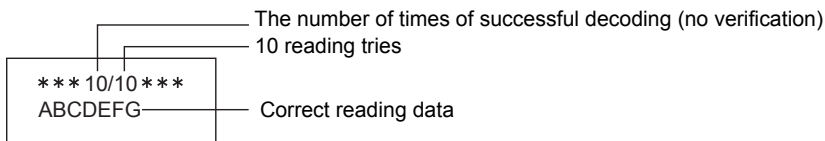

Communication data format

Header	SPACE (20H)	* (2AH)	* (2AH)	* (2AH)	1 (31H)	0 (31H)	/ (2FH)	1 (31H)	0 (31H)	SPACE (20H)	* (2AH)	* (2AH)	* (2AH)	SPACE (20H)	Footer
--------	----------------	------------	------------	------------	------------	------------	------------	------------	------------	----------------	------------	------------	------------	----------------	--------

Header	Correct reading data	Footer
--------	----------------------	--------

Footer

Investigation into the reading timing

This reader uses the “trigger reading” system. Trigger reading uses the following trigger input systems and reading operations.

 Setting method p.71

Reading system		Trigger reading
		Reading is executed by applying a reading trigger from outside.
Trigger input method	External trigger signal	Reading starts when the external trigger signal is turned on. The “Trigger controlled system” performs reading while the trigger is ON, and the “Effective duration designation system” performs reading only for the predetermined effective duration (*) that starts when the trigger is ON.
	RS-232C command	Reading starts when the communication command is sent from the upper equipment. After receiving the command, the reader performs reading only for the effective duration (*) you have set beforehand.
Reading operation	Single reading	When the reading succeeds, the reader outputs the data and finishes the reading operation.
	Plural reading	The reader reads codes continuously while the trigger is ON or for the effective duration (*). When the first reading is completed, the data is output once. While the reader is reading the same code continuously, it outputs no data. The reader outputs data only when the new data differs from that of the previous code.
	Continuous reading	The reader reads codes continuously while the trigger is ON or for the effective duration (*). The reader outputs data even if it reads the same code.

* Effective duration of reading

When the trigger input method is external trigger signal effective duration designation system or RS-232C command, effective duration setting is required beforehand. The effective duration is set between 0 and 10 seconds.

 Effective duration setting method p.72

Setting the reading conditions

There are the following two setting methods for the reader. Select either method according to the condition.

Setting method	Description
Read the menu sheet.	This method reads the menu sheet of the function you want to set. This is convenient for the initial setting and when testing.
Input a command from the upper equipment.	This method inputs a command from the upper equipment. This is convenient when changing setup according to the type of code.

■ Read the menu sheet.

The menu sheet is a special code used to set the reader function. Setting can be changed by reading this menu sheet.

1. Read the menu sheet “ZZ” that starts/ends the setting procedure.

The buzzer sounds continuously, indicating that the reader has entered the setting mode.



2. Read the menu sheet “U2” that restores the factory default settings.



3. Read the menu sheet for the setting item you want to change.

 Menu Sheet/Command List p.58

4. To finish, read the menu sheet “ZZ” that starts/ends the setting procedure.

The buzzer stops and the reader returns to the normal mode.



■ How to create a menu sheet

Menu sheets use the CODE39 code system. However, the code used for this reader is special as a space mark is used as the start and stop codes. (Normally “*”)

You can create a menu sheet using readily available code creation software, as shown below.

E.g.: When creating a menu sheet “A3”

Create “* A3 *” and cut the parts of “*” with scissors to create the menu sheet “A3”.



■ Inputting a command from the upper equipment

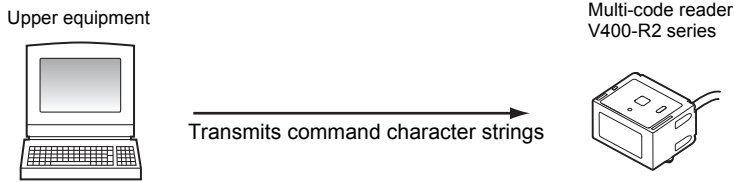

1. Transmit the command character strings of the function you want to set.

ESC (1BH)	Command	CR (0DH)
--------------	---------	-------------

Menu Sheet/Command List p.58

2. Transmit the command “Z2” to write the setting data in the nonvolatile memory of the reader.



Be sure to write the setting data in the nonvolatile memory whenever a condition is set by inputting a command from the upper equipment. When you turn the power OFF without writing the setting in the memory, the settings will be lost.

CHECK!

Transmission method of the command by designating values and characters is explained as follows.

E.g.: Setting “AB” on header (Designating codes directly)

ESC (1BH)	R (52H)	Y (59H)	0 (30H)	A (41H)	0 (30H)	B (42H)	CR (0DH)
Header setting command			Character “A”		Character “B”		

Installation and Reading

This section explains how to install the reader and conduct a final check to confirm that the reader works successfully in the actual environment.

Installation

■ Installing the reader

Install the reader at a distance where it captures the code correctly.

■ Field of view and distance in relation to the code

 For information about the installation distance and code resolution, refer to “Reading range performance” on p.27.

■ Installing the mounting bracket

To avoid regular reflection of illumination light, install the bracket at an angle of about 15 to 30 against the bar code.

The mounting bracket supplied with the reader can be tilted between -30° and $+30^{\circ}$.
Use this mounting bracket.

1. Attach the mounting bracket to the reader (M2 × 6 screws, Tightening torque: 0.15 N·m).

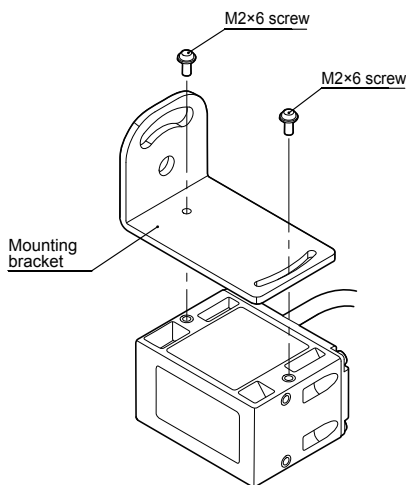

- 2.** Install the mounting bracket to the installation location (M5 × 10 screw, Tightening torque: 2.3 N·m)

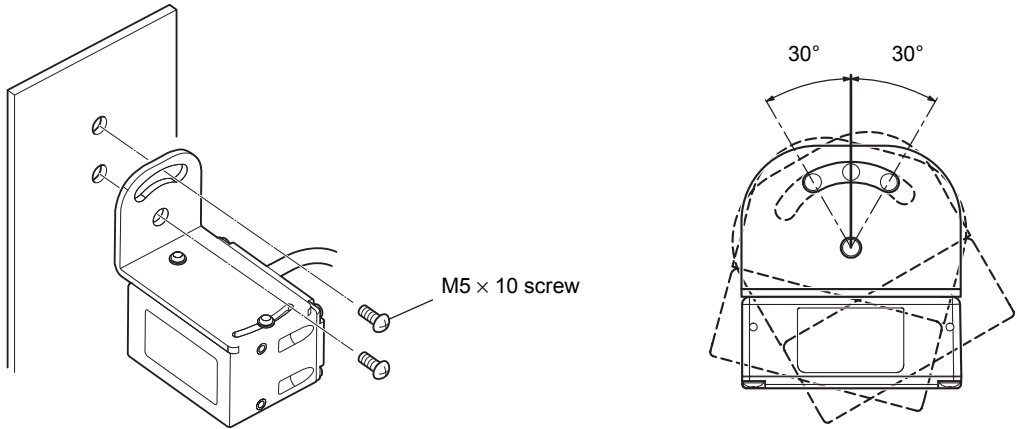



- Do not apply stress to the cable when installing or using.
- The reading distance and angle ranges may differ depending on labels. Before installing the reader, check that the label is read successfully.

MEMO

Section 3

Basic Knowledge of Operation

This section explains main functions of the reader.

 Operation Flow Chart	46
 Communication Data Format	52

Operation Flow Chart

Basic operation flow charts by reading operation, data transmission charts by communication protocol, and timing charts of buzzer and LED indication are shown below.

Basic operation flow chart

■ In case of single reading

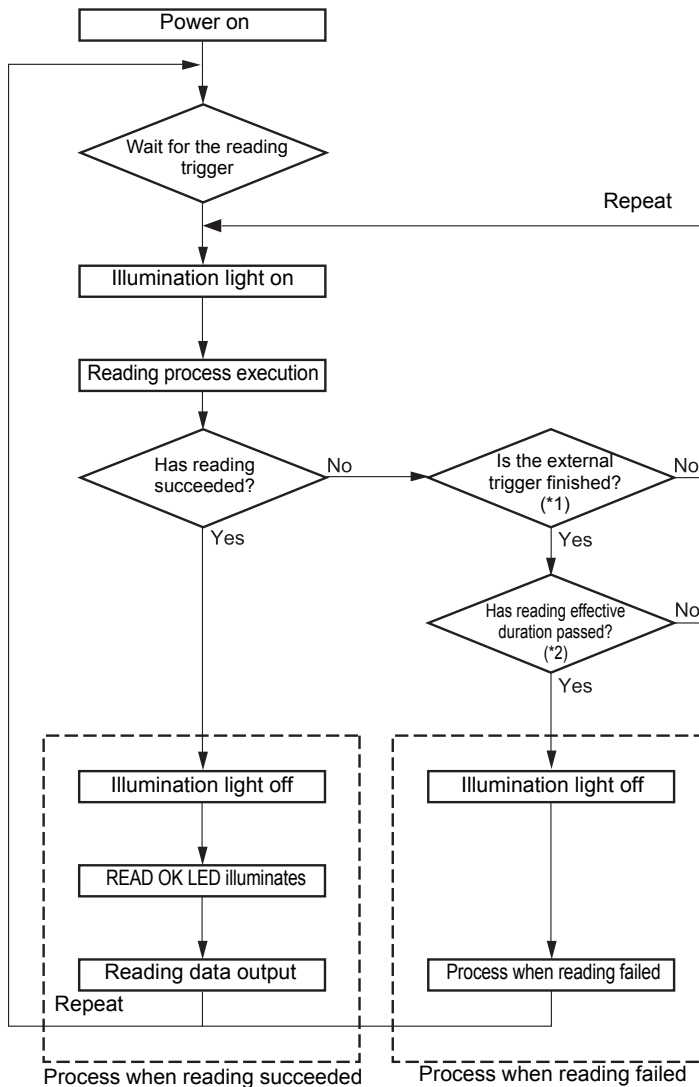

*1: When the trigger by a command is used, ignore this clause.

*2: When the trigger controlled system is used (codes are read while the trigger is ON), the reading effective duration is set to 0.

■ In case of plural reading

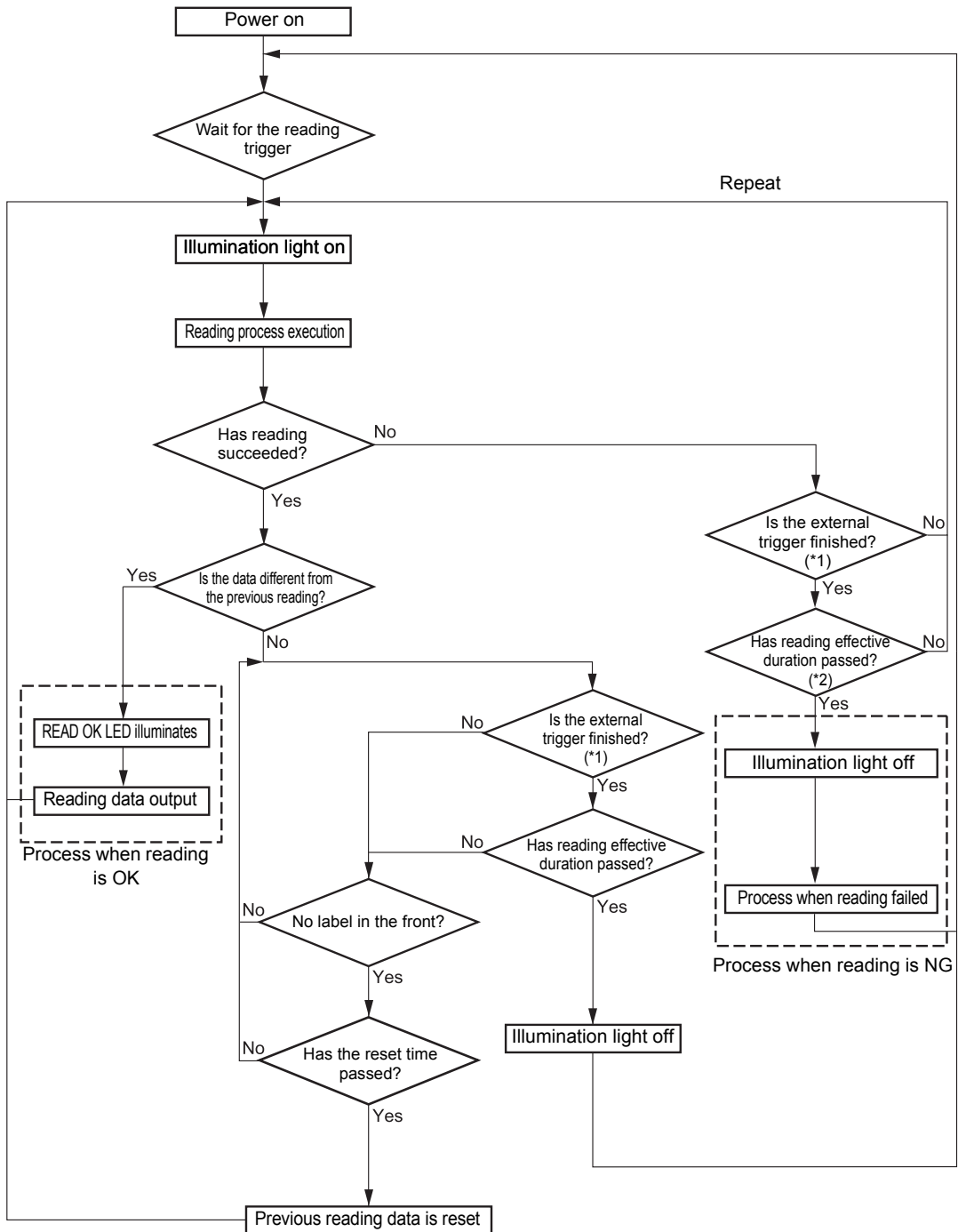

*1: When the trigger by a command is used, ignore this clause.

*2: When the trigger controlled system is used (codes are read while the trigger is ON), the reading effective duration is set to 0.

■ In case of continuous reading

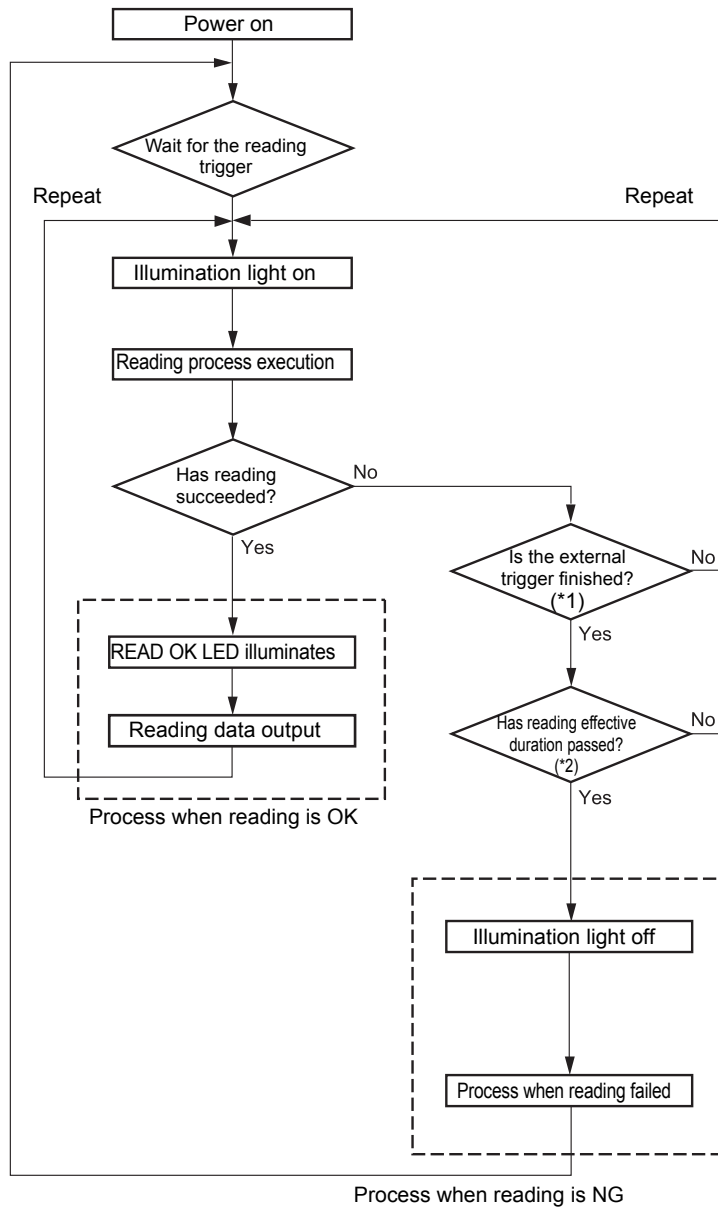

*1: When the trigger by a command is used, ignore this clause.

*2: When the trigger controlled system is used (codes are read while the trigger is ON), the reading effective duration is set to 0.

Communication protocol

The following two systems exist for transmitting the data read by the reader to the equipment.

■ Nonprocedural system (no protocol system)

The reader transmits the data to the upper equipment and ends the communication.

Multi-code reader
V400-R2 series

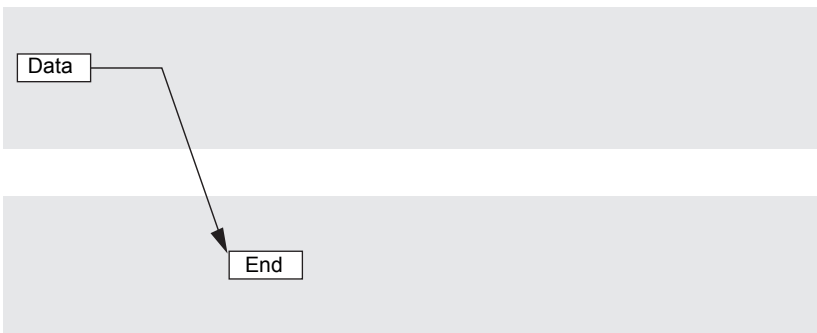
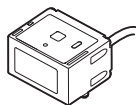

■ ACK/NAK system

The reader waits for a response from the upper equipment after transmitting the data. When ACK (06H) 1 byte is received from the upper equipment, a buzzer sounds indicating normal finishing and ends data transmission.

Multi-code reader
V400-R2 series

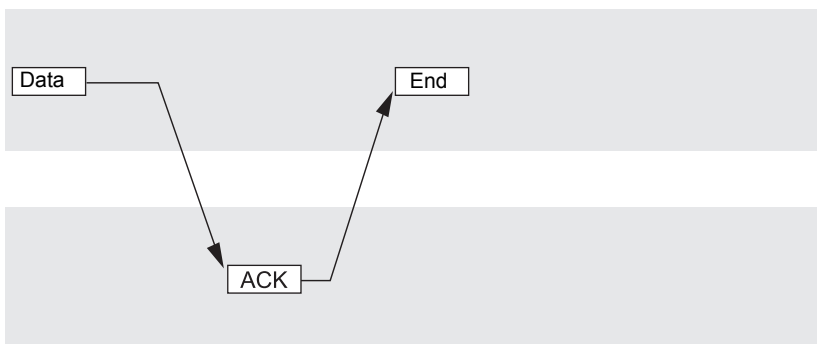
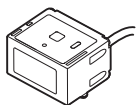

When NAK (15H) 1 byte is received from the upper equipment, the data is transmitted again. When the time-up time set beforehand comes, the time-up buzzer sounds and the data transmission ends.

Multi-code reader
V400-R2 series

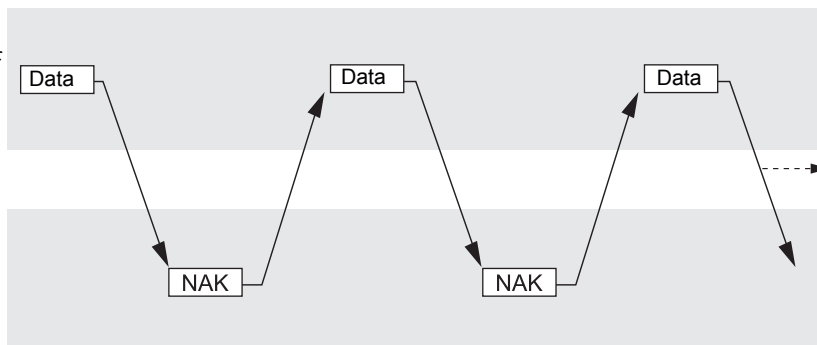
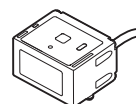

Communication timing chart

This section explains the timing of the buzzer and LED indication.

■ In case of reading OK (single reading)

In cases when READ OK signal output is set for One-shot system.

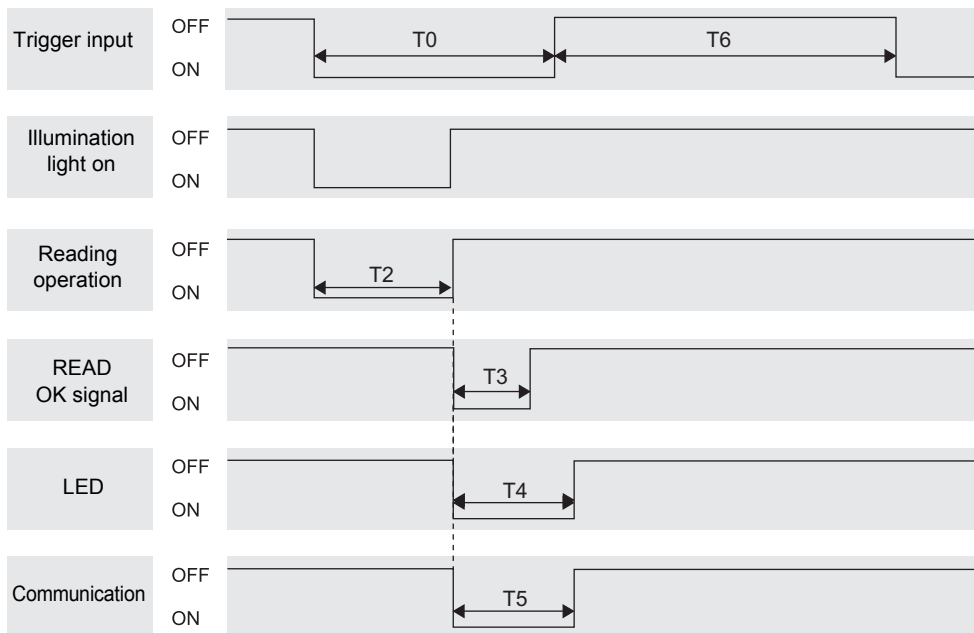

Time	Description
T0	Trigger ON time. Keep the external trigger ON for at least 50 ms. The reading time depends on the "trigger effective duration" setting.
T2	Reading valid time. (The factory default setting is 2 sec. It can be changed.) In case of reading OK, the illumination LED turns off and the reading operation finishes as soon as the operation succeeds.
T3	One-shot duration. It depends on the setting for "One-shot duration". (In case when READ OK signal output is set for One-shot system.)
T4	Buzzer and indication LED illumination time. (The factory default settings are 50 ms for the buzzer and 200 ms for the indication LED. They can be changed.)
T5	Communication time. This differs depending on communication conditions.
T6	Trigger signal minimum OFF time. Be sure to set 5 ms or more.



- In case of continuous reading and plural reading, illumination light is emitted throughout the reading effective duration that starts when a trigger is input. The concept of T0 to T4 is the same as that in the case of single reading.
- Concept of communication time

$$\text{Communication time (ms)} = \frac{(\text{Data length}) + (\text{In case when parity exists}) + (\text{Number of stop bits})}{(\text{Communication speed})} \times (\text{Number of digits of communication data} + \text{Number of header characters} + \text{Number of footer characters}) \times 10^3$$

■ In case of reading NG (single reading)

In case when READ OK signal output is set for trigger signal synchronous system. The READ NG signal is output when any code other than the labels registered in "Setting for label registration" (p.81) is read.

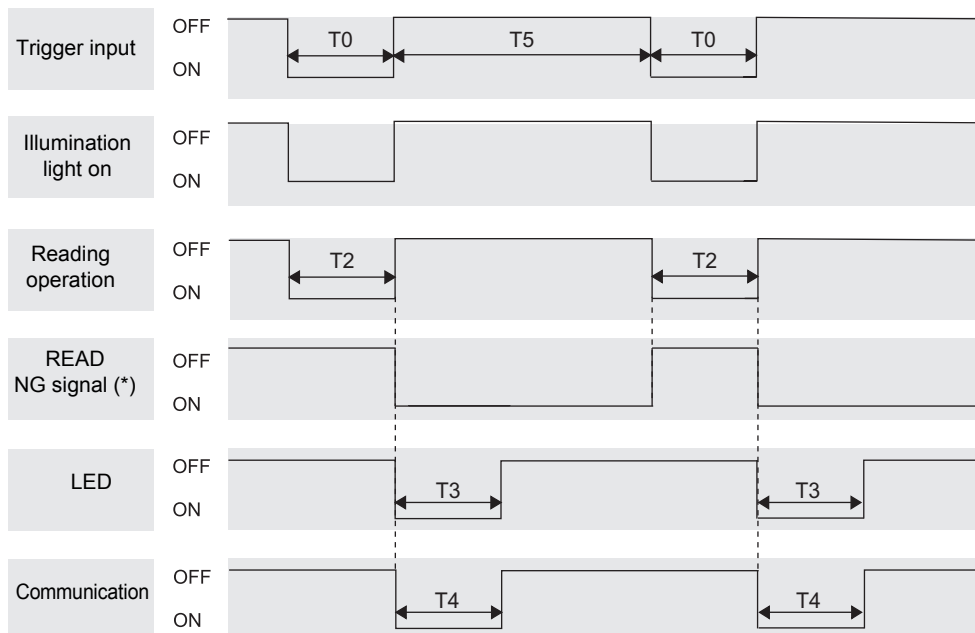

*The READ NG signal is output when any code other than the labels registered in "Setting for label registration" (p.81) is read.

Register labels to output READ NG signal.

Setting for label registration p.81

Time	Description
T0	Trigger ON time. Keep the external trigger ON for at least 50 ms. Here, it is assumed that the reading time is "trigger controlled".
T2	Reading valid time. (The factory default setting is 2 sec. It can be changed.) In case of "trigger controlled" and reading NG, the illumination LED turns off and the reading operation finishes as soon as the external trigger turns off.
T3	When the error message output is set to ON, this is the indication LED illumination time.
T4	This is the error message transmission time when the error message output is set to ON. This differs depending on communication conditions.
T5	Trigger signal minimum OFF time. Be sure to set 5ms or more.



- In case of continuous reading and plural reading, illumination light is emitted throughout the reading effective duration that starts when a trigger is input. The concept of T0 to T4 is the same as that in the case of single reading.
- Concept of communication time

$$\text{Communication time (ms)} = \frac{(\text{Data length}) + (\text{In case when parity exists}) + (\text{Number of stop bits})}{(\text{Communication speed})} \times (\text{Number of digits of communication data} + \text{Number of header characters} + \text{Number of footer characters}) \times 10^3$$

Communication Data Format

This section explains the format of communication between the reader and upper equipment.

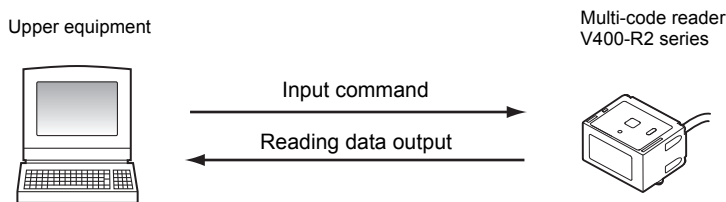

Inputting a reading trigger using an RS-232C command

The reading trigger command format is as shown below.

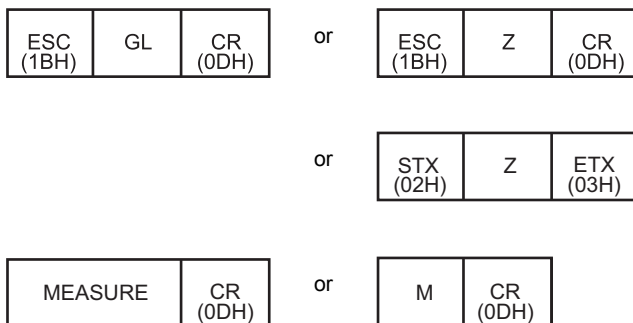

The continuous reading trigger command format is as shown below.

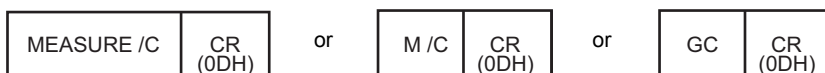

The continuous reading stop command format is as shown below.



Note: If a non-existent command is received, ER+CR(0DH) is returned.

Inputting a setting command

The reading condition setting command can be transmitted from the upper equipment. The format is as follows.

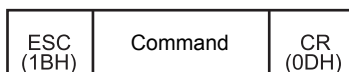

For details about the commands, refer to Section 4.

p.58

Data output format to indicate a successful read

When code reading succeeds, the following data is transmitted to the upper equipment.

Header	Number of digits	Data of the read code	Footer
--------	------------------	-----------------------	--------

Output item	Description	Factory default setting
Header	A character string to be added to the head of transmission characters. Up to four characters can be set.	None
Number of digits	The number of digits of the read data is output in ASCII code. Whether or not to output the number of digits can be selected from the following choices. <ul style="list-style-type: none"> • "Bar code: 2 digits, 2D code: 6 digits" • "Bar code and 2D code: 6 digits" • None 	None
Footer	A character string to be added to the end of the transmission data. Up to four characters can be set.	CR (0DH)

Setting method p.85, p.86

Note: If a read trigger is input by a MEASURE command, MEASURE/C command, MEASURE/E command, or an abbreviated form of one of these commands, OK+CR(0DH) is returned before the data output format.

Process for failed reading

The error message transmitted when reading fails depends on the setting.

Output item	Description	Factory default setting
Error message - No label	This message is returned when no code exists in the field of view.	Not transmitted
Error message - Decoding failure	This message is returned when the code cannot be read.	Not transmitted

Setting method p.75

Data transfer contents of each reading code type

Reading code	Description
UPC-A	You can select whether or not to transfer the head character "0" for transfer digit number adjustment and check digit C/D. ("0" is an additional character to be combined with C/D to adjust the number of digits to be identical to JAN/EAN-13.) 0 S X1 X2 X3 X4 X5 X6 X7 X8 X9 X10 C/D S: Number system character (Automatically decided according to the combination of each character of X1 to X10.)
UPC-E	You can select whether or not to transfer the head character "0" for transfer digit number adjustment and check digit C/D. ("0" is an additional character to be combined with C/D to adjust the number of digits to be identical to JAN/EAN-13.) 0 S X1 X2 X3 X4 X5 X6 C/D S: Number system character (Automatically decided according to the combination of each character of X1 to X10.)
JAN/EAN	Reading data (8-digit or 13-digit) is transferred as it is.
ITF, Industrial2of5(STF)	Transfers in the order from the next character of the start code to the character before the stop code. (The start code and stop code are not transferred.)
Codabar(NW-7), CODE39	You can select whether or not to transfer the start code and stop code. When the transfer of the start code and stop code is permitted, you can select whether the transferred start/stop code of Codabar(NW-7) is in lower-case "a/b/c/d" or in upper-case "A/B/C/D". The transfer start/stop code of CODE39 is "*".
GS1-128	When the GS1-128 conversion is enabled, the control character "JC1" (ASCII code: 5D, 43, 31) which indicates GS1-128 is added to the head of the transfer data. Also, the FNC1 character, which is used as a separating character, is replaced with the GS (ASCII code: 1DH) character before it is transferred.
2D code	Only the reading data is transferred.

 Setting method p.65



Communication with upper equipment

Check that the product has started up, and then start communication with upper equipment.

Indefinite signals may be generated from the upper interface while the product starts up. Clear the receive buffer of the devices before starting initial operation.

Section 4

Setting Method

This section explains setting methods using a menu sheet and by entering a command from the upper equipment.

☒	How to Use a Menu Sheet/Command	56
☒	Menu Sheet/Command List	58

How to Use a Menu Sheet/Command

The following two setting methods are available for the reader. Select either method depending on the condition.

Setting method	Description
Reading a menu sheet	This method reads the menu sheet of the function you want to set. This is convenient for the initial setting and when testing.
Inputting a command from the upper equipment	This method inputs a command from the upper equipment. This is convenient when changing setup according to the type of code.

Reading a menu sheet

The menu sheet is a special code used to set the reader function.
Setting can be changed by reading this menu sheet.

1. Read the menu sheet "ZZ" that starts/ends the setting procedure.

The buzzer sounds continuously, indicating that the reader has entered the setting mode.



2. Read the menu sheet "U2" that restores the factory default settings.



3. Read the menu sheet for the setting item you want to change.

 Menu Sheet/Command List p.58

4. To finish, read the menu sheet "ZZ" that starts/ends the setting procedure.

The buzzer stops and the reader returns to the normal mode.



■ How to create a menu sheet

Menu sheets use the CODE39 code system. However, the code used for this reader is special as a space mark is used as the start and stop codes. (Normally “*”) You can create a menu sheet using readily available code creation software, as shown below.

E.g.: When creating a menu sheet “A3”

Create “* A3 *” and cut the parts of “*” with scissors to create the menu sheet “A3”.



■ Inputting a command from the upper equipment

 Refer to “Inputting a command from the upper equipment” (p.41).

Menu Sheet/Command List

Groups are classified as follows. Please refer to the corresponding pages.

Setting item	Reference
Start/end setting using menu sheets	p.59
Write setting contents on the nonvolatile memory	p.59
Setting for external trigger signal	p.59
Return to the factory default setting	p.60
Setting of reading permission and prohibition	p.62
Detail setting for reading code	p.65
Setting of inverted code	p.70
Setting for the number of times of reading coincidence	p.71
Setting for reading operation	p.72
Setting for reading effective duration	p.72
Setting for plural reading reset time	p.74
Setting for failed reading	p.75
Setting for the number of reading digits	p.76
Setting for the READ OK LED	p.77
Setting for the buzzer	p.77
Setting for READ OK signal output	p.79
Setting for label registration	p.81
Setting for communication conditions	p.82
Setting for the communication protocol	p.84
Setting for the header and footer	p.85
Number of digit output	p.86
Direct code designation	p.87

Start/end setting using menu sheets

When setting the reader using menu sheets, read this menu sheet at the start and end of the procedure.

Menu sheet	Command
Start/end setting using menu sheets 	None



Write setting contents on the nonvolatile memory

Be sure to write the settings in the nonvolatile memory whenever a condition is set by inputting a command from the upper equipment. When you turn the power OFF without writing the setting in the memory, the settings will be lost.

Menu sheet	Command
Write the contents set with a command in the nonvolatile memory. (No menu sheet)	Z2

Setting for external trigger signal

Select positive logic or negative logic of the external trigger signal.

Menu sheet	Command
External trigger signal, positive logic (H active) 	YA
External trigger signal, negative logic (L active) (factory default setting) 	YB

Return to the factory default setting

Menu sheet	Command
Return to the factory default setting  U 2	U2

Factory default setting

Item		Setting content
Readable code types		JAN/UPC (A and E)/EAN(13 and 8), CODE39, Codabar(NW-7), Industrial2of5, ITF, CODE128, CODE93, DataMatrix (ECC200), QR code, Micro QR code, PDF417, and GS1 DataBar (RSS)
Detail conditions	UPC/EAN detail settings	UPC-A: Transfer C/D without an 0 in the beginning
		UPC-E: Transfer C/D without an 0 in the beginning
		EAN-13: Transfer C/D
		EAN-8: Transfer C/D
	CODE39 detail settings	Not calculate C/D
		Transfer C/D
		Not transfer ST/SP
	Codebar (NW-7) detail settings	Not calculate C/D
		Transfer C/D
		Not transfer ST/SP
Data character of at least 5 digits		
Industrial2of5(STF) detail settings	Not calculate C/D	
	Transfer C/D	
Code93 detail settings	Transfer C/D	
GS1-Databar(RSS) detail settings	Transfer C/D	
GS1-128(EAN128) detail settings	Disable FNC1 to GS conversion	
Reading conditions	Reading method (normal reading / trigger reading)	Trigger reading
	Inverted code	Black code only
	Number of reading verification times	Once
	Reading operation	Single reading
	Failed reading	Transmit nothing
	Number of reading digits	Not specified
	Reading valid time	2 seconds
	Plural reading reset time	6 frames
LED	READ OK LED illumination time: 200 ms	
Buzzer	Enable the buzzer	
	Single-tone buzzer	
	Buzzer sound duration: 50 ms	
	Buzzer sound volume: Max	

Item		Setting content
External trigger signal		Negative logic (L active)
READ OK/NG signal output	Signal output	Output signals
	Signal output system	External trigger synchronous system (positive logic, H active)
Label registration		None
Communication conditions	Communication speed	9600 bps
	Data length	8 bits
	Parity	None
	Stop bit	1 bit
	Header	None
	Footer	CR
	Number of digit output	None
	RS/CS control	None (no protocol system)
	CS waiting time	Not limited
	ACK/NCK waiting time	Not limited







Setting of reading permission and prohibition

Select the types of code to be read.

For higher reading reliability, prohibit reading of codes that will not be read.

Menu sheet	Command
All codes except add-ons (Factory default setting) 	A0
Reading permission for all bar codes 	[BCM
Reading permission for all 2D codes 	[BCN
Reading prohibition for all codes 	B0
Reading permission for UPC codes 	R1
Permission for UPC add-on 2-digit codes 	R2
Permission for UPC add-on 5-digit codes 	R3
Reading permission for JAN/EAN codes 	R4
Permission for EAN add-on 2-digit codes 	R5
Permission for EAN add-on 5-digit codes 	R6





Menu sheet	Command
Reading permission for CODE39 codes 	B2
Reading permission for Cadabar(NW-7) codes 	B3
Reading permission for Industrial2of5(STF) codes 	R7
Reading permission for ITF codes 	R8
Reading permission for CODE128 codes 	B6
Reading permission for CODE93 codes 	B5
Reading permission for GS1 DataBar (RSS-14) codes 	JX
Reading permission for GS1 DataBar (RSS-Limited) codes 	JY
Reading permission for GS1 DataBar (RSS-Expanded) codes 	DR
Reading permission for GS1 DataBar Composite 	[BHE
Reading permission only for DataMatrix (ECC200) codes 	[BCC

Menu sheet	Command
Reading permission for QR codes 	[BCD]
Reading permission for Micro QR codes 	[D2U]
Reading permission for PDF417 codes 	[BCF]
Reading permission for MicroPDF417 	[BCG]
Reading permission for AztecCode 	[BCH]
Reading permission for MaxiCode 	[BCE]
Reading permission for Codablock-F 	[D4P]





Detail setting for reading code

Conditions for details about reading codes, such as whether to use the check digit (C/D) or to transmit the start code/stop code (ST/SP), are set.



UPC-A

Menu sheet	Command
Transfer C/D without an 0 in the beginning (Factory default setting) 	E3
Not transfer C/D without an 0 in the beginning 	E5
Transfer C/D with 0 in the beginning 	E2
Not transfer C/D with 0 in the beginning 	E4



UPC-E

Menu sheet	Command
Transfer C/D without an 0 in the beginning (Factory default setting) 	E7
Not transfer C/D without an 0 in the beginning 	E9
Transfer C/D with 0 in the beginning 	E6
Not transfer C/D with 0 in the beginning 	E8



EAN-13

Menu sheet	Command
Transfer C/D (Factory default setting) 	6K
Not transfer C/D 	6J

EAN-8









Menu sheet	Command
Transfer C/D (Factory default setting) 	6I
Not transfer C/D 	6H

CODE39

Menu sheet	Command
Not calculate C/D (Factory default setting) 	C1
Calculate C/D 	C0
Transfer C/D (Factory default setting) 	D9
Not transfer C/D 	D8
Transfer ST/SP 	D0







Menu sheet	Command
Not transfer ST/SP (Factory default setting)  D 1	D1

Codabar(NW-7)

Menu sheet	Command
Not calculate C/D (Factory default setting)  H 7	H7
Calculate C/D  H 6	H6
Transfer C/D (Factory default setting)  H 8	H8
Not transfer C/D  H 9	H9
Not transfer ST/SP (Factory default setting)  F 0	F0
ST/SP: ABCD/ABCD  F 3	F3
ST/SP: abcd/abcd  F 4	F4
ST/SP: ABCD/TN*E  F 1	F1
ST/SP: abcd/tn*e  F 2	F2



Menu sheet	Command
ST/SP: <DC1><DC2><DC3><DC4>/<DC1><DC2><DC3><DC4>  H J	HJ
Data character of at least 1 digit  H C	HC
Data character of at least 3 digits  H B	HB
Data character of at least 5 digits  H F	HF

Industrial2of5(STF)

Menu sheet	Command
Not calculate C/D (Factory default setting)  G 0	G0
Calculate C/D  G 1	G1
Transfer C/D (Factory default setting)  E 0	E0
Not transfer C/D  E 1	E1
Data character of at least 1 digit  G E	GE
Data character of at least 3 digits  G F	GF

Menu sheet	Command
Data character of at least 5 digits  G I	GI

GS1-128(EAN-128)

Menu sheet	Command
Disable GS1 conversion (Factory default setting)  X / 0	[X/0
Enable GS1 conversion  X / 4	[X/4

GS1-Databar(RSS) Menu sheet

Menu sheet	Command
Not transfer C/D  D M	DM
Transfer C/D  D L	DL

Setting of inverted code

Normally, codes are printed in black on a white background. However, some codes are white on a black background.

Black codes on a white background are called normal (regular) codes, and white codes in a black background are inverted codes.

Inverted codes can be read when the “Inverted code” option is selected.

Menu sheet	Command
<p>Normal (regular) code (Factory default setting)</p> 	V2
<p>Normal (regular) and inverted codes</p> 	V4
<p>Inverted codes</p> 	V3

Setting for the number of times of reading coincidence



When reading result coincides the number of times you have set, the reading result is output to the RS-232C interface.

The verification system is AND verification (Continuous coincidence system). (This cannot be changed.)

Menu sheet	Command
Reading once and verification zero times 	X0
Reading twice and verification once (Factory default setting) 	X1
Reading three times and verification twice 	X2
Reading four times and verification three times 	X3
Reading five times and verification four times 	BS
Reading six times and verification five times 	BT





Setting for reading operation







The reading operation is set.

Menu sheet	Command
Single reading (Factory default setting) 	S0
Plural reading 	S1
Continuous reading 	S2

Setting for reading effective duration

The time during which the reading continues after a trigger is input is set. When it is set to 0 sec., reading is controlled by the external trigger and the trigger is effective while the external trigger is ON.

Menu sheet	Command
0 seconds (controlled by the external trigger) 	Y0
1 second 	Y1
2 seconds (Factory default setting) 	Y2
3 seconds 	Y3

Menu sheet	Command
4 seconds 	Y4
5 seconds 	Y5
6 seconds 	Y6
7 seconds 	Y7
8 seconds 	Y8
9 seconds 	Y9
Infinity 	YM

Setting for plural reading reset time

This setting has effect when plural reading is enabled.

This setting specifies the number of frames (length of time) during which the reader should be kept away from the code before reading the same code again.









Frames

A frame is another representation of time (ms). Intervals between frames are not constant and they differ depending on codes. When the frame is set to infinity, the next code must differ from the previous one as long as a trigger is input.

(Example)

Frame	1	2	3	4	5	6
Time (ms)	50	100	200	300	400	500

Menu sheet	Command
1 frame 	AH
2 frames 	AI
3 frames 	AJ
4 frames 	AK
5 frames 	AL
6 frames (Factory default setting) 	AM
Infinity 	AG

Setting for failed reading

Process for failed reading is set.

With the factory default setting, nothing is transmitted in the event of failed reading.

■ Error message - No label

Direct input characters of up to 4 digits can be set. These characters are transmitted when no code (label) is detected during the reading time.



CHECK!

- The error message is disabled when no direct input characters are read after the command.
- This may be output simultaneously with "Error message - Decoding failure".

■ Error message - Decoding failure

Direct input characters of up to 4 digits can be read. These characters are transmitted when a code (label) is detected during the reading time but nothing is read.



CHECK!

- The error message is disabled when no direct input characters are read after the command.
- This may be output simultaneously with "Error message - No label".

E.g.: In the following two examples, the "NL<CR>" message is set for "No label" and the "ND<CR>" message for "Decoding failure". Those two examples may occur at the same time.

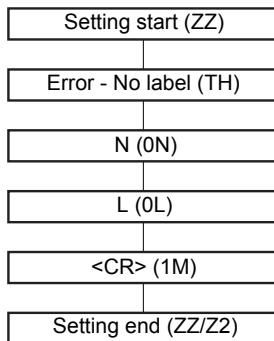

When no code is detected during the reading time

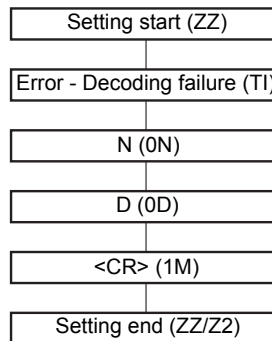

When a code is detected during the reading time but nothing is read



Menu sheet	Command
Error message - No label  T H	TH

Menu sheet	Command
Error message - Decoding failure 	TI
Not transmit an error message (Factory default setting) 	TG

Setting for the number of reading digits

When the number of reading digits is fixed, all codes having other lengths than that specified can be rejected. Up to two reading digits can be set.

This setting is effective for codes such as Interleaved 2 of 5 for which security against partial reading is insufficient.

While the number of reading digits to be fixed can be set by reading the code, the number of reading digits cannot be set with a command since a code of the necessary length must be read.





CHECK!

- To read codes of a known length, it is recommended that the number of digits be fixed.
- While the number of reading digits to be fixed can be set by reading the code, it is not affected by a detail setting (p.65) for reading codes, including “Transfer ST/SP”, “Not transfer ST/SP”, “Transfer C/D” and “Not transfer C/D”.
- Fixing the number of reading digits does not affect WPC (JAN/EAN/UPC) or other fixed-length codes and DataMatrix or other 2D codes.

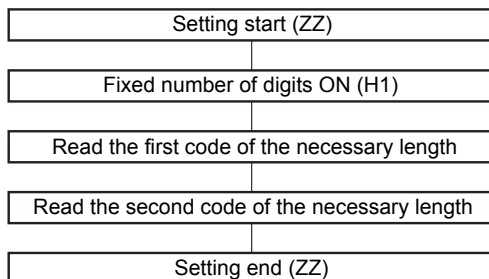



E.g.: The following describes the steps for fixing the number of reading digits.



Menu sheet	Command
Fixed number of digits OFF for all codes (Factory default setting) 	H0
Fixed number of digits ON for all codes 	None



Setting for the READ OK LED











The READ OK LED is disabled or its illumination time is set. The READ OK LED illuminates when reading succeeds.

Menu sheet	Command
Disable the READ OK LED 	T4
READ OK LED illumination time: 200 ms (Factory default setting) 	T5
READ OK LED illumination time: 400 ms 	T6
READ OK LED illumination time: 800 ms 	T7

Setting for the buzzer

The buzzer is enabled or disabled or its type and sound duration and volume are set. The buzzer sounds when reading succeeds.







Menu sheet	Command
Disable the buzzer 	W0
Enable the buzzer (Factory default setting) 	W8
Single-tone buzzer (Factory default setting) 	W1







Menu sheet	Command
High-low buzzer 	W2
High-high buzzer 	W3
Buzzer sound duration: 50 ms (Factory default setting) 	W7
Buzzer sound duration: 100 ms 	W4
Buzzer sound duration: 200 ms 	W5
Buzzer sound duration: 400 ms 	W6
Buzzer sound volume: Max (Factory default setting) 	T0
Buzzer sound volume: High 	T1
Buzzer sound volume: Medium 	T2
Buzzer sound volume: Low 	T3

Setting for READ OK signal output

When you want to output reading succeeded to the READ OK signal, set the conditions of output system and duration, then set them for “signal output (X*Q)”.

The READ NG signal is output when any code other than the labels registered in “Setting for label registration” (p.81) is read.

Menu sheet	Command
Output the signal (Factory default setting)  X * Q	[X*Q
Not output the signal  X * R	[X*R
External trigger signal synchronous system (positive logic, H active) (Factory default setting)  X * C	[X*C
External trigger signal synchronous system (negative logic, L active)  X * D	[X*D
One-shot system (positive logic, H active)  X * E	[X*E
One-shot system (negative logic, L active)  X * F	[X*F
One-shot duration: 10 ms  X * G	[X*G
One-shot duration: 20 ms  X * H	[X*H
One-shot duration: 30 ms  X * I	[X*I

Menu sheet	Command
One-shot duration: 40 ms  X * J	[X*J]
One-shot duration: 50 ms  X * K	[X*K]
One-shot duration: 60 ms  X * L	[X*L]
One-shot duration: 70 ms  X * M	[X*M]
One-shot duration: 80 ms  X * N	[X*N]
One-shot duration: 90 ms  X * O	[X*O]
One-shot duration: 100 ms  X * P	[X*P]

Setting for label registration

You should first register codes in the reader so that they are recognized as OK. This function outputs the OK signal when the reader reads a code that matches one of the registered codes and outputs the NG signal for a code that does not match any of those codes.

Up to 5 codes can be registered.



Up to 123 bytes of a single set of data, and up to 250 bytes of data in total can be registered.

E.g.: The following describes the steps for registering labels.

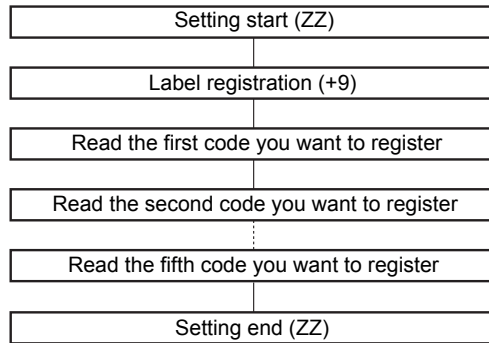

















Menu sheet	Command
Register labels  + 9	+9

To cancel a label registration, end the setting without reading a label in label registration processing.



Setting for communication conditions

The settings made here are not fixed until the menu sheet “ZZ” for ending setting is read or the setting save command “Z2” is transmitted and the reader is restarted.

Menu sheet	Command
Communication speed: 300 bps 	K1
Communication speed: 600 bps 	K2
Communication speed: 1200 bps 	K3
Communication speed: 2400 bps 	K4
Communication speed: 4800 bps 	K5
Communication speed: 9600 bps (Factory default setting) 	K6
Communication speed: 19200 bps 	K7
Communication speed: 38400 bps 	K8
Communication speed: 57600 bps 	K9
Communication speed: 115200 bps 	SZ

Menu sheet	Command
Data length: 7 bits  L 0	L0
Data length: 8 bits (Factory default setting)  L 1	L1
Parity: None (Factory default setting)  L 2	L2
Parity: Even number  L 3	L3
Parity: Odd number  L 4	L4
Stop bit: 1 bit (Factory default setting)  L 5	L5
Stop bit: 2 bits  L 6	L6

Setting for the communication protocol

Menu sheet	Command
Communication protocol: No protocol system (Factory default setting)  P 0	P0
Communication protocol: With RS/CS control (Ready/Busy system)  P 1	P1
Communication protocol: ACK/NAK system  P 3	P3
CS waiting time: Not limited (Factory default setting)  I 0	I0
CS waiting time: 100 ms  I 1	I1
CS waiting time: 200 ms  I 2	I2
CS waiting time: 400 ms  I 3	I3



Setting for the header and footer

Direct input header and footer of up to 4 digits can be set.

The number of digit output setting (p.86) can be included as 1 digit in the header.

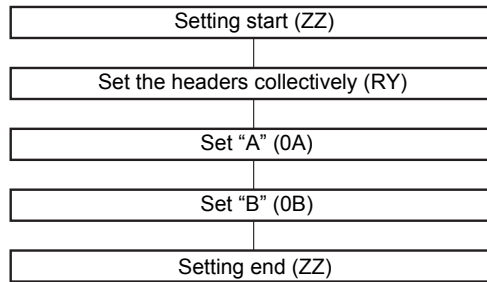
E.g.: The following describes the steps for setting the header (AB).



Menu sheet	Command
Set the headers collectively (Applied to all codes)  R Y	RY
Clear the header (Applied to all codes)  M G	MG
Set the footers collectively (Applied to all codes)  R Z	RZ
Clear the footer (Applied to all codes)  P R	PR

Number of digit output

Whether to output the number of digits to the data output format is specified.



This setting item can be registered as 1 item of the header and is added to a location determined by the order of registration.

Two-byte characters are handled as 2 characters in 2D codes.

Set "Clear the header (PR)" to clear the number of digit output.

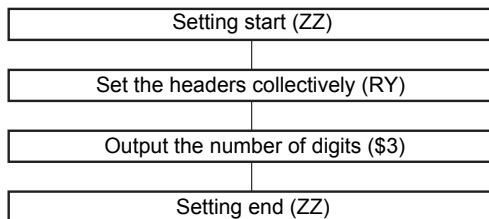
E.g.: The following describes the steps for setting the number of digit output.



Menu sheet	Command
Number of digit output (Bar code: 2 digits, 2D code: 6 digits) 	\$3
Number of digit output (Bar code and 2D code: 6 digits) 	\$6













The output format is as shown below.











- When the the number of digits output is set to [ZZRY\$3ZZ] (barcode 2 digits), the number of digits is "05" when the data of the barcode of the scanned code is "ABCDE".
- When the number of digits output is set to [ZZRY\$6ZZ] (barcode 6 digits), the number of digits is "000005" when the data of the barcode of the scanned code is "ABCDE".











Direct code designation

Used to set character strings and values directly when designating the header or footer.



Menu sheet	Command
<SPACE> 	5A
! 	5B
" 	5C
# 	5D
\$ 	5E
% 	5F
& 	5G
' 	5H
(	5I
) 	5J

Menu sheet	Command
* 	5K
+ 	5L
, 	5M
- 	5N
. 	5O
/ 	5P
: 	6A
; 	6B
< 	6C
= 	6D
> 	6E







Menu sheet	Command
? 	6F
@ 	6G
[	7A
\ 	7B
] 	7C
^ 	7D
_ 	7E
` 	7F
{ 	9T
 	9U
} 	9V











Menu sheet	Command
~ 	9W
0 	Q0
1 	Q1
2 	Q2
3 	Q3
4 	Q4
5 	Q5
6 	Q6
7 	Q7
8 	Q8
9 	Q9











Menu sheet	Command
<p>A</p>  <p style="text-align: center;">0 A</p>	0A
<p>B</p>  <p style="text-align: center;">0 B</p>	0B
<p>C</p>  <p style="text-align: center;">0 C</p>	0C
<p>D</p>  <p style="text-align: center;">0 D</p>	0D
<p>E</p>  <p style="text-align: center;">0 E</p>	0E
<p>F</p>  <p style="text-align: center;">0 F</p>	0F
<p>G</p>  <p style="text-align: center;">0 G</p>	0G
<p>H</p>  <p style="text-align: center;">0 H</p>	0H
<p>I</p>  <p style="text-align: center;">0 I</p>	0I
<p>J</p>  <p style="text-align: center;">0 J</p>	0J
<p>K</p>  <p style="text-align: center;">0 K</p>	0K







Menu sheet	Command
L 	0L
M 	0M
N 	0N
O 	0O
P 	0P
Q 	0Q
R 	0R
S 	0S
T 	0T
U 	0U
V 	0V









Menu sheet	Command
W 	0W
X 	0X
Y 	0Y
Z 	0Z
a 	A
b 	B
c 	C
d 	D
e 	E
f 	F
g 	G

Menu sheet	Command
h 	\$H
i 	\$I
j 	\$J
k 	\$K
l 	\$L
m 	\$M
n 	\$N
o 	\$O
p 	\$P
q 	\$Q
r 	\$R

Menu sheet	Command
<p>s</p> 	\$S
<p>t</p> 	\$T
<p>u</p> 	\$U
<p>v</p> 	\$V
<p>w</p> 	\$W
<p>x</p> 	\$X
<p>y</p> 	\$Y
<p>z</p> 	\$Z
<p>(NULL)</p> 	9G
<p>(SOH)</p> 	1A
<p>(STX)</p> 	1B

Menu sheet	Command
(ETX)  1 C	1C
(EOT)  1 D	1D
(ENQ)  1 E	1E
(ACK)  1 F	1F
(BEL)  1 G	1G
(BS)  1 H	1H
(HT)  1 I	1I
(LF)  1 J	1J
(VT)  1 K	1K
(FF)  1 L	1L
(CR)  1 M	1M

Menu sheet	Command
(SO) 	1N
(SI) 	1O
(DLE) 	1P
(DC1) 	1Q
(DC2) 	1R
(DC3) 	1S
(DC4) 	1T
(NAK) 	1U
(SYN) 	1V
(ETB) 	1W
(CAN) 	1X

Menu sheet	Command
(EM) 	1Y
(SUB) 	1Z
(ESC) 	9A
(FS) 	9B
(GS) 	9C
(RS) 	9D
(US) 	9E
DELL 	9F

Section 5

Appendix

☒ Maintenance	100
☒ Troubleshooting	101
☒ Specifications and External Dimension	102
☒ ASCII Code Table	108
☒ Quick-Reference Tables of Data Capacities	109

Maintenance

Directions on the handling of the reader

The reading window contains precision optics. Care should be taken when handling the reader.

Dust, dirt or cracks should degrade image capture conditions, rendering data unreadable.



CHECK!

- Do not touch the lens with hands or any sharp object.
- Use the reader in a dust- and dirt-free environment. If the lens becomes contaminated, clean it with a lens cleaning cloth or an airbrush.

Inspection

To use the reader in a good working condition, do the following:



CHECK!

- If the lens becomes contaminated with dust or dirt, remove it with a lens cleaning cloth or an airbrush.
- For dust or dirt on other surfaces, gently wipe off with a soft cloth.

Item to be inspected	Description	Tool required
Power supply	Should be within the rating voltage (5 V +/-10%) when the voltage is measured on the power supply terminal block.	Voltmeter
Operating temperature limit	Should be within a range of 0 to 45°C when the interior temperature is measured.	Thermometer
Operating humidity limit	Should be within a range of 35 to 85% when the interior temperature is measured.	Hygrometer
Condition of the reader installed	The reader and its mounting bracket must be properly secured.	Torque driver

Troubleshooting

■ Connection

Symptom	Cause	Refer to:
Buzzer does not sound when power is supplied	<ul style="list-style-type: none"> The power supply is not properly connected. Not enough power capacity/current capacity. 	p.33 p.102

■ Reading operation

Symptom	Cause	Refer to:
Unable to read	<ul style="list-style-type: none"> Reading prohibition is set for the relevant code. The minimum resolution, reading distance and contrast are not within the effective range. 	p.62 p.29, p.102

■ External input/output signals (TRIG, OK, NG)

Symptom	Cause	Refer to:
Fails to respond to signal from TRIG	<ul style="list-style-type: none"> The signal line is not properly connected. 	p.31
OK and NG signals are not output	<ul style="list-style-type: none"> The signal line is not properly connected. 	p.31

■ RS-232C

Symptom	Cause	Refer to:
Communication failure	<ul style="list-style-type: none"> The communication cable is not properly connected. Communication specifications do not conform to upper equipment. Correct communication protocol is not selected. 	p.33 p.52 p.49, p.84

Specifications and External Dimension

Specifications

■ General specification

Model		V400-R2CF65	V400-R2CF125	
Direction of view		Front view		
Applicable codes	Bar code	WPC(JAN/EAN/UPC), Codabar(NW-7), ITF,Industrial2of5(STF), Code39, Code93, Code128, GS1-128(EAN-128), GS1-Databar(RSS-14), GS1-Databar Limited(RSS Limited), GS1-Databar Expanded(RSS Expanded), GS1-Databar Composite(RSS Composite)		
	2D code	QR code, DataMatrix(ECC200), MicroQR code, PDF417, MicroPDF417, AztecCode, MaxiCode, Codablock-F		
	Number of reading digits	No upper limit (depends on bar width and reading distance)		
Reading performance (*)	Light source	Two red LEDs (wave length: 617 nm)		
	Aiming light	One green LED (wave length: 528 nm)		
	Minimum resolution	Bar code: 0.076 mm	Bar code: 0.127 mm	
		2D code: 0.169 mm	2D code: 0.212 mm	
	Image capture device	Monochrome CMOS		
	Effective number of pixels	754 × 480 pixels		
	Working distance (WD)	65 mm	125 mm	
		Field of view	Approximately 48 × 31 (for WD = 65 mm)	Approximately 93 × 59 (for WD = 125 mm)
	Pitch angle (α)	±50°		
	Screw angle (β)	±50°		
	Tilt angle (γ)	±180°		
	Reading of bar codes on curved surfaces (R)	R ≥ 20mm (UPC 12 line)		
Interface	Communication specification	RS-232C		
	OK/NG outputs	NPN open collector output (cable work required)		
Function setting method		Menu sheet reading method or host command method		
Functional specifications	Reading trigger	External trigger (Transistor input) Trigger by command (RS-232C) Trigger a test reading by pressing the SCAN button on the product		
	OK/NG signals	OK signal is turned on to indicate a successful read OK signal is turned on to indicate a successful read of registered label NG signal is turned on to indicate a successful read of a non-registered label		
	Indication LED	OK LED (green) illuminates to indicate a successful read		
	Buzzer	Notifies a successful reading with a buzzer sound (Muting available)		

Power supply specification	Power voltage	4.5 to 5.5 VDC
	Consumption current	During operation: 265 mA or less; during standby: 70 mA or less
Environmental specifications	Ambient temperature range	At operation: 0 to + 45°C; At storage: -10 to + 60°C
	Ambient humidity range	At operation and storage: 20 to 85% RH (with no icing or condensation)
	Ambient atmosphere	No corrosive gases
	Ambient light	Fluorescent lamp: 10,000lx or less, Sunlight: 100,000lx or less
	Vibration resistance	10 to 150 Hz, half amplitude 0.35 mm, 3 directions (X/Y/Z), 8 minutes each 10 times
Degree of protection		IP54 (IEC60529)
Weight	Main unit only	Approximately 90 g
	Including accessories	Approximately 200 g (including mounting bracket and screws)
	Packaged weight	Approximately 280 g (including packing carton)
Dimensions	Main unit	Approximately 41(W) × 33(D) × 24(H) mm
	Packing carton	Approximately 240(W) × 110(D) × 40(H) mm
Input/output connector		Round DIN connector
Code length		Approximately 1.5 m
Minimum bending radius of cord		Approximately 23 mm
Accessories		Operation manual, menu sheet, mounting bracket, M2 × 6 screws (two), M5 × 10 screws (two)
Material, Color	Case	PC, PET, black
	Reading window	PMMA, transparent
	Cable	Polyvinyl chloride (PVC), black
	Mounting bracket	SUS304, silver

* Unless otherwise specified, the reading performance is defined with angle $\alpha = 0^\circ$, $\beta = +15^\circ$, $r = 0^\circ$, $R = \infty$; illuminance: 100 to 200lx, reading rate: 90% or more.

External Dimension

Multi-code Reader

V400-R2CF65/R2CF125

(Unit: mm)

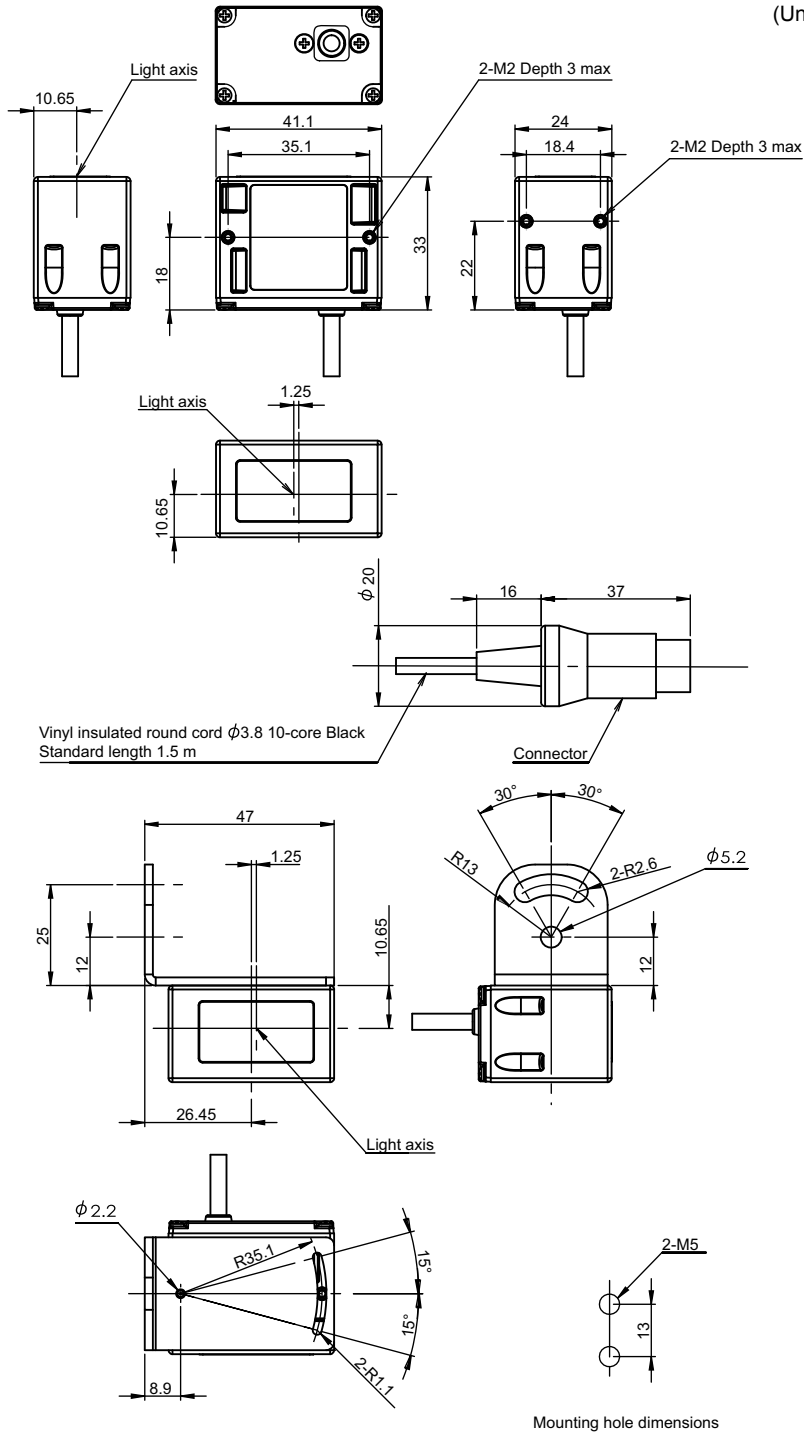

Mounting bracket

(Unit: mm)

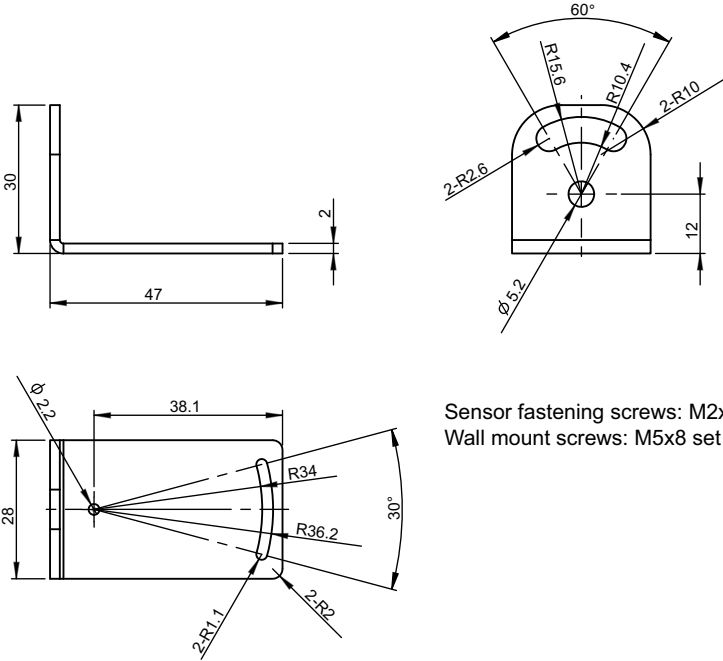

Sensor fastening screws: M2x5 set screws x2
Wall mount screws: M5x8 set screws x2

Cable for programmable controller connection made by OMRON
V509-W011

(Unit: mm)

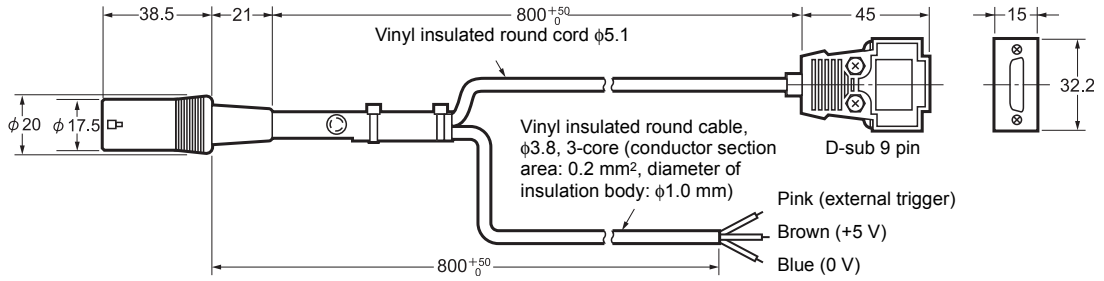

Reader side
DIN 8-pin connector

Upper equipment side
D-sub 9 pin

No.	Signal name
1	SD
2	RD
3	RS
4	CS
5	TRIG
6	-
7	SG
8	+5 V

Signal name	No.
FG	1
SD	2
RD	3
RS	4
CS	5
-	6
-	7
-	8
SG	9

Shield cable

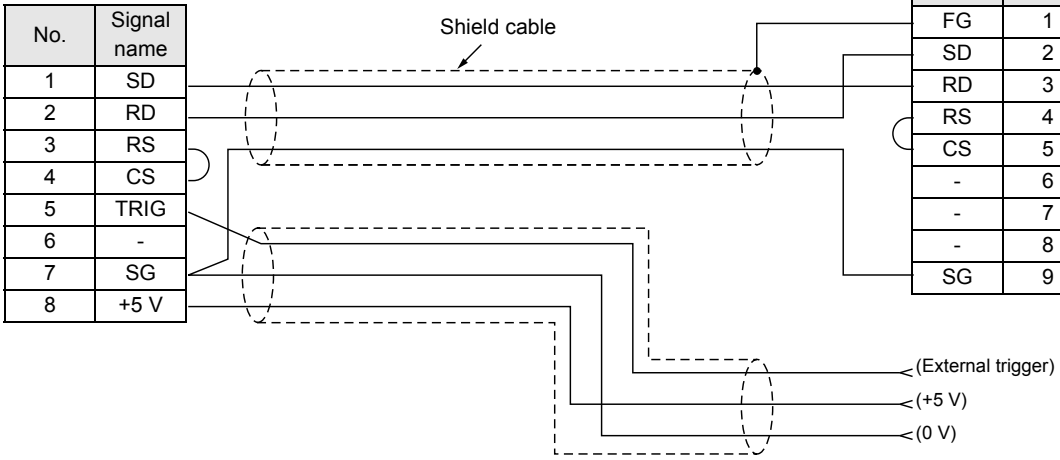

**Cable for connecting PC/AT compatible
V509-W011D**

(Unit: mm)

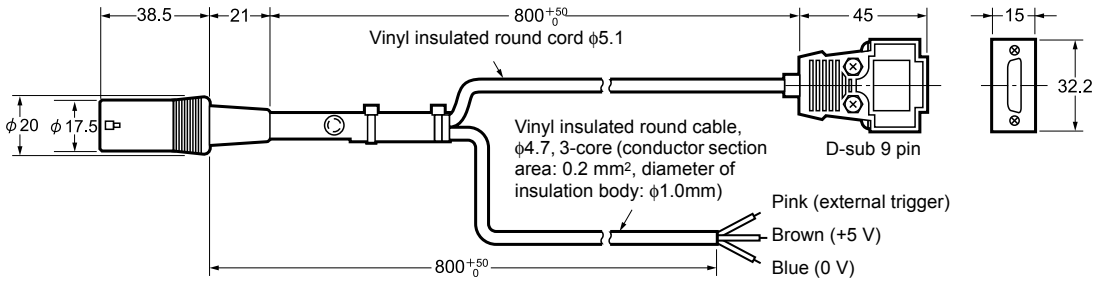

Reader side
DIN 8-pin connector

Upper equipment side
D-sub 9 pin

No.	Signal name
1	SD
2	RD
3	RS
4	CS
5	TRIG
6	-
7	SG
8	+5 V

Signal name	No.
-	1
RD	2
SD	3
ER	4
SG	5
DR	6
RS	7
CS	8
-	9
Shield wire	Connector Cover

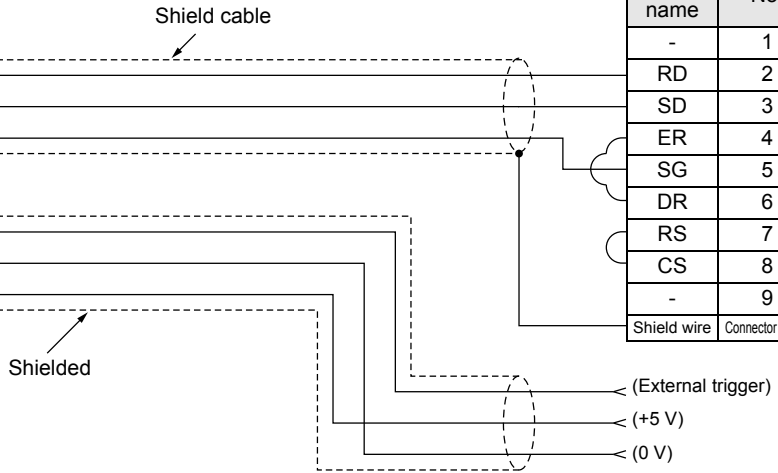

ASCII Code Table

Data read via RS-232C communications is output in ASCII code.

The table below shows one-to-one correspondence between each character and the ASCII code used.

Examples:

- For read data “A”: Hexadecimal “41” is output.
- For read data “T”: Hexadecimal “54” is output.

Upper 4 bits

		Upper 4 bits							
		0	1	2	3	4	5	6	7
Lower 4 bits	0		D _E		0	@	P	`	p
	1	S _H	D ₁	!	1	A	Q	a	q
	2	S _X	D ₂	”	2	B	R	b	r
	3	E _X	D ₃	#	3	C	S	c	s
	4	E _T	D ₄	\$	4	D	T	d	t
	5	E _Q	N _K	%	5	E	U	e	u
	6	A _K	S _N	&	6	F	V	f	v
	7	B _L	E _B	'	7	G	W	g	w
	8	B _S	C _N	(8	H	X	h	x
	9	H _T	E _M)	9	I	Y	i	y
	A	L _F	S _B	*	:	J	Z	j	z
	B	H _M	E _C	+	;	K	[k	{
	C	C _L	F _S	,	<	L	¥	l	!
	D	C _R	G _S	-	=	M]	m	}
	E	S _O	R _S	.	>	N	^	n	~
	F	S _I	U _S	/	?	O	_	o	

Quick-Reference Tables of Data Capacities

The maximum amount of data that can be stored in a code varies with the symbol size. The character types, order and combinations of different characters also affects the data capacity. The relation between symbol size (number of cells) and data capacity is shown in the table below.

■ DataMatrix

▪ DataMatrix ECC200

In this example, the symbol size is 12 × 12 cells.

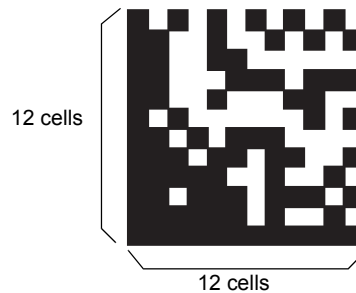

Symbol size	Maximum data capacity				
	Numbers	Alphanumeric characters	Symbols	Kanji (two bytes)	Kana (one byte)
10 × 10	6	3	3	-	1
12 × 12	10	6	5	1	3
14 × 14	16	10	9	3	6
16 × 16	24	16	14	5	10
18 × 18	36	25	22	8	16
20 × 20	44	31	28	10	20
22 × 22	60	43	38	14	28
24 × 24	72	52	46	17	34
26 × 26	88	64	57	21	42
32 × 32	124	91	81	30	60
36 × 36	172	127	113	42	84
40 × 40	228	169	150	56	112
44 × 44	288	214	190	72	142
48 × 48	348	259	230	86	172
52 × 52	408	304	270	101	202
64 × 64	560	418	372	139	278
8 × 18	10	6	5	1	3
8 × 32	20	13	12	4	8
12 × 26	32	22	20	7	14
12 × 36	44	31	28	10	20
16 × 36	64	46	41	15	30
16 × 48	98	72	64	23	47

■ QR Code

▪ QR Code Model 2

In this example, the symbol size is 21 x 21 cells (version 1).

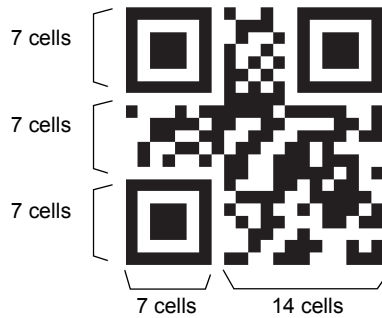

Symbol size (version)	Error correction level (ECC level)	Maximum data capacity			
		Numbers	Alphanumeric characters (upper case only)	8 bits (byte)	Kanji
21 × 21 (version 1)	L (7%)	41	25	17	10
	M (15%)	34	20	14	8
	Q (25%)	27	16	11	7
	H (30%)	17	10	7	4
25 × 25 (version 2)	L (7%)	77	47	32	20
	M (15%)	63	38	26	16
	Q (25%)	48	29	20	12
	H (30%)	34	20	14	8
29 × 29 (version 3)	L (7%)	127	77	53	32
	M (15%)	101	61	42	26
	Q (25%)	77	47	32	20
	H (30%)	58	35	24	15
33 × 33 (version 4)	L (7%)	187	114	78	48
	M (15%)	149	90	62	38
	Q (25%)	111	67	46	28
	H (30%)	82	50	34	21
37 × 37 (version 5)	L (7%)	255	154	106	65
	M (15%)	202	122	84	52
	Q (25%)	144	87	60	37
	H (30%)	106	64	44	27
41 × 41 (version 6)	L (7%)	322	195	134	82
	M (15%)	255	154	106	65
	Q (25%)	178	108	74	45
	H (30%)	139	84	58	36

Symbol size (version)	Error correction level (ECC level)	Maximum data capacity			
		Numbers	Alphanumeric characters (upper case only)	8 bits (byte)	Kanji
45 × 45 (version 7)	L (7%)	370	224	154	95
	M (15%)	293	178	122	75
	Q (25%)	207	125	86	53
	H (30%)	154	93	64	39
49 × 49 (version 8)	L (7%)	461	279	192	118
	M (15%)	365	221	152	93
	Q (25%)	259	157	108	66
	H (30%)	202	122	84	52
53 × 53 (version 9)	L (7%)	552	335	230	141
	M (15%)	432	262	180	111
	Q (25%)	312	189	130	80
	H (30%)	235	143	98	60
57 × 57 (version 10)	L (7%)	652	395	271	167
	M (15%)	513	311	213	131
	Q (25%)	364	221	151	93
	H (30%)	288	174	119	74

Source: 2D Codes, Basic Specifications for QR Code (JIS × 0510)



Maximum data capacity

The maximum amount of data that can be stored in a 2D code varies with the symbol size. In other words, if there is a large amount of data to be stored, then the symbol size must also be large.

The maximum data capacity will also vary with the type of characters used. With a QR Code or DataMatrix, the numeric capacity (numbers only) is larger than the alpha numeric capacity (numbers and letters), which is in turn larger than the Japanese Kanji capacity.

The order and combinations of different characters also affects the data capacity.

■ Micro QR Code

▪ Micro QR Code

In this example, the symbol size is 15 × 15 cells (version 3).

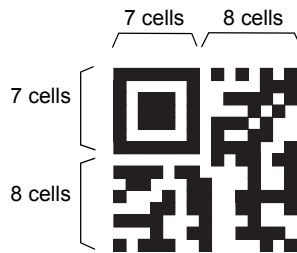

Symbol size (version)	Error correction level (ECC level)	Maximum data capacity			
		Numbers	Alphanumeric characters (upper case only)	8 bits (byte)	Kanji
11 × 11 (version 1)	-	5	-	-	-
13 × 13 (version 2)	L	10	6	-	-
	M	8	5	-	-
15 × 15 (version 3)	L	23	14	9	6
	M	18	11	7	4
17 × 17 (version 4)	L	35	21	15	9
	M	30	18	13	8
	Q	21	13	9	5

Index

Numerics

2D code 10, 54, 102

A

ACK/NAK system 49, 84
AND verification 71
ASCII Code Table 108

B

Bar code 10, 102
Basic configuration 18
Buzzer 77

C

C/D 65
Cell size 10
Check digit 65
Codabar(NW-7) 25, 54
CODE128 25
CODE39 25, 54
CODE93 25
Command 56
Command input 41, 57
Communication conditions 82
Communication protocol 49, 84
Communication speed 82
Communication time 50
Communication with upper equipment 33, 36, 54
Connecting cable 18
 PC 18
 Programmable controller 18
Connection
 PC 33
 Programmable controller 34
Consumption current 103
Continuous reading 38, 48, 72
CS1 34
Curvature 30, 102

D

Data length 83
DataMatrix 24, 109
Decoding failure 75
Direct code designation 87

E

EAN 25, 54
Effective duration 38
Effective duration designation system 38
Effective duration of reading 38
End setting 59
Example of program 36
External Dimension 104
External trigger signal 38, 59

F

Factory default setting 60
Failed reading 53, 75
Flow chart 46
Footer 85
Frame 74

G

GS1 DataBar (RSS) 26
GS1 DataBar Composite 26
GS1 DataBar Expanded 26
GS1 DataBar Limited 26
GS1 DataBar Omni-directional 26
GS1 DataBar Stacked 26
GS1 DataBar Truncated 26
GS1-128 54

H

Header 85
Height 10

I

Industrial2of5(STF) 25, 54
Initial setting 60
Input circuit 32
Installation 42, 43
Inverted code 70
ITF 25, 54

J

JAN 25, 54

L

Label 10
Label registration 81

M

Main cable	19
Maintenance	100
Margin	10
Matrix size	10
Menu sheet	56
Micro QR code	24, 112
Mounting bracket	42

N

Narrow bar	10
No label	75
No protocol system	49, 84
Nonprocedural system	49
Nonvolatile memory	59
Number of digits	86
Number of reading digits	76, 102

O

Output circuit	32
Output format	53

P

Parity	83
PC	
Connecting cable	18, 107
Connection	33
Wiring	33
PDF417	24
Pin arrangement	31
Pitch angle	29, 102
Plural reading	38, 47, 72
Plural reading reset time	74
Power supply	18
Programmable controller	
Connecting cable	18, 106
Connection	34
System settings	35
Wiring	34
Protocol	49, 84

Q

QR code	24, 110
Quick-Reference Tables of Data Capacities	109

R

Read confirmation LED	19
READ NG output	31

READ OK LED	77
READ OK output	31
READ OK signal	79
Reading angle	29
Reading coincidence	71
Reading operation	38, 72
Reading permission/prohibition	62
Reading range	27
Reading rate measurement mode	37
Reading system	38
Reading trigger	52
Reading valid time	38, 72
Reading window	19
Ready/Busy system	84
RS-232C command	38

S

SCAN button	19
Single reading	38, 46, 72
Skew angle	29, 102
ST/SP	65
Start code	65
Start setting	59
Stop bit	83
Stop code	65
Supported code list	24

T

Tilt angle	30, 102
Timing chart	50
Trigger controlled system	38
Trigger input method	38
Trigger reading	38

U

UPC	25
UPC-A	54
UPC-E	54

W

Width	10
Wiring	
PC	33
Programmable controller	34

MEMO

Revision History

A manual revision code appears as a suffix to the catalog number at the bottom of the front and back covers.

Cat. No. Z333-E1-02

↑
Revision code

Revision code	Date	Revised contents
01	January 2013	Original production
01A	March 2013	Minor corrections
02	August 2014	Minor corrections

OMRON Corporation Industrial Automation Company

Tokyo, JAPAN

Contact: www.ia.omron.com

Regional Headquarters

OMRON EUROPE B.V.

Sensor Business Unit

Carl-Benz-Str. 4, D-71154 Nufringen, Germany

Tel: (49) 7032-811-0/Fax: (49) 7032-811-199

OMRON ELECTRONICS LLC

One Commerce Drive Schaumburg,

IL 60173-5302 U.S.A.

Tel: (1) 847-843-7900/Fax: (1) 847-843-7787

OMRON ASIA PACIFIC PTE. LTD.

No. 438A Alexandra Road # 05-05/08 (Lobby 2),

Alexandra Technopark,

Singapore 119967

Tel: (65) 6835-3011/Fax: (65) 6835-2711

OMRON (CHINA) CO., LTD.

Room 2211, Bank of China Tower,

200 Yin Cheng Zhong Road,

PuDong New Area, Shanghai, 200120, China

Tel: (86) 21-5037-2222/Fax: (86) 21-5037-2200

Authorized Distributor:

© OMRON Corporation 2013 All Rights Reserved.
In the interest of product improvement,
specifications are subject to change without notice.

Cat. No. Z333-E1-02

0814