

Industrial Automation Guide 2015



Industrial Products & Systems

industrial.omron.eu

Targeted Technologies

Creating maximum output with minimum input

By identifying the many ways of innovation in specific industries we developed the 'targeted technologies' concept. It's a way of thinking about technology in a prioritized format. Prioritized according to our customers' most pressing needs. The result? A set of solutions that make immediate impact on the core of our customers' businesses. A set of solutions that hit the target every time. Take a look at the examples on our website.

industrial.omron.eu/technologies



PROplus Line

PROplus Line is a family of products that offer a wide range of solutions for your industrial automation needs. From basic control to advanced motion control, we have the right solution for you.

PROplus Line is a family of products that offer a wide range of solutions for your industrial automation needs. From basic control to advanced motion control, we have the right solution for you.

ES-Net temperature control

The new ES-Net temperature control system is a revolutionary new way to control temperature in industrial processes. It offers a wide range of solutions for your industrial automation needs.

The 361° Approach



OMRON Industrial Automation

Home News Products Solutions Services & Support Company Info Contact

Products > Technologies

Technologies

Creating maximum output with minimum input

Whatever type of automated machinery you are specialized in, you know that there are many ways to improve. You are already aware that there are many possible areas for improvement. But where do you start? Where do you focus your efforts? Where can you make the biggest difference with the least amount of effort?

At OMRON, we asked ourselves these questions too. And by identifying the answers in specific industries we developed the integrated technologies concept. It's a way of thinking about technology in a practical format. Practical according to our customers' most pressing needs. The result? A set of solutions that make immense impact on the core of our customers' business. A set of solutions that let the target away time. Take a look at the examples below.

Technologies

Systec: the all-in-one platform

We know that machine builders prefer different product solutions for different challenges. But this can cause lengthy headaches and communication issues. That's why we developed Systec: a single unified platform that is open, scalable, flexible, and totally focused on maintaining the speed and flexibility of machines. A platform that integrates robots, motion and sequential logic control into a single networking system.

[Learn more](#)

361°: the perfect match

When it comes to sensors and components, we know that our customers all have different needs. That's why our product development in this area is driven by the 361° Approach. It produces product families that offer a total all-round choice. From quality products suited to standard environments to specialist devices that can handle extremes. A full range of choice, all with an extra degree of quality and power stability.

[Learn more](#)

[Omron Europe](#) | [Omron Corporation](#) | [Yamaha of Ltd](#) | [Innovative Policy](#) | [Contact](#)
 Copyright © Omron Corporation 2012. All rights reserved.

realizing

The 361° portfolio

With over 120 sensors, you only pay for what you need. Combining multiple primary sensors in the one I2S range has never been possible. It's a revolutionary new way to combine multiple sensors in one package, saving space and reducing costs. It's a revolutionary new way to combine multiple sensors in one package, saving space and reducing costs.

[Learn more](#)

PRO Lite

If you need extra performance in your sensors, we've got you covered. The Omron PRO Lite is just what you need.

[Learn more](#)

I2S I/O

With over 120 sensors, you only pay for what you need. Combining multiple primary sensors in the one I2S range has never been possible. It's a revolutionary new way to combine multiple sensors in one package, saving space and reducing costs. It's a revolutionary new way to combine multiple sensors in one package, saving space and reducing costs.

[Learn more](#)

LITE

With over 120 sensors, you only pay for what you need. Combining multiple primary sensors in the one I2S range has never been possible. It's a revolutionary new way to combine multiple sensors in one package, saving space and reducing costs. It's a revolutionary new way to combine multiple sensors in one package, saving space and reducing costs.

[Learn more](#)

With grinding made easy

System controller

The new system controller is a revolutionary new way to control grinding processes. It offers a wide range of solutions for your industrial automation needs.

[Learn more](#)

Product groups

Systec

The Systec platform is a revolutionary new way to control grinding processes. It offers a wide range of solutions for your industrial automation needs.

[Learn more](#)

361°

The 361° approach is a revolutionary new way to control grinding processes. It offers a wide range of solutions for your industrial automation needs.

[Learn more](#)

ES-Net

The ES-Net temperature control system is a revolutionary new way to control temperature in industrial processes. It offers a wide range of solutions for your industrial automation needs.

[Learn more](#)

PROplus

The PROplus Line is a family of products that offer a wide range of solutions for your industrial automation needs. From basic control to advanced motion control, we have the right solution for you.

[Learn more](#)

Related product news

With over 120 sensors, you only pay for what you need

Combining multiple primary sensors in the one I2S range has never been possible. It's a revolutionary new way to combine multiple sensors in one package, saving space and reducing costs. It's a revolutionary new way to combine multiple sensors in one package, saving space and reducing costs.

[Learn more](#)

Related product news

ES-Net

The ES-Net temperature control system is a revolutionary new way to control temperature in industrial processes. It offers a wide range of solutions for your industrial automation needs.

[Learn more](#)

Related product news

ES-Net

The ES-Net temperature control system is a revolutionary new way to control temperature in industrial processes. It offers a wide range of solutions for your industrial automation needs.

[Learn more](#)

PROplus

The PROplus Line is a family of products that offer a wide range of solutions for your industrial automation needs. From basic control to advanced motion control, we have the right solution for you.

[Learn more](#)

Welcome to our world

Our best-in-class devices for your automation system

Welcome to Omron's world of advanced industrial automation. The INDUSTRIAL AUTOMATION GUIDE is your essential tool to select best-in-class devices for your automation system. It highlights our core competences in sensing, control, visualisation, motion and panel components.

Of course, Omron offers a much larger range of products than you can find on the attached DVD's. For more information on services and company competence visit our website.

Here you will find:

- Latest product news
- Technical product specifications
- 2D / 3D CAD Library
- Customer references
- Technology concepts
- Supporting product documentation
- Knowledge Base - "myOmron"
- Events Calendar
- Contact information

Find information fast!

Quick Links shortens your search. Quick Links are unique codes assigned to Omron products listed in this guide. Enter Quick Link codes in the search box on industrial.omron.eu to access detailed information on products in this guide.



Quick Link

Industrial Automation Guide 2015

Automation systems

Machine automation controller	10
Programmable logic controllers (PLC)	16
Remote I/O	44
Human machine interfaces (HMI)	58
I/O cables and terminal blocks	72
Ethernet cables and accessories	81

Motion & Drives

Motion controllers	86
Servo systems	102
Frequency inverters	150

Sensing

Photoelectric sensors	172
Mark and color sensors	214
Lightcurtains and area sensors	222
Fiber optic sensors and amplifiers	230
Inductive sensors	262
Mechanical sensors/Limit switches	282
Rotary encoders	298
Cable connectors	306

Quality control & Inspection

Inspection & Ident systems	310
Measurement sensors	366

Safety

Control- and Signalling devices	402
Safety limit switches	426
Safety door switches	434
Safety sensors	462
Safety control systems	492

Control components

Temperature controllers	512
Power supplies	538
Timers	554
Counters	564
Programmable relays	574
Digital panel indicators	582

Switching components

Electromechanical relays	594
Solid state relays	608
Low voltage switchgear	618
Monitoring products	634
Pushbutton switches	662

Software

Software	674
Outline of Major Standards	680
Index	687

“To the machine the work of the machine,
to man the thrill of further creation.”

Kazuma Tateisi, founder of Omron

Omron at a glance

Listed in Top 2000 largest companies of the globe
Omron Corporation NASDAQ: OMRNY
Top ranking in Dow Jones Sustainability Index
Thomson Reuters Top 100 Global Innovators



200.000 products ranging input, logic and output

Sensing, Control Systems, Visualization, Drives, Robots,
Safety, Quality Control & Inspection, Control and
Switching Components

7%

Investment in Research & Development

Innovation track record of 80 years

Top 150 global patent assignee
1.200 employees dedicated to R&D
11.000 + issued and pending patents

36.500

Employees worldwide

210

Locations worldwide

22

Countries in EMEA

Working for the benefit of society

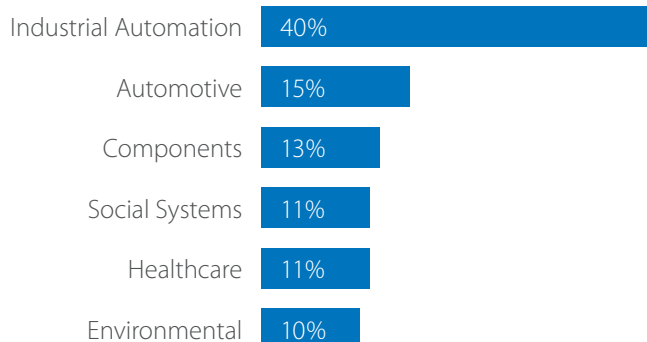

Sysmac Automation Platform

- One control for the entire machine or production cell
- Harmony between machine and people
- Open communication and open programming standards

SYSMAC
always in control

Your needs, our focus

Solutions perfectly matching your needs

We asked ourselves: 'What do you need in sensors and components?' Well, first you need reliability. Then a variety and choice of performance levels. You may also want advanced functionality, with special features defined by you – or you may want standardized solutions, with highly competitive prices.

Whatever it is, it can all add up to a wish list that is difficult to fulfil. Until now. That's because our new 361° Approach not only provides a complete all-round offer without gaps, it also puts you at the very centre of the product selection process. It's an approach that leads to a Perfect Match – one with the extra degree of confidence that comes from choosing Omron.

361° in one view

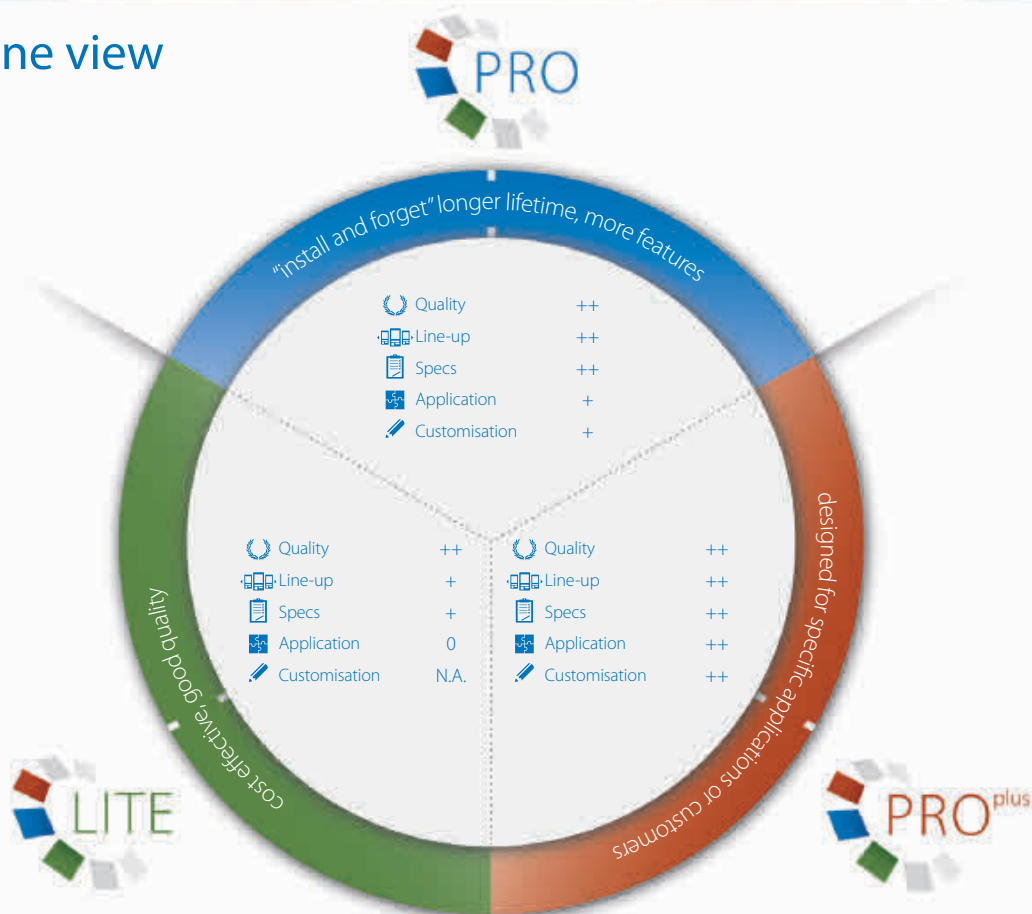

Three distinct lines

361° Approach offers three distinct lines within each sensor or component product category. LITE products are cost-effective without any compromise in quality. PRO products represent the "install & forget" option, offering longer lifetime, higher protection, and more features. While PRO^{plus} products are designed for specific applications or customer demands.

The extra degree of advantage

Three distinct lines of sensors and components

Optimized reliability

All three lines are backed by the Omron commitment to quality, so even when you need a price-competitive advantage, you can be confident that they will never let you down.

Solutions that perfectly match your needs

The 361° Approach ensures that you can quickly and easily identify the perfect match solution to your needs – nothing more, nothing less.

Optimized costs

Your sensor and component costs are also minimized – because it eliminates over-specification.

Why an extra 1°?

The extra degree is what you get when you do business with Omron, and that means different things to different customers – all depending on their needs. For example, if you need specification advice, the extra degree is 'service'. But ultimately, to everyone it means "an extra degree of confidence in the perfect match".



'Quality' refers to the standard of manufacturing and the materials used – this translates into reliability.



'Line-up' refers to the number of model types.



'Specs' refers to the choice of performance levels.



'Application' indicates the complexity of the automation.



'Customization' is the possibility to modify the product.

Product selection table

Automation systems



10 Machine automation controller

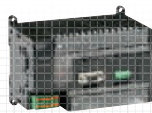

16 Programmable logic controllers (PLC)



44 Remote I/O



58 Human machine interfaces (HMI)

Motion & Drives



86 Motion controllers



102 Servo systems



150 Frequency inverters

Sensing



172 Photoelectric sensors



214 Mark and color sensors



222 Lightcurtains and area sensors



230 Fiber optic sensors and amplifiers

Quality control & Inspection



310 Inspection & Ident systems

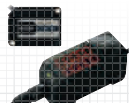

366 Measurement sensors

Safety



402 Control- and Signalling devices



426 Safety limit switches



434 Safety door switches



462 Safety sensors

Control components



512 Temperature controllers



538 Power supplies



554 Timers

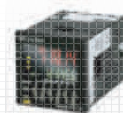

564 Counters

Switching components



594 Electromechanical relays



608 Solid state relays



618 Low voltage switchgear



634 Monitoring products

Software



674 Software



72 Cables and accessories



262 Inductive sensors

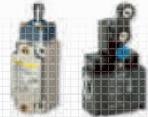

282 Mechanical sensors/Limit switches

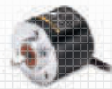

298 Rotary encoders

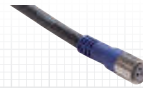

306 Cable connectors



492 Safety control systems



574 Programmable relays

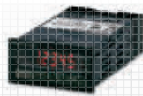

582 Digital panel indicators



662 Pushbutton switches

Automation systems

Find information fast!

Quick Links shortens your search. Quick Links are unique codes assigned to Omron products listed in this guide. Enter Quick Link codes in the search box on industrial.omron.eu to access detailed information on products in this guide.

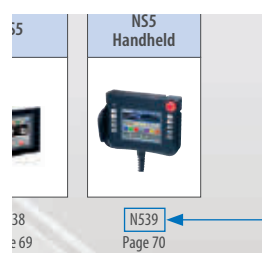

Quick Link

Automation systems

Machine automation controller

Product overview	10
Selection table	13
Machine controller	
NJ-Series	14

Programmable logic controllers (PLC)

Product overview	16
Selection table	18
Compact PLC	
CPM2C CPU units	20
CPM2C expansion units	21
CP1E CPU units	22
CP1L CPU units	24
CP1H CPU units	26
CP1W expansion units	27
Modular PLC	
CJ-Series CPU units	28
CJ-Series power supplies, expansions	30
CJ-Series digital I/O units	31
CJ-Series analog I/O and control units	32
CJ-Series motion/position control units	34
CJ-Series communication units	36
Rack PLC	
CS-Series CPU units	37
CS-Series power supplies, backplanes	38
CS-Series digital I/O units	39
CS-Series analog and process I/O units	40
CS-Series position/motion control units	42
CS-Series communication units	43

Remote I/O

Product overview	44
Selection table	47
Remote I/O	
NX-series modular I/O system	48
SmartSlice I/O system	51
Compact I/O GX-series	52
Compact I/O DRT2	53
Compact I/O CRT1	54
Compact I/O SRT2	55
Field I/O DRT2-_C	56
Field I/O SRT2-_C	57

Human machine interfaces (HMI)

Product overview	58
Selection table	60
Integrated HMI	
NA7/9/12/15	62
Scalable HMI	
NS15/NS12/NS10/NS8	64
NS5	65
NS5 handheld	66
Integrated controller/Scalable HMI	
Accessories NS	67
Compact HMI	
NB series	68
Function-key HMI	
NT11	70
NT2S	71

Cables and accessories

I/O cables and terminal blocks	
I/O cables	72
I/O terminal blocks	80
Ethernet cables and accessories	
Ethernet cables	81
Accessories	82
Wireless communication	
WE70	83

Machine automation controller

NJ-SERIES MACHINE AUTOMATION CONTROLLER

Complete and robust machine automation

The NJ-Series Machine Automation Controller is at the heart of the new Sysmac platform. One integrated machine controller that offers speed, flexibility and scalability of software centric architecture without compromising on the traditional reliability and robustness that you have come to expect from Omron PLCs. The NJ-Series is designed to meet extreme machine control requirements in terms of motion control speed and accuracy, communication, security and robust system. You just create...

- Integration of logic and motion in one Intel CPU
- Scalable control: CPUs for 4, 8, 16, 32 and 64 axes
- EtherCAT and EtherNet/IP ports embedded
- Fully conforms to IEC 61131-3 standards
- Certified PLCopen function blocks for motion control
- Linear, circular and spiral (helical) interpolation
- CPU units with SQL client and robotic functionality



SYSMAC
always in control

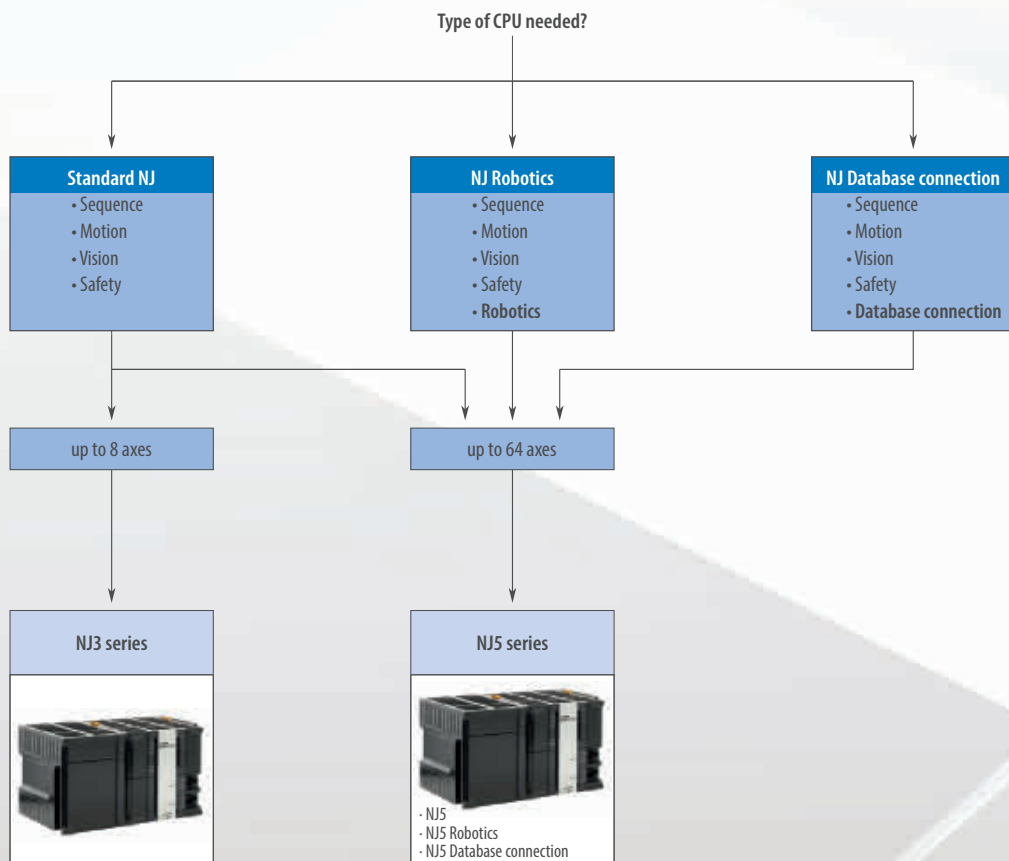

H245
Page 14

H248, H246, H252
Page 14

		Machine automation controller					
							
Model	NJ5		NJ5 Robotics		NJ5 with Database connection		NJ3
Description	NJ5 series Machine Controller with Sequence and Motion functionality		NJ5 series Machine Controller with Sequence, Motion and Robotics functionality		NJ5 series Machine Controller with Sequence, Motion and Database connection functionality		NJ3 series Machine Controller with Sequence and Motion functionality
Task	Multi-tasking program						
Software	Sysmac Studio						
Programming	<ul style="list-style-type: none"> Ladder Structured Text In-Line ST 						
Standard programming	<ul style="list-style-type: none"> IEC 61131-3 PLCopen Function Blocks for Motion Control 						
Program capacity	20 MB						5 MB
SD Memory Card	SD and SDHC Memory card						
Built-in port	<ul style="list-style-type: none"> EtherNet/IP EtherCAT USB 2.0 						
EtherCAT slaves	192						
Number of axes	64, 32, 16						8, 4
Servo Drive	Accurax G5/EtherCAT						
Motion Control	<ul style="list-style-type: none"> Axes groups interpolation and single axis moves Electronic cams and gearboxes Direct position control for axis and group 		<ul style="list-style-type: none"> Axes groups interpolation and single axis moves Electronic cams and gearboxes Direct position control for axis and group Up to 8 Delta Robot control 		<ul style="list-style-type: none"> Axes groups interpolation and single axis moves Electronic cams and gearboxes Direct position control for axis and group 		
Local I/O	(Compatible CJ series units)	Digital I/O units	Analog I/O units	Special I/O units	Communication units	ID sensor units	
		CJ1W-IA201 CJ1W-IA111 CJ1W-ID201 CJ1W-ID211 CJ1W-ID211(SL) CJ1W-ID212 CJ1W-INT01 CJ1W-IDP01 CJ1W-ID231 CJ1W-ID232 CJ1W-ID233 CJ1W-ID261 CJ1W-ID262 CJ1W-ID262 CJ1W-OA201 CJ1W-OC201 CJ1W-OC201(SL) CJ1W-OC211 CJ1W-OC211(SL) CJ1W-OD201 CJ1W-OD203 CJ1W-OD211 CJ1W-OD211(SL)	CJ1W-OD213 CJ1W-OD231 CJ1W-OD233 CJ1W-OD234 CJ1W-OD261 CJ1W-OD263 CJ1W-OD202 CJ1W-OD204 CJ1W-OD212 CJ1W-OD212(SL) CJ1W-OD232 CJ1W-OD262 CJ1W-MD232 CJ1W-MD231 CJ1W-MD233 CJ1W-MD261 CJ1W-MD263 CJ1W-MD563	CJ1W-AD04U CJ1W-AD04U(SL) CJ1W-AD041-V1 CJ1W-AD041-V1(SL) CJ1W-AD042 CJ1W-AD081-V1 CJ1W-AD081-V1(SL) CJ1W-DA021 CJ1W-DA021(SL) CJ1W-DA041 CJ1W-DA041(SL) CJ1W-DA042V CJ1W-DA08V CJ1W-DA08V(SL) CJ1W-DA08C CJ1W-DA08C(SL) CJ1W-MAD42 CJ1W-MAD42(SL) CJ1W-PH41U CJ1W-PDC15 CJ1W-TS561 CJ1W-TS561(SL) CJ1W-TS562 CJ1W-TS562(SL) CJ1W-TC003 CJ1W-TC004 CJ1W-TC103 CJ1W-TC104	CJ1W-CT021 CJ1W-CTL41-E	CJ1W-SCU22 CJ1W-SCU32 CJ1W-SCU42 CJ1W-EIP21 CJ1W-DRM21 CJ1W-CRM21 CJ1W-PRM21 CJ1W-PRT21 CJ1W-PNT21 CJ1W-CIF11	CJ1W-V680C11 CJ1W-V680C12
Remote I/O	NX I/O units/EtherCAT						
Mounting	DIN rail						
Global standards	CE, cULus, NK, LR						
Page/Quick Link	14						



Complete and robust machine automation

The NJ-Series is designed to meet extreme machine control requirements in terms of motion control speed and accuracy, communication, security and robustness.

- Integration of logic and motion in one Intel CPU
- Scalable control: CPUs for 4, 8, 16, 32 and 64 axes
- EtherCAT and EtherNet/IP ports embedded
- Fully conforms to IEC 61131-3 standards
- Certified PLCopen function blocks for motion control
- Linear, circular and spiral (helical) interpolation
- CPU units with database connection and robotic functionality

Ordering information

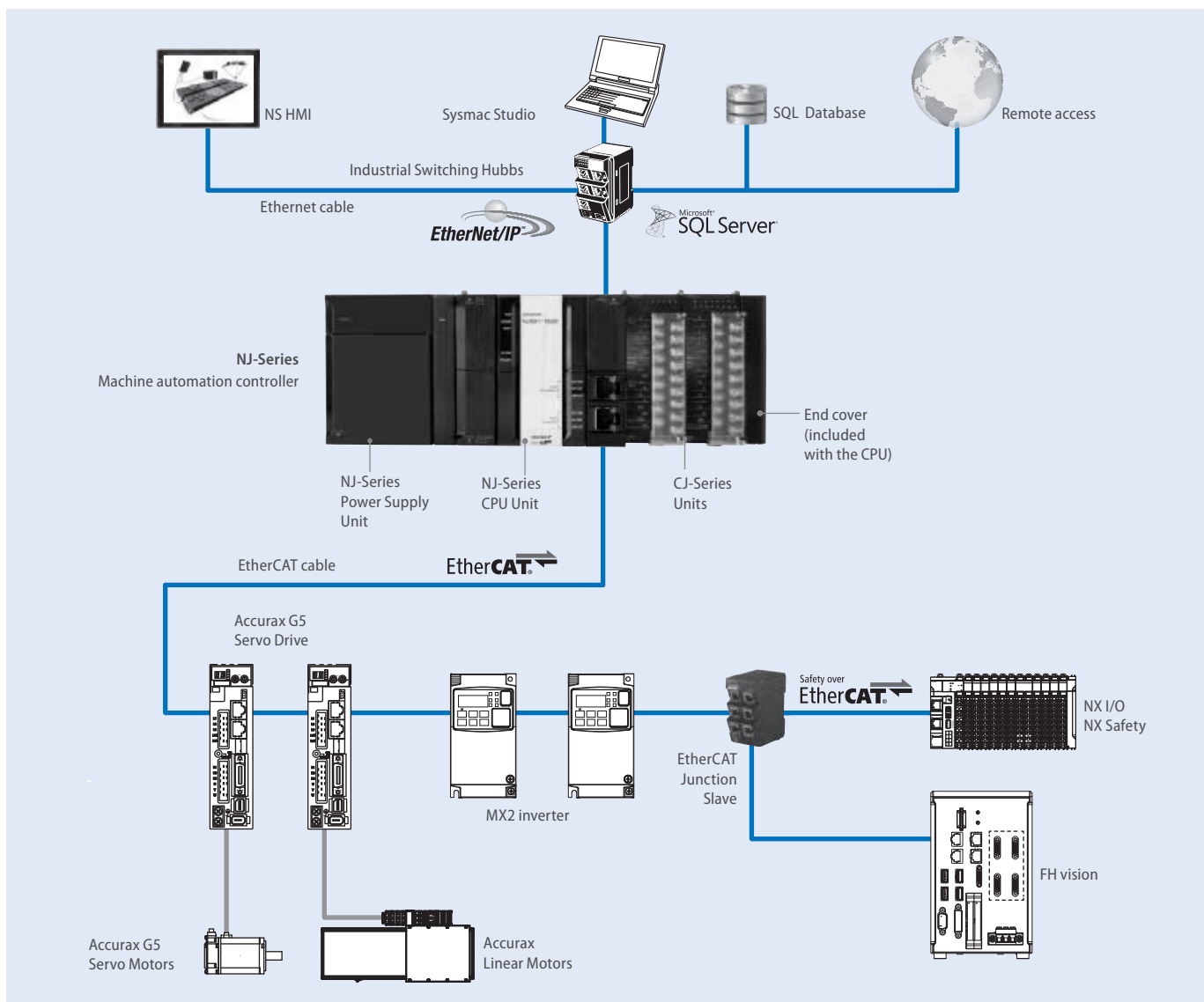

Power supply

Type	Output capacity at 5 VDC	Output capacity at 24 VDC	Max. output power	Features	Size in mm (H × W × D)	Order code
100 to 240 VAC	6.0 A	1.0 A	30 W	Run output	90 × 70 × 90	NJ-PA3001
24 VDC						NJ-PD3001

CPU

Series	Description	Max. Digital I/O points	Program capacity	Variables capacity	Max. I/O units	5 VDC current consumption	Size in mm (H × W × D)	Number of axes	Order code
NJ5 series	Sequence and motion functionality	2,560	20 MB	2 MB: Retained 4 MB: Not retained	CPU rack: 10 units max. Expansion rack: 40 units max. (up to 3 expansion racks)	1.90 A	90 × 90 × 90	64	NJ501-1500
	Sequence, motion and robotics functionality							32	NJ501-1400
								16	NJ501-1300
								64	NJ501-4500
	Sequence, motion and database connection functionality							32	NJ501-4400
								16	NJ501-4300
									NJ501-4310*1
	Sequence, motion and database connection functionality							64	NJ501-1520
								32	NJ501-1420
16		NJ501-1320							
NJ3 series	Sequence and motion functionality		5 MB	0,5 MB: Retained 2 MB: Not retained				8	NJ301-1200
								4	NJ301-1100

*1 The NJ501-4310 CPU unit only supports one delta robot.

Note: The end cover unit CJ1W-TER01 is included with the CPU unit.

Accessories

Type	Remarks	Size in mm (H × W × D)	Order code
EtherCAT branching unit	3 ports, 24 VDC, DIN rail mounting	90 × 25 × 78	GX-JC03
	6 ports, 24 VDC, DIN rail mounting	90 × 48 × 78	GX-JC06
Industrial switching hub	3 ports, 24 VDC, DIN rail mounting	90 × 25 × 78	W4S1-03B
	5 ports, 24 VDC, DIN rail mounting	90 × 48 × 78	W4S1-05B
	5 ports, 24 VDC, failure detection, DIN rail mounting	90 × 48 × 78	W4S1-05C
SD memory card	2 GB		HMC-SD291
	4 GB		HMC-SD491
DIN track	Length: 0.5 m, height: 7.3 mm		PPF-50N
	Length: 1 m, height: 7.3 mm		PPF-100N
	Length: 1 m, height: 16 mm		PPF-100N2
End plate to secure the units on the DIN track	2 pieces are included with the CPU unit and I/O interface unit		PPF-M (2 pcs.)
Battery for NJ-series CPU unit	The battery is included with the CPU unit		CJ1W-BAT01
End cover	The end cover is included with each CPU unit and I/O interface unit		CJ1W-TER01

Computer software

Specifications	Order code
Sysmac Studio	SYSMAC-SE2_____

Programmable logic controllers (PLC)

KNOW ONE ... KNOW THEM ALL!

Whether your automation requires a simple and economical solution, or your target is advanced, high-speed control, you can find what you need in Omron's line-up of Programmable Controllers.

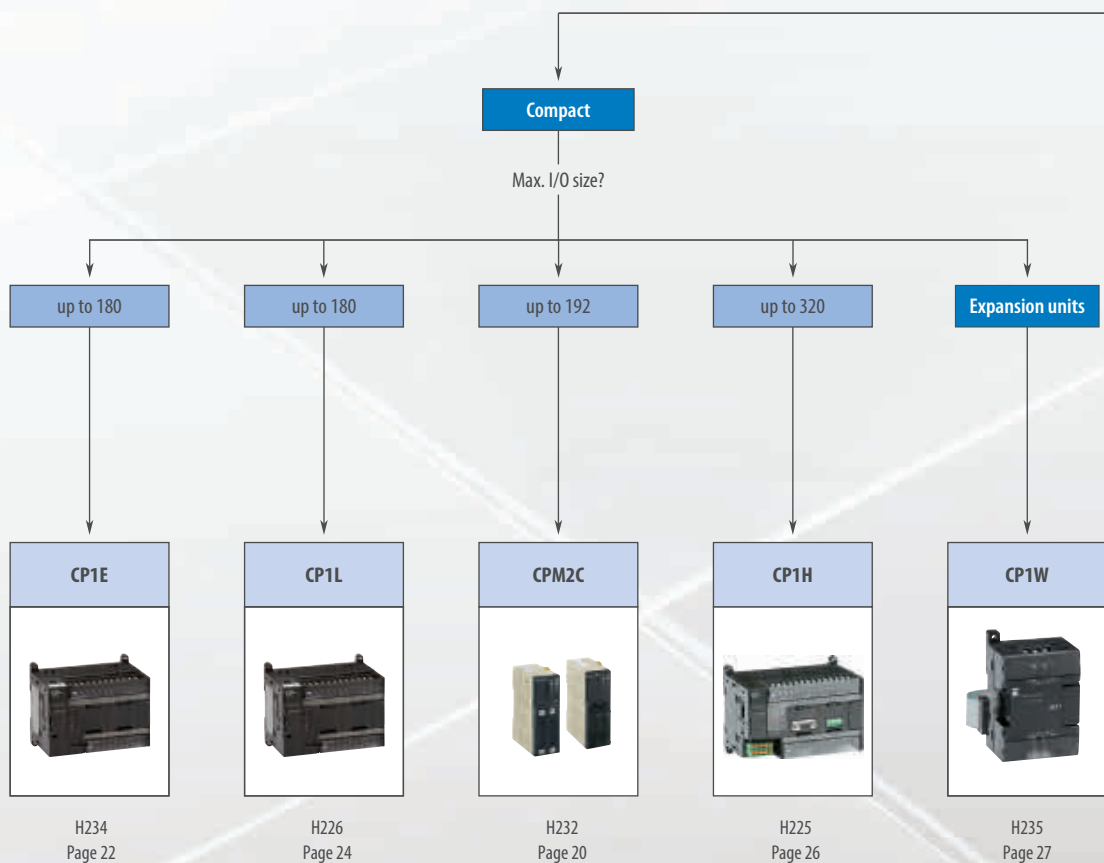

And if your systems grow, or change due to market demand, you will find that only Omron offers a full range of Compact PLCs and Modular PLCs that share the same architecture. Therefore your programs are fully upward compatible, both in memory allocation and instruction set.

- One scalable PLC family to always match exactly with your application
- Transparent communication routing through different networks
- The best size/performance ratio in the industry

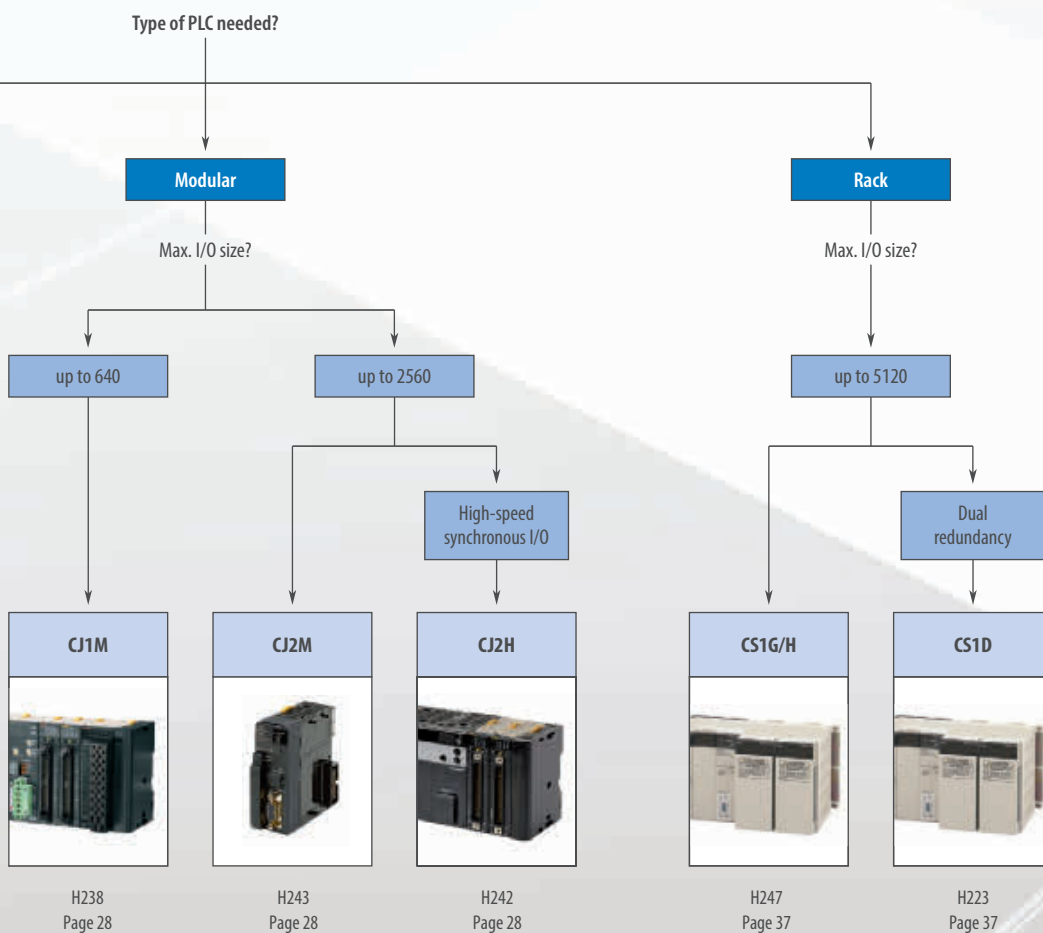





Selection table

		Compact PLC series			
					
Model		CPM2C	CP1E	CP1L	CP1H
Max digital I/O points* ¹		192	180	180	320* ²
Built-in	Digital I/O	10 to 32	10 to 60	10 to 60	20 or 40
	Interrupt inputs	2 or 4	4 or 6	2, 4, or 6	6 or 8
	Counter inputs	2 or 4	5 or 6	4	2 or 4
	Pulse outputs* ¹	2	2	2	2 or 4
CPU features* ¹		Compact size Expansion units Quick-response inputs High-speed counter Pulse output with PWM RS-232C port Real time clock	USB port Expansion I/O units Quick-response inputs High-speed counter Pulse output with PWM RS-232C port RS-485 port Real time clock 2 Analog adjusters See Analog I/O section	USB or Ethernet port Expansion I/O units Quick-response inputs High-speed counter Pulse output with PWM Up to 2 serial option boards Real time clock 1 Analog adjuster See Analog I/O section	USB port Expansion I/O units CJ-series Special I/O Units CJ-series CPU Bus Units Quick-response inputs High-speed counter Pulse output with PWM RS-232C port Option board slots Real time clock 1 Analog adjuster LED display, 2 digit See Analog I/O section
Instruction Execution time (bit instruction)		0.64 µs	1.19 µs	0.55 µs	0.10 µs
Program memory		4K words	2 or 8K steps	5 or 10K (+10K Function block) steps	20K steps
Data memory		2K words	2 or 8K words	10 or 32K words	32K words
External memory		Expansion memory unit	–	Memory cassette	Memory cassette
Analog I/O		Analog I/O unit Temperature sensor unit	Built-in for E-NA model (2 in + 1 out) Analog I/O Expansion Units Temperature Input Expansion Units	Built-in for EL/EM model (2 inputs) Analog I/O Expansion Units Temperature Input Expansion Units	Built-in for XA model (4 in + 2 out) Analog I/O Expansion Units Temperature Input Expansion Units CJ Analog I/O Units CJ Temperature Units
Special function units		–	–	–	CJ-series Special I/O Units CJ-series CPU Bus Units
Fieldbus master		–	ModBus	Ethernet ModBus	Ethernet EtherNet/IP Controller Link DeviceNet PROFIBUS-DP PROFINET ModBus CompoNet CompoBus/S CAN (freely configurable)
Fieldbus I/O		CompoBus/S DeviceNet	PROFIBUS-DP CompoBus/S DeviceNet	PROFIBUS-DP CompoBus/S DeviceNet	PROFIBUS-DP CompoBus/S DeviceNet
Page/Quick Link		20	22	24	26

*¹ Some features listed are not available for all CPU types within each series. Please review specifications for more information on CPU features and performance.

*² Represents local I/O capacity. If a fieldbus master is used more I/O is possible.

		Modular PLC series			Rack PLC series	
						
Model		CJ1M/G	CJ2M	CJ2H	CS1G/H	CS1D
Max. digital I/O points*1		1280	2560	2560	5120	5120
Built-in*1	Digital I/O	16	–			
	Interrupt inputs	4	–			
	Counter inputs	2	–			
	Pulse outputs	2	–			
CPU features*1		Compact size No backplane required Large program capacity Easy backups Built-in pulse I/O Loop control CPU type Real time clock	USB port Ethernet/IP port High-speed I/O units Option board plug-in Structures and arrays Tag data links Compact size No backplane required Large program capacity Function Block memory Easy backups Real time clock	USB port Ethernet/IP port High-speed I/O units Structures and arrays Tag data links Synchronous I/O Compact size No backplane required Extra Large program capacity Easy backups Real time clock	High I/O capacity Inner board support Large program capacity Backwards compatible Easy backups Real time clock	Redundant CPU Redundant power supply Hot swapping High I/O capacity Inner board support Large program capacity Backwards compatible Easy backups Real time clock
Instruction Execution time (bit instruction)		0.10/0.04 µs	0.04 µs	0.016 µs	0.04/0.02 µs	0.04/0.02 µs
Program memory		5 to 60K steps	5 to 60K steps	50 to 400K steps	10 to 250K steps	10 to 250K steps
Data memory		32 to 128K words	64 to 160K words	160 to 832K words	64 to 448K words	64 to 448K words
CompactFlash memory		Up to 512 MB				
Analog I/O		Analog I/O unit Temperature sensor unit Temperature control unit				
Special function units		Temperature control High-speed counters (500 kHz) SSI encoder input Position control Protocol macro RFID sensor unit Weighing unit Data collection & storage unit		Temperature control High-speed counters (500 kHz) SSI encoder input Position control Protocol macro RFID sensor unit High-speed I/O Synchronised Position Data collection & storage unit	Temperature control SSI encoder input High-speed counters (500 kHz) Position control Motion control Process control Protocol macro RFID sensor unit Data collection & storage unit	
Fieldbus master		Ethernet EtherNet/IP Controller Link DeviceNet PROFIBUS-DP PROFINET ModBus CompoNet CompoBus/S CAN (freely configurable)				
Fieldbus I/O		DeviceNet PROFIBUS-DP CAN (freely configurable)				
Page/Quick Link		28			37	

*1 Some features listed are not available for all CPU types within each series. Please review specifications for more information on CPU features and performance.



The versatile slim-line controller

An extensive range of models ensures efficient machine control in an ultra-compact package. CPU units are available with relay or transistor output, terminal block or various connector options, and an optional real-time clock function. Select the output type, number of I/O points and other specifications to meet your needs. Expansion I/O units with 8 to 32 I/O points make it possible to configure a control system with a maximum of 192 I/O points.

- Space-saving slim outline, high-density I/O
- 10-32 I/O points per CPU, transistor or relay outputs
- 20 kHz counter input, two 10 kHz pulse outputs integrated
- Two communication ports built-in, freely accessible
- Digital, analog, and fieldbus expansion units

Ordering information

Input points	Output points	Program capacity	Data memory capacity	Logic execution speed	Size in mm (H × W × D)	I/O Connectors	Output method	Built-in functions	Real time clock	Order code
6 points	4 points	4K words	2K words	0.64 μs	90 × 33 × 65	2 Terminal blocks	Relay	1 Encoder input (20 kHz)	–	CPM2C-10CDR-D
							Yes	CPM2C-10C1DR-D		
						2 Fujitsu (24 pt)	Transistor (source type)	1 Encoder input (20 kHz) 2 Pulse output (10 kHz)	–	CPM2C-10CDT1C-D
							Yes	CPM2C-10C1DT1C-D		
						2 MIL (20 pt)	Transistor (source type)	1 Encoder input (20 kHz) 2 Pulse output (10 kHz)	–	CPM2C-10CDT1M-D
							Yes	CPM2C-10C1DT1M-D		
12 points	8 points	4K words	2K words	0.64 μs	90 × 33 × 65	2 Terminal blocks	Relay	1 Encoder input (20 kHz)	–	CPM2C-20CDR-D
							Yes	CPM2C-20C1DR-D		
						2 Fujitsu (24 pt)	Transistor (source type)	1 Encoder input (20 kHz) 2 Pulse output (10 kHz)	–	CPM2C-20CDT1C-D
							Yes	CPM2C-20C1DT1C-D		
						2 MIL (20 pt)	Transistor (source type)	1 Encoder input (20 kHz) 2 Pulse output (10 kHz)	–	CPM2C-20CDT1M-D
							Yes	CPM2C-20C1DT1M-D		
16 points	16 points	4K words	2K words	0.64 μs	90 × 33 × 65	2 Fujitsu (24 pt)	Transistor (source type)	1 Encoder input (20 kHz) 2 Pulse output (10 kHz)	–	CPM2C-32CDT1C-D
						2 MIL (20 pt)	Transistor (source type)	1 Encoder input (20 kHz) 2 Pulse output (10 kHz)	–	CPM2C-32CDT1M-D
6 points	4 points	4K words	2K words	0.64 μs	90 × 40 × 65	1 Fujitsu (24 pt)	Transistor (source type)	1 Encoder input (20 kHz) 2 Pulse output (10 kHz) Programmable Slave with DeviceNet slave and CompoBus/S Master	Yes	CPM2C-S110C-DRT
6 points	4 points	4K words	2K words	0.64 μs	90 × 40 × 65	1 Fujitsu (24 pt)	Transistor (source type)	1 Encoder input (20 kHz) 2 Pulse output (10 kHz) CompoBus/S Master	Yes	CPM2C-S110C

Note: All CPU's are available only with DC supply voltage (CPM2C-PA201 can be used as power supply). CPU's with sourcing transistor outputs are also available with sinking transistor outputs. MIL = connector according to MIL-C-83503 (compatible with DIN 41651/IEC 60603-1). For I/O Cables and Terminal Blocks, see page 72



Expand the capacity of your CPM2C PLC

Expansion I/O units with 8 to 32 I/O points make it possible to configure a control system with a maximum of 192 I/O points

Ordering information

Unit	Output type	I/O Connectors	Inputs	Outputs	Order code
Expansion I/O units	-	1 Fujitsu (24 pt)	8	-	CPM2C-8EDC
		1 MIL (20 pt)			CPM2C-8EDM
	-	1 Fujitsu (24 pt)	16	-	CPM2C-16EDC
		1 MIL (20 pt)			CPM2C-16EDM
	Relay	1 Terminal block	-	8	CPM2C-8ER
	Transistor output (source type)	1 Fujitsu (24 pt)	-		CPM2C-8ET1C
		1 MIL (20 pt)			CPM2C-8ET1M
	Transistor output (source type)	1 Fujitsu (24 pt)	-	16	CPM2C-16ET1C
		1 MIL (20 pt)			CPM2C-16ET1M
	Relay	2 Terminal blocks	6	4	CPM2C-10EDR
	Relay	2 Terminal blocks	12	8	CPM2C-20EDR
	Transistor output (source type)	2 Fujitsu (24 pt)	16	8	CPM2C-24EDT1C
		2 MIL (20 pt)			CPM2C-24EDT1M
	Transistor output (source type)	2 Fujitsu (24 pt)	16	16	CPM2C-32EDT1C
	2 MIL (20 pt)	CPM2C-32EDT1M			
Analog I/O units	Analog (resolution 1/6,000)	2 Terminal blocks	2	1	CPM2C-MAD11
Temperature sensor units	Thermocouple input	1 Terminal block	2	-	CPM2C-TS001
	Platinum resistance input	1 Terminal block	2	-	CPM2C-TS101
CompoBus/S I/O link unit	-	1 Terminal block	I/O link of 8 input bits and 8 output bits		CPM2C-SRT21
RS-232C and RS422 adapter units	-	1 D-sub 9-pin	RS-232C		CPM2C-CIF01-V1
		1 Terminal block and 1 D-sub 9-pin	RS-232C and RS422		CPM2C-CIF11

Note: Expansion I/O units with sourcing transistor outputs are also available with sinking transistor outputs.
 MIL = connector according to MIL-C-83503 (compatible with DIN 41651/IEC 60603-1).
 For I/O Cables and Terminal Blocks, see page 72



Maximum functionality at minimum cost

Omron's CP1E series targets a "lean" automation solution, but still offers all functionality you need to control relatively simple applications, including outstanding positioning capability. The CP1E comes with 10, 14, 20, 30, 40 or 60 I/O built-in and can be expanded with a wide range of CP1W expansion units up to 180 I/O points. It uses a standard USB port for programming and monitoring. The CP1E-N CPU types have a RS232 serial communication port embedded and offer an extra serial communication port that can be used to connect frequency inverters or temperature controllers. As the CP1E series shares the same architecture as the CP1L, CP1H, CJ, and CS1 series, programs are compatible for memory allocations and instructions.

Ordering information

CP1E CPU	Digital input	Digital output	Max. I/O points (incl. expansions)	Communication ports	Input/output functions	Output type	Power supply	Expandability	Program capacity	Data memory capacity	Logic execution speed	Order code
E-type with 10 I/O points	6	4	10	-	5 Encoder inputs (10 kHz) 4 Interrupts/counters	Relay	84 to 264 VAC 20.4 to 26.4 VDC	-	2K steps	2K words	1.19 µs	CP1E-E10DR-A
						Transistor (sinking)						CP1E-E10DR-D
						Transistor (sourcing)						CP1E-E10DT-D
							CP1E-E10DT1-D					
E-type with 14 I/O points	8	6	14	-	6 Encoder inputs (10 kHz) 6 Interrupts/counters	Relay	84 to 264 VAC	Up to 3 expansion units*1			CP1E-E145DR-A	
E-type with 20 I/O points	12	8	20			CP1E-E205DR-A						
E-type with 30 I/O points	18	12	150			CP1E-E305DR-A						
E-type with 40 I/O points	24	16	160			CP1E-E405DR-A						
N-type with 14 I/O points	8	6	14	RS-232C port	6 Encoder inputs (2 × 100 kHz, 4 × 10kHz)	Relay	84 to 264 VAC 20.4 to 26.4 VDC	-	8K steps	8K words		CP1E-N14DR-A
					6 Encoder inputs (2 × 100 kHz, 4 × 10kHz) 2 Pulse outputs (100 kHz)	Transistor (sinking)						CP1E-N14DR-D
						Transistor (sourcing)						CP1E-N14DT-D
N-type with 20 I/O points	12	8	20		6 Encoder inputs (2 × 100 kHz, 4 × 10kHz)	Relay	84 to 264 VAC 20.4 to 26.4 VDC					CP1E-N20DR-A
					6 Encoder inputs (2 × 100 kHz, 4 × 10kHz) 2 Pulse outputs (100 kHz)	Transistor (sinking)						CP1E-N20DR-D
						Transistor (sourcing)						CP1E-N20DT-D
							CP1E-N20DT1-D					
NA-type with 20 I/O points and analog I/O	12	8	140		6 Encoder inputs (2 × 100 kHz, 4 × 10kHz) 2 analog inputs (1/6,000) 1 analog output (1/6,000)	Relay	84 to 264 VAC	Up to 3 expansion units*1				CP1E-NA20DR-A
					6 Encoder inputs (2 × 100 kHz, 4 × 10kHz) 2 Pulse outputs (100 kHz) 2 analog inputs (1/6,000) 1 analog output (1/6,000)	Transistor (sinking)						20.4 to 26.4 VDC
						Transistor (sourcing)						CP1E-NA20DT1-D

CP1E CPU	Digital input	Digital output	Max. I/O points (incl. expansions)	Communication ports	Input/output functions	Output type	Power supply	Expandability	Program capacity	Data memory capacity	Logic execution speed	Order code
N-type with 30 I/O points	18	12	150	RS-232C port	6 Encoder inputs (2 × 100 kHz, 4 × 10kHz)	Relay	84 to 264 VAC 20.4 to 26.4 VDC	Up to 3 expansion units ^{*1}	8K steps	8K words	1.19 μs	CP1E-N30DR-A
						Transistor (sinking)						CP1E-N30DR-D
					6 Encoder inputs (2 × 100 kHz, 4 × 10kHz) 2 Pulse outputs (100 kHz)	Transistor (sourcing)	CP1E-N30DT-D					
						Relay	84 to 264 VAC					CP1E-N30DT1-D
				RS-232C port RS-485 port (half-duplex)	6 Encoder inputs (2 × 100 kHz, 4 × 10kHz)	Relay	20.4 to 26.4 VDC					CP1E-N30S1DR-A
						Transistor (sinking)						CP1E-N30S1DT-D
					6 Encoder inputs (2 × 100 kHz, 4 × 10kHz) 2 Pulse outputs (100 kHz)	Transistor (sourcing)	CP1E-N30S1DT1-D					
						Relay	84 to 264 VAC					CP1E-N40DR-A
N-type with 40 I/O points	24	16	160	RS-232C port	6 Encoder inputs (2 × 100 kHz, 4 × 10kHz)	Relay	84 to 264 VAC 20.4 to 26.4 VDC	Up to 3 expansion units ^{*1}	8K steps	8K words	1.19 μs	CP1E-N40DR-D
						Transistor (sinking)						CP1E-N40DT-D
					6 Encoder inputs (2 × 100 kHz, 4 × 10kHz) 2 Pulse outputs (100 kHz)	Transistor (sourcing)	CP1E-N40DT1-D					
						Relay	84 to 264 VAC					CP1E-N40S1DR-A
				RS-232C port RS-485 port (half-duplex)	6 Encoder inputs (2 × 100 kHz, 4 × 10kHz)	Relay	20.4 to 26.4 VDC					CP1E-N40S1DT-D
						Transistor (sinking)						CP1E-N40S1DT1-D
					6 Encoder inputs (2 × 100 kHz, 4 × 10kHz) 2 Pulse outputs (100 kHz)	Transistor (sourcing)	CP1E-N60DR-A					
						Relay	84 to 264 VAC					CP1E-N60DR-D
N-type with 60 I/O points	36	24	180	RS-232C port	6 Encoder inputs (2 × 100 kHz, 4 × 10kHz)	Relay	84 to 264 VAC 20.4 to 26.4 VDC	Up to 3 expansion units ^{*1}	8K steps	8K words	1.19 μs	CP1E-N60DT-D
						Transistor (sinking)						CP1E-N60DT1-D
					6 Encoder inputs (2 × 100 kHz, 4 × 10kHz) 2 Pulse outputs (100 kHz)	Transistor (sourcing)	CP1E-N60S1DR-A					
						Relay	84 to 264 VAC					CP1E-N60S1DT-D
				RS-232C port RS-485 port (half-duplex)	6 Encoder inputs (2 × 100 kHz, 4 × 10kHz)	Relay	20.4 to 26.4 VDC					CP1E-N60S1DT1-D
						Transistor (sinking)						CP1E-N60S1DT1-D
					6 Encoder inputs (2 × 100 kHz, 4 × 10kHz) 2 Pulse outputs (100 kHz)	Transistor (sourcing)	CP1E-N60S1DT1-D					
						Relay	84 to 264 VAC					CP1E-N60S1DT1-D

*1 There is no restriction on the possible combination of CP1W expansion units. All expansion units can be combined with each other up to the maximum number of expansions.

Note: The CP1E E-type has no real-time clock and therefore no battery. The N/NA-type has one optional battery for the real-time clock.
 The CP1E-N/NA-type has 6 Interrupts/counters.
 The CP1E-NxxS1 CPU types do not support serial option boards.

Accessories

Type	Remarks	Order code
USB programming cable	A-type male to B-type male (length: 1.8 m)	CP1W-CN221
RS-232C option board	D-Sub, 9 pins, female (15 m max.)	CP1W-CIF01
RS-422A/485 option board	Terminal block (50 m max.)	CP1W-CIF11
RS-422A/485 (isolated) option board	Terminal block (500 m max.)	CP1W-CIF12
Ethernet option board	100/10Base-TX (Auto-MDIX)	CP1W-CIF41 ^{*1}
Battery for CP1E-N/NA type	To retain time of clock	CP1W-BAT01

*1 Only firmware v2.0



The compact machine controller

When it comes to controllers for compact machines, Omron's CP1L series offers the compactness of a micro-PLC with the capability of a modular PLC. It provides all the functionality you need to control your machine, including outstanding positioning capability. The CP1L comes with 14, 20, 30, 40, or 60 I/O built-in and can be expanded with a wide range of CP1W expansion units up to 180 I/O points. It uses a standard USB port for programming and monitoring and offers two optional plug-in serial communication ports, of which one can be used for a display or Ethernet option as well. As the CP1L series shares the same architecture as the CP1E, CP1H, CJ1, and CS1 series, programs are compatible for memory allocations and instructions.

Ordering information

CP1L CPU	Digital input	Digital output	Max. I/O points (incl. expansions)	Input/output functions	Output type	Power supply	PLC port	Expandability	Program capacity	Data memory capacity	Logic execution speed	Order code	
L-type with 10 I/O points	6	4	10	4 Encoder inputs (100 kHz) 2 Interrupts/counters	Relay	84 to 264 VAC 20.4 to 26.4 VDC	USB	-	5K steps	10K words	0.55 μs	CP1L-L10DR-A	
												CP1L-L10DR-D	
				4 Encoder inputs (100 kHz) 2 Pulse outputs (100 kHz) 2 Interrupts/counters	Transistor (sinking) Transistor (sourcing)							CP1L-L10DT-D	
												CP1L-L10DT1-D	
L-type with 14 I/O points	8	6	54	4 Encoder inputs (100 kHz) 4 Interrupts/counters	Relay	84 to 264 VAC 20.4 to 26.4 VDC	Up to 1 expansion units*1					CP1L-L14DR-A	
												CP1L-L14DR-D	
				4 Encoder inputs (100 kHz) 2 Pulse outputs (100 kHz) 4 Interrupts/counters	Transistor (sinking) Transistor (sourcing)							CP1L-L14DT-D	
												CP1L-L14DT1-D	
L-type with 20 I/O points	12	8	60	4 Encoder inputs (100 kHz) 6 Interrupts/counters	Relay	84 to 264 VAC 20.4 to 26.4 VDC	Ethernet		5K (+10K FB) steps			CP1L-L20DR-A	
												CP1L-L20DR-D	
				4 Encoder inputs (100 kHz) 2 Pulse outputs (100 kHz) 6 Interrupts/counters	Transistor (sinking) Transistor (sourcing)							CP1L-L20DT-D	
												CP1L-L20DT1-D	
				4 Encoder inputs (100 kHz) 6 Interrupts/counters 2 Analog inputs (1/1,000)	Relay							CP1L-EL20DR-D	
												CP1L-EL20DT-D	
				4 Encoder inputs (100 kHz) 2 Pulse outputs (100 kHz) 6 Interrupts/counters 2 Analog inputs (1/1,000)	Transistor (sinking) Transistor (sourcing)							CP1L-EL20DT1-D	
M-type with 30 I/O points	18	12	150	4 Encoder inputs (100 kHz) 6 Interrupts/counters	Relay	84 to 264 VAC 20.4 to 26.4 VDC	USB	Up to 3 expansion units*1	10K steps	32K words			CP1L-M30DR-A
													CP1L-M30DR-D
				4 Encoder inputs (100 kHz) 2 Pulse outputs (100 kHz) 6 Interrupts/counters	Transistor (sinking) Transistor (sourcing)								CP1L-M30DT-D
													CP1L-M30DT1-D
				4 Encoder inputs (100 kHz) 6 Interrupts/counters 2 Analog inputs (1/1,000)	Relay								CP1L-EM30DR-D
													CP1L-EM30DT-D
				4 Encoder inputs (100 kHz) 2 Pulse outputs (100 kHz) 6 Interrupts/counters 2 Analog inputs (1/1,000)	Transistor (sinking) Transistor (sourcing)								CP1L-EM30DT1-D

CP1L CPU	Digital input	Digital output	Max. I/O points (incl. expansions)	Input/output functions	Output type	Power supply	PLC port	Expandability	Program capacity	Data memory capacity	Logic execution speed	Order code
M-type with 40 I/O points	24	16	160	4 Encoder inputs (100 kHz) 6 Interrupts/counters	Relay	84 to 264 VAC	USB	Up to 3 expansion units ^{*1}	10K steps	32K words	0.55 μs	CP1L-M40DR-A
						20.4 to 26.4 VDC						CP1L-M40DR-D
				4 Encoder inputs (100 kHz) 2 Pulse outputs (100 kHz) 6 Interrupts/counters	Transistor (sinking)				CP1L-M40DT-D			
					Transistor (sourcing)				CP1L-M40DT1-D			
				4 Encoder inputs (100 kHz) 6 Interrupts/counters 2 Analog inputs (1/1,000)	Relay		Ethernet		10K (+10KFB) steps			CP1L-EM40DR-D
				4 Encoder inputs (100 kHz) 2 Pulse outputs (100 kHz) 6 Interrupts/counters 2 Analog inputs (1/1,000)	Transistor (sinking)							CP1L-EM40DT-D
	Transistor (sourcing)			CP1L-EM40DT1-D								
M-type with 60 I/O points	36	24	180	4 Encoder inputs (100 kHz) 6 Interrupts/counters	Relay	84 to 264 VAC	USB	Up to 3 expansion units ^{*1}	10K steps	32K words	0.55 μs	CP1L-M60DR-A
						20.4 to 26.4 VDC						CP1L-M60DR-D
				4 Encoder inputs (100 kHz) 2 Pulse outputs (100 kHz) 6 Interrupts/counters	Transistor (sinking)				CP1L-M60DT-D			
					Transistor (sourcing)				CP1L-M60DT1-D			

*1 There is no restriction on the possible combination of CP1W expansion units. All expansion units can be combined with each other up to the maximum number of expansions.

Accessories

Type	Remarks	Order code
Memory cassette	512K words (upload/download program)	CP1W-ME05M
USB programming cable	A-type male to B-type male (length: 1.8 m)	CP1W-CN221
RS-232C option board	D-Sub, 9 pins, female (15 m max.)	CP1W-CIF01
RS-422A/485 option board	Terminal block (50 m max.)	CP1W-CIF11
RS-422A/485 (isolated) option board	Terminal block (500 m max.)	CP1W-CIF12
Ethernet option board	100/10Base-TX (Auto-MDIX)	CP1W-CIF41
LCD display	4 rows x 12 characters	CP1W-DAM01
Analog I/O option board (only for CP1L-EL/EM)	2 inputs, 0 to 10 V/0 to 20 mA	CP1W-ADB21
Analog I/O option board (only for CP1L-EL/EM)	2 outputs, 0 to 10 V	CP1W-DAB21V
Analog I/O option board (only for CP1L-EL/EM)	2 inputs, 0 to 10 V/0 to 20 mA + 2 outputs 0 to 10 V	CP1W-MAB221
Battery	For replacement purpose	CJ1W-BAT01

Note: CP1L-10 I/O points CPU does not support option boards.
 CP1L-30/40/60 I/O points CPUs support two option boards.
 For Ethernet Cables and Accessories, see page 81.



The all-in-one PLC

Designed for compact machines, it combines the size of a micro PLC and the power of a modular PLC. Four built-in high-speed counters and four pulse outputs are ideal for multi-axis positioning control. The CP1H-XA comes with 4 analog inputs and 2 analog outputs built-in. This makes it suitable for simple loop control, using the PLC's advanced PID control function with auto-tuning. The CP1H can be expanded with CP1W I/Os and supports up to 2 CJ1 special I/O units. This means that it is open to popular fieldbuses and supports all communication units of the CJ1 series.

- Up to 1 MHz for inputs/outputs
- CJ1M compatible instruction set and execution speed
- 4 analog inputs and 2 analog outputs for the XA model
- USB port for easy communication, programming and configuration
- Supports PROFIBUS, DeviceNet, CAN and Ethernet

Ordering information

CP1H CPU	Digital input	Digital output	Max. I/O points (incl. expansions)	Input/output functions	Output type	Power supply	PLC port	Expandability	Program capacity	Data memory capacity	Logic execution speed	Order code
Y-type with 20 I/O points	12	8	300	4 Encoder inputs (2 × 1 MHz + 2 × 100 kHz) 4 Pulse outputs (2 × 1 MHz + 2 × 100 kHz) 6 Interrupts/counters	Transistor (sinking)	20.4 to 26.4 VDC	USB	Up to 7 expansion units ^{*1}	20K steps	32K words	0.1 μs	CP1H-Y20DT-D
X-type with 40 I/O points	24	16	320	4 Encoder inputs (100 kHz) 8 Interrupts/counters	Relay	84 to 264 VAC						CP1H-X40DR-A
				4 Encoder inputs (100 kHz) 4 Pulse outputs (100 kHz) 8 Interrupts/counters	Transistor (sinking)	20.4 to 26.4 VDC						CP1H-X40DT-D
					Transistor (sourcing)							CP1H-X40DT1-D
XA-type with 40 I/O points and analog I/O				4 Encoder inputs (100 kHz) 8 Interrupts/counters 4 Analog inputs (1/12,000) 2 Analog outputs (1/12,000)	Relay	84 to 264 VAC						CP1H-XA40DR-A
				4 Encoder inputs (100 kHz) 4 Pulse outputs (100 kHz) 8 Interrupts/counters 4 Analog inputs (1/12,000) 2 Analog outputs (1/12,000)	Transistor (sinking)	20.4 to 26.4 VDC						CP1H-XA40DT-D
					Transistor (sourcing)							CP1H-XA40DT1-D

^{*1} CP1H CPU series can be expanded with CP1W expansion units (up to 7 units) and CJ1 Special I/O units (up to 2 units).

Note: Some expansion units count for 2 unit numbers (eg. CP1W-AD041, CP1W-DA041, CP1W-TS002 and CP1W-TS102) but only 7 expansion unit numbers can be allocated in a CP1H PLC's configuration.

Accessories

Type	Remarks	Order code
Memory cassette	512K words (upload/download program)	CP1W-ME05M
USB programming cable	A-type male to B-type male (length: 1.8 m)	CP1W-CN221
RS-232C option board	D-Sub, 9 pins, female (15 m max.)	CP1W-CIF01
RS-422A/485 option board	Terminal block (50 m max.)	CP1W-CIF11
RS-422A/485 (isolated) option board	Terminal block (500 m max.)	CP1W-CIF12
Ethernet option board	100/10Base-TX (Auto-MDIX)	CP1W-CIF41
LCD display	4 rows × 12 characters	CP1W-DAM01
Expansion I/O connecting cable	80 cm cable to connect CP1W expansion units	CP1W-CN811
CJ1 expansion unit adapter	Unit to connect CJ1 Special I/O units	CP1W-EXT01
Battery	For replacement purpose	CJ1W-BAT01



Expand the capacity of your compact PLC

A wide variety of expansion units such as Digital I/O, Analog I/O and Remote I/O are available to create the application you need. These CP1W expansion units can be used for CP1E-, CP1L-, and CP1H series PLC.

Ordering information

Expansion unit	Inputs	Outputs	Max I/O points	Input/output functions	Input/output type	Size in mm (H × W × D)	No. of unit numbers allocated (CP1H only)*1	Order code
Digital I/O units	8	–	8 points	8 Inputs	–	90 × 66 × 50	1	CP1W-8ED
	–	8	8 points	8 Outputs	Relay	90 × 66 × 50	1	CP1W-8ER
					Transistor (sinking)	90 × 66 × 50	1	CP1W-8ET
					Transistor (sourcing)	90 × 66 × 50	1	CP1W-8ET1
	12	8	20 points	12 Inputs/8 outputs	Relay	90 × 86 × 50	1	CP1W-20EDR1
					Transistor (sinking)	90 × 86 × 50	1	CP1W-20EDT
					Transistor (sourcing)	90 × 86 × 50	1	CP1W-20EDT1
	24	16	40 points	24 Inputs/16 outputs	Relay	90 × 150 × 50	1	CP1W-40EDR
					Transistor (sinking)	90 × 150 × 50	1	CP1W-40EDT
					Transistor (sourcing)	90 × 150 × 50	1	CP1W-40EDT1
Analog I/O units	4	–	4 analog points	4 Analog inputs (resolution 1/6,000)	Analog	90 × 86 × 50	2	CP1W-AD041
	–	4	4 analog points	4 Analog outputs (resolution 1/6,000)	Analog	90 × 86 × 50	2	CP1W-DA041
	–	2	2 analog points	2 Analog outputs (resolution 1/6,000)	Analog	90 × 86 × 50	1	CP1W-DA021
	2	1	3 analog points	2 Analog inputs (resolution 1/6,000) 1 Analog output (resolution 1/6,000)	Analog	90 × 86 × 50	1	CP1W-MAD11
Temperature sensor units (K, J)	2	–	2 analog points	2 Thermocouple inputs (K or J)	–	90 × 86 × 50	1	CP1W-TS001
	4	–	4 analog points	4 Thermocouple inputs (K or J)	–	90 × 86 × 50	2	CP1W-TS002
Temperature sensor units (Pt100, JPt100)	2	–	2 analog points	2 Platinum resistance thermometer inputs (Pt100 or JPt100)	–	90 × 86 × 50	1	CP1W-TS101
	4	–	4 analog points	4 Platinum resistance thermometer inputs (Pt100 or JPt100)	–	90 × 86 × 50	2	CP1W-TS102
CompoBus/S I/O link unit	8 points	8 points	16 points	I/O link of 8 input bits and 8 output bits	CompoBus/S communication	90 × 66 × 50	1	CP1W-SRT21
PROFIBUS-DP I/O link unit	16 points	16 points	32 points	I/O link of 16 input bits and 16 output bits	PROFIBUS-DP communication	90 × 66 × 50	1	CPM1A-PR21
DeviceNet I/O link unit	32 points	32 points	64 points	I/O link of 32 input bits and 32 output bits	DeviceNet communication	90 × 66 × 50	1	CPM1A-DRT21

*1 Some expansion units count for 2 unit numbers (eg. CP1W-AD041, CP1W-DA041, CP1W-TS002 and CP1W-TS102) but only 7 expansion unit numbers can be allocated in a CP1H PLC's configuration.



Fast and powerful CPUs for any task

The family of CJ2 CPUs range from very small CPUs for simple sequence control to powerful and fast models that offer total machine control which can handle up to 2,560 I/O points. This enables you to modularize or 'slice' your machine into logical sections without changing PLC series.

All CPU units support IEC61131-3 Structured text, Sequential Function Charts and ladder language. Omron's extensive function block library helps to reduce your programming effort, while you can create your own function blocks to suit your specific needs. All CJ2M CPU units can be equipped with pulse I/O option modules to perform position control for up to 4 axes, using dedicated instructions.

Ordering information

Max. digital I/O points	Program capacity	Data memory capacity	Logic execution speed	Max. I/O units	Width	5 V current consumption	Built-in functions	Order code
2,560	400 K	832 K	16 ns	40	80 mm	820 mA	USB + EtherNet/IP + RS-232C	CJ2H-CPU68-EIP
2,560	250 K	512 K	16 ns	40	80 mm	820 mA	USB + EtherNet/IP + RS-232C	CJ2H-CPU67-EIP
2,560	150 K	352 K	16 ns	40	80 mm	820 mA	USB + EtherNet/IP + RS-232C	CJ2H-CPU66-EIP
2,560	100 K	160 K	16 ns	40	80 mm	820 mA	USB + EtherNet/IP + RS-232C	CJ2H-CPU65-EIP
2,560	50 K	160 K	16 ns	40	80 mm	820 mA	USB + EtherNet/IP + RS-232C	CJ2H-CPU64-EIP
2,560	60 K	160 K	40 ns	40	62 mm	700 mA	USB + EtherNet/IP, serial comm. option slot	CJ2M-CPU35
2,560	30 K	160 K	40 ns	40	62 mm	700 mA	USB + EtherNet/IP, serial comm. option slot	CJ2M-CPU34
2,560	20 K	64 K	40 ns	40	62 mm	700 mA	USB + EtherNet/IP, serial comm. option slot	CJ2M-CPU33
2,560	10 K	64 K	40 ns	40	62 mm	700 mA	USB + EtherNet/IP, serial comm. option slot	CJ2M-CPU32
2,560	5 K	64 K	40 ns	40	62 mm	700 mA	USB + EtherNet/IP, serial comm. option slot	CJ2M-CPU31
2,560	400 K	832 K	16 ns	40	49 mm	420 mA	USB + RS-232C	CJ2H-CPU68
2,560	250 K	512 K	16 ns	40	49 mm	420 mA	USB + RS-232C	CJ2H-CPU67
2,560	150 K	352 K	16 ns	40	49 mm	420 mA	USB + RS-232C	CJ2H-CPU66
2,560	100 K	160 K	16 ns	40	49 mm	420 mA	USB + RS-232C	CJ2H-CPU65
2,560	50 K	160 K	16 ns	40	49 mm	420 mA	USB + RS-232C	CJ2H-CPU64
2,560	60 K	160 K	40 ns	40	31 mm	500 mA	USB + RS-232C	CJ2M-CPU15
2,560	30 K	160 K	40 ns	40	31 mm	500 mA	USB + RS-232C	CJ2M-CPU14
2,560	20 K	64 K	40 ns	40	31 mm	500 mA	USB + RS-232C	CJ2M-CPU13
2,560	10 K	64 K	40 ns	40	31 mm	500 mA	USB + RS-232C	CJ2M-CPU12
2,560	5 K	64 K	40 ns	40	31 mm	500 mA	USB + RS-232C	CJ2M-CPU11
1,280	60 k	128 k	40 ns	40	69 mm	1,060 mA	Loop control engine (300 blocks) with Gradient Temperature Control	CJ1G-CPU45P-GTC
1,280	60 k	128 k	40 ns	40	69 mm	1,060 mA	Loop control engine (300 blocks)	CJ1G-CPU45P
1,280	30 k	64 k	40 ns	40	69 mm	1,060 mA	Loop control engine (300 blocks)	CJ1G-CPU44P
960	20 k	64 k	40 ns	30	69 mm	1,060 mA	Loop control engine (300 blocks)	CJ1G-CPU43P
960	10 k	64 k	40 ns	30	69 mm	1,060 mA	Loop control engine (50 blocks)	CJ1G-CPU42P

Accessories

Description	Remarks	Order code
High-speed data collection and storage unit, with CF card slot and Ethernet port	CPU bus unit	CJ1W-SPU01-V2
Pulse I/O option module for CJ2M CPU Units, 2 encoder inputs, 2 pulse outputs	NPN (sinking) outputs	CJ2M-MD211
Pulse I/O option module for CJ2M CPU Units, 2 encoder inputs, 2 pulse outputs	PNP (sourcing) outputs	CJ2M-MD212
CompactFlash memory card, 128 MB, for all models (not required for operation)	Industrial grade	HMC-EF183
CompactFlash memory card, 256 MB, for all models (not required for operation)	Industrial grade	HMC-EF283
CompactFlash memory card, 512 MB, for all models (not required for operation)	Industrial grade	HMC-EF583
CompactFlash PC-Card adapter	–	HMC-AP001
I/O terminal block (40-pt.) for CJ1M-CPU2_/CJ2M-MD21_	Push-in	XW2R-P40G-T
I/O terminal block (40-pt.) for CJ1M-CPU2_/CJ2M-MD21_	Clamp	XW2R-E40G-T
I/O terminal block (40-pt.) for CJ1M-CPU2_/CJ2M-MD21_	M3 Screws	XW2R-J40G-T
Connection cable between I/O terminal block and CJ1M-CPU2_/CJ2M-MD21_ (____ = length in cm)	MIL (40 pt)	XW2Z-____FF-L
Servo unit terminal block for 1 axis	–	XW2B-20J6-8A
Servo unit terminal block for 2 axes	–	XW2B-40J6-9A
SMARTSTEP cable for CJ1M-CPU2_/CJ2M-MD21_, cable length: 1 m	–	XW2Z-100J-A26
W-series servo cable for CJ1M-CPU2_/CJ2M-MD21_, cable length: 1 m	–	XW2Z-100J-A27
CX-One, integrated software for programming and configuration of all Omron control system components	–	CX-ONE-AL__C-E
Connection cable, D-Sub 9-pin PC serial port to PLC peripheral port (length: 2.0 m)	–	CS1W-CN226
Connection cable, D-Sub 9-pin PC serial port to PLC peripheral port (length: 6.0 m)	–	CS1W-CN626
USB to serial conversion cable	–	CS1W-CIF31
RS-232C Option Board* ¹	–	CP1W-CIF01
RS-422A/485 Option board* ¹	–	CP1W-CIF11
RS422A/485 (isolated) Option board* ¹	–	CP1W-CIF12
Battery Set* ²	–	CJ1W-BAT01
USB Programming cable	–	CP1W-CN221

*¹ Only used with CJ2M-CPU3_

*² Included with the CPU unit

Note: –MIL = connector according to MIL-C-83503 (compatible with DIN 41651/IEC 60603-1).
 –More accessories are available. Please refer to CJ-Series Data Sheets and Operation Manuals for details
 For I/O Cables and Terminal Blocks, see page 72
 For Ethernet Cables and Accessories, see page 81



Power and flexibility

CJ systems can operate on 24 VDC power supply, or on 100 to 240 VAC mains. For small-scale systems with mainly digital I/O a low cost, small capacity power supply can be used. For systems with many analog I/Os and control/communication units, it may be necessary to use a larger power supply unit.

Depending on the CPU type, up to 3 expansions can be connected to the CPU 'rack', giving a total capacity of 40 I/O units. The total length of the expansion cables of one system may be up to 12 m.

Ordering information

Power supply

Input range	Power consumption	Output capacity at 5 VDC	Output capacity at 24 VDC	Max. output power	Features	Width	Order code
21.6 to 26.4 VDC	35 W max.	2.0 A	0.4 A	16.6 W	–	27 mm	CJ1W-PD022
19.2 to 28.8 VDC	50 W max.	5.0 A	0.8 A	25 W	–	60 mm	CJ1W-PD025
85 to 264 VAC 47 to 63 Hz	50 VA max.	2.8 A	0.4 A	14 W	–	45 mm	CJ1W-PA202
	100 VA max.	5.0 A	0.8 A	25 W	Run output (SPST relay) Maintenance status display	80 mm	CJ1W-PA205R CJ1W-PA205C

Note: The CJ1W-PD022 has no galvanic isolation

I/O expansion

Type	Description	Width, Length	Order code
I/O control unit	Required unit on CPU 'rack' to connect I/O expansions	20 mm	CJ1W-IC101
I/O interface unit	Start unit for each I/O expansion 'rack'. Requires a power supply unit.	31 mm	CJ1W-II101
I/O expansion cable	Connects CJ1W-IC101 or -II101 to the next expansion rack's -II101	0.3 m	CS1W-CN313
		0.7 m	CS1W-CN713
		2.0 m	CS1W-CN223
		3.0 m	CS1W-CN323
		5.0 m	CS1W-CN523
		10 m	CS1W-CN133
		12 m	CS1W-CN133-B2



8 to 64 points per unit – input, output or mixed

Digital I/O units serve as the PLC's interface to achieve fast, reliable sequence control. A full range of units, from high-speed DC inputs to relay outputs, let you adapt CJ1 to your needs.

CJ1 units are available with various I/O densities and connection technologies. Up to 16 I/O points can be wired to units with detachable M3 screw terminals or screwless clamp terminals. High-density 32- and 64- point I/O units are equipped with standard 40-pin flat cable-connectors. Prefabricated cables and wiring terminals are available for easy interfacing to high-density I/O units.

Ordering information

Points	Type	Rated voltage	Rated current	Width	Remarks	Connection type*1	Order code
16	AC input	120 VAC	7 mA	31 mm	–	M3	CJ1W-IA111
8	AC input	240 VAC	10 mA	31 mm	–	M3	CJ1W-IA201
8	DC input	24 VDC	10 mA	31 mm	–	M3	CJ1W-ID201
16	DC input	24 VDC	7 mA	31 mm	–	M3 Screwless	CJ1W-ID211 CJ1W-ID211(SL)
16	DC input	24 VDC	7 mA	31 mm	Fast-response (15 µs ON, 90 µs OFF)	M3	CJ1W-ID212
16	DC input	24 VDC	7 mA	31 mm	Inputs start interrupt tasks in PLC program	M3	CJ1W-INT01
16	DC input	24 VDC	7 mA	31 mm	Latches pulses down to 50 µs pulse width	M3	CJ1W-IDP01
32	DC input	24 VDC	4.1 mA	20 mm	–	1 × Fujitsu	CJ1W-ID231
32	DC input	24 VDC	4.1 mA	20 mm	–	1 × MIL*1 (40 pt)	CJ1W-ID232
32	DC input	24 VDC	4.1 mA	20 mm	Fast-response (15 µs ON, 90 µs OFF)	1 × MIL*1 (40 pt)	CJ1W-ID233
64	DC input	24 VDC	4.1 mA	31 mm	–	2 × Fujitsu	CJ1W-ID261
64	DC input	24 VDC	4.1 mA	31 mm	–	2 × MIL*1 (40 pt)	CJ1W-ID262
8	Triac output	250 VAC	0.6 mA	31 mm	–	M3	CJ1W-OA201
8	Relay output	250 VAC	2 A	31 mm	–	M3 Screwless	CJ1W-OC201 CJ1W-OC201(SL)
16	Relay output	250 VAC	2 A	31 mm	–	M3 Screwless	CJ1W-OC211 CJ1W-OC211(SL)
8	DC output (sink)	12 to 24 VDC	2 A	31 mm	–	M3	CJ1W-OD201
8	DC output (source)	24 VDC	2 A	31 mm	With short-circuit protection, alarm	M3	CJ1W-OD202
8	DC output (source)	24 VDC	0.5 A	31 mm	With short-circuit protection, alarm	M3	CJ1W-OD204
16	DC output (sink)	12 to 24 VDC	0.5 A	31 mm	–	M3 Screwless	CJ1W-OD211 CJ1W-OD211(SL)
16	DC output (source)	24 VDC	0.5 A	31 mm	With short-circuit protection, alarm	M3 Screwless	CJ1W-OD212 CJ1W-OD212(SL)
16	DC output (sink)	24 VDC	0.5 A	31 mm	Fast-response (15 µs ON, 80 µs OFF)	M3	CJ1W-OD213
32	DC output (sink)	12 to 24 VDC	0.5 A	20 mm	–	1 × Fujitsu	CJ1W-OD231
32	DC output (source)	24 VDC	0.3 A	20 mm	With short-circuit protection, alarm	1 × MIL*1 (40 pt)	CJ1W-OD232
32	DC output (sink)	24 VDC	0.5 A	20 mm	Fast-response (15 µs ON, 80 µs OFF)	1 × MIL*1 (40 pt)	CJ1W-OD234
64	DC output (sink)	12 to 24 VDC	0.3 A	31 mm	–	2 × Fujitsu	CJ1W-OD261
64	DC output (source)	24 VDC	0.3 A	31 mm	–	2 × MIL*1 (40 pt)	CJ1W-OD262
16+16	DC in+out (source)	24 VDC	0.5 A	31 mm	–	2 × MIL*1 (20 pt)	CJ1W-MD232
32+32	DC in+out (sink)	24 VDC	0.3 A	31 mm	–	2 × MIL*1 (40 pt)	CJ1W-MD263
32+32	DC in+out (TLL)	5 VDC	35 mA	31 mm	–	2 × MIL*1 (40 pt)	CJ1W-MD563

*1 MIL = connector according to MIL-C-83503 (compatible with DIN 41651/IEC 60603-1).

Note: All digital I/O units are designated as basic I/O units.
For I/O Cables and Terminal Blocks, see page 72

Accessories

Description	Connection type	Order code
Replacement 18-point screwless terminal blocks for I/O units, pack of 5 pcs.	Screwless	CJ-WM01-18P-5
Replacement 18-point screw terminal blocks for I/O units, pack of 5 pcs.	M3	CJ-OD507-18P-5



From basic analog I/O to advanced temperature control

The CJ-series offers a wide choice of analog input units, fit for any application, from low-speed, multi-channel temperature measurement to high-speed, high-accuracy data acquisition. Analog outputs can be used for accurate control or external indication.

Advanced units with built-in scaling, filtering and alarm functions reduce the need for complex PLC programming. High-accuracy process I/O units support an extensive range of sensors, for fast and accurate data acquisition. Temperature control units relieve the PLC CPU of PID calculations and alarm monitoring. These functions are handled autonomously by the unit, offering control performance and auto-tuning functions similar to stand-alone temperature controllers.

Ordering information

Points	Type	Ranges	Resolution	Accuracy ¹	Conversion time	Width	Remarks	Connection type	Order code
4	Universal analog input	0 to 5 V 1 to 5 V 0 to 10 V 0 to 20 mA 4 to 20 mA K, J, T, L, R, S, B Pt100, Pt1000, JPt100	V / I: 1/12,000 T/C: 0.1°C RTD: 0.1°C	V: 0.3% I: 0.3% T/C: 0.3% RTD: 0.3%	250 ms/4 point	31 mm	Universal inputs, with zero/span adjustment, configurable alarms, scaling, sensor error detection	M3	CJ1W-AD04U
								Screwless	CJ1W-AD04U(SL)
4	Analog input	0 to 5 V, 0 to 10 V, -10 to 10 V, 1 to 5 V, 4 to 20 mA	1/8,000	V: 0.2% I: 0.4%	250 µs/point	31 mm	Offset/gain adjustment, peak hold, moving average, alarms	M3	CJ1W-AD041-V1
								Screwless	CJ1W-AD041-V1 (SL)
4	High-speed analog input	1 to 5 V, 0 to 10 V, -5 to 5 V, -10 to 10 V, 4 to 20 mA	1/40,000	V: 0.2% I: 0.4%	35 µs/4 points	31 mm	Direct conversion (CJ2H special instruction)	M3	CJ1W-AD042
8	Analog input	1 to 5 V, 0 to 5 V, 0 to 10 V, -10 to 10 V, 4 to 20 mA	1/8,000	V: 0.2% I: 0.4%	250 µs/point	31 mm	Offset/gain adjustment, peak hold, moving average, alarms	M3	CJ1W-AD081-V1
								Screwless	CJ1W-AD081-V1 (SL)
2	Analog output	0 to 5 V, 0 to 10 V, -10 to 10 V, 1 to 5 V, 4 to 20 mA	1/4,000	V: 0.3% I: 0.5%	1 ms/point	31 mm	Offset/gain adjustment, output hold	M3	CJ1W-DA021
								Screwless	CJ1W-DA021 (SL)
4	Analog output	1 to 5 V, 0 to 5 V, 0 to 10 V, -10 to 10 V, 4 to 20 mA	1/4,000	V: 0.3% I: 0.5%	1 ms/point	31 mm	Offset/gain adjustment, output hold	M3	CJ1W-DA041
								Screwless	CJ1W-DA041 (SL)
4	High-speed analog output	1 to 5 V, 0 to 10 V, -10 to 10 V	1/40,000	0.3%	35 µs/4 points	31 mm	Direct conversion (CJ2H special instruction)	M3	CJ1W-DA042V
8	Voltage output	0 to 5 V, 0 to 10 V, -10 to 10 V, 1 to 5 V	1/8,000	0.3%	250 µs/point	31 mm	Offset/gain adjustment, output hold	M3	CJ1W-DA08V
								Screwless	CJ1W-DA08V (SL)
8	Current output	4 to 20 mA	1/8,000	0.3%	250 µs/point	31 mm	Offset/gain adjustment, output hold	M3	CJ1W-DA08C
								Screwless	CJ1W-DA08C (SL)
4 + 2	Analog in + output	1 to 5 V, 0 to 5 V, 0 to 10 V, -10 to 10 V, 4 to 20 mA	1/8,000	in: 0.2% out: 0.3%	1 ms/point	31 mm	Offset/gain adjustment, scaling, peak hold, moving average, alarms, output hold	M3	CJ1W-MAD42
								Screwless	CJ1W-MAD42 (SL)
4	Universal analog input	DC voltage, DC current, Thermocouple, Pt100/Pt1000, potentiometer	1/256,000	0.05%	60 ms/4 points	31 mm	All inputs individually isolated, configurable alarms, maintenance functions, user-defined scaling, zero/span adjustment	M3	CJ1W-PH41U
2	Process input	4 to 20 mA 0 to 20 mA 0 to 10 V, -10 to 10 V, 0 to 5 V, -5 to 5 V, 1 to 5 V, 0 to 1.25 V, 1.25 to 1.25 V	1/64,000	0.05%	5 ms/point	31 mm	Configurable alarms, maintenance functions, user-defined scaling, zero/span adjustment, square root, totaliser	M3	CJ1W-PDC15

Points	Type	Ranges	Resolution	Accuracy ^{*1}	Conversion time	Width	Remarks	Connection type	Order code
2	Thermocouple input	B, E, J, K, L, N, R, S, T, U, WRe5-26, PLII, -100 to 100 mV	1/64,000	0.05%	5 ms/point	31 mm	Configurable alarms, maintenance functions	M3	CJ1W-PTS15
4	Thermocouple Input	B, J, K, L, R, S, T	0.1°C	0.3%	62.5 ms/point	31 mm	4 configurable alarm outputs	M3	CJ1W-PTS51
4	Resistance thermometer input	Pt100, JPt100	0.1°C	0.3%	62.5 ms/point	31 mm	4 configurable alarm outputs	M3	CJ1W-PTS52
6	Thermocouple input	K-type (-200 to 1,300°C) J-Type (-100 to 850°C)	0.1°C	0.5%	40 ms/point	31 mm	Basic I/O unit, setup by DIP switches, adjustable filtering 10/50/60 Hz	M3	CJ1W-TS561
								Screwless	CJ1W-TS561 (SL)
6	Resistance thermometer input	Pt100 (-200 to 650°C) Pt1000 (-200 to 650°C)	0.1°C	0.5%	40 ms/point	31 mm	Basic I/O unit, setup by DIP switches, adjustable filtering 10/50/60 Hz	M3	CJ1W-TS562
								Screwless	CJ1W-TS562 (SL)
4	Temperature control loops, Thermocouple	B, J, K, L, R, S, T	0.1°C	0.3%	500 ms total	31 mm	4 control outputs: PNP open collector, 100 mA max.	M3	CJ1W-TC002
2	Temperature control loops, Thermocouple	B, J, K, L, R, S, T	0.1°C	0.3%	500 ms total	31 mm	2 control outputs: PNP open collector, 100 mA max., 2 current transformer inputs for heater burnout detection.	M3	CJ1W-TC004
4	Temperature control loops, RTD	Pt100, JPt100	0.1°C	0.3%	500 ms total	31 mm	4 control outputs: PNP open collector, 100 mA max.	M3	CJ1W-TC102
2	Temperature control loops, RTD	Pt100, JPt100	0.1°C	0.3%	500 ms total	31 mm	2 control outputs: PNP open collector, 100 mA max., 2 current transformer inputs for heater burnout detection.	M3	CJ1W-TC104
1	Load Cell Interface unit	10 VDC or 2.5 VDC, max. four 350Ω load cells.	24 bit, 0.1μV/count	Linearity error: <0.02% FS	0.33 ms	31 mm	Self-contained unit designed for fast weight and force measurement. Low-pass filter adjustable 3 Hz - 1 kHz. Made by Unipulse Co.	M3	CJ1W-F130
1	Weighing unit	10 VDC, max. four 350Ω load cells	24 bit, 0.3μV/count	Linearity error: <0.01% FS	2 ms	31 mm	Self-contained unit designed for feed weighing, discharge weighing, hopper scales, packing scales, bag filling, etc. Made by Unipulse Co.	M3	CJ1W-F159

*1 Accuracy for Voltage and Current Inputs/Outputs as percentage of full scale and typical value at 25°C ambient temperature (Consult the operation manual for details)
Accuracy for Temperature Inputs/Outputs as percentage of process value and typical value at 25°C ambient temperature (Consult the operation manual for details)

Note: All Analog I/O units are designated as Special I/O units, except TS561/TS562, which are Basic I/O units (cannot be used with CP1H).

Accessories

Description	Connection type	Order code
Replacement 18-point screwless terminal blocks for I/O units, pack of 5 pcs.	Screwless	CJ-WM01-18P-5
Replacement 18-point screw terminal blocks for I/O units, pack of 5 pcs.	M3	CJ-OD507-18P-5



Add motion control to any CJ-Series PLC

From simple position measurement to multi-axis synchronised motion control, the CJ-Series offers a full range of units:

- Counter units gather position information from SSI- or incremental encoders. Actual positions are compared with internally stored target values.
- CJ2M CPU Units have dedicated positioning functions that can be used by installing up to 2 Pulse I/O option modules.
- Position Control units are used for point-to-point positioning with servo drives or stepper motors. Target data and acceleration/deceleration curves can be adjusted on-the-fly.
- Position- and Motion Control units equipped with EtherCAT or MECHATROLINK-II interface can control multiple drives through a single high-speed link. Message routing through multiple communication layers allows the attached drives to be configured from any point in the control network.

Ordering information

Channels/ Axes	Type	Signal type	Unit class	Width	Remarks	Connection type	Order code
2	SSI inputs (absolute position data)	Synchronous serial protocol	Special I/O unit	31 mm	Baud rate, encoding type, data length, etc. can be set per channel	M3 screw	CJ1W-CTS21-E
2	500 kHz Counter	24 V, line driver	Special I/O unit	31 mm	2 configurable digital inputs + outputs	1 × Fujitsu (40 pt)	CJ1W-CT021
4	100 kHz Counter	Line driver, 24 V via terminal block	Special I/O unit	31 mm	Target values trigger interrupt to CPU	1 × MIL (40 pt)	CJ1W-CTL41-E
1	DC Motor Control unit	PWM (24 V/4 A)	Special I/O unit	31 mm	4 configurable digital inputs + 50 kHz counter input	3 × Screwless	CJ1W-DCM11-E
2	Pulse I/O option module for CJ2M CPU	24 V, line driver	CPU Option Module	20 mm	100 kpps encoder inputs and pulse outputs, NPN (sinking), interrupt / fast response inputs	1 × MIL (40 pt)	CJ2M-MD211
2	Pulse I/O option module for CJ2M CPU	24 V, line driver	CPU Option Module	20 mm	100 kpps encoder inputs and pulse outputs, PNP (sourcing), interrupt / fast response inputs	1 × MIL (40 pt)	CJ2M-MD212
1	Position Control unit	24 V open collector	Special I/O unit	31 mm	500 kpps pulse outputs, inputs for origin, limit switches, stop, interrupt	1 × Fujitsu (40 pt)	CJ1W-NC113
2	Position Control unit	24 V open collector	Special I/O unit	31 mm	500 kpps pulse outputs, inputs for origin, limit switches, stop, interrupt	1 × Fujitsu (40 pt)	CJ1W-NC213
4	Position Control unit	24 V open collector	Special I/O unit	31 mm	500 kpps pulse outputs, inputs for origin, limit switches, stop, interrupt	2 × Fujitsu (40 pt)	CJ1W-NC413
2	Position Control Unit High speed type	24 V open collector	Special I/O Unit	51 mm	500 kpps pulse outputs, built-in feedback pulse counters, synchronous multi-axis control	MIL	CJ1W-NC214
4	Position Control Unit High speed type	24 V open collector	Special I/O Unit	62 mm	500 kpps pulse outputs, built-in feedback pulse counters, synchronous multi-axis control	MIL	CJ1W-NC414
2	Position Control Unit	EtherCAT	CPU bus unit	31 mm	Position, speed and torque control, access to all drive parameters	RJ45	CJ1W-NC281
4	Position Control Unit	EtherCAT	CPU bus unit	31 mm	Position, speed and torque control, access to all drive parameters	RJ45	CJ1W-NC481
4	Position Control Unit	EtherCAT	CPU bus unit	31 mm	Position, speed and torque control, access to all drive parameters, supports up to 64 general purpose EtherCAT slaves	RJ45	CJ1W-NC482
8	Position Control Unit	EtherCAT	CPU bus unit	31 mm	Position, speed and torque control, access to all drive parameters	RJ45	CJ1W-NC881
8	Position Control Unit	EtherCAT	CPU bus unit	31 mm	Position, speed and torque control, access to all drive parameters, supports up to 64 general purpose EtherCAT slaves	RJ45	CJ1W-NC882
16	Position Control Unit	EtherCAT	CPU bus unit	31 mm	Position, speed and torque control, access to all drive parameters	RJ45	CJ1W-NCF81
2	Position Control Unit	MECHATROLINK-II	CPU bus unit	31 mm	Position, speed and torque control, access to all drive parameters	ML-II	CJ1W-NC271
4	Position Control Unit	MECHATROLINK-II	CPU bus unit	31 mm	Position, speed and torque control, access to all drive parameters	ML-II	CJ1W-NC471
16	Position Control unit	MECHATROLINK-II	CPU bus unit	31 mm	Position, speed and torque control, access to all drive parameters	ML-II	CJ1W-NCF71
30	Advanced Motion Control unit	MECHATROLINK-II, Encoder I/O, digital I/O	CPU bus unit	49 mm	Trajexia Motion Controller on the CJ-series	ML-II, 9-pin D-Sub, screwless push-in	CJ1W-MCH72

Note: Line driver signal type units also available.

Accessories

Description	Connection type	Order code
Screwless terminal block for connecting 24 V or Line driver encoders to CJ1W-CTL41-E	Push-in	XW2G-40G7-E
General purpose I/O connection cable for I/O units with 40-pt. Fujitsu connector (____ = length in cm)	Fujitsu (40 pt.) to MIL (40 pt.)	XW2Z-____BF-L
General purpose I/O connection cable for I/O units with 40-pt. MIL connector (____ = length in cm)	2 × MIL (40 pt)	XW2Z-____FF-L
Servo relay unit 1-Axis position control unit	–	XW2B-20J6-1B
Servo relay unit 2-Axes position control unit	–	XW2B-40J6-2B
Cable connecting servo relay unit to Position control unit CJ1W-NC113, cable length 1 m. For Accurax G5 servo drives.	–	XW2Z-100J-A14
Cable connecting servo relay unit to Position control unit CJ1W-NC213/413, cable length 1 m. For Accurax G5 servo drives.	–	XW2Z-100J-A15
Cable connecting servo relay unit to Position control unit CJ1W-NC113, cable length 1 m. For SmartStep 2 servo drives.	–	XW2Z-100J-A14
Cable connecting servo relay unit to Position control unit CJ1W-NC213/413, cable length 1 m. For SmartStep 2 servo drives.	–	XW2Z-100J-A15
Cable connecting servo relay unit to Position control unit CJ1W-NC133, cable length 1 m. For Accurax G5 servo drives.	–	XW2Z-100J-A18
Cable connecting servo relay unit to Position control unit CJ1W-NC233/433, cable length 1 m. For Accurax G5 servo drives.	–	XW2Z-100J-A19
Cable connecting servo relay unit to Position control unit CJ1W-NC133, cable length 1 m. For SmartStep 2 servo drives.	–	XW2Z-100J-A18
Cable connecting servo relay unit to Position control unit CJ1W-NC233/433, cable length 1 m. For SmartStep 2 servo drives.	–	XW2Z-100J-A19
Cable connecting servo relay unit to Accurax G5 servo drives, cable length 1 m.	–	XW2Z-100J-B25
Cable connecting servo relay unit to SmartStep 2 servo drive, cable length 1 m.	–	XW2Z-100J-B29

Note: For General-purpose I/O Cables and Terminal Blocks, see page 72



Open to any communication

The CJ-Series offers both standardised open networks interfaces, and cost-efficient high-speed proprietary network links. Datalinks between PLCs, or to higher-level information systems can be made using serial or Ethernet links, or the easy-to-use controller link network.

Omron supports the 2 major field networks, DeviceNet and PROFIBUS-DP. For high-speed field I/O, Omron's own CompoBus/S offers an unsurpassed ease of installation. Fully user-configurable serial and CAN-based communication can be used to emulate a variety of application-specific protocols. EtherNet/IP units provide data link functions to share large amounts of data between PLCs. The new PROFINET-IO controller together with the SmartSlice modular I/O system offers Ethernet based I/O with controller- and network redundancy.

Ordering information

Type	Ports	Data transfer	Protocols	Unit class	Width	Connection type	Order code
Serial	2 × RS-232C		CompoWay/F, Host link, NT link, Modbus, User-defined	CPU bus unit	31 mm	9-pin D-Sub	CJ1W-SCU21-V1
Serial	2 × RS-232C	High-speed	CompoWay/F, Host link, NT link, Modbus, User-defined	CPU bus unit	31 mm	9-pin D-Sub	CJ1W-SCU22
Serial	2 × RS-422A/RS-485		CompoWay/F, Host link, NT link, Modbus, User-defined	CPU bus unit	31 mm	9-pin D-Sub	CJ1W-SCU31-V1
Serial	2 × RS-422A/RS-485	High-speed	CompoWay/F, Host link, NT link, Modbus, User-defined	CPU bus unit	31 mm	9-pin D-Sub	CJ1W-SCU32
Serial	1 × RS-232C + 1 × RS-422/RS-485		CompoWay/F, Host link, NT link, Modbus, User-defined	CPU bus unit	31 mm	9-pin D-Sub	CJ1W-SCU41-V1
Serial	1 × RS-232C + 1 × RS-422/RS-485	High-speed	CompoWay/F, Host link, NT link, Modbus, User-defined	CPU bus unit	31 mm	9-pin D-Sub	CJ1W-SCU42
Ethernet	1 × 100 Base-Tx		UDP, TCP/IP, FTP server, SMTP (e-mail), SNMP (time adjust), FINS routing, socket service	CPU bus unit	31 mm	RJ45	CJ1W-ETN21
EtherNet/IP	1 × 100 Base-Tx		EtherNet/IP, UDP, TCP/IP, FTP server, SNMP, SNMP	CPU Bus unit	31 mm	RJ45	CJ1W-EIP21
Controller link	2-wire twisted pair		Omron proprietary	CPU bus unit	31 mm	2-wire screw + GND	CJ1W-CLK23
DeviceNet	1 × CAN		DeviceNet	CPU bus unit	31 mm	5-p detachable	CJ1W-DRM21
PROFIBUS-DP	1 × RS-485 (Master)		DP, DPV1	CPU bus unit	31 mm	9-pin D-Sub	CJ1W-PRM21
PROFIBUS-DP	1 × RS-485 (Slave)		DP	Special I/O unit	31 mm	9-pin D-Sub	CJ1W-PRT21
PROFINET-IO	1 × 100 Base-Tx		PROFINET-IO Controller, FINS/UDP	CPU Bus unit	31 mm	RJ45	CJ1W-PNT21
CAN	1 × CAN		User-defined, supports 11-bit and 29-bit identifiers	CPU bus unit	31 mm	5-p detachable	CJ1W-CORT21
CompoNet	4-wire, data + power to slaves (Master)		CompoNet (CIP-based)	Special I/O unit	31 mm	4-p detachable IDC or screw	CJ1W-CRM21
CompoBus/S	2-wire (Master)		Omron proprietary	Special I/O unit	20 mm	2-wire screw + 2-wire power	CJ1W-SRM21

Accessories

Description	Connection type	Order code
RS-232C to RS-422/RS-485 signal converter. Mounts directly on serial port.	9-pin D-sub to screw clamp terminals	CJ1W-CIF11
Controller link PCI board with support software	PCI, wired CLK	3G8F7-CLK23-E
Controller link repeater unit (wire to wire)	Screw - Screw	CS1W-RPT01
Controller link repeater unit (wire to HPCF fiber)	Screw - HPCF connector	CS1W-RPT02
Controller link repeater unit (wire to graded-index glass fiber)	Screw - ST connector	CS1W-RPT03
PROFIBUS DP to RS-422/RS-485 Serial Gateway. User-configurable, with Omron protocols built-in.	9-pin D-sub to screw clamp terminals	PRT1-SCU11
PROFINET IO + ModBus/TCP to Modbus/RTU (RS-485) Gateway.	3 × RJ45 to screw clamp terminals	EJ1N-HFU-ETN

Note: For Ethernet Cables and Accessories, see page 81



Fast and powerful CPUs for any task

Omron's CS1-series CPUs are available in two processor speeds, each in various memory capacities. Besides the basic CPU models, versions are available for dual redundant operation, supporting I/O hot-swapping. All CPUs have one dedicated board slot with a direct CPU-bus connection, in which a serial communication board or a loop control board can be mounted. All CPU units support IEC61131-3 structured text and ladder language.

Omron's extensive function block library helps to reduce your programming effort, while you can create your own function blocks to suit your specific needs.

Ordering information

Max. Digital I/O points	Program capacity	Data memory capacity	Logic execution speed	Max. I/O units	Additional functions	Order code
5120	250K steps	448K words	20 ns	80	–	CS1H-CPU67H
				71	Supports duplex power supply and I/O hot-swapping	CS1D-CPU67S
				68	CPU for full dual-redundancy	CS1D-CPU67H
	CPU for full dual-redundancy, with loop control board	CS1D-CPU67P				
	80	–		CS1H-CPU66H		
	80	–		CS1H-CPU65H		
	40 ns	120K steps	256K words	71	Supports duplex power supply and I/O hot-swapping	CS1D-CPU65S
				68	CPU for full dual-redundancy	CS1D-CPU65H
					CPU for full dual-redundancy, with loop control board	CS1D-CPU65P
		60K steps	128K words	80	–	CS1H-CPU64H
				20K steps	–	CS1H-CPU63H
				60K steps	–	CS1G-CPU45H
1280	30K steps	64K words	40	–	CS1G-CPU44H	
			35	Supports duplex power supply and I/O hot-swapping	CS1D-CPU44S	
			960	20K steps	30	–
–	–	CS1G-CPU42H				
26	Supports duplex power supply and I/O hot-swapping	CS1D-CPU42S				
960	10K steps	64K words	–	–	–	

Accessories

Description	Remarks	Order code
High-speed data collection and storage unit, with CF card slot and Ethernet port	CPU bus unit	CS1W-SPU01-V2
High-speed data collection and storage unit, with CF card slot and 2 Ethernet ports	CPU bus unit	CS1W-SPU02-V2
Duplex unit, required for CS1D-CPU6_H systems	–	CS1D-DPL01
Serial communication option board, 2 x RS-232C	–	CS1W-SCB21-V1
Serial communication option board, 1 x RS-232C + 1 x RS422/RS-485	–	CS1W-SCB41-V1
Loop control option board	50 control blocks max.	CS1W-LCB01
Loop control option board	300 control blocks max.	CS1W-LCB05
Replacement battery set, for all CS1 CPUs	–	CS1W-BAT01
Compact Flash memory card, 128 MB, for all models (not required for operation)	Industrial grade	HMC-EF183
Compact Flash memory card, 256 MB, for all models (not required for operation)	Industrial grade	HMC-EF283
Compact Flash memory card, 512 MB, for all models (not required for operation)	Industrial grade	HMC-EF583
Compact Flash PC-Card adapter	–	HMC-AP001
CX-One, integrated software for programming and configuration of all Omron control system components	–	CX-ONE-AL__C-E
Connection cable, D-Sub 9-pin PC serial port to PLC peripheral port	length: 2.0 m	CS1W-CN226
Connection cable, D-Sub 9-pin PC serial port to PLC peripheral port	length: 6.0 m	CS1W-CN626
USB to serial conversion cable	–	CS1W-CIF31



Expand with up to 7 racks

CS1 systems can operate on 24 VDC power supply, or on 100-240 VAC mains. For small-scale systems with mainly digital I/O a low cost, small capacity power supply can be used. For systems with many analog I/Os and control/communication units, it may be necessary to use a larger power supply unit.

PLC racks are available in several sizes, from 2 to 10 slots wide. Special backplanes are required for duplex systems. Depending on the CPU type, up to 7 expansions can be connected to the CPU rack, giving a total capacity of 80 I/O units. The total length of the expansion cables of one system may be up to 12 m.

Ordering information

Power supplies

Input range	Power consumption	Output capacity 5 VDC	Output capacity 26 VDC	Max. output power	Extra functions	Order code
19.2 to 28.8 VDC	40 W max.	6.6 A	0.62 A	30 W	–	C200HW-PD024
		4.3 A	0.56 A	28 W	Power supply for dual-redundant system	CS1D-PD024
	55 VA max.	5.3 A	1.3 A	40 W	–	C200HW-PD025
		–	–	–	Power supply for dual-redundant system	CS1D-PD025
85 to 264 VAC 50/60 Hz	120 VA max.	4.6 A	0.62 A	30 W	Maintenance status display	C200HW-PA204C
85 to 132 VAC, 170 to 264 VAC, 50/60 Hz					–	C200HW-PA204
					Service output 24 VDC, 0.8 A	C200HW-PA204S
					Run status output (SPST relay)	C200HW-PA204R
					Run status output (SPST relay)	C200HW-PA209R
180 VA max.					9.0 A	1.3 A
150 VA max.	7.0 A	1.3 A	35 W	Power supply for dual-redundant system	CS1D-PA207R	

Backplanes

Type	Slots	Expansion connector	Width	Special functions	Order code
CPU backplane	2	No	200 mm	–	CS1W-BC023
CPU backplane	3	Yes	260 mm	–	CS1W-BC033
CPU backplane	5	Yes	330 mm	–	CS1W-BC053
CPU backplane	8	Yes	435 mm	–	CS1W-BC083
CPU backplane	10	Yes	505 mm	–	CS1W-BC103
Expansion backplane	3	Yes	260 mm	–	CS1W-BI033
Expansion backplane	5	Yes	330 mm	–	CS1W-BI053
Expansion backplane	8	Yes	435 mm	–	CS1W-BI083
Expansion backplane	10	Yes	505 mm	–	CS1W-BI103
CPU backplane	5	Yes	505 mm	For Duplex CPU + Power supplies	CS1D-BC052
CPU backplane	8	Yes	505 mm	For Duplex Power supplies	CS1D-BC082S
Expansion backplane	9	Yes	505 mm	For Duplex Power supplies	CS1D-BI092

Accessories

Type	Remarks	Order code
I/O Expansion cable to connect CS1 CPU backplane or Expansion backplane to next Expansion backplane.	0.3 m	CS1W-CN313
	0.7 m	CS1W-CN713
	2.0 m	CS1W-CN223
	3.0 m	CS1W-CN323
	5.0 m	CS1W-CN523
	10.0 m	CS1W-CN133
	12.0 m	CS1W-CN133-B2



Up to 96 I/O points per unit – input, output or mixed

Digital I/O units serve as the PLC's interface to achieve fast, reliable sequence control. A full range of units, from high-speed DC inputs to relay outputs, let you adapt CS1 to your needs.

CS1 units are available with various I/O densities and connection technologies. Up to 16 I/O points can be wired to units with detachable M3 screw terminals directly. High-density 32- and 64- point I/O units are equipped with standard 40-pin connectors. Prefabricated cables and wiring terminals are available for easy interfacing to high-density I/O units.

Ordering information

Points	Type	Rated voltage	Rated current	Remarks	Connection type	Order code*1
16	AC or DC input	120 VAC or VDC	10 mA	–	M3	CS1W-IA111
16	AC input	240 VAC	10 mA	–	M3	CS1W-IA211
16	DC input	24 VDC	7 mA	–	M3	CS1W-ID211
16	DC input	24 VDC	7 mA	Inputs start interrupt tasks in PLC program	M3	CS1W-INT01
16	DC input	24 VDC	7 mA	Latches pulses down to 50 µs pulse width	M3	CS1W-IDP01
32	DC input	24 VDC	6 mA	–	1 × 40 pt Fujitsu	CS1W-ID231
64	DC input	24 VDC	6 mA	–	2 × 40 pt Fujitsu	CS1W-ID261
96	DC input	24 VDC	5 mA	–	2 × 56 pt Fujitsu	CS1W-ID291
8	Triac output	250 VAC	1.2 A	–	M3	CS1W-OA201
16	Triac output	250 VAC	0.5 A	–	M3	CS1W-OA211
8	Relay output	250 VAC	2.0 A	–	M3	CS1W-OC201
16	Relay output	250 VAC	2.0 A	–	M3	CS1W-OC211
16	DC output (sink)	12 to 24 VDC	0.5 A	–	M3	CS1W-OD211
16	DC output (source)	24 VDC	0.5 A	With short-circuit protection, alarm	M3	CS1W-OD212
32	DC output (sink)	12 to 24 VDC	0.5 A	–	1 × 40 pt Fujitsu	CS1W-OD231
32	DC output (source)	24 VDC	0.5 A	With short-circuit protection, alarm	1 × 40 pt Fujitsu	CS1W-OD232
64	DC output (sink)	12 to 24 VDC	0.3 A	–	2 × 40 pt Fujitsu	CS1W-OD261
64	DC output (source)	24 VDC	0.3 A	With short-circuit protection, alarm	2 × 40 pt Fujitsu	CS1W-OD262
96	DC output (sink)	12 to 24 VDC	0.1 A	–	2 × 56 pt Fujitsu	CS1W-OD291
96	DC output (source)	24 VDC	0.1 A	–	2 × 56 pt Fujitsu	CS1W-OD292
32+32	DC output (sink)	12 to 24 VDC	0.3 A	–	2 × 40 pt Fujitsu	CS1W-MD261
32+32	DC in+out (source)	24 VDC	0.3 A	With short-circuit protection, alarm	2 × 40 pt Fujitsu	CS1W-MD262
48+48	DC output (sink)	12 to 24 VDC	0.1 A	–	2 × 56 pt Fujitsu	CS1W-MD291
48+48	DC in+out (source)	12 to 24 VDC	0.1 A	–	2 × 56 pt Fujitsu	CS1W-MD292

*1 C200H I/O units can also be mounted, except on CS1D systems.

Note: All Digital I/O units are designated as Basic I/O units.

Accessories

Description	Connection type	Order code
Connection cable between I/O terminal block and I/O unit with 40-pt Fujitsu connector (_ _ _ = length in cm)	Fujitsu (40pt)	XW2Z- _ _ _ B
I/O terminal block for input unit with 40-pt Fujitsu connector	Push-in	XW2R-P34G-C1
I/O terminal block for output unit with 40-pt Fujitsu connector	Push-in	XW2R-P34G-C3
I/O terminal block for input unit with 40-pt Fujitsu connector	Clamp	XW2R-E34G-C1
I/O terminal block for output unit with 40-pt Fujitsu connector	Clamp	XW2R-E34G-C3
I/O terminal block for input unit with 40-pt Fujitsu connector	M3 Screws	XW2R-J34G-C1
I/O terminal block for output unit with 40-pt Fujitsu connector	M3 Screws	XW2R-J34G-C3

Note: For I/O Cables and Terminal Blocks, see page 72



From basic analog I/O to process control

CS1 offers a wide choice of analog input units, fit for any application, from low-speed, multi-channel temperature measurement to high-speed, high-accuracy data acquisition. Analog outputs can be used for accurate control or external indication. Advanced units with built-in scaling, filtering and alarm functions reduce the need for complex PLC programming. High-accuracy process I/O units support an extensive range of sensors, for fast and accurate data acquisition. All process and temperature I/O units provide isolation between all individual channels.

Ordering information

Points	Type	Ranges	Resolution	Accuracy ^{*1}	Conversion time	Remarks	Connection type	Order code
4	Analog input	0 to 5 V, 0 to 10 V,	1/8,000	V: 0.2% of PV I: 0.4% of PV	250 µs/point	Offset/gain adjustment, peak hold, moving average, alarms	M3	CS1W-AD041-V1
8	Analog input	-10 to 10 V,		0.2% of PV			M3	CS1W-AD081-V1
16	Analog input	1 to 5 V, 4 to 20 mA					2 × MIL (34p.)	CS1W-AD161
4	Analog output	0 to 5 V, 0 to 10 V, -10 to 10 V, 1 to 5 V, 4 to 20 mA	1/4,000	V: 0.3% of PV I: 0.5% of PV	1 ms/point	Offset/gain adjustment	M3	CS1W-DA041
8	Voltage output	0 to 5 V, 0 to 10 V, -10 to 10 V, 1 to 5 V		0.3% of PV			M3	CS1W-DA08V
8	Current output	4 to 20 mA		0.5% of PV			M3	CS1W-DA08C
4 + 4	Analog in + output	0 to 5 V, 0 to 10 V, -10 to 10 V, 1 to 5 V (4 to 20 mA input)	1/8,000	V in: 0.2% of PV I in: 0.4% of PV out: 0.3% of PV	1 ms/point	Offset/gain adjustment, scaling, peak hold, moving average, alarms, output hold	M3	CS1W-MAD44
4	Process input	4 to 20 mA, 0 to 20 mA, 0 to 10 V, -10 to 10 V, 0 to 5 V, -5 to 5 V, 1 to 5 V, 1 to 1.25 V, -1.25 to 1.25 V	1/64,000	0.05% of PV	5 ms/point	Configurable alarms, maintenance functions, user-defined scaling, zero/span adjustment, square root, totaliser.	M3	CS1W-PDC11
8	Process input	-10 to 10 V, 0 to 5 V, 1 to 5 V, 4 to 20 mA	1/16,000	0.3% of PV	62.5 ms/point	Configurable alarms, zero/span adjustment, square root	M3	CS1W-PDC55
4	Thermocouple input	B, E, J, K, L, N, R, S, T, U, WRe5-26, PLII, -100 to 100 mV	1/64,000	0.05% of PV	5 ms/point	Configurable alarms (absolute + rate-of-change), peak hold, maintenance functions	M3	CS1W-PTS11
4	Resistance thermometer input	Pt50, Pt100 JPt100, Ni508.4	1/64,000	0.05% of PV	5 ms/point	Configurable alarms (absolute + rate-of-change), peak hold, maintenance functions	M3	CS1W-PTS12
4	Thermocouple input	B, J, K, L, R, S, T	0.1°C	0.3% of PV	62.5 ms/point	4 configurable alarm outputs	M3	CS1W-PTS51
4	Resistance thermometer input	Pt100, JPt100	0.1°C	0.3% of PV	62.5 ms/point	4 configurable alarm outputs	M3	CS1W-PTS52
8	Thermocouple input	B, J, K, L, R, S, T	0.1°C	0.3% of PV	31.2 ms/point	Configurable alarms per channel	M3	CS1W-PTS55
8	Resistance thermometer input	Pt100, JPt100	0.1°C	0.3% of PV	31.2 ms/point	Configurable alarms per channel	M3	CS1W-PTS56
4	2-Wire transmitter input	1 to 5 V, 4 to 20 mA	1/4,096	0.2% of FS	25 ms/point	Built-in power supply for transmitter, configurable alarms, square root, rate-of-change, etc.	M3	CS1W-PTW01
8	Power transducer input	-1 to 1 mA, 0 to 1 mA	1/4,096	0.2% of FS	25 ms/point	Inrush current limiter, configurable alarms, averaging, etc.	M3	CS1W-PTR01
8	Power transducer input	-100 to 100 mV, 0 to 100 mV	1/4,096	0.2% of FS	25 ms/point	Inrush current limiter, configurable alarms, averaging, etc.	M3	CS1W-PTR02
4	Pulse rate input	20000 pps, voltage, open collector, contact	up to 1/32,000	-	25 ms/point	Averaging, totaliser	M3	CS1W-PPS01

Points	Type	Ranges	Resolution	Accuracy *1	Conversion time	Remarks	Connection type	Order code
4	Isolated control output	1 to 5 V, 4 to 20 mA	1/4,000	I: 0.1% of FS V: 0.2% of FS	25 ms/point	Output readback, high/low/rate limiting, disconnection alarm, zero/span adjustment	M3	CS1W-PMV01
4	Isolated control output	-10 to 10 V, 0 to 10 V, -5 to 5 V, 0 to 5 V, -1 to 1 V, 0 to 1 V	1/4,000	0.1% of FS	10 ms/point	High/low/rate limiting, output hold, zero/span adjustment	M3	CS1W-PMV02

*1 Accuracy for Voltage and Current Inputs/Outputs as percentage of full scale and typical value at 25°C ambient temperature (Consult the operation manual for details)
Accuracy for Temperature Inputs/Outputs as percentage of process value and typical value at 25°C ambient temperature (Consult the operation manual for details)

Note: All analog I/O units are designated as special I/O units



Add motion control to any CS1 PLC

From simple position measurement to multi-axis synchronised motion control, CS1 offers a full range of units:

- Counter units gather position information from SSI- or incremental encoders. Actual positions are compared with internally stored target values.
- Position control units are used for point-to-point positioning with servo drives or stepper motors. Target data and acceleration/deceleration curves can be adjusted on-the-fly.
- Position- and motion control units equipped with MECHATROLINK-II interface can control multiple drives through a single high-speed link. Message routing through multiple communication layers allows the attached drives to be configured from any point in the control network.

Ordering information

Channels/ Axes	Type	Signal type	Unit class	Remarks	Connection type	Order code
2	SSI inputs (absolute position data)	Synchronous serial protocol	Special I/O unit	Baud rate, encoding type, data length, etc. can be set per channel 2 digital outputs, NPN/PNP selectable.	M3 screw	CS1W-CTS21
2	500 kHz Counter	24 V, 12 V, line driver	Special I/O unit	4 configurable digital inputs + 4 configurable digital outputs Target values trigger interrupt to CPU	1 × Fujitsu (40 pt)	CS1W-CT021
4					2 × Fujitsu (40 pt)	CS1W-CT041
1	Position control unit	24 V open collector	Special I/O unit	500 kpps pulse outputs, inputs for origin, limit switches, stop, interrupt	1 × Fujitsu (40 pt)	CS1W-NC113
2	Position control unit	24 V open collector	Special I/O unit	500 kpps pulse outputs, inputs for origin, limit switches, stop, interrupt	1 × Fujitsu (40 pt)	CS1W-NC213
4	Position control unit	24 V open collector	Special I/O unit	500 kpps pulse outputs, inputs for origin, limit switches, stop, interrupt	2 × Fujitsu (40 pt)	CS1W-NC413
1	Position control unit	Line driver	Special I/O unit	500 kpps pulse outputs, inputs for origin, limit switches, stop, interrupt	1 × Fujitsu (40 pt)	CS1W-NC133
2	Position control unit	Line driver	Special I/O unit	500 kpps pulse outputs, inputs for origin, limit switches, stop, interrupt	1 × Fujitsu (40 pt)	CS1W-NC233
4	Position control unit	Line driver	Special I/O unit	500 kpps pulse outputs, inputs for origin, limit switches, stop, interrupt	2 × Fujitsu (40 pt)	CS1W-NC433
2	Motion control unit	Analog	Special I/O unit	Closed loop with automatic trapezoid or S-curve acceleration/deceleration	Snap-on connectors (3M)	CS1W-MC221-V1
4	Motion control unit	Analog	Special I/O unit	Closed loop with automatic trapezoid or S-curve acceleration/deceleration	Snap-on connectors (3M)	CS1W-MC421-V1

Accessories

Description	Connection type	Order code
Servo relay unit 1-Axis position control unit	–	XW2B-20J6-1B
Servo relay unit 2-Axes position control unit	–	XW2B-40J6-2B
Cable connecting servo relay unit to Position control unit CS1W-NC113, cable length 1 m. For Accurax G5 servo drives.	–	XW2Z-100J-A6
Cable connecting servo relay unit to Position control unit CS1W-NC213/413, cable length 1 m. For Accurax G5 servo drives.	–	XW2Z-100J-A7
Cable connecting servo relay unit to Position control unit CS1W-NC113, cable length 1 m. For SmartStep 2 servo drives.	–	XW2Z-100J-A6
Cable connecting servo relay unit to Position control unit CS1W-NC213/413, cable length 1 m. For SmartStep 2 servo drives.	–	XW2Z-100J-A7
Cable connecting servo relay unit to Position control unit CS1W-NC133, cable length 1 m. For Accurax G5 servo drives.	–	XW2Z-100J-A10
Cable connecting servo relay unit to Position control unit CS1W-NC233/433, cable length 1 m. Accurax G5 servo drives.	–	XW2Z-100J-A11
Cable connecting servo relay unit to Position control unit CS1W-NC133, cable length 1 m. For SmartStep 2 servo drives.	–	XW2Z-100J-A10
Cable connecting servo relay unit to Position control unit CS1W-NC233/433, cable length 1 m. For SmartStep 2 servo drives.	–	XW2Z-100J-A11
Cable connecting servo relay unit to Accurax G5 servo drives, cable length 1 m.	–	XW2Z-100J-B25
Cable connecting servo relay unit to SmartStep 2 servo drive, cable length 1 m.	–	XW2Z-100J-B29

Note: For General-purpose I/O Cables and Terminal Blocks, see page 72



Open to any communication, standard or user-defined

CS1 provides both standardised open networks interfaces, and cost efficient, high-speed proprietary network links. Datalinks between PLCs, or to higher-level information systems can be made using Serial or Ethernet links, or the easy-to-use Controller Link network.

Omron supports the 2 major field networks, DeviceNet and PROFIBUS-DP. For high-speed field I/O, Omron's own CompoBus/S offers an unsurpassed ease of installation. Fully user-configurable serial and CAN-based communication can be used to emulate a variety of application-specific protocols. EtherNet/IP units provide data link functions to share large amounts of data between PLCs. The PROFINET-IO controller together with the SmartSlice modular I/O system offers ethernet-based I/O with controller- and network redundancy.

Ordering information

Type	Ports	Protocols	Unit class	Remarks	Connection type	Order code
Serial	2 × RS-232C	CompoWay/F, Host Link, NT link, Modbus, User-defined	CPU bus unit	–	9-pin D-Sub	CS1W-SCU21-V1
Serial	2 × RS-232C/RS-485	CompoWay/F, Host Link, NT link, Modbus, User-defined	CPU bus unit	–	9-pin D-Sub	CS1W-SCU31-V1
Serial	2 × RS-232C	CompoWay/F, Host Link, NT link, Modbus, User-defined	CPU option board	–	9-pin D-Sub	CS1W-SCB21-V1
Serial	1 × RS-232C + 1 × RS-422/RS-485	CompoWay/F, Host Link, NT link, Modbus, User-defined	CPU option board	–	9-pin D-Sub	CS1W-SCB41-V1
GP-IB	Master/Slave selectable	GP-IB instrument communication	Special I/O unit	–	GP-IB	CS1W-GPI01
Ethernet	1 × 100 Base-Tx	UDP, TCP/IP, FTP server, SMTP (e-mail), SNMP (time adjust), FINS routing, socket service	CPU bus unit	–	RJ45	CS1W-ETN21
Controller link	2-wire twisted pair	Omron proprietary	CPU bus unit	–	2-wire screw + GND	CS1W-CLK23
	Optical HPCF			–	2 × HPCF connector	CS1W-CLK13
	Optical graded-index fiber			–	4 × ST connector	CS1W-CLK53
EtherNet/IP	1 × 100 Base-Tx	EtherNet/IP, UDP, TCP/IP, FTP server, SNMP, SNMP	CPU Bus unit	31 mm	RJ45	CS1W-EIP21
DeviceNet	1 × CAN	DeviceNet	CPU bus unit	–	5-p detachable	CS1W-DRM21-V1
CompoNet	4-wire, data + power to slaves (Master)	CompoNet (CIP-based)	Special I/O unit	–	4-p detachable IDC or screw	CS1W-CRM21
CompoBus/S	2-wire (Master)	Omron proprietary	Special I/O unit	–	2-wire screw + 2-wire power	CS1W-SRM21
PROFIBUS-DP	1 × RS-485 (Master)	DP, DPV1	CPU bus unit	–	9-pin D-Sub	CS1W-PRM21
CAN	1 × CAN	CANopen, User-defined	CPU bus unit	–	5-p detachable	CS1W-CORT21
PROFINET IO	1 × 100 Base-Tx PROFINET IO controller	FINS UDP	CPU bus unit	–	RJ45	CS1W-PNT21
PROFIBUS-DP	1 × RS-485 (Slave)	DP	C200H special I/O unit	C200H units cannot be used on CS1D systems	9-pin D-Sub	C200HW-PRT21

Accessories

Description	Connection type	Order code
RS-232C to RS-422/RS-485 signal converter. Mounts directly on serial port.	9-pin D-sub to screw clamp terminals	CJ1W-CIF11
Controller link PCI board with support software	PCI, wired CLK	3G8F7-CLK23-E
Controller link PCI board with support software	PCI, HPCF connectors	3G8F7-CLK13-E
Controller link PCI board with support software	PCI, ST connectors	3G8F7-CLK53-E
Controller link repeater unit (wire to wire)	Screw - Screw	CS1W-RPT01
Controller link repeater unit (wire to HPCF fiber)	Screw - HPCF connector	CS1W-RPT02
Controller link repeater unit (wire to graded-index glass fiber)	Screw - ST connector	CS1W-RPT03
PROFIBUS DP to RS-422/RS-485 Serial Gateway. User-configurable, with Omron protocols built-in.	9-pin D-sub to screw clamp terminals	PRT1-SCU11
PROFINET IO + ModBus/TCP to Modbus/RTU (RS-485) Gateway.	3 × RJ45 to screw clamp terminals	EJ1N-HFU-ETN

Note: For Ethernet Cables and Accessories, see page 81

I/O SYSTEMS TO MEET EVERY NEED

Choose by network, style and flexibility

Compact remote I/O units combine a fixed number of I/O points in a space-saving housing. Built-in smart monitoring functions for voltage level, broken wire, actuator and cycle time will assist in planning preventive maintenance for machines and eliminating costly downtime. Compact smart slaves are available for the open EtherCAT, DeviceNet and CompoNet networks, and Omron's CompoBus/S offers a more simple and cost-efficient solution.

Modular remote I/O systems offer the possibility to install just the right number and type of I/O's where you need them. I/O modules range from basic and economical digital I/O's to high-performance modules with intelligent functions. With a choice of communication couplers for various open networks, you can adapt to existing installations and end-user demands, or make the right trade-off between performance and ease-of-use. Besides EtherCAT as main machine automation network, Omron offers connectivity to EtherNet/IP, DeviceNet, CompoNet, PROFINET IO, PROFIBUS DP, and MECHATROLINK-II.

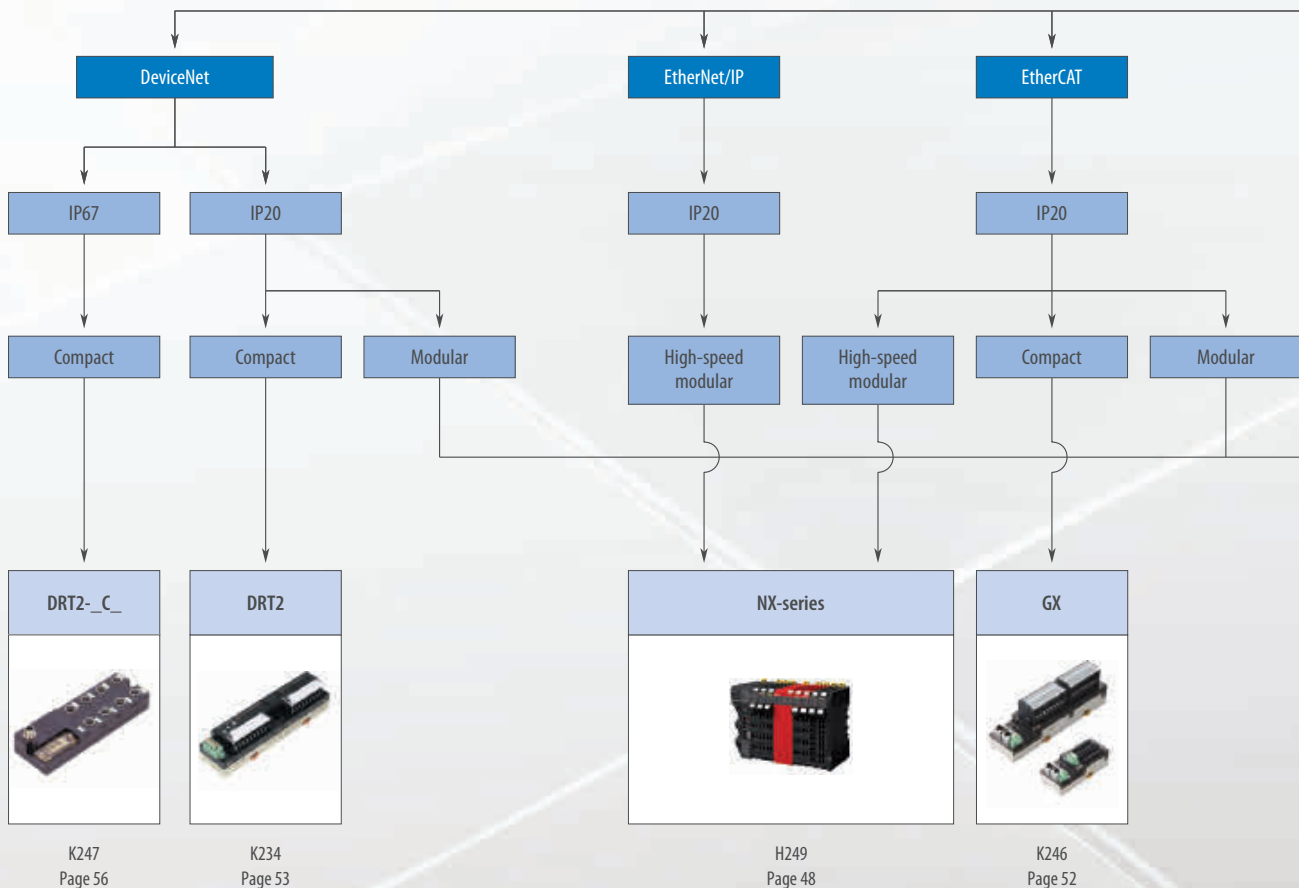

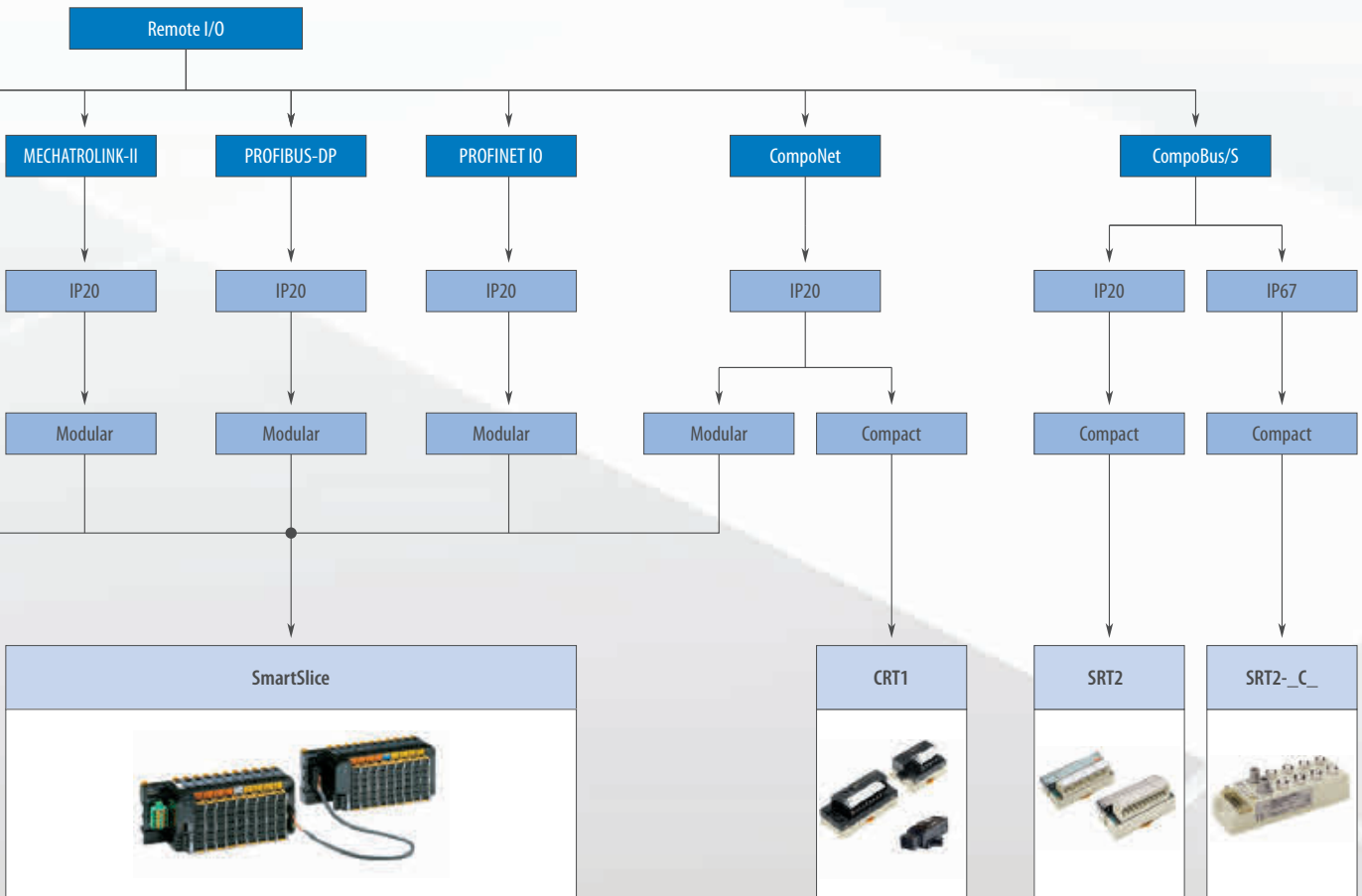









K224
Page 51

K227
Page 54

K248
Page 55

K252
Page 57

	Modular I/O		Compact I/O		
					
Model	NX-series	SmartSlice	GX	DRT2	CRT1
Network connection	EtherCAT in- and outgoing connections by RJ45 ethernet ports, EtherNet/IP with built-in Ethernet switch and 2 RJ45 ports	DeviceNet, CompoNet, PROFIBUS DP, PROFINET I/O, EtherCAT, MECHATROLINK-II	EtherCAT in- and outgoing connections by RJ45 ethernet plug	DeviceNet with open-style push-in terminal block	CompoNet, unshielded 4-wire flat cable and IDC connectors, or general-purpose 2-wire cable by screw terminals
I/O types	Digital standard and high-speed synchronous, analog standard and high-speed, temperature, encoders, pulse output, safety I/O	Digital I/O, analog I/O, temperature inputs, high-speed counter with control outputs	8 DI + 8 DO 16 DI+extension 16 DO+extension 16 relay out 4 AI (V/I) 2 AO (V/I) Incremental encoder (24 V/line driver)	8/16 DI+extension, 8/16 DO+extension, 8 DI + 8 DO 16 relay out, 4 AI (V/I, TC, Pt100), 2 AO (V/I),	8/16 DI+extension, 8/16 DO+extension, 8 DI + 8 DO 4 AI, 2 AO, 2 DI, 2 DO
I/O Connection technology	Push-in wiring on removable terminal block, MIL connectors	Push-in wiring on removable terminal block	M3 screw terminals (1- or 3-wire DI)	M3 screw terminals (1- or 3-wire DI)	M3 screw terminals
Smart features	Synchronous I/O and time-stamping on EtherCAT, safety I/O	I/O and power supply diagnostics, operation timers and counters per I/O point	Automatic or fixed address allocation	I/O and power supply diagnostics, operation timers and counters per I/O point, analog value calculations and alarms	I/O and power supply diagnostics, operation timers and counters for each I/O point, analog value calculations and alarms
Ingress Protection class	IP20 (DIN rail mounting in cabinets)	IP20 (DIN rail mounting in cabinets)	IP20 (DIN rail mounting in cabinets)	IP20 (DIN rail mounting in cabinets)	IP20 (DIN rail mounting in cabinets)
Page/Quick Link	48	51	52	53	54

	Compact I/O	Field I/O	
			
Model	SRT2	DRT2- C	SRT2- C
Network connection	CompoBus/S, (2-wire + power) by M3 screw terminals	DeviceNet with M12 micro connector	CompoBus/S, by 4-wire M12 connector, unshielded
I/O types	4/8/16 DI, 4/8/16 DO, 8/16 relay out, 4 AI (V/I) 2 AO (V/I)	8/16 DI, 8/16 DO, 8DI + 8 DO	4/8 DI, 4/8 DO
I/O Connection technology	M3 screw terminals (1- or 3-wire DI)	M12, 1 or 2 I/O signals per connector, 7/8" I/O Power connector	M12 connectors, one I/O point per connector
Smart features	I/O isolation, status indication	I/O and power supply diagnostics, operation timers and counters per I/O point	I/O isolation, status indication
Ingress Protection class	IP20 (DIN rail mounting in cabinets)	IP67, flat mounting by two M5 screws	IP67, flat mounting by three M5 screws
Page/Quick Link	55	56	57



Performance and practicality for machine control

Modern machine control requires system-wide synchronisation of motion axes with microsecond accuracy. The NX I/O system offers this timing accuracy and repeatability for a wide variety of in- and outputs. Its ultra-fast internal bus system is synchronised with the Distributed Clock of the EtherCAT network, resulting in system-wide deterministic I/O operation.

Alternatively, NX-series I/O can be used in non-synchronous “Free Run” mode on EtherNet/IP, the open CIP-based network supported by our CJ2-series PLC’s.

NX-series I/O covers a full range of units, including standard and high-speed digital I/O’s, various performance levels in analog I/O, encoder inputs and pulse outputs. The series continues to expand with time-stamped I/O, safety I/O and application-specific modules.

- Ideal match with Sysmac machine automation controllers and CJ2-series PLC’s
- Synchronous I/O updates, system-wide, with less than 1 µs jitter using EtherCAT
- High density: up to 16 digital or 8 analog signals in 12 mm width
- Removable wiring terminals for easy system assembly and testing

Ordering information

Communication and Control Units

Module Type	Protocol	Connection	Specification	Width	Order Code
Communication Coupler	EtherCAT Slave	2 RJ45 ports (in + out)	Up to 63 I/O units. Max. 1,024 bytes in + 1,024 bytes out Supports Distributed Clock I/O Power Supply up to 10 A	46 mm	NX-ECC202
	EtherNet/IP Slave	2 RJ45 ports with built-in switch	Up to 63 I/O units. Max. 512 bytes in + 512 bytes out Supports local safety communication Free run I/O refresh mode only I/O Power Supply up to 10 A	46 mm	NX-EIC202
Safety Controller	FSOE Protocol	128 Safety Connections	For up to 1,024 Safety I/O points	30 mm	NX-SL3500
		32 Safety Connections	For up to 256 Safety I/O points	30 mm	NX-SL3300

Digital I/O Units

Module type	Channels, Signal type	Performance ^{*1} , I/O Refresh Mode	Connection type ^{*2}	Width	Order Code	NPN-type ^{*3}
AC Digital Input	4 inputs, 200 to 240 VAC, 50/60 Hz	Free Run	Screwless push-in (NX-TBA082)	12 mm	NX-IA3117	-
Safety Digital Input	4 inputs + 2 test outputs	Free Run	Screwless push-in (NX-TBA082)	12 mm	NX-SIH400	-
	8 inputs + 2 test outputs	Free Run	Screwless push-in (NX-TBA162)	12 mm	NX-SID800	-
DC Digital Input	4 inputs, 3-wire connection	High-speed Synchronous Time Stamp	Screwless push-in (NX-TBA122)	12 mm	NX-ID3444	NX-ID3344
		High-speed Synchronous/Free Run	Screwless push-in (NX-TBA122)	12 mm	NX-ID3443	NX-ID3343
		Synchronous/Free Run	Screwless push-in (NX-TBA122)	12 mm	NX-ID3417	NX-ID3317
	8 inputs, 2-wire connection	Synchronous/Free Run	Screwless push-in (NX-TBA162)	12 mm	NX-ID4442	NX-ID4342
		Synchronous/Free Run	1 × 20-pin MIL connector	30 mm	NX-ID5142-5	same
	32 inputs, 1-wire connection	Synchronous/Free Run	1 × 40-pin MIL connector	30 mm	NX-ID6142-5	same
DC Digital I/O	16 inputs + 16 outputs 0.5 A, 1-wire connection + common	Synchronous/Free Run	2 × 20-pin MIL connector	30 mm	NX-MD6256-5	NX-MD6121-5
DC Digital Output	2 outputs 0.5 A, 3-wire connection	High-speed Synchronous Time Stamp	Screwless push-in (NX-TBA082)	12 mm	NX-OD2258	NX-OD2154
		High-speed Synchronous/Free Run	Screwless push-in (NX-TBA122)	12 mm	NX-OD3257	NX-OD3153
	4 outputs 0.5 A, 3-wire connection	Synchronous/Free Run	Screwless push-in (NX-TBA122)	12 mm	NX-OD3256	NX-OD3121
	8 outputs 0.5 A, 2-wire connection	Synchronous/Free Run	Screwless push-in (NX-TBA162)	12 mm	NX-OD4256	NX-OD4121
		Synchronous/Free Run	1 × 20-pin MIL connector	30 mm	NX-OD5256-5	NX-OD5121-5
	32 outputs 0.5 A, 1-wire connection	Synchronous/Free Run	1 × 40-pin MIL connector	30 mm	NX-OD6256-5	NX-OD6121-5
Safety Digital Output	2 outputs, 2.0 A	Free Run	Screwless push-in (NX-TBA082)	12 mm	NX-SOH200	-
	4 outputs, 0.5 A	Free Run	Screwless push-in (NX-TBA082)	12 mm	NX-SOD400	-
Relay Digital Output	2 outputs, N.O., 2.0 A	Free Run	Screwless push-in (NX-TBA082)	12 mm	NX-OC2633	-
	2 outputs, N.O.+ N.C., 2.0 A	Free Run	Screwless push-in (NX-TBA082)	12 mm	NX-OC2733	-

Position Control Units

Module type	Channels, Signal type	Performance, I/O Refresh Mode	Connection type ^{*2}	Width	Order Code	NPN-type ^{*3}
Encoder Input	1 SSI encoder, 2 MHz	Synchronous/Free Run	Screwless push-in (NX-TBA122)	12 mm	NX-ECS112	-
	2 SSI encoders, 2 MHz	Synchronous/Free Run	Screwless push-in (NX-TBA122)	12 mm	NX-ECS212	-
	1 incremental encoder line driver 4 MHz + 3 Digital Inputs (1 μs)	Synchronous/Free Run	Screwless push-in (NX-TBA122 + NX-TBB122)	24 mm	NX-EC0142	NX-EC0132
	1 incremental encoder open collector 500 kHz + 3 Digital Inputs (1 μs)	Synchronous/Free Run	Screwless push-in (NX-TBA162)	12 mm	NX-EC0122	NX-EC0112
	2 incremental encoders open collector 500 kHz	Synchronous/Free Run	Screwless push-in (NX-TBA122)	12 mm	NX-EC0222	NX-EC0212
Pulse Output	1 Pulse Up/Down or Pulse/Direction open collector 500 kHz + 2 Digital Inputs + 1 Digital Output (1 μs)	Synchronous	Screwless push-in (NX-TBA162)	12 mm	NX-PG0122	NX-PG0112

*1 Digital I/O performance

Digital I/O performance		Standard		High Speed	
		ON delay	OFF delay	ON delay	OFF delay
Input	PNP	0.02 ms	0.4 ms	100 ns	100 ns
	NPN				
	AC	10 ms	40 ms		
Output	PNP	0.5 ms	1.0 ms	300 ns	300 ns
	NPN	0.1 ms	0.8 ms		
	Relay	15 ms	15 ms	N.A.	N.A.

*2 Units with screwless push-in connections are supplied with the appropriate terminal connector. Units with MIL connectors are supplied without matching plugs; for connecting cables see page 72

*3 Order codes are for PNP-type signals (positive switching, 0V common). Most models are also available as NPN-type (negative switching, 24V common). Inputs of MIL-connector versions can be used as NPN or PNP.

Analog I/O Units

Module type	Signal type	Performance, I/O Refresh Mode	Channels	Connection type *1	Width	Order Code
Temperature Sensor Input	Thermocouple type B,E,J,K,L,N,R,S,T,U,WRe5-26,PLII	0.1°C resolution, 200 ms/unit Free Run	2	Screwless push-in terminal block(s) with cold junction sensor, calibrated individually at the factory	12 mm	NX-TS2101
			4		24 mm	NX-TS3101
		0.01°C resolution, 10 ms/unit Free Run	2		12 mm	NX-TS2102
			4		24 mm	NX-TS3102
		0.001°C resolution, 60 ms/unit Free Run	2		12 mm	NX-TS2104
			4		24 mm	NX-TS3104
	RTD type Pt100 (3-wire), Pt1000, Ni508.4	0.1°C resolution, 200 ms/unit Free Run	2	Screwless push-in (NX-TBA162)	12 mm	NX-TS2201
			4	Screwless push-in (NX-TBA162 + NX-TBB162)	24 mm	NX-TS3201
		0.01°C resolution, 10 ms/unit Free Run	2	Screwless push-in (NX-TBA162)	12 mm	NX-TS2202
			4	Screwless push-in (NX-TBA162 + NX-TBB162)	24 mm	NX-TS3202
		0.001°C resolution, 60 ms/unit Free Run	2	Screwless push-in (NX-TBA162)	12 mm	NX-TS2204
			4	Screwless push-in (NX-TBA162 + NX-TBB162)	24 mm	NX-TS3204
Analog Input	4 to 20 mA single ended	1/8000 resolution, 250 µs/channel Free Run	2	Screwless push-in (NX-TBA082)	12 mm	NX-AD2203
			4	Screwless push-in (NX-TBA122)	12 mm	NX-AD3203
			8	Screwless push-in (NX-TBA162)	12 mm	NX-AD4203
	4 to 20 mA differential	1/8000 resolution, 250 µs/channel Free Run	2	Screwless push-in (NX-TBA082)	12 mm	NX-AD2204
			4	Screwless push-in (NX-TBA122)	12 mm	NX-AD3204
			8	Screwless push-in (NX-TBA162)	12 mm	NX-AD4204
	1/30000 resolution, 10 µs/channel Synchronous/Free Run	1/30000 resolution, 10 µs/channel Synchronous/Free Run	2	Screwless push-in (NX-TBA082)	12 mm	NX-AD2208
			4	Screwless push-in (NX-TBA122)	12 mm	NX-AD3208
			8	Screwless push-in (NX-TBA162)	12 mm	NX-AD4208
	-10 to 10 V single ended	1/8000 resolution, 250 µs/channel Free Run	2	Screwless push-in (NX-TBA082)	12 mm	NX-AD2603
			4	Screwless push-in (NX-TBA122)	12 mm	NX-AD3603
			8	Screwless push-in (NX-TBA162)	12 mm	NX-AD4603
	-10 to 10 V differential	1/8000 resolution, 250 µs/channel Free Run	2	Screwless push-in (NX-TBA082)	12 mm	NX-AD2604
			4	Screwless push-in (NX-TBA122)	12 mm	NX-AD3604
			8	Screwless push-in (NX-TBA162)	12 mm	NX-AD4604
	1/30000 resolution, 10 µs/channel Synchronous/Free Run	1/30000 resolution, 10 µs/channel Synchronous/Free Run	2	Screwless push-in (NX-TBA082)	12 mm	NX-AD2608
			4	Screwless push-in (NX-TBA122)	12 mm	NX-AD3608
			8	Screwless push-in (NX-TBA162)	12 mm	NX-AD4608
Analog Output	4 to 20 mA	1/8000 resolution, 250 µs/channel Free Run	2	Screwless push-in (NX-TBA082)	12 mm	NX-DA2203
			4	Screwless push-in (NX-TBA122)	12 mm	NX-DA3203
		1/30000 resolution, 10 µs/channel Synchronous/Free Run	2	Screwless push-in (NX-TBA082)	12 mm	NX-DA2205
			4	Screwless push-in (NX-TBA122)	12 mm	NX-DA3205
	-10 to 10 V	1/8000 resolution, 250 µs/channel Free Run	2	Screwless push-in (NX-TBA082)	12 mm	NX-DA2603
			4	Screwless push-in (NX-TBA122)	12 mm	NX-DA3603
		1/30000 resolution, 10 µs/channel Synchronous/Free Run	2	Screwless push-in (NX-TBA082)	12 mm	NX-DA2605
			4	Screwless push-in (NX-TBA122)	12 mm	NX-DA3605

Other Units

Module type	Description	Connection type *1	Width	Order Code
Power Unit	NX bus power supply unit, 24 V DC input, non-isolated	Screwless push-in (NX-TBC082)	12 mm	NX-PD1000
	I/O power feed unit, for separation of power groups, up to 10 A	Screwless push-in (NX-TBA082)	12 mm	NX-PF0730
	I/O power connection unit, 16 × IOV	Screwless push-in (NX-TBA162)	12 mm	NX-PC0020
	I/O power connection unit, 16 × IOG	Screwless push-in (NX-TBA162)	12 mm	NX-PC0010
	I/O power connection, 8 × IOV + 8 × IOG	Screwless push-in (NX-TBA162)	12 mm	NX-PC0030
System Units and Accessories	Grounding terminal, 16 points	Screwless push-in (NX-TBC162)	12 mm	NX-TBX01
	End cover (included with Communication Coupler)	-	12 mm	NX-END01
	Replacement front connector with 8 wiring terminals (marked A+B)	Screwless push-in	12 mm	NX-TBA082
	Replacement front connector with 12 wiring terminals (marked A+B)	Screwless push-in	12 mm	NX-TBA122
	Replacement front connector with 16 wiring terminals (marked A+B)	Screwless push-in	12 mm	NX-TBA162
	Replacement front connector with 12 wiring terminals (marked C+D)	Screwless push-in	12 mm	NX-TBB122
	Replacement front connector with 16 wiring terminals (marked C+D)	Screwless push-in	12 mm	NX-TBB162
	Replacement front connector with 8 wiring terminals (marked A+B+FG)	Screwless push-in	12 mm	NX-TBC082
	Replacement front connector with 16 wiring terminals (marked A+B+FG)	Screwless push-in	12 mm	NX-TBC162
	DIN rail insulation spacers, set of 3 pcs	-	-	NX-AUX01
	30 Unit pins + 30 Terminal keying pins, to prevent mismatch of unit and terminal block (one set is enough for 10 units)	-	-	NX-AUX02

*1 Units with screwless push-in connections are supplied with the appropriate terminal connector.

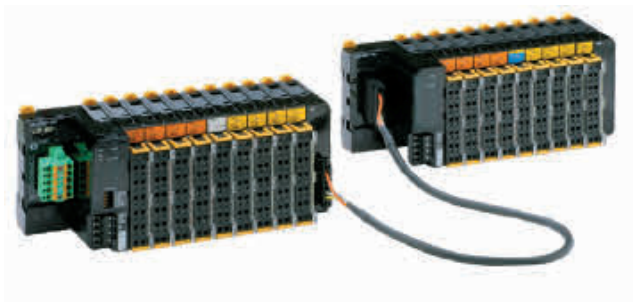

The smartest modular I/O system

Omron's SmartSlice I/O system is compact, intelligent and easy. When used with Omron's CS1/CJ1 DeviceNet master units it is plug-and-work, no configuration tool is required. By using built-in functions such as pre-scaling, totalising, differentiation and alarming in analog I/O units, PLC programming can be minimised. Preventive maintenance data can be accessed using CX-Integrator software, standard PLC function blocks or NS-series Smart Active Parts.

- Most compact in the market (84 mm high)
- Easy set-up, backup and restore functions
- Diagnostics and preventive maintenance data at I/O level
- Detachable terminal blocks allow hot-swapping without re-wiring
- 3-wire connection with 'push-in' technology, no screwdriver required for installation

Ordering information

Model	Function	Specifications	Size in mm (H×W×D)	Order code
Interface units	DeviceNet interface unit	For up to 64 I/O units	84×58×70	GRT1-DRT
	CompoNet interface unit	For up to 64 I/O units (limited to 32 byte in + 32 byte out)	84×58×70	GRT1-CRT
	PROFIBUS-DP interface unit	For up to 64 I/O units	84×58×70	GRT1-PRT
	PROFINET-IO interface unit	For up to 64 I/O units	84×58×70	GRT1-PNT
	MECHATROLINK-II interface unit	For up to 64 I/O units (slave to Trajexia motion controller)	84×58×70	GRT1-ML2
	EtherCAT interface unit	For up to 64 I/O units (slave to Trajexia and Sysmac controller)	84×58×70	GRT1-ECT
	End plate	One unit required per bus interface	84×20×58	GRT1-END
	End plate with memory function	Supports toolless replacement of PROFINET-IO interface unit	84×20×58	GRT1-END-M
I/O units	4 NPN inputs	24 VDC, 6 mA, 3-wire connection	84×15×74	GRT1-ID4
	4 PNP inputs	24 VDC, 6 mA, 3-wire connection	84×15×74	GRT1-ID4-1
	8 NPN inputs	24 VDC, 4 mA, 1-wire connection + 4×G	84×15×74	GRT1-ID8
	8 PNP inputs	24 VDC, 4 mA, 1-wire connection + 4×V	84×15×74	GRT1-ID8-1
	4 AC inputs	110 VAC, 2-wire connection	84×15×74	GRT1-IA4-1
	4 AC inputs	230 VAC, 2-wire connection	84×15×74	GRT1-IA4-2
	4 NPN outputs	24 VDC, 500 mA, 2-wire connection	84×15×74	GRT1-OD4
	4 PNP outputs	24 VDC, 500 mA, 2-wire connection	84×15×74	GRT1-OD4-1
	4 PNP outputs with short-circuit protection	24 VDC, 500 mA, 3-wire connection	84×15×74	GRT1-OD4G-1
	4 PNP outputs with short-circuit protection	24 VDC, 2 A, 2-wire connection	84×15×74	GRT1-OD4G-3
	8 NPN outputs	24 VDC, 500 mA, 1-wire connection + 4×V	84×15×74	GRT1-OD8
	8 PNP outputs	24 VDC, 500 mA, 1-wire connection + 4×G	84×15×74	GRT1-OD8-1
	8 PNP outputs with short-circuit protection	24 VDC, 500 mA, 1-wire connection + 4×G	84×15×74	GRT1-OD8G-1
	2 relay outputs	240 VAC, 2A, normally-open contacts	84×15×74	GRT1-ROS2
	60 kHz Counter unit, NPN	A+B encoder inputs + 1 Z/control input + 1 output (NPN-type)	84×15×74	GRT1-CT1
	60 kHz Counter unit, PNP	A+B encoder inputs + 1 Z/control input + 1 output (PNP-type)	84×15×74	GRT1-CT1-1
	100 kHz Counter / Positioner unit	A+B+Z encoder inputs (line driver or 24 V selectable) + 1 control input + 2 outputs (PNP-type)	84×15×74	GRT1-CP1-L
	2 analog inputs, current/voltage	±10 V, 0-10 V, 0-5 V, 1-5 V, 0-20 mA, 4-20 mA	84×15×74	GRT1-AD2
	2 analog outputs, voltage	±10 V, 0-10 V, 0-5 V, 1-5 V	84×15×74	GRT1-DA2V
	2 analog outputs, current	0-20 mA, 4-20 mA	84×15×74	GRT1-DA2C
	2 Pt100 inputs	Pt100, 2-wire or 3-wire connection	84×15×74	GRT1-TS2P
	2 Pt1000 inputs	Pt1000, 2-wire or 3-wire connection	84×15×74	GRT1-TS2PK
	2 Thermocouple inputs	Types B, E, J, K, N, R, S, T, U, W, PL2, with cold junction compensation	84×15×74	GRT1-TS2T

Model	Description	Size in mm (H×W×D)	Order code
Other units	I/O power feed unit, separates power supply between groups of I/O units	84×15×74	GRT1-PD2
	I/O power feed unit with electronic overload protection, separates power supply between groups of I/O units	84×15×74	GRT1-PD2G
	I/O power feed and distribution unit, separates power supply between groups of I/O units, 8×V + 4×G	84×15×74	GRT1-PD8
	I/O power feed and distribution unit, separates power supply between groups of I/O units, 4×V + 8×G	84×15×74	GRT1-PD8-1
	I/O power connection unit, 8×V + 4×G	84×15×74	GRT1-PC8
	I/O power connection unit, 4×V + 8×G	84×15×74	GRT1-PC8-1
	Turnback unit, right-hand side	84×20×58	GRT1-TBR
	Turnback unit, left-hand side	84×58×70	GRT1-TBL
	Turnback cable, one meter	1 m	GCN2-100

Accessories

Description	Order code
Replacement front connectors, pack of 5 pcs.	GRT1-BT1-5
PROFIBUS-DP connector, 9-pin D-sub	PROFIBUS Connector 839550
PROFIBUS-DP connector, 9-pin D-sub, with bus termination	PROFIBUS Term. Conn. 846086
PROFINET RJ45 connector	IE-PS-RJ45-FH-BK
CompoNet connectors	See page 54



When speed counts: EtherCAT I/O

EtherCAT is an extremely fast industrial automation network, which uses standard ethernet cabling. It makes very efficient use of the standard Ethernet transmission frame, with each node accessing the entire frame on the fly. This reduces the delay in each slave to microsecond level.

Its deterministic nature makes EtherCAT extremely suitable for motion control. Omron provides PLC-based as well as stand-alone motion control solutions based on EtherCAT.

The GX-series I/O units provide the basic in- and outputs for such systems, including high-speed encoder inputs which can feed position information into the controller.

Ordering information

Unit Type	Specification	Size in mm (H×W×D)	Remarks	Order code
16-point NPN input unit	24 VDC, 6 mA per point	52×135×57	Expandable with one XWT unit	GX-ID1611
16-point NPN input unit	24 VDC, 6 mA per point	52×200×69	3-tier connection for direct sensor wiring	GX-ID1612
16-point PNP input unit	24 VDC, 6 mA per point	52×135×57	Expandable with one XWT unit	GX-ID1621
16-point PNP input unit	24 VDC, 6 mA per point	52×200×69	3-tier connection for direct sensor wiring	GX-ID1622
16-point relay output unit	2 A per point, max. 8 A per common	52×160×58	with easy-to-replace relays, expandable with one XWT unit	GX-OC1601
16-point NPN output unit	24 VDC, 0.5 A per point	52×135×57	Expandable with one XWT unit	GX-OD1611
16-point NPN output unit	24 VDC, 0.5 A per point	52×200×69	3-tier connection for direct sensor wiring	GX-OD1612
16-point PNP output unit	24 VDC, 0.5 A per point	52×135×57	Expandable with one XWT unit	GX-OD1621
16-point PNP output unit	24 VDC, 0.5 A per point	52×200×69	3-tier connection for direct sensor wiring	GX-OD1622
8-point input + 8-point output unit (NPN)	24 VDC, input 6 mA, output 0.5 A per point	52×135×57	–	GX-MD1611
8-point input + 8-point output unit (NPN)	24 VDC, input 6 mA, output 0.5 A per point	52×200×69	3-tier connection for direct sensor wiring	GX-MD1612
8-point input + 8-point output unit (PNP)	24 VDC, input 6 mA, output 0.5 A per point	52×135×57	–	GX-MD1621
8-point input + 8-point output unit (PNP)	24 VDC, input 6 mA, output 0.5 A per point	52×200×69	3-tier connection for direct sensor wiring	GX-MD1622
4-Channel analog input unit	1 to 5 V, 1 to 5 V, 0 to 10 V, -10 to 10 V, 4 to 20 mA,	52×135×57	Resolution 1/6000, conversion time 4 ms (4 inputs)	GX-AD0471
2-Channel analog output unit	1 to 5 V, 1 to 5 V, 0 to 10 V, -10 to 10 V, 4 to 20 mA,	52×135×57	Resolution 1/6000, conversion time 2 ms (2 outputs)	GX-DA0271
1-Channel incremental encoder input (24V)	Open collector, up to 125 kHz	52×215×69	A, B, Z, 2 × Latch, Reset inputs	GX-EC0211
1-Channel incremental encoder input (line driver)	RS422 signal level, up to 1 MHz	52×215×69	A, B, Z, 2 × Latch, Reset inputs	GX-EC0241

Expansion units

Unit Type	Specification	Size in mm (H×W×D)	Remarks	Order code
8-point PNP input expansion unit	24 VDC, 6 mA per point	50×66×50	Expansion unit for GX, DRT2 and CRT1 series	XWT-ID08-1
16-point PNP input expansion unit	24 VDC, 6 mA per point	50×94×50	Expansion unit for GX, DRT2 and CRT1 series	XWT-ID16-1
8-point PNP output expansion unit	24 VDC, 0.5 A per point	50×66×50	Expansion unit for GX, DRT2 and CRT1 series	XWT-OD08-1
16-point PNP output expansion unit	24 VDC, 0.5 A per point	50×94×50	Expansion unit for GX, DRT2 and CRT1 series	XWT-OD16-1
3 port branching uni	24 VDC, 3 x RJ45	90×25×78	EtherCAT junction box for T-branching	GX-JC03
6 port branching unit	24VDC, 6 x RJ45	90×48×78	EtherCAT junction box for star branching	GX-JC06

Note: To order models with NPN (sinking) outputs and corresponding inputs (+V common), omit the “-1” from the model code.

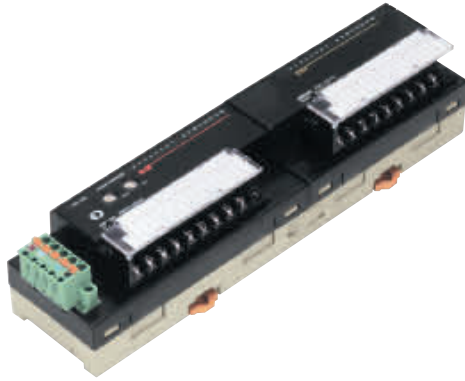

Smart DeviceNet I/O

Compact DeviceNet I/O units with extensive diagnostic functions. Data regarding power supply status, I/O response times, operation counters and on-time are continuously recorded and checked against user-defined limits. Any deviation is reported to the control system, as indication to perform machine maintenance and prevent unplanned downtime. Smart DeviceNet I/Os are supported by PLC Function Blocks and HMI Smart Active Parts, allowing program-less visualisation and monitoring from the CJ1 PLCs and NS operator terminals.

- Compact size IP20 housing
- Expandable digital I/Os
- Built-in diagnostics and preventive maintenance functions
- Detachable I/O terminal blocks
- Analog I/O with data pre-processing and alarm functions

Ordering information

Unit type	Specifications	Size in mm (H×W×D)	Remarks	Order code
8-point PNP input unit	24 VDC, 6 mA per point	50×115×50	–	DRT2-ID08-1
16-point PNP input unit	24 VDC, 6 mA per point	50×115×50	Expandable with one XWT unit	DRT2-ID16-1
16-point PNP input unit	24 VDC, 6 mA per point	50×180×58	3-tier connection for direct sensor wiring	DRT2-ID16TA-1
8-point PNP output unit	24 VDC, 0.5 A per point	50×115×50	–	DRT2-OD08-1
16-point PNP output unit	24 VDC, 0.5 A per point	50×115×50	Expandable with one XWT unit	DRT2-OD16-1
16-point PNP output unit	24 VDC, 0.5 A per point	50×180×58	3-tier connection for direct actuator wiring	DRT2-OD16TA-1
16-point relay output unit	2 A per point, max. 8 A per common	50×125×52	with easy-to-replace relays, expandable with one XWT unit	DRT2-ROS16
8-point input + 8-point output unit (PNP)	24 VDC, input 6 mA, output 0.5 A per point	50×115×50	–	DRT2-MD16-1
8-point input + 8-point output unit (PNP)	24 VDC, input 6 mA, output 0.5 A per point	50×180×58	3-tier connection for direct sensor/actuator wiring	DRT2-MD16TA-1
4-Channel analog input unit	0 to 5 V, 1 to 5 V, 0 to 10 V, -10 to 10 V, 0 to 20 mA, 4 to 20 mA	50×115×50	Resolution 1/6000, conversion time 4 ms (4 inputs)	DRT2-AD04
4-Channel analog input unit	1 to 5 V, 1 to 5 V, 0 to 10 V, -10 to 10 V, 0 to 20 mA, 4 to 20 mA	50×115×50	Resolution 1/30000, conversion time 250 ms (4 inputs)	DRT2-AD04H
2-Channel analog output unit	0 to 5 V, 1 to 5 V, 0 to 10 V, -10 to 10 V, 0 to 20 mA, 4 to 20 mA	50×115×50	Resolution 1/6000, conversion time 2 ms (2 outputs)	DRT2-DA02
4-Channel temperature input unit	Platinum Resistance Thermometer types Pt100, JPt100	50×115×50	0.3% accuracy, conversion time 250 ms (4 inputs)	DRT2-TS04P
4-Channel temperature input unit	Thermocouple types R, S, K, J, T, B, L, E, U, N, W, and PL2	50×115×50	0.3% accuracy, conversion time 250 ms (4 inputs)	DRT2-TS04T

Expansion units

Unit type	Specifications	Size in mm (H×W×D)	Remarks	Order code
8-point PNP input expansion unit	24 VDC, 6 mA per point	50×66×50	Expansion unit for GX, DRT2 and CRT1 series	XWT-ID08-1
16-point PNP input expansion unit	24 VDC, 6 mA per point	50×94×50	Expansion unit for GX, DRT2 and CRT1 series	XWT-ID16-1
8-point PNP output expansion unit	24 VDC, 0.5 A per point	50×66×50	Expansion unit for GX, DRT2 and CRT1 series	XWT-OD08-1
16-point PNP output expansion unit	24 VDC, 0.5 A per point	50×94×50	Expansion unit for GX, DRT2 and CRT1 series	XWT-OD16-1

Note: To order models with NPN (sinking) outputs and corresponding inputs (+V common), omit the "-1" from the model code.

Accessories

Type	Order code
Power supply tap with 2 fuses, 2 bus connectors and termination resistor	DCN1-1P
T-branch tap with 3 bus connectors (screw clamp) and terminating resistor	DCN1-1C
T-branch tap with 3 bus connectors (screwless)	DCN1-1NC
T-branch tap with 5 bus connectors (screw clamp) and terminating resistor	DCN1-3C
T-branch tap with 5 bus connectors (screwless)	DCN1-3NC
Terminating resistor with screw terminals	DRS1-T



Smart CompoNet I/O

Combining the smart features of DRT2 DeviceNet I/O and the speed and ease of use of CompoBus/S, CompoNet is ideal for high-speed machine control with a flexible and expandable architecture. The special flat cable and IDC connectors make installation quick and easy. The use of repeaters allows wide-area networks with free topology, ideal for conveyor- and warehouse automation.

- Compact size IP20 housing
- Expandable digital I/Os with detachable terminal blocks
- Easy network wiring with IDC connections
- Built-in diagnostics and preventive maintenance functions
- Analog I/O with data pre-processing and alarm functions

Ordering information

Unit type	Specifications	Size in mm (H×W×D)	Remarks	Order code
4-point PNP input unit	24 VDC, 6 mA per point	24×80×20	Screwless I/O connector, power supply via CompoNet cable	CRT1B-ID04SL-1-300
8-point PNP input unit	24 VDC, 6 mA per point	50×115×57.6	Screw terminals, common power terminals per 8 points	CRT1-ID08-1
8-point PNP input unit	24 VDC, 6 mA per point	50×96×60	3 push-in terminals per I/O point (signal + power)	CRT1-ID08SL-1
16-point PNP input unit	24 VDC, 6 mA per point	50×115×50	Expandable with one XWT unit.	CRT1-ID16-1
16-point PNP input unit	24 VDC, 6 mA per point	52×180×69	3 terminals per I/O point (for power distribution)	CRT1-ID16TA-1
4-point PNP output unit	24 VDC, 0.2 A per point	24×80×20	Screwless I/O connector, power supply via CompoNet cable	CRT1B-OD04SL-1-300
8-point PNP output unit	24 VDC, 0.5 A per point	50×115×57.6	Screw terminals, common power terminals per 8 points	CRT1-OD08-1
8-point PNP output unit	24 VDC, 0.5 A per point	50×96×60	3 push-in terminals per I/O point (signal + power)	CRT1-OD08SL-1
16-point PNP output unit	24 VDC, 0.5 A per point	50×115×50	Expandable with one XWT unit.	CRT1-OD16-1
16-point PNP output unit	24 VDC, 0.5 A per point	52×180×69	3 terminals per I/O point (for power distribution)	CRT1-OD16TA-1
8-point SSR output unit	265 V AC, 0.3 A per point	50×95×57.6	Screw terminals, common power terminals per 8 points	CRT1-ROF08
8-point relay output unit	250 VAC, 2 A per point, 8 A per common	50×95×57.6	Screw terminals, common power terminals per 8 points	CRT1-ROS08
16-point relay output unit	250 VAC, 2 A per point, 8 A per common	50×140×57.6	8 outputs per common	CRT1-ROS16
2-point input + 2-point output unit, PNP	24 VDC, 0.1 A per point	24×80×20	Screwless I/O connector, power supply via CompoNet cable	CRT1-MD04SL-1-300
8-point input + 8-point output unit, PNP	24 VDC, 0.5 A per point	50×115×57.6	Screw terminals, common power terminals	CRT1-MD16-1
8-point input + 8-point output unit, PNP	24 VDC, 0.5 A per point	50×170×60	3 push-in terminals per I/O point (signal + power)	CRT1-MD16SL-1
8-point input + 8-point output unit PNP	24 VDC, 0.5 A per point	52×180×69	3 terminals per I/O point (for power distribution)	CRT1-MD16TA-1
4-Channel analog input unit	0 to 5 V, 1 to 5 V, 0 to 10 V, -10 to 10 V, 0 to 20 mA, 4 to 20 mA	50×115×50	Resolution 1/6000, conversion time 4 ms (4 inputs)	CRT1-AD04
2-Channel analog output unit	0 to 5 V, 1 to 5 V, 0 to 10 V, -10 to 10 V, 0 to 20 mA, 4 to 20 mA	50×115×50	Resolution 1/6000, conversion time 2 ms (2 outputs)	CRT1-DA02
4-Channel Temperature input unit	Platinum Resistance Thermometer type Pt100	50×115×50	0.3% accuracy, conversion time 250 ms (4 inputs)	CRT1-TS04P
4-Channel Temperature input unit	Thermocouple types R, S, K, J, T, B, L, E, U, N, W and PL2	50×115×50	0.3% accuracy, conversion time 250 ms (4 inputs)	CRT1-TS04T

Expansion units

Unit type	Specifications	Size in mm (H×W×D)	Remarks	Order code
8-point PNP input expansion unit	24 VDC, 6 mA per point	50×66×50	Expansion unit for GX, DRT2 and CRT1 series	XWT-ID08-1
16-point PNP input expansion unit	24 VDC, 6 mA per point	50×94×50	Expansion unit for GX, DRT2 and CRT1 series	XWT-ID16-1
8-point PNP output expansion unit	24 VDC, 0.5 A per point	50×66×50	Expansion unit for GX, DRT2 and CRT1 series	XWT-OD08-1
16-point PNP output expansion unit	24 VDC, 0.5 A per point	50×94×50	Expansion unit for GX, DRT2 and CRT1 series	XWT-OD16-1

Note: To order models with NPN (sinking) outputs and corresponding inputs (+V common), omit the "-1" from the model code.

Accessories

Unit type	Specifications	Size in mm (H×W×D)	Remarks	Order code
CompoNet Repeater unit	1 upstream port + 1 downstream port	50×95×43	For extending CompoNet trunk lines, or creating branch lines	CRS1-RPT01
CompoNet 4-wire flat cable	For IP20 use	100 m	For power supply + communication, use with DCN4-connectors	DCA4-4F10
CompoNet Branch connector for trunk line	For IP20 use	–	To create a branching point on a trunk line	DCN4-TR4
CompoNet Branch line end connector	For IP20 use	–	To connect a branch line to a trunk line	DCN4-BR4
CompoNet Y-connector	For IP20 use	–	To connect two line connectors to one slave unit	DCN4-MD4
CompoNet Screw terminal connector	For IP20 use	–	To provide conventional screw terminals for masters or slaves	DCN4-TB4
CompoNet Terminator	For IP20 use	–	Plugs in to DCN4-MD4 or DCN4-TR4	DCN4-TM4
CompoNet connector tool	For DCN4-connectors	–	To attach DCN4-connectors to DCA4-4F10 flat cable	DWT-A01
CompoNet Screw terminal connector	For IP20 use, box of 10 pcs	–	To provide conventional screw terminals for 4-point bit slaves	HCN-TB4LMZG-B10+
Bit slave flat cable plug	For CRT1B-_D04SL-1-300 slaves	–	Allows mounting bit slaves directly on flat cable	DCN4-MR4
Bit slave mounting plate	For CRT1B-_D04SL-1-300 slaves	–	Mount with two screws, bit slave clips in place	CRT1-ATT03



Fast and easy over CompoBus/S

Omron's unique CompoBus/S is the original I/O bus for machine automation. With free topology and up to 500 m bus length in long-distance mode, it can be used as a remote I/O system. In high-speed mode (100 m max.) the guaranteed sub-millisecond cycle time makes it ideal for efficient machine control. Used with the compact CPM2C-S PLC as master, your machine control system will fit in the smallest spaces.

- Compact size in IP20 housing
- Fast cycle time; less than 1 ms per 256 I/O points
- Easy set-up; no software required
- Choice of 4- 8- and 16-point Digital I/O; transistor-, and relay models
- Analog In/Outputs and customisable modules available

Ordering information

Unit type	Specifications	Size in mm (H×W×D)	Remarks	Order code
4-point PNP input unit	24 VDC, 6 mA per point	48×80×50	Compact IP20 I/O	SRT2-ID04-1
8-point PNP input unit	24 VDC, 6 mA per point	48×80×50	Compact IP20 I/O	SRT2-ID08-1
16-point PNP input unit	24 VDC, 6 mA per point	48×105×50	Compact IP20 I/O	SRT2-ID16-1
16-point PNP input unit	24 VDC, 6 mA per point	50×180×59	3-tier connection for direct sensor wiring	SRT2-ID16T-1
4-point PNP output unit	24 VDC, 0.3 A per point	48×80×50	Compact IP20 I/O	SRT2-OD04-1
8-point PNP output unit	24 VDC, 0.3 A per point	48×80×50	Compact IP20 I/O	SRT2-OD08-1
16-point PNP output unit	24 VDC, 0.3 A per point	48×105×50	Compact IP20 I/O	SRT2-OD16-1
16-point PNP output unit	24 VDC, 0.5 A per point	50×180×59	3-tier connection for direct sensor/actuator wiring	SRT2-OD16T-1
8-point input + 8-point output unit (PNP)	24 VDC, input 6 mA, output 0.3 A per point	50×180×59	3-tier connection for direct actuator wiring	SRT2-MD16T-1
8-point relay output unit	Max. 3 A per point	50×100×50	with easy-to-replace relays	SRT2-ROC08
16-point relay output unit	Max. 3 A per point	50×155×50	with easy-to-replace relays	SRT2-ROC16
4-Channel analog input unit	0 to 5 V, 1 to 5 V, 0 to 10 V, -10 to 10 V, 0 to 20 mA, 4 to 20 mA	48×105×50	Resolution 1/6000, conversion time 4 ms (4 inputs)	SRT2-AD04
2-Channel analog output unit	0 to 5 V, 1 to 5 V, 0 to 10 V, -10 to 10 V, 0 to 20 mA, 4 to 20 mA	48×105×50	Resolution 1/6000, conversion time 2 ms (2 outputs)	SRT2-DA02

Note: To order models with NPN (sinking) outputs and corresponding inputs (+V common), omit the "-1" from the model code.

Accessories

Type	Order code
CompoBus/S 4-wire flatcable for power and communication (100 m)	SCA1-4F10
CompoBus/S branch connector (IDC) for flatcable	SCN1-TH4
CompoBus/S termination connector (IDC) for flatcable	SCN1-TH4T
CompoBus/S termination block (screw connection)	SRS1-T



DeviceNet I/O for harsh environments

Rugged I/O units for field mounting. The DRT2 slave units feature internal diagnostic and maintenance data collection, which can be accessed over the network. Power supply status, I/O response times, operation counters and on-time monitor data is available at all times, and is internally checked against user-defined limits. Maintenance warnings will be generated when limits are exceeded. Using CX-One or NS-series HMI with Smart Active Parts for visualisation, this allows more efficient system setup, commissioning and troubleshooting without any additional programming.

- IP67 protection, DRT2 versions are also oil- and welding-spatter proof
- Internal circuits powered by DeviceNet; fewer connections means less installation errors
- Smart Slave functions for diagnostics and preventive maintenance
- Indication of broken wire and short-circuit in I/O signals
- M12 connectors for fast installation

Ordering information

Unit type	Specifications	Size in mm (H×W×D)	Remarks	Order code
4-point PNP input unit	24 V, 6 mA	123×60×44	Separate I/O power supply connection	DRT2-ID04CL-1
8-point PNP input unit	24 V, 6 mA	175×60×44	Separate I/O power supply connection	DRT2-ID08CL-1
8-point PNP input unit	24 V, 11 mA, with power short-circuit and sensor disconnection detection	175×60×38	Unit power supply via DeviceNet cable	DRT2-ID08C-1
16-point PNP input unit	24 V, 6 mA, 2 inputs per M12 connector	175×60×44	Separate I/O power supply connection	DRT2-HD16CL-1
16-point PNP input unit	24 V, 11 mA, 2 inputs per M12 connector, with power short-circuit and sensor disconnection detection	175×60×38	Unit power supply via DeviceNet cable	DRT2-HD16C-1
4-point PNP output unit	24 V, 0.5 A per point	123×60×44	Separate I/O power supply connection	DRT2-OD04CL-1
8-point PNP output unit	24 V, 0.5 A per point	175×60×44	Separate I/O power supply connection	DRT2-OD08CL-1
8-point PNP output unit	24 V, 1.5 A per point (8 A total), with short-circuit protection + indication	175×60×44	Separate I/O power supply connection	DRT2-OD08C-1
16-point PNP output unit	24 V, 0.5 A per point, 2 points per M12 connector	175×60×44	Separate I/O power supply connection	DRT2-WD16CL-1
8-point input + 8-point PNP output unit	24 V, 6 mA input, 0.5 A output per point, 2 points per M12 connector	175×60×44	Separate I/O power supply connection	DRT2-MD16CL-1

Note: To order models with NPN (sinking) outputs and corresponding inputs (+V common), omit the “-1” from the model code.

Accessories

Unit type	Specifications	Order code
DeviceNet thin cable	with one M12 socket connector (female), 1 m	DCA1-5CN01F1
DeviceNet thin cable	with one M12 socket connector (female), 2 m	DCA1-5CN02F1
DeviceNet thin cable	with one M12 socket connector (female), 5 m	DCA1-5CN05F1
DeviceNet thin cable	with one M12 socket connector (female) and one M12 plug connector (male), 1 m	DCA1-5CN01W1
DeviceNet thin cable	with one M12 socket connector (female) and one M12 plug connector (male), 2 m	DCA1-5CN02W1
DeviceNet thin cable	with one M12 socket connector (female) and one M12 plug connector (male), 5 m	DCA1-5CN05W1
DeviceNet T-connector for thin cable	with two M12 socket connectors (female) + one M12 plug connector (male)	DCN2-1
DeviceNet terminator	with M12 plug connector	DRS2-1
Power supply cable	with one 7/8 inches socket connector (female), 2 m	XS4F-D421-102-A
Power supply cable	with one 7/8 inches socket connector (female), 5 m	XS4F-D421-105-A
Power supply cable	with one 7/8 inches socket connector (female) and one 7/8 inches plug connector (male), 2 m	XS4W-D421-102-A
Power supply cable	with one 7/8 inches socket connector (female) and one 7/8 inches plug connector (male), 5 m	XS4W-D421-105-A
Power supply T-connector	with two 7/8 inches socket connectors (female) + one 7/8 inches plug connector (male)	XS4R-D424-5
4-wire I/O connection cable	with one M12 plug connector (male), 1 m	XS2H-D421-C80-A
4-wire I/O connection cable	with one M12 plug connector (male), 2 m	XS2H-D421-D80-A
4-wire I/O connection cable	with one M12 plug connector (male), 5 m	XS2H-D421-G80-A
4-wire I/O connection cable	with one M12 socket connector (female) and one M12 plug connector (male), 1 m	XS2W-D421-C81-A
4-wire I/O connection cable	with one M12 socket connector (female) and one M12 plug connector (male), 2 m	XS2W-D421-D81-A
4-wire I/O connection cable	with one M12 socket connector (female) and one M12 plug connector (male), 5 m	XS2W-D421-G81-A
Y-connector for 16-point I/O units	Splits the 2 I/O points per M12 connector to two M12 connectors	XS2R-D426-1
Y-connector cable for 16-point I/O units	Splits the 2 I/O points per M12 connector to two M12 connectors, 1 m	XS2R-D426-C11-F
M12 connector	M12 plug connector (male), solder type	XS2G-D421
M12 connector	M12 socket connector (female), solder type	XS2C-D421
IP67 cap for M12 sockets	Metal cap for unused I/O connections	XS2Z-12



Dust- and waterproof CompoBus I/O

Rugged I/O units for field mounting. Omron's unique CompoBus/S is the most efficient I/O bus for machine automation. With free topology and up to 500 m bus length in long-distance mode, it can be used as a remote I/O system. In high-speed mode (100 m max.) the guaranteed sub-millisecond cycle time makes it ideal for efficient machine control. With IP67 slave modules distributed throughout the machine, the need for protective enclosures is minimised.

- IP67 protection against dust and water
- Fast cycle time; less than 1 ms for 256 I/O points
- Easy setup; no software required
- Choice of 4- and 8-point Digital I/O
- M12 connectors for easy field wiring

Ordering information

Unit type	Specifications	Size in mm (H×W×D)	Order code
4-point PNP input unit	24 V, 6 mA	114×54×45	SRT2-ID04CL-1
8-point PNP input unit	24 V, 6 mA	114×54×45	SRT2-ID08CL-1
4-point PNP output unit	24 V, 0.5 A per point	114×54×45	SRT2-OD04CL-1
8-point PNP output unit	24 V, 0.5 A per point	114×54×45	SRT2-OD08CL-1

Note: To order models with NPN (sinking) outputs and corresponding inputs (+V common), omit the "-1" from the model code.

Accessories

Unit type	Specifications	Remarks	Order code
CompoBus/S terminator	with M12 plug connector	–	SRS2-1
M12 connector	M12 plug connector (male), screw type	For CompoBus/S 4-wire round cable	XS2G-D4S7
M12 connector	M12 socket connector (female), screw type	For CompoBus/S 4-wire round cable	XS2C-D4S7
M12 T-connector (4-wire)	with two M12 socket connectors (female) + one M12 plug connector (male)	–	XS2R-D427-5
4-wire I/O connection cable	with one M12 plug connector (male), 1 m	–	XS2H-D421-C80-A
4-wire I/O connection cable	with one M12 plug connector (male), 2 m	–	XS2H-D421-D80-A
4-wire I/O connection cable	with one M12 plug connector (male), 5 m	–	XS2H-D421-G80-A
4-wire I/O connection cable	with one M12 socket connector (female) and one M12 plug connector (male), 1 m	–	XS2W-D421-C81-A
4-wire I/O connection cable	with one M12 socket connector (female) and one M12 plug connector (male), 2 m	–	XS2W-D421-D81-A
4-wire I/O connection cable	with one M12 socket connector (female) and one M12 plug connector (male), 5 m	–	XS2W-D421-G81-A
Y-connector for 16-point I/O units	Splits the 2 I/O points per M12 connector to two M12 connectors	–	XS2R-D426-1
Y-connector cable for 16-point I/O units	Splits the 2 I/O points per M12 connector to two M12 connectors, 1 m	–	XS2R-D426-C11-F
M12 connector	M12 plug connector (male), solder type	–	XS2G-D421
M12 connector	M12 socket connector (female), solder type	–	XS2C-D421
IP67 cap for M12 sockets	Metal cap for unused I/O connections	–	XS2Z-12

Human machine interfaces (HMI)

NA AND NB SERIES

If you are looking for a smart and dependable HMI for use with our compact and modular PLC's, look no further than the NB series. It offers you - among various other features – an LED backlit TFT LCD, a portrait and landscape mode and USB memory stick support. It is available with screen sizes from 3.5 to 10 inches.

For faster, more efficient control and monitoring, the scalable NA series HMI offers a more natural, proactive machine/operator environment that will evolve to meet your ever-changing needs. Based on the Sysmac Platform, the NA series is fully aware of the total machine and brings together all areas of automation including: logic, motion, vision, safety and visualization. It gives you a clear view in one integrated project. The high resolution wide screens are available in 7" and 9" (800 × 480 pixel) as well as 12" and 15" (1280 × 800 pixel)

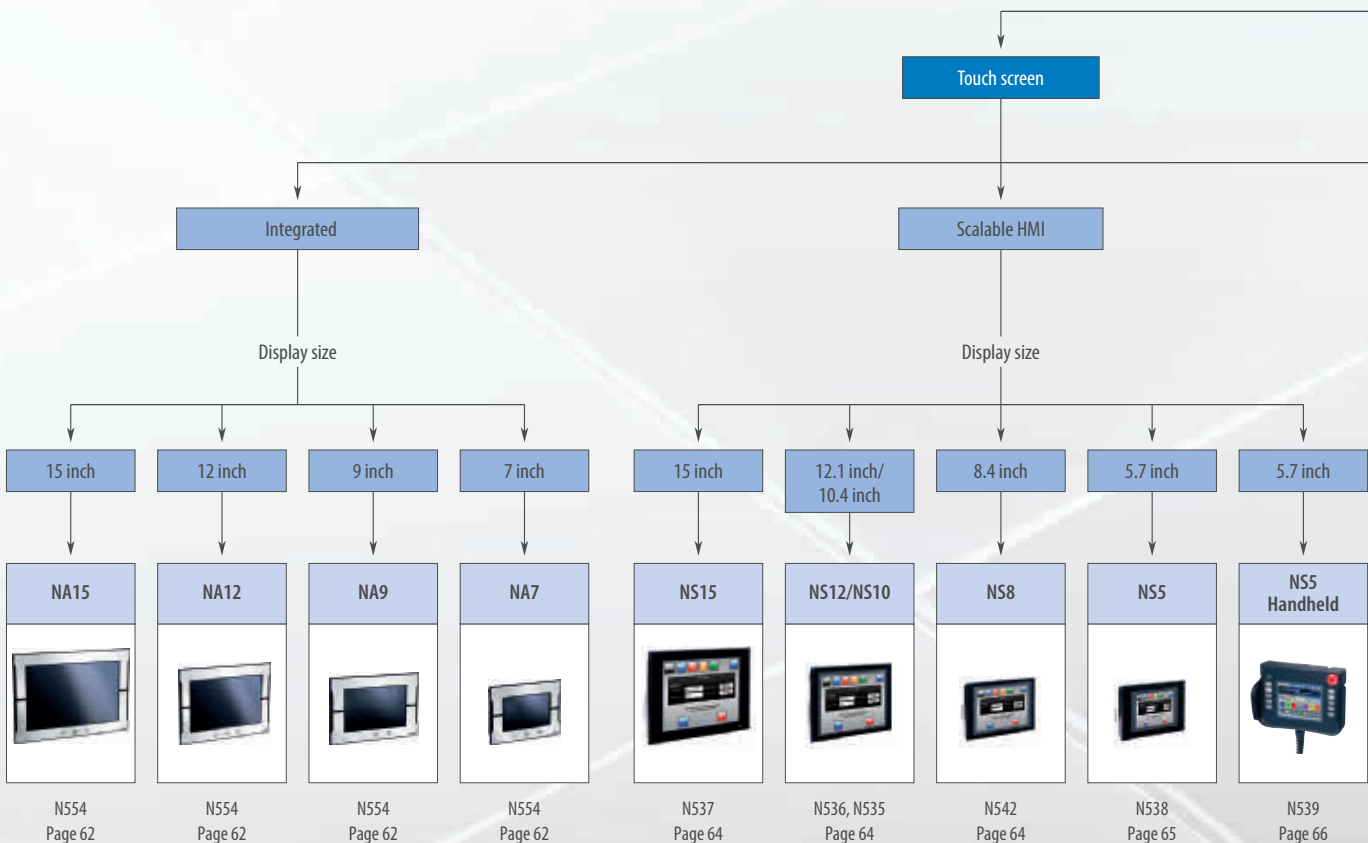





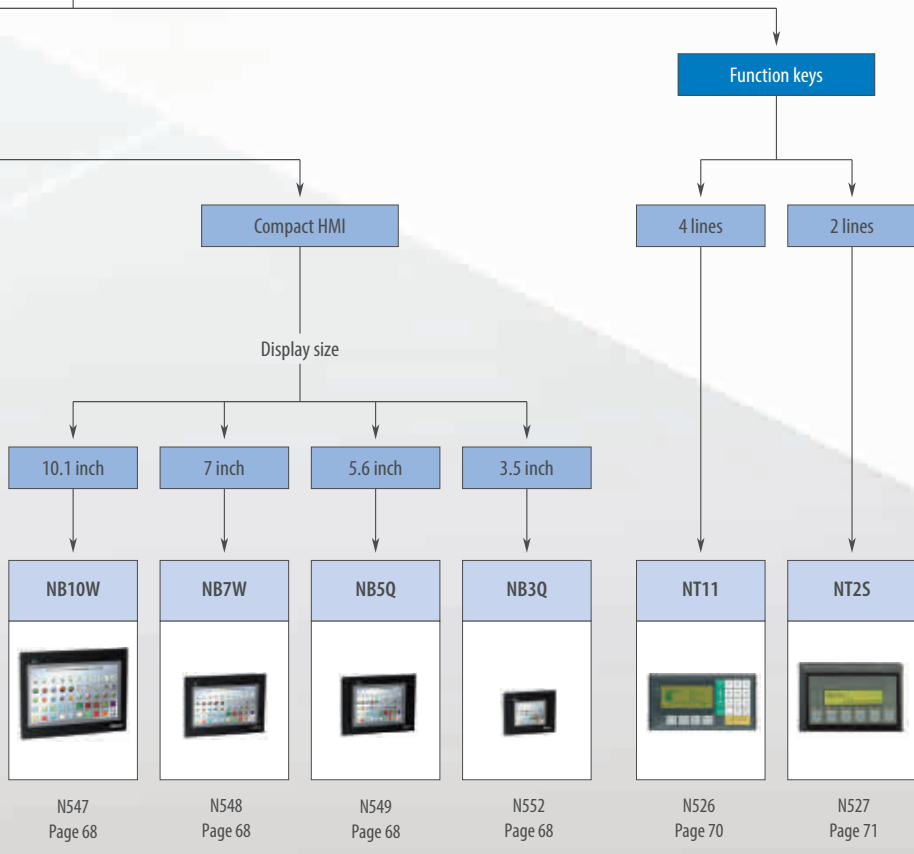







Interaction type





Selection table

Integrated				
				
Model	NA15	NA12	NA9	NA7
Display	15 inch widescreen TFT color	12 inch widescreen TFT color	9 inch widescreen TFT color	7 inch widescreen TFT color
Resolution	1280 × 800 pixels	1280 × 800 pixels	800 × 400 pixels	800 × 400 pixels
Colors	24 bit	24 bit	24 bit	24 bit
Communication	3 × USB 2 × Ethernet 1 × RS-232 SD Card 24 VDC	3 × USB 2 × Ethernet 1 × RS-232 SD Card 24 VDC	3 × USB 2 × Ethernet 1 × RS-232 SD Card 24 VDC	3 × USB 2 × Ethernet 1 × RS-232 SD Card 24 VDC
Dimensions in mm (H×W×D)	420×291 391×267 (cut-out)	340×244 309×220 (cut-out)	290×190 260×165 (cut-out)	236×165 196×140 (cut-out)
Page/Quick Link	62			

Scalable HMI						
						
Model	NS15	NS12	NS10	NS8	NS5	NS5 handheld
Display	15 inch TFT color	12.1 inch TFT color	10.4 inch TFT color	8.4 inch TFT color	5.7 inch TFT color	5.7 inch STN color
Resolution	1024 × 768 pixels (XGA)	800 × 600 pixels (SVGA)	640 × 480 pixels (VGA)	640 × 480 pixels (VGA)	320 × 240 pixels (QVGA)	320 × 240 pixels (QVGA)
Number of colors	256 (32,768 for image data)	256 (32,768 for image data)	256 (32,768 for image data)	256 (32,768 for image data)	256 (32,768 for image data)	256 (4,096 for image data)
Memory Size	60 MB screen memory	60 MB screen memory, 32,768 words + 32,768 bits internal memory and 8192 words + 8192 bits retentative memory	60 MB screen memory, 32,768 words + 32,768 bits internal memory and 8192 words + 8192 bits retentative memory	60 MB screen memory, 32,768 words + 32,768 bits internal memory and 8192 words + 8192 bits retentative memory	60 MB screen memory, 32,768 words + 32,768 bits internal memory and 8192 words + 8192 bits retentative memory	60 MB screen memory, 32,768 words + 32,768 bits internal memory and 8192 words + 8192 bits retentative memory
Options	Controller Link, Video input board (NS-CA002)	Ethernet, Controller Link, Video input board (RGB/Composite)	Ethernet, Controller Link, Video input board (RGB/Composite)	Ethernet, Video input board (RGB/Composite)	Ethernet	RS-232 or RS-422 communication depending on cable
Dimensions in mm (H×W×D)	300×400×80	241×315×48.5	241×315×48.5	177×195×48.5	142×195×54	176×223×70.5 (excl. emergency button)
Page/Quick Link	64				65	66

Compact HMI				
				
Model	NB10W	NB7W	NB5Q	NB3Q
Display	10.1 inch Wide TFT LCD	7 inch Wide TFT LCD	5.6 inch TFT LCD	3.5 inch TFT LCD
Resolution	800 × 480 pixels	800 × 480 pixels	320 × 234 pixels	320 × 240 pixels
Number of colors	65,536	65,536	65,536	65,536
Memory	128 MB (including system area)	128 MB (including system area)	128 MB (including system area)	128 MB (including system area)
Communication ports	Serial Communication	1 × RS-232C & 1 × RS-232C/422A/485	1 × RS-232C & 1 × RS-232C/422A/485	1 × RS-232C/422A/485
	USB (USB Host only on TW01 model)	1 × USB Host & 1 × USB Slave	1 × USB Host & 1 × USB Slave	1 × USB Host & 1 × USB Slave
	Ethernet	1 × Ethernet	1 × Ethernet (TW01 model)	1 × Ethernet (TW01 model)
Dimensions in mm (H×W×D)	210.8×268.8×54.0	148×202×46	142×184×46	103.8×129.8×52.8
Page/Quick Link	68			

Function-key HMI				
				
Model	NT11	NT25		
Type of Display	LED backlight LCD	LED backlight LCD		
Number of F-keys	22	6 or 20 depending on model		
Number of characters	20 × 4 lines	16 × 2 lines		
Printer connection	Yes	Depending on model		
Number of screens	250	65,000 (limited by memory)		
Size in mm (H×W×D)	113×218×38.2	6 F-keys 60×109×43 20 F-keys 107×107×43		
Page/Quick Link	70	71		

Bringing technology to life...

An HMI that is dynamic, intuitive and predictive makes industrial machines more attractive and competitive. Our Sysmac HMI enables faster, more efficient control and monitoring – and a more natural, proactive relationship between operator and machine.

- Complete functionality scalable with widescreen across 7", 9", 12", 15" range
- Available in black or silver
- High resolution (1280 × 800 pixel for 12" and 15", 800 × 480 pixel for 7" and 9")



Ordering information

Machine interface

Display	Colors	Resolution	Frame color	Order code
15.4 inch wide screen, TFT LCD	24 bit full color	1280 × 800 pixels	Silver	NA5-15W101S
			Black	NA5-15W101B
12.1 inch wide screen, TFT LCD		1280 × 800 pixels	Silver	NA5-12W101S
			Black	NA5-12W101B
9 inch wide screen, TFT LCD		800 × 480 pixels	Silver	NA5-9W001S
			Black	NA5-9W001B
7 inch wide screen, TFT LCD		800 × 480 pixels	Silver	NA5-7W001S
			Black	NA5-7W001B

Accessories

Type	Specifications	Order code	
SD memory card	2 GB	HMC-SD291	
	4 GB	HMC-SD491	
USB memory	2 GB	FZ-MEM2G	
	8 GB	FZ-MEM8G	
Replacement battery	Battery life: 5 years (at 25°C). This Battery is provided as an accessory.	CJ1W-BAT01	
Anti-reflection sheets	Attach a Sheet to the screen to protect against diffused reflections and dirt. The entire Sheet is colorless and transparent. Five Sheets are provided in one set.	For NA5-15W	NA-15KBA04
		For NA5-12W	NA-12KBA04
		For NA5-9W	NA-9KBA04
		For NA5-7W	NA-7KBA04

Computer software

Specifications	Order code
Sysmac Studio version 1.10 or higher	SYSMAC-SE2_

Specifications

Item	Specification			
	NA5-15W_	NA5-12W_	NA5-9W_	NA5-7W_
Rated supply voltage	24 VDC			
Allowable power supply voltage range	19.2 to 28.8 VDC (24 VDC ±20%)			
Power consumption	47 W max.	45 W max.	40 W max.	35 W max.
Ambient operating temperature	0 to 50°C ^{*1} ^{*2}			
Ambient storage temperature	-20 to +60°C ^{*3}			
Ambient operating humidity	10 to 90% ^{*2} Must be no condensation.			
Atmosphere	Must be free from corrosive gases.			
Pollution degree	2 or less: JIS B 3502, IEC 61131-2			
Noise immunity	2 kV on power supply line (Conforms to IEC 61000-4-4.)			
Vibration resistance (during operation)	Conforms to IEC 60068-2-6. 5 to 8.4 Hz with 3.5 mm half amplitude and 8.4 to 150 Hz with 9.8 m/s ² for 100 minutes each in X,Y, and Z directions (Time coefficient of 10 minutes × coefficient factor of 10 = total time of 100 min.)			
Shock resistance (during operation)	Conforms to IEC 60028-2-27. 147 m/s ² 3 times each in X, Y, and Z directions			
Dimensions (W×H×D)	420 × 291 × 69 mm	340 × 244 × 69 mm	290 × 190 × 69 mm	236 × 165 × 69 mm
Panel cutout dimensions	392 ⁺¹ ₀ × 268 ⁺¹ ₀ mm (horizontal × vertical) Panel thickness: 1.6 to 6.0 mm	310 ⁺¹ ₀ × 221 ⁺¹ ₀ mm (horizontal × vertical) Panel thickness: 1.6 to 6.0 mm	261 ⁺¹ ₀ × 166 ⁺¹ ₀ mm (horizontal × vertical) Panel thickness: 1.6 to 6.0 mm	197 ^{+0.5} ₀ × 141 ^{+0.5} ₀ mm (horizontal × vertical) Panel thickness: 1.6 to 6.0 mm
Weight	3.2 kg max.	2.3 kg max.	1.7 kg max.	1.3 kg max.
Degree of protection	Front-panel controls: IP65 oil-proof type, UL type 4X			
Battery life	Battery life: 5 years at 25°C The RTC will be backed up for 5 days after the battery runs low. The RTC will be backed up by a super capacitor for 5 minutes after removing the old battery. (This assumes that the power is first turned ON for at least 5 minutes and then turned OFF.)			
International standards	UL 508/CSA standard C22.2 No.142 ^{*4} EMC Directive (2004/108/EC) EN 61131-2:2007 Shipbuilding standards LR, DNV, and NK IP65 oil-proof, UL type 4X (front panel only) ANSI 12.12.01 Class 1 Division 2/CSA standard C22.2 RoHS Directive (2002/95/EC) KC Standards KN 61000-6-2:2012-06 for EMS and KN 61000-6-4:2012-06 for EMI RCM			

^{*1} The ambient operating temperature is subject to the following restrictions, depending on the mounting angle.
 · The ambient operating temperature is 0° to 40°C when the mounting angle is 0° or more and less than 45° to the horizontal.
 · The ambient operating temperature is 0° to 50°C when the mounting angle is 45° or more and 90° or less to the horizontal.
 · The ambient operating temperature is 0° to 50°C when the mounting angle is 90° or more and 135° or less to the horizontal.

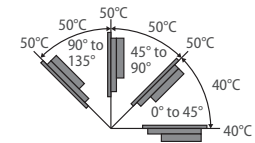

^{*2} Use the Programmable Terminal within the following temperature and humidity ranges.

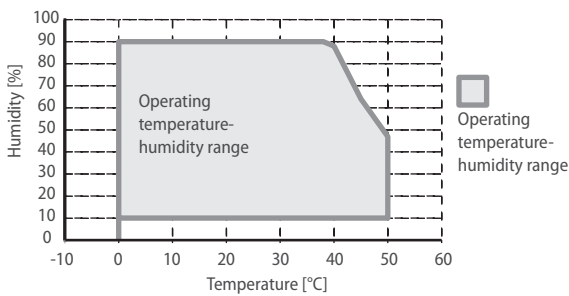

^{*3} Store the Programmable Terminal within the following temperature and humidity ranges.

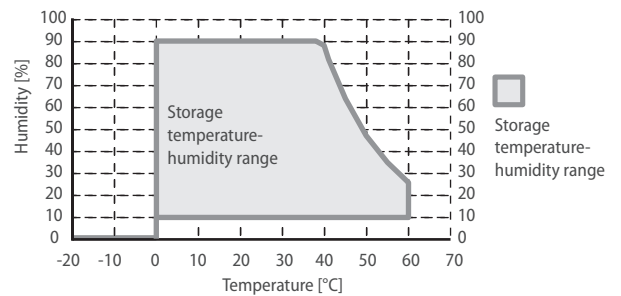

^{*4} Use power supply Class 2 to conform to UL Standards.



One-touch machine management

The NS-series is our advanced HMI series that covers a large range from 5.7" Monochrome STN to 15" TFT. Easily programmed it offers advanced features like, multiple communication possibilities, good synergy with our PLC's and other devices with Ladder monitor, Smart Active Parts and proven reliability.

- Perfect clarity and fast switching screens
- Extremely long backlight life (up to 50,000 hours)
- Support all European languages, Asian and Cyrillic
- Easy data logging on compact flash
- Large Memory size (60 MB)
- Support for several non-Omron PLC's

Ordering information

Type		Order Code	
TFT, 15", 1024 x 768 pixels	with Ethernet	Black	NS15-TX01B-V2
		Silver	NS15-TX01S-V2
TFT, 12", 800 x 600 pixels	no Ethernet	Black	NS12-TS00B-V2
		Ivory	NS12-TS00-V2
	with Ethernet	Black	NS12-TS01B-V2
		Ivory	NS12-TS01-V2
TFT, 10", 640 x 480 pixels	no Ethernet	Black	NS10-TV00B-V2
		Ivory	NS10-TV00-V2
	with Ethernet	Black	NS10-TV01B-V2
		Ivory	NS10-TV01-V2
TFT, 8.4", 640 x 480 pixels	no Ethernet	Black	NS8-TV00B-V2
		Ivory	NS8-TV00-V2
	with Ethernet	Black	NS8-TV01B-V2
		Ivory	NS8-TV01-V2

Note: For the accessories, please refer to page 67

Specifications

Item	NS15	NS12	NS10	NS8
Display type	15 inch color TFT	12 inch color TFT	10 inch color TFT	8 inch color TFT
Display resolution	1024×768 (XGA)	800×600 (SVGA)	640×480 (VGA)	
Number of colors	256 (32,768 for image data)			
Backlight	2×CCFL	1×LED		
Backlight lifetime	Min. 50000 hours			
View angle	Left/right ±85°, Top 70°, Bottom 80°	Left/right ±60°, Top 45°, Bottom 75°	Left/right ±60°, Top 35°, Bottom 65°	Left/right ±65°, Top 50°, Bottom 60°
Touch panel	Analog resistive touch	Matrix resistive touch		
Number of functional keys	3	–		
Dimensions in mm (H×W×D)	304×405×75.8	241×315×48.5		177×232×48.5
Weight	4.2 kg max.	2.5 kg max.		2.0 kg max.
Screen data capacity	60 MB			
Internal memory	Bit memory: 32,767 bits, Word memory: 32,767 words, Retentative memory: 8,192 bits and 8,192 words.			
Memory card interface	1 slot ATA Compact Flash card			
Printer connection	PictBridge support			
Serial (COM1)	1×RS-232			
Serial (COM2)	1×RS-232/422/485	1×RS-232		
USB Slave	For programming & printing			
Ethernet	IEEE 802.3u 10Base-T/100Base-TX			
Expansion module	Optional network/video unit			Optional video unit
Line voltage	24 VDC ±15%			
Power consumption	45 W max.	25 W max.		
Battery	CJ1W-BAT01			
Battery lifetime	5 years (at 25°C)			
Enclosure rating (front side)	IP65F (equivalent to NEMA4)			
Obtained standards	UL 1604 Class 1 Diff. 2, cUL, CE, Lloyds, DNV			
Operating environment	No corrosive gases			
Noise immunity	Conforms to IEC61000-4-4, 2 KV (power lines)			
Ambient operating temperature	0 to 50°C ^{*1}			
Ambient operating humidity	35% to 85% (0 to 40°C) with no condensation, 35% to 60% (40 to 50°C) with no condensation			

*1 see manual for details.



More power, smaller size

The smallest NS HMI is available in two brightness variations, both with a vivid color TFT touchscreen. It is equipped with a USB connection for project download/upload and the possibility to communicate over Ethernet. One great advantage with the NS is that you can make use of Omron's unique Smart Active Parts (SAP) that save you time when configuring, commissioning and maintaining your machine. SAP are pre-programmed, pre-tested visualisation objects with embedded communication code, bringing 'drag and drop' simplicity to HMI design.

- Perfect clarity and fast switching screens
- Extremely long backlight life (up to 75,000 hours)
- Support all European languages, Asian and Cyrillic
- Easy data logging on compact flash
- Large Memory size (60 MB)
- Support for several non-Omron PLC's

Ordering information

Type				Order Code
NS5-TQ	TFT, 5.7", 320×240 pixels	no Ethernet	Black	NS5-TQ10B-V2
			Ivory	NS5-TQ10-V2
		with Ethernet	Black	NS5-TQ11B-V2
			Ivory	NS5-TQ11-V2
NS5-SQ	TFT, 5.7", 320×240 pixels	no Ethernet	Black	NS5-SQ10B-V2
			Ivory	NS5-SQ10-V2
		with Ethernet	Black	NS5-SQ11B-V2
			Ivory	NS5-SQ11-V2

Note: For the accessories, please refer to page 67

Specifications

Item	NS5-TQ	NS5-SQ
Display type	5.7 inch color TFT	
Display resolution	340×240 (QVGA)	
Number of colors	256 (32,768 for image data)	
Backlight	LED	
Backlight lifetime	Min. 75000 hours	
View angle	Left/right ±80°, Top 80°, Bottom 60°	
Touch panel	Matrix resistive touch	
Number of functional keys	-	
Dimensions in mm (H×W×D)	142×195×54	
Weight	1.0 kg max.	
Screen data capacity	60 MB	
Internal memory	Bit memory: 32,767 bits, Word memory: 32,767 words, Retentative memory: 8,192 bits and 8,192 words.	
Memory card interface	1 slot ATA Compact Flash card	
Printer connection	PictBridge support	
Serial (COM1)	1×RS-232	
Serial (COM2)	1×RS-232	
USB Slave	For programming & printing	
Ethernet	IEEE 802.3u 10Base-T/100Base-TX	
Expansion module	-	
Line voltage	24 VDC ±15%	
Power consumption	15 W max.	
Battery	CJ1W-BAT01	
Battery lifetime	5 years (at 25°C)	
Enclosure rating (front side)	IP65F (equivalent to NEMA4)	
Obtained standards	UL 1604 Class 1 Diff. 2, cUL, CE, Lloyds, DNV	
Operating environment	No corrosive gases	
Noise immunity	Conforms to IEC61000-4-4, 2 KV (power lines)	
Ambient operating temperature	0 to 50°C ^{*1}	
Ambient operating humidity	35% to 85% (0 to 40°C) with no condensation, 35% to 60% (40 to 50°C) with no condensation	

*1 See manual for details.



NS5 handheld, suitable for use in harsh conditions

The NS series has evolved into a mobile format. Based on the standard 5.7" TFT color version, we can offer a handheld version of the NS series. Offering 10 Function keys for the most used functions and with a protection degree of IP65 it is the product to use in harsh environment where freedom of movement is needed.

- 10 Function keys, 4 hardwired for inching
- Emergency switch on front plus enable switch on back of unit
- Well protected against water, IP65
- Compact Flash, Serial and USB interface

Ordering information

Type			Order code
NSH5	TFT, 5.7", 320×240 pixels	Black	NSH5-SQR10B-V2

Accessories

Type		Order code
Bracket NS handheld protecting emergency button from accidental activation		NSH5-ATT01
Bracket NS handheld for wall mounting		NSH5-ATT02
Cable NS handheld, RS-422, 10m UL		NSH5-422UL-10M
Cable NS handheld, RS-232, 10m UL		NSH5-232UL-10M
Cable NS handheld, RS-232, 3m UL		NSH5-232UL-3M

Specifications

Memory card interface	1 slot ATA Compact Flash card
Serial (COM1)	1×RS-232/RS-422A
USB Slave	For programming
Line voltage	24 VDC ±15%
Power consumption	10 W max.
Battery	CJ1W-BAT01
Battery lifetime	5 years (at 25°C)
Enclosure rating	IP65 ^{*1}
Obtained standards	UL 1604 Class 1 Diff. 2, cUL, CE, NEMA equivalent
Operating environment	No corrosive gases
Noise immunity	Conforming to IEC 61000-4-4: 2 kV (power supply line)
Ambient operating temperature	0 to 40°C
Ambient operating humidity	35% to 85% max. (with no condensation)
Vibration resistance (during operation)	10 to 57 Hz with amplitude of 0.075 mm, 57 to 150 Hz with acceleration of 9.8 m/s ² three minutes each in X, Y, and Z directions
Shock resistance (during operation)	147 m/s ² three times each in X, Y, and Z directions
Drop test ^{*1}	Dropped from 1 m. Conforming to JIS B 3502/IEC61131-2

^{*1} see manual for details.

Ordering information

Type	Description	Order code	
Cable	Serial programming cable	XW2Z-S002	
	USB programming cable, 2 m	CP1W-CN221	
PT-to-PLC Connecting Cable	PT connection: 9 pins Length: 2 m	XW2Z-200T	
	PLC connection: 9 pins Length: 5 m	XW2Z-500T	
Accessories	Video input	Inputs: 4 channels NTSC / PAL NS-CA001	
		Inputs: 2 channels NTSC / PAL, 1 channel RGB NS-CA002	
	Cable to connect NS-CA00_ to Video console unit		F150-VKP (2 m) F150-VKP (5 m)
	Controller link interface unit		NS-CLK21
	RS-422A/485 adapter (50 m)		CJ1W-CIF11
	RS-422A adapter (500 m)		NS-AL002
	Anti-reflection sheets (5 sheets)	NS15	NS15-KBA04
		NS12/10	NS12-KBA04
		NS8	NS7-KBA04
		NS5	NT30-KBA04
	Anti-reflection protective covers (5 pack)	NS12/10	NS12-KBA05
		NS8	NS7-KBA05
		NS5	NT31C-KBA05
	Transparent protective covers (5 pack)	NS15 (1 cover)	NS15-KBA05N
		NS12/10	NS12-KBA05N
		NS8	NS7-KBA05N
		NS5	NT31C-KBA05N
	Chemical-resistant cover (1 cover)	NS5	NT30-KBA01
	Attachment adapter	(NT625C/631/631C series to NS12 series)	NS12-ATT01
		(NT625C/631/631C series to NS12 series) Black	NS12-ATT01B
		(NT620S/620C/600S series to NS8 series)	NS8-ATT01
		(NT600M/600G/610G/612G series to NS8 series)	NS8-ATT02
	Memory card	128 MB	HMC-EF183
256 MB		HMC-EF283	
512 MB		HMC-EF583	
Memory card adapter for PC		HMC-AP001	
Battery		CJ1W-BAT01	

HMI



The feature-rich, cost-effective HMI

The combination of high quality and rich features add up to give outstanding value for an HMI in the economy class. The NB-Designer software to create your HMI application is free of charge and can be downloaded from our website.

- More than 65,000 display colors TFT touch screen
- Available in sizes ranging from 3.5 to 10 inches
- Long-life LED backlight
- Serial, USB or Ethernet communication
- USB memory stick support (TW01 model only)
- 128 MB internal memory
- Vector and bitmap graphics

Ordering information

HMI panels

Product name	Specifications	Order code
NB3Q	3.5 inch, TFT LCD, Color, 320 × 240 dots	NB3Q-TW00B
	3.5 inch, TFT LCD, Color, 320 × 240 dots, USB Host, Ethernet	NB3Q-TW01B
NB5Q	5.6 inch, TFT LCD, Color, 320 × 234 dots	NB5Q-TW00B
	5.6 inch, TFT LCD, Color, 320 × 234 dots, USB Host, Ethernet	NB5Q-TW01B
NB7W	7 inch, TFT LCD, Color, 800 × 480 dots	NB7W-TW00B
	7 inch, TFT LCD, Color, 800 × 480 dots, USB Host, Ethernet	NB7W-TW01B
NB10W	10.1 inch, TFT LCD, Color, 800 × 480 dots, USB Host, Ethernet	NB10W-TW01B

Options

Product item	Specifications	Order code
NB-to-PLC Connecting cable	For NB to PLC via RS-232C (CP/CJ/CS), 2m	XW2Z-200T
	For NB to PLC via RS-232C (CP/CJ/CS), 5m	XW2Z-500T
	For NB to PLC via RS-422A/485, 2m	NB-RSEXT-2M
Software	Supported Operating Systems: Windows 7, Windows Vista®, Windows XP* ¹ (SP1 or higher). Download from the Omron website.	NB-Designer* ²
Display protective sheets	For the NB3Q contains 5 sheets	NB3Q-KBA04
	For the NB5Q contains 5 sheets	NB5Q-KBA04
	For the NB7W contains 5 sheets	NB7W-KBA04
	For the NB10W contains 5 sheets	NB10W-KBA04
Attachment	Mounting bracket for NT31/NT31C series to NB5Q series	NB5Q-ATT01

*¹ Except for Windows XP 64-bit version

*² The NB5Q-TW01B and NB7W-TW01B are supported by NB-Designer version 1.10 or higher.
The NB3Q-TW01_B and NB10W-TW01B are supported by NB-Designer version 1.20 or higher.

Model	Panel cutout (H × V mm)
NB3Q	119.0 (+0.5/-0) × 93.0 (+0.5/-0)
NB5Q	172.4 (+0.5/-0) × 131.0 (+0.5/-0)
NB7W	191.0 (+0.5/-0) × 137.0 (+0.5/-0)
NB10W	258.0 (+0.5/-0) × 200.0 (+0.5/-0)

Note: Applicable panel thickness: 1.6 to 4.8 mm.

Specifications

HMI

Specifications	NB3Q		NB5Q		NB7W		NB10W
	TW00B	TW01B	TW00B	TW01B	TW00B	TW01B	TW01B
Display type	3.5 inch TFT LCD		5.6 inch TFT LCD		7 inch TFT LCD		10.1 inch TFT LCD
Display resolution (HxV)	320x240		320x234		800x480		800x480
Number of colors	65,536						
Backlight	LED						
Backlight lifetime	50,000 hours of operating time at the normal temperature (25°C) ^{*1}						
Touch panel	Analog resistive membrane, resolution 1024x1024, life: 1 million touch operations						
Dimensions in mm (HxWxD)	103.8x129.8x52.8		142x184x46		148x202x46		210.8x268.8x54.0
Weight	310 g max.	315 g max.	620 g max.	625 g max.	710 g max.	715 g max.	1,545 g max.

*1 This is the estimated time when the luminous intensity is decreased by 50% per LED at room temperature and humidity. It is a typical value.

Functionality

Specifications	NB3Q		NB5Q		NB7W		NB10W
	TW00B	TW01B	TW00B	TW01B	TW00B	TW01B	TW01B
Internal memory	128MB (including system area)						
Memory interface	–	USB Memory	–	USB Memory	–	USB Memory	USB Memory
Serial (COM1)	RS-232C/422A/485 (not isolated), Transmission distance: 15m Max. (RS-232C), 500m Max. (RS-422A/485), Connector: D-Sub 9-pin		RS-232C, Transmission distance: 15 m Max., Connector: D-Sub 9-pin				
Serial (COM2)	–		RS-232C/422A/485 (not isolated), Transmission distance: 15m Max. (RS-232C), 500m Max. (RS-422A/485), Connector: D-Sub 9-pin				
USB Host	Equivalent to USB 2.0 full speed, type A, Output power 5V, 150mA						
USB Slave	Equivalent to USB 2.0 full speed, type B, Transmission distance: 5m						
Printer connection	PictBridge support						
Ethernet	–	10/100 base-T	–	10/100 base-T	–	10/100 base-T	10/100 base-T

General

Specifications	NB3Q		NB5Q		NB7W		NB10W
	TW00B	TW01B	TW00B	TW01B	TW00B	TW01B	TW01B
Line voltage	20.4 to 27.6 VDC (24 VDC –15 to 15%)						
Power consumption	5 W	9 W	6 W	10 W	7 W	11 W	14 W
Battery lifetime	5 years (at 25°C)						
Enclosure rating (front side)	Front operation part: IP65 (Dust proof and drip proof only from the front of the panel)						
Obtained standards	EC Directives, KC, cUL508						
Operating environment	No corrosive gases.						
Noise immunity	Compliant with IEC61000-4-4, 2KV (Power cable)						
Ambient operating temperature	0 to 50°C						
Ambient operating humidity	10% to 90% RH (without condensation)						

Applicable Controllers

Brand	Series
OMRON	Omron C Series Host Link
	Omron CJ/CS Series Host Link
	Omron CP Series
Mitsubishi	Mitsubishi Q_QnA (Link Port)
	Mitsubishi FX-485ADP/485BD/422BD (Multi-station)
	Mitsubishi FX0N/1N/2N/3G
	Mitsubishi FX1S
	Mitsubishi FX2N-10GM/20GM
	Mitsubishi FX3U
	Mitsubishi Q series (CPU Port)
	Mitsubishi Q00J (CPU Port)
	Mitsubishi Q06H
Panasonic	FP series
Siemens	Siemens S7-200
	Siemens S7-300/400 (PC Adapter Direct)
Allen-Bradley ^{*1} (Rockwell)	AB DF1 AB CompactLogix/ControlLogix

Brand	Series
Schneider	Schneider Modicon Uni-TelWay
	Schneider Twido Modbus RTU
Delta	Delta DVP
LG (LS)	LS Master-K Cnet
	LS Master-K CPU Direct
	LS Master-K Modbus RTU
	LS XGT CPU Direct
	LS XGT Cnet
GE Fanuc Automation ^{*1}	GE Fanuc Series SNP
	GE SNP-X
Modbus	Modbus ASCII
	Modbus RTU
	Modbus RTU Slave
	Modbus RTU Extend
	Modbus TCP

*1 AB and GE will be supported by NB-Designer version 1.20 or higher.

Note: For details, refer to NB Series Host Connection Manual (Cat.No V108).

HMI with four text lines and 22 F-keys

The NT11 is a Function key HMI with four text lines that can each hold up to 20 characters. It has a parallel printer connection next to a serial port for connection to a PLC. It has a LED backlight that has a life expectancy of at least 50,000 hours.

- Easy programming software.
- Small size and installation depth.
- Customisable F-Keys
- Printer connection.
- Cost effective solution.



Ordering information

Type			Order code
STN monochrome	Ten-key type	Ivory	NT11-SF121-EV1
		Black	NT11-SF121B-EV1

Accessories

Type	Description			Order code
Cables	For screen transfer			XW2Z-S002
	For PLC connection	PT: 9-pin	Cable length: 2 m	XW2Z-200T
		PLC: 9-pin	Cable length: 5 m	XW2Z-500T
		PT: 9-pin PLC: Mini-peripheral	Cable length: 2 m	NT-CN221

Software

Type	Order code
NTST Version 4.8	NTZJCAT1EV4
Upgrade NTST Version 4.8	NTZJCAT1EV4S

Specifications

Size in mm (H×W×D)	113×218×38.2
Effective display area	100×40mm (160×64 pixels)
Line voltage	24 VDC ±15%
Function keys	22 keys
Touch panel	–
Obtained standards	CE, cULus
No. of display characters (standard characters)	20 characters × 4 lines
No. of registered screens	250
Screen data capacity (standard)	32 KB
Expansion memory	–
Memory card interface	–
Printer connection	Supported
Backlight life	50,000 hours average



HMI with two text lines, 6 or 20 F-keys and up to two serial ports

The NT2S is the smallest HMI that we can offer you. It is based on a 16 × 2 lines LCD display with 6 or 20 Function keys. It offers IP65 protection, an optional RTC and printer connection.

- Easy and free programming software.
- Small size and installation depth.
- Real Time Clock (depending on model).
- Printer connection (depending on model).
- Cost effective solution.

Ordering information

Type			Order code
STN monochrome	Programmable	6-key type, Black	NT2S-SF121B-EV2
	PLC controlled		NT2S-SF122B-EV2
	Programmable	20-key type, Black	NT2S-SF123B-EV2
	PLC controlled		NT2S-SF125B-E
			NT2S-SF126B-E
			NT2S-SF127B-E

Accessories

Type	Description	Order code
NT2S-SF121/125 and NT3S	peripheral port CPM series except CPM2C, 2 m	NT2S-CN212-V1
NT2S-SF121/125 and NT3S	peripheral port CPM series except CPM2C, 5 m	NT2S-CN215-V1
NT2S-SF122/SF123/SF126/SF127	peripheral port CPM series except CPM2C, 2 m	NT2S-CN222-V1
NT2S-SF122/SF123/SF126/SF127	peripheral port CPM series except CPM2C, 5 m	NT2S-CN225-V2
NT2S-SF121/125 and NT3S	mini-peripheral port CJ1/CS1 and CPM2C series, 2 m	NT2S-CN223-V2
NT2S-SF122/SF123/SF126/SF127	mini-peripheral port CJ1/CS1 and CPM2C series, 2 m	NT2S-CN224-V1
NT2S-SF121/125 and NT3S	serial port CJ1/CS1/CP1/CPM2/CQM1(H), 2 m	NT2S-CN232-V1
NT2S-SF121/125 and NT3S	serial port CJ1/CS1/CP1/CPM2/CQM1(H), 5 m	NT2S-CN235-V1
NT2S-SF122/SF126	serial port CJ1/CS1/CP1/CPM2/CQM1(H), 2 m	NT2S-CN242-V1
All NT2S and NT3S models	serial programming cable, 2 m	NT2S-CN002

Software

Type	Order code
This software is provided free of charge and features Windows fonts, a Multi language import/export utility, a character map to design your own characters and can be used to place bitmaps in your application.	NTXS











Specifications

Size in mm (H×W×D)	60×109×43 (6 F-keys), 107×107×43 (20 F-keys)
Effective display area	56×11 mm
Line voltage	24 VDC ±10%
Touch panel	–
Obtained standards	CE, cULus
No. of display characters (standard characters)	16 characters x 2 lines
No. of registered screens	65,000 max.
Screen data capacity (standard)	24 KB in Programmable models
Expansion memory	–
Memory card interface	–
Internal memory	1K words data, 1K words retentative memory
Printer connection	Supported
Multi-Vendor support	Supported for several non-Omron PLCs. *1
Backlight life	LED, min. 50,000 hours

*1 Please contact Omron for a list of available drivers.

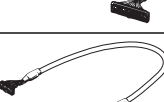
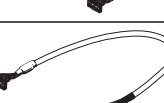
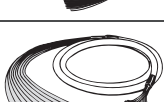
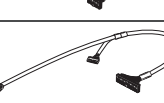
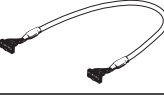
Ordering information

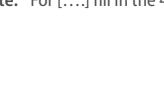
I/O cables

Shape	PLC connection	Terminal connection	Length in cm										Wiring	Order code			
			30	50	75	100	150	200	250	300	400	500					
	FCN24	MIL20	-	■	-	■	-	■	-	■	-	■	-	■	-	Straight	XW2Z-[...]AD-L
		Open ends	-	-	-	■	-	■	-	■	-	■	-	■	-	n. a.	XW2Z-[...]AL-L
	FCN40	MIL20 × 2	-	-	-	■	■	■	-	■	■	■	-	■	Straight	XW2Z-[...]BH-L01	
			Reverse	XW2Z-[...]BH-L02													
		MIL40	-	■	-	■	■	■	-	■	-	■	-	■	Straight	XW2Z-[...]BF-L	
		Open ends	-	-	-	■	-	■	-	■	-	■	-	■	n. a.	XW2Z-[...]BN-L	
	FCN56	MIL20 × 3	-	-	-	-	■	■	-	■	-	-	-	-	Straight	XW2Z-[...]CJ-L01	
			Reverse	XW2Z-[...]CJ-L02													
		MIL20 + MIL40	-	-	-	-	■	■	-	-	-	-	-	-	Straight	XW2Z-[...]CK-L01	
			Reverse	XW2Z-[...]CK-L02													
	MIL60	-	-	-	■	-	■	-	■	-	■	-	■	Straight	XW2Z-[...]CG-L		
	MIL20	MIL20	-	■	-	■	-	■	-	-	-	-	-	Straight	XW2Z-[...]DD-L		
		Open ends	-	■	-	■	■	■	-	■	-	■	-	■	n. a.	XW2Z-[...]DL-L	
		Fork terminals	-	■	-	■	■	■	-	■	-	■	-	■	n. a.	XW2Z-[...]DM-L	
	MIL34	MIL34	-	-	-	-	-	■	-	-	-	-	-	Straight	XW2Z-[...]EE-L		
	MIL40	MIL20 × 2	-	-	■	■	-	■	-	■	-	■	-	■	Reverse	XW2Z-[...]FH-L01	
			Straight	XW2Z-[...]FH-L02													
		MIL40	■	■	-	■	■	■	-	■	-	■	-	■	Straight	XW2Z-[...]FF-L	
	Open ends	-	-	-	■	■	■	■	■	-	■	-	■	n. a.	XW2Z-[...]FN-L		

Note: For [...] fill in the 4-digit length in cm

I/O cables XW2Z

XW2Z-_AD-L

PLC connection	Terminal connection	Wiring	Length in cm (L)									Order code	
			30	50	75	100	150	200	250	300	400		500
24-pin FCN Connector	20-pin MIL Connector	Straight	-	■	-	-	-	-	-	-	-	-	XW2Z-0050AD-L
			-	-	-	■	-	-	-	-	-	-	XW2Z-0100AD-L
			-	-	-	-	-	■	-	-	-	-	XW2Z-0200AD-L
			-	-	-	-	-	-	-	■	-	-	XW2Z-0300AD-L

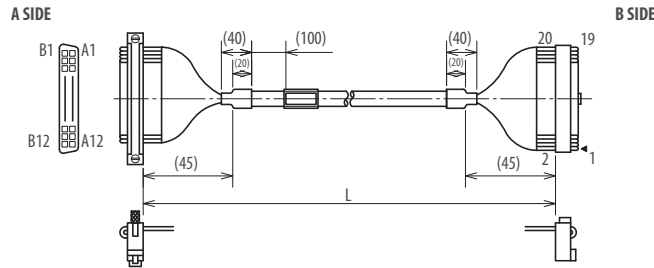

XW2Z-_AL-L

PLC connection	Terminal connection	Wiring	Length in cm (L)									Order code	
			30	50	75	100	150	200	250	300	400		500
24-pin FCN	Loose Wires	Straight	-	-	-	■	-	-	-	-	-	-	XW2Z-0100AL-L
			-	-	-	-	-	■	-	-	-	-	XW2Z-0200AL-L
			-	-	-	-	-	-	-	■	-	-	XW2Z-0300AL-L

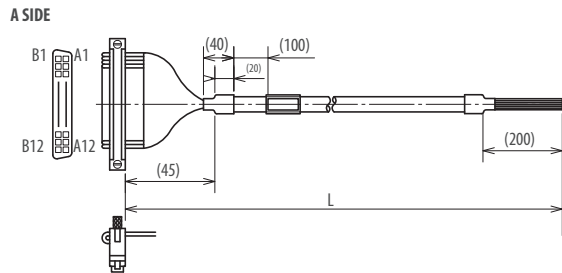

XW2Z-_BH-L01

PLC connection	Terminal connection	Wiring	Length in cm (L1)					Length in cm (L2)					Order code		
			100	150	200	300	400	500	75	125	175	275		375	475
40-pin FCN	Two 20-pin MIL	Straight	■	-	-	-	-	-	■	-	-	-	-	-	XW2Z-0100BH-L01
			-	■	-	-	-	-	-	■	-	-	-	-	XW2Z-0150BH-L01
			-	-	■	-	-	-	-	-	■	-	-	-	XW2Z-0200BH-L01
			-	-	-	■	-	-	-	-	-	■	-	-	XW2Z-0300BH-L01
			-	-	-	-	■	-	-	-	-	-	■	-	XW2Z-0400BH-L01
			-	-	-	-	-	■	-	-	-	-	-	■	XW2Z-0500BH-L01

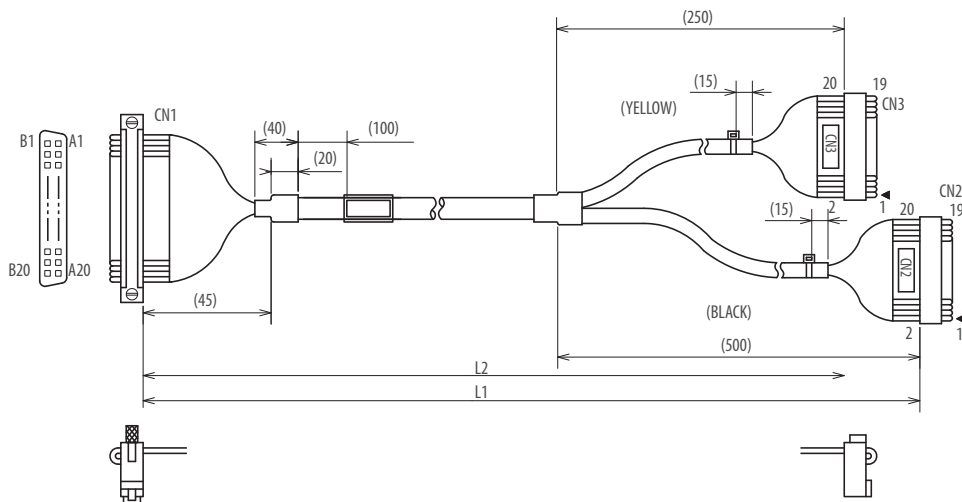

XW2Z-_BH-L02

PLC connection	Terminal connection	Wiring	Length in cm (L1)					Length in cm (L2)					Order code		
			100	150	200	300	400	500	75	125	175	275		375	475
40-pin FCN	Two 20-pin MIL	Reverse	■	-	-	-	-	-	■	-	-	-	-	-	XW2Z-0100BH-L02
			-	■	-	-	-	-	-	■	-	-	-	-	XW2Z-0150BH-L02
			-	-	■	-	-	-	-	-	■	-	-	-	XW2Z-0200BH-L02
			-	-	-	■	-	-	-	-	-	■	-	-	XW2Z-0300BH-L02
			-	-	-	-	■	-	-	-	-	-	■	-	XW2Z-0400BH-L02
			-	-	-	-	-	■	-	-	-	-	-	■	XW2Z-0500BH-L02

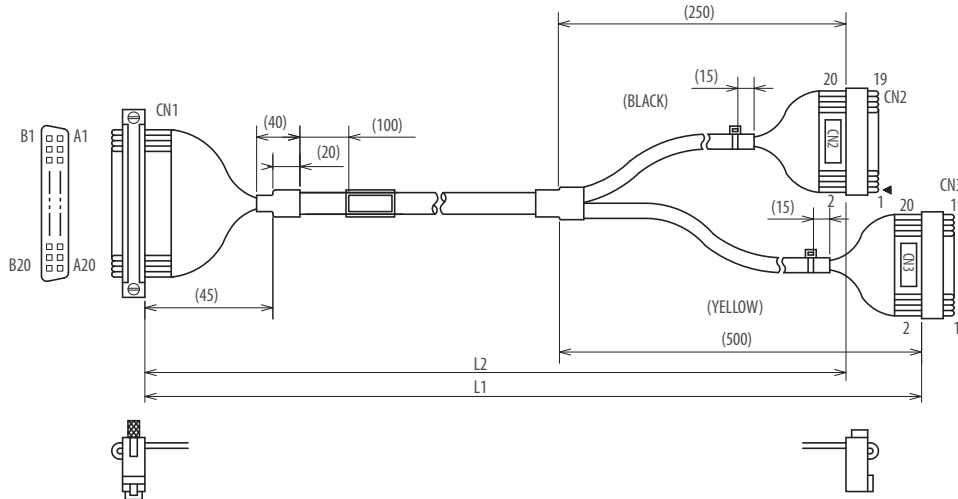

XW2Z-_BF-L

PLC connection	Terminal connection	Wiring	Length in cm (L)								Order code			
			30	50	75	100	150	200	250	300		400	500	
40-pin FCN	40-pin MIL	Straight	-	■	-	-	-	-	-	-	-	-	XW2Z-0050BF-L	
			-	-	■	-	-	-	-	-	-	-	-	XW2Z-0100BF-L
			-	-	-	■	-	-	-	-	-	-	-	XW2Z-0150BF-L
			-	-	-	-	■	-	-	-	-	-	-	XW2Z-0200BF-L
			-	-	-	-	-	-	■	-	-	-	-	XW2Z-0300BF-L
			-	-	-	-	-	-	-	■	-	-	-	XW2Z-0500BF-L

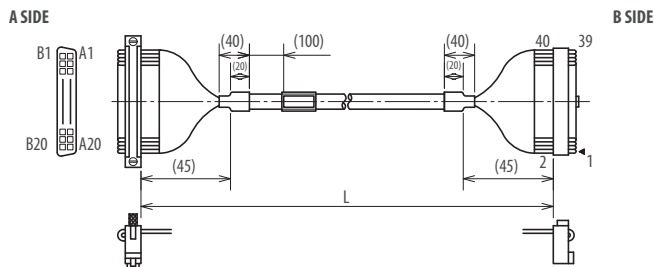

XW2Z-_BN-L

PLC connection	Terminal connection	Wiring	Length in cm (L)								Order code			
			30	50	75	100	150	200	250	300		400	500	
40-pin FCN	Loose Wires	Straight	-	-	-	■	-	-	-	-	-	-	XW2Z-0100BN-L	
			-	-	-	-	■	-	-	-	-	-	-	XW2Z-0200BN-L
			-	-	-	-	-	-	■	-	-	-	-	XW2Z-0300BN-L
			-	-	-	-	-	-	-	-	■	-	-	XW2Z-0500BN-L

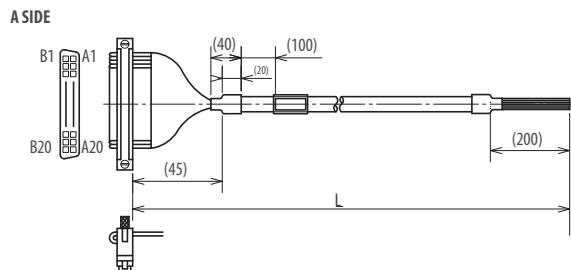

XW2Z-_CJ-L01

PLC connection	Terminal connection	Wiring	Length in cm (L1)					Length in cm (L2)					Order code		
			100	150	200	300	400	500	75	125	175	275		375	475
56-pin FCN	Three 20-pin MIL	Straight	-	■	-	-	-	-	-	■	-	-	-	-	XW2Z-0150CJ-L01
			-	-	■	-	-	-	-	-	■	-	-	-	XW2Z-0200CJ-L01
			-	-	-	■	-	-	-	-	-	■	-	-	XW2Z-0300CJ-L01

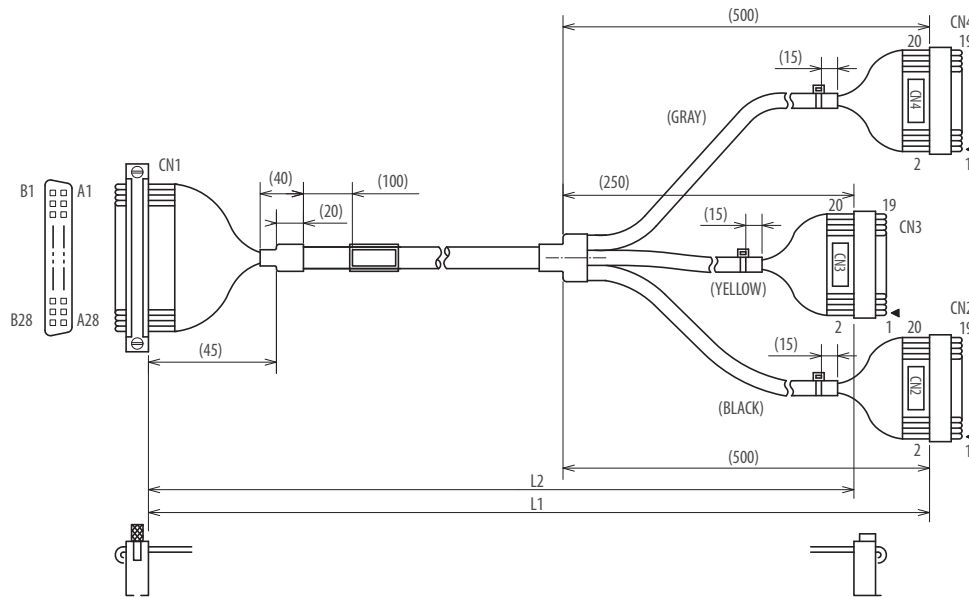

XW2Z-_CJ-L02

PLC connection	Terminal connection	Wiring	Length in cm (L1)					Length in cm (L2)					Length in cm (L3)					Order code			
			100	150	200	300	400	500	75	125	175	275	375	475	50	100	150		250	300	
56-pin FCN	Three 20-pin MIL	Reverse	-	■	-	-	-	-	-	■	-	-	-	-	-	■	-	-	-	XW2Z-0150CJ-L02	
			-	-	■	-	-	-	-	-	■	-	-	-	-	-	■	-	-	-	XW2Z-0200CJ-L02
			-	-	-	■	-	-	-	-	-	■	-	-	-	-	-	■	-	-	XW2Z-0300CJ-L02

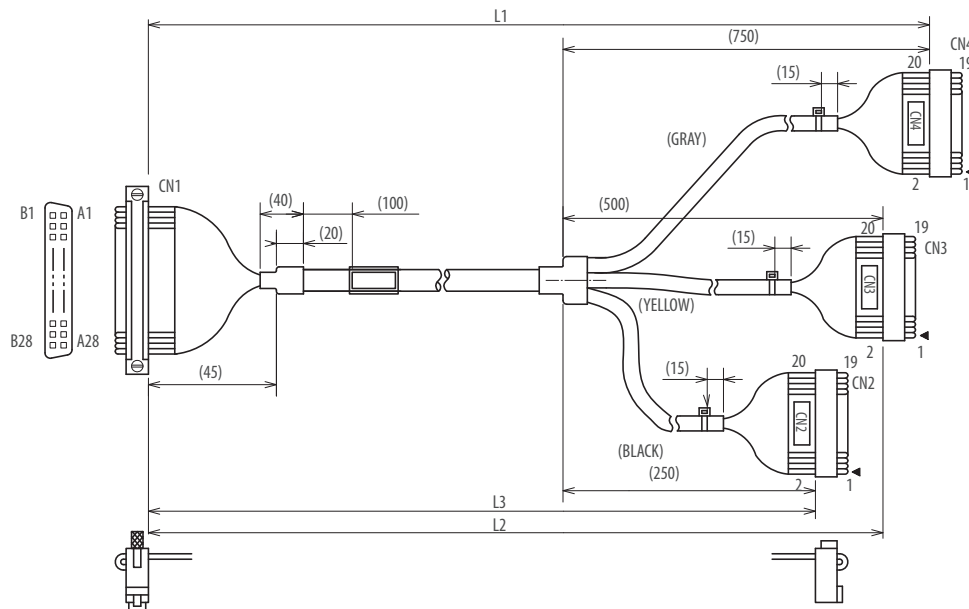

XW2Z-CK-L0

PLC connection	Terminal connection	Wiring	Length in cm (L1)					Length in cm (L2)					Order code	
			100	150	200	300	400	500	75	125	175	275		375
56-pin	40-pin MIL	Straight	-	■	-	-	-	-	■	-	-	-	-	XW2Z-0150CK-L01
		Reverse	-	■	-	-	-	-	■	-	-	-	-	XW2Z-0150CK-L02
		Straight	-	-	■	-	-	-	-	-	■	-	-	XW2Z-0200CK-L01
		Reverse	-	-	■	-	-	-	-	-	■	-	-	XW2Z-0200CK-L02

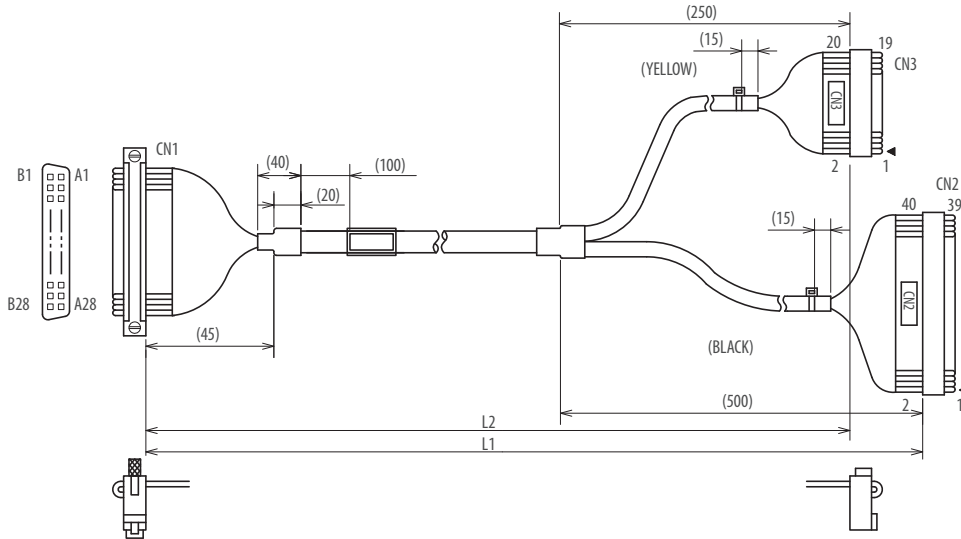

XW2Z-CG-L

PLC connection	Terminal connection	Wiring	Length in cm (L)										Order code	
			30	50	75	100	150	200	250	300	400	500		
56-pin FCN	60-pin MIL	Straight	-	-	-	■	-	-	-	-	-	-	-	XW2Z-0100CG-L
			-	-	-	-	-	■	-	-	-	-	-	XW2Z-0200CG-L
			-	-	-	-	-	-	-	■	-	-	-	XW2Z-0300CG-L

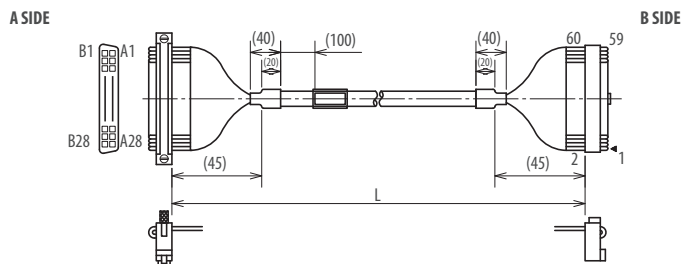

XW2Z-DD-L

PLC connection	Terminal connection	Wiring	Length in cm (L)										Order code	
			30	50	75	100	150	200	250	300	400	500		
20-pin MIL	20-pin MIL	Straight	-	■	-	-	-	-	-	-	-	-	-	XW2Z-0050DD-L
			-	-	-	■	-	-	-	-	-	-	-	XW2Z-0100DD-L
			-	-	-	-	-	■	-	-	-	-	-	XW2Z-0200DD-L

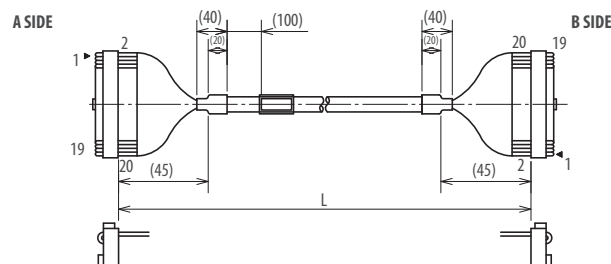

XW2Z-_DL-L

PLC connection	Terminal connection	Wiring	Length in cm (L1)								Order code		
			30	50	75	100	150	200	250	300		400	500
20-pin MIL	Loose Wires	Straight	-	■	-	-	-	-	-	-	-	-	XW2Z-0050DL-L
			-	-	-	■	-	-	-	-	-	-	XW2Z-0100DL-L
			-	-	-	-	■	-	-	-	-	-	XW2Z-0150DL-L
			-	-	-	-	-	■	-	-	-	-	XW2Z-0200DL-L
			-	-	-	-	-	-	■	-	-	-	XW2Z-0300DL-L
			-	-	-	-	-	-	-	■	-	-	XW2Z-0500DL-L

A SIDE

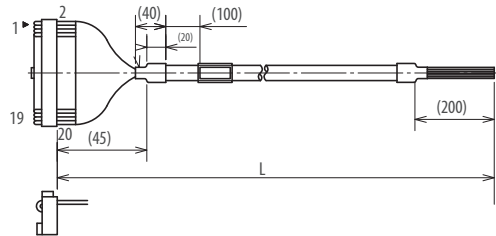

XW2Z-_DM-L

PLC connection	Terminal connection	Wiring	Length in cm (L1)								Order code		
			30	50	75	100	150	200	250	300		400	500
20-pin MIL	Loose Wires with Fork Terminals	Straight	-	■	-	-	-	-	-	-	-	-	XW2Z-0050DM-L
			-	-	-	■	-	-	-	-	-	-	XW2Z-0100DM-L
			-	-	-	-	■	-	-	-	-	-	XW2Z-0150DM-L
			-	-	-	-	-	■	-	-	-	-	XW2Z-0200DM-L
			-	-	-	-	-	-	■	-	-	-	XW2Z-0300DM-L
			-	-	-	-	-	-	-	■	-	-	XW2Z-0500DM-L

A SIDE

B SIDE

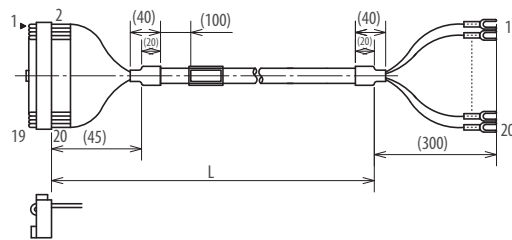

XW2Z-0200EE-L

PLC connection	Terminal connection	Wiring	Length in cm (L1)								Order code		
			30	50	75	100	150	200	250	300		400	500
34-pin MIL	34-pin MIL	Straight	-	-	-	-	-	■	-	-	-	-	XW2Z-0200EE-L

A SIDE

B SIDE

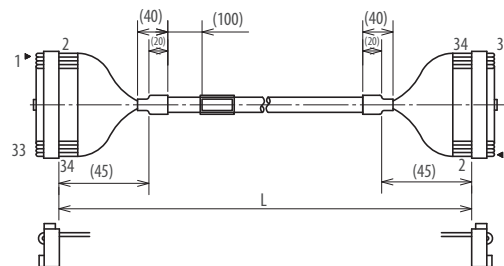

XW2Z-_FH-L01

PLC connection	Terminal connection	Wiring	Length in cm (L1)					Length in cm (L2)					Order code			
			75	100	200	300	400	500	50	75	175	275		375	475	
40-pin MIL	Two 20-pin MIL	Reverse	■	-	-	-	-	-	■	-	-	-	-	-	XW2Z-0075FH-L01	
			-	■	-	-	-	-	-	■	-	-	-	-	XW2Z-0100FH-L01	
			-	-	■	-	-	-	-	-	-	■	-	-	-	XW2Z-0200FH-L01
			-	-	-	■	-	-	-	-	-	-	■	-	-	XW2Z-0300FH-L01
			-	-	-	-	-	■	-	-	-	-	-	-	■	XW2Z-0500FH-L01

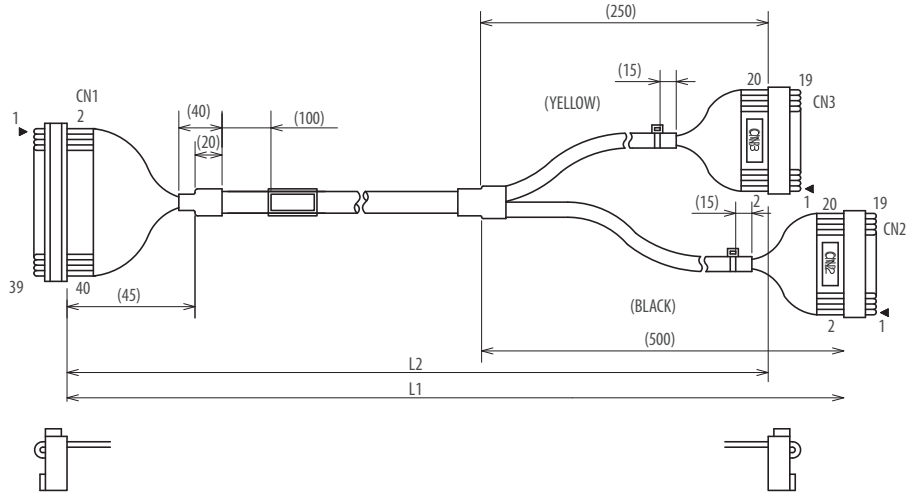

XW2Z-_FH-L02

PLC connection	Terminal connection	Wiring	Length in cm (L1)					Length in cm (L2)					Order code			
			75	100	200	300	400	500	50	75	175	275		375	475	
40-pin MIL	Two 20-pin MIL	Straight	■	-	-	-	-	-	■	-	-	-	-	-	XW2Z-0075FH-L02	
			-	■	-	-	-	-	-	■	-	-	-	-	XW2Z-0100FH-L02	
			-	-	■	-	-	-	-	-	-	■	-	-	-	XW2Z-0200FH-L02
			-	-	-	■	-	-	-	-	-	-	■	-	-	XW2Z-0300FH-L02
			-	-	-	-	-	■	-	-	-	-	-	-	■	XW2Z-0500FH-L02

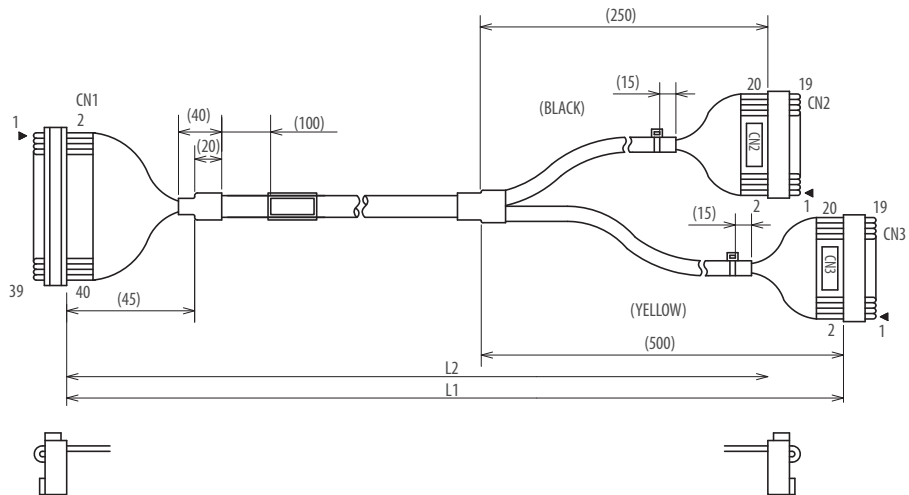

XW2Z-_FF-L

PLC connection	Terminal connection	Wiring	Length in cm (L1)								Order code			
			30	50	75	100	150	200	250	300		400	500	
40-pin MIL	40-pin MIL	Straight	■		-	-	-	-	-	-	-	-	XW2Z-0030FF-L	
			-	■	-	-	-	-	-	-	-	-	XW2Z-0050FF-L	
			-	-	-	■	-	-	-	-	-	-	-	XW2Z-0100FF-L
			-	-	-	-	■	-	-	-	-	-	-	XW2Z-0150FF-L
			-	-	-	-	-	■	-	-	-	-	-	XW2Z-0200FF-L
			-	-	-	-	-	-	■	-	-	-	-	XW2Z-0300FF-L
-	-	-	-	-	-	-	-	■	-	-	-	XW2Z-0500FF-L		

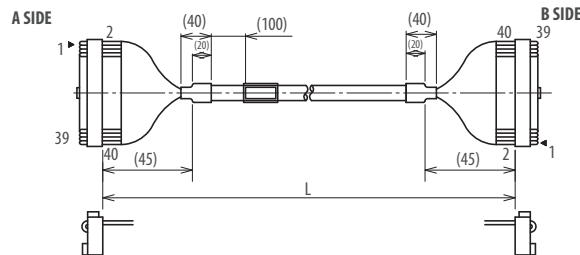

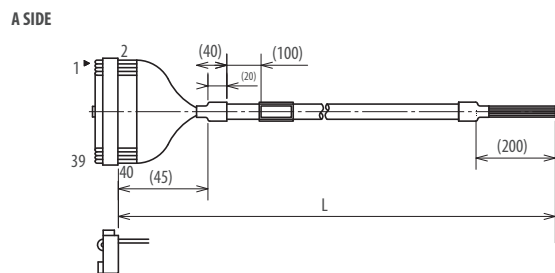

XW2Z-_FN-L

PLC connection	Terminal connection	Wiring	Length in cm (L1)								Order code			
			30	50	75	100	150	200	250	300		400	500	
40-pin MIL	Loose Wires	Straight	-	-	-	■	-	-	-	-	-	-	XW2Z-0100FN-L	
			-	-	-	-	■	-	-	-	-	-	XW2Z-0150FN-L	
			-	-	-	-	-	■	-	-	-	-	XW2Z-0200FN-L	
			-	-	-	-	-	-	■	-	-	-	XW2Z-0250FN-L	
			-	-	-	-	-	-	-	■	-	-	-	XW2Z-0300FN-L
			-	-	-	-	-	-	-	-	■	-	-	XW2Z-0500FN-L





I/O terminal blocks





General purpose I/O terminals

Shape	Connection type	Number of points	Order code
	Push-in	20 pt	XW2R-P20G-T
		34 pt	XW2R-P34G-T
		40 pt	XW2R-P40G-T
		50 pt	XW2R-P50G-T
		60 pt	XW2R-P60G-T
	Clamp	20 pt	XW2R-E20G-T
		34 pt	XW2R-E34G-T
		40 pt	XW2R-E40G-T
		50 pt	XW2R-E50G-T
		60 pt	XW2R-E60G-T
	Screw	20 pt	XW2R-J20G-T
		34 pt	XW2R-J34G-T
		40 pt	XW2R-J40G-T
		50 pt	XW2R-J50G-T
		60 pt	XW2R-J60G-T

Omron PLC I/O terminals





Shape	Connection type	I/O unit type	Order code
	Push-in	32 inputs Fujitsu (FCN)	XW2R-P34G-C1
		32 inputs MIL	XW2R-P34G-C2
		32 outputs Fujitsu (FCN)	XW2R-P34G-C3
		32 outputs MIL	XW2R-P34G-C4
	Clamp	32 inputs Fujitsu (FCN)	XW2R-E34G-C1
		32 inputs MIL	XW2R-E34G-C2
		32 outputs Fujitsu (FCN)	XW2R-E34G-C3
		32 outputs MIL	XW2R-E34G-C4
	Screw	32 inputs Fujitsu (FCN)	XW2R-J34G-C1
		32 inputs MIL	XW2R-J34G-C2
		32 outputs Fujitsu (FCN)	XW2R-J34G-C3
		32 outputs MIL	XW2R-J34G-C4

Ethernet patch cables, standard RJ45 connectors

Shape	Connector 1	Connector 2	Material	Cable	Color	Length in cm										Order code					
						20	30	50	100	150	200	300	500	750	1000		1500	2000			
	RJ45 std.	RJ45 std.	LSZH	Cat6a S/FTP 4 pairs	Blue	■	■	■	■	■	■	■	■	■	■	■	■	■	■	■	XS6W-6LSZH8SS[...]CM-B
	RJ45 std.	RJ45 std.	LSZH	Cat6a S/FTP 4 pairs	Yellow	■	■	■	■	■	■	■	■	■	■	■	■	■	■	■	XS6W-6LSZH8SS[...]CM-Y
	RJ45 std.	RJ45 std.	LSZH	Cat6a S/FTP 4 pairs	Green	■	■	■	■	■	■	■	■	■	■	■	■	■	■	■	XS6W-6LSZH8SS[...]CM-G
	RJ45 std.	RJ45 std.	PUR	Cat5e S/FTP 4 pairs	Green	-	-	■	■	■	■	■	■	■	■	■	■	■	■	■	XS6W-5PUR8SS[...]CM-G

Note: For [...] fill in the length in cm.

Ethernet patch cables, RJ45/M12 connectors





Shape	Connector 1	Connector 2	Material	Cable	Color	Length in cm								Order code
						30	50	100	200	300	500	1000	1500	
	RJ45	RJ45	PVC	Cat5e Shielded Quad	Light Blue	A	B	C	D	E	G	J	K	XS5W-T421-[]JMD-K
	M12 straight	M12 straight	PVC	Cat5e Shielded Quad	Light Blue	-	B	C	D	E	G	J	K	XS5W-T421-[]JM2-K
	M12 straight	RJ45	PVC	Cat5e Shielded Quad	Light Blue	A	B	C	D	E	G	J	K	XS5W-T421-[]JMC-K
	M12 angled	M12 angled	PVC	Cat5e Shielded Quad	Light Blue	-	B	C	D	E	G	J	K	XS5W-T422-[]JM2-K
	M12 angled	RJ45	PVC	Cat5e Shielded Quad	Light Blue	A	B	C	D	E	G	J	K	XS5W-T422-[]JMC-K

Note: For [] fill in the 1-character length code.



Specifications

Item	XS6W-6LSZH8SS_CM-	XS6W-5PUR8SS_CM-G
Rated current	1 A (at 50°C)	
Withstand voltage	1,000 VDC for 60 s (leakage current: 1 mA max.)	
Ambient operating temperature	-20 to 60°C	-40 to 85°C
Ambient storage temperature	-20 to 60°C	-40 to 85°C
Ambient installation temperature	0 to 50°C	-10 to 60°C
Protective structure	IP20	IP20



Accessories

Type	Connector	Specification	Color	Length	Order code
Ethernet installation cable 	none	CAT 5, SF/UTP, 4 × 2 × AWG 24/1 (solid core), Polyurethane (PUR)	Green	100 m	WM IE-5IC4x2xAWG24/1-PUR
Ethernet installation cable 	none	CAT 5, SF/UTP, 4 × 2 × AWG 26/7 (stranded core), Polyurethane (PUR)		100 m	WM IE-5CC4x2xAWG26/7-PUR
Ethernet socket 	RJ45 socket	DIN-rail mount socket to terminate installation cable in the cabinet	Grey	60 × 17.5 × 67 mm	WM IE-TO-RJ45-FJ-B
Ethernet field-mount plugs 	Metal RJ45	for AWG22 to AWG26	Chrome	52 mm	WM IE-PS-RJ45-FH-BK
Ethernet field-mount plugs 	Plastic RJ45	for AWG22 to AWG24	Black	52 mm	XS6G-T421-1

Industrial switching hubs

Shape	Functions	Ports	Failure detection	Power supply voltage	Order code
	Quality of Service (QoS): EtherNet/IP control data priority Failure detection: Broadcast storm and LSI error detection 10/100BASE-TX, Auto-negotiation	3	—	24.0 VDC±5%	W4S1-03B
		5			W4S1-05B
			■		W4S1-05C

EtherCAT junction slave

Shape	Functions	Ports	Power supply voltage	Order code
	Creation of star- and tree topologies in EtherCAT networks. Distributed Clock (DC) is supported.	3	20.4 to 28.8 VDC (24 VDC –15% to 20%)	GX-JC03
		6		GX-JC06



Industrial Wireless LAN unit

WE70 utilises spread-spectrum modulation technology based on radio waves to enable communication between devices in a limited area. This gives users the mobility to move around within a broad coverage area and still be connected to the network. The smart roaming function enables high speed roaming therefore moving equipment and mobile objects can communicate reliably at high speed.

- Conforms to IEEE 802.11a/b/g.
- Same noise and environment resistance level as a PLC.
- Features Omron's original security system.
- Signals can be observed with LED indicators.
- Conforms to radio wave standards for the USA, Europe, and China.

Ordering information

Area	Type	Order code
Europe	Access Point (Master)	WE70-AP-EU
	Client (Slave)	WE70-CL-EU
USA	Access Point (Master)	WE70-AP-US
	Client (Slave)	WE70-CL-US
China	Access Point (Master)	WE70-AP-CN
	Client (Slave)	WE70-CL-CN

Accessories

Type	Specifications	Order code
Directional Magnetic-base Antenna	1 set with two Antennas, 2.4 GHz/5 GHz Dual-band compatible	WE70-AT001H

Type	Order code
DIN Rail Mounting Bracket (for TH35 7.5)	WT30-FT001
DIN Rail Mounting Bracket (for TH35 15)	WT30-FT002
Antenna Extension Cable (5 m)	WE70-CA5M

Note: For Ethernet Cables and Accessories, see page 81

Motion & Drives

Find information fast!

Quick Links shortens your search. Quick Links are unique codes assigned to Omron products listed in this guide. Enter Quick Link codes in the search box on industrial.omron.eu to access detailed information on products in this guide.

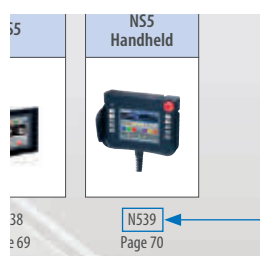

Quick Link

Motion & Drives

Motion controllers

Product overview	86
Selection table	89
Machine controller	
NJ-Series	14
Control via EtherCAT	
Trajexia stand-alone	90
CJ1W-NC_8_	95
Control via interface	
Trajexia 2.5 axes motion controller	93
Control via MECHATROLINK-II	
Trajexia stand-alone	90
Trajexia-PLC CJ1W-MC472/MCH72	97
CJ1W-NC_71	99
Control via pulses	
CJ1W-NC_3	100
CJ1W-NC_4	101

Servo systems

Product overview	102
Selection table	104
Servo drives	
Accurax G5	106
G-Series	114
SmartStep 2	120
Rotary servo motors	
Accurax G5	125
G-Series	141

Frequency inverters

Product overview	150
Selection table	153
Frequency inverters	
RX	154
MX2	160
JX	166
LX	150
SX (400 V)	151
SX (690 V)	151

Motion controllers

NJ-Series Machine Controller

- Integration of logic and motion in one Intel CPU
- Scalable control: CPUs for 4, 8, 16, 32 and 64 axes
- EtherCAT and EtherNet/IP ports embedded
- Linear, circular and spiral (helical) interpolation



SYSTMAC
always in control

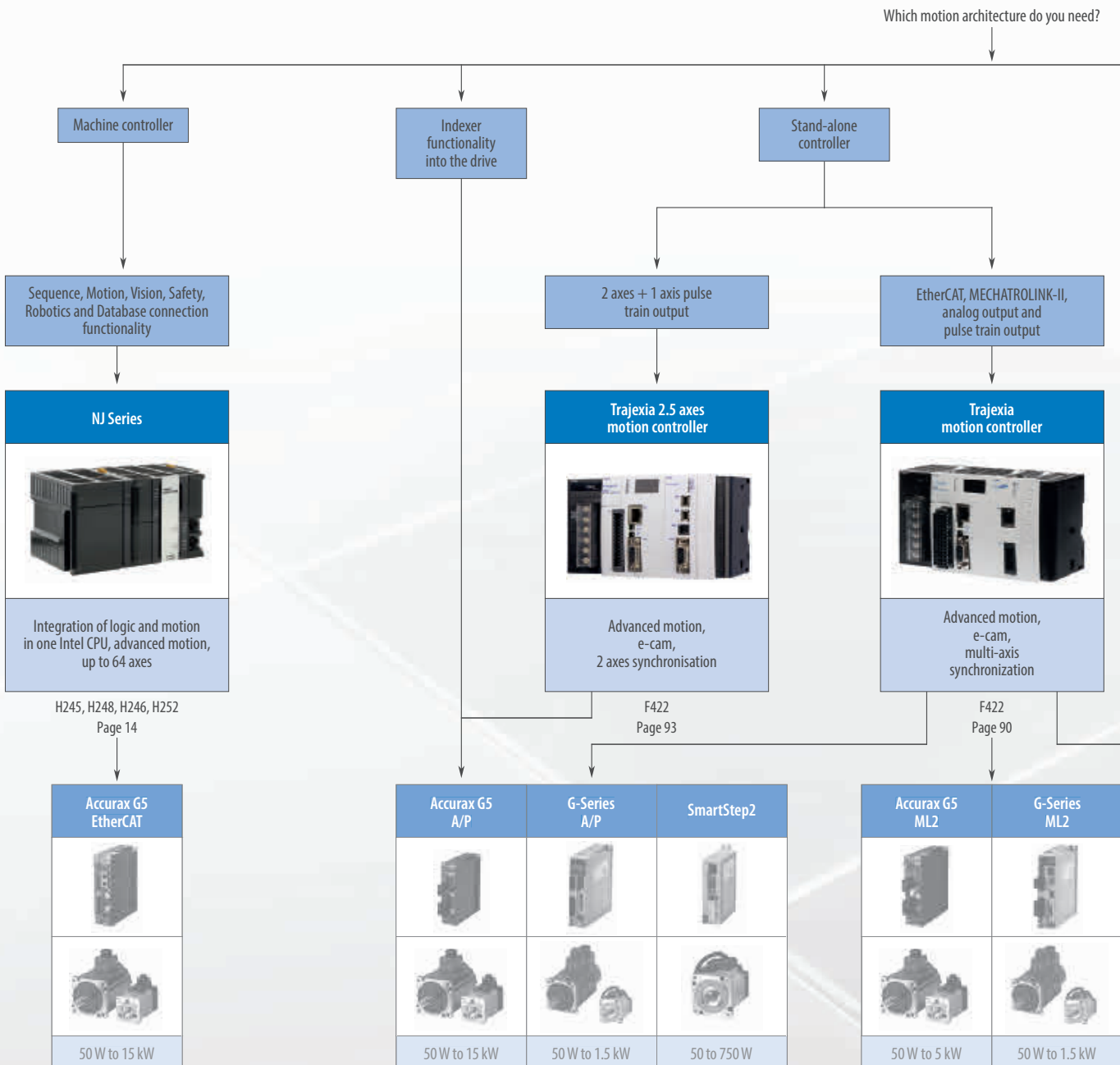

Trajexia with EtherCAT

- Perfect control of 64 axes
- Scalability with EtherCAT masters for 4, 16 and 64 axes
- Supports servos, inverters, vision systems and distributed I/O modules



EtherCAT®

CJ-Series PLC with EtherCAT





- Position control unit CJ1W-NC with EtherCAT
- Support for up to 16 axes and 64 inverters, vision systems and distributed I/O modules



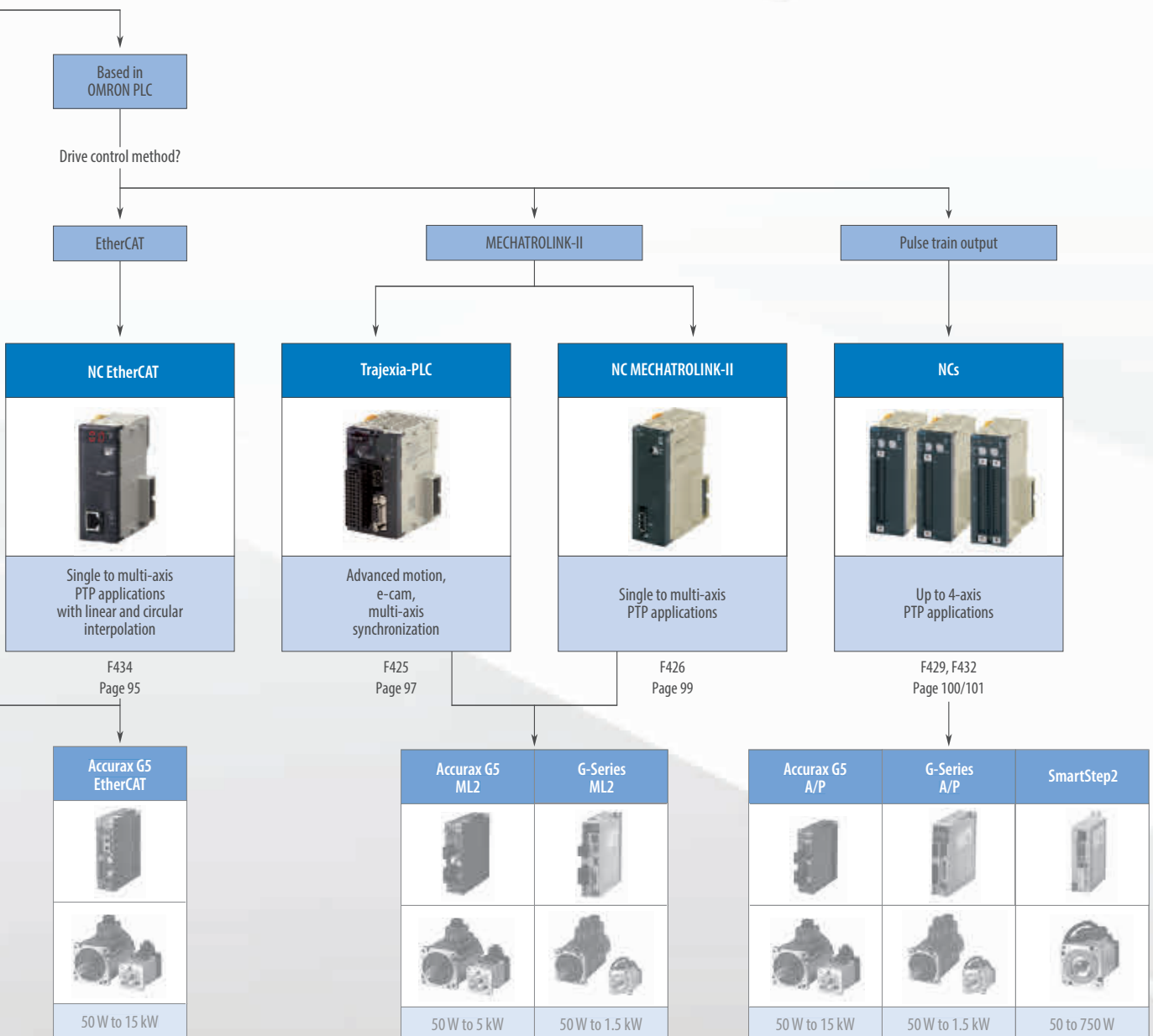



EtherCAT®

Motion controllers



Motion controllers				
				
Model	NJ Series machine controller	Trajexia stand-alone	Trajexia 2.5 axes motion controller	NC EtherCAT
Sequence, Motion, Robotics and Database connection functionality	Sequence, Motion, Robotics and Database connection functionality	The advanced stand-alone motion controller	Trajexia 2.5 axes motion controller	16-axis point-to-point positioning controller
Axes control method	EtherCAT	EtherCAT, MECHATROLINK-II, analog output and pulse-train output	2 axes for position, speed and torque control and 1 axis for pulse train output in open loop	EtherCAT
Number of axes	4, 8, 16, 32, 64	4, 16, 64	2	2, 4, 8, 16
Applicable servo drive	Accurax G5	Accurax G5 and G-Series	Accurax-G5	Accurax G5
Application	Advance motion including robotics	Advanced motion, e-cam, ELS, Phase shift, Registration	Advanced motion, e-cam, ELS, Phase shift, Registration	From simple PTP to multi axis PTP with linear and circular interpolation
Servo control mode	Position, speed and torque	Position, speed and torque	Position, speed and torque	Position, speed and torque
PLC series	NJ Series machine controller	Stand-alone motion controller: Serial and Ethernet/IP built-in, PROFIBUS-DP, DeviceNet and CANopen communication options	Stand-alone motion controller: Serial and EtherNet/IP built-in, PROFIBUS-DP, DeviceNet and CANopen communication options	CJ
Page/Quick Link	14	90	93	95

Motion controllers				
				
Model	Trajexia-PLC	NC MECHATROLINK-II	CJ1W-NC_3	CJ1W-NC_4
Advanced multi-axes motion controller in a PLC	Advanced multi-axes motion controller in a PLC	16-axis point-to-point positioning controller	4-axis point-to-point positioning controller	4-axis point-to-point positioning controller with synchronization
Axes control method	MECHATROLINK-II	MECHATROLINK-II	Pulse train output	Pulse train output
Number of axes	4, 30	2, 4, 16	1, 2, 4	2, 4
Applicable servo drive	Accurax G5 and G-Series	Accurax G5 and G-Series	SmartStep 2 and Accurax G5	SmartStep 2 and Accurax G5
Application	Advanced motion, e-cam, ELS, Phase shift, Registration	From simple PTP to multi axis PTP coordinated systems	Point to point applications	Point-to-point with complex interpolations
Servo control mode	Position, speed and torque	Position, speed and torque	Open loop position with linear interpolation	Open loop position with linear and circular interpolation
PLC series	CJ	CJ and CS1	CJ an CS1	CJ
Page/Quick Link	97	99	100	101



Stand-alone advanced motion controller over EtherCAT

- Perfect motion control of up to 64 axes. Scalability with EtherCAT masters for 4, 16 and 64 axes
- Supports position, speed and torque control
- Multi-tasking controller capable of running up to 22 tasks simultaneously
- Advanced motion control such as linear, circular, helical or spherical interpolation, electronic cams and gearboxes via simple motion commands
- Control of servos, inverters, vision systems and distributed I/Os over a single EtherCAT network
- Support for EtherNet/IP communications
- Advanced debugging tools including data trace and oscilloscope functions
- Open communication: Serial and EtherNet/IP built-in, PROFIBUS-DP, DeviceNet and CANopen

Ordering information

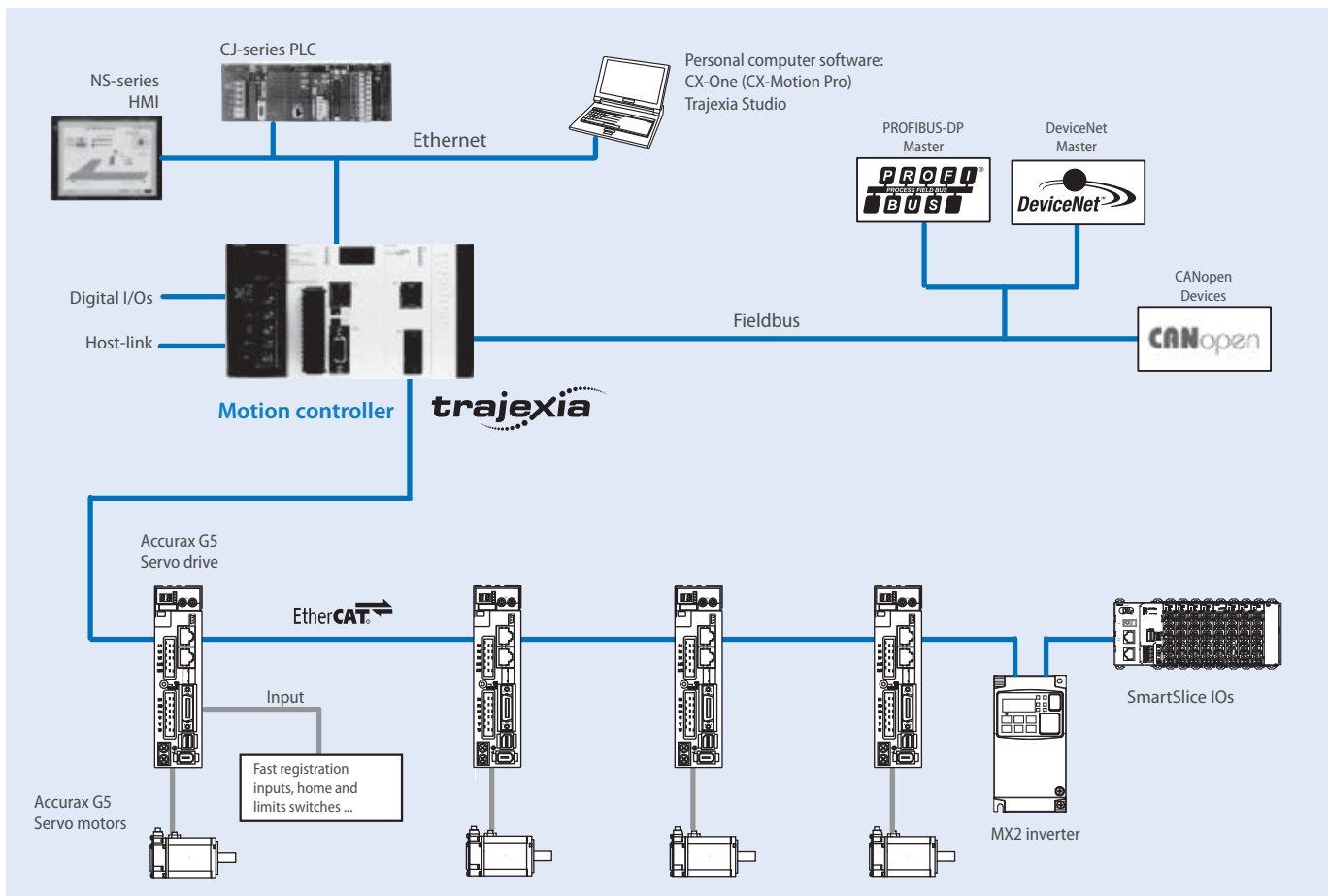

Trajexia motion controller

Name	Order code
Trajexia motion controller Unit, up to 64 axes. (Trajexia end cover unit TJ1-TER is included)	TJ2-MC64
Trajexia motion controller unit, up to 16 axes. (Trajexia end cover unit TJ1-TER is included)	TJ1-MC16
Trajexia motion controller unit, up to 4 axes. (Trajexia end cover unit TJ1-TER is included)	TJ1-MC04
Power supply for Trajexia system, 100 to 240 VAC	CJ1W-PA202
Power supply for Trajexia system, 24 VDC	CJ1W-PD022

Trajexia – axes control modules

Name	Order code
Trajexia EtherCAT master unit (up to 64 servo drives) ^{*1}	TJ2-ECT64
Trajexia EtherCAT master unit (up to 16 servo drives)	TJ2-ECT16
Trajexia EtherCAT master unit (up to 4 servo drives)	TJ2-ECT04
Trajexia MECHATROLINK-II master unit (up to 16 stations) ^{*2}	TJ1-ML16
Trajexia MECHATROLINK-II master unit (up to 4 stations) ^{*2}	TJ1-ML04
Trajexia flexible axis unit (for 2 stations)	TJ1-FL02

^{*1} The number of servo drives is currently limited to 32 when using TJ2-MC64 motion controller with firmware 2.0132.

^{*2} The TJ1-ML04 and TJ1-ML16 supported by the TJ2-MC64 motion controller are V2 (Version 2) and lot number equal or above Lot. No.091019 (YYMMDD).

Trajexia – communication modules

Name	Order code
Trajexia DeviceNet slave unit	TJ1-DRT
Trajexia PROFIBUS-DP slave unit	TJ1-PRT
Trajexia CANOpen unit	TJ1-CORT

EtherCAT – related devices

Servo system and frequency inverters

Name	Order code	
Accurax G5 servo drive EtherCAT built-in	R88D-KN____-ECT	
MX2 inverter with EtherCAT option board	Frequency inverter	3G3MX2-A_
	EtherCAT option board	3G3AX-MX2-ECT

Note: Refer to servo systems and frequency inverter sections for detailed specs and ordering information

SmartSlice IOs system

Function	Specification	Order code
SmartSlice Interface unit	SmartSlice EtherCAT interface unit	GRT1-ECT
End plate, one unit required per bus interface		GRT1-END
4 NPN inputs	24 VDC, 6 mA, 3-wire connection	GRT1-ID4
4 PNP inputs	24 VDC, 6 mA, 3-wire connection	GRT1-ID4-1
8 NPN inputs	24 VDC, 4 mA, 1-wire connection + 4xG	GRT1-ID8
8 PNP inputs	24 VDC, 4 mA, 1-wire connection + 4xV	GRT1-ID8-1
4 AC inputs	110 VAC, 2-wire connection	GRT1-IA4-1
4 AC inputs	230 VAC, 2-wire connection	GRT1-IA4-2
4 NPN outputs	24 VDC, 500 mA, 2-wire connection	GRT1-OD4
4 PNP outputs	24 VDC, 500 mA, 2-wire connection	GRT1-OD4-1
4 PNP outputs with short-circuit protection	24 VDC, 500 mA, 3-wire connection	GRT1-OD4G-1
4 PNP outputs with short-circuit protection	24 VDC, 2 A, 2-wire connection	GRT1-OD4G-3
8 NPN outputs	24 VDC, 500 mA, 1-wire connection + 4xV	GRT1-OD8
8 PNP outputs	24 VDC, 500 mA, 1-wire connection + 4xG	GRT1-OD8-1
8 PNP outputs with short-circuit protection	24 VDC, 500 mA, 1-wire connection + 4xG	GRT1-OD8G-1
2 relay outputs	240 VAC, 2 A, normally-open contacts	GRT1-ROS2
2 analog inputs, current/voltage	±10 V, 0 to 10 V, 0 to 5 V, 1 to 5 V, 0 to 20 mA, 4 to 20 mA	GRT1-AD2
2 analog outputs, voltage	±10 V, 0 to 10 V, 0 to 5 V, 1 to 5 V	GRT1-DA2V
2 analog outputs, current	0 to 20 mA, 4 to 20 mA	GRT1-DA2C
2 Pt100 inputs	Pt100, 2-wire or 3-wire connection	GRT1-TS2P
2 Pt1000 inputs	Pt1000, 2-wire or 3-wire connection	GRT1-TS2K
2 Thermocouple inputs	Types B, E, J, K, N, R, S, T, U, W, PL2, with cold junction compensation	GRT1-TS2T

Note: Refer to Automation systems catalogue for detailed specs and accessories information

GX-Series I/O Blocks

Name	Specification	Order code
16 NPN inputs	24 VDC, 6 mA, 1-wire connection, expandable	GX-ID1611
16 PNP inputs	24 VDC, 6 mA, 1-wire connection, expandable	GX-ID1621
16 NPN outputs	24 VDC, 500 mA, 1-wire connection, expandable	GX-OD1611
16 PNP outputs	24 VDC, 500 mA, 1-wire connection, expandable	GX-OD1621
8 inputs and 8 outputs, NPN	24 VDC, 6 mA input, 500 mA output, 1-wire connection	GX-MD1611
8 inputs and 8 outputs, PNP	24 VDC, 6 mA input, 500 mA output, 1-wire connection	GX-MD1621
16 NPN inputs	24 VDC, 6 mA, 3-wire connection	GX-ID1612
16 PNP inputs	24 VDC, 6 mA, 3-wire connection	GX-ID1622
16 NPN outputs	24 VDC, 500 mA, 3-wire connection	GX-OD1612
16 PNP outputs	24 VDC, 500 mA, 3-wire connection	GX-OD1622
8 inputs and 8 outputs, NPN	24 VDC, 6 mA input, 500 mA output, 3-wire connection	GX-MD1612
8 inputs and 8 outputs, PNP	24 VDC, 6 mA input, 500 mA output, 3-wire connection	GX-MD1622
16 relay outputs	250 VAC, 2 A, 1-wire connection, expandable	GX-OC1601
4 analog inputs, current/voltage	±10 V, 0 to 10 V, 0 to 5 V, 1 to 5 V, 4 to 20 mA	GX-AD0471
2 analog outputs, current/voltage	±10 V, 0 to 10 V, 0 to 5 V, 1 to 5 V, 4 to 20 mA	GX-DA0271
2 encoder open collector inputs	500 kHz Open collector input	GX-EC0211
2 encoder line-driver inputs	4 MHz Line driver input	GX-EC0241

Note: The GX-Series I/O blocks are only supported by the T2-MC64 motion controller and with official firmware release above 2.0132.

Vision system

Name	Specification	Order code
Vision system with EtherCAT interface	NPN	FZM1-350-ECT
	PNP	FZM1-355-ECT
Smart camera with EtherCAT interface	NPN/Color camera	FQ-MS120-ECT
	NPN/Monochrome camera	FQ-MS120-M-ECT
	PNP/Color camera	FQ-MS125-ECT
	PNP/Monochrome camera	FQ-MS125-M-ECT

Note: The vision systems are only supported by the T2-MC64 motion controller and with official firmware release above 2.0132.

MECHATROLINK-II – related devices

Servo system and frequency inverters

Name	Order code	
Accurax G5 servo drive ML-II built-in	R88D-KN____-ML2	
G-Series servo drive ML-II built-in	R88D-GN__H-ML2	
MX2 inverter with MECHATROLINK-II option board	Frequency inverter	3G3MX2-A_
	ML2 option board	3G3AX-MX2-MRT

Note: Refer to servo systems and frequency inverter sections for detailed specs and ordering information

SmartSlice IOs system

Function	Specification	Order code
SmartSlice Interface unit	SmartSlice MECHATROLINK-II interface unit	GRT1-ML2 ^{*1}
End plate, one unit required per bus interface		GRT1-END
4 NPN inputs	24 VDC, 6 mA, 3-wire connection	GRT1-ID4
4 PNP inputs	24 VDC, 6 mA, 3-wire connection	GRT1-ID4-1
8 NPN inputs	24 VDC, 4 mA, 1-wire connection + 4xG	GRT1-ID8
8 PNP inputs	24 VDC, 4 mA, 1-wire connection + 4xV	GRT1-ID8-1
4 AC inputs	110 VAC, 2-wire connection	GRT1-IA4-1
4 AC inputs	230 VAC, 2-wire connection	GRT1-IA4-2
4 NPN outputs	24 VDC, 500 mA, 2-wire connection	GRT1-OD4
4 PNP outputs	24 VDC, 500 mA, 2-wire connection	GRT1-OD4-1
4 PNP outputs with short-circuit protection	24 VDC, 500 mA, 3-wire connection	GRT1-OD4G-1
4 PNP outputs with short-circuit protection	24 VDC, 2 A, 2-wire connection	GRT1-OD4G-3
8 NPN outputs	24 VDC, 500 mA, 1-wire connection + 4xV	GRT1-OD8
8 PNP outputs	24 VDC, 500 mA, 1-wire connection + 4xG	GRT1-OD8-1
8 PNP outputs with short-circuit protection	24 VDC, 500 mA, 1-wire connection + 4xG	GRT1-OD8G-1
2 relay outputs	240 VAC, 2 A, normally-open contacts	GRT1-ROS2
2 analog inputs, current/voltage	±10 V, 0 to 10 V, 0 to 5 V, 1 to 5 V, 0 to 20 mA, 4 to 20 mA	GRT1-AD2
2 analog outputs, voltage	±10 V, 0 to 10 V, 0 to 5 V, 1 to 5 V	GRT1-DA2V
2 analog outputs, current	0 to 20 mA, 4 to 20 mA	GRT1-DA2C
2 Pt100 inputs	Pt100, 2-wire or 3-wire connection	GRT1-TS2P
2 Pt1000 inputs	Pt1000, 2-wire or 3-wire connection	GRT1-TS2K
2 Thermocouple inputs	Types B, E, J, K, N, R, S, T, U, W, PL2, with cold junction compensation	GRT1-TS2T

^{*1} The GRT1-ML2 supports the GRT1-IA4-1, GRT1-IA4-2, GRT1-OD4G-3, GRT1-TS2P, GRT1-TS2K and GRT1-TS2T slice units only in combination with TJ2-MC64 motion controller. They are not supported in combination with TJ1-MC16/04.

Note: Refer to Automation systems catalogue for detailed specs and accessories information

MECHATROLINK-II cables

Name	Remarks	Order code
MECHATROLINK-II cables	0.5 meter	JEPMC-W6003-A5
	1 meter	JEPMC-W6003-01
	3 meters	JEPMC-W6003-03
	5 meters	JEPMC-W6003-05
	10 meters	JEPMC-W6003-10
	20 meters	JEPMC-W6003-20
	30 meters	JEPMC-W6003-30
MECHATROLINK-II terminator	Terminating resistor	JEPMC-W6022
MECHATROLINK-II repeater	Network repeater	JEPMC-REP2000

Computer software

Specifications	Order code
CX-Motion Pro V1.3.3 or higher	CX-One
Trajexia Studio ^{*1} V1.3.3 or higher	TJ1-Studio

^{*1} When the Trajexia Studio software is included in CX-One, then it is called CX-Motion Pro.



Stand-alone motion controller for compact and simple machines

- Perfect motion control of 2 axes
- Supports position, speed and torque control
- Serial port for master encoder axis
- Multi-tasking controller capable of running up to 22 tasks simultaneously
- 2 fast-registration inputs
- Single axis moves and axes interpolation
- Electronic cams and gearboxes
- Motion basic programming and dedicated motion commands
- Open communication: Serial and EtherNet/IP built-in, PROFIBUS-DP, DeviceNet and CANopen options

Ordering information

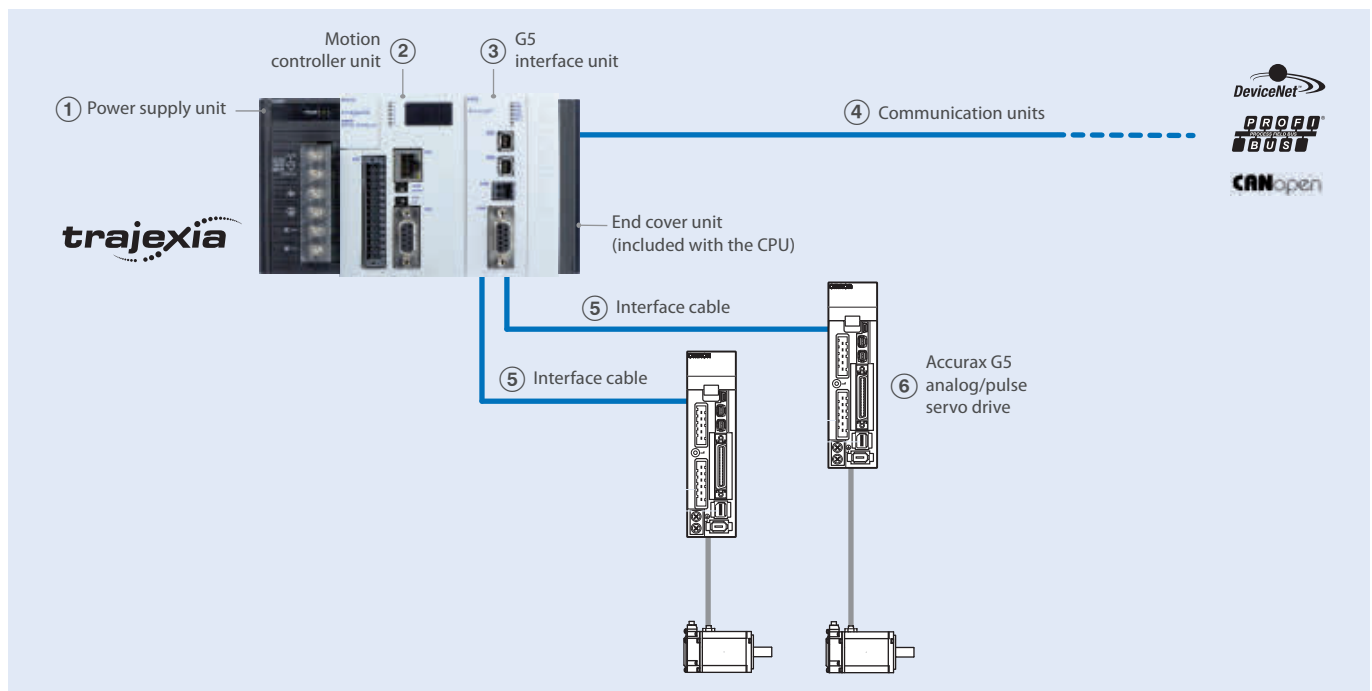

Trajexia system

Power supply unit

Symbol	Specifications	Order code
①	Power supply unit for Trajexia system (100 to 240 VAC)	CJ1W-PA202
	Power supply unit for Trajexia system (24 VDC)	CJ1W-PD025

Motion controller unit

Symbol	Specifications	Order code
②	Trajexia motion controller unit, up to 64 axes (Trajexia end cover unit TJ1-TER is included)	TJ2-MC64
	Trajexia motion controller unit, up to 2 axes (Trajexia end cover unit TJ1-TER is included)	TJ2-MC02

G5 interface unit

Symbol	Specifications	Order code
③	G5 interface unit	TJ2-KS02

Communication unit

Symbol	Specifications	Order code
④	Trajexia DeviceNet slave unit	TJ1-DRT
	Trajexia PROFIBUS-DP slave unit	TJ1-PRT
	Trajexia CANopen unit	TJ1-CORT

Note: The TJ2-MC02 supports a maximum of one TJ1-CORT unit.
The TJ2-MC02 supports a maximum of one TJ1-PRT or TJ1-DRT unit. No both at the same time.

Accessories

Symbol	Specifications	Order code	
⑤	Interface cable	1 m	TJ2-KC01M
		3 m	TJ2-KC03M

Servo drive related device

Symbol	Specifications	Order code
⑥	Accurax G5 Analog/pulse servo drive (100 W to 15 kW)	R88D-KT_

Computer software

Specifications	Order code
CX-Motion Pro (version 1.4.2 or higher)	CX-One
Trajexia Studio* ¹ (version 1.4.2 or higher)	TJ1-Studio

*¹ When the Trajexia Studio software is included in CX-One, then it is called CX-Motion Pro.



Multi-axis point-to-point positioning controller over EtherCAT

- Position control units with 2, 4, 8 or 16 axes
- NC_82 models support up to 64 additional nodes: inverters, vision systems and distributed I/Os
- Linear and circular interpolation
- Linear and infinite axes management
- Programming languages: ladder and function blocks. Certified PLCopen motion control function blocks
- The unit can perform various operation sequences in the memory operation data.
- CX-Programmer software for unit setup, EtherCAT network configuration and PLC programming

Ordering information

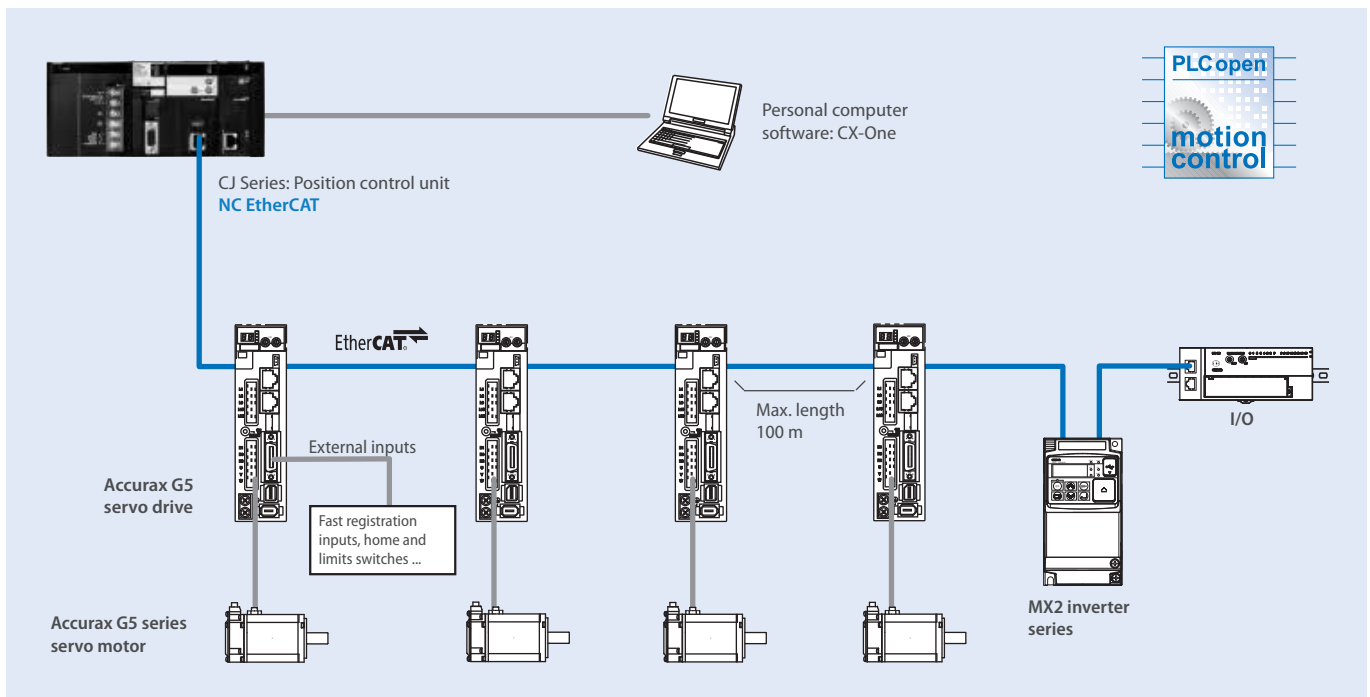

Position controller unit

Name	Order code
Position controller unit - EtherCAT – 16 axes + 64 nodes for remote I/O	CJ1W-NCF82
Position controller unit - EtherCAT – 8 axes + 64 nodes for remote I/O	CJ1W-NC882
Position controller unit - EtherCAT – 4 axes + 64 nodes for remote I/O	CJ1W-NC482
Position controller unit - EtherCAT – 16 axes	CJ1W-NCF81
Position controller unit - EtherCAT – 8 axes	CJ1W-NC881
Position controller unit - EtherCAT – 4 axes	CJ1W-NC481
Position controller unit - EtherCAT – 2 axes	CJ1W-NC281

EtherCAT related devices

Servo system and frequency inverter

Name	Order code	
Accurax G5 servo drive EtherCAT built-in	R88D-KN___-ECT	
MX2 inverter with EtherCAT option board	Frequency inverter	3G3MX2-A_
	EtherCAT option board	3G3AX-MX2-ECT

Note: Refer to servo system and frequency inverter sections for detailed specs and ordering information.

GX-Series I/O Blocks

Name	Order code
16 NPN inputs	24 VDC, 6 mA, 1-wire connection, expandable GX-ID1611
16 PNP inputs	24 VDC, 6 mA, 1-wire connection, expandable GX-ID1621
16 NPN outputs	24 VDC, 500 mA, 1-wire connection, expandable GX-OD1611
16 PNP outputs	24 VDC, 500 mA, 1-wire connection, expandable GX-OD1621
8 inputs and 8 outputs, NPN	24 VDC, 6 mA input, 500 mA output, 1-wire connection GX-MD1611
8 inputs and 8 outputs, PNP	24 VDC, 6 mA input, 500 mA output, 1-wire connection GX-MD1621

Name		Order code
16 NPN inputs	24 VDC, 6 mA, 3-wire connection	GX-ID1612
16 PNP inputs	24 VDC, 6 mA, 3-wire connection	GX-ID1622
16 NPN outputs	24 VDC, 500 mA, 3-wire connection	GX-OD1612
16 PNP outputs	24 VDC, 500 mA, 3-wire connection	GX-OD1622
8 inputs and 8 outputs, NPN	24 VDC, 6 mA input, 500 mA output, 3-wire connection	GX-MD1612
8 inputs and 8 outputs, PNP	24 VDC, 6 mA input, 500 mA output, 3-wire connection	GX-MD1622
16 relay outputs	250 VAC, 2 A, 1-wire connection, expandable	GX-OC1601
4 analog inputs, current/voltage	±10 V, 0 to 10 V, 0 to 5 V, 1 to 5 V, 4 to 20 mA	GX-AD0471
2 analog outputs, current/voltage	±10 V, 0 to 10 V, 0 to 5 V, 1 to 5 V, 4 to 20 mA	GX-DA0271
2 encoder open collector inputs	500 kHz Open collector input	GX-EC0211
2 encoder line-driver inputs	4 MHz Line driver input	GX-EC0241

Note: Refer to Automation systems catalogue for detailed specs and ordering information.

Vision system

Name	Specification	Order code
Vision system with EtherCAT interface	NPN	FZM1-350-ECT
	PNP	FZM1-355-ECT

Note: Refer to vision system documentation for detailed specs and ordering information.

Computer software

Specifications	Order code
CX-One version 4 or higher	CX-One
CX-Programmer version 9.12 or higher	CX-Programmer



Trajexia motion controller integrated with your PLC

Trajexia, the family of advanced motion controllers that put you in control, now has a compact and integrated version. Meet Trajexia-PLC, the motion controller that has all the flexibility and modularity of Omron PLCs, plus the outstanding motion-control features of the Trajexia platform.

- Control of up to 30 physical axes
- Control of servos and inverters over a single motion network
- Advanced motion control such as CAM control, registration control, interpolation and axes synchronization via simple motion commands
- Serial port for external encoder
- Embedded digital I/Os
- I/O data exchange with the PLC CPU

Ordering information

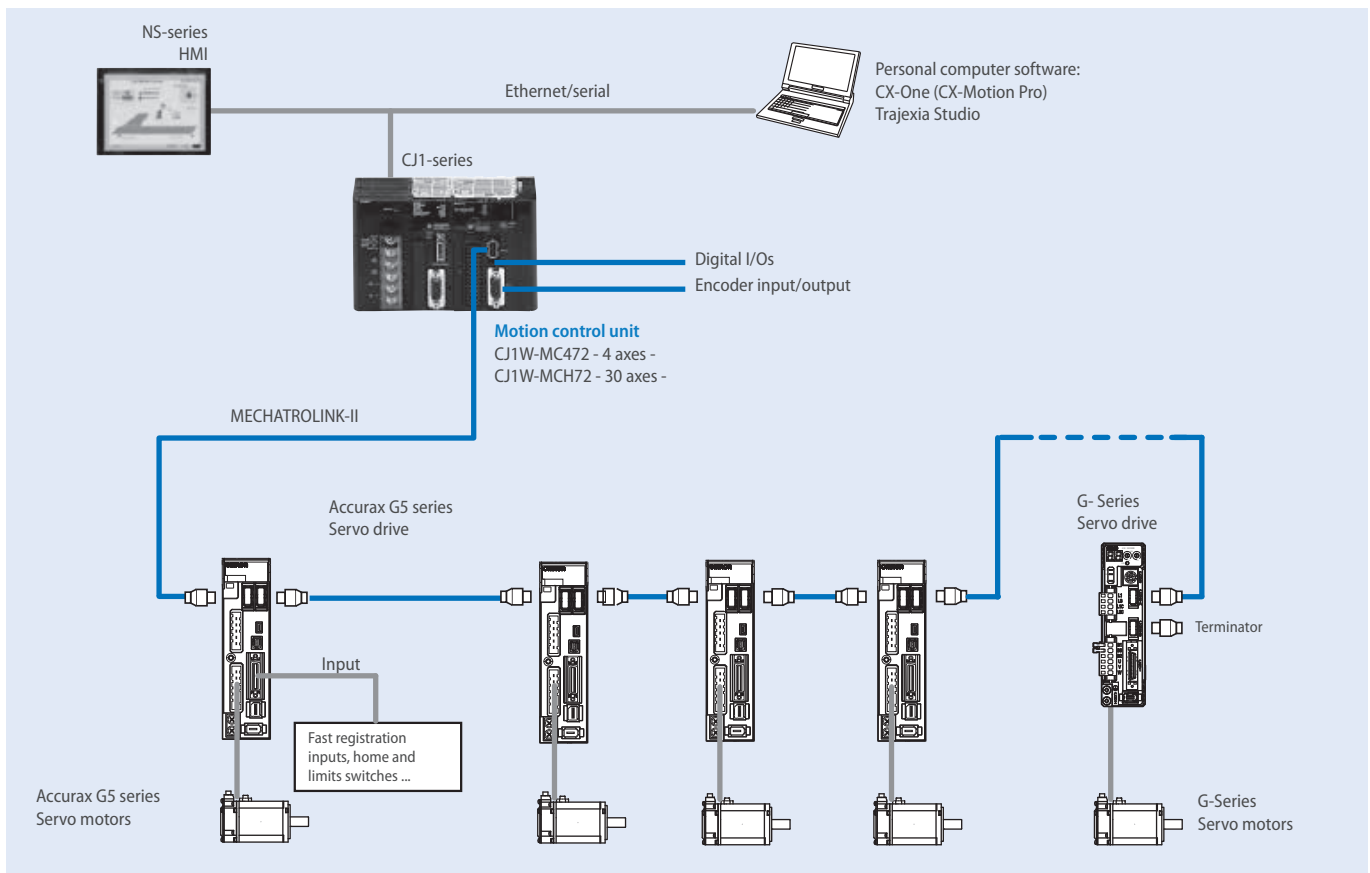

Motion controller

Name	Order code
Trajexia motion control unit, up to 30 MECHATROLINK-II axes	CJ1W-MCH72
Trajexia motion control unit, up to 4 MECHATROLINK-II axes	CJ1W-MC472

MECHATROLINK-II – related devices

Servo system

Name	Order code	
Accurax G5 servo drive ML-II built-in	R88D-KN___-ML2	
G-Series servo drive ML-II built-in	R88D-GN__H-ML2	
MX2 inverter with MECHATROLINK-II option board	Frequency inverter	3G3MX2-A_
	MECHATROLINK-II option board	3G3AX-MX2-MRT

Note: Refer to servo systems and frequency inverter sections for detailed specs and ordering information

MECHATROLINK-II cables

Name	Remarks	Order code
MECHATROLINK-II cables	0.5 meter	JEPMC-W6003-A5
	1 meter	JEPMC-W6003-01
	3 meters	JEPMC-W6003-03
	5 meters	JEPMC-W6003-05
	10 meters	JEPMC-W6003-10
	20 meters	JEPMC-W6003-20
	30 meters	JEPMC-W6003-30
MECHATROLINK-II terminator	Terminating resistor	JEPMC-W6022
MECHATROLINK-II repeater	Network repeater	JEPMC-REP2000

Computer software

Specifications	Order code
CX-Motion Pro V1.3.3 or higher	CX-One
Trajexia Studio ^{*1} V1.3.3 or higher	TJ1-Studio

^{*1} When the Trajexia Studio software is included in CX-One, then it is called CX-Motion Pro.



2, 4 and 16-axis point-to-point positioning controller over MECHATROLINK-II

NC_71 is a powerful controller for point-to-point applications. It is based on MECHATROLINK-II motion bus, which reduces programming and development and maintenance costs. Supports PLC open function blocks.

- Supports position, speed and torque control.
- Programming languages: ladder, function blocks. Supports PLC Open Function Blocks.
- Smart active parts for Omron HMIs terminals reduce engineering time.
- Access to the complete system from one point. Network setup, servo drives configuring and monitoring, and PLC programming.

Ordering information

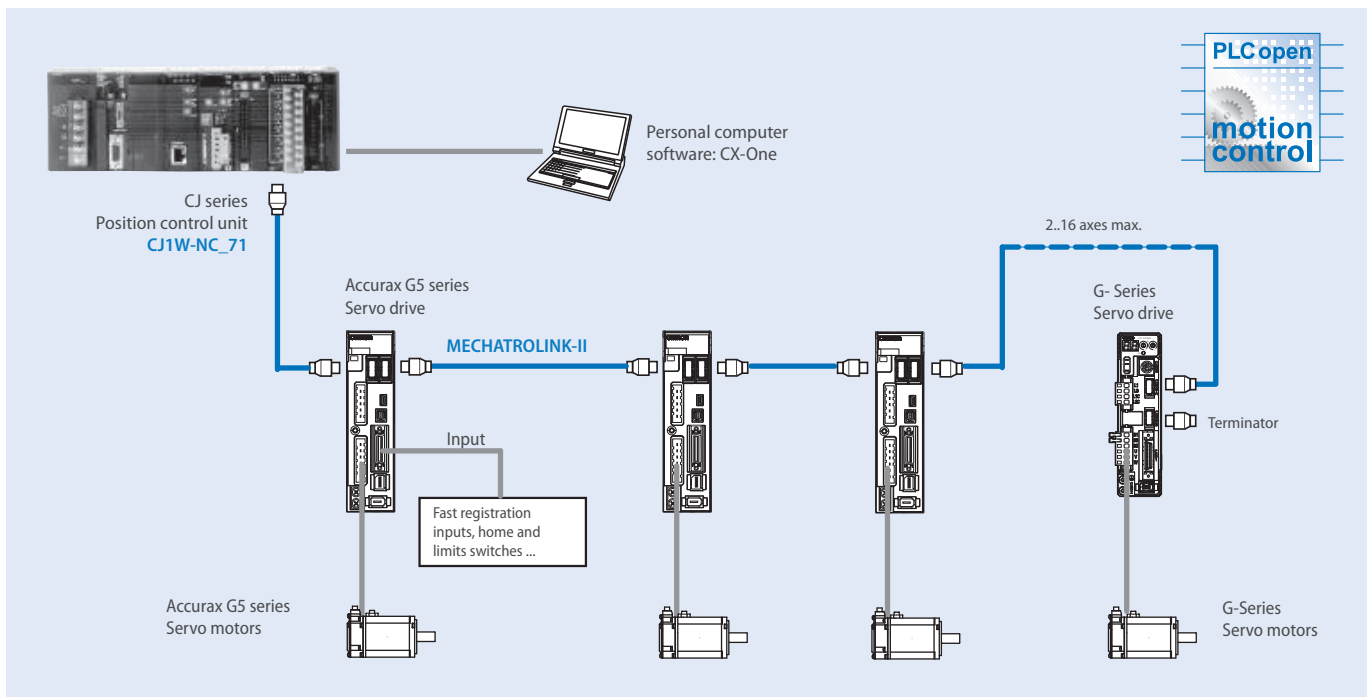

Position controller unit

Name	Order code
MECHATROLINK-II position controller unit – 16 axes	CJ1W-NCF71
MECHATROLINK-II position controller unit – 4 axes	CJ1W-NC471
MECHATROLINK-II position controller unit – 2 axes	CJ1W-NC271

Computer software

Specifications	Order code
CX-One version 2.0 (CX-Motion NCF 1.70 or higher)	CX-One
CX-One version 3.0 (CX-Motion NCF 1.90 or higher)	
CX-One version 4.0 or higher	

MECHATROLINK-II related devices

Servo system

Name	Order code
Accurax G5 servo drive ML-II built-in	R88D-KN___-ML2
G-Series servo drive ML-II built-in	R88D-GN___H-ML2

Note: Refer to servo systems section for detailed specs and ordering information

MECHATROLINK-II cables

Name	Remarks	Order code
MECHATROLINK-II terminator	Terminating resistor	JEPMC-W6022
MECHATROLINK-II cables	0.5 meter	JEPMC-W6003-A5
	1 meter	JEPMC-W6003-01
	3 meters	JEPMC-W6003-03
	5 meters	JEPMC-W6003-05
	10 meters	JEPMC-W6003-10
	20 meters	JEPMC-W6003-20
	30 meters	JEPMC-W6003-30



1, 2 or 4-axis point-to-point positioning controller with pulse train output

The NC motion controllers support positioning control via pulse-train outputs. Positioning is performed using trapezoidal or S-curve acceleration and deceleration. Ideal for controlling simple positioning in stepper motors and servos with pulse-train input.

- Positioning can be done by direct ladder commands
- Position and speed control
- Linear interpolation
- Interrupt feeding function
- Positioning of 100 points done from memory
- Positioning data is saved in internal flash memory, eliminating the need to maintain a backup battery.

Ordering information

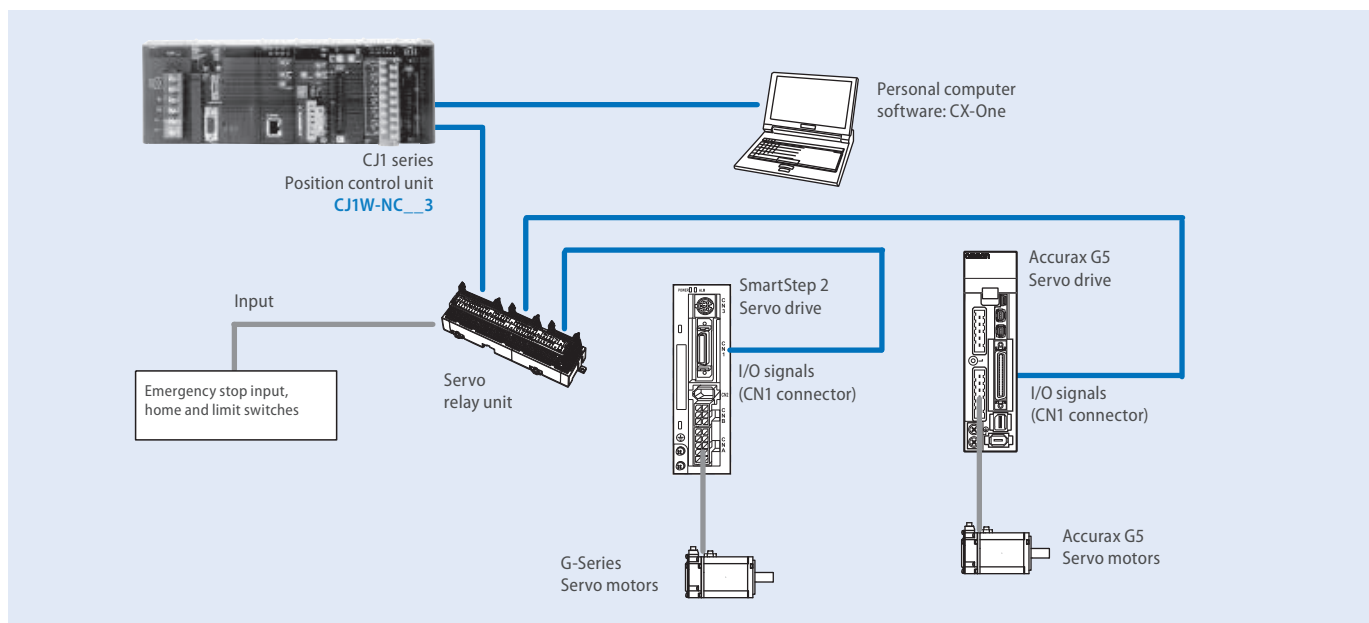

Position control unit

Name	Order code
1 axis position control unit. Open-collector output.	CJ1W-NC113
2 axes position control unit. Open-collector output.	CJ1W-NC213
4 axes position control unit. Open-collector output.	CJ1W-NC413
1 axis position control unit. Line-driver output.	CJ1W-NC133
2 axes position control unit. Line-driver output.	CJ1W-NC233
4 axes position control unit. Line-driver output.	CJ1W-NC433

Servo drive cables

Note: Refer the selected servo systems section for cable and servo relay units information.

Computer software

Specifications	Order code
CX-One	CX-One



2 or 4-axis point-to-point positioning controller with pulse train output and motion control unit functionality

The NC motion controllers support positioning control via pulse-train outputs. Positioning is performed using trapezoidal or S-curve acceleration and deceleration. Ideal for controlling simple positioning in stepper motors and servos with pulse-train input. When the CJ1W-NC__4 unit is used in a CJ2 CPU, it can perform also synchronous operation by use of electronic CAMs and other function blocks.

- Position and speed control
- Linear interpolation and feeder control function
- Electronic CAM profiles and axes synchronization
- Positioning of 500 points done from memory
- Programming languages: ladder, function blocks.

Ordering information

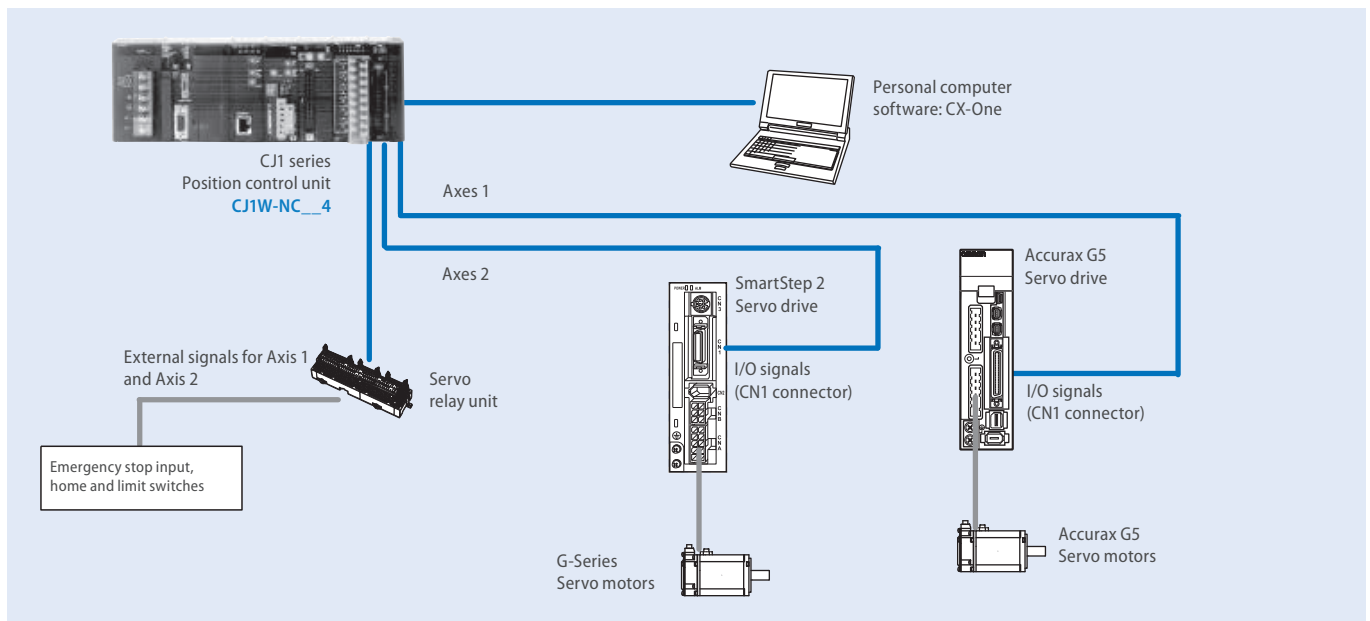

Position control unit

Name	Order code
2 axes position control unit. Open-collector output.	CJ1W-NC214
4 axes position control unit. Open-collector output.	CJ1W-NC414
2 axes position control unit. Line-driver output.	CJ1W-NC234
4 axes position control unit. Line-driver output.	CJ1W-NC434

Servo drive cables

Note: Refer to selected servo systems section for cable and servo relay units information.

Computer software

Specifications	Order code
CX-One	CX-One

EXTREME MECHATRONICS MEETS X-STREAM AUTOMATION

At the heart of every great machine

Great machines are born from a perfect match between control and mechanics. Accurax G5 gives you the extra edge to build more accurate, faster, smaller and safer machines. You will benefit from an almost 25% reduction in motor weight, and gain 50% cabinet space. You will achieve sub micron precision and ms settling time. Some might call it perfection, we just call it tireless innovation to help you build great machines.



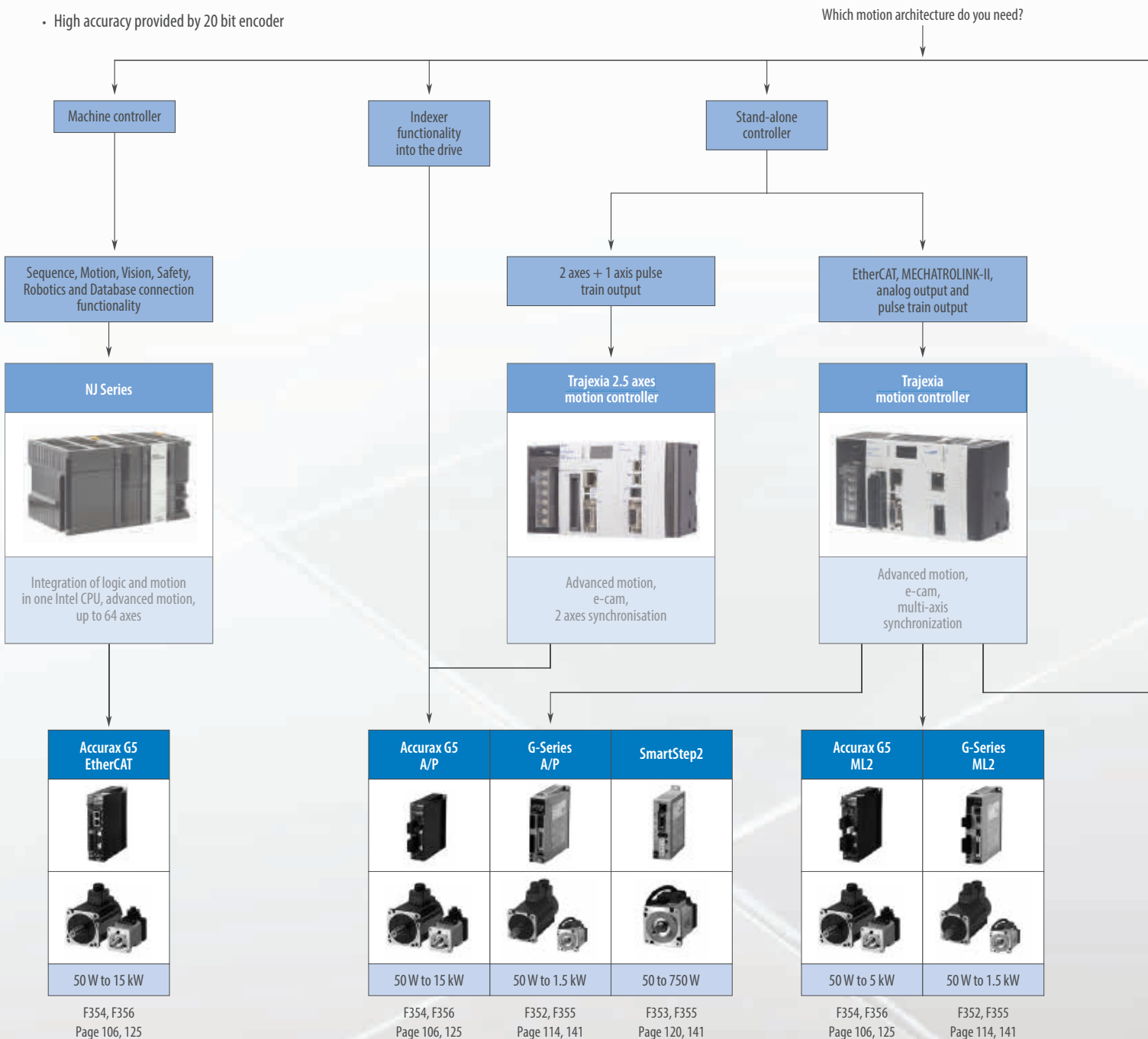

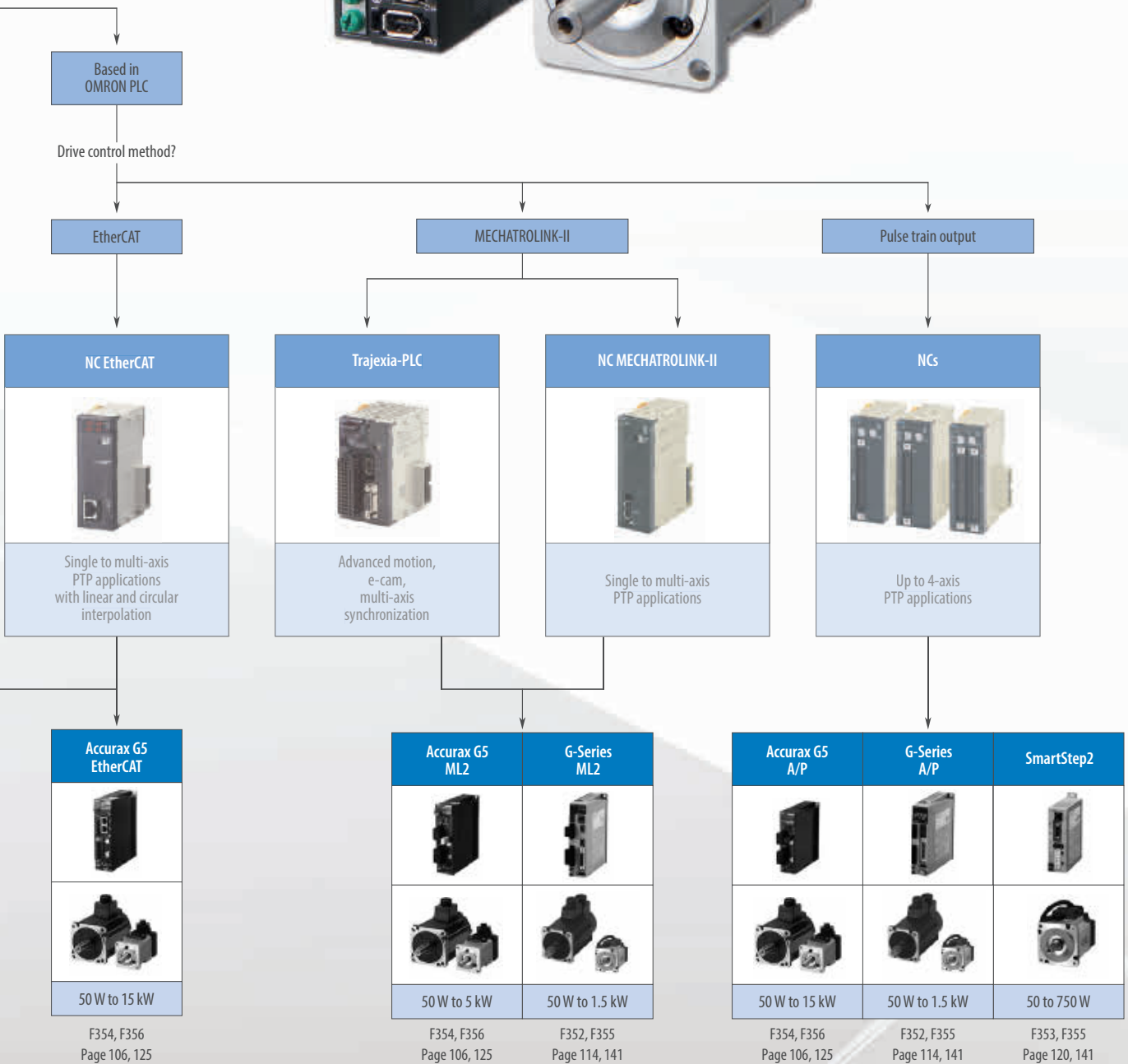
- EtherCAT, ML-II and analog/pulse models
- High response frequency of 2 kHz
- Safety built-in conforming ISO13849-1 PL-d
- High accuracy provided by 20 bit encoder









Selection table

Servo drives			
			
	Accurax G5 EtherCAT network and safety built-in	G-Series Compact size and ML2 motion bus	SmartStep 2 Pulse train input with ultra-compact size
Ratings 230 V single-phase	100 W to 1.5 kW	100 W to 1.5 kW	100 W to 750 W
Ratings 400 V three-phase	600 W to 15 kW	N/A	N/A
Applicable servomotor	Accurax G5 and G-Series rotary motors	G-Series	G-Series
Position control	EtherCAT, MECHATROLINK-II or Pulse train input	MECHATROLINK-II or Pulse train input	Pulse train input
Speed control	EtherCAT, MECHATROLINK-II or Analog input ± 10 V	MECHATROLINK-II or Analog input ± 10 V	N/A
Torque control	EtherCAT, MECHATROLINK-II or Analog input ± 10 V	MECHATROLINK-II or Analog input ± 10 V	Torque limits only
	Embedded indexer functionality	N/A	N/A
Safety approvals	ISO13849-1:2008 (PL d), EN 954-1:1996 (Cat-3)	N/A	N/A
Full closed loop	Built-in	N/A	N/A
Page/Quick Link	106	114	120

Accurax G5 servo motors				
				
	Standard models			
	3,000 r/min motor	2,000 r/min motor	1,500 r/min motor	1,000 r/min motor
Rated speed	3,000 rpm	2,000 rpm	1,500 rpm	1,000 rpm
Maximum speed	4,500 to 6,000 rpm	3,000 rpm	2,000 to 3,000 rpm	2,000 rpm
Rated torque	0.16 Nm to 15.9 Nm	1.91 Nm to 23.9 Nm	47.8 Nm to 95.5 Nm	8.59 Nm to 28.7 Nm
Sizes	50 W to 5 kW	400 W to 5 kW	7.5 kW to 15 kW	900 W to 6 kW
Applicable servo drive	Accurax G5 servo drive	Accurax G5 servo drive	Accurax G5 servo drive	Accurax G5 servo drive
Encoder resolution	20-bit incremental/ 17-bit absolute	20-bit incremental/ 17-bit absolute	17-bit absolute	20-bit incremental/ 17-bit absolute
IP rating	IP67	IP67	IP67	IP67
Page/Quick Link	125			

G-Series servo motors – Cylindrical type –			G-Series servo motors – Flat type –	
				
	3,000 r/min motor	2,000 r/min motor	1,000 r/min motor	3,000 r/min motor
Rated speed	3,000 rpm	2,000 rpm	1,000 rpm	3,000 rpm
Maximum speed	4,500 to 5,000 rpm	3,000 rpm	2,000 rpm	5,000 rpm
Rated torque	0.16 Nm to 4.77 Nm	4.8 Nm to 7.15 Nm	8.62 Nm	0.32 Nm to 1.3 Nm
Sizes	50 to 1,500 W	1 to 1.5 kW	900 W	100 to 400 W
Applicable servo drive	SmartStep 2, G-Series and Accurax G5 servo drives	SmartStep 2, G-Series and Accurax G5 servo drives	SmartStep 2, G-Series and Accurax G5 servo drives	SmartStep 2, G-Series and Accurax G5 servo drives
Encoder resolution	10,000 pulses/revolution or 17-bit absolute/incremental	10,000 pulses/revolution or 17-bit absolute/incremental	10,000 pulses/revolution or 17-bit absolute/incremental	10,000 pulses/revolution or 17-bit absolute/incremental
IP rating	IP65	IP65	IP65	IP65
Page/Quick Link	141			

Accurax G5 servo motors			
			
High inertia models			
	3,000 r/min motor	2,000 r/min motor	1,500 r/min motor
Rated speed	3,000 rpm	2,000 rpm	1,500 rpm
Maximum speed	5,000 rpm	3,000 rpm	2,000 to 3,000 rpm
Rated torque	0.64 Nm to 2.4 Nm	4.77 Nm to 23.9 Nm	47.8 Nm
Sizes	200 W to 750 W	1 kW to 5 kW	7.5 kW
Applicable servo drive	Accurax G5 servo drive	Accurax G5 servo drive	Accurax G5 servo drive
Encoder resolution	20-bit incremental/ 17-bit absolute	20-bit incremental/ 17-bit absolute	17-bit absolute
IP rating	IP65	IP67	IP67
Page/Quick Link	125		



Accurate motion control in a compact size servo drive family. EtherCAT and safety built-in

- EtherCAT, ML-II and analog/pulse servo drive models
- Safety conforming ISO13849-1 PL-d
- High-response frequency of 2 kHz
- High resolution provided by 20 bits encoder
- Drive Programming: embedded indexer functionality in the analog/pulse models
- External encoder input for full closed loop
- Real time auto-tuning
- Advanced tuning algorithms (anti-vibration function, torque feedforward, disturbance observer)

Ordering information

Accurax G5 series EtherCAT reference configuration

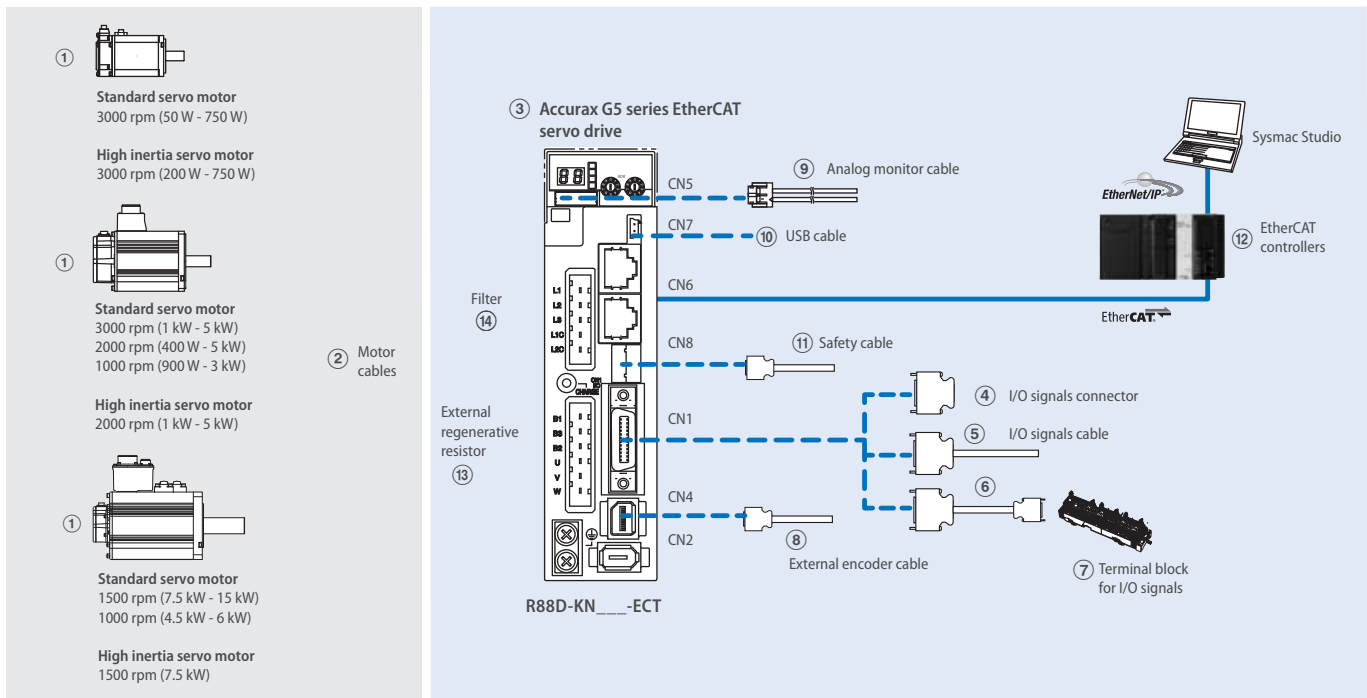

Note: The symbols ①②③④⑤... show the recommended sequence to select the components in Accurax G5 servo system

Servo motors, power and encoder cables

Note: ①② Refer to the Accurax G5 servo motor chapter for servomotor, motor cables or connectors selection

Servo drives

Symbol	Specifications	① Compatible G5 series rotary servo motors		Servo drive models Order code	
		Standard models	High Inertia models		
③	1 phase 230 VAC	100 W	R88M-K05030(H/T)-_	-	R88D-KN01H-ECT
			R88M-K10030(H/T)-_	-	
		200 W	R88M-K20030(H/T)-_	R88M-KH20030(H/T)-_	R88D-KN02H-ECT
			R88M-K40030(H/T)-_	R88M-KH40030(H/T)-_	R88D-KN04H-ECT
			R88M-K75030(H/T)-_	R88M-KH75030(H/T)-_	R88D-KN08H-ECT
			R88M-K1K020(H/T)-_	-	R88D-KN10H-ECT
	1.5 kW	R88M-K1K030(H/T)-_	-	R88D-KN15H-ECT	
		R88M-K1K530(H/T)-_	-		
	3 phase 400 VAC	600 W	R88M-K40020(F/C)-_	-	R88D-KN06F-ECT
			R88M-K60020(F/C)-_	-	
		1.0 kW	R88M-K75030(F/C)-_	-	R88D-KN10F-ECT
			R88M-K1K020(F/C)-_	R88M-KH1K020(F/C)-_	
1.5 kW		R88M-K1K030(F/C)-_	-	R88D-KN15F-ECT	
		R88M-K1K530(F/C)-_	-		
			R88M-K1K520(F/C)-_	R88M-KH1K520(F/C)-_	
			R88M-K90010(F/C)-_	-	

Symbol	Specifications		① Compatible G5 series rotary servo motors		Servo drive models
			Standard models	High Inertia models	Order code
③	3 phase 400 VAC	2.0 kW	R88M-K2K030(F/C)-_	-	R88D-KN20F-ECT
			R88M-K2K020(F/C)-_	R88M-KH2K020(F/C)-_	
		3.0 kW	R88M-K3K030(F/C)-_	-	R88D-KN30F-ECT
			R88M-K3K020(F/C)-_	R88M-KH3K020(F/C)-_	
			R88M-K2K010(F/C)-_	-	
			-	-	
	5.0 kW	R88M-K4K030(F/C)-_	-	R88D-KN50F-ECT	
		R88M-K5K030(F/C)-_	-		
		R88M-K4K020(F/C)-_	R88M-KH4K020(F/C)-_		
		R88M-K5K020(F/C)-_	R88M-KH5K020(F/C)-_		
	7.5 kW	R88M-K4K510C-_	-	R88D-KN75F-ECT	
		R88M-K3K010(F/C)-_	-		
	15 kW	R88M-K6K010C-_	-	R88D-KN150F-ECT	
		R88M-K7K515C-_	R88M-KH7K515C-_		
		R88M-K11K015C-_	-		
		R88M-K15K015C-_	-		

Signals cables for I/O general purpose (CN1)

Symbol	Description	Connect to	Length	Order code
④	I/O connector kit (26 pins)	For I/O general purpose	-	R88A-CNW01C
⑤	I/O signals cable	For I/O general purpose	1 m	R88A-CPKB001S-E
			2 m	R88A-CPKB002S-E
⑥	Terminal block cable	For I/O general purpose	1 m	XW2Z-100J-B34
			2 m	XW2Z-200J-B34
⑦	Terminal block (M3 screw and for pin terminals)		-	XW2B-20G4
	Terminal block (M3.5 screw and for fork/round terminals)		-	XW2B-20G5
	Terminal block (M3 screw and for fork/round terminals)		-	XW2D-20G6

External encoder cable (CN4)

Symbol	Name	Length	Order code
⑧	External encoder cable	5 m	R88A-CRKM005SR-E
		10 m	R88A-CRKM010SR-E
		20 m	R88A-CRKM020SR-E

Analog monitor (CN5)

Symbol	Name	Length	Order code
⑨	Analog monitor cable	1 m	R88A-CMK001S

USB personal computer cable (CN7)

Symbol	Name	Length	Order code
⑩	USB mini-connector cable	2 m	AX-CUSBM002-E

Cable for safety (CN8)

Symbol	Name	Length	Order code
⑪	Safety cable	3 m	R88A-CSK003S-E

EtherCAT controllers

Symbol	Name	Order code	
⑫	NJ-series	CPU unit	NJ501-1500 (64 axes)
			NJ501-1400 (32 axes)
			NJ501-1300 (16 axes)
			NJ301-1200 (8 axes)
			NJ301-1100 (4 axes)
	Trajexia stand-alone	Power supply unit	NJ-PA3001 (220 VAC)
			NJ-PD3001 (24 VDC)
		Motion control unit	TJ2-MC64 (64 axes)
		EtherCAT master unit	TJ2-ECT64 (64 axes)
			TJ2-ECT16 (16 axes)
		TJ2-ECT04 (4 axes)	
Position controller unit for CJ1 PLC series		CJ1W-NCF8_ (16 axes)	
		CJ1W-NC88_ (8 axes)	
		CJ1W-NC48_ (4 axes)	
		CJ1W-NC281 (2 axes)	

External regenerative resistor

Symbol	Specifications	Order code
⑬	50 Ω, 80 W	R88A-RR08050S
	100 Ω, 80 W	R88A-RR080100S
	47 Ω, 220 W	R88A-RR22047S
	20 Ω, 500 W	R88A-RR50020S

Filters

Symbol	Applicable servodrive	Rated current	Leakage current	Rated voltage	Order code
⑭	R88D-KN01H-ECT, R88D-KN02H-ECT	2.4 A	3.5 mA	250 VAC single-phase	R88A-FIK102-RE
	R88D-KN04H-ECT	4.1 A	3.5 mA		R88A-FIK104-RE
	R88D-KN08H-ECT	6.6 A	3.5 mA		R88A-FIK107-RE
	R88D-KN10H-ECT, R88D-KN15H-ECT	14.2 A	3.5 mA		R88A-FIK114-RE
	R88D-KN06F-ECT, R88D-KN10F-ECT, R88D-KN15F-ECT	4 A	0.3 mA/32 mA ^{*1}	400 VAC three-phase	R88A-FIK304-RE
	R88D-KN20F-ECT	6 A	0.3 mA/32 mA ^{*1}		R88A-FIK306-RE
	R88D-KN30F-ECT, R88D-KN50F-ECT	12.1 A	0.3 mA/32 mA ^{*1}		R88A-FIK312-RE
	R88D-KN75F-ECT	22 A	0.3 mA/40 mA ^{*1}		R88A-FIK330-RE
	R88D-KN150F-ECT	44 A	2 mA/130 mA ^{*1}		R88A-FIK350-RE

*1 Momentary peak leakage current for the filter at switch-on/off.

Connectors

Specifications	Order code
External encoder connector (for CN4)	R88A-CNK41L
Safety I/O signal connector (for CN8)	R88A-CNK81S

Computer software

Specifications	Order code
Sysmac Studio version 1.0 or higher	SYSMAC-SE2_...
CX-Drive version 2.10 or higher	CX-DRIVE 2.10
CX-One software package including CX-Drive 2.10 or higher	CX-ONE

Note: If CX-One is installed on the same computer as Sysmac Studio, it must be CX-One v4.2 or higher.

Accurax G5 series MECHATROLINK-II reference configuration

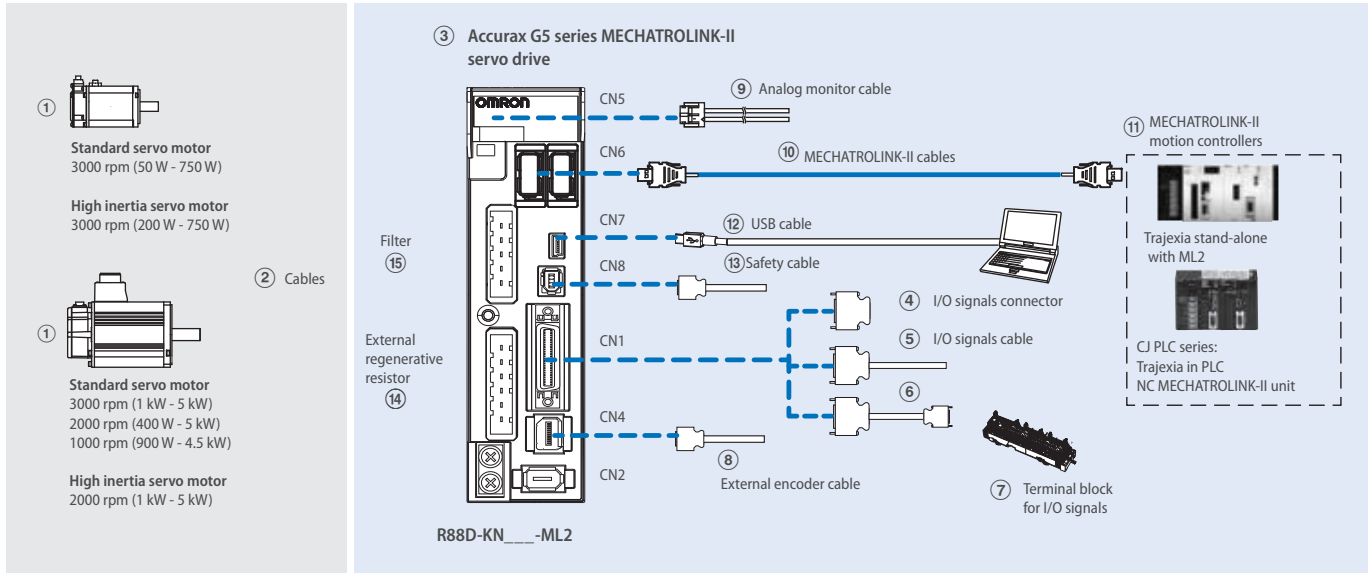

Note: The symbols ①②③④⑤... show the recommended sequence to select the components in Accurax G5 servo system

Servo motors, power and encoder cables

Note: ①② Refer to the Accurax G5 servo motor section for servomotor, motor cables or connectors selection

Servo drives

Symbol	Specifications	① Compatible G5 series rotary servo motors		Servo drive models	
		Standard models	High inertia models		
③	1 phase 230 VAC	100 W	R88M-K05030(H/T)-_	-	R88D-KN01H-ML2
			R88M-K10030(H/T)-_	-	-
		200 W	R88M-K20030(H/T)-_	R88M-KH20030(H/T)-_	R88D-KN02H-ML2
			R88M-K40030(H/T)-_	R88M-KH40030(H/T)-_	R88D-KN04H-ML2
		750 W	R88M-K75030(H/T)-_	R88M-KH75030(H/T)-_	R88D-KN08H-ML2
		1.0 kW	R88M-K1K020(H/T)-_	-	R88D-KN10H-ML2
		1.5 kW	R88M-K1K030(H/T)-_	-	R88D-KN15H-ML2
	R88M-K1K530(H/T)-_		-		
	R88M-K1K520(H/T)-_		-		
	3 phase 400 VAC	600 W	R88M-K40020(F/C)-_	-	R88D-KN06F-ML2
			R88M-K60020(F/C)-_	-	-
		1.0 kW	R88M-K75030(F/C)-_	-	R88D-KN10F-ML2
			R88M-K1K020(F/C)-_	R88M-KH1K020(F/C)-_	R88D-KN15F-ML2
		R88M-K1K030(F/C)-_	-		
R88M-K1K530(F/C)-_		-			
1.5 kW		R88M-K1K520(F/C)-_	R88M-KH1K520(F/C)-_	-	
		R88M-K90010(F/C)-_	-	-	
		2.0 kW	R88M-K2K030(F/C)-_	-	R88D-KN20F-ML2
2.0 kW		R88M-K2K020(F/C)-_	R88M-KH2K020(F/C)-_	R88D-KN30F-ML2	
		R88M-K3K030(F/C)-_	-		
3.0 kW		R88M-K3K020(F/C)-_	R88M-KH3K020(F/C)-_		-
		R88M-K2K010(F/C)-_	-	-	
5.0 kW		R88M-K4K030(F/C)-_	-	R88D-KN50F-ML2	
		R88M-K5K030(F/C)-_	-		
		R88M-K4K020(F/C)-_	R88M-KH4K020(F/C)-_		-
		R88M-K5K020(F/C)-_	R88M-KH5K020(F/C)-_		-
	R88M-K4K510C-_	-	-		
	R88M-K3K010(F/C)-_	-	-		
	-	-	-		

Control cables (CN1)

Symbol	Description	Connect to	Length	Order code
④	I/O connector kit (26 pins)	For I/O general purpose	-	R88A-CNW01C
⑤	I/O signals cable		1 m	R88A-CPKB001S-E
			2 m	R88A-CPKB002S-E
⑥	Terminal block cable	For I/O general purpose	1 m	XW2Z-100J-B34
			2 m	XW2Z-200J-B34
⑦	Terminal block (M3 screw and for pin terminals)		-	XW2B-20G4
	Terminal block (M3.5 screw and for fork/round terminals)		-	XW2B-20G5
	Terminal block (M3 screw and for fork/round terminals)		-	XW2D-20G6

External encoder cable (CN4)

Symbol	Name	Length	Order code
⑧	External encoder cable	5 m	R88A-CRKM005SR-E
		10 m	R88A-CRKM010SR-E
		20 m	R88A-CRKM020SR-E

Analog monitor (CN5)

Symbol	Name	Length	Order code
⑨	Analog monitor cable	1 m	R88A-CMK001S

MECHATROLINK-II cables (CN6)

Symbol	Specifications	Length	Order code
⑩	MECHATROLINK-II Terminator resistor	-	JEPMC-W6022-E
	MECHATROLINK-II cables	0.5 m	JEPMC-W6003-A5-E
		1 m	JEPMC-W6003-01-E
		3 m	JEPMC-W6003-03-E
		5 m	JEPMC-W6003-05-E
		10 m	JEPMC-W6003-10-E
		20 m	JEPMC-W6003-20-E
		30 m	JEPMC-W6003-30-E

MECHATROLINK-II motion controllers

Symbol	Name	Order code	
⑪	Trajexia stand-alone	Motion control unit	TJ2-MC64 (64 axes)
			TJ1-MC16 (16 axes)
	ML2 master unit		TJ1-MC04 (4 axes)
			TJ1-ML16 (16 axes)
		TJ1-ML04 (4 axes)	
	Trajexia-PLC motion controller	CJ1W-MCH72 (30 axes)	
		CJ1W-MC472 (4 axes)	
	Position controller unit for CJ1 PLC	CJ1W-NCF71 (16 axes)	
		CJ1W-NC471 (4 axes)	
		CJ1W-NC271 (2 axes)	
	Position controller unit for CS1 PLC	CS1W-NCF71 (16 axes)	
		CS1W-NC471 (4 axes)	
		CS1W-NC271 (2 axes)	

USB personal computer cable (CN7)

Symbol	Name	Length	Order code
⑫	USB mini-connector cable	2 m	AX-CUSBM002-E

Cable for safety functions (CN8)

Symbol	Description	Order code
⑬	Safety connector with 3 m cable (with loose wires at one end)	R88A-CSK003S-E

External regenerative resistor

Symbol	Specifications	Order code
⑭	50 Ω, 80 W	R88A-RR08050S
	100 Ω, 80 W	R88A-RR080100S
	47 Ω, 220 W	R88A-RR22047S
	20 Ω, 500 W	R88A-RR50020S

Filters

Symbol	Applicable servodrive	Rated current	Leakage current	Rated voltage	Order code
⑮	R88D-KN01H-ML2, R88D-KN02H-ML2	2.4 A	3.5 mA	250 VAC single-phase	R88A-FIK102-RE
	R88D-KN04H-ML2	4.1 A	3.5 mA		R88A-FIK104-RE
	R88D-KN08H-ML2	6.6 A	3.5 mA		R88A-FIK107-RE
	R88D-KN10H-ML2, R88D-KN15H-ML2	14.2 A	3.5 mA	400 VAC three-phase	R88A-FIK114-RE
	R88D-KN06F-ML2, R88D-KN10F-ML2, R88D-KN15F-ML2	4 A	0.3 mA /32 mA ^{*1}		R88A-FIK304-RE
	R88D-KN20F-ML2	6 A	0.3 mA /32 mA ^{*1}		R88A-FIK306-RE
	R88D-KN30F-ML2, R88D-KN50F-ML2	12.1 A	0.3 mA /32 mA ^{*1}		R88A-FIK312-RE

*1 Momentary peak leakage current for the filter at switch-on/off.

Connectors

Specifications	Order code
External encoder connector (for CN4)	R88A-CNK41L
Safety I/O signal connector (for CN8)	R88A-CNK81S

Computer software

Specifications	Order code
CX-Drive version 1.91 or higher	CX-DRIVE 1.91
CX-One software package including CX-Drive 1.91 or higher	CX-ONE

Accurax G5 series analog/pulse reference configuration

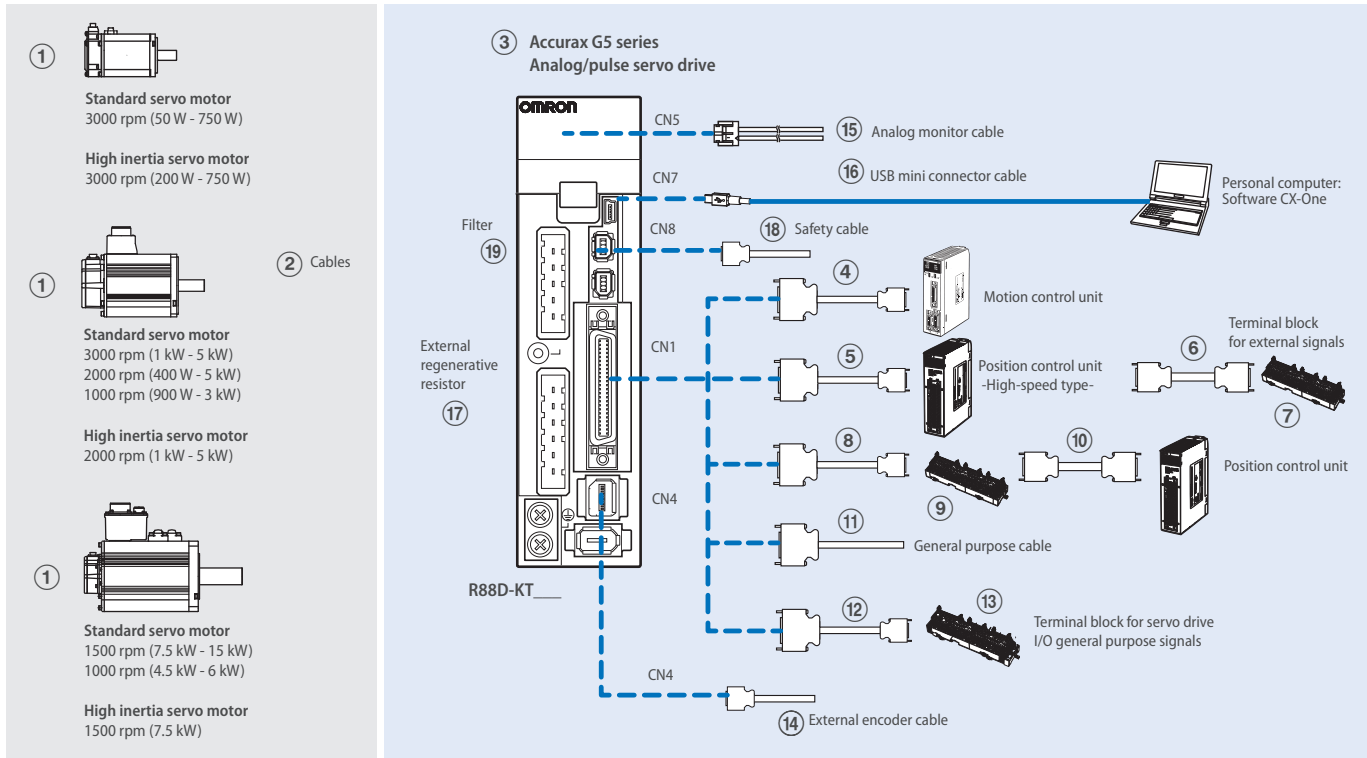

Note: The symbols ①②③④⑤... show the recommended sequence to select the components in Accurax G5 servo system

Servo motors, power and encoder cables

Note: ①② Refer to the Accurax G5 servo motor section for servomotor, motor cables or connectors selection

Servo drives

Symbol	Specifications		① Compatible Accurax G5 series rotary servo motors		Servo drive models*1		
			Standard models	High inertia models	Order code		
③	1 phase 230 VAC	100 W	R88M-K05030(H/T)-_	-	R88D-KT01H		
			R88M-K10030(H/T)-_	-			
			R88M-K20030(H/T)-_	R88M-KH20030(H/T)-_	R88D-KT02H		
		200 W	R88M-K40030(H/T)-_	R88M-KH40030(H/T)-_	R88D-KT04H		
			R88M-K75030(H/T)-_	R88M-KH75030(H/T)-_	R88D-KT08H		
			R88M-K1K020(H/T)-_	-	R88D-KT10H		
		1.0 kW	1.5 kW	R88M-K1K030(H/T)-_	-	R88D-KT15H	
				R88M-K1K530(H/T)-_	-		
				R88M-K1K520(H/T)-_	-		
			R88M-K90010(H/T)-_	-			
			3 phase 400 VAC	600 W	R88M-K40020(F/C)-_	-	R88D-KT06F
					R88M-K60020(F/C)-_	-	
	R88M-K75030(F/C)-_	-			R88D-KT10F		
	1.0 kW	R88M-K1K020(F/C)-_		R88M-KH1K020(F/C)-_	R88D-KT15F		
		R88M-K1K030(F/C)-_		-			
		R88M-K1K520(F/C)-_		R88M-KH1K520(F/C)-_			
	1.5 kW	2.0 kW	R88M-K90010(F/C)-_	-			
			R88M-K2K030(F/C)-_	-	R88D-KT20F		
			R88M-K2K020(F/C)-_	R88M-KH2K020(F/C)-_			
		3.0 kW	R88M-K3K030(F/C)-_	-	R88D-KT30F		
			R88M-K3K020(F/C)-_	R88M-KH3K020(F/C)-_			
			R88M-K2K010(F/C)-_	-			
	5.0 kW	5.0 kW	R88M-K4K030(F/C)-_	-	R88D-KT50F		
			R88M-K5K030(F/C)-_	-			
R88M-K4K020(F/C)-_			R88M-KH4K020(F/C)-_				
7.5 kW		R88M-K5K020(F/C)-_	R88M-KH5K020(F/C)-_				
		R88M-K4K510C-_	-				
		R88M-K3K010(F/C)-_	-				
15 kW	15 kW	R88M-K6K010C-_	-	R88D-KT75F			
		R88M-K7K515C-_	R88M-KH7K515C-_				
		R88M-K11K015C-_	-	R88D-KT150F			
		R88M-K15K015C-_	-				

*1 Drive Programming – embedded indexer functionality – is available in the Accurax G5 analog/pulse models with firmware 1.10 or higher.

Control cables (CN1)

Symbol	Description	Connect to	Length	Order code			
④	Control cable (1 axis)	Motion control units CS1W-MC221 CS1W-MC421	1 m	R88A-CPG001M1			
			2 m	R88A-CPG002M1			
			3 m	R88A-CPG003M1			
	Control cable (2 axes)	Motion control units CS1W-MC221 CS1W-MC421	1 m	R88A-CPG001M2			
			2 m	R88A-CPG002M2			
			3 m	R88A-CPG003M2			
5 m			R88A-CPG005M2				
⑤	Control cable (line-driver output for 1 axis)	Position control units (high-speed type) CJ1W-NC234 CJ1W-NC434	1 m	XW2Z-100J-G9			
			5 m	XW2Z-500J-G9			
			10 m	XW2Z-10MJ-G9			
	Control cable (open-collector output for 1 axis)	Position control units (high-speed type) CJ1W-NC214 CJ1W-NC414	1 m	XW2Z-100J-G13			
			3 m	XW2Z-300J-G13			
	Control cable (line-driver output for 2 axes)	Position control units (high-speed type) CJ1W-NC234 CJ1W-NC434	1 m	XW2Z-100J-G1			
			5 m	XW2Z-500J-G1			
			10 m	XW2Z-10MJ-G1			
	Control cable (open-collector output for 2 axes)	Position control units (high-speed type) CJ1W-NC214 CJ1W-NC414	1 m	XW2Z-100J-G5			
			3 m	XW2Z-300J-G5			
			⑥	Terminal block cable for external signals (for input common, forward/reverse run prohibited inputs, emergency stop input, origin proximity input and interrupt input)	Position control units (high-speed type) CJ1W-NC234 CJ1W-NC434 CJ1W-NC214 CJ1W-NC414	0.5 m	XW2Z-C50X
						1 m	XW2Z-100X
2 m	XW2Z-200X						
3 m	XW2Z-300X						
5 m	XW2Z-500X						
10 m	XW2Z-010X						
⑦	Terminal block for external signals (M3 screw, pin terminals)	–	XW2B-20G4				
	Terminal block for ext. signals (M3.5 screw, fork/round terminals)	–	XW2B-20G5				
	Terminal block for ext. signals (M3 screw, fork/round terminals)	–	XW2D-20G6				
⑧	Cable from servo relay unit to servo drive	CS1W-NC1□3, CJ1W-NC1□3, C200HW-NC113, CS1W-NC2□3/4□3, CJ1W-NC2□3/4□3, C200HW-NC213/413, CQM1H-PLB21 or CQM1-CPU43 CJ1M-CPU21/22/23	1 m	XW2Z-100J-B25			
			2 m	XW2Z-200J-B25			
			1 m	XW2Z-100J-B31			
			2 m	XW2Z-200J-B31			
⑨	Servo relay unit	Position control units CS1W-NC1□3, CJ1W-NC1□3 or C200HW-NC113	–	XW2B-20J6-1B (1 axis)			
			–	XW2B-40J6-2B (2 axes)			
		Position control units CS1W-NC2□3/4□3, CJ1W-NC2□3/4□3 or C200HW-NC213/413 CQM1H-PLB21 or CQM1-CPU43 CJ1M-CPU21/22/23	–	XW2B-20J6-3B (1 axis)			
			–	XW2B-20J6-8A (1 axis) XW2B-40J6-9A (2 axes)			
			–	XW2B-20J6-3B (1 axis)			
⑩	Position control unit connecting cable	CQM1H-PLB21	0.5 m	XW2Z-050J-A3			
			1 m	XW2Z-100J-A3			
		CS1W-NC113 or C200HW-NC113	0.5 m	XW2Z-050J-A6			
			1 m	XW2Z-100J-A6			
		CS1W-NC213/413 or C200HW-NC213/413	0.5 m	XW2Z-050J-A7			
			1 m	XW2Z-100J-A7			
		CS1W-NC133	0.5 m	XW2Z-050J-A10			
			1 m	XW2Z-100J-A10			
		CS1W-NC233/433	0.5 m	XW2Z-050J-A11			
			1 m	XW2Z-100J-A11			
		CJ1W-NC113	0.5 m	XW2Z-050J-A14			
			1 m	XW2Z-100J-A14			
		CJ1W-NC213/413	0.5 m	XW2Z-050J-A15			
			1 m	XW2Z-100J-A15			
		CJ1W-NC133	0.5 m	XW2Z-050J-A18			
			1 m	XW2Z-100J-A18			
		CJ1W-NC233/433	0.5 m	XW2Z-050J-A19			
			1 m	XW2Z-100J-A19			
		CJ1M-CPU21/22/23	0.5 m	XW2Z-050J-A33			
			1 m	XW2Z-100J-A33			
⑪	General purpose cable	For general purpose controllers	1 m	R88A-CPG001S			
			2 m	R88A-CPG002S			
⑫	Terminal block cable	For general purpose controllers	1 m	XW2Z-100J-B24			
			2 m	XW2Z-200J-B24			
⑬	Terminal block (M3 screw and for pin terminals)	–	XW2B-50G4				
	Terminal block (M3.5 screw and for fork/round terminals)	–	XW2B-50G5				
	Terminal block (M3 screw and for fork/round terminals)	–	XW2D-50G6				

External encoder cable (CN4)

Symbol	Name	Length	Order code
⑭	External encoder cable	5 m	R88A-CRKM005SR-E
		10 m	R88A-CRKM010SR-E
		20m	R88A-CRKM020SR-E

Analog monitor (CN5)

Symbol	Name	Length	Order code
⑮	Analog monitor cable	1 m	R88A-CMK001S

USB personal computer cable (CN7)

Symbol	Name	Length	Order code
⑯	USB mini-connector cable	2 m	AX-CUSBM002-E

Filters

Symbol	Applicable servodrive	Rated current	Leakage current	Rated voltage	Order code
⑰	R88D-KT01H, R88D-KT02H	2.4 A	3.5 mA	250 VAC single-phase	R88A-FIK102-RE
	R88D-KT04H	4.1 A	3.5 mA		R88A-FIK104-RE
	R88D-KT08H	6.6 A	3.5 mA		R88A-FIK107-RE
	R88D-KT10H, R88D-KT15H	14.2 A	3.5 mA		R88A-FIK114-RE
	R88D-KT06F, R88D-KT10F, R88D-KT15F	4 A	0.3 mA/32 mA ^{*1}	400 VAC three-phase	R88A-FIK304-RE
	R88D-KT20F	6 A	0.3 mA/32 mA ^{*1}		R88A-FIK306-RE
	R88D-KT30F, R88D-KT50F	12.1 A	0.3 mA/32 mA ^{*1}		R88A-FIK312-RE
	R88D-KT75F	22 A	0.3 mA/40 mA ^{*1}		R88A-FIK330-RE
	R88D-KT150F	44 A	2 mA/130 mA ^{*1}		R88A-FIK350-RE

^{*1} Momentary peak leakage current for the filter at switch-on/off.

Connectors

Specifications	Model
I/O connector kit – 50 pins – (for CN1)	R88A-CNU11C
External encoder connector (for CN4)	R88A-CNK41L
Safety I/O signal connector (for CN8)	R88A-CNK81S

Computer software

Specifications	Order code
CX-Drive version 2.10 or higher	CX-DRIVE 2.10
CX-One software package including CX-Drive 2.10 or higher	CX-ONE

External regenerative resistor

Symbol	Specifications	Order code
⑱	50 Ω, 80 W	R88A-RR08050S
	100 Ω, 80 W	R88A-RR080100S
	47 Ω, 220 W	R88A-RR22047S
	20 Ω, 500 W	R88A-RR50020S

Cable for safety functions (CN8)

Symbol	Description	Order code
⑲	Safety connector with 3 m cable (with loose wires at one end)	R88A-CSK003S-E

Specifications

Single-phase, 230 V

Servo drive type	R88D-K_	01H_	02H_	04H_	08H_	10H_	15H_
Applicable servo motor	R88M-K_	05030(H/T)-_	20030(H/T)-_	40030(H/T)-_	75030(H/T)-_	1K020(H/T)-_	1K030(H/T)-_
		10030(H/T)-_	-	-	-	-	1K530(H/T)-_
		-	-	-	-	-	1K520(H/T)-_
		-	-	-	-	-	90010(H/T)-_
Max. applicable motor capacity	W	100	200	400	750	1,000	1,500
Continuous output current	Arms	1.2	1.6	2.6	4.1	5.9	9.4
Input power	Main circuit	Single-phase/3-phase, 200 to 240 VAC + 10% to -15% (50/60 Hz)					
Supply	Control circuit	Single-phase, 200 to 240 VAC + 10% to -15% (50/60 Hz)					
Control method		IGBT-driven PWM method, sinusoidal drive					
Feedback		Serial encoder (incremental/absolute value)					
Conditions	Usage/storage temperature	0 to 55°C/-20 to 65°C					
	Usage/storage humidity	90% RH or less (non-condensing)					
	Altitude	1,000 m or less above sea level					
	Vibration/shock resistance (max.)	5.88 m/s ² 10-60 Hz (Continuous operation at resonance point is not allowed)/19.6 m/s ²					
Configuration		Base mounted					
Approx. weight	kg	0.8	1.1	1.6	1.8		

Three-phase, 400 V

Servo drive type	R88D-K_	06F_	10F_	15F_	20F_	30F_	50F_	75F_	150F_
Applicable servo motor	R88M-K_	40020(F/C)-_	75030(F/C)-_	1K030(F/C)-_	2K030(F/C)-_	3K030(F/C)-_	4K030(F/C)-_	6K010C-_	11K015C-_
		60020(F/C)-_	1K020(F/C)-_	1K530(F/C)-_	2K020(F/C)-_	3K020(F/C)-_	5K030(F/C)-_	7K515C-_	15K015C-_
		-	-	1K520(F/C)-_	-	-	2K010(F/C)-_	4K020(F/C)-_	-
		-	-	90010(F/C)-_	-	-	5K020(F/C)-_	-	-
		-	-	-	-	-	4K510C-_	-	-
		-	-	-	-	-	3K010(F/C)-_	-	-
Max. applicable motor capacity	W	0.6	1.0	1.5	2.0	3.0	5.0	7.5	15.0
Continuous output current	Arms	2.9	4.7	6.7	9.4	16.5	22.0	33.4	
Input power	Main circuit	3-phase, 380 to 480 VAC + 10% to -15% (50/60Hz)							
Supply	Control circuit	24 VDC±15%							
Control method		IGBT-driven PWM method, sinusoidal drive							
Feedback		Serial encoder (incremental/absolute value)						Absolute encoder	
Conditions	Usage/storage temperature	0 to 55°C/-20 to 65°C							
	Usage/storage humidity	90% RH or less (non-condensing)							
	Altitude	1,000 m or less above sea level							
	Vibration/shock resistance	5.88 m/s ² 10-60 Hz (Continuous operation at resonance point is not allowed)/19.6 m/s ²							
Configuration		Base mounted							
Approx. weight	kg	1.9	2.7	4.7	13.5	21.0			

Dimensions

Drive model	Specification	EtherCAT model				ML2 model				Analog/pulse model				Diagram	
		H	W	D	D1	H	W	D	D1	H	W	D	D1		
R88D-KT01/02H, R88D-KN01/02H-_	230 V	100-200 W	150	40	132	70	150	40	132	70	150	40	130	70	
R88D-KT04H, R88D-KN04H-_		400 W	150	55	132	70	150	55	132	70	150	55	130	70	
R88D-KT08H, R88D-KN08H-_		750 W	150	65	172	70	150	65	172	70	150	65	170	70	
R88D-KT10/15H, R88D-KN10/15H-_		1-1.5 kW	150	86	172	70	150	86	172	70	150	85	170	70	
R88D-KT06/10/15F, R88D-KN06/10/15F-_	400 V	600 W-1.5 kW	150	92	172	70	150	92	172	70	150	91	170	70	
R88D-KT20F, R88D-KN20F-_		2 kW	198	94	195	70	198	94	195	70	198	94	193.5	70	
R88D-KT30/50F, R88D-KN30/50F-_		3-5 kW	250	130	214	70	250	130	214	70	250	130	212	70	
R88D-KT75F, R88D-KN75H-ECT		7.5 kW	250	233	334	70	-	-	-	-	250	233	334	70	
R88D-KT150F, R88D-KN150H-ECT		15 kW	450	261	271	70	-	-	-	-	450	261	270	70	



Compact in size, big in features. Save space, save wiring, save time

The G-series servo drive with built-in MECHATROLINK-II significantly reduces wiring and set-up time, while saving up to 30% of cabinet space. So you not only save on space, wiring and installation time, but also significantly reduce the chance of connection errors.

- High response frequency of 1 kHz
- Auto-tuning for easy and quick start-up
- Vibration suppression and adaptive resonance suppression filter
- Positioning, speed and torque control modes
- Fast and accurate positioning
- Separated supply for main power and control power
- Incremental and absolute encoder available

Ordering information

G-Series MECHATROLINK-II model reference configuration

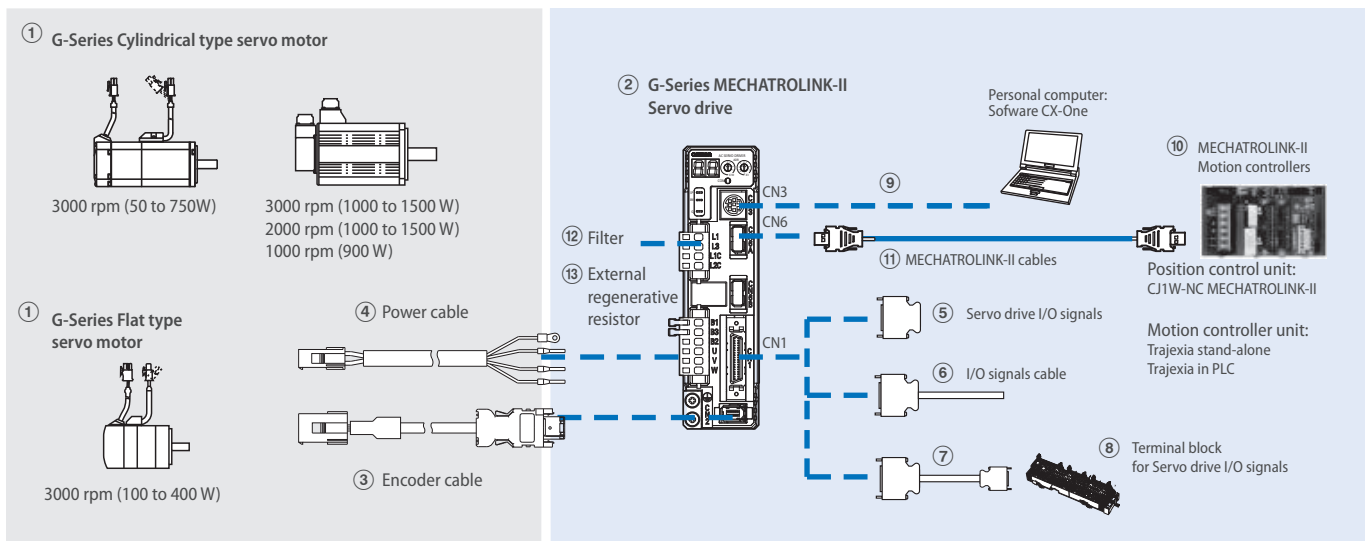

Note: The symbols ①②③④⑤ ... show the recommended sequence to select the components in a G-Series servo system

Servo motors, power & encoder cables

Note: ①③④ Refer to the G-Series servo motor section for servomotor, motor cables or connectors selection

Servo drives

Symbol	Specifications	① Compatible rotary servo motors		Servo drive model		
		Cylindrical type	Flat type			
②	1 phase 200 VAC	100 W	R88M-G05030_	R88M-GP10030_	R88D-GN01H-ML2	
		200 W	R88M-G10030_			
		400 W	R88M-G20030_	R88M-GP20030_		R88D-GN02H-ML2
		750 W	R88M-G40030_	R88M-GP40030_		R88D-GN04H-ML2
		1.0 kW	R88M-G75030_	-		R88D-GN08H-ML2
		1.5 kW	R88M-G1K020T_	-		R88D-GN10H-ML2
			R88M-G90010T_	-		R88D-GN15H-ML2
			R88M-G1K030T_	-		
			R88M-G1K520T_	-		
	R88M-G1K530T_	-				

Control cables (for CN1)

Symbol	Name	Connect to	Length	Order code
⑤	I/O connector kit	Servo drive I/O signals	-	R88A-CNU01C
⑥	General purpose cable		1 m	R88A-CPGB001S-E
			2 m	R88A-CPGB002S-E
⑦	Terminal block cable		1 m	XW2Z-100J-B33
			2 m	XW2Z-200J-B33
⑧	Terminal block		-	XW2B-20G4
				XW2B-20G5
				XW2D-20G6

Computer cable (for CN3)

Symbol	Name	Length	Order code
⑨	Computer cable RS232	2 m	R88A-CCG002P2

MECHATROLINK-II Motion controllers

Symbol	Name	Axes	Order code
⑩	Trajexia stand-alone motion controller	4	TJ1-MC04
		16	TJ1-MC16
		64	TJ2-MC64
	Trajexia-PLC motion controller,	4	CJ1W-MC472
		30	CJ1W-MCH72
		Position controller unit for CJ1 PLC	2
		4	CJ1W-NC471
		16	CJ1W-NCF71
	Position controller unit for CS1 PLC	2	CS1W-NC271
		4	CS1W-NC471
		16	CS1W-NCF71

MECHATROLINK-II cables (for CN6)

Symbol	Specifications	Length	Order code
⑪	MECHATROLINK-II Terminator resistor	-	JEPMC-W6022-E
	MECHATROLINK-II cables	0.5 m	JEPMC-W6003-A5-E
		1 m	JEPMC-W6003-01-E
		3 m	JEPMC-W6003-03-E
		5 m	JEPMC-W6003-05-E
		10 m	JEPMC-W6003-10-E
		20 m	JEPMC-W6003-20-E
		30 m	JEPMC-W6003-30-E

Filters

Symbol	Applicable servodrive	Rated current	Leakage current	Rated voltage	Order code
⑫	R88D-GN01H_ R88D-GN02H_	2.4 A	3.5 mA	250 VAC single- phase	R88A-FIK102-RE
	R88D-GN04H_	4.1 A	3.5 mA		R88A-FIK104-RE
	R88D-GN08H_	6.6 A	3.5 mA		R88A-FIK107-RE
	R88D-GN10H_ R88D-GN15H_	14.2 A	3.5 mA		R88A-FIK114-RE

External regenerative resistor

Symbol	Specifications	Order code
⑬	50 Ω, 80 W	R88A-RR08050S
	100 Ω, 80 W	R88A-RR080100S
	47 Ω, 220 W	R88A-RR22047S
	20 Ω, 500 W	R88A-RR50020S

Computer software

Specifications	Order code
Configuration and monitoring software tool for servo drives and inverters. (CX-Drive version 1.70 or higher)	CX-Drive
Complete Omron software package including CX-Drive. (CX-One version 3.10 or higher)	CX-One

G-Series analog/pulse model reference configuration

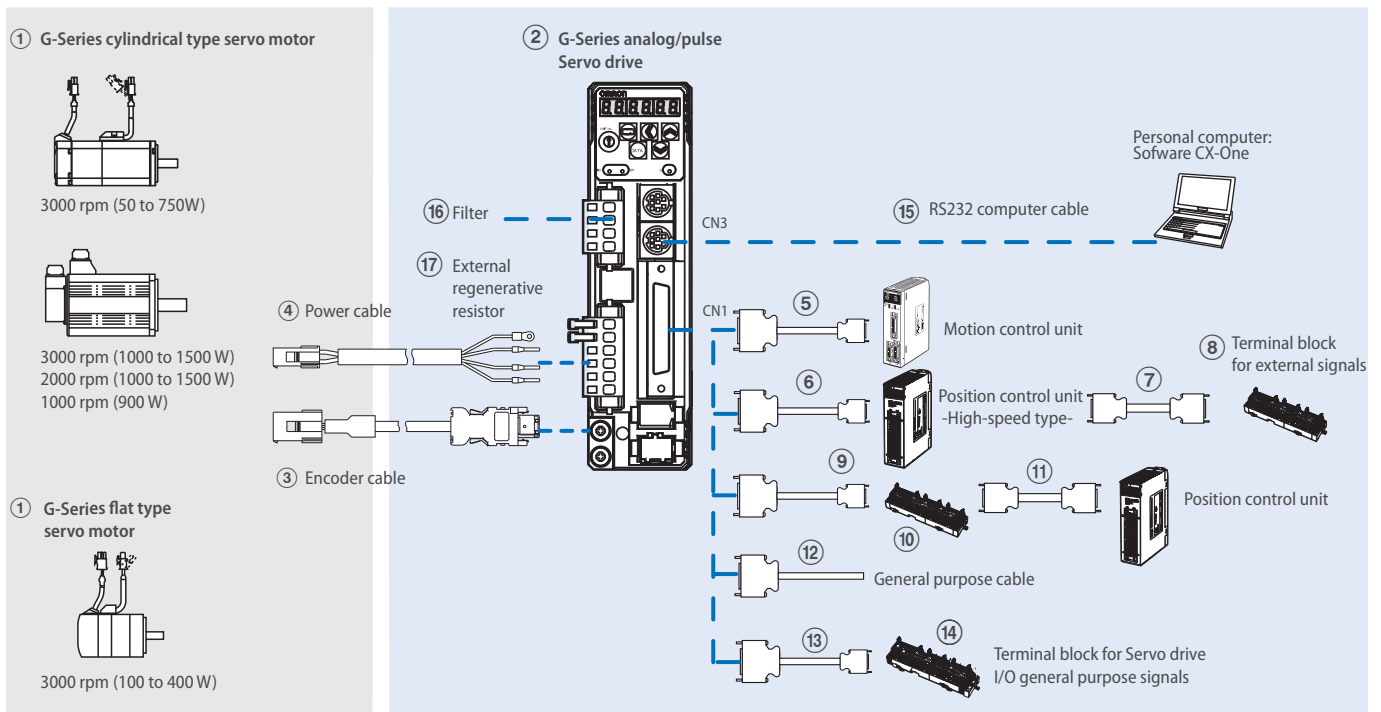

Note: The symbols ①②③④⑤... show the recommended sequence to select the components in a G-Series servo system

Servo motors, power & encoder cables

Note: ①③④ Refer to the G-Series servo motor section for servomotor, motor cables or connectors selection

Servo drives

Symbol	Specifications		① Compatible rotary servo motors		Servo drive model
			Cylindrical type	Flat type	
②	1 phase 200 VAC	100 W	R88M-G05030_	R88M-GP10030_	R88D-GT01H
			R88M-G10030_		
		200 W	R88M-G20030_	R88M-GP20030_	R88D-GT02H
			R88M-G40030_	R88M-GP40030_	R88D-GT04H
		750 W	R88M-G75030_	-	R88D-GT08H
		1.0 kW	R88M-G1K020T_	-	R88D-GT10H
		1.5 kW	R88M-G90010T_	-	R88D-GT15H
			R88M-G1K030T_	-	
			R88M-G1K520T_	-	
			R88M-G1K530T_	-	

Control cables (for CN1)

Symbol	Description	Connect to	Length	Order code	
⑤	Control cable (1 axis)	Motion control units CS1W-MC221 CS1W-MC421	1 m	R88A-CPG001M1	
			2 m	R88A-CPG002M1	
			3 m	R88A-CPG003M1	
	Control cable (2 axis)	Motion control units CS1W-MC221 CS1W-MC421	1 m	R88A-CPG001M2	
			2 m	R88A-CPG002M2	
			3 m	R88A-CPG003M2	
⑥	Control cable (line-driver output for 1 axis)	Position control units (high-speed type) CJ1W-NC234 CJ1W-NC434	1 m	XW2Z-100J-G9	
			5 m	XW2Z-500J-G9	
			10 m	XW2Z-10MJ-G9	
	Control cable (open-collector output for 1 axis)	Position control units (high-speed type) CJ1W-NC214 CJ1W-NC414	1 m	XW2Z-100J-G13	
			3 m	XW2Z-300J-G13	
	Control cable (line-driver output for 2 axis)	Position control units (high-speed type) CJ1W-NC234 CJ1W-NC434	1 m	XW2Z-100J-G1	
			5 m	XW2Z-500J-G1	
			10 m	XW2Z-10MJ-G1	
	Control cable (open-collector output for 2 axis)	Position control units (high-speed type) CJ1W-NC214 CJ1W-NC414	1 m	XW2Z-100J-G5	
			3 m	XW2Z-300J-G5	
	⑦	Terminal block cable for external signals (for input common, forward/reverse run prohibited inputs, emergency stop input, or igin proximity input and interrupt input)	Position control units (high-speed type) CJ1W-NC234 CJ1W-NC434 CJ1W-NC214 CJ1W-NC414	0.5 m	XW2Z-C50X
				1 m	XW2Z-100X
2 m				XW2Z-200X	
3 m				XW2Z-300X	
5 m				XW2Z-500X	
10 m				XW2Z-010X	
⑧	Terminal block for external signals (M3 screw, pin terminals)		–	XW2B-20G4	
	Terminal block for ext. signals (M3.5 screw, fork/round terminals)		–	XW2B-20G5	
	Terminal block for ext. signals (M3 screw, fork/round terminals)		–	XW2D-20G6	
⑨	Cable from servo relay unit to servo drive	CS1W-NC1□3, CJ1W-NC1□3, C200HW-NC113, CS1W-NC2□3/4□3, CJ1W-NC2□3/4□3, C200HW-NC213/413, CQM1H-PLB21 or CQM1- CPU43	1 m	XW2Z-100J-B25	
			2 m	XW2Z-200J-B25	
		CJ1M-CPU21/22/23	1 m	XW2Z-100J-B31	
			2 m	XW2Z-200J-B31	
⑩	Servo relay unit	Position control units CS1W-NC1□3, CJ1W-NC1□3 or C200HW-NC113	–	XW2B-20J6-1B (1 axis)	
		Position control units CS1W-NC2□3/4□3, CJ1W-NC2□3/4□3 or C200HW-NC213/413	–	XW2B-40J6-2B (2 axes)	
		CQM1H-PLB21 or CQM1-CPU43	–	XW2B-20J6-3B (1 axis)	
		CJ1M-CPU21/22/23	–	XW2B-20J6-8A (1 axis) XW2B-40J6-9A (2 axes)	
⑪	Position control unit connecting cable	CQM1H-PLB21 or CQM1-CPU43	0.5 m	XW2Z-050J-A3	
			1 m	XW2Z-100J-A3	
		CS1W-NC113 or C200HW-NC113	0.5 m	XW2Z-050J-A6	
			1 m	XW2Z-100J-A6	
		CS1W-NC213/413 or C200HW-NC213/413	0.5 m	XW2Z-050J-A7	
			1 m	XW2Z-100J-A7	
		CS1W-NC133	0.5 m	XW2Z-050J-A10	
			1 m	XW2Z-100J-A10	
		CS1W-NC233/433	0.5 m	XW2Z-050J-A11	
			1 m	XW2Z-100J-A11	
		CJ1W-NC113	0.5 m	XW2Z-050J-A14	
			1 m	XW2Z-100J-A14	
		CJ1W-NC213/413	0.5 m	XW2Z-050J-A15	
			1 m	XW2Z-100J-A15	
		CJ1W-NC133	0.5 m	XW2Z-050J-A18	
			1 m	XW2Z-100J-A18	
CJ1W-NC233/433	0.5 m	XW2Z-050J-A19			
	1 m	XW2Z-100J-A19			
CJ1M-CPU21/22/23	0.5 m	XW2Z-050J-A33			
	1 m	XW2Z-100J-A33			
⑫	General purpose cable	For general purpose controllers	1 m	R88A-CPG001S	
			2 m	R88A-CPG002S	
⑬	Terminal block cable	For general purpose controllers	1 m	XW2Z-100J-B24	
			2 m	XW2Z-200J-B24	
⑭	Terminal block (M3 screw and for pin terminals)		–	XW2B-50G4	
	Terminal block (M3.5 screw and for fork/round terminals)		–	XW2B-50G5	
	Terminal block (M3 screw and for fork/round terminals)		–	XW2D-50G6	

Computer cable (for CN3)

Symbol	Name	Length	Order code
⑮	Computer cable RS232	2 m	R88A-CCG002P2

Filters

Symbol	Applicable servodrive	Rated current	Leakage current	Rated voltage	Order code
⑯	R88D-GT1H_ R88D-GT02H_	2.4 A	3.5 mA	250 VAC single- phase	R88A-FIK102-RE
	R88D-GT04H_	4.1 A	3.5 mA		R88A-FIK104-RE
	R88D-GT08H_	6.6 A	3.5 mA		R88A-FIK107-RE
	R88D-GT10H_ R88D-GT15H_	14.2 A	3.5 mA		R88A-FIK114-RE

External regenerative resistor

Symbol	Specifications	Order code
⑰	50 Ω, 80 W	R88A-RR08050S
	100 Ω, 80 W	R88A-RR080100S
	47 Ω, 220 W	R88A-RR22047S
	20 Ω, 500 W	R88A-RR50020S

Connectors

Specifications	Order code
I/O connector kit, 50 pins (for CN1)	R88A-CNU11C

Computer software

Specifications	Order code
Configuration and monitoring software tool for servo drives and inverters. (CX-Drive version 1.70 or higher)	CX-Drive
Complete Omron software package including CX-Drive. (CX-One version 3.10 or higher)	CX-One

Specifications

General specifications

Servo drive type	R88D-G_	01H_	02H_	04H_	08H_	10H_	15H_
Applicable servomotor	R88M-G_	05030_/10030_	20030_	40030_	75030_	G1K020T_	90010T_/1K030T_/1K5_0T_
	R88M-GP_	10030_	20030_	40030_	—	—	—
Max. applicable motor capacity	W	100	200	400	750	1,000	1,500
Continuous output current	Arms	1.16	1.6	2.7	4.0	5.9	9.8
Max. output current	Arms	3.5	5.3	7.1	14.1	21.2	28.3
Input power	Main circuit	For single-phase, 200 to 240 VAC + 10% to -15% (50/60 Hz)			For single-phase/three-phase, 200 to 240 VAC + 10% to -15% (50/60 Hz)		
Supply	Control circuit	For single-phase, 200 to 240 VAC + 10% to -15% (50/60 Hz)					
Control method	IGBT-driven PWM method						
Feedback	Serial encoder (incremental/absolute)						
Conditions	Usage/storage temperature	0 to 55°C/-20 to 65°C					
	Usage/storage humidity	90% RH or less (non-condensing)					
	Altitude	1,000m or less above sea level					
	Vibration/shock resistance	5.88 m/s ² /19.6 m/s ²					
Configuration	Base mounted						
Approx. weight	Kg	0.8		1.1	1.5	1.7	

MECHATROLINK-II servo drive specifications

Position/Speed/torque control mode	Performance	Speed variance	Load variance	During 0% to 100% load ±0.01 max. (at rated speed)
			Voltage variance	0% at ±10% of rated voltage (at rated speed)
		Temperature variance	0 to 50°C ±0.1% max. (at rated speed)	
	Frequency characteristics	1 kHz		
	Torque control accuracy (reproducibility)	±3% (at 20% to 100% of rated torque)		
	Soft start time setting	0 to 10 s (acceleration time and deceleration time can be set)		
	Command input	MECHATROLINK communication	MECHATROLINK-II commands (for sequence, motion, data setting/reference, monitor, adjustment and other commands)	
I/O signal	Sequence input signal	Emergency stop, 3 external latch signals, forward/reverse torque limit, forward/reverse run prohibit, origin proximity, 3 general-purpose inputs		
	Sequence output signal	It is possible to output three types of signals: positioning completed, speed coincidence, rotation speed detection, servo ready, current limit, speed limit, brake release and warning signal		

Integrated functions	Communications	RS-232 communications	Interface	Personal computer
			Transmission rate	From 2,400 to 57,600 bps
			Functions	Parameter setting, status display, alarm display (monitor, clear, history), servo drive data tracing function, test run/autotuning operations, real time trace, absolute encoder setting, default values function
		MECHATROLINK communications	Communications protocol	MECHATROLINK-II
			Transmission rate	10 Mbps
			Data length	32 bytes
	Tuning		Horizontal and vertical axis mode. One parameter rigidity setting. Load inertia detection.	
	Dynamic brake (DB)		Operates when main power OFF, servo alarm, overtravel or servo OFF	
	Regenerative processing		Built-in regeneration resistor in models from 750 W to 1.5 kW. External regeneration resistor optionally.	
	Overtravel (OT) prevention function		Dynamic brake, disables torque or emergency stop torque during POT and NOT operation	
	Emergency stop (STOP)		Emergency stop input	
	Encoder divider function		Optional division pulses possible	
	Electronic gearing		0,01 < Numerator/Denominator < 100	
	Internal speed setting function		8 internal speeds	
	Protective functions		Overvoltage, undervoltage, overcurrent, overload, regeneration overload, servo drive overheat	
Analog monitor output		The actual servomotor speed, command speed, torque and number of accumulated pulses can be measured using an oscilloscope or other device.		
Panel operator	Display functions	A 2-digit 7-segment LED display shows the servo drive status, alarm codes, parameters, etc.		
		MECHATROLINK-II communications status LED indicator (COM)		
	Switches	Rotary switch for setting the MECHATROLINK-II node address		

Analog/pulse servo drive specifications

Control mode		Position, speed and torque control mode			
Performance	Speed variance	Load variance	During 0% to 100% load ±0.01 max. (at rated speed)		
		Voltage variance	0% at ±10% of rated voltage (at rated speed)		
		Temperature dependence	0 to 50°C ±0.1% max. (at rated speed)		
		Frequency characteristics	1 kHz		
Torque control accuracy (reproducibility)		±3% (at 20% to 100% of rated torque)			
Soft start time setting		0 to 10 s (acceleration time and deceleration time can be set)			
Position control	Input signal	Command pulse	Input pulse type Signal + pulse, 90° phase displacement 2-phase pulse (phase A/B) or reverse and forward pulses (CW/CCW) Input pulse frequency 500 kpps max. line-driver input, 200 kpps max. open-collector input Electronic gearing 0,01 < Numerator/Denominator < 100		
		Speed control		Speed reference voltage	10 VDC at 3,000 r/min: set at delivery (the scale can be set by parameters)
				Torque limit	3 VDC at rated torque (torque can be limited separately in positive/negative direction)
Speed/torque control	Input signal	Preset speed control	Preset speed is selectable from 8 internal settings by digital inputs.		
		Torque control	Torque reference voltage	3 VDC at rated torque: set at delivery (the scale and polarity can be set by parameters).	
		Speed limit	Speed limit can be set by parameter.		
I/O signal	Sequence input signal		Forward/reverse run prohibit, deviation counter reset, alarm reset, control mode switch, pulse prohibited, speed selection, gain switch, zero speed designation, origin proximity		
	Sequence output signal		Brake release, servo ready and alarm output. It is possible also to output two types of configurable signals: current limit, rotation speed detection, warning signal, speed coincidence, positioning completed		
Integrated functions	Communications	RS-232 communications	Interface	Personal computer	
			Transmission rate	From 2,400 to 57,600 bps	
			Functions	Parameter setting, status display, alarm display (monitor, clear, history), servo drive data tracing function, test run/autotuning operations, real time trace, absolute encoder setting, default values function	
		RS-485 communications data	Interface	Communication data interface between servo drives and personal computer.	
			Transmission rate	From 2,400 to 57,600 bps	
			Functions	Parameter setting, status display, alarm display (monitor, clear, history), servo drive data tracing function, test run/autotuning operations, real time trace, absolute encoder setting, default values function	
	Tuning		Horizontal and vertical axis mode. One parameter rigidity setting. Load inertia detection.		
	Dynamic brake (DB)		Operates when main power OFF, servo alarm, overtravel or servo OFF		
	Regenerative processing		Built-in regeneration resistor in models from 750 W to 1.5 kW. External regeneration resistor optionally.		
	Overtravel (OT) prevention function		Dynamic brake, disables torque or emergency stop torque during POT and NOT operation		
	Emergency stop (STOP)		Emergency stop input		
	Encoder divider function		Optional division pulses possible		
	Protective functions		Overvoltage, undervoltage, overcurrent, overload, regeneration overload, servo drive overheat		
	Analog monitor Output		The actual servomotor speed, command speed, torque and number of accumulated pulses can be measured using an oscilloscope or other device.		
	Panel operator	Display functions	A 6-digit 7-segment LED display shows the servo drive status, alarm codes, parameters, etc.		
Switches		Unit No. switch for serial communications. Value from 0 to F. To identify which servo drive the computer is accessing in RS232 communications when multiple servo drives.			

Dimensions

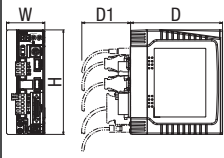
Drive model	Specification		ML2 models				Analog/pulse models				
			H	W	D	D1	H	W	D	D1	
R88D-GN01/02H-ML2, R88D-GT01/02H	200 V	100 to 200 W	150 mm	40 mm	132 mm	70 mm	150 mm	40 mm	130 mm	70 mm	
R88D-GN04H-ML2, R88D-GT04H		400 W	150 mm	55 mm	132 mm	70 mm	150 mm	55 mm	130 mm	70 mm	
R88D-GN08H-ML2, R88D-GT08H		750 W	150 mm	65 mm	172 mm	70 mm	150 mm	65 mm	170 mm	70 mm	
R88D-GN10/15H-ML2, R88D-GT10/15H		1 kW to 1.5 kW	150 mm	85 mm	172 mm	70 mm	150 mm	85 mm	170 mm	70 mm	



Another step forward in drive simplicity

The new SmartStep offers an ideal solution for point-to-point motion applications where simplicity is essential. SmartStep 2 keeps things simple whilst combining high performance and advanced features in a cost effective solution.

- On-line Auto-tuning and Easy set up
- Ultra-compact size. The footprint is only 48% compared to the previous SmartStep
- Two torque limits
- Electronic gear, four internal speed settings and wide range of pulse settings
- Adaptive resonance suppression filter
- Position control via pulse input 500 kpps
- Configuration and commissioning using CX Drive-software

Ordering information

SmartStep2 servo drive configuration (100-400 W)

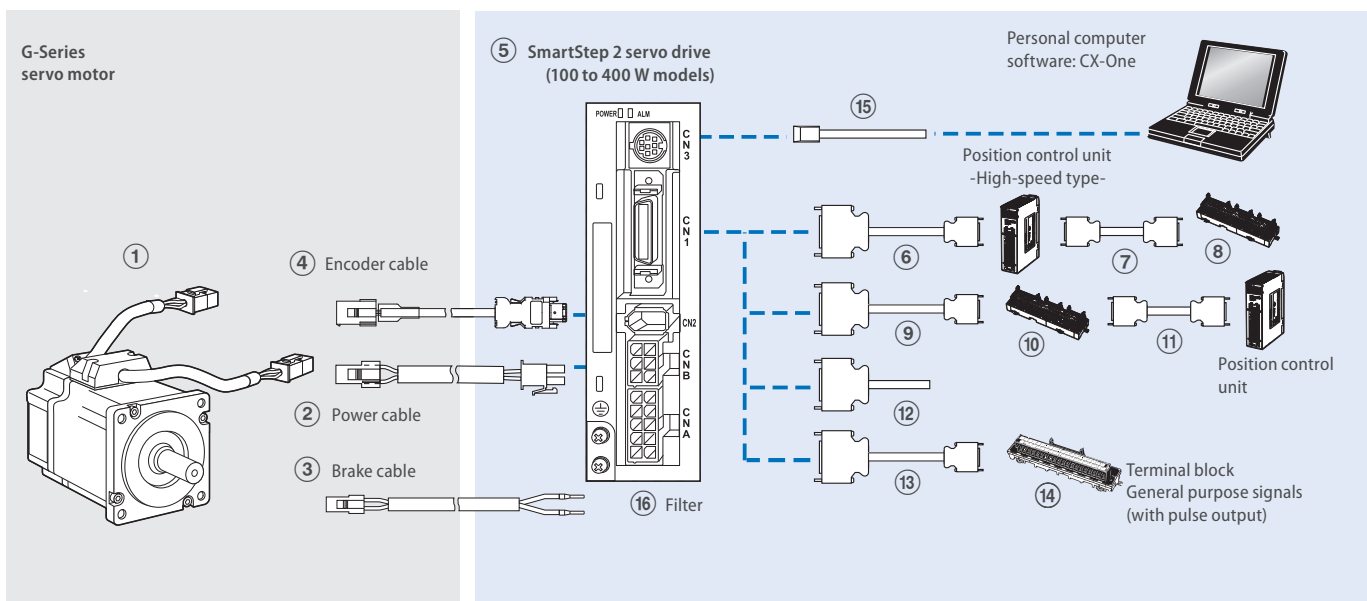

Note: The symbols ①②③④⑤ ... show the recommended sequence to select the components in a SmartStep 2 servo system

Servo motor

Note: ①②③④ refer to G-Series motor section for detailed motor specifications and selection.

Servo drives

Symbol	Specifications	① Compatible servo motors		SmartStep 2 drive model
		Cylindrical type	Flat type	Order code
⑤	200 VAC	100 W	–	R7D-BP01H
		200 W	R88M-GP10030H-__	R7D-BP02HH
		400 W	R88M-GP40030H-__	R7D-BP04H

Power supply cables (for CNA)

Symbol	Specifications	Appearance	Order code
⑤	Power supply input cable for single-phase power (connectors attached)		R7A-CLB002S2

Control cables (for CN1)

Symbol	Description	Connect to	Length	Order code
⑥	Control cable (line-driver output for 1 axis)	Position control unit (high-speed type) CJ1W-NC234 CJ1W-NC434	1 m	XW2Z-100J-G12
			5 m	XW2Z-500J-G12
			10 m	XW2Z-10MJ-G12
Control cable (open-collector output for 1 axis)	Position control unit (high-speed type) CJ1W-NC214 CJ1W-NC414	1 m	XW2Z-100J-G16	
		3 m	XW2Z-300J-G16	
Control cable (line-driver output for 2 axis)	Position control unit (high-speed type) CJ1W-NC234 CJ1W-NC434	1 m	XW2Z-100J-G4	
		5 m	XW2Z-500J-G4	
		10 m	XW2Z-10MJ-G4	
Control cable (open-collector output for 2 axis)	Position control unit (high-speed type) CJ1W-NC214 CJ1W-NC414	1 m	XW2Z-100J-G8	
		3 m	XW2Z-300J-G8	

Symbol	Description	Connect to	Length	Order code
⑦	Terminal block cable for external signals (for input common, forward/reverse run prohibited inputs, emergency stop input, origin proximity input and interrupt input)	Position control units (high-speed type) CJ1W-NC234 CJ1W-NC434 CJ1W-NC214 CJ1W-NC414	0.5 m	XW2Z-C50X
			1 m	XW2Z-100X
			2 m	XW2Z-200X
			3 m	XW2Z-300X
			5 m	XW2Z-500X
			10 m	XW2Z-010X
⑧	Terminal block for external signals (with M3 screw and for pin terminals)		-	XW2B-20G4
	Terminal block ext. signals (with M3.5 screw and for fork/round terminals)		-	XW2B-20G5
	Terminal block ext. signals (with M3 screw and fork/round pin terminals)		-	XW2D-20G6
⑨	Cable from servo relay unit to servo drive	CS1W-NC1_3, CJ1W-NC1_3, C200HW-NC113, CS1W-NC2_3/4_3, CJ1W-NC2_3/4_3, C200HW-NC213/413, CQM1H-PLB21 or CQM1-CPU43-V1	1 m	XW2Z-100J-B29
			2 m	XW2Z-200J-B29
		CJ1M-CPU21/22/23	1 m	XW2Z-100J-B32
			2 m	XW2Z-200J-B32
⑩	Servo relay unit	CS1W-NC1_3, CJ1W-NC1_3 or C200HW-NC113 position control unit	-	XW2B-20J6-1B (1 axis)
		CS1W-NC2_3/4_3, CJ1W-NC2_3/4_3 or C200HW-NC213/413 position control unit	-	XW2B-40J6-2B (2 axes)
		CQM1H-PLB21 or CQM1-CPU43-V1	-	XW2B-20J6-3B (1 axis)
		CJ1M-CPU21/22/23	-	XW2B-20J6-8A (1 axis)
			-	XW2B-40J6-9A (2 axes)
⑪	Position control unit connecting cable	CJ1W-NC133	0.5 m	XW2Z-050J-A18
			1 m	XW2Z-100J-A18
		CJ1W-NC233/433	0.5 m	XW2Z-050J-A19
			1 m	XW2Z-100J-A19
		CS1W-NC133	0.5 m	XW2Z-050J-A10
			1 m	XW2Z-100J-A10
		CS1W-NC233/433	0.5 m	XW2Z-050J-A11
			1 m	XW2Z-100J-A11
		CJ1W-NC113	0.5 m	XW2Z-050J-A14
			1 m	XW2Z-100J-A14
		CJ1W-NC213/413	0.5 m	XW2Z-050J-A15
			1 m	XW2Z-100J-A15
		CS1W-NC113 C200HW-NC113	0.5 m	XW2Z-050J-A6
			1 m	XW2Z-100J-A6
		CS1W-NC213/413 C200HW-NC213/413	0.5 m	XW2Z-050J-A7
			1 m	XW2Z-100J-A7
		CJ1M-CPU21/22/23	0.5 m	XW2Z-050J-A33
			1 m	XW2Z-100J-A33
		CQM1H-PLB21 CQM1-CPU43-V1	0.5 m	XW2Z-050J-A3
			1 m	XW2Z-100J-A3
⑫	General purpose cable	For general purpose controllers	1 m	R7A-CPB001S
⑬	Terminal block cable	For general purpose controllers	2 m	R7A-CPB002S
			1 m	XW2Z-100J-B28
⑭	Terminal block (with M3 screw and for pin terminals)		2 m	XW2Z-200J-B28
			-	XW2B-34G4
			-	XW2B-34G5
			-	XW2D-34G6

Cable for CN3

Symbol	Name	Length	Order code
⑮	Personal Computer Monitor Cable	2 m	R88A-CCG002P2

Filters

Symbol	Applicable servo drive	Rated current	Rated voltage	Order code
⑯	R7D-BP01H/ 02HH/ 04H	4 A	1 pH, 230 V	R7A-FIB104-RE

Connectors

Specifications	Order code
Main Circuit Connector (CNA)	R7A-CNB01P
Servomotor Connector (CNB)	R7A-CNB01A
Control I/O Connector (CN1)	R88A-CNW01C
Encoder Input Connector (CN2)	R88A-CNW01R
Servomotor Connector for Encoder Cable	R88A-CNG02R
Servomotor Connector for Servomotor Power Cable	R88A-CNG01A
Brake Cable Connector	R88A-CNG01B

External regeneration resistor

Specification	Order code
80 W, 50 Ω	R88A-RR08050S
80 W, 100 Ω	R88A-RR080100S
220 W, 47 Ω	R88A-RR22047S

External regeneration resistor cable

Specifications	Order code
External Regenerative Resistor Connection Cable, 2 meters	R7A-CLB002RG

Parameter unit & computer software

Specifications	Order code
Parameter copy unit (with cable)	R88A-PRO2G
Configuration and monitoring software tool for servo drives and inverters. (CX-Drive version 1.8 or higher)	CX-Drive

SmartStep2 servo drive configuration (750 W)

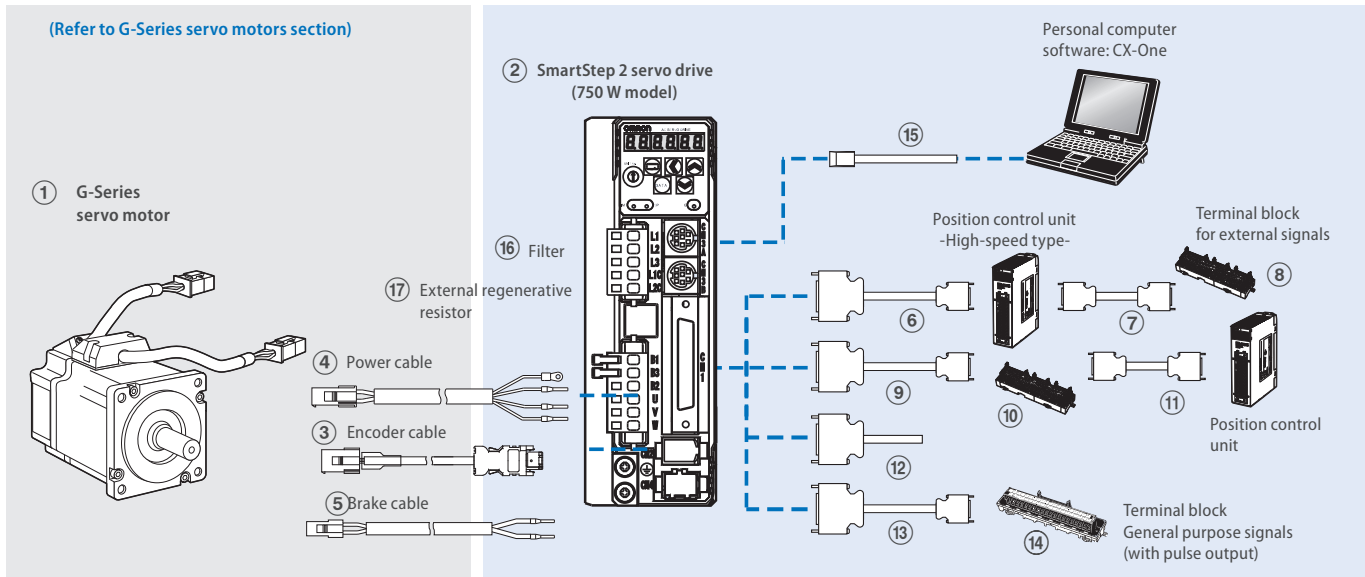

Note: The symbols ①②③④⑤ ... show the recommended sequence to select the components in a SmartStep 2 servo system.

Servo motor

Note: ①③④⑤ refer to G-Series motor section for detailed motor specifications and selection.

Servo drives

Symbol	Specifications		① Compatible rotary servo motors	Servo drive model
			Cylindrical type	Order code
②	1 phase 200 VAC	750 W	R88M-G75030H-__	R88D-GP08H

Control cables (for CN1)

Symbol	Description	Connect to	Length	Order code
⑥	Control cable (line-driver output for 1 axis)	Position control units (high-speed type) CJ1W-NC234 CJ1W-NC434	1 m 5 m 10 m	XW2Z-100J-G9 XW2Z-500J-G9 XW2Z-10MJ-G9
	Control cable (open-collector output for 1 axis)	Position control units (high-speed type) CJ1W-NC214 CJ1W-NC414	1 m 3 m	XW2Z-100J-G13 XW2Z-300J-G13
	Control cable (line-driver output for 2 axis)	Position control units (high-speed type) CJ1W-NC234 CJ1W-NC434	1 m 5 m 10 m	XW2Z-100J-G1 XW2Z-500J-G1 XW2Z-10MJ-G1
	Control cable (open-collector output for 2 axis)	Position control units (high-speed type) CJ1W-NC214 CJ1W-NC414	1 m 3 m	XW2Z-100J-G5 XW2Z-300J-G5
⑦	Terminal block cable for external signals (for input common, forward/reverse run prohibited inputs, emergency stop input, or origin proximity input and interrupt input)	Position control units (high-speed type) CJ1W-NC234 CJ1W-NC434 CJ1W-NC214 CJ1W-NC414	0.5 m	XW2Z-C50X
			1 m	XW2Z-100X
			2 m	XW2Z-200X
			3 m	XW2Z-300X
			5 m	XW2Z-500X
			10 m	XW2Z-010X
⑧	Terminal block for external signals (M3 screw, pin terminals)		-	XW2B-20G4
	Terminal block ext. signals (M3.5 screw, fork/round terminals)		-	XW2B-20G5
	Terminal block ext. signals (M3 screw, fork/round terminals)		-	XW2D-20G6
⑨	Cable from servo relay unit to servo drive	CS1W-NC1_3, CJ1W-NC1_3, C200HW-NC113/213/413, CS1W-NC2_3/4_3, CJ1W-NC2_3/4_3 or CQM1H-PLB21	1 m	XW2Z-100J-B25
			2 m	XW2Z-200J-B25
		CJ1M-CPU21/22/23	1 m	XW2Z-100J-B31
			2 m	XW2Z-200J-B31
⑩	Servo relay unit	CS1W-NC1_3, CJ1W-NC1_3 or C200HW-NC113 position control unit	-	XW2B-20J6-1B (1 axis)
		CS1W-NC2_3/4_3, CJ1W-NC2_3/4_3 or C200HW-NC213/413 position control unit	-	XW2B-40J6-2B (2 axes)
		CQM1H-PLB21	-	XW2B-20J6-3B (1 axis)
		CJ1M-CPU21/22/23	-	XW2B-20J6-8A (1 axis)
			-	XW2B-40J6-9A (2 axes)

Symbol	Description	Connect to	Length	Order code
⑪	Position control unit connecting cable	CQM1H-PLB21	0.5 m	XW2Z-050J-A3
			1 m	XW2Z-100J-A3
		CS1W-NC113 or C200HW-NC113	0.5 m	XW2Z-050J-A6
			1 m	XW2Z-100J-A6
		CS1W-NC213/413 or C200HW-NC213/413	0.5 m	XW2Z-050J-A7
			1 m	XW2Z-100J-A7
		CS1W-NC133	0.5 m	XW2Z-050J-A10
			1 m	XW2Z-100J-A10
		CS1W-NC233/433	0.5 m	XW2Z-050J-A11
			1 m	XW2Z-100J-A11
		CJ1W-NC113	0.5 m	XW2Z-050J-A14
			1 m	XW2Z-100J-A14
		CJ1W-NC213/413	0.5 m	XW2Z-050J-A15
			1 m	XW2Z-100J-A15
CJ1W-NC133	0.5 m	XW2Z-050J-A18		
	1 m	XW2Z-100J-A18		
CJ1W-NC233/433	0.5 m	XW2Z-050J-A19		
	1 m	XW2Z-100J-A19		
CJ1M-CPU21/22/23	0.5 m	XW2Z-050J-A33		
	1 m	XW2Z-100J-A33		
⑫	General purpose cable	For general purpose controllers	1 m	R88A-CPG001S
			2 m	R88A-CPG002S
⑬	Terminal block cable	For general purpose controllers	1 m	XW2Z-100J-B24
			2 m	XW2Z-200J-B24
⑭	Terminal block (M3 screw and for pin terminals)		-	XW2B-50G4
	Terminal block (M3.5 screw and for fork/round terminals)		-	XW2B-50G5
	Terminal block (M3 screw and for fork/round terminals)		-	XW2D-50G6

Computer cable (for CN3)

Symbol	Name	Length	Order code
⑮	Computer cable RS232	2 m	R88A-CCG002P2

Filter

Symbol	Rated current	Leakage current	Rated voltage	Applicable servodrive	Order code
⑯	6.6 A	3.5 mA	250 VAC single-phase	R88D-GP08H	R88A-FIK107-RE

External regenerative resistor

Symbol	Specifications	Order code
⑰	50 Ω, 80 W	R88A-RR08050S
	100 Ω, 80 W	R88A-RR080100S
	47 Ω, 220 W	R88A-RR22047S
	20 Ω, 500 W	R88A-RR50020S

Connectors

Specifications	Order code
I/O connector kit -50 pins- (for CN1)	R88A-CNU11C
Power cable connector (motor side)	R88A-CNG01A
Encoder connector (Servo drive side CN2)	R88A-CNW01R
Incremental encoder cable connector (motor side)	R88A-CNG02R

Computer software

Specifications	Order code
Configuration and monitoring software tool for servo drives and inverters (CX-Drive version 1.91 or higher).	CX-Drive

Specifications

Performance specifications

Item	200 VAC input type			
	100 W R7D-BP01H	200 W R7D-BP02HH	400 W R7D-BP04H	750 W R88D-GP08H
Continuous output current (rms)	1.0 A	1.6 A	2.5 A	4 A
Momentary maximum output current (rms)	3.3 A	4.9 A	7.8 A	14.1 A
Main-circuit power supply	Single-phase 200 to 240 VAC (170 to 264 V), 50/60 Hz			Single-phase/three-phase 200 to 240 VAC (170 to 264 V), 50/60 Hz
Control circuit input power	-			Single-phase 200 to 240 VAC (170 to 264 V)
Control method	All-digital method			
Feedback	10,000 pulses/revolution incremental encoder			
Inverter method	PWM method based on IGBT			
PWM frequency	12 kHz		6 kHz	
Weight	0.35 kg	0.42 kg	0.42 kg	1.5 kg
Compatible motor voltage	200 V			
Command pulse response	Line drive: 500 kpps			
Compatible motor capacity	50 W 100 W	200 W	400 W	750 W
Applicable servo motor (R88M-)	G05030H G10030H GP10030H	G020030H GP20030H	G40030H GP40030H	G75030H

Dimensions

R7D-BP01H (230 V, 100 W)

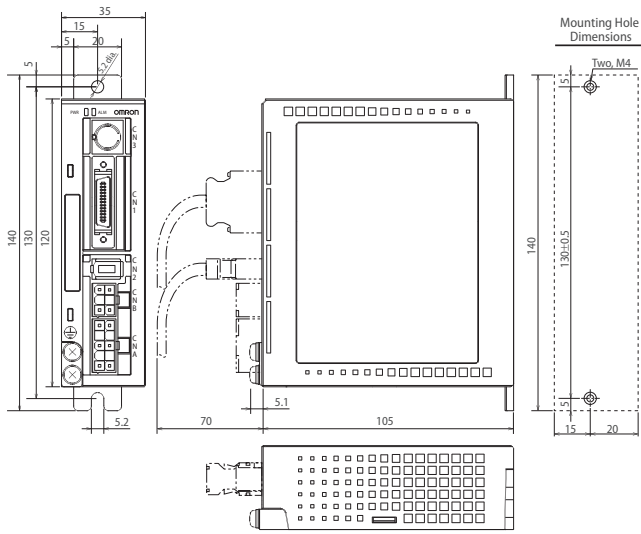

R7D-BP02HH/04H (230 V, 200-400 W)

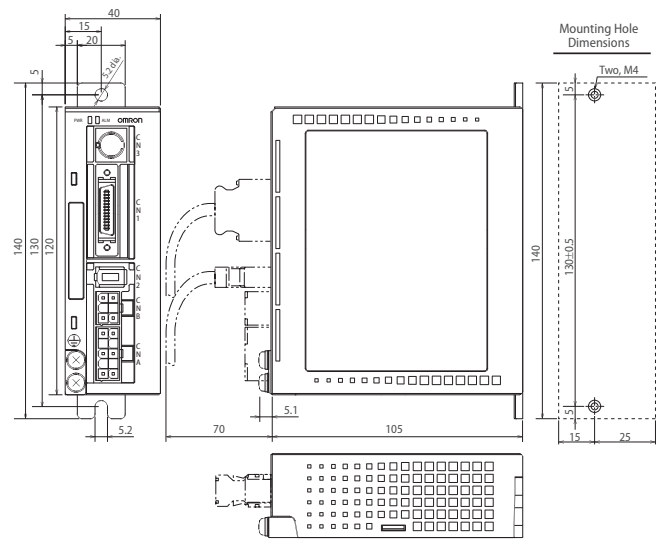

R88D-GP08H (230 V, 750 W)

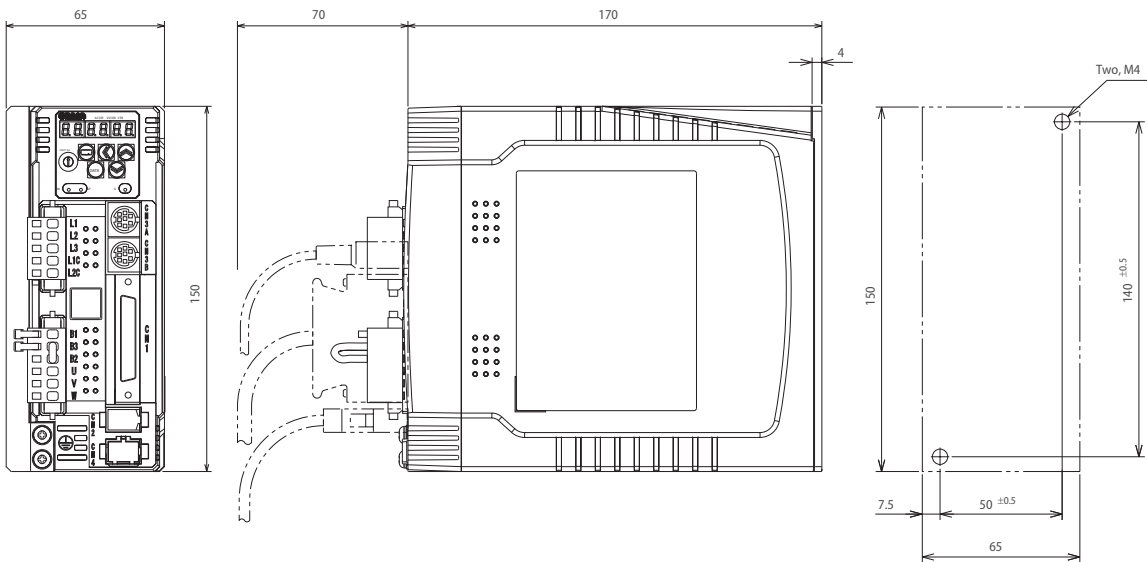



Servo motor family for accurate motion control

Accurax G5 servo motors include IP67 protection and connectors on the motor body. Use of 10 pole motors and 20 bit encoder results in 40% reduction in motor cogging. The servomotors are 25% lighter and 15% smaller due to patented new stator design PACK & CLAMP technology, 40% iron loss reduction and 15% smaller encoder.

- Standard and high inertia servo motor models
- Peak torque 300% of rated torque during 3 seconds or more depending on model
- High accuracy provided by a 20 bit resolution encoder, ABS encoder as an option
- IP67 protection in all models
- Ultra-light and compact size motor
- Low speed ripple and low torque ripple due to low torque cogging
- Various shaft, brake and seal options

Ordering information

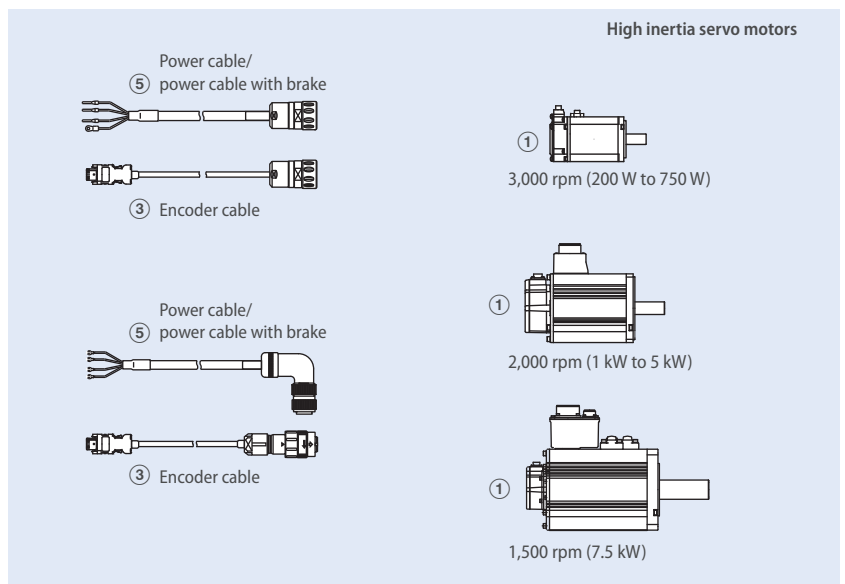
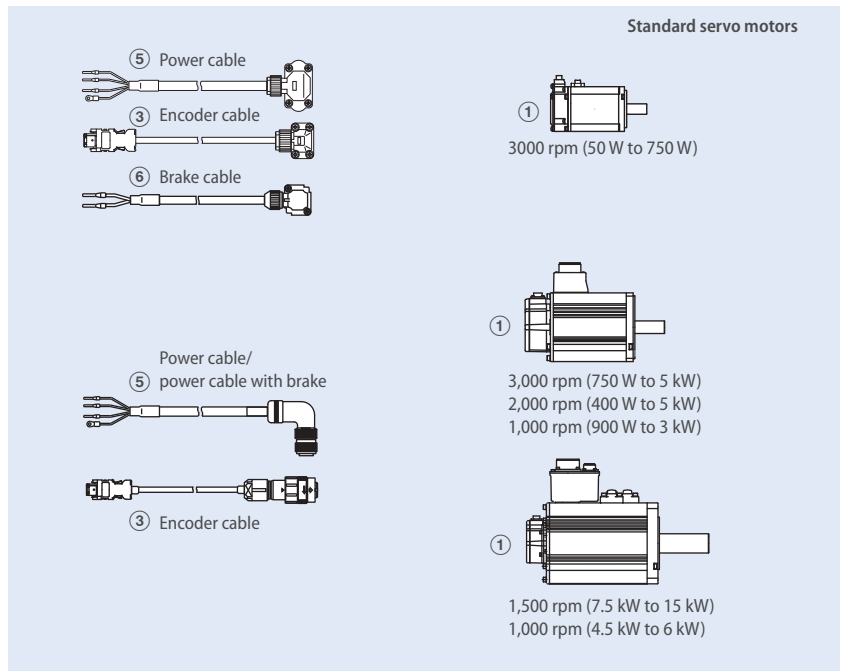
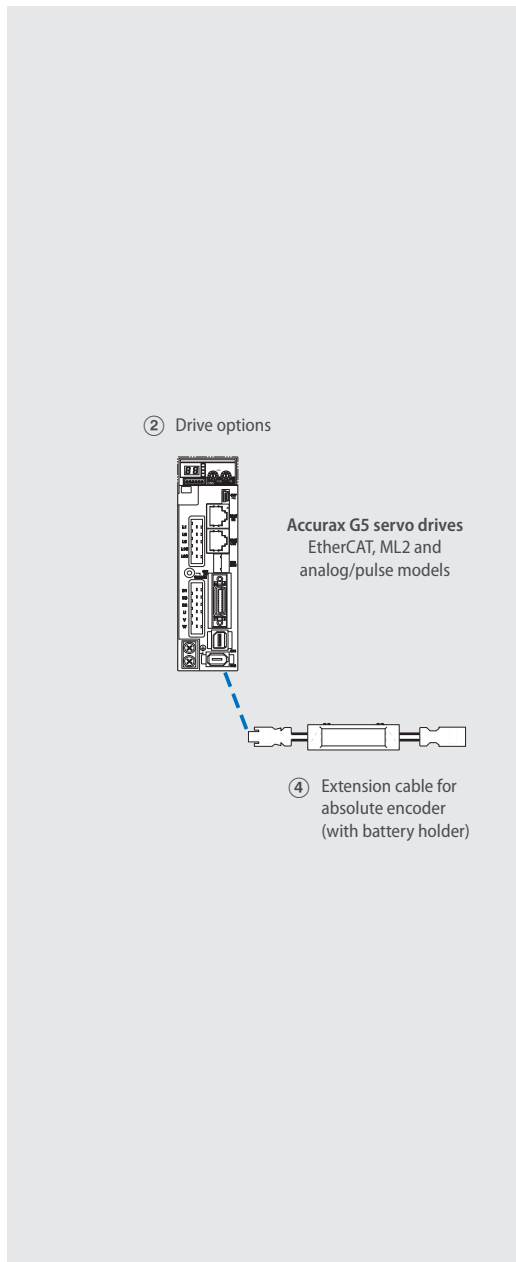

Note: The symbols ①②③ ... show the recommended sequence to select the servo motor and cables

Servo motor



① Select motor from R88M-K or R88M-KH families using motor tables in next pages.

Servo drive

② Refer to Accurax G5 servo drive section for detailed drive specifications and selection of drive accessories.

Standard servo motors

Servo motors 3,000 r/min (50 to 5,000 W)

Symbol	Specifications				② Compatible servo drives		Order code				
	Voltage	Encoder and design		Rated torque	Capacity	G5 EtherCAT/ML2		G5 analog/pulse			
①  230 V (50 to 750 W)  230 V (1,000 to 1,500 W) 400 V (750 to 5,000 W)	230 V	Incremental encoder (20 bit) Straight shaft with key and tap	Without brake	0.16 Nm	50 W	R88D-KN01H-__	R88D-KT01H	R88M-K05030H-S2			
				0.32 Nm	100 W	R88D-KN01H-__	R88D-KT01H	R88M-K10030H-S2			
				0.64 Nm	200 W	R88D-KN02H-__	R88D-KT02H	R88M-K20030H-S2			
				1.3 Nm	400 W	R88D-KN04H-__	R88D-KT04H	R88M-K40030H-S2			
				2.4 Nm	750 W	R88D-KN08H-__	R88D-KT08H	R88M-K75030H-S2			
				3.18 Nm	1,000 W	R88D-KN15H-__	R88D-KT15H	R88M-K1K030H-S2			
				4.77 Nm	1,500 W	R88D-KN15H-__	R88D-KT15H	R88M-K1K530H-S2			
				With brake	0.16 Nm	50 W	R88D-KN01H-__	R88D-KT01H	R88M-K05030H-B52		
					0.32 Nm	100 W	R88D-KN01H-__	R88D-KT01H	R88M-K10030H-B52		
			0.64 Nm		200 W	R88D-KN02H-__	R88D-KT02H	R88M-K20030H-B52			
			1.3 Nm		400 W	R88D-KN04H-__	R88D-KT04H	R88M-K40030H-B52			
			2.4 Nm		750 W	R88D-KN08H-__	R88D-KT08H	R88M-K75030H-B52			
			3.18 Nm		1,000 W	R88D-KN15H-__	R88D-KT15H	R88M-K1K030H-B52			
			4.77 Nm		1,500 W	R88D-KN15H-__	R88D-KT15H	R88M-K1K530H-B52			
			400 V		Incremental encoder (20 bit) Straight shaft with key and tap	Without brake	2.39 Nm	750 W	R88D-KN10F-__	R88D-KT10F	R88M-K75030F-S2
							3.18 Nm	1,000 W	R88D-KN15F-__	R88D-KT15F	R88M-K1K030F-S2
				4.77 Nm			1,500 W	R88D-KN15F-__	R88D-KT15F	R88M-K1K530F-S2	
				6.37 Nm			2,000 W	R88D-KN20F-__	R88D-KT20F	R88M-K2K030F-S2	
	9.55 Nm	3,000 W		R88D-KN30F-__			R88D-KT30F	R88M-K3K030F-S2			
	12.7 Nm	4,000 W		R88D-KN50F-__			R88D-KT50F	R88M-K4K030F-S2			
	15.9 Nm	5,000 W		R88D-KN50F-__			R88D-KT50F	R88M-K5K030F-S2			
	With brake	2.39 Nm		750 W			R88D-KN10F-__	R88D-KT10F	R88M-K75030F-B52		
		3.18 Nm		1,000 W			R88D-KN15F-__	R88D-KT15F	R88M-K1K030F-B52		
		4.77 Nm		1,500 W		R88D-KN15F-__	R88D-KT15F	R88M-K1K530F-B52			
		6.37 Nm		2,000 W		R88D-KN20F-__	R88D-KT20F	R88M-K2K030F-B52			
		9.55 Nm		3,000 W		R88D-KN30F-__	R88D-KT30F	R88M-K3K030F-B52			
		12.7 Nm		4,000 W		R88D-KN50F-__	R88D-KT50F	R88M-K4K030F-B52			
		15.9 Nm		5,000 W		R88D-KN50F-__	R88D-KT50F	R88M-K5K030F-B52			
		Absolute encoder (17 bit) Straight shaft with key and tap		Without brake		2.39 Nm	750 W	R88D-KN10F-__	R88D-KT10F	R88M-K75030C-S2	
						3.18 Nm	1,000 W	R88D-KN15F-__	R88D-KT15F	R88M-K1K030C-S2	
	4.77 Nm					1,500 W	R88D-KN15F-__	R88D-KT15F	R88M-K1K530C-S2		
	6.37 Nm					2,000 W	R88D-KN20F-__	R88D-KT20F	R88M-K2K030C-S2		
	9.55 Nm		3,000 W		R88D-KN30F-__	R88D-KT30F	R88M-K3K030C-S2				
	12.7 Nm		4,000 W		R88D-KN50F-__	R88D-KT50F	R88M-K4K030C-S2				
	15.9 Nm		5,000 W		R88D-KN50F-__	R88D-KT50F	R88M-K5K030C-S2				
	With brake		2.39 Nm		750 W	R88D-KN10F-__	R88D-KT10F	R88M-K75030C-B52			
3.18 Nm			1,000 W		R88D-KN15F-__	R88D-KT15F	R88M-K1K030C-B52				
4.77 Nm			1,500 W	R88D-KN15F-__	R88D-KT15F	R88M-K1K530C-B52					
6.37 Nm			2,000 W	R88D-KN20F-__	R88D-KT20F	R88M-K2K030C-B52					
9.55 Nm			3,000 W	R88D-KN30F-__	R88D-KT30F	R88M-K3K030C-B52					
12.7 Nm			4,000 W	R88D-KN50F-__	R88D-KT50F	R88M-K4K030C-B52					
15.9 Nm			5,000 W	R88D-KN50F-__	R88D-KT50F	R88M-K5K030C-B52					



Servo motors 2,000 r/min (1 to 5 kW)

Symbol	Specifications				② Compatible servo drives		Order code			
	Voltage	Encoder and design		Rated torque	Capacity	G5 EtherCAT/ML2		G5 analog/pulse		
	230 V	Incremental encoder (20 bit) Straight shaft with key and tap	Without brake	4.77 Nm	1,000 W	R88D-KN10H-__	R88D-KT10H	R88M-K1K020H-S2		
				7.16 Nm	1,500 W	R88D-KN15H-__	R88D-KT15H	R88M-K1K520H-S2		
				4.77 Nm	1,000 W	R88D-KN10H-__	R88D-KT10H	R88M-K1K020H-BS2		
			With brake	7.16 Nm	1,500 W	R88D-KN15H-__	R88D-KT15H	R88M-K1K520H-BS2		
				Absolute encoder (17 bit) Straight shaft with key and tap	Without brake	4.77 Nm	1,000 W	R88D-KN10H-__	R88D-KT10H	R88M-K1K020T-S2
						7.16 Nm	1,500 W	R88D-KN15H-__	R88D-KT15H	R88M-K1K520T-S2
		With brake	4.77 Nm	1,000 W	R88D-KN10H-__	R88D-KT10H	R88M-K1K020T-BS2			
			7.16 Nm	1,500 W	R88D-KN15H-__	R88D-KT15H	R88M-K1K520T-BS2			
		400 V	Incremental encoder (20 bit) Straight shaft with key and tap	Without brake	1.91 Nm	400 W	R88D-KN06F-__	R88D-KT06F	R88M-K40020F-S2	
					2.86 Nm	600 W	R88D-KN06F-__	R88D-KT06F	R88M-K60020F-S2	
					4.77 Nm	1,000 W	R88D-KN10F-__	R88D-KT10F	R88M-K1K020F-S2	
					7.16 Nm	1,500 W	R88D-KN15F-__	R88D-KT15F	R88M-K1K520F-S2	
					9.55 Nm	2,000 W	R88D-KN20F-__	R88D-KT20F	R88M-K2K020F-S2	
					14.3 Nm	3,000 W	R88D-KN30F-__	R88D-KT30F	R88M-K3K020F-S2	
	19.1 Nm				4,000 W	R88D-KN50F-__	R88D-KT50F	R88M-K4K020F-S2		
	23.9 Nm				5,000 W	R88D-KN50F-__	R88D-KT50F	R88M-K5K020F-S2		
	With brake				1.91 Nm	400 W	R88D-KN06F-__	R88D-KT06F	R88M-K40020F-BS2	
					2.86 Nm	600 W	R88D-KN06F-__	R88D-KT06F	R88M-K60020F-BS2	
					4.77 Nm	1,000 W	R88D-KN10F-__	R88D-KT10F	R88M-K1K020F-BS2	
					7.16 Nm	1,500 W	R88D-KN15F-__	R88D-KT15F	R88M-K1K520F-BS2	
					9.55 Nm	2,000 W	R88D-KN20F-__	R88D-KT20F	R88M-K2K020F-BS2	
					14.3 Nm	3,000 W	R88D-KN30F-__	R88D-KT30F	R88M-K3K020F-BS2	
				19.1 Nm	4,000 W	R88D-KN50F-__	R88D-KT50F	R88M-K4K020F-BS2		
	Absolute encoder (17 bit) Straight shaft with key and tap			Without brake	1.91 Nm	400 W	R88D-KN06F-__	R88D-KT06F	R88M-K40020C-S2	
					2.86 Nm	600 W	R88D-KN06F-__	R88D-KT06F	R88M-K60020C-S2	
					4.77 Nm	1,000 W	R88D-KN10F-__	R88D-KT10F	R88M-K1K020C-S2	
					7.16 Nm	1,500 W	R88D-KN15F-__	R88D-KT15F	R88M-K1K520C-S2	
					9.55 Nm	2,000 W	R88D-KN20F-__	R88D-KT20F	R88M-K2K020C-S2	
14.3 Nm					3,000 W	R88D-KN30F-__	R88D-KT30F	R88M-K3K020C-S2		
19.1 Nm					4,000 W	R88D-KN50F-__	R88D-KT50F	R88M-K4K020C-S2		
23.9 Nm				5,000 W	R88D-KN50F-__	R88D-KT50F	R88M-K5K020C-S2			
With brake				1.91 Nm	400 W	R88D-KN06F-__	R88D-KT06F	R88M-K40020C-BS2		
				2.86 Nm	600 W	R88D-KN06F-__	R88D-KT06F	R88M-K60020C-BS2		
				4.77 Nm	1,000 W	R88D-KN10F-__	R88D-KT10F	R88M-K1K020C-BS2		
				7.16 Nm	1,500 W	R88D-KN15F-__	R88D-KT15F	R88M-K1K520C-BS2		
				9.55 Nm	2,000 W	R88D-KN20F-__	R88D-KT20F	R88M-K2K020C-BS2		
		14.3 Nm	3,000 W	R88D-KN30F-__	R88D-KT30F	R88M-K3K020C-BS2				
	19.1 Nm	4,000 W	R88D-KN50F-__	R88D-KT50F	R88M-K4K020C-BS2					
23.9 Nm	5,000 W	R88D-KN50F-__	R88D-KT50F	R88M-K5K020C-BS2						

Servo motors 1,500 r/min (7.5 to 15 kW)

Symbol	Specifications				② Compatible servo drives		Order code	
	Voltage	Encoder and design		Rated torque	Capacity	G5 EtherCAT		G5 analog/pulse
	400 V	Absolute encoder (17 bit) straight shaft with key and tap	Without brake	47.8 Nm	7,500 W	R88D-KN75F-ECT	R88D-KT75F	R88M-K7K515C-S2
				70.0 Nm	11,000 W	R88D-KN150F-ECT	R88D-KT150F	R88M-K11K015C-S2
				95.5 Nm	15,000 W	R88D-KN150F-ECT	R88D-KT150F	R88M-K15K015C-S2
			With brake	47.8 Nm	7,500 W	R88D-KN75F-ECT	R88D-KT75F	R88M-K7K515C-BS2
				70.0 Nm	11,000 W	R88D-KN150F-ECT	R88D-KT150F	R88M-K11K015C-BS2
				95.5 Nm	15,000 W	R88D-KN150F-ECT	R88D-KT150F	R88M-K15K015C-BS2

Servo motors 1,000 r/min (900 to 6,000 W)

Symbol	Specifications				② Compatible servo drives			Order code	
	Voltage	Encoder and design		Rated torque	Capacity	G5 EtherCAT	G5 analog/pulse		G5 ML2
①  900 W to 3 kW  4.5 kW to 6 kW	230 V	Incremental encoder (20 bit) straight shaft with key and tap	Without brake	8.59 Nm	900 W	R88D-KN15H-ECT	R88D-KT15H	R88D-KN15H-ML2	R88M-K90010H-S2
			With brake	8.59 Nm	900 W	R88D-KN15H-ECT	R88D-KT15H	R88D-KN15H-ML2	R88M-K90010H-B52
		Absolute encoder (17 bit) straight shaft with key and tap	Without brake	8.59 Nm	900 W	R88D-KN15H-ECT	R88D-KT15H	R88D-KN15H-ML2	R88M-K90010T-S2
			With brake	8.59 Nm	900 W	R88D-KN15H-ECT	R88D-KT15H	R88D-KN15H-ML2	R88M-K90010T-B52
	400 V	Incremental encoder (20 bit) straight shaft with key and tap	Without brake	8.59 Nm	900 W	R88D-KN15F-ECT	R88D-KT15F	R88D-KN15F-ML2	R88M-K90010F-S2
				19.1 Nm	2,000 W	R88D-KN30F-ECT	R88D-KT30F	R88D-KN30F-ML2	R88M-K2K010F-S2
				28.7 Nm	3,000 W	R88D-KN50F-ECT	R88D-KT50F	R88D-KN50F-ML2	R88M-K3K010F-S2
				8.59 Nm	900 W	R88D-KN15F-ECT	R88D-KT15F	R88D-KN15F-ML2	R88M-K90010F-B52
			With brake	19.1 Nm	2,000 W	R88D-KN30F-ECT	R88D-KT30F	R88D-KN30F-ML2	R88M-K2K010F-B52
				28.7 Nm	3,000 W	R88D-KN50F-ECT	R88D-KT50F	R88D-KN50F-ML2	R88M-K3K010F-B52
				8.59 Nm	900 W	R88D-KN15F-ECT	R88D-KT15F	R88D-KN15F-ML2	R88M-K90010C-S2
				19.1 Nm	2,000 W	R88D-KN30F-ECT	R88D-KT30F	R88D-KN30F-ML2	R88M-K2K010C-S2
		Absolute encoder (17 bit) straight shaft with key and tap	Without brake	28.7 Nm	3,000 W	R88D-KN50F-ECT	R88D-KT50F	R88D-KN50F-ML2	R88M-K3K010C-S2
				43.0 Nm	4,500 W	R88D-KN50F-ECT	R88D-KT50F	R88D-KN50F-ML2	R88M-K4K510C-S2
				57.3 Nm	6,000 W	R88D-KN75F-ECT	R88D-KT75F	-	R88M-K6K010C-S2
				8.59 Nm	900 W	R88D-KN15F-ECT	R88D-KT15F	R88D-KN15F-ML2	R88M-K90010C-B52
			With brake	19.1 Nm	2,000 W	R88D-KN30F-ECT	R88D-KT30F	R88D-KN30F-ML2	R88M-K2K010C-B52
				28.7 Nm	3,000 W	R88D-KN50F-ECT	R88D-KT50F	R88D-KN50F-ML2	R88M-K3K010C-B52
				43.0 Nm	4,500 W	R88D-KN50F-ECT	R88D-KT50F	R88D-KN50F-ML2	R88M-K4K510C-B52
				57.3 Nm	6,000 W	R88D-KN75F-ECT	R88D-KT75F	-	R88M-K6K010C-B52

High inertia servo motors

Servo motors 3,000 r/min (200 to 750 W)

Symbol	Specifications				② Compatible servo drives		Order code		
	Voltage	Encoder and design		Rated torque	Capacity	G5 EtherCAT/ML2		G5 analog/pulse	
① 	230 V	Incremental encoder (20 bit)	Without brake	0.64 Nm	200 W	R88D-KN02H-__	R88D-KT02H	R88M-KH20030H-S2-D	
				1.3 Nm	400 W	R88D-KN04H-__	R88D-KT04H	R88M-KH40030H-S2-D	
				2.4 Nm	750 W	R88D-KN08H-__	R88D-KT08H	R88M-KH75030H-S2-D	
				0.64 Nm	200 W	R88D-KN02H-__	R88D-KT02H	R88M-KH20030H-B52-D	
		Straight shaft with key and tap	With brake	1.3 Nm	400 W	R88D-KN04H-__	R88D-KT04H	R88M-KH40030H-B52-D	
				2.4 Nm	750 W	R88D-KN08H-__	R88D-KT08H	R88M-KH75030H-B52-D	
				0.64 Nm	200 W	R88D-KN02H-__	R88D-KT02H	R88M-KH20030T-S2-D	
				1.3 Nm	400 W	R88D-KN04H-__	R88D-KT04H	R88M-KH40030T-S2-D	
		Absolute encoder (17 bit)	Without brake	Straight shaft with key and tap	2.4 Nm	750 W	R88D-KN08H-__	R88D-KT08H	R88M-KH75030T-S2-D
					0.64 Nm	200 W	R88D-KN02H-__	R88D-KT02H	R88M-KH20030T-B52-D
					1.3 Nm	400 W	R88D-KN04H-__	R88D-KT04H	R88M-KH40030T-B52-D
					2.4 Nm	750 W	R88D-KN08H-__	R88D-KT08H	R88M-KH75030T-B52-D



Servo motors 2,000 r/min (1 to 5 kW)

Symbol	Specifications				② Compatible servo drives		Servo motor model		
	Voltage	Encoder and design		Rated torque	Capacity	G5 EtherCAT/ML2	G5 analog/pulse	Order code	
① 	400 V	Incremental encoder (20 bit)	Shaft end with key	Without brake	4.77 Nm	1,000 W	R88D-_KN10F-__	R88D-KT10F	R88M-KH1K020F-S1
					7.16 Nm	1,500 W	R88D-_KN15F-__	R88D-KT15F	R88M-KH1K520F-S1
					9.55 Nm	2,000 W	R88D-_KN20F-__	R88D-KT20F	R88M-KH2K020F-S1
					14.3 Nm	3,000 W	R88D-_KN30F-__	R88D-KT30F	R88M-KH3K020F-S1
					19.1 Nm	4,000 W	R88D-_KN50F-__	R88D-KT50F	R88M-KH4K020F-S1
					23.9 Nm	5,000 W	R88D-_KN50F-__	R88D-KT50F	R88M-KH5K020F-S1
				With brake	4.77 Nm	1,000 W	R88D-_KN10F-__	R88D-KT10F	R88M-KH1K020F-B51
					7.16 Nm	1,500 W	R88D-_KN15F-__	R88D-KT15F	R88M-KH1K520F-B51
					9.55 Nm	2,000 W	R88D-_KN20F-__	R88D-KT20F	R88M-KH2K020F-B51
					14.3 Nm	3,000 W	R88D-_KN30F-__	R88D-KT30F	R88M-KH3K020F-B51
					19.1 Nm	4,000 W	R88D-_KN50F-__	R88D-KT50F	R88M-KH4K020F-B51
					23.9 Nm	5,000 W	R88D-_KN50F-__	R88D-KT50F	R88M-KH5K020F-B51
		Absolute encoder (17 bit)	Shaft end with key	Without brake	4.77 Nm	1,000 W	R88D-_KN10F-__	R88D-KT10F	R88M-KH1K020C-S1
					7.16 Nm	1,500 W	R88D-_KN15F-__	R88D-KT15F	R88M-KH1K520C-S1
					9.55 Nm	2,000 W	R88D-_KN20F-__	R88D-KT20F	R88M-KH2K020C-S1
					14.3 Nm	3,000 W	R88D-_KN30F-__	R88D-KT30F	R88M-KH3K020C-S1
				With brake	19.1 Nm	4,000 W	R88D-_KN50F-__	R88D-KT50F	R88M-KH4K020C-S1
					23.9 Nm	5,000 W	R88D-_KN50F-__	R88D-KT50F	R88M-KH5K020C-S1
					4.77 Nm	1,000 W	R88D-_KN10F-__	R88D-KT10F	R88M-KH1K020C-B51
					7.16 Nm	1,500 W	R88D-_KN15F-__	R88D-KT15F	R88M-KH1K520C-B51
				9.55 Nm	2,000 W	R88D-_KN20F-__	R88D-KT20F	R88M-KH2K020C-B51	
				14.3 Nm	3,000 W	R88D-_KN30F-__	R88D-KT30F	R88M-KH3K020C-B51	
				19.1 Nm	4,000 W	R88D-_KN50F-__	R88D-KT50F	R88M-KH4K020C-B51	
				23.9 Nm	5,000 W	R88D-_KN50F-__	R88D-KT50F	R88M-KH5K020C-B51	

Servo motors 1,500 r/min (7.5 kW)

Symbol	Specifications					② Compatible servo drives		Servo motor model
	Voltage	Encoder and design		Rated torque	Capacity	G5 EtherCAT	G5 analog/pulse	Order code
① 	400 V	Absolute encoder (17 bit) Shaft end with key	Without brake	47.8 Nm	7,500 W	R88D-KN75F-ECT	R88D-KT75F	R88M-KH7K515C-S1
			With brake	47.8 Nm	7,500 W	R88D-KN75F-ECT	R88D-KT75F	R88M-KH7K515C-BS1

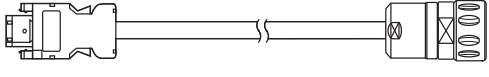
Encoder cables for absolute and incremental encoders

Symbol	Appearance	Specifications	Order code	
③		Encoder cable for servomotors R88M-K(050/100/200/400/750)30(H/T)_	1.5 m	R88A-CRKA001-5CR-E
			3 m	R88A-CRKA003CR-E
			5 m	R88A-CRKA005CR-E
			10 m	R88A-CRKA010CR-E
			15 m	R88A-CRKA015CR-E
			20 m	R88A-CRKA020CR-E
		Encoder cable for servomotors R88M-KH(200/400/750)30(H/T)_	3 m	R88A-CRWA003C-DE
			5 m	R88A-CRWA005C-DE
			10 m	R88A-CRWA010C-DE
			15 m	R88A-CRWA015C-DE
		Encoder cable for servomotors R88M-K(1K0/1K5)30(H/T)_ R88M-K(750/1K0/1K5/2K0/3K0/4K0/5K0)30(F/C)_ R88M-K(400/600/1K0/1K5/2K0/3K0/4K0/5K0)20_ R88M-K(7K5/11K0/15K0)15_ R88M-K(900/2K0/3K0/4K5/6K0)10_ R88M-KH(1K0/1K5/2K0/3K0/4K0/5K0)20(F/C)_ R88M-KH7K515C_	1.5 m	R88A-CRKC001-5NR-E
			3 m	R88A-CRKC003NR-E
			5 m	R88A-CRKC005NR-E
			10 m	R88A-CRKC010NR-E
			15 m	R88A-CRKC015NR-E
20 m	R88A-CRKC020NR-E			

Note: For servomotors fitted with an absolute encoder you have to add the extension battery cable R88A-CRGD0R3C_ (see below) or connect a backup battery in the CN1 I/O connector.

Absolute encoder battery cable (encoder extension cable only)

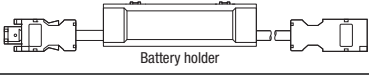
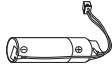
Symbol	Appearance	Specifications	Order code	
④		Battery not included	0.3 m	R88A-CRGD0R3C-E
		Battery included	0.3 m	R88A-CRGD0R3C-BS-E
		Absolute encoder backup battery	2,000 mA.h 3.6V	R88A-BAT01G

Power cables

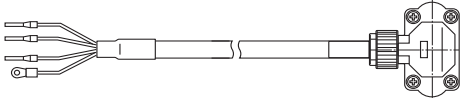
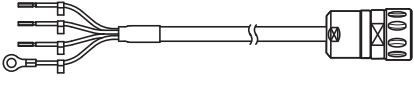
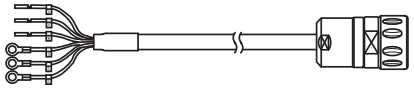
Symbol	Appearance	Specifications	Order code		
⑤		For 200 V servomotors R88M-K(050/100/200/400/750)30(H/T)___S2 Note: for servomotors with brake R88M-K(050/100/200/400/750)30 (H/T)-BS2, the separate brake cable R88A-CAKA___BR-E is needed	Power cable only (without brake)	1.5 m	R88A-CAKA001-5SR-E
				3 m	R88A-CAKA003SR-E
				5 m	R88A-CAKA005SR-E
				10 m	R88A-CAKA010SR-E
				15 m	R88A-CAKA015SR-E
				20 m	R88A-CAKA020SR-E
		For 200 V servomotors R88M-KH(200/400/750)30(H/T)___S2	without brake	3 m	R88A-CAWA003S-DE
				5 m	R88A-CAWA005S-DE
				10 m	R88A-CAWA010S-DE
				15 m	R88A-CAWA015S-DE
				20 m	R88A-CAWA020S-DE
					For 200 V servomotors R88M-KH(200/400/750)30(H/T)___S2
5 m	R88A-CAWA005B-DE				
10 m	R88A-CAWA010B-DE				
15 m	R88A-CAWA015B-DE				
20 m	R88A-CAWA020B-DE				

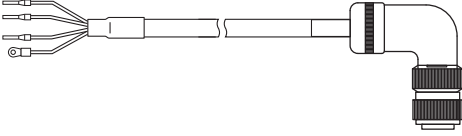
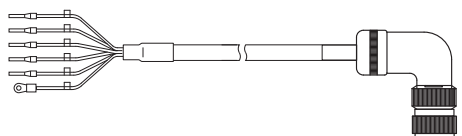
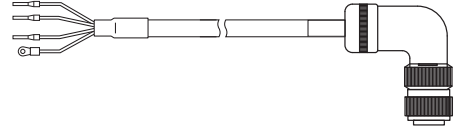
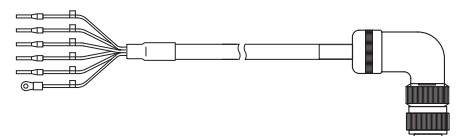
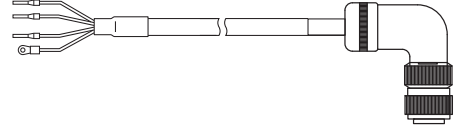
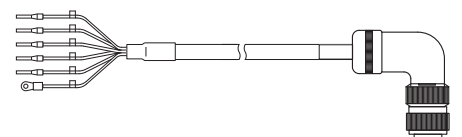
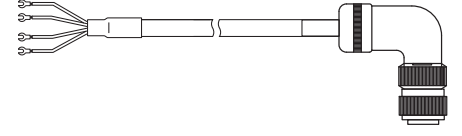
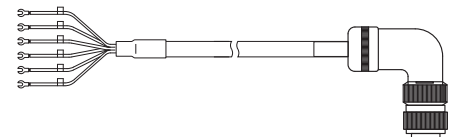
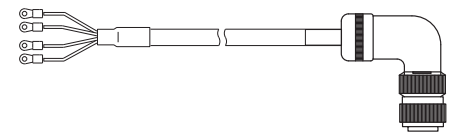
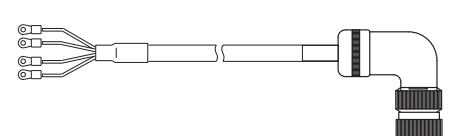
Symbol	Appearance	Specifications			Order code	
⑤		For 200 V servomotors R88M-K(1K0/1K5)30(H/T)-__S2 R88M-K(1K0/1K5)20(H/T)-__S2 R88M-K90010(H/T)-__S2	without brake	1.5 m	R88A-CAGB001-5SR-E	
				3 m	R88A-CAGB003SR-E	
				5 m	R88A-CAGB005SR-E	
				10 m	R88A-CAGB010SR-E	
				15 m	R88A-CAGB015SR-E	
				20 m	R88A-CAGB020SR-E	
				with brake	1.5 m	R88A-CAGB001-5BR-E
					3 m	R88A-CAGB003BR-E
					5 m	R88A-CAGB005BR-E
					10 m	R88A-CAGB010BR-E
					15 m	R88A-CAGB015BR-E
					20 m	R88A-CAGB020BR-E
		For 400 V servomotors R88M-K(750/1K0/1K5/2K)30(F/C)-__S2 R88M-K(400/600/1K0/1K5/2K0)20(F/C)-__S2 R88M-K90010(F/C)-__S2 R88M-KH(1K0/1K5)20(F/C)-_S1	without brake	1.5 m	R88A-CAGB001-5SR-E	
				3 m	R88A-CAGB003SR-E	
				5 m	R88A-CAGB005SR-E	
				10 m	R88A-CAGB010SR-E	
				15 m	R88A-CAGB015SR-E	
				20 m	R88A-CAGB020SR-E	
			with brake	1.5 m	R88A-CAKF001-5BR-E	
				3 m	R88A-CAKF003BR-E	
				5 m	R88A-CAKF005BR-E	
				10 m	R88A-CAKF010BR-E	
				15 m	R88A-CAKF015BR-E	
				20 m	R88A-CAKF020BR-E	
	For 400 V servomotors R88M-KH2K020(F/C)-_S1	without brake	1.5 m	R88A-CAKC001-5SR-E		
			3 m	R88A-CAKC003SR-E		
			5 m	R88A-CAKC005SR-E		
			10 m	R88A-CAKC010SR-E		
			15 m	R88A-CAKC015SR-E		
			20 m	R88A-CAKC020SR-E		
			with brake	1.5 m	R88A-CAKF001-5BR-E	
				3 m	R88A-CAKF003BR-E	
				5 m	R88A-CAKF005BR-E	
				10 m	R88A-CAKF010BR-E	
				15 m	R88A-CAKF015BR-E	
				20 m	R88A-CAKF020BR-E	
	For 400 V servomotors R88M-K(3K0/4K0/5K0)30(F/C)-__S2 R88M-K(3K0/4K0/5K0)20(F/C)-__S2 R88M-K(2K0/3K0)10(F/C)-__S2 R88M-K4K510C-__S2 R88M-KH(3K0/4K0/5K0)20(F/C)-_S1	without brake	1.5 m	R88A-CAGD001-5SR-E		
			3 m	R88A-CAGD003SR-E		
			5 m	R88A-CAGD005SR-E		
			10 m	R88A-CAGD010SR-E		
			15 m	R88A-CAGD015SR-E		
			20 m	R88A-CAGD020SR-E		
			with brake	1.5 m	R88A-CAGD001-5BR-E	
				3 m	R88A-CAGD003BR-E	
				5 m	R88A-CAGD005BR-E	
				10 m	R88A-CAGD010BR-E	
				15 m	R88A-CAGD015BR-E	
				20 m	R88A-CAGD020BR-E	
	For 400 V servomotors R88M-K6K010C-__S2 R88M-K7K515C-__S2 R88M-KH7K515C-_S1 Note: for servomotors with brake R88M-K(6K010/7K515)C-BS2 and R88M-KH7K515C-BS1 the separate brake cable R88A-CAGE ___ BR-E is needed	Power cable only (without brake)	1.5 m	R88A-CAKE001-5SR-E		
			3 m	R88A-CAKE003SR-E		
			5 m	R88A-CAKE005SR-E		
			10 m	R88A-CAKE010SR-E		
			15 m	R88A-CAKE015SR-E		
			20 m	R88A-CAKE020SR-E		
	For 400 V servomotors R88M-K(11K0/15K0)15C-__S2 Note: Note: for servomotors with brake R88M-K(11K0/15K0)15C-BS2, the sep- arate brake cable R88A-CAGE ___ BR- E is needed	Power cable only (without brake)	1.5 m	R88A-CAKG001-5SR-E		
			3 m	R88A-CAKG003SR-E		
			5 m	R88A-CAKG005SR-E		
			10 m	R88A-CAKG010SR-E		
			15 m	R88A-CAKG015SR-E		
			20 m	R88A-CAKG020SR-E		

Brake cables (for 200 V 50 to 750 W servo motors and 400 V 6 to 15 kW servo motors)

Symbol	Appearance	Specifications	Order code	
⑥		Brake cable only. For 200 V servo motors with brake R88M-K(050/100/200/400/750)30(H/T)-BS2	1.5 m	R88A-CAKA001-SBR-E
			3 m	R88A-CAKA003BR-E
			5 m	R88A-CAKA005BR-E
			10 m	R88A-CAKA010BR-E
			15 m	R88A-CAKA015BR-E
			20 m	R88A-CAKA020BR-E
		Brake cable only. For 400 V servo motors with brake R88M-K6K010C-BS2 R88M-K(7K5/11K0/15K0)15C-BS2 R88M-KH7K515C-BS1	1.5 m	R88A-CAGE001-SBR-E
			3 m	R88A-CAGE003BR-E
			5 m	R88A-CAGE005BR-E
			10 m	R88A-CAGE0010BR-E
			15 m	R88A-CAGE015BR-E
			20 m	R88A-CAGE020BR-E

Connectors for encoder, power and brake cables

Specifications	Applicable servo motor	Order code	
Connectors for making encoder cables	Drive side (CN2)	All models	R88A-CNW01R
	Motor side	R88M-K(050/100/200/400/750)30(H/T)_	R88A-CNK02R
	Motor side	R88M-KH(200/400/750)_	SPOC-17H-FRON169
	Motor side	R88M-K(1K0/1K5)30(H/T)_ R88M-K(750/1K0/1K5/2K0/3K0/4K0/5K0)30(F/C)_ R88M-K(400/600/1K0/1K5/2K0/3K0/4K0/5K0)20_ R88M-K(900/2K0/3K0)10_ R88M-K(4K5/6K0)10C-_ R88M-K(7K5/11K0/15K0)15C-_ R88M-KH(1K0/1K5/2K0/3K0/4K0/5K0/7K5)_	R88A-CNK04R
Connectors for making power cables	Motor side	R88M-K(050/100/200/400/750)30(H/T)_	R88A-CNK11A
	Motor side	R88M-KH(200/400/750)30(H/T)_	SPOC-06K-FSDN169
	Motor side	R88M-K(1K0/1K5)30(H/T)-S2 R88M-K(1K0/1K5)20(H/T)-S2 R88M-K90010(H/T)-S2 R88M-K(750/1K0/1K5/2K0)30(F/C)-S2 R88M-K(400/600/1K0/1K5/2K0)20(F/C)-S2 R88M-K90010(F/C)-S2 R88M-KH(1K0/1K5)20(F/C)-S1	MS3108E20-4S
	Motor side	R88M-K(1K0/1K5)30(H/T)-BS2 R88M-K(1K0/1K5)20(H/T)-BS2 R88M-K90010(H/T)-BS2	MS3108E20-18S
	Motor side	R88M-K(750/1K0/1K5/2K0/3K0/4K0/5K0)30(F/C)-BS2 R88M-K(400/600/1K0/1K5/2K0/3K0/4K0/5K0)20(F/C)-BS2 R88M-K(900/2K0/3K0)10(F/C)-BS2 R88M-K4K510C-BS2 R88M-KH(1K0/1K5/2K0/3K0/4K0/5K0)20(F/C)-BS1	MS3108E24-11S
	Motor side	R88M-K(3K0/4K0/5K0)30(F/C)-S2 R88M-K(3K0/4K0/5K0)20(F/C)-S2 R88M-K(2K0/3K0)10(F/C)-S2 R88M-K4K510C-S2 R88M-KH(2K0/3K0/4K0/5K0)20(F/C)-S1	MS3108E22-22S
	Motor side	R88M-K6K010C-_ R88M-K(7K5/11K0/15K0)15C-_ R88M-KH7K515C-_ S1	MS3108E32-17S
	Motor side	R88M-K(050/100/200/400/750)30(H/T)-BS2	R88A-CNK11B
Connector for brake cable	Motor side	R88M-K(050/100/200/400/750)30(H/T)-BS2	R88A-CNK11B
	Motor side	R88M-K6K010C-BS2 R88M-K(7K5/11K0/15K0)15C-BS2 R88M-KH7K515C-BS1	MS3108E14S-2S

- Note: 1. All cables listed are flexible and shielded (except the R88A-CAKA__-BR-E which is only a flexible cable).
2. All connectors and cables listed have IP67 class (except R88A-CNW01R connector and R88A-CRGD0R3C cable).

Specifications

Standard servo motors 3,000 r/min, 230 V

Voltage		230 V							
Servo motor model R88M-K_	20-bit incremental encoder	05030H- ₋	10030H- ₋	20030H- ₋	40030H- ₋	75030H- ₋	1K030H- ₋	1K530H- ₋	
	17-bit absolute encoder	05030T- ₋	10030T- ₋	20030T- ₋	40030T- ₋	75030T- ₋	1K030T- ₋	1K530T- ₋	
Rated output	W	50	100	200	400	750	1,000	1,500	
Rated torque	N·m	0.16	0.32	0.64	1.3	2.4	3.18	4.77	
Instantaneous peak torque	N·m	0.48	0.95	1.91	3.8	7.1	9.55	14.3	
Rated current	A (rms)	1.1	1.1	1.5	2.4	4.1	6.6	8.2	
Instantaneous max. current	A (rms)	4.7	4.7	6.5	10.2	17.4	28	35	
Rated speed	min ⁻¹	3,000							
Max. speed	min ⁻¹	6,000						5,000	
Torque constant	N·m/A	0.11±10%	0.21±10%	0.31±10%	0.39±10%	0.42±10%	0.37	0.45	
Rotor moment of inertia (JM)	kg·m ² × 10 ⁻⁴ (without brake)	0.025	0.051	0.14	0.26	0.87	2.03	2.84	
	kg·m ² × 10 ⁻⁴ (with brake)	0.027	0.054	0.16	0.28	0.97	2.35	3.17	
Allowable load moment of inertia (JL)	Multiple of (JM)	30 ^{*1}					20 ^{*1}	15 ^{*1}	

Voltage		230 V						
Servo motor model R88M-K_	20-bit incremental encoder	05030H_	10030H_	20030H_	40030H_	75030H_	1K030H_	1K530H_
	17-bit absolute encoder	05030T_	10030T_	20030T_	40030T_	75030T_	1K030T_	1K530T_
Rated power rate	kW/s (without brake)	10.1	19.9	29.0	62.4	65.6	49.8	80.1
	kW/s (with brake)	9.4	18.8	25.4	58	58.8	43	71.8
Allowable radial load	N	68			245		490	
Allowable thrust load	N	58			98		196	
Approx. mass	kg (without brake)	0.32	0.47	0.82	1.2	2.3	3.5	4.4
	kg (with brake)	0.53	0.68	1.3	1.7	3.1	4.5	5.4
Brake specifications	Rated voltage	24VDC±10%						
	Holding brake moment of inertia J	kg·m ² × 10 ⁻⁴		0.002		0.0018		0.33
	Power consumption (20°C)	W	7		9		17	19
	Current consumption (20°C)	A	0.3		0.36		0.70±10%	0.81±10%
	Static friction torque	N.m (minimum)	0.29		1.27		2.5	7.8
	Rise time for holding torque	ms (max.)	35		50			
	Release time	ms (max)	20		15			
Basic specifications	Time Rating	Continuous						
	Insulation class	Type B					Type F	
	Ambient operating/storage temperature	0 to 40°C/-20 to 65°C						
	Ambient operating/storage humidity	20% to 80% (non-condensing)					20% to 85% (non-condensing)	
	Vibration class	V-15						
	Insulation resistance	20 MΩ min. at 500 VDC between the power terminals and FG terminal						
	Enclosure	Totally-enclosed, self-cooling, IP67 (excluding shaft opening)						
	Vibration resistance	Vibration acceleration 49 m/s ²						
	Mounting	Flange-mounted						

*1 Applicable load inertia: The operable load inertia ratio (load inertia/rotor inertia) depends on the mechanical configuration and its rigidity. For a machine with high rigidity, operation is possible even with high load inertia. Select an appropriate motor and confirm that operation is possible.

Standard servo motors 3,000 r/min, 400 V

Voltage		400 V							
Servo motor model R88M-K_	20-bit incremental encoder	75030F_	1K030F_	1K530F_	2K030F_	3K030F_	4K030F_	5K030F_	
	17-bit absolute encoder	75030C_	1K030C_	1K530C_	2K030C_	3K030C_	4K030C_	5K030C_	
Rated output	W	750	1,000	1,500	2,000	3,000	4,000	5,000	
Rated torque	N·m	2.39	3.18	4.77	6.37	9.55	12.7	15.9	
Instantaneous peak torque	N·m	7.16	9.55	14.3	19.1	28.6	38.2	47.7	
Rated current	A (rms)	2.4	3.3	4.2	5.7	9.2	9.9	12	
Instantaneous max. current	A (rms)	10	14	18	24	39	42	51	
Rated speed	min ⁻¹	3,000							
Max. speed	min ⁻¹	5,000					4,500		
Torque constant	N·m/A	0.78	0.75	0.89	0.87	0.81	0.98		
Rotor moment of inertia (JM)	kg·m ² × 10 ⁻⁴ (without brake)	1.61	2.03	2.84	3.68	6.5	12.9	17.4	
	kg·m ² × 10 ⁻⁴ (with brake)	1.93	2.35	3.17	4.01	7.85	14.2	18.6	
Allowable load moment of inertia (JL)	Multiple of (JM)	20 ⁻¹	15 ⁻¹						
Rated power rate	kW/s (without brake)	35.5	49.8	80.1	110	140	126	146	
	kW/s (with brake)	29.6	43	71.8	101	116	114	136	
Allowable radial load	N	490					784		
Allowable thrust load	N	196					343		
Approx. mass	kg (without brake)	3.1	3.5	4.4	5.3	8.3	11	14	
	kg (with brake)	4.1	4.5	5.4	6.3	9.4	12.6	16	
Brake specifications	Rated voltage	24VDC±10%							
	Holding brake moment of inertia J	kg·m ² × 10 ⁻⁴		0.33				1.35	
	Power consumption (20°C)	W	17	19				22	
	Current consumption (20°C)	A	0.70±10%	0.81±10%				0.90±10%	
	Static friction torque	N.m (minimum)	2.5	7.8			11.8	16.1	
	Rise time for holding torque	ms (max.)	50					110	
	Release time	ms (max)	15					50	
Basic specifications	Time Rating	Continuous							
	Insulation class	Type F							
	Ambient operating/storage temperature	0 to 40°C/-20 to 65°C							
	Ambient operating/storage humidity	20% to 85% (non-condensing)							
	Vibration class	V-15							
	Insulation resistance	20 MΩ min. at 500 VDC between the power terminals and FG terminal							
	Enclosure	Totally-enclosed, self-cooling, IP67(excluding shaft opening)							
	Vibration resistance	Vibration acceleration 49 m/s ²							
	Mounting	Flange-mounted							

*1 Applicable load inertia: The operable load inertia ratio (load inertia/rotor inertia) depends on the mechanical configuration and its rigidity. For a machine with high rigidity, operation is possible even with high load inertia. Select an appropriate motor and confirm that operation is possible.

Standard servo motors 2,000 r/min, 230 V/400 V

Voltage		230 V					400 V					
Servo motor model R88M-K_	20-bit incremental encoder	1K020H_	1K520H_	40020F_	60020F_	1K020F_	1K520F_	2K020F_	3K020F_	4K020F_	5K020F_	
	17-bit absolute encoder	1K020T_	1K520T_	40020C_	60020C_	1K020C_	1K520C_	2K020C_	3K020C_	4K020C_	5K020C_	
Rated output	W	1,000	1,500	400	600	1,000	1,500	2,000	3,000	4,000	5,000	
Rated torque	N·m	4.77	7.16	1.91	2.86	4.77	7.16	9.55	14.3	19.1	23.9	
Instantaneous peak torque	N·m	14.3	21.5	5.73	8.59	14.3	21.5	28.7	43	57.3	71.6	
Rated current	A (rms)	5.7	9.4	1.2	1.5	2.8	4.7	5.9	8.7	10.6	13	
Instantaneous max. current	A (rms)	24	40	4.9	6.5	12	20	25	37	45	55	
Rated speed	min ⁻¹	2,000										
Max. speed	min ⁻¹	3,000										
Torque constant	N·m/A	0.63	0.58	1.27	1.38	1.27	1.16	1.27	1.18	1.40	1.46	
Rotor moment of inertia (JM)	kg·m ² × 10 ⁻⁴ (without brake)	4.60	6.70	1.61	2.03	4.60	6.70	8.72	12.9	37.6	48	
	kg·m ² × 10 ⁻⁴ (with brake)	5.90	7.99	1.90	2.35	5.90	7.99	10	14.2	38.6	48.8	
Max. load moment of inertia (JL)	Multiple of (JM)	10 ^{*1}										
Rated power rate	kW/s (without brake)	49.5	76.5	22.7	40.3	49.5	76.5	105	159	97.1	119	
	kW/s (with brake)	38.6	64.2	19.2	34.8	38.6	64.2	91.2	144	94.5	117	
Allowable radial load	N	490							784			
Allowable thrust load	N	196							343			
Approx. mass	kg (without brake)	5.2	6.7	3.1	3.5	5.2	6.7	8	11	15.5	18.6	
	kg (with brake)	6.7	8.2	4.1	4.5	6.7	8.2	9.5	12.6	18.7	21.8	
Brake specifications	Rated voltage	24VDC ±10%										
	Holding brake moment inertia	(J) kg·m ² × 10 ⁻⁴	1.35								4.7	
	Power consumption (20°C)	W	14	19	17		14	19		22	31	
	Current consumption (20°C)	A	0.59±10%	0.79±10%	0.70±10%		0.59±10%	0.79±10%		0.90±10%	1.3±10%	
	Static friction torque	N·m (minimum)	4.9	13.7	2.5		4.9	13.7		16.2	24.5	
	Rise time for holding torque	ms (max.)	80	100	50		80	100		110	80	
Release time	ms (max)	70	50	15		70	50			25		
Basic specifications	Time Rating	Continuous										
	Insulation class	TypeF										
	Ambient operating/storage temperature	0 to 40 °C/-20 to 85°C										
	Ambient operating/storage humidity	20% to 85% (non-condensing)										
	Vibration class	V-15										
	Insulation resistance	20 MΩ min. at 500 VDC between the power terminals and FG terminal										
	Enclosure	Totally-enclosed, self-cooling, IP67 (excluding shaft opening)										
	Vibration resistance	Vibration acceleration 49 m/s ²										
Mounting	Flange-mounted											

*1 Applicable load inertia: The operable load inertia ratio (load inertia/rotor inertia) depends on the mechanical configuration and its rigidity. For a machine with high rigidity, operation is possible even with high load inertia. Select an appropriate motor and confirm that operation is possible.

Standard servo motors 1,500 r/min, 400 V

Applied voltage		400 V		
Servo motor model R88M-K_	17-bit absolute encoder	7K515C_	11K015C_	15K015C_
Rated output	W	7,500	11,000	15,000
Rated torque	N·m	47.8	70.0	95.5
Instantaneous peak torque	N·m	119.0	175.0	224.0
Rated current	A (rms)	22.0	27.1	33.1
Instantaneous max. current	A (rms)	83	101	118
Rated speed	min ⁻¹	1,500		
Max. speed	min ⁻¹	3,000		
Torque constant	N·m/A	1.54	1.84	2.10
Rotor moment of inertia (JM)	kg·m ² × 10 ⁻⁴ (without brake)	101	212	302
	kg·m ² × 10 ⁻⁴ (with brake)	107	220	311
Allowable load moment of inertia (JL)	Multiple of (JM)	10 ^{*1}		
Rated power rate	kW/s (without brake)	226	231	302
	kW/s (with brake)	213	223	293
Allowable radial load	N	1,176	2,254	
Allowable thrust load	N	490	686	
Approx. mass	kg (without brake)	36.4	52.7	70.2
	kg (with brake)	40.4	58.9	76.3
Brake specifications	Rated voltage	24VDC±10%		
	Holding brake moment of inertia J	kg·m ² × 10 ⁻⁴	4.7	7.1
	Power consumption (20°C)	W	34	26
	Current consumption (20°C)	A	1.4±10%	1.08±10%
	Static friction torque	N·m (minimum)	58.8	100
	Rise time for holding torque	ms (max.)	150	300
Release time	ms (max)	50	140	

Applied voltage		400 V		
Servo motor model R88M-K_	17-bit absolute encoder	7K515C_	11K015C_	15K015C_
Basic specifications	Time Rating	Continuous		
	Insulation class	Type F		
	Ambient operating/storage temperature	0 to 40 °C/-20 to 65°C		
	Ambient operating/storage humidity	20% to 85% RH (non-condensing)		
	Vibration class	V-15		
	Insulation resistance	20 MΩ min. at 500 VDC between the power terminals and FG terminal		
	Enclosure	Totally-enclosed, self-cooling, IP67 (excluding shaft opening)		
	Vibration resistance	Vibration acceleration 49 m/s ²		
	Mounting	Flange-mounted		

*1 Applicable load inertia: The operable load inertia ratio (load inertia/rotor inertia) depends on the mechanical configuration and its rigidity. For a machine with high rigidity, operation is possible even with high load inertia. Select an appropriate motor and confirm that operation is possible.

Standard servo motors 1000 r/min, 230 V/400 V

Applied voltage		230 V		400 V			
Servo motor model R88M-K_	20-bit incremental encoder	90010H_	90010F_	2K010F_	3K010F_		
	17-bit absolute encoder	90010T_	90010C_	2K010C_	3K010C_	4K510C_	6K010C_
Rated output	W	900	900	2,000	3,000	4,500	6,000
Rated torque	N·m	8.59		19.1	28.7	43.0	57.3
Instantaneous peak torque	N·m	19.3		47.7	71.7	107.0	143.0
Rated current	A (rms)	7.6	3.8	8.5	11.3	14.8	19.4
Instantaneous max. current	A (rms)	24	12	30	40	55	74
Rated speed	min ⁻¹	1,000					
Max. speed	min ⁻¹	2,000					
Torque constant	N·m/A	0.86	1.72	1.76	1.92	2.05	2.08
Rotor moment of inertia (JM)	kg·m ² × 10 ⁻⁴ (without brake)	6.70		30.3	48.4	79.1	101
	kg·m ² × 10 ⁻⁴ (with brake)	7.99		31.4	49.2	84.4	107
Allowable load moment of inertia (JL)	Multiple of (JM)	10 ^{*1}					
Rated power rate	kW/s (without brake)	110		120	170	233	325
	kW/s (with brake)	92.4		116	167	219	307
Allowable radial load	N	686		1,176	1,470		1,764
Allowable thrust load	N	196		490			588
Approx. mass	kg (without brake)	6.7		14	20	29.4	36.4
	kg (with brake)	8.2		17.5	23.5	33.3	40.4

Brake specifications	Rated voltage	24VDC±10%					
	Holding brake moment of inertia J	kg·m ² × 10 ⁻⁴	1.35		4.7		
	Power consumption (20°C)	W	19		31	34	
	Current consumption (20°C)	A	0.79±10%		1.3±10%	1.4±10%	
	Static friction torque	N·m (minimum)	13.7		24.5	58.8	
	Rise time for holding torque	ms (max.)	100		80	150	
	Release time	ms (max.)	50		25	50	

Basic specifications	Time Rating	Continuous					
	Insulation class	Type F					
	Ambient operating/storage temperature	0 to 40 °C/-20 to 65°C					
	Ambient operating/storage humidity	20% to 85% RH (non-condensing)					
	Vibration class	V-15					
	Insulation resistance	20 MΩ min. at 500 VDC between the power terminals and FG terminal					
	Enclosure	Totally-enclosed, self-cooling, IP67 (excluding shaft opening)					
	Vibration resistance	Vibration acceleration 49 m/s ²					
	Mounting	Flange-mounted					

*1 Applicable load inertia: The operable load inertia ratio (load inertia/rotor inertia) depends on the mechanical configuration and its rigidity. For a machine with high rigidity, operation is possible even with high load inertia. Select an appropriate motor and confirm that operation is possible.

High inertia servo motors 3,000 r/min, 230 V

Voltage		230 V		
Servo motor model R88M-KH_	20-bit incremental encoder	20030H_	40030H_	75030H_
	17-bit absolute encoder	20030T_	40030T_	75030T_
Rated output	W	200	400	750
Rated torque	N·m	0.64	1.3	2.4
Instantaneous peak torque	N·m	1.91	3.8	7.1
Rated current	A (rms)	1.6	2.6	4.0
Instantaneous max. current	A (rms)	6.9	11.0	17.0
Rated speed	min ⁻¹	3,000		
Max. speed	min ⁻¹	5,000		4,500
Torque constant	N·m/A	0.29±10%		0.36±10%
Rotor moment of inertia (JM)	kg·m ² × 10 ⁻⁴ (without brake)	0.42		0.67
	kg·m ² × 10 ⁻⁴ (with brake)	0.45		0.70

Voltage		230 V		
Servo motor model R88M-KH_	20-bit incremental encoder	20030H_	40030H_	75030H_
	17-bit absolute encoder	20030T_	40030T_	75030T_
Allowable load moment of inertia (JL)	Multiple of (JM)	30 ^{*1}		20 ^{*1}
Rated power rate	kW/s (without brake)	9.58	24.1	37.7
	kW/s (with brake)	9.06	23.3	35.3
Allowable radial load	N	245		392
Allowable thrust load	N	98		147
Approx. mass	kg (without brake)	0.96	1.4	2.5
	kg (with brake)	1.4	1.8	3.3
Brake specifications	Rated voltage	24 VDC±5%		
	Holding brake moment of inertia J	kg·m ² × 10 ⁻⁴	0.018	0.075
	Power consumption (at 20°C)	W	9	10
	Current consumption (at 20°C)	A	0.36	0.42
	Static friction torque	N·m (minimum)	1.27	2.45
	Rise time for holding torque	ms (max.)	50	70
Release time	ms (max)	15	20	
Basic specifications	Time Rating	Continuous		
	Insulation class	Type B		
	Ambient operating/storage temperature	0 to 40°C/-20 to 65°C		
	Ambient operating/storage humidity	20% to 85% RH (non-condensing)		
	Vibration class	V-15		
	Insulation resistance	20 MΩ min. at 500 VDC between the power terminals and FG terminal		
	Enclosure	Totally-enclosed, self-cooling, IP65 (excluding shaft opening and lead wire ends)		
	Vibration resistance	Vibration acceleration 49 m/s ²		
Mounting	Flange-mounted			

*1 Applicable load inertia: The operable load inertia ratio (load inertia/rotor inertia) depends on the mechanical configuration and its rigidity. For a machine with high rigidity, operation is possible even with high load inertia. Select an appropriate motor and confirm that operation is possible.

High inertia servo motors 2,000 and 1,500 r/min, 400 V

R/min, voltage		2,000r/min, 400 V						1,500r/min, 400 V
Servo motor model R88M-KH_	20-bit incremental encoder	1K020F_	1K520F_	2K020F_	3K020F_	4K020F_	5K020F_	
	17-bit absolute encoder	1K020C_	1K520C_	2K020C_	3K020C_	4K020C_	5K020C_	7K515C_
Rated output	W	1,000	1,500	2,000	3,000	4,000	5,000	7,500
Rated torque	N·m	4.77	7.16	9.55	14.3	19.1	23.9	47.8
Instantaneous peak torque	N·m	14.3	21.5	28.6	43.0	57.3	71.6	119
Rated current	A (rms)	2.9	4.7	5.5	8.0	10.5	13.0	22.0
Instantaneous max. current	A (rms)	12	20	24	34	45	55	83
Rated speed	min ⁻¹	2,000						1500
Max. speed	min ⁻¹	3,000						3000
Torque constant	N·m/A	1.27	1.16	1.31	1.34	1.38	1.39	1.54
Rotor moment of inertia (JM)	kg·m ² × 10 ⁻⁴ (without brake)	24.7	37.1	57.8	90.2	112	162	273
	kg·m ² × 10 ⁻⁴ (with brake)	26.0	38.4	62.9	95.3	117	167	279
Max. load moment of inertia (JL)	Multiple of (JM)	5 ^{*1}						
Rated power rate	kW/s (without brake)	9.2	13.8	15.8	22.7	32.5	35.1	86.7
	kW/s (with brake)	8.8	13.4	14.5	21.5	31.1	34.1	85.1
Allowable radial load	N	490		784				1,176
Allowable thrust load	N	196		343				490
Approx. mass	kg (without brake)	6.7	8.6	12.2	16.0	18.6	23.0	42.3
	kg (with brake)	8.1	10.1	15.5	19.2	21.8	26.2	46.2
Brake specifications	Rated voltage	24 VDC±10%						
	Holding brake moment inertia	(J) kg·m ² × 10 ⁻⁴	1.35	4.7				
	Power consumption (20°C)	W	14	19	31			34
	Current consumption (20°C)	A	0.59±10%	0.79±10%	1.30±10%			1.40±10%
	Static friction torque	N·m (minimum)	4.9	13.7	24.5			58.8
	Rise time for holding torque	ms (max.)	80	100	80			150
Release time	ms (max)	70	50	25			50	
Basic specifications	Time Rating	Continuous						
	Insulation class	Type F						
	Ambient operating/storage temperature	0 to 40°C/-20 to 65°C						
	Ambient operating/storage humidity	20% to 85% RH (non-condensing)						
	Vibration class	V-15						
	Insulation resistance	20 MW min. at 500 VDC between the power terminals and FG terminal						
	Enclosure	Totally-enclosed, self-cooling, IP67 (excluding shaft opening)						
	Vibration resistance	Vibration acceleration 49 m/s ²						
Mounting	Flange-mounted							

*1 Applicable load inertia: The operable load inertia ratio (load inertia/rotor inertia) depends on the mechanical configuration and its rigidity. For a machine with high rigidity, operation is possible even with high load inertia. Select an appropriate motor and confirm that operation is possible.

Dimensions

Standard servo motors

Type 3,000 r/min motors (230 V, 50 to 100 W)

Dimensions (mm)	Without brake		With brake		LN	Shaft end dimensions Tap x Depth	Approx. mass (kg)	
	LL	LM	LL	LM			Without brake	With brake
R88M-K05030(H/T)-_S2	72	48	102	78	23	M3 x 6L	0.32	0.53
R88M-K10030(H/T)-_S2	92	68	122	98	43		0.47	0.68

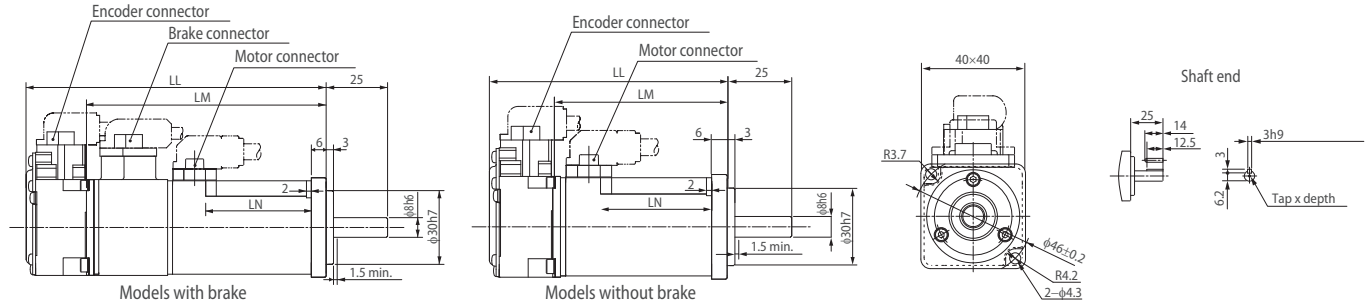

Type 3,000 r/min motors (230 V, 200 to 750 W)

Dimensions (mm)	Without brake		With brake		LR	Flange surface						Shaft end dimensions						Approx. mass (kg)		
	LL	LM	LL	LM		LB	LC	LD	LE	LG	LZ	S	K	QK	H	B	T	Tap x Depth	Without brake	With brake
R88M-K20030(H/T)-_S2	79.5	56.5	116	93	30	50 ^{h7}	60	70	3	6.5	4.5	11 ^{h6}	20	18	8.5	4 ^{h9}	4	M4 x 8L	0.82	1.3
R88M-K40030(H/T)-_S2	99	76	135.5	112.5								14 ^{h6}	25	22.5	11	5 ^{h9}	5	M5 x 10L	1.2	1.7
R88M-K75030(H/T)-_S2	112.2	86.2	148.2	122.2	35	70 ^{h7}	80	90		8	6	19 ^{h6}		22	15.5	6 ^{h9}	6		2.3	3.1

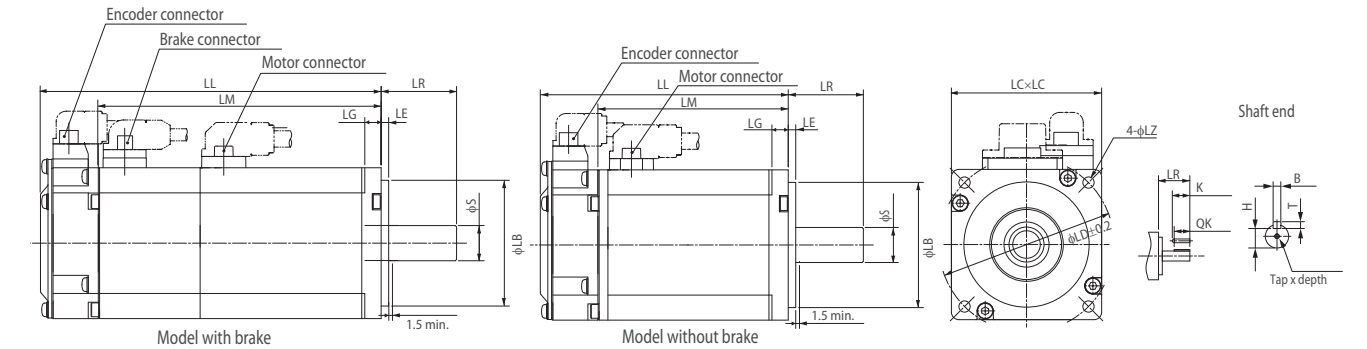

Type 3,000 r/min motors (230 V, 1 to 1.5 kW/ 400V, 750 W to 5 kW)

Voltage	Model	Without brake					With brake					LR	Flange surface						Shaft end dimensions						Approx. mass (kg)		
		LL	LM	KB1	KB2	KL1	LL	LM	KB1	KB2	KL1		LA	LB	LC	LD	LE	LG	S	Tap x Depth	K	QK	H	B	T	Without brake	With brake
230	1K030(H/T)-_S2	141	97	66	119	101	168	124	66	146	101	55	135	95 ^{h7}	100	115	3	10	19 ^{h6}	M5 x 12L	45	42	15.5	6 ^{h9}	6	3.5	4.5
	1K530(H/T)-_S2	159.5	115.5	84.5	137.5		186.5	142.5	84.5	164.5															4.4	5.4	
400	75030(F/C)-_S2	131.5	87.5	56.5	109.5		158.5	114.5	53.5	136.5	103														3.1	4.1	
	1K030(F/C)-_S2	141	97	66	119		168	124	63	146															3.5	4.5	
	1K530(F/C)-_S2	159.5	115.5	84.5	137.5		186.5	142.5	81.5	164.5															4.4	5.4	
	2K030(F/C)-_S2	178.5	134.5	103.5	156.5		205.5	161.5	100.5	183.5															5.3	6.3	
	3K030(F/C)-_S2	190	146	112	168	113	215	171	112	193	113	65	162	110 ^{h7}	120	145	6	12	22 ^{h6}	M8 x 20L	55	51	20	8 ^{h9}	7	8.3	9.4
	4K030(F/C)-_S2	208	164	127	186	118	233	189	127	211	118	65	165		130		6		24 ^{h6}		55	51	20		7	11	12.6
	5K030(F/C)-_S2	243	199	162	221		268	224	162	246															14	16	

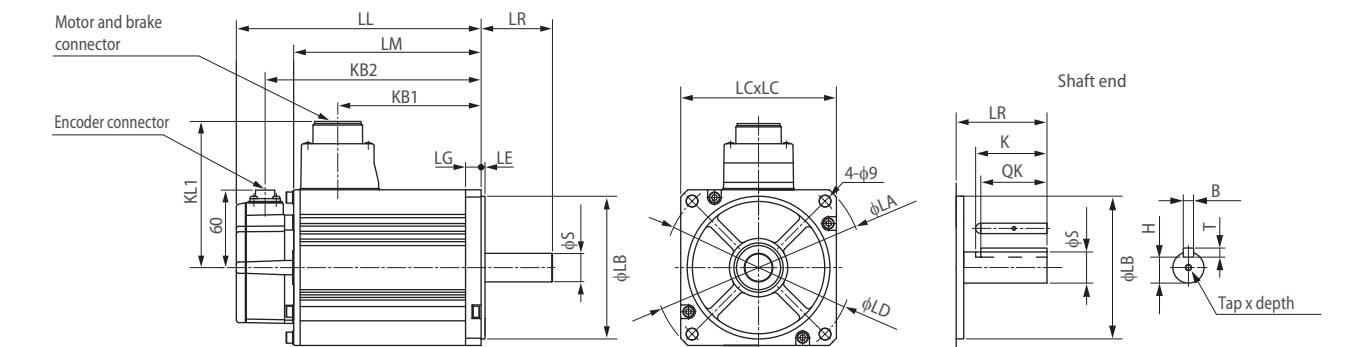

Type 1,500 r/min motors (400 V, 11 to 15 kW)

Dimensions (mm)		Without brake									With brake						Approx. mass (kg)	
Voltage	Model	LL	LM	KB1	KB2	L1	L2	L3	LL	LM	KB1	KB2	L1	L2	L3	Without brake	With brake	
400	R88M-K_																	
	11K015C-_S2	316	272	232	294	124.5	124.5	162	364	320	266	342	124.5	159.5	196	52.7	58.9	
	15K015C-_S2	384	340	300	362	158.5	158.5	230	432	388	334	410	158.5	193.5	264	70.2	76.3	

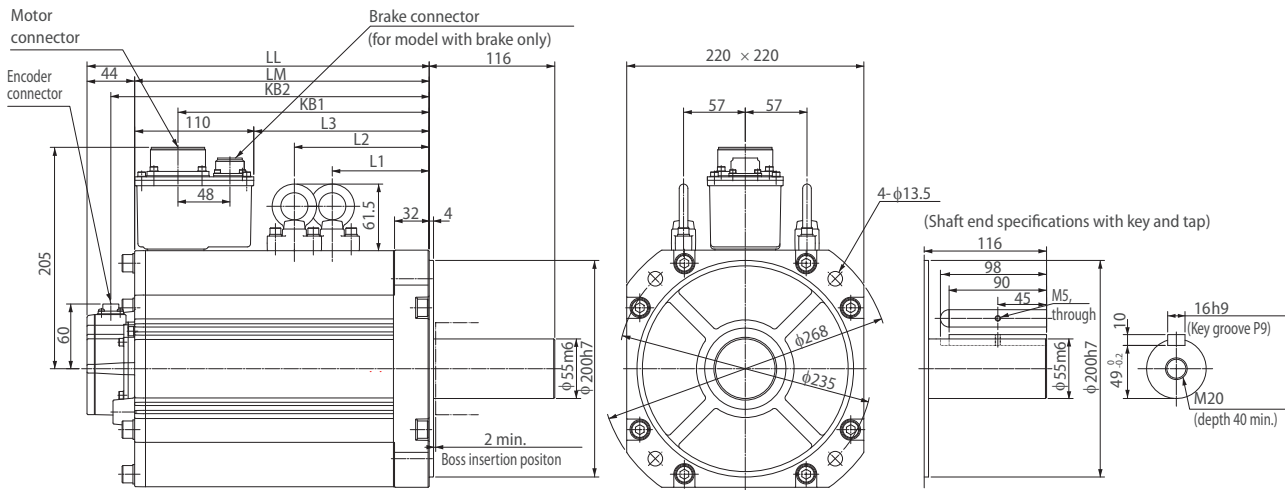

Type 1,000 r/min motors (230 V, 900 W/400 V, 900 W to 3 kW)

Dimensions (mm)		Without brake					With brake					LR									Shaft end dimensions						Approx. mass (kg)		
Voltage	Model	LL	LM	KB1	KB2	KL1	LL	LM	KB1	KB2	KL1	Flange surface									S	Tap × Depth	K	QK	H	B	T	Without brake	With brake
												LA	LB	LC	LD	LE	LG	LZ	LA	LB									
230	90010(H/T)-_S2	155.5	111.5	77.5	133.5	116	180.5	136.5	77.5	158.5	116	70	165	110 ^{h7}	130	145	6	12	9	22 ^{h6}	M5 × 12L	45	41	18	8 ^{h9}	7	6.7	8.2	
400	90010(F/C)-_S2								74.5		118									M5 × 10L									
	2K010(F/C)-_S2	163.5	119.5	82.5	141.5	140	188.5	144.5	82.5	166.5	140	80	233	114.3 ^{h7}	176	200	3.2	18	13.5	35 ^{h6}	M12 × 25L	55	50	30	10 ^{h9}	8	14	17.5	
	3K010(F/C)-_S2	209.5	165.5	128.5	187.5		234.5	190.5	128.5	212.5																20	23.5		

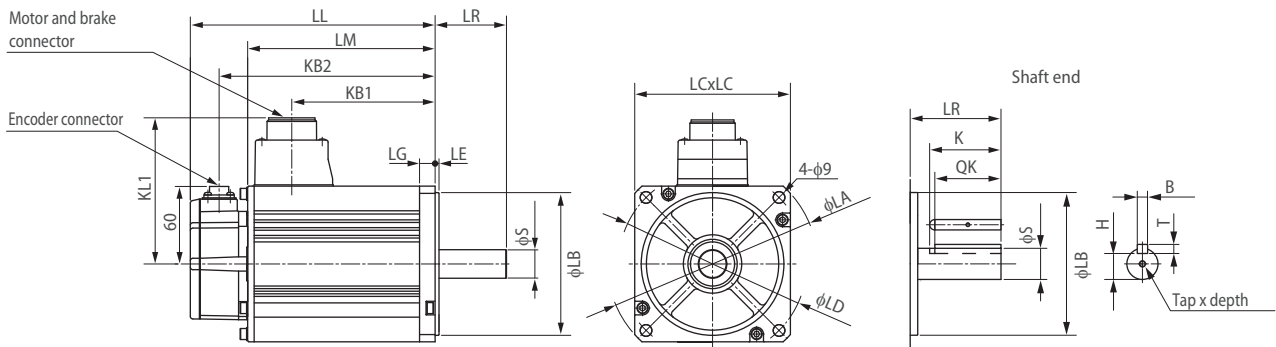

Type 1,000 r/min motors (400 V, 4.5 kW)

Dimensions (mm)		Without brake						With brake						Approx. mass (kg)	
Voltage	Model	LL	LM	KB1	KB2	L1	L2	LL	LM	KB1	KB2	L1	L2	Without brake	With brake
400	R88M-K_														
	4K510C-_S2	266	222	185	244	98	98	291	247	185	269	98	133	29.4	33.3

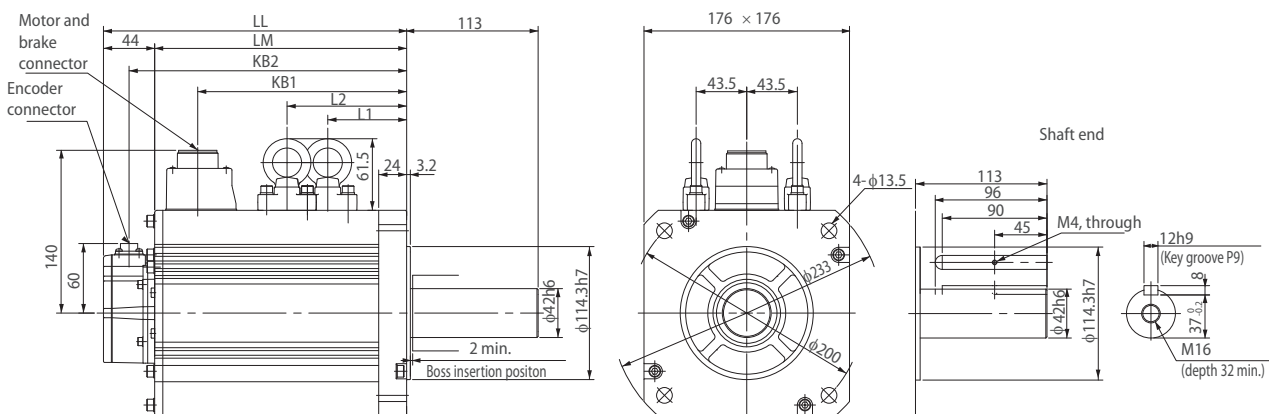

Type 1,000 r/min motors (400 V, 6 kW)

Dimensions (mm)		Without brake							With brake							Approx. mass (kg)	
Voltage	Model	LL	LM	KB1	KB2	L1	L2	L3	LL	LM	KB1	KB2	L1	L2	L3	Without brake	With brake
400	R88M-K_6K010C-_S2	312	268	219	290	117.5	117.5	149	337	293	253	315	117.5	152.5	183	36.4	40.4

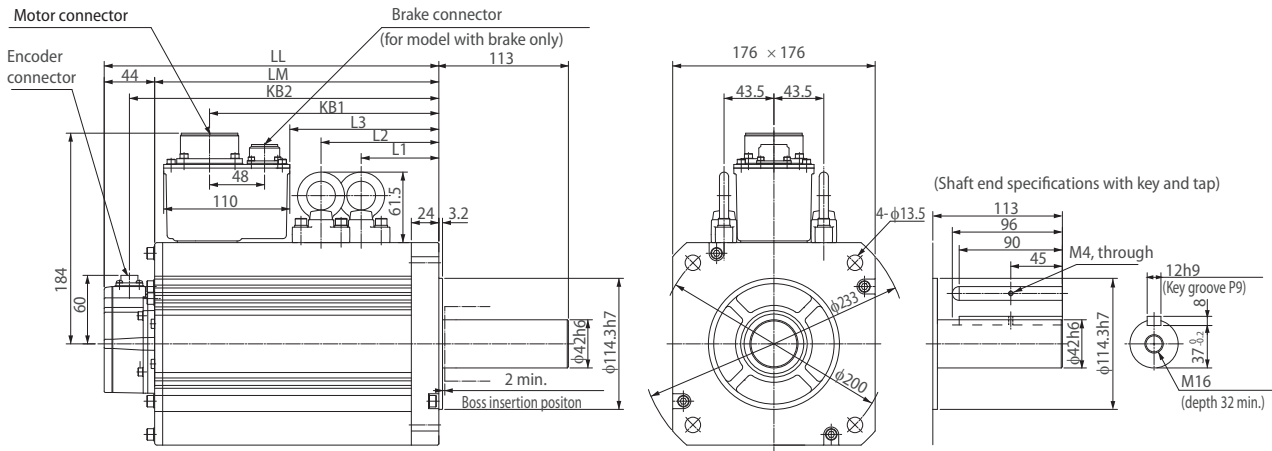

High inertia servo motors

Type 3,000 r/min motors (230 V, 200 to 750 W)

Dimensions (mm)		Without brake		With brake		KB1	LR	Flange surface					Shaft end dimensions					Approx. mass (kg)			
Voltage	Model	L	LL	L	LL			LA	LB	LC	LG	LZ	S	Tap × Depth	K	QK	H	B	T	Without brake	With brake
230	20030(H/T)-_S2-D	129	99	165.5	135.5	42	30	70	50 ^{h7}	60	6.5	4.5	11 ^{h6}	M4 × 8L	20	18	8.5	4 ^{h9}	4	0.96	1.4
	40030(H/T)-_S2-D	148.5	118.5	185	155	61.5		90	70 ^{h7}	60	8		14 ^{h6}	M5 × 10L	25	22.5	11	5 ^{h9}	5	1.4	1.8
	75030(H/T)-_S2-D	162.2	127.2	199.2	164.2	67.2	35	90	70 ^{h7}	80	8	6	19 ^{h6}	M5 × 10L	25	22	15.5	6 ^{h9}	6	2.5	3.3

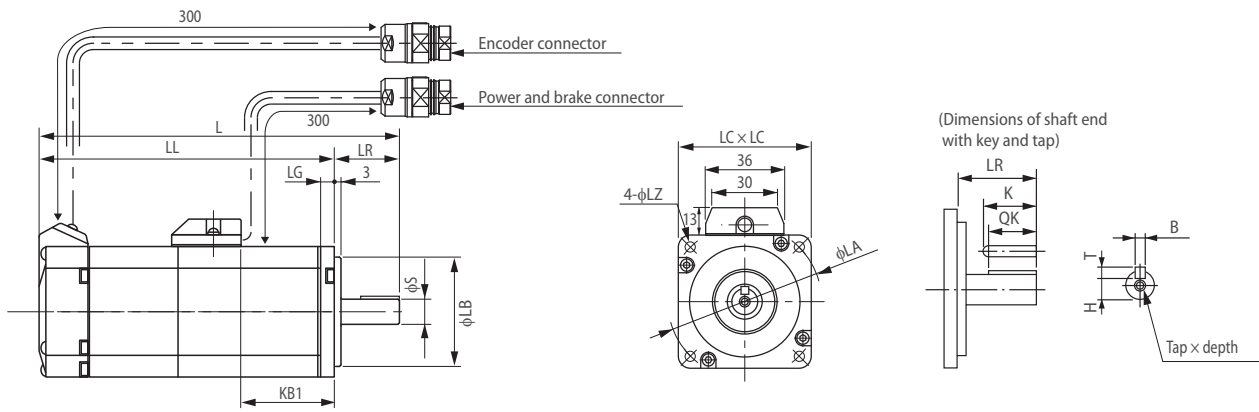

Encoder connector wiring



Cable length 300±30
Connector optional
Made by Hypertac
SRUC-17G-MRWN040 (MALE)

Pin No.	Signal
1	BAT - (0 V)
2	BAT +
3	S +
4	S -
5 to 7	Free
8	ESV (power supply)
9	E0V (power supply)
10 to 17	Free
Connector case	FG (Ground)

* Note: Pins 1 and 2 used only for motors with ABS encoder.

Mating connector:
Plug type: SPOC-17H-FRON169 (FEMALE)

Power and brake connector wiring

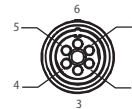

Cable length 300±30
Connector optional
Made by Hypertac
SRUC-06J-MSCN236 (MALE)

Pin No.	Output
1	Phase U
2	Phase V
3	Phase W
4	*Brake terminal
5	*Brake terminal
6	FG (ground)

* Note: Pins 4 and 5 used only for motors with brake.

Mating connector:
Plug type: SPOC-06K-FSDN169 (FEMALE)

Type 2,000 r/min motors (400 V, 1 kW to 5 kW)

Dimensions (mm)		Without brake					With brake					LR	Flange surface							Shaft End Dimensions					Approx. mass (kg)		
Voltage	Model	LL	LM	KB1	KB2	KL1	LL	LM	KB1	KB2	KL1	70	LA	LB	LC	LD	LE	LG	LZ	S	K	QK	H	B	T	Without brake	With brake
		R88M-KH□											22 ^{h6}	45	41	18	8 ^{h9}	7	6.7	8.1							
400	1K020(F/C)-_S1	173	129	95	151	116	201	157	92	179	118	165	110 ^{h7}	130	145	6	12	9	22 ^{h6}	45	41	18	8 ^{h9}	7	6.7	8.1	
	1K520(F/C)-_S1	190.5	146.5	112.5	168.5		218.5	174.5	109.5	196.5															8.6	10.1	
	2K020(F/C)-_S1	177	133	96	155	140	206	162	96	184	140	80	233	114.3 ^{h7}	176	200	3.2	18	13.5	35 ^{h6}	55	50	30	10 ^{h9}	8	12.2	15.5
	3K020(F/C)-_S1	196	152	115	174		225	181	115	203															16.0	19.2	
	4K020(F/C)-_S1	209.5	165.5	128.5	187.5		238.5	194.5	128.5	216.5															18.6	21.8	
	5K020(F/C)-_S1	238.5	194.5	157.5	216.5		267.5	223.5	157.5	245.5															23.0	26.2	

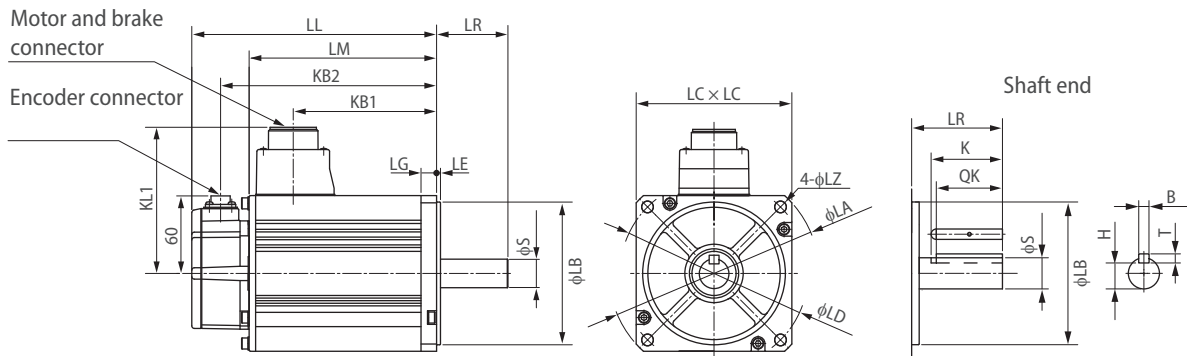

Type 1,500 r/min motors (400 V, 7.5 kW)

Dimensions (mm)		Without brake							With brake						Approx. mass (kg)		
Voltage	Model	LL	LM	KB1	KB2	L1	L2	L3	LL	LM	KB1	KB2	L1	L2	L3	Whithout brake	With brake
		R88M-KH_															
400	7K515C-_S1	357	313	264	335	146.5	146.5	194	382	338	298	360	146.5	181.5	228	42.3	46.2

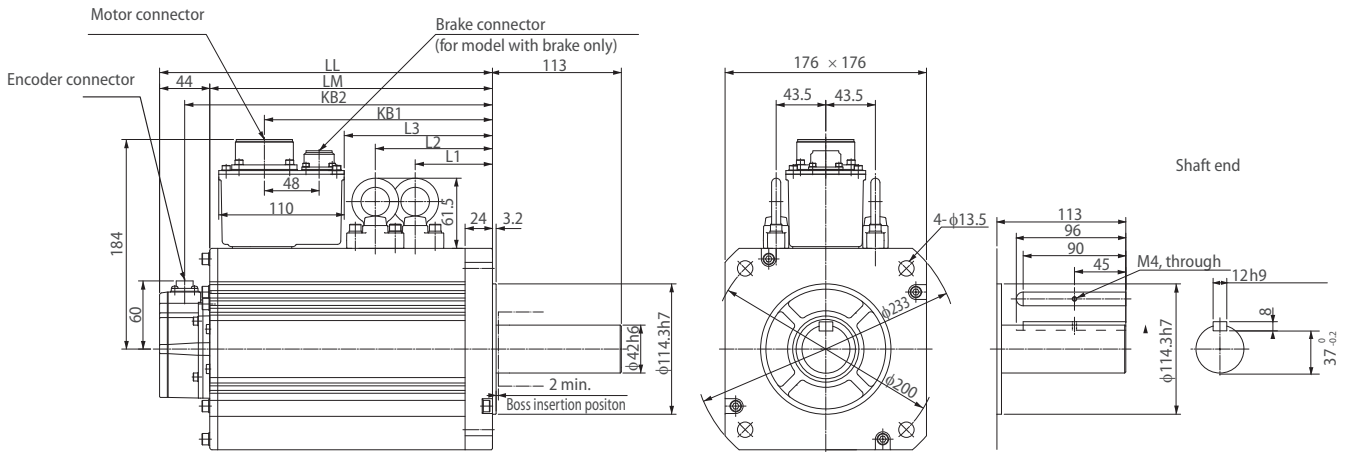



Compact in size, big in features

A wide range of compact servo motors to meet all application needs. When used with a SmartStep 2 drive, the G-Series servo motors offer the simplicity and cost-effectiveness of a stepper with the added advantages of a servo system.

- Peak torque 300% of continuous torque during 3 seconds or more depending on model
- Servo motors supported by SmartStep2, G-Series and Accurax G5 servo drives
- Cylindrical and Flat servo motors types are available
- Encoder accuracy of 10,000 step/rev as standard and 17-bit INC/ABS encoder as optional
- IP65 as standard and shaft oil seal available
- Motors with brake as option

Ordering information

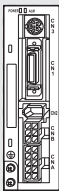

SmartStep 2
Servo drive controlled by pulses (100 to 750 W)

Drive options
②

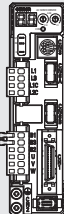

G-Series servo drive
ML2 and analog/pulse models (100 to 1500 W)



③ Encoder cable



⑨ Brake cable



⑥ Power cable

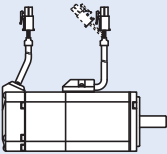

① Servo motor with standard connector
3,000 rpm (50 to 750 W)

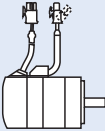

① Flat type servo motor with standard connector
3,000 rpm (100 to 400 W)



④ Encoder cable



⑦ Power cable

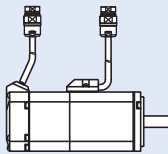

① Servo motor with circular connector
3,000 rpm (50 to 750 W)

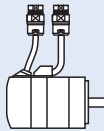

① Flat type servo motor with circular connector
3,000 rpm (100 to 400 W)

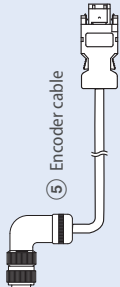

⑤ Encoder cable

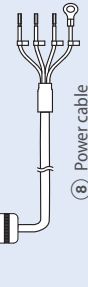

⑧ Power cable

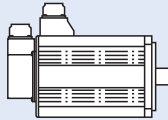

①

3,000 rpm (1,000 to 1,500 W)
2,000 rpm (1,000 to 1,500 W)
1,000 rpm (900 W)

Note: The symbols ①②③④⑤⑥ ... show the recommended sequence to select the servo motor and cables



Servo drive

② Refer to G-Series and SmartStep2 servo drive section for detailed drive specifications and selection of drive accessories.

Servo motor

① Select motor from cylindrical and flat types using motor tables in next pages.

Cylindrical servo motors 3,000/2,000/1,000 r/min (230 V, 50 to 1.5 kW)

Symbol	Specifications					② Compatible servo drives		Servo motor with standard connector	Servo motor with circular connector
	Encoder and design	Speed	Design	Rated torque	Capacity	SmartStep 2	G-Series	Order code	
①  (50 to 750 W)  (900 to 1,500 W)	Incremental encoder (10,000 pulses) Straight shaft with key and tap	3,000 min ⁻¹	Without brake	0.16 Nm	50 W	R7D-BP01H	R88D-G_01H_	R88M-G05030H-S2	R88M-G05030H-S2-D
				0.32 Nm	100 W	R7D-BP01H	R88D-G_01H_	R88M-G10030H-S2	R88M-G10030H-S2-D
				0.64 Nm	200 W	R7D-BP02HH	R88D-G_02H_	R88M-G20030H-S2	R88M-G20030H-S2-D
				1.3 Nm	400 W	R7D-BP04H	R88D-G_04H_	R88M-G40030H-S2	R88M-G40030H-S2-D
				2.4 Nm	750 W	R88D-GP08H	R88D-G_08H_	R88M-G75030H-S2	R88M-G75030H-S2-D
			With brake	0.16 Nm	50 W	R7D-BP01H	R88D-G_01H_	R88M-G05030H-BS2	R88M-G05030H-BS2-D
				0.32 Nm	100 W	R7D-BP01H	R88D-G_01H_	R88M-G10030H-BS2	R88M-G10030H-BS2-D
				0.64 Nm	200 W	R7D-BP02HH	R88D-G_02H_	R88M-G20030H-BS2	R88M-G20030H-BS2-D
				1.3 Nm	400 W	R7D-BP04H	R88D-G_04H_	R88M-G40030H-BS2	R88M-G40030H-BS2-D
				2.4 Nm	750 W	R88D-GP08H	R88D-G_08H_	R88M-G75030H-BS2	R88M-G75030H-BS2-D
	Absolute/incremental encoder (17 bits) Straight shaft with key and tap	3,000 min ⁻¹	Without brake	0.16 Nm	50 W	-	R88D-G_01H_	R88M-G05030T-S2	R88M-G05030T-S2-D
				0.32 Nm	100 W	-	R88D-G_01H_	R88M-G10030T-S2	R88M-G10030T-S2-D
				0.64 Nm	200 W	-	R88D-G_02H_	R88M-G20030T-S2	R88M-G20030T-S2-D
				1.3 Nm	400 W	-	R88D-G_04H_	R88M-G40030T-S2	R88M-G40030T-S2-D
				2.4 Nm	750 W	-	R88D-G_08H_	R88M-G75030T-S2	R88M-G75030T-S2-D
			With brake	0.16 Nm	50 W	-	R88D-G_01H_	R88M-G05030T-BS2	R88M-G05030T-BS2-D
				0.32 Nm	100 W	-	R88D-G_01H_	R88M-G10030T-BS2	R88M-G10030T-BS2-D
				0.64 Nm	200 W	-	R88D-G_02H_	R88M-G20030T-BS2	R88M-G20030T-BS2-D
				1.3 Nm	400 W	-	R88D-G_04H_	R88M-G40030T-BS2	R88M-G40030T-BS2-D
				2.4 Nm	750 W	-	R88D-G_08H_	R88M-G75030T-BS2	R88M-G75030T-BS2-D
	2,000 min ⁻¹	Without brake	4.8 Nm	1 kW	-	R88D-G_10H_	R88M-G1K020T-S2	-	
			7.15 Nm	1.5 kW	-	R88D-G_15H_	R88M-G1K520T-S2	-	
		With brake	4.8 Nm	1 kW	-	R88D-G_10H_	R88M-G1K020T-BS2	-	
			7.15 Nm	1.5 kW	-	R88D-G_15H_	R88M-G1K520T-BS2	-	
			4.77 Nm	1.5 kW	-	R88D-G_15H_	R88M-G1K530T-BS2	-	
	1,000 min ⁻¹	Without brake	8.62 Nm	900 W	-	R88D-G_15H_	R88M-G90010T-S2	-	
			8.62 Nm	900 W	-	R88D-G_15H_	R88M-G90010T-BS2	-	
		With brake	8.62 Nm	900 W	-	R88D-G_15H_	R88M-G90010T-BS2	-	
			8.62 Nm	900 W	-	R88D-G_15H_	R88M-G90010T-BS2	-	
			8.62 Nm	900 W	-	R88D-G_15H_	R88M-G90010T-BS2	-	

Flat type servo motors 3,000 r/min (230 V, 100 to 400 W)

Symbol	Specifications				② Compatible servo drives		Servo motor with standard connector	Servo motor with circular connector
	Encoder and design		Rated torque	Capacity	SmartStep 2	G-Series	Order code	
① 	Incremental encoder (10,000 pulses) Straight shaft with key and tap	Without brake	0.32 Nm	100 W	R7D-BP01H	R88D-G_01H_	R88M-GP10030H-S2	R88M-GP10030H-S2-D
			0.64 Nm	200 W	R7D-BP02HH	R88D-G_02H_	R88M-GP20030H-S2	R88M-GP20030H-S2-D
			1.3 Nm	400 W	R7D-BP04H	R88D-G_04H_	R88M-GP40030H-S2	R88M-GP40030H-S2-D
		With brake	0.32 Nm	100 W	R7D-BP01H	R88D-G_01H_	R88M-GP10030H-BS2	R88M-GP10030H-BS2-D
			0.64 Nm	200 W	R7D-BP02HH	R88D-G_02H_	R88M-GP20030H-BS2	R88M-GP20030H-BS2-D
			1.3 Nm	400 W	R7D-BP04H	R88D-G_04H_	R88M-GP40030H-BS2	R88M-GP40030H-BS2-D
	Absolute/incremental encoder (17 bits) Straight shaft with key and tap	Without brake	0.32 Nm	100 W	-	R88D-G_01H_	R88M-GP10030T-S2	R88M-GP10030T-S2-D
			0.64 Nm	200 W	-	R88D-G_02H_	R88M-GP20030T-S2	R88M-GP20030T-S2-D
		With brake	0.32 Nm	100 W	-	R88D-G_01H_	R88M-GP10030T-BS2	R88M-GP10030T-BS2-D
			0.64 Nm	200 W	-	R88D-G_02H_	R88M-GP20030T-BS2	R88M-GP20030T-BS2-D
		1.3 Nm	400 W	-	R88D-G_04H_	R88M-GP40030T-BS2	R88M-GP40030T-BS2-D	

Encoder cables

For 50 to 750 W servo motors with standard connectors

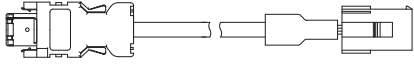
Symbol	Appearance	Specifications	Length	Order code	
③		Encoder cable (50 to 750 W) R88M-G(50/100/200/400/750)30 R88M-GP(100/200/400)30	Absolute encoder T_	1.5 m	R88A-CRGA001-5CR-E
				3 m	R88A-CRGA003CR-E
				5 m	R88A-CRGA005CR-E
				10 m	R88A-CRGA010CR-E
				15 m	R88A-CRGA015CR-E
				20 m	R88A-CRGA020CR-E
			Incremental encoder H_	1.5 m	R88A-CRGB001-5CR-E
				3 m	R88A-CRGB003CR-E
				5 m	R88A-CRGB005CR-E
				10 m	R88A-CRGB010CR-E
				15 m	R88A-CRGB015CR-E
				20 m	R88A-CRGB020CR-E

For 50 to 750 W servo motors with circular connector

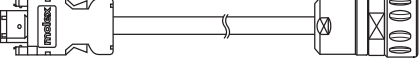
Symbol	Appearance	Specifications	Length	Order code
④		Encoder cable (50 to 750 W) R88M-G(50/100/200/400/750)30_----D R88M-GP(100/200/400)30_----D	3 m	R88A-CRWA003C-DE
			5 m	R88A-CRWA005C-DE
			10 m	R88A-CRWA010C-DE
			15 m	R88A-CRWA015C-DE
			20 m	R88A-CRWA020C-DE

For 900 to 1,500 W servo motors

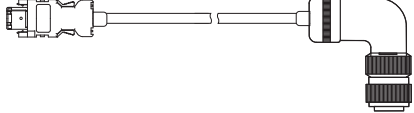
Symbol	Appearance	Specifications	Length	Order code
⑤		Encoder cable (900-1500 W) R88M-G(1K0/1K5)30T_-- R88M-G(1K0/1K5)20T_-- R88M-G90010T_--	1.5 m	R88A-CRGC001-5NR-E
			3 m	R88A-CRGC003NR-E
			5 m	R88A-CRGC005NR-E
			10 m	R88A-CRGC010NR-E
			15 m	R88A-CRGC015NR-E
20 m	R88A-CRGC020NR-E			

Battery cable for G-series servo drive models with absolute encoder

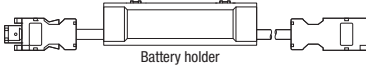
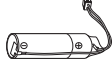
Symbol	Appearance	Specifications	Order code		
④	 <p>Battery holder</p>	Absolute encoder battery cable	Battery not included	0.3 m	R88A-CRGDOR3C-E
			Battery included	0.3 m	R88A-CRGDOR3C-BS-E
		Absolute encoder backup battery 2,000 mA.h 3.6 V	-	R88A-BAT01G	



Note: The absolute encoder battery cable is only an extension and must be used with an absolute encoder cable.

Power cables

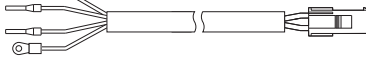

For 50 to 750 W servo motors with standard connectors

Symbol	Appearance	Specifications	Applicable servo drive	Length	Order code
⑥		For servomotors from 50 to 400 W R88M-G(050/100/200/400)30_ R88M-GP(100/200/400)30_	SmartStep 2	1.5 m	R7A-CAB001-5SR-E
				3 m	R7A-CAB003SR-E
				5 m	R7A-CAB005SR-E
				10 m	R7A-CAB010SR-E
				15 m	R7A-CAB015SR-E
		For servomotors from 50 to 750 W R88M-G(050/100/200/400/750)30_ R88M-GP(100/200/400)30_	SmartStep 2 (only 750 W) and G-Series	1.5 m	R88A-CAGA001-5SR-E
				3 m	R88A-CAGA003SR-E
				5 m	R88A-CAGA005SR-E
				10 m	R88A-CAGA010SR-E
				15 m	R88A-CAGA015SR-E
20 m	R88A-CAGA020SR-E				

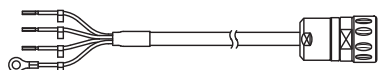
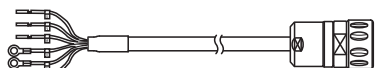
For 50 to 750 W servo motors with circular connectors

Symbol	Appearance	Specifications	Applicable servo drive	Length	Order code	
⑦		For servomotors from 50 to 400 W R88M-G(050/100/200/400)30_ R88M-GP(100/200/400)30_	Without brake -S2-D	SmartStep 2	1.5 m	R7A-CAB001-5SR-DE
					3 m	R7A-CAB003SR-DE
					5 m	R7A-CAB005SR-DE
					10 m	R7A-CAB010SR-DE
					15 m	R7A-CAB015SR-DE
					20 m	R7A-CAB020SR-DE
			With brake -BS2-D	1.5 m	R7A-CAB001-5BR-DE	
				3 m	R7A-CAB003BR-DE	
				5 m	R7A-CAB005BR-DE	
				10 m	R7A-CAB010BR-DE	
				15 m	R7A-CAB015BR-DE	
				20 m	R7A-CAB020BR-DE	
	For servomotors from 50 to 750 W R88M-G(050/100/200/400/750)30_ R88M-GP(100/200/400)30_	Without brake -S2-D	SmartStep 2 (only 750 W) and G-Series	3 m	R88A-CAWA003S-DE	
				5 m	R88A-CAWA005S-DE	
				10 m	R88A-CAWA010S-DE	
				15 m	R88A-CAWA015S-DE	
				With brake -BS2-D	3 m	R88A-CAWA003B-DE
					5 m	R88A-CAWA005B-DE
					10 m	R88A-CAWA010B-DE
					15 m	R88A-CAWA015B-DE
20 m	R88A-CAWA020B-DE					

For 900 to 1,500 W servo motors

Symbol	Appearance	Specifications	Applicable servo drive	Length	Order code	
⑧		For servomotors from 900 to 1.5 kW R88M-G(1K0/1K5)30T_ R88M-G(1K0/1K5)20T_ R88M-G90010T_	Without brake -S2	G-Series	1.5 m	R88A-CAGB001-5SR-E
					3 m	R88A-CAGB003SR-E
					5 m	R88A-CAGB005SR-E
					10 m	R88A-CAGB010SR-E
					15 m	R88A-CAGB015SR-E
					20 m	R88A-CAGB020SR-E
			With brake -BS2		1.5 m	R88A-CAGB001-5BR-E
					3 m	R88A-CAGB003BR-E
					5 m	R88A-CAGB005BR-E
					10 m	R88A-CAGB010BR-E
					15 m	R88A-CAGB015BR-E
					20 m	R88A-CAGB020BR-E

Brake cable with standard connector

Symbol	Appearance	Specifications	Order code	
⑥		Brake cable only. For servomotors from 50 to 750W with brake R88M-G(050/100/200/400/750)30_-BS2, R88M-GP(100/200/400)30_-BS2	1.5 m	R88A-CAGA001-5BR-E
			3 m	R88A-CAGA003BR-E
			5 m	R88A-CAGA005BR-E
			10 m	R88A-CAGA010BR-E
			15 m	R88A-CAGA015BR-E
			20 m	R88A-CAGA020BR-E

Connectors for power, encoder and brake cables

Specifications			Applicable servomotor	Order code
Connectors for power cable	Drive side (CNB)	-	R88M-G(050/100/200/400)30H_ R88M-GP(100/200/400)30H_	R7A-CNB01A
	Motor side	Standard connector	R88M-G(050/100/200/400/750)30_ R88M-GP(100/200/400)30_	R88A-CNG01A
			R88M-G(1K0/1K5)30_-S2 R88M-G(1K0/1K5)20_-S2 R88M-G90010_-S2	MS3108E20-4S
			R88M-G(1K0/1K5)30_-BS2 R88M-G(1K0/1K5)20_-BS2 R88M-G90010_-BS2	MS3108E20-18S
			Circular connector (Hypertac)	R88M-G(50/100/200/400/750)30_-_-_-_-D R88M-GP(100/200/300)_-_-_-_-D
Connectors for encoder cable	Drive side (CN2)	-	All models	R88A-CNW01R
Motor side	Standard connector	R88M-G(050/100/200/400/750)30T_ R88M-GP(100/200/400)30T_	R88A-CNG01R	
		R88M-G(050/100/200/400/750)30H_ R88M-GP(100/200/400)30H_	R88A-CNG02R	
		R88M-G(1K0/1K5)30T_ R88M-G(1K0/1K5)20T_ R88M-G90010T_	MS3108E20-29S	
	Circular connector (Hypertac)	R88M-G(50/100/200/400/750)30_-_-_-_-D R88M-GP(100/200/300)_-_-_-_-D	SPOC-17H-FRON169	
Connector for brake cable	Motor side	Standard connector	R88M-G(050/100/200/400/750)30_-BS2 R88M-GP(100/200/400)30_-BS2	R88A-CNG01B

Connectors included with the motor

Specifications		Applicable servomotor	Order code
Power and brake connector (MALE)	Circular connector (Hypertac)	R88M-G(50/100/200/400/750)30_-_-_-_-D R88M-GP(100/200/300)_-_-_-_-D	SRUC-06J-MSCN236
Encoder connector (MALE)		R88M-G(50/100/200/400/750)30_-_-_-_-D R88M-GP(100/200/300)_-_-_-_-D	SRUC-17G-MRWNO87

Note: 1. All cables listed are flexible and shielded (except the R88A-CAGA ___ BR-E which is only a flexible cable).
 2. The R88A-CRGC ___ NR-E, R88A-CAGB ___ SR-E, R88A-CAGB ___ BR-E, R88A-CRWA ___ C-DE, R88A-CAWA ___ S-DE and R88A-CAWA ___ B-DE cables have IP67 class (including connector).

Specifications

Cylindrical servo motors 3,000/2,000/1,000 r/min

Applied voltage		230 V										
Servo motor model R88M-__		G05030_	G10030_	G20030_	G40030_	G75030_	G1K030T	G1K530T	G1K020T	G1K520T	G90010T	
Rated output	W	50	100	200	400	750	1,000	1,500	1,000	1,500	900	
Rated torque	N·m	0.16	0.32	0.64	1.3	2.4	3.18	4.77	4.8	7.15	8.62	
Instantaneous peak torque	N·m	0.45	0.90	1.78	3.67	7.05	9.1	12.8	13.5	19.6	18.4	
Rated current	A (rms)	1.1		1.6	2.6	4	7.2	9.4	5.6	9.4	7.6	
Instantaneous max. current	A (rms)	3.4		4.9	7.9	12.1	21.4	28.5	17.1	28.5	17.1	
Rated speed	min ⁻¹	3,000							2,000		1,000	
Max. speed	min ⁻¹	5,000				4,500	5,000		3,000		2,000	
Torque constant	N·m/A (rms)	0.14	0.19	0.41	0.51	0.64	0.44	0.51	0.88	0.76	1.13	
Rotor moment of inertia (JM)	kg·m ² ×10 ⁻⁴	0.025	0.051	0.14	0.26	0.87	1.69	2.59	6.17	11.2		
Allowable load moment of inertia (JL)	Multiple of (JM)	30				20	15		10			
Rated power rate	kW/s	10.4	20.1	30.3	62.5	66	60	88	37.3	45.8	66.3	
Applicable Encoder		Incremental encoder (10,000 pulses)					-					
		Incremental /Absolute encoder(17 bits)										
Allowable radial load	N	68		245		392		490		686		
Allowable thrust load	N	58		98		147		196				
Approx. mass	kg (without brake)	0.3	0.5	0.8	1.2	2.3	4.5	5.1	6.8	8.5		
	kg (with brake)	0.5	0.7	1.3	1.7	3.1	5.1	6.5	8.7	10.1	10	
Brake specifications	Rated voltage	24 VDC±5%						24 VDC±10%				
	Holding brake moment of inertia J	0.002			0.018		0.075		0.25		1.35	
	Power consumption (at 20°C)	W		7	9		10		18	19	14	19
	Current consumption (at 20°C)	A		0.3	0.36		0.42		0.74	0.81	0.59	0.79
	Static friction torque	N·m (minimum)		0.29	1.27		2.45		4.9	7.8	4.9	13.7
	Rise time for holding torque	ms (max.)		35	50		70		50	80	100	
Release time	ms (max)		20	15		20		15	70	50		

Applied voltage		230 V									
Servo motor model R88M-__		G05030_	G10030_	G20030_	G40030_	G75030_	G1K030T	G1K530T	G1K020T	G1K520T	G90010T
Basic specifications	Rating	Continuous									
	Insulation grade	Type B					Type F				
	Ambient operating/storage temperature	0 to 40°C/-20 to 65°C					0 to 40°C/-20 to 80°C				
	Ambient operating/storage humidity	85% RH max. (non-condensing)									
	Vibration class	V-15									
	Insulation resistance	20 MΩ min. at 500 VDC between the power terminals and FG terminal									
	Enclosure	Totally-enclosed, self-cooling, IP65 (excluding shaft opening and lead wire ends)									
	Vibration resistance	Vibration acceleration 49 m/s ²					Vibration acceleration 24.5 m/s ²				
	Mounting	Flange-mounted									

Flat servo motors 3,000 r/min

Applied voltage		230 V					
Servo motor model R88M-__		GP10030_		GP20030_		GP40030_	
Rated output	W	100		200		400	
Rated torque	N·m	0.32		0.64		1.3	
Instantaneous peak torque	N·m	0.86		1.8		3.65	
Rated current	A (rms)	1		1.6		2.5	
Instantaneous max. current	A (rms)	3.1		4.9		7.5	
Rated speed	min ⁻¹	3,000					
Max. speed	min ⁻¹	5,000					
Torque constant	N·m/A (rms)	0.34		0.42		0.54	
Rotor moment of inertia (JM)	kg·m ² ×10 ⁻⁴	0.1		0.35		0.64	
Allowable load moment of inertia (JL)	Multiple of (JM)	20					
Rated power rate	kW/s	10.2		11.5		25.5	
Applicable encoder		Incremental (10,000 pulses)					
		Incremental/Absolute encoder (17 bits)					
Allowable radial load	N	68		245			
Allowable thrust load	N	58		98			
Approx. mass	kg (without brake)	0.7		1.3		1.8	
	kg (with brake)	0.9		2		2.5	
Brake specifications	Rated voltage	24 VDC±10%					
	Holding brake moment of inertia J	kg·m ² ×10 ⁻⁴	0.03		0.09		
	Power consumption (at 20°C)	W	7		10		
	Current consumption (at 20°C)	A	0.29		0.41		
	Static friction torque	N·m (minimum)	0.29		1.27		
	Rise time for holding torque	ms (max.)	50		60		
Release time	ms (max)	15					
Basic specifications	Rating	Continuous					
	Insulation grade	Type B					
	Ambient operating/storage temperature	0 to 40°C/-20 to 80°C					
	Ambient operating/storage humidity	85% RH max. (non-condensing)					
	Vibration class	V-15					
	Insulation resistance	20 MΩ min. at 500 VDC between the power terminals and FG terminal					
	Enclosure	Totally-enclosed, self-cooling, IP65 (excluding shaft opening and lead wire ends)					
	Vibration resistance	Vibration acceleration 49 m/s ²					
Mounting	Flange-mounted						

Dimensions

Cylindrical type 3,000 r/min (230 V, 50 to 100 W)

Dimensions (mm)	Without brake		LN	Flange surface		Shaft end		Aprox. mass (kg)	
	LL	With brake		D	S	B	Without brake	With brake	
R88M-G05030_-S2_-	72	102	26.5	30 ^{h7}	8 ^{h6}	3 ^{h9}	0.3	0.5	
R88M-G10030_-S2_-	92	122	46.5				0.5	0.7	

Servo motor with standard connector

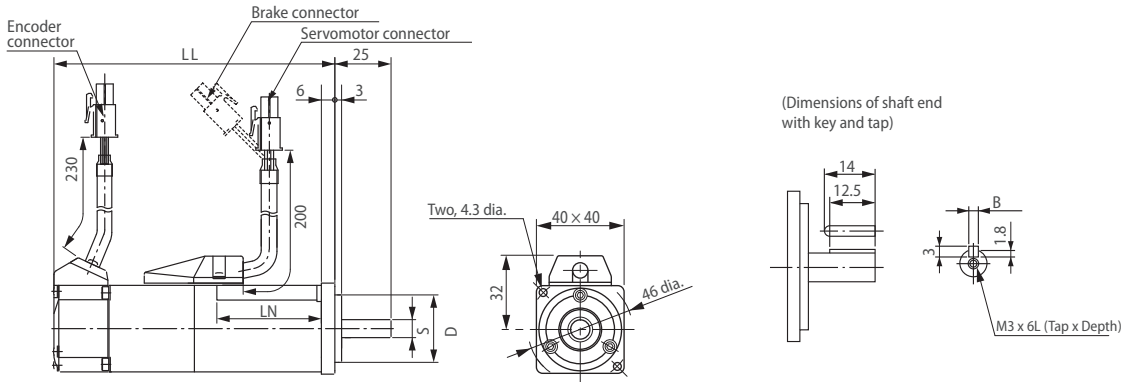

Servo motor with circular connector

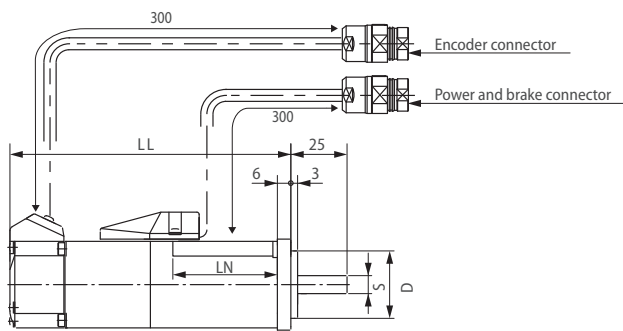

Encoder connector wiring

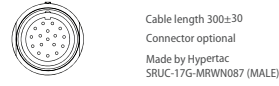

Pin No.	Signal
1	BAT - (0 V)
2	BAT +
3	S +
4	S -
5 to 7	Free
8	ESV (power supply)
9	EOV (power supply)
10 to 17	Free
Connector case	FG (Ground)

*Note: Pins 1 and 2 used only for motors with ABS encoder.

Mating connector:
Plug type: SPOC-17H-FRON169 (FEMALE)

Power and brake connector wiring

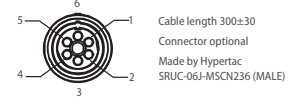

Pin No.	Output
1	Phase U
2	Phase V
3	Phase W
4	*Brake terminal
5	*Brake terminal
6	FG (ground)

*Note: Pins 4 and 5 used only for motors with brake.

Mating connector:
Plug type: SPOC-06K-FSDN169 (FEMALE)

Cylindrical type 3,000 r/min (230 V, 200 to 750 W)

Dimensions (mm)	Without brake	With brake	LR	KL1	Flange surface					Shaft end					Approx. mass (kg)		
					D1	D2	C	G	Z	S	QK	B	H	T1	Tap x depth	Without brake	With brake
R88M-G20030_-S2_-	79.5	116	30	43	70	50 ^{h7}	60	6.5	4.5	11 ^{h6}	18	4 ^{h9}	4	2.5	M4 x 8L	0.8	1.3
R88M-G40030_-S2_-	99	135.5								14 ^{h6}	22.5	5 ^{h9}	5	3	M5 x 10L	1.2	1.7
R88M-G75030_-S2_-	112.2	149.2	35	53	90	70 ^{h7}	80	8	6	19 ^{h6}	22	6 ^{h9}	6	3.5		2.3	3.1

Servo motor with standard connector

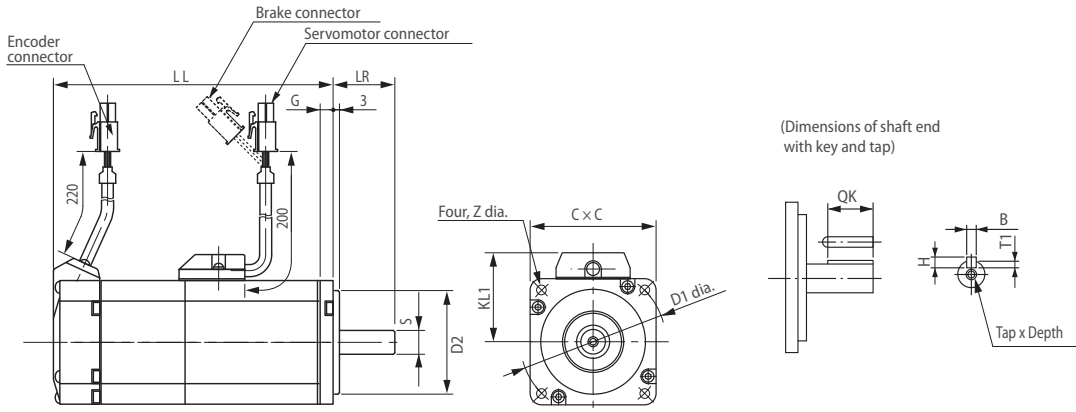

Servo motor with circular connector

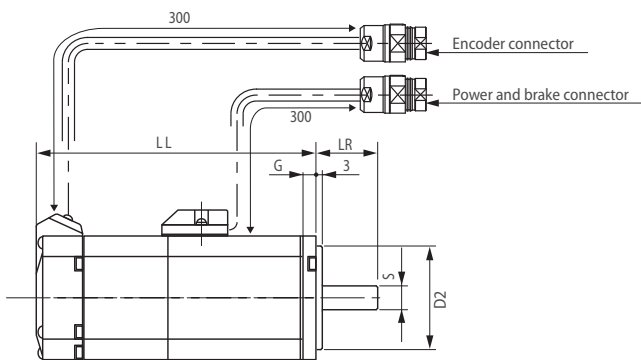

Encoder connector wiring



Cable length 300±30
Connector optional
Made by Hypertac
SRUC-17G-MRWN087 (MALE)

Pin No.	Signal
1	BAT - (0 V)
2	BAT +
3	S +
4	S -
5 to 7	Free
8	E5V (power supply)
9	E0V (power supply)
10 to 17	Free
Connector case	FG (Ground)

*Note: Pins 1 and 2 used only for motors with ABS encoder.

Mating connector:
Plug type: SPOC-17H-FRON169 (FEMALE)

Power and brake connector wiring

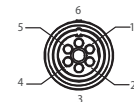

Cable length 300±30
Connector optional
Made by Hypertac
SRUC-06J-MSCN236 (MALE)

Pin No.	Output
1	Phase U
2	Phase V
3	Phase W
4	*Brake terminal
5	*Brake terminal
6	FG (ground)

*Note: Pins 4 and 5 used only for motors with brake.

Mating connector:
Plug type: SPOC-06K-FSDN169 (FEMALE)

Cylindrical type 3,000, 2,000 and 1,000 r/min (230 V, 900 kW to 1.5 kW)

Dimensions (mm)	Without brake	With brake	LR	KL1	Flange surface							Shaft end					Approx. mass (kg)			
					D1	D2	D3	C	G	F	Z	S	QK	B	H	T1	Tap x depth	Without brake	With brake	
R88M-G1K030T_-S2	175	200	55	98	100	80 ^{h7}	120	90	7	3	6.6	19 ^{h6}	42	6 ^{h9}	6	3.5	M5 x 12L	4.5	5.1	
R88M-G1K530T_-S2	180	205			103	115	95 ^{h7}	135	100	10		9							5.1	6.5
R88M-G1K020T_-S2	150	175			118	145	110 ^{h7}	165	130	12	6	22 ^{h6}	41	8 ^{h9}	7	4		6.8	8.7	
R88M-G1K520T_-S2	175	200																8.5	10.1	
R88M-G90010T_-S2	175	200	70																10	

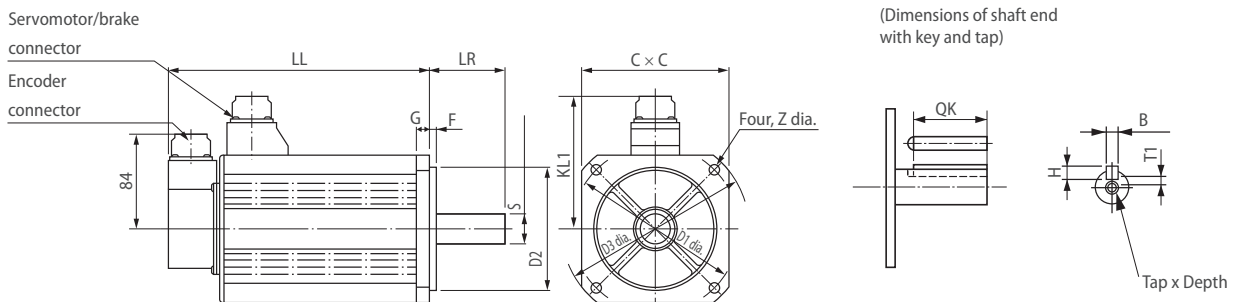

Flat type 3;000 r/min (230 V, 100 W to 400 W)

Dimensions (mm)	Without brake	With brake	LR	KL1	Flange surface							Shaft end					Aprox. mass (kg)	
Model	LL	LL			D1	D2	C	F	G	Z	S	QK	B	H	T1	Tap × depth	Without brake	With brake
R88M-GP10030H-_-S2-_-	60.5	84.5	25	43	70	50 ^{h7}	60	3	7	4.5	8 ^{h6}	12.5	3 ^{h9}	3	1.8	M3 × 6L	0.7	0.9
R88M-GP10030T-_-S2-_-	87.5	111.5																
R88M-GP20030H-_-S2-_-	67.5	100	30	53	90	70 ^{h7}	80	5	8	5.5	11 ^{h6}	18	4 ^{h9}	4	2.5	M4 × 8L	1.3	2
R88M-GP20030T-_-S2-_-	94.5	127																
R88M-GP40030H-_-S2-_-	82.5	115									14 ^{h6}	22.5	5 ^{h9}	5	3.0	M5 × 10L	1.8	2.5
R88M-GP40030T-_-S2-_-	109.5	142																

Servo motor with standard connector

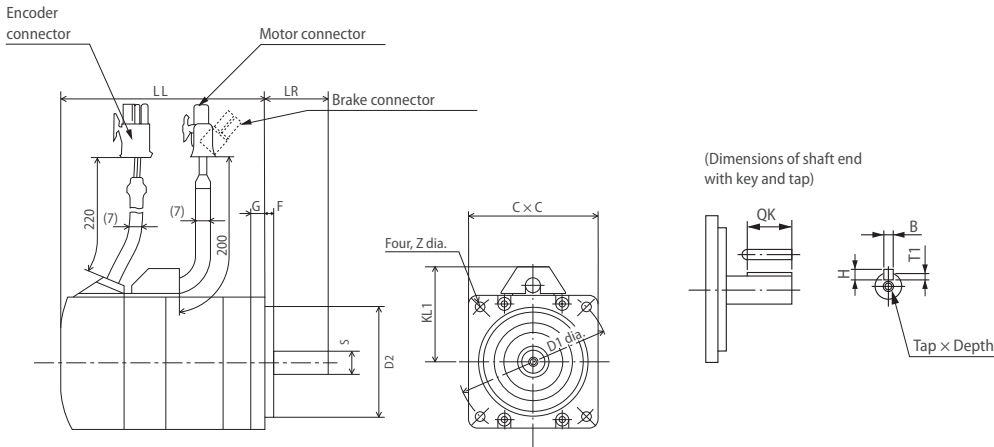

Servo motor with circular connector

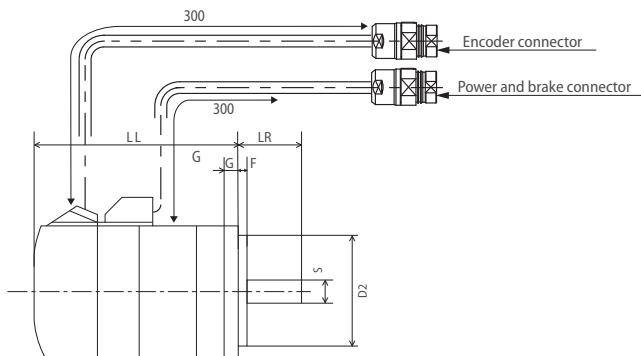

Encoder connector wiring



Cable length 300±30
Connector optional
Made by Hypertac
SRUC-17G-MRWN087 (MALE)

Encoder connector	
Pin No.	Signal
1	BAT - (0 V)
2	BAT +
3	S +
4	S -
5 to 7	Free
8	E5V (power supply)
9	E0V (power supply)
10 to 17	Free
Connector case	FG (Ground)

*Note: Pins 1 and 2 used only for motors with ABS encoder.

Mating connector:
Plug type: SPOC-17H-FRON169 (FEMALE)

Power and brake connector wiring

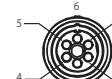

Cable length 300±30
Connector optional
Made by Hypertac
SRUC-06J-MSCN236 (MALE)

Power and brake connector	
Pin No.	Output
1	Phase U
2	Phase V
3	Phase W
4	*Brake terminal
5	*Brake terminal
6	FG (ground)

*Note: Pins 4 and 5 used only for motors with brake.

Mating connector:
Plug type: SPOC-06K-FSDN169 (FEMALE)

Frequency inverters

BORN TO DRIVE MACHINES

Harmonised motor and machine control



Specifically created for your application, the MX2 was developed to harmonise advanced motor and machine control. Thanks to its advanced design and algorithms the MX2 provides smooth control down to zero speed, plus precise operation for fast cyclic operations and torque control capability in open loop.

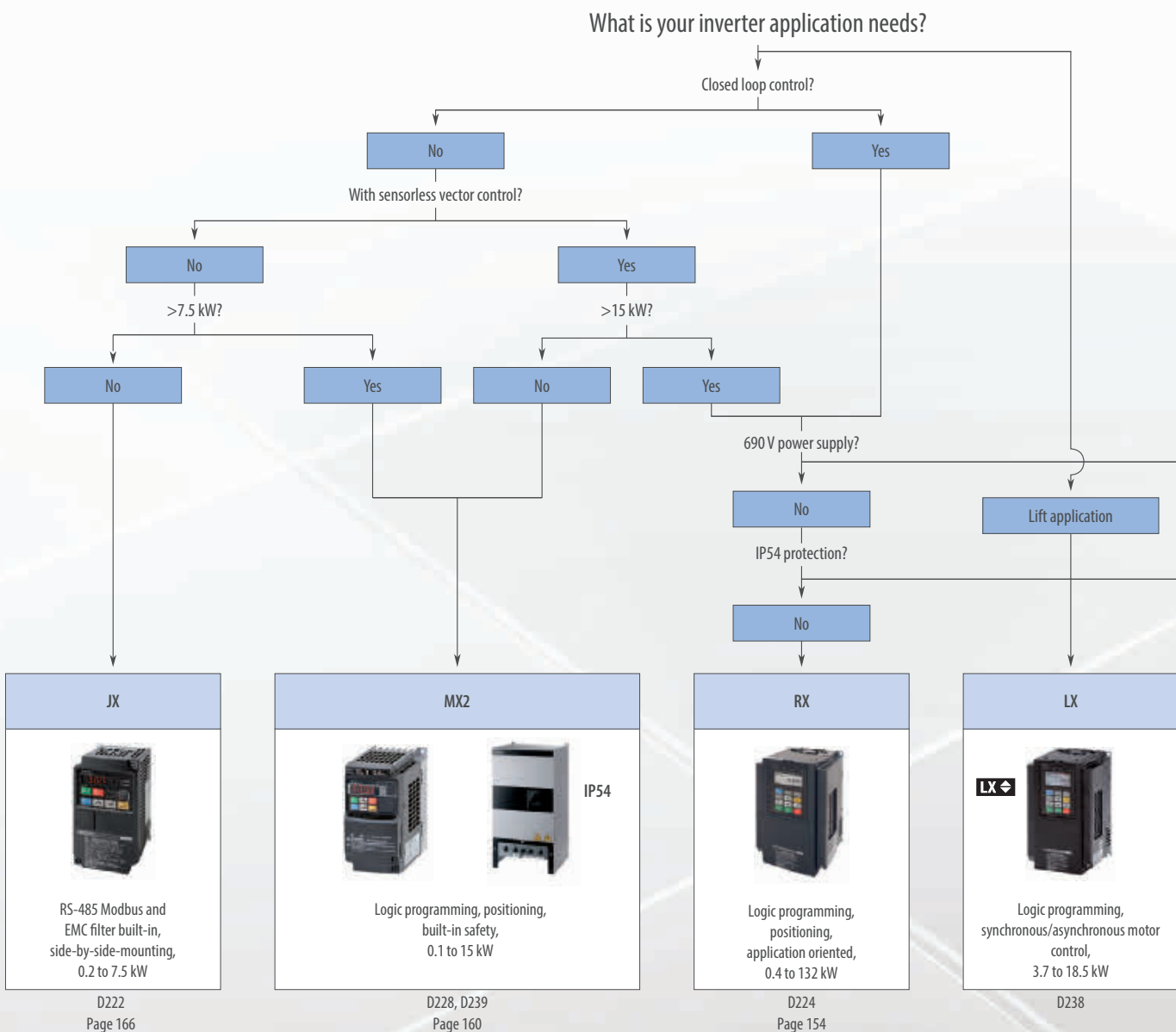

The MX2 also gives you comprehensive functionality for machine control such as positioning, speed synchronisation and logic programming. The MX2 is fully integrated within the Omron smart automation platform.

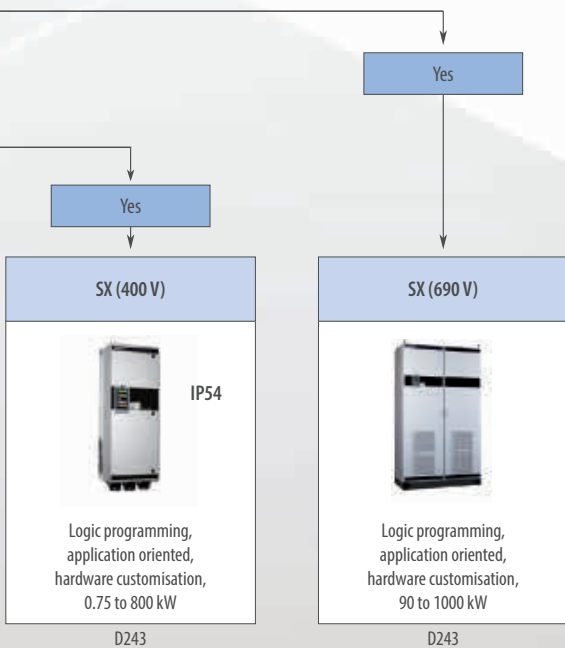

The MX2 is the child of a true leader in machine automation.





Model	RX	LX
		 LX ⇄
	Customised to your machine	Lift applications
400 V three-phase	0.4 kW to 132 kW	3.7 kW to 18.5 kW
200 V three-phase	0.4 kW to 55 kW	–
Application	High performance, built-in know-how functionality	Lift control with asynchronous and synchronous motors
Control method	Open and closed loop for vector and V/F control	Open and closed loop vector control and V/F control
Torque features	200% at 0.0 Hz (CLV) 150% at 0.3 Hz (OLV)	150% at 0.0 Hz (CLV) 200% at 0.3 Hz (OLV)
Connectivity	Modbus, DeviceNet, PROFIBUS, MECHATROLINK-II, EtherCAT, CompoNet	Modbus
Logic programming	Standard firmware	Standard firmware
Page/Quick Link	154	D238

Model	MX2	JX
	  IP54	
	Born to drive machines	Compact and complete
400 V three-phase	0.4 kW to 15 kW	0.4 kW to 7.5 kW
200 V three-phase	0.1 kW to 15 kW	0.2 kW to 7.5 kW
200 V single-phase	0.1 kW to 2.2 kW	0.2 kW to 2.2 kW
Application	Harmonized motor and machine control	General purpose built-in communications
Control method	Open loop speed and torque control for vector and speed for V/F control	V/F control
Torque features	200% at 0.5 Hz	150% at 3 Hz
Connectivity	Modbus, DeviceNet, PROFIBUS, MECHATROLINK-II, EtherCAT, CompoNet, EtherNet IP	Modbus
Logic programming	Standard firmware	N/A
Customisation options	IP54 enclosure	N/A
Page/Quick Link	160	166

Model	SX (400 V)	SX (690 V)
	 IP54	
	High performance vector control	
400 V three-phase	0.75 kW to 800 kW	–
690 V three-phase	–	90 kW to 1,000 kW
Application	High power flux vector and variable torque applications	High power flux vector and variable torque applications
Control method	Flux vector and V/F control	Flux vector and V/F control
Torque features	120% at 0,0 Hz (CLV) 120% at 0,5 Hz (OLV)	120% at 0,0 Hz (CLV) 120% at 0,5 Hz (OLV)
Connectivity	Modbus, DeviceNet, PROFIBUS, EtherCAT, Modbus TCP, CAN	Modbus, DeviceNet, PROFIBUS, EtherCAT, Modbus TCP, CAN
Logic programming	Standard firmware	Standard firmware
Customisation options	Hardware customisation (main switch, liquid cooling, 12-pulse rectifier, ...)	Hardware customisation (main switch, liquid cooling, 12-pulse rectifier, ...)
Page/Quick Link	D243	D243



Customised to your machine

Omron realises that you need quality and reliability, plus the ability to easily and quickly customise your inverter to the application in hand. And with the RX, you have the perfect tool for the job. Naturally it combines the same high level of quality and performance for which Omron is renowned. It also has abundant application functionality on board and you can customise it yourself to match your precise requirements.

- Ratings up to 132 kW
- Full torque at 0 Hz in closed loop
- Sensor-less and vector closed-loop control
- Built-in EMC filter
- Built-in logic programmability
- Built-in application oriented functionality
- Fieldbus communications: Modbus, DeviceNet, PROFIBUS, MECHATROLINK-II, EtherCAT and CompoNet

Ordering information

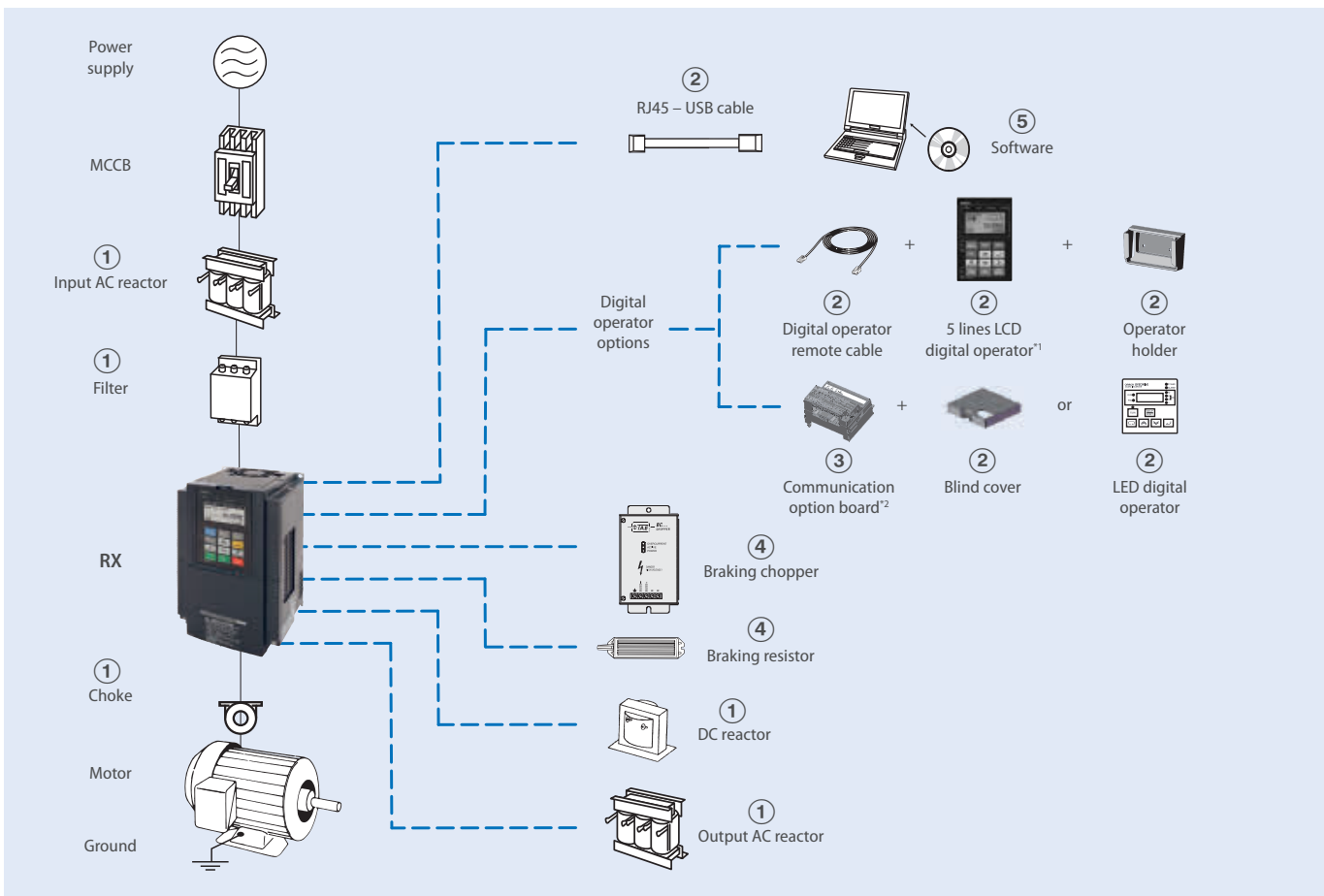

¹The 5 lines LCD digital operator is provided with the inverter from factory.

²When a communication option board is mounted, there are two options: mount a blind cover or a LED digital operator.

3G3RX

Specifications					Order code	Specifications					Order code
Voltage class	Constant torque		Variable torque		Standard	Voltage class	Constant torque		Variable torque		Standard
	Max. motor kW	Rated current A	Max. motor kW	Rated current A			Max. motor kW	Rated current A	Max. motor kW	Rated current A	
Three-phase 200 V	0.4	3.0	0.75	3.7	3G3RX-A2004-E1F	Three-phase 400 V	0.4	1.5	0.75	1.9	3G3RX-A4004-E1F
	0.75	5.0	1.5	6.3	3G3RX-A2007-E1F		0.75	2.5	1.5	3.1	3G3RX-A4007-E1F
	1.5	7.5	2.2	9.4	3G3RX-A2015-E1F		1.5	3.8	2.2	4.8	3G3RX-A4015-E1F
	2.2	10.5	4.0	12	3G3RX-A2022-E1F		2.2	5.3	4.0	6.7	3G3RX-A4022-E1F
	4.0	16.5	5.5	19.6	3G3RX-A2037-E1F		4.0	9.0	5.5	11.1	3G3RX-A4040-E1F
	5.5	24	7.5	30	3G3RX-A2055-E1F		5.5	14	7.5	16	3G3RX-A4055-E1F
	7.5	32	11	44	3G3RX-A2075-E1F		7.5	19	11	22	3G3RX-A4075-E1F
	11	46	15	58	3G3RX-A2110-E1F		11	25	15	29	3G3RX-A4110-E1F
	15	64	18.5	73	3G3RX-A2150-E1F		15	32	18.5	37	3G3RX-A4150-E1F
	18.5	76	22	85	3G3RX-A2185-E1F		18.5	38	22	43	3G3RX-A4185-E1F
	22	95	30	113	3G3RX-A2220-E1F		22	48	30	57	3G3RX-A4220-E1F
	30	121	37	140	3G3RX-A2300-E1F		30	58	37	70	3G3RX-A4300-E1F
	37	145	45	169	3G3RX-A2370-E1F		37	75	45	85	3G3RX-A4370-E1F
	45	182	55	210	3G3RX-A2450-E1F		45	91	55	105	3G3RX-A4450-E1F
55	220	75	270	3G3RX-A2550-E1F	55	112	75	135	3G3RX-A4550-E1F		
-	-	-	-	-	75	149	90	160	3G3RX-B4750-E1F		
-	-	-	-	-	90	176	110	195	3G3RX-B4900-E1F		
-	-	-	-	-	110	217	132	230	3G3RX-B411K-E1F		
-	-	-	-	-	132	260	160	290	3G3RX-B413K-E1F		

① Rasmi line filter

200 V					400 V				
Model 3G3R_X-	Leakage Nom./Max.	Rated current A	Weight (kg)	Order code	Model 3G3RX-	Leakage Nom./Max.	Rated current A	Weight (kg)	Order code
A2004/A2007/A2015/A2022/A2037	0.7/40 mA	18	2.0	AX-FIR2018-RE	A4004/A4007/A4015/A4022/A4040	0.3/40 mA	10	1.9	AX-FIR3010-RE
A2055/A2075/A2110	0.7/40 mA	53	2.5	AX-FIR2053-RE	A4055/A4075/A4110	0.3/40 mA	30	2.2	AX-FIR3030-RE
A2150/A2185/A2220	1.2/70 mA	110	8.0	AX-FIR2110-RE	A4150/A4185/A4220	0.8/70 mA	53	4.5	AX-FIR3053-RE
A2300	1.2/70 mA	145	8.6	AX-FIR2145-RE	A4300	3/160 mA	64	7.0	AX-FIR3064-RE
A2370/A2450	6/300 mA	250	13.0	AX-FIR3250-RE	A4370	2/130 mA	100	8.0	AX-FIR3100-RE
A2550	6/300 mA	320	13.2	AX-FIR3320-RE	A4450/A4550	2/130 mA	130	8.6	AX-FIR3130-RE
-	-	-	-	-	A4750/A4900	10/500 mA	250	13.0	AX-FIR3250-RE
-	-	-	-	-	A411K/A413K	10/500 mA	320	13.2	AX-FIR3320-RE

① Input AC reactors

3-phase 200 VAC			3-phase 400 VAC		
Inverter model 3G3RX-	Order code		Inverter model 3G3RX-	Order code	
A2004/A2007/A2015	AX-RAI02800100-DE		A4004/A4007/A4015	AX-RAI07700050-DE	
A2022/A2037	AX-RAI00880200-DE		A4022/A4040	AX-RAI03500100-DE	
A2055/A2075	AX-RAI00350335-DE		A4055/A4075	AX-RAI01300170-DE	
A2110/A2150	AX-RAI00180670-DE		A4110/A4150	AX-RAI00740335-DE	
A2185/A2220	AX-RAI00091000-DE		A4185/A4220	AX-RAI00360500-DE	
A2300/A2370	AX-RAI00071550-DE		A4300/A4370	AX-RAI00290780-DE	
A2450/A2550	AX-RAI00042300-DE		A4450/A4550	AX-RAI00191150-DE	
			A4750/A4900	AX-RAI00111850-DE	
			A411K/A413K	AX-RAI00072700-DE	

① DC reactors

3-phase 200 VAC			3-phase 400 VAC		
Inverter model 3G3RX-	Order code		Inverter model 3G3RX-	Order code	
A2004	AX-RC10700032-DE		A4004	AX-RC43000020-DE	
A2007	AX-RC06750061-DE		A4007	AX-RC27000030-DE	
A2015	AX-RC03510093-DE		A4015	AX-RC14000047-DE	
A2022	AX-RC02510138-DE		A4022	AX-RC10100069-DE	
A2037	AX-RC01600223-DE		A4040	AX-RC06400116-DE	
A2055	AX-RC01110309-DE		A4055	AX-RC04410167-DE	
A2075	AX-RC00840437-DE		A4075	AX-RC03350219-DE	
A2110	AX-RC00590614-DE		A4110	AX-RC02330307-DE	
A2150	AX-RC00440859-DE		A4150	AX-RC01750430-DE	
A2185/A2220	AX-RC00301275-DE		A4185/A4220	AX-RC01200644-DE	
A2300	AX-RC00231662-DE		A4300	AX-RC00920797-DE	
A2370	AX-RC00192015-DE		A4370	AX-RC00741042-DE	
A2450	AX-RC00162500-DE		A4450	AX-RC00611236-DE	
A2550	AX-RC00133057-DE		A4550	AX-RC00501529-DE	

3-phase 200 VAC		3-phase 400 VAC	
Inverter model 3G3RX-__	Order code	Inverter model 3G3RX-__	Order code
		A4750	AX-RC00372094-DE
		A4900	AX-RC00312446-DE
		A411K	AX-RC00252981-DE
		A413K	AX-RC00213613-DE

① Chokes





Diameter	Description	Order code
21	For 2.2 kW motors or below	AX-FER2102-RE
25	For 15 kW motors or below	AX-FER2515-RE
50	For 45 kW motors or below	AX-FER5045-RE
60	For 55 kW motors or above	AX-FER6055-RE

① Output AC Reactor

200 V		400 V	
Model 3G3RX-__	Order code	Model 3G3RX-__	Order code
A2004	AX-RAO11500026-DE	A4004/A4007/A4015	AX-RAO16300038-DE
A2007	AX-RAO07600042-DE		
A2015	AX-RAO04100075-DE		
A2022	AX-RAO03000105-DE	A4022	AX-RAO11800053-DE
A2037	AX-RAO01830160-DE	A4040	AX-RAO07300080-DE
A2055	AX-RAO01150220-DE	A4055	AX-RAO04600110-DE
A2075	AX-RAO00950320-DE	A4075	AX-RAO03600160-DE
A2110	AX-RAO00630430-DE	A4110	AX-RAO02500220-DE
A2150	AX-RAO00490640-DE	A4150	AX-RAO02000320-DE
A2185	AX-RAO00390800-DE	A4185	AX-RAO01650400-DE
A2220	AX-RAO00330950-DE	A4220	AX-RAO01300480-DE
A2300	AX-RAO00251210-DE	A4300	AX-RAO01030580-DE
A2370	AX-RAO00191450-DE	A4370	AX-RAO00800750-DE
A2450	AX-RAO00161820-DE	A4450	AX-RAO00680900-DE
A2550	AX-RAO00132200-DE	A4550	AX-RAO00531100-DE
		A4750	AX-RAO00401490-DE
		A4900	AX-RAO00331760-DE
		A411K	AX-RAO00262170-DE
		A413K	AX-RAO00212600-DE

Note: This table corresponds with HD rating. When ND is used, please choose the reactor for the next size inverter.

② Accessories

Types	Appearance	Description	Order code
Remote digital operator		5 line LCD digital operator with copy function*1	3G3AX-OP05
		Operator holder (for inside cabinet mounting)	3G3AX-OP05-H-E
		LED remote digital operator	3G3AX-OP01
		Mounting kit	4X-KITmini
LED digital operator		To be used in combination with communication option boards	3G3AX-OP03
Blind cover			3G3AX-OP05-B-E
Cables		3 m remote digital operator cable	3G3AX-CAJOP300-EE
		RJ45 to USB connection cable	USB-CONVERTERCABLE 3G3AX-PCACN2

*1 This digital operator is provided with the RX inverter from factory.

③ Option boards

Types	Description	Functions	Order code
Encoder feedback	PG speed controller option card	Phase A,B and Z pulse (differential pulse) inputs (RS-422) Pulse train position command input (RS-422) Pulse monitor output (RS-422) PG frequency range: 100 kHz max	3G3AX-PG
Communication option board	DeviceNet option card	Used for running or stopping the inverter, setting or referencing parameters, and monitoring output frequency, output current ... through communications with the host controller	3G3AX-RX-DRT
	Profibus option card		3G3AX-RX-PRT
	Ethercat option card		3G3AX-RX-ECT
	CompoNet option card		3G3AX-RX-CRT
	Mechatrolink-II option card		3G3AX-RX-MRT
I/O option	Extra input/output option card	8 digital inputs, 8 digital outputs, 4 analog inputs, 1 analog output	3G3AX-EIO21-ROE

④ Braking unit, braking resistor unit

Inverter					Braking resistor unit							
Voltage	Max. motor kW	Inverter 3G3RX_ 3-phase	Braking unit AX-BCR_	Connectable min. resistance Ω	Inverter mounted type (3% ED, 10 sec max.)		Braking torque %	External resistor 10% ED 10 sec max. for built-in 5 sec max. for braking unit		Braking torque %		
					Order code	Resist Ω		Order code	Resist Ω			
200 V (single-/ three-phase)	0.55	2004	Built-in	50	AX-REM00K1200-IE	200	180	AX-REM00K1200-IE	200	180		
	1.1	2007			AX-REM00K2070-IE		100	AX-REM00K2070-IE	70	200		
	1.5	2015			AX-REM00K2070-IE	35	70	140	AX-REM00K4075-IE	75	130	
	2.2	2022					90	AX-REM00K4035-IE	35	180		
	4.0	2037					50	AX-REM00K6035-IE	35	100		
	5.5	2055			AX-REM00K4035-IE	16	35	75	AX-REM00K9020-IE	20	150	
	7.5	2075					55	AX-REM01K9017-IE	17	110		
	11.0	2110			AX-REM00K6035-IE	10	35	40	AX-REM02K1017-IE	17	75	
	15.0	2150					7.5	55	AX-REM03K5010-IE	10	95	
	18.5	2185			AX-REM03K5010-IE	7.5	17	55	AX-REM03K5010-IE	10	95	
	22.0	2220					10	75	AX-REM19K0008-IE	8	95	
	30.0	2300			2035090-TE	4	-			AX-REM19K0006-IE	6	80
	37.0	2370					6	60				
	45.0	2450			2070130-TE	2.8	-			2 x AX-REM19K0006-IE	3	105
	55.0	2550	3	85								
400 V (three-phase)	0.55	4004	Built-in	100	AX-REM00K1400-IE	400	200	AX-REM00K1400-IE	400	200		
	1.1	4007				200	200		200			
	1.5	4015			AX-REM00K1200-IE	70	200	190	AX-REM00K2200-IE	200	190	
	2.2	4022					200	130	AX-REM00K5120-IE	120	200	
	4.0	4040					120	120	AX-REM00K6100-IE	100	140	
	5.5	4055			AX-REM00K4075-IE	35	75	140	AX-REM00K9070-IE	70	150	
	7.5	4075					100	100	AX-REM01K9070-IE	70	110	
	11.0	4110			AX-REM00K6100-IE	24	100	50	AX-REM02K1070-IE	70	75	
	15.0	4150					70	55	AX-REM03K5035-IE	35	110	
	18.5	4185			AX-REM03K5035-IE	20	35	90	AX-REM19K0030-IE	30	100	
	22.0	4220					75			85		
	30.0	4300			4015045-TE	16	-			AX-REM19K0020-IE	20	95
	37.0	4370			4017068-TE	11	-			AX-REM38K0012-IE	15	125
	45.0	4450					100					
	55.0	4550	4035090-TE	8.5	-			2 x AX-REM19K0020-IE	10	100		
	75.0	4750			3 x AX-REM19K0030-IE	10	75					
	90.0	4900	4070130-TE	5.5	-			2 x AX-REM38K0012-IE	6	105		
	110.0	411K	4090240-TE	3.2	-			3 x AX-REM38K0012-IE	4	125		
132.0	413K	105										

⑤ Computer software

Description	Installation	Order code
Computer software	Configuration and monitoring software tool	CX-Drive
Computer software	Configuration and monitoring software tool	CX-One
Computer software	Software tool for energy saving calculation	€Saver

Specifications

200 V class

Three-phase: 3G3RX-__		A2004	A2007	A2015	A2022	A2037	A2055	A2075	A2110	A2150	A2185	A2220	A2300	A2370	A2450	A2550			
Max. applicable motor 4P kW*1		at CT	0.4	0.75	1.5	2.2	3.7	5.5	7.5	11	15	18.5	22	30	37	45	55		
		at VT	0.75	1.5	2.2	3.7	5.5	7.5	11	15	18.5	22	30	37	45	55	75		
Output characteristics	Inverter capacity kVA	200 V	at CT	1.0	1.7	2.5	3.6	5.7	8.3	11.0	15.9	22.1	26.3	32.9	41.9	50.2	63.0	76.2	
			at VT	1.3	2.1	3.2	4.1	6.7	10.4	15.2	20.0	26.3	29.4	39.1	49.5	59.2	72.7	93.5	
		240 V	at CT	1.2	2.0	3.1	4.3	6.8	9.9	13.3	19.1	26.6	31.5	39.4	50.2	60.2	75.6	91.4	
			at VT	1.5	2.6	3.9	5.0	8.1	12.4	18.2	24.1	31.5	35.3	46.9	59.4	71.0	87.2	112.2	
	Rated output current (A)		at CT	3.0	5.0	7.5	10.5	16.5	24	32	46	64	76	95	121	145	182	220	
	at VT		3.7	6.3	9.4	12	19.6	30	44	58	73	85	113	140	169	210	270		
Max. output voltage		Proportional to input voltage: 0 to 240 V																	
Max. output frequency		400 Hz																	
Power supply	Rated input voltage and frequency		3-phase 200 to 240 V 50/60 Hz																
	Allowable voltage fluctuation		-15% to 10%																
	Allowable frequency fluctuation		5%																
Braking	Regenerative braking		Internal BRD circuit (external discharge resistor)												External regenerative braking unit				
	Minimum connectable resistance		50	50	35	35	35	16	10	10	7.5	7.5	5						
Protective structure		IP20																	
Cooling method		Forced air cooling																	

*1 Based on a standard 3-phase standard motor.

400 V class

Three-phase: 3G3RX-__		A4004	A4007	A4015	A4022	A4040	A4055	A4075	A4110	A4150	A4185	A4220	A4300	A4370	A4450	A4550	B4750	B4900	B411K	B413K		
Max. applicable motor 4P kW*1		at CT	0.4	0.75	1.5	2.2	4.0	5.5	7.5	11	15	18.5	22	30	37	45	55	75	90	110	132	
		at VT	0.75	1.5	2.2	4.0	5.5	7.5	11	15	18.5	22	30	37	45	55	75	90	110	132	160	
Output characteristics	Inverter capacity kVA	400 V	at CT	1.0	1.7	2.5	3.6	6.2	9.7	13.1	17.3	22.1	26.3	33.2	40.1	51.9	63.0	77.6	103.2	121.9	150.3	180.1
			at VT	1.3	2.1	3.3	4.6	7.7	11.0	15.2	20.9	25.6	30.4	39.4	48.4	58.8	72.7	93.5	110.8	135	159.3	200.9
		480 V	at CT	1.2	2.0	3.1	4.3	7.4	11.6	15.8	20.7	26.6	31.5	39.9	48.2	62.3	75.6	93.1	123.8	146.3	180.4	216.1
			at VT	1.5	2.5	4.0	5.5	9.2	13.3	18.2	24.1	30.7	36.5	47.3	58.1	70.6	87.2	112.2	133	162.1	191.2	241.1
	Rated output current (A)		at CT	1.5	2.5	3.8	5.3	9.0	14	19	25	32	38	48	58	75	91	112	149	176	217	260
	at VT		1.9	3.1	4.8	6.7	11.1	16	22	29	37	43	57	70	85	105	135	160	195	230	290	
Max. output voltage		Proportional to input voltage: 0 to 480 V																				
Max. output frequency		400 Hz																				
Power supply	Rated input voltage and frequency		3-phase 380 to 480 V 50/60 Hz																			
	Allowable voltage fluctuation		-15% to 10%																			
	Allowable frequency fluctuation		5%																			
Braking	Regenerative braking		Internal BRD circuit (external discharge resistor)												External regenerative braking unit							
	Minimum connectable resistance		100	100	100	100	70	70	35	35	24	24	20									
Protective structure		IP20															IP00					
Cooling method		Forced air cooling																				

*1 Based on a standard 3-phase standard motor.

Dimensions

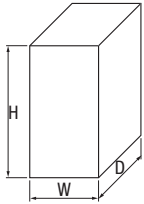
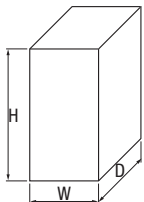
Voltage class	Inverter model	Dimensions in mm			Weight (kg)	
		H	W	D		
Three-phase 200 V	3G3RX-A2004	255	150	140	3.5	
	3G3RX-A2007					
	3G3RX-A2015					
	3G3RX-A2022					
	3G3RX-A2037					
	3G3RX-A2055	260	210	170	6	
	3G3RX-A2075					
	3G3RX-A2110					
	3G3RX-A2150	390	250	190	14	
	3G3RX-A2185					
	3G3RX-A2220					
	3G3RX-A2300	540	310	195	20	
	3G3RX-A2370	550	390	250	30	
	3G3RX-A2450					
3G3RX-A2550	700	480	250	43		
Three-phase 400 V	3G3RX-A4004	255	150	140	3.5	
	3G3RX-A4007					
	3G3RX-A4015					
	3G3RX-A4022					
	3G3RX-A4040					
	3G3RX-A4055	260	210	170	6	
	3G3RX-A4075					
	3G3RX-A4110					
	3G3RX-A4150	390	250	190	14	
	3G3RX-A4185					
	3G3RX-A4220					
	3G3RX-A4300	540	310	195	22	
	3G3RX-A4370	550	390	250	30	
	3G3RX-A4450					
	3G3RX-A4550					
	3G3RX-B4750	700	390	270	60	
	3G3RX-B4900					
	3G3RX-B411K	740	480	270	80	
3G3RX-B413K						



Born to drive machines

MX2 has been developed to harmonise advanced motor and machine control. Thanks to its advanced design algorithms the MX2 provides smooth control down to zero speed, plus precise operation for fast cyclic operations and torque control capability in open loop. The MX2 also gives you comprehensive functionality for machine control such as positioning, speed synchronisation and logic programming.

- Current vector control
- Double rating VT 120%/1 min and CT 150%/1 min
- IM & PM motor control
- Torque control in open loop vector
- Positioning functionality
- Built-in application functionality (i.e. Brake control)
- Fieldbus comms: Modbus, DeviceNet, Profibus, MECHATROLINK-II, EtherCAT, CompoNet and EtherNet/IP

Ordering information

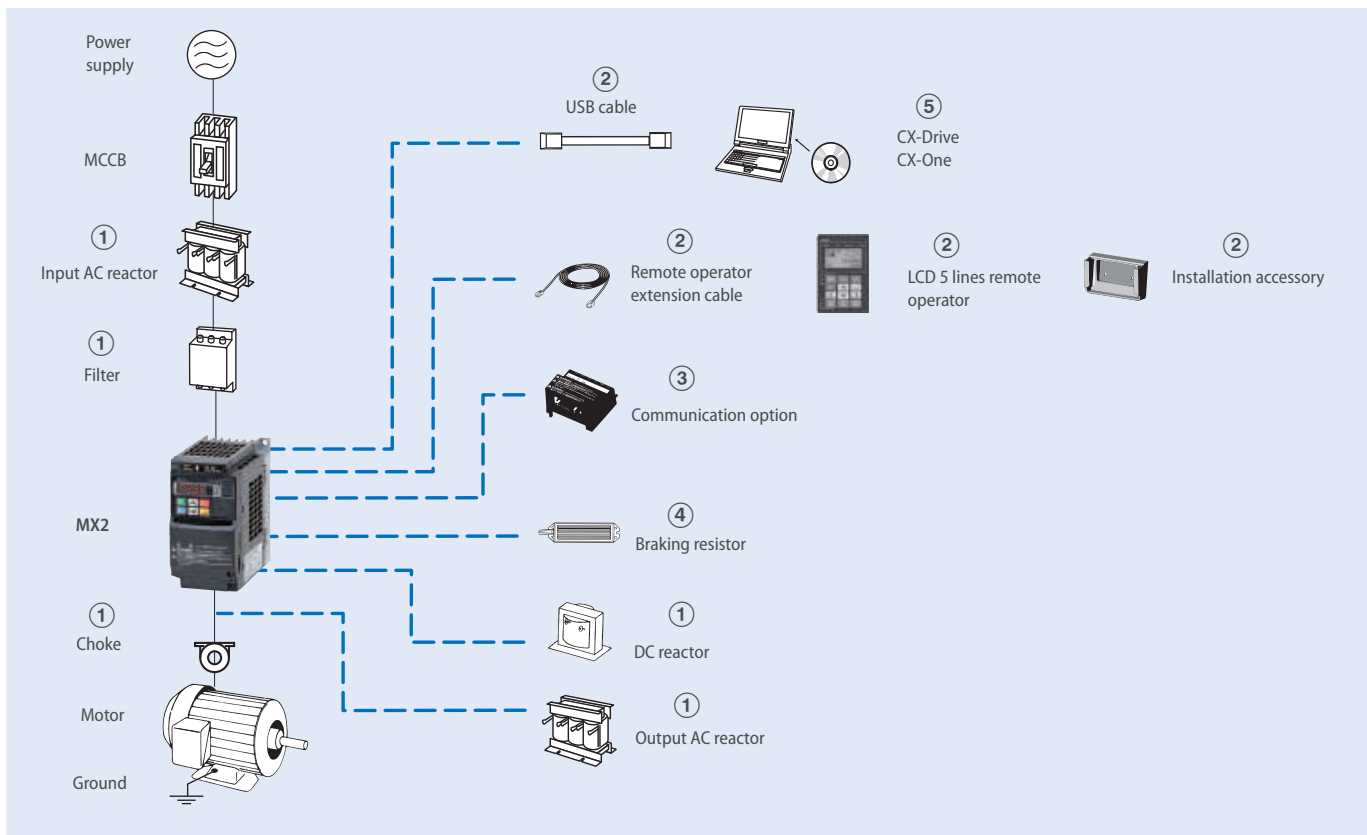

3G3MX2

Specifications					Order code		
Voltage class	Constant torque		Variable torque		Standard (IP20)	Finless	IP54
	Max motor kW	Rated current A	Max motor kW	Rated current A			
Single-phase 200 V	0.1	1.0	0.2	1.2	3G3MX2-AB001-E	3G3MX2-AB001-P-E	3G3MX2-DB001-E/EC
	0.2	1.6	0.4	1.9	3G3MX2-AB002-E	3G3MX2-AB002-P-E	3G3MX2-DB002-E/EC
	0.4	3.0	0.55	3.5	3G3MX2-AB004-E	3G3MX2-AB004-P-E	3G3MX2-DB004-E/EC
	0.75	5.0	1.1	6.0	3G3MX2-AB007-E	3G3MX2-AB007-P-E	3G3MX2-DB007-E/EC
	1.5	8.0	2.2	9.6	3G3MX2-AB015-E	3G3MX2-AB015-P-E	3G3MX2-DB015-E/EC
	2.2	11.0	3.0	12.0	3G3MX2-AB022-E	3G3MX2-AB022-P-E	3G3MX2-DB022-E/EC
Three-phase 200 V	0.1	1.0	0.2	1.2	3G3MX2-A2001-E	3G3MX2-A2001-P-E	3G3MX2-D2001-E/EC
	0.2	1.6	0.4	1.9	3G3MX2-A2002-E	3G3MX2-A2002-P-E	3G3MX2-D2002-E/EC
	0.4	3.0	0.55	3.5	3G3MX2-A2004-E	3G3MX2-A2004-P-E	3G3MX2-D2004-E/EC
	0.75	5.0	1.1	6.0	3G3MX2-A2007-E	3G3MX2-A2007-P-E	3G3MX2-D2007-E/EC
	1.5	8.0	2.2	9.6	3G3MX2-A2015-E	3G3MX2-A2015-P-E	3G3MX2-D2015-E/EC
	2.2	11.0	3.0	12.0	3G3MX2-A2022-E	3G3MX2-A2022-P-E	3G3MX2-D2022-E/EC
	3.7	17.5	5.5	19.6	3G3MX2-A2037-E	3G3MX2-A2037-P-E	3G3MX2-D2037-E/EC
	5.5	25.0	7.5	30.0	3G3MX2-A2055-E	-	3G3MX2-D2055-E/EC
	7.5	33.0	11	40.0	3G3MX2-A2075-E	-	3G3MX2-D2075-E/EC
11	47.0	15	56.0	3G3MX2-A2110-E	-	3G3MX2-D2110-E/EC	
15	60.0	18.5	69.0	3G3MX2-A2150-E	-	3G3MX2-D2150-E/EC	

Specifications					Order code		
Voltage class	Constant torque		Variable torque		Standard (IP20)	Finless	IP54
	Max motor kW	Rated current A	Max motor kW	Rated current A			
Three-phase 400 V	0.4	1.8	0.75	2.1	3G3MX2-A4004-E	3G3MX2-A4004-P-E	3G3MX2-D4004-EC
	0.75	3.4	1.5	4.1	3G3MX2-A4007-E	3G3MX2-A4007-P-E	3G3MX2-D4007-EC
	1.5	4.8	2.2	5.4	3G3MX2-A4015-E	3G3MX2-A4015-P-E	3G3MX2-D4015-EC
	2.2	5.5	3.0	6.9	3G3MX2-A4022-E	3G3MX2-A4022-P-E	3G3MX2-D4022-EC
	3.0	7.2	4.0	8.8	3G3MX2-A4030-E	3G3MX2-A4030-P-E	3G3MX2-D4030-EC
	4.0	9.2	5.5	11.1	3G3MX2-A4040-E	3G3MX2-A4040-P-E	3G3MX2-D4040-EC
	5.5	14.8	7.5	17.5	3G3MX2-A4055-E	-	3G3MX2-D4055-EC
	7.5	18.0	11	23.0	3G3MX2-A4075-E	-	3G3MX2-D4075-EC
	11	24.0	15	31.0	3G3MX2-A4110-E	-	3G3MX2-D4110-EC
	15	31.0	18.5	38.0	3G3MX2-A4150-E	-	3G3MX2-D4150-EC

① Line filters

Inverter		Standard line filter				Low leakage line filter			
Voltage	Model 3G3MX2-__	Rasmi		Schaffner		Rasmi		Schaffner	
		Order code AX-FIM	Current (A)	Order code AX-FIM	Current (A)	Order code AX-FIM	Current (A)	Order code AX-FIM	Current (A)
1Phase 200 VAC	AB001 / AB002 / AB004	1010-RE	10	1010-SE-V1	8	1010-RE-LL	10	1010-SE-LL	10
	AB007	1014-RE	14	1014-SE-V1	14	1014-RE-LL	14	1014-SE-LL	14
	AB015 / AB022	1024-RE	24	1024-SE-V1	27	1024-RE-LL	24	1024-SE-LL	24
3Phase 200 VAC	A2001 / A2002 / A2004 / A2007	2010-RE	10	2010-SE-V1	7.8	2010-RE-LL	10	-	-
	A2015 / A2022	2020-RE	20	2020-SE-V1	16	2020-RE-LL	20	2020-SE-LL	20
	A2037	2030-RE	30	2030-SE-V1	25	2030-RE-LL	30	2030-SE-LL	30
	A2055 / A2075	2060-RE	60	2060-SE-V1	50	2060-RE-LL	60	2060-SE-LL	50
	A2110	2080-RE	80	2080-SE-V1	70	2080-RE-LL	80	-	-
3Phase 400 VAC	A2150	2100-RE	100	2100-SE-V1	75	2100-RE-LL	100	-	-
	A4004 / A4007	3005-RE	5	3005-SE-V1	6	3005-RE-LL	5	3005-SE-LL	5
	A4015 / A4022 / A4030	3010-RE	10	3010-SE-V1	12	3010-RE-LL	10	3010-SE-LL	10
	A4040	3014-RE	14	3014-SE-V1	15	3014-RE-LL	14	3014-SE-LL	15
	A4055 / A4075	3030-RE	30	3030-SE-V1	29	3030-RE-LL	30	3030-SE-LL	30
	A4110 / A4150	3050-RE	50	3050-SE-V1	48	3050-RE-LL	50	3050-SE-LL	50

① Input AC reactors

Inverter	AC Reactor	
Voltage	Model 3G3MX2-__	Order code
1-Phase 200 VAC	AB002/AB004	AX-RAI02000070-DE
	AB007	AX-RAI01700140-DE
	AB015	AX-RAI01200200-DE
	AB022	AX-RAI00630240-DE
3-Phase 200 VAC	A2002/A2004/A2007	AX-RAI02800080-DE
	A2015/A2022/A2037	AX-RAI00880200-DE
	A2055/A2075	AX-RAI00350335-DE
	A2110/A2150	AX-RAI00180670-DE

Inverter	AC Reactor	
Voltage	Model 3G3MX2-__	Order code
3-Phase 400 VAC	A4004/A4007/A4015	AX-RAI07700050-DE
	A4022/A4030/A4040	AX-RAI03500100-DE
	A4055/A4075	AX-RAI01300170-DE
	A4110/A4150	AX-RAI00740335-DE

① DC reactors

200 V single-phase		200 V three-phase		400 V three-phase	
Inverter	Order code	Inverter	Order code	Inverter	Order code
3G3MX2-AB001	AX-RC10700032-DE	3G3MX2-A2001	AX-RC21400016-DE	3G3MX2-A4004	AX-RC43000020-DE
3G3MX2-AB002		3G3MX2-A2002		3G3MX2-A4007	AX-RC27000030-DE
3G3MX2-AB004	AX-RC06750061-DE	3G3MX2-A2004	AX-RC10700032-DE	3G3MX2-A4015	AX-RC14000047-DE
3G3MX2-AB007	AX-RC03510093-DE	3G3MX2-A2007	AX-RC06750061-DE	3G3MX2-A4022	AX-RC10100069-DE
3G3MX2-AB015	AX-RC02510138-DE	3G3MX2-A2015	AX-RC03510093-DE	3G3MX2-A4030	AX-RC08250093-DE
3G3MX2-AB022	AX-RC01600223-DE	3G3MX2-A2022	AX-RC02510138-DE	3G3MX2-A4040	AX-RC06400116-DE
-		3G3MX2-A2037	AX-RC01600223-DE	3G3MX2-A4055	AX-RC04410167-DE
		3G3MX2-A2055	AX-RC01110309-DE	3G3MX2-A4075	AX-RC03350219-DE
		3G3MX2-A2075	AX-RC00840437-DE	3G3MX2-A4011	AX-RC02330307-DE
		3G3MX2-A2011	AX-RC00590614-DE	3G3MX2-A4015	AX-RC01750430-DE
		3G3MX2-A2015	AX-RC00440859-DE	-	-

① Chokes

Diameter	Description	Order code
21	For 2.2 KW motors or below	AX-FER2102-RE
25	For 15 KW motors or below	AX-FER2515-RE
50	For 45 KW motors or below	AX-FER5045-RE

① Output AC reactor

Inverter		AC Reactor
Voltage	Model 3G3MX2_	Order code
200 VAC	AB001/AB002/AB004/A2001/A2002/A2004	AX-RAO11500026-DE
	AB007/A2007	AX-RAO07600042-DE
	AB015/A2015	AX-RAO04100075-DE
	AB022/A2022	AX-RAO03000105-DE
	A2037	AX-RAO01830160-DE
	A2055	AX-RAO01150220-DE
	A2075	AX-RAO00950320-DE
	A2110	AX-RAO00630430-DE
	A2150	AX-RAO00490640-DE

Inverter		AC Reactor
Voltage	Model 3G3MX2_	Order code
400 VAC	A4004/A4007/A4015	AX-RAO16300038-DE
	A4022	AX-RAO11800053-DE
	A4030/A4040	AX-RAO07300080-DE
	A4055	AX-RAO04600110-DE
	A4075	AX-RAO03600160-DE
	A4110	AX-RAO02500220-DE
A4150	AX-RAO02000320-DE	

② Accessories

Types	Description	Functions	Order code
Digital operator	LCD remote operator	5 Line LCD remote operator with copy function, cable length max. 3m.	AX-OP05-E
	Remote operator cable	3 meters cable for connecting remote operator	3G3AX-CAJOP300-EE
	LED remote operator	LED remote operator, cable length max. 3m	3G3AX-OP01
	Mounting kit for LED operator	Mounting kit for LED operator on panel	4X-KITMINI
	Operator holder	Holder to put the AX-OP05-E inside of the cabinet	3G3AX-OP05-H-E
Accessories	PC configuration cable	Mini USB to USB connector cable	AX-CUSBM002-E

③ Communication option boards

Description	Functions	Order code
Profibus option card	Used for running or stopping the inverter, setting or referencing parameters, and monitoring output frequency, output current, or similar items through communications with the host controller.	3G3AX-MX2-PRT
DeviceNet option card		3G3AX-MX2-DRT
EtherCAT option card		3G3AX-MX2-ECT
CompoNet option card		3G3AX-MX2-CRT
MECHATROLINK-II option card		3G3AX-MX2-MRT
EtherNet/IP option card		3G3AX-MX2-EIP
Extra input/output option board	1 analog voltage input, 1 analog current input, 1 analog voltage output, 8 discrete logic inputs, 4 discrete logic outputs	3G3AX-MX2-EIO15-E

④ Braking unit, braking resistor unit

Inverter Voltage	Max. motor kW	Inverter 3G3MX2_		Connectable min. resistance Ω	Braking resistor unit		Braking torque %	Inverter mounted type (10%ED, 10 sec max)	Braking torque %	
		1-phase	3-phase		Inverter mounted type (3%ED, 10 sec max)					
					Order code	Resist Ω				Order code
200 V (Single-/Three-phase)	0.12	B001	2001	100	AX-REM00K1400-IE	400	200	AX-REM00K1400-IE	400	200
	0.25	B002	2002		180					180
	0.55	B004	2004			AX-REM00K1200-IE	200	180	AX-REM00K1200-IE	200
	1.1	B007	2007	50			100	AX-REM00K2070-IE	70	200
	1.5	B015	2015		AX-REM00K2070-IE	70	140	AX-REM00K4075-IE	75	130
	2.2	B022	2022	35			90	AX-REM00K4035-IE	35	180
	4.0	--	2040		AX-REM00K4075-IE	75	50	AX-REM00K6035-IE	35	100
	5.5	--	2055	20	AX-REM00K4035-IE	35	75	AX-REM00K9020-IE	20	150
	7.5	--	2075				55	AX-REM01K9017-IE	17	110
	11	--	2110	10	AX-REM00K6035-IE	35	40	AX-REM02K1017-IE	17	75
15	--	2150	AX-REM00K9017-IE		17	55	AX-REM03K5010-IE	10	95	
400 V (Three-phase)	0.55	--	4004	180	AX-REM00K1400-IE	400	200	AX-REM00K1400-IE	400	200
	1.1	--	4007		200					200
	1.5	--	4015		AX-REM00K1200-IE	200	190	AX-REM00K2200-IE	200	190
	2.2	--	4022	100	AX-REM00K2200-IE	200	130	AX-REM00K5120-IE	120	200
	3.0	--	4030		AX-REM00K2120-IE	120	160			160
	4.0	--	4040				120	AX-REM00K6100-IE	100	140
	5.5	--	4055	70	AX-REM00K4075-IE	75	140	AX-REM00K9070-IE	70	150
	7.5	--	4075				100	AX-REM01K9070-IE	70	110
	11	--	4110		AX-REM00K6100-IE	100	50	AX-REM02K1070-IE	70	75
	15	--	4150	35	AX-REM00K9070-IE	70	55	AX-REM03K5035-IE	35	110

⑤ Computer software

Description	Installation	Order code
Computer software	Configuration and monitoring software tool	CX-Drive
Computer software	Configuration and monitoring software tool	CX-One
Computer software	Software tool for Energy Saving calculation	€Saver

Specifications

200 V class

Single-phase: 3G3MX2-__		B001	B002	B004	B007*1	B015	B022	-	-	-	-	-	
Three-phase: 3G3MX2-__		2001	2002	2004	2007	2015	2022	2037	2055	2075	2110	2150	
Motor kW*2	For VT setting	0.2	0.4	0.55	1.1	2.2	3.0	5.5	7.5	11	15	18.5	
	For CT setting	0.1	0.2	0.4	0.75	1.5	2.2	3.7	5.5	7.5	11	15	
Output characteristics	Inverter capacity kVA	200 VT	0.4	0.6	1.2	2.0	3.3	4.1	6.7	10.3	13.8	19.3	23.9
		200 CT	0.2	0.5	1.0	1.7	2.7	3.8	6.0	8.6	11.4	16.2	20.7
		240 VT	0.4	0.7	1.4	2.4	3.9	4.9	8.1	12.4	16.6	23.2	28.6
		240 CT	0.3	0.6	1.2	2.0	3.3	4.5	7.2	10.3	13.7	19.5	24.9
	Rated output current (A) at VT		1.2	1.9	3.5	6.0	9.6	12.0	19.6	30.0	40.0	56.0	69.0
	Rated output current (A) at CT		1.0	1.6	3.0	5.0	8.0	11.0	17.5	25.0	33.0	47.0	60.0
Max. output voltage		Proportional to input voltage: 0 ... 240 V											
Max. output frequency		400 Hz											
Power supply	Rated input voltage and frequency		Single-phase 200... 240 V 50/60 Hz 3-phase 200... 240 V 50/60 Hz										
	Allowable voltage fluctuation		-15% ... +10%										
	Allowable frequency fluctuation		5%										
Braking torque	At short-time deceleration		100%: <50Hz			70%: <50Hz		Approx 20%		-			
	At capacitor feedback		50%: <60Hz			50%: <60Hz							
Cooling method		Self cooling*3				Forced-air-cooling							

*1 Three phase model use forced-air-cooling but single phase model is self cooling.

*2 Based on a standard 3-Phase standard motor.

*3 Forced air cooling for IP54 models

400 V class

Three-phase: 3G3MX2-__		4004	4007	4015	4022	4030	4040	4055	4075	4110	4150	
Motor kW*1	For VT setting	0.75	1.5	2.2	3.0	4.0	5.5	7.5	11	15	18.5	
	For CT setting	0.4	0.75	1.5	2.2	3.0	4.0	5.5	7.5	11	15	
Output characteristics	Inverter capacity kVA	380 VT	1.3	2.6	3.5	4.5	5.7	7.3	11.5	15.1	20.4	25.0
		380 CT	1.1	2.2	3.1	3.6	4.7	6.0	9.7	11.8	15.7	20.4
		480 VT	1.7	3.4	4.4	5.7	7.3	9.2	14.5	19.1	25.7	31.5
		480 CT	1.4	2.8	3.9	4.5	5.9	7.6	12.3	14.9	19.9	25.7
	Rated output current (A) at VT		2.1	4.1	5.4	6.9	8.8	11.1	17.5	23.0	31.0	38.0
	Rated output current (A) at CT		1.8	3.4	4.8	5.5	7.2	9.2	14.8	18.0	24.0	31.0
Max. output voltage		Proportional to input voltage: 0 ... 480 V										
Max. output frequency		400 Hz										
Power supply	Rated input voltage and frequency		3-phase 380 ... 480 V 50/60 Hz									
	Allowable voltage fluctuation		-15% ... +10%									
	Allowable frequency fluctuation		5%									
Braking torque	At short-time deceleration*2		100%: <50Hz			70%: <50Hz		-				
	At capacitor feedback		50%: <60Hz			50%: <60Hz						
Cooling method		Self cooling*2			Forced-air-cooling							

*1 Based on a standard 3-Phase standard motor.

*2 Forced air cooling for IP54 models

Dimensions

Standard models (IP20)

Voltage class	Inverter model	Dimensions in mm			Weight (kg)
		H	W	D	
Single-phase 200 V	3G3MX2-AB001-E	128	68	109	1.0
	3G3MX2-AB002-E				1.0
	3G3MX2-AB004-E			122.5	1.1
	3G3MX2-AB007-E	128	108	170.5	1.4
	3G3MX2-AB015-E				1.8
	3G3MX2-AB022-E				1.8
Three-phase 200 V	3G3MX2-A2001-E	128	68	109	1.0
	3G3MX2-A2002-E				1.0
	3G3MX2-A2004-E			122.5	1.1
	3G3MX2-A2007-E	128	108	145.5	1.2
	3G3MX2-A2015-E				1.6
	3G3MX2-A2022-E				1.8
	3G3MX2-A2037-E	128	140	170.5	2.0
	3G3MX2-A2055-E	260	140	155	3.0
	3G3MX2-A2075-E				3.4
	3G3MX2-A2110-E	296	180	175	5.1
	3G3MX2-A2150-E	350	220	175	7.4
	Three-phase 400 V	3G3MX2-A4004-E	128	108	143.5
3G3MX2-A4007-E					1.6
3G3MX2-A4015-E					1.8
3G3MX2-A4022-E					1.9
3G3MX2-A4030-E					1.9
3G3MX2-A4040-E		128	140	170.5	2.1
3G3MX2-A4055-E		260		155	3.5
3G3MX2-A4075-E					3.5
3G3MX2-A4110-E		296	180	175	4.7
3G3MX2-A4150-E					5.2

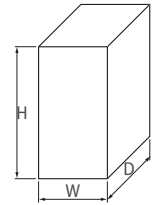

Finless models

Voltage class	Inverter model	Dimensions in mm			Weight (kg)
		H	W	D	
Single-phase 200 V	3G3MX2-AB001-P-E	128	68	103	1.1
	3G3MX2-AB002-P-E				
	3G3MX2-AB004-P-E				
	3G3MX2-AB007-P-E	128	108	123	1.8
	3G3MX2-AB015-P-E				
	3G3MX2-AB022-P-E				
Three-phase 200 V	3G3MX2-A2001-P-E	128	68	103	1.1
	3G3MX2-A2002-P-E				
	3G3MX2-A2004-P-E				
	3G3MX2-A2007-P-E	128	108	123	1.8
	3G3MX2-A2015-P-E				
	3G3MX2-A2022-P-E				
3G3MX2-A2037-P-E	128	140	123	2.1	
Three-phase 400 V	3G3MX2-A4004-P-E	128	108	123	1.8
	3G3MX2-A4007-P-E				
	3G3MX2-A4015-P-E				
	3G3MX2-A4022-P-E				
	3G3MX2-A4030-P-E				
	3G3MX2-A4040-P-E	128	140	123	2.1

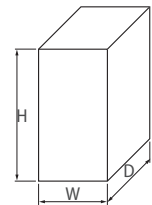

IP54 models

Voltage class	Inverter model	Dimensions in mm			Weight (kg)
		H	W	D	
Single-phase 200 V	3G3MX2-DB001-E	464.74	179.5	292.7	8.0
	3G3MX2-DB001-EC	482.8	309.5	317.7	11.8
	3G3MX2-DB002-E	464.74	179.5	292.7	8.0
	3G3MX2-DB002-EC	482.8	309.5	317.7	11.8
	3G3MX2-DB004-E	464.74	179.5	292.7	8.4
	3G3MX2-DB004-EC	482.8	309.5	317.7	12.1
	3G3MX2-DB007-EC				12.4
	3G3MX2-DB015-EC				16.0
	3G3MX2-DB022-EC				16.0
Three-phase 200 V	3G3MX2-D2001-E	464.74	179.5	292.7	8.0
	3G3MX2-D2001-EC	482.8	309.5	317.7	11.8
	3G3MX2-D2002-E	464.74	179.5	292.7	8.0
	3G3MX2-D2002-EC	482.8	309.5	317.7	11.8
	3G3MX2-D2004-E	464.74	179.5	292.7	8.1
	3G3MX2-D2004-EC	482.8	309.5	317.7	11.9
	3G3MX2-D2007-E	464.74	179.5	292.7	8.2
	3G3MX2-D2007-EC	482.8	309.5	317.7	12.0
	3G3MX2-D2015-EC				15.4
	3G3MX2-D2022-EC				15.6
	3G3MX2-D2037-EC				16.2
	3G3MX2-D2055-EC	627.04	325	299.5	18.8
	3G3MX2-D2075-EC				19.2
	3G3MX2-D2110-EC	710.35	379	329.7	25.3
	3G3MX2-D2150-EC				28.0
Three-phase 400 V	3G3MX2-D4004-EC	482.8	309.5	317.7	12.0
	3G3MX2-D4007-EC				12.5
	3G3MX2-D4015-EC				12.4
	3G3MX2-D4022-EC				12.5
	3G3MX2-D4030-EC				12.5
	3G3MX2-D4040-EC				13.1
	3G3MX2-D4055-EC	627.04	325	299.5	18.7
	3G3MX2-D4075-EC				18.7
	3G3MX2-D4110-EC	710.35	379	329.7	23.8
	3G3MX2-D4150-EC				24.3

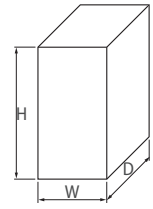



Compact and complete

With the RFI filter built-in, and the communications integrated as standard, the JX provides a compact and complete solution to a whole range of simple applications, such as conveyor control. The RS485 Modbus is built into the RJ45 port of the inverter front, making it very easy to add inverters into the network without any extra option boards. Therefore, saving costs and space.

- V/f controlled inverter
- Side by side mounting
- EMC filter built-in
- RS485 Modbus built-in
- Overload detection function (150% during 60 s)
- PID
- Micro-surge voltage suppression
- Automatic energy saving

Ordering information

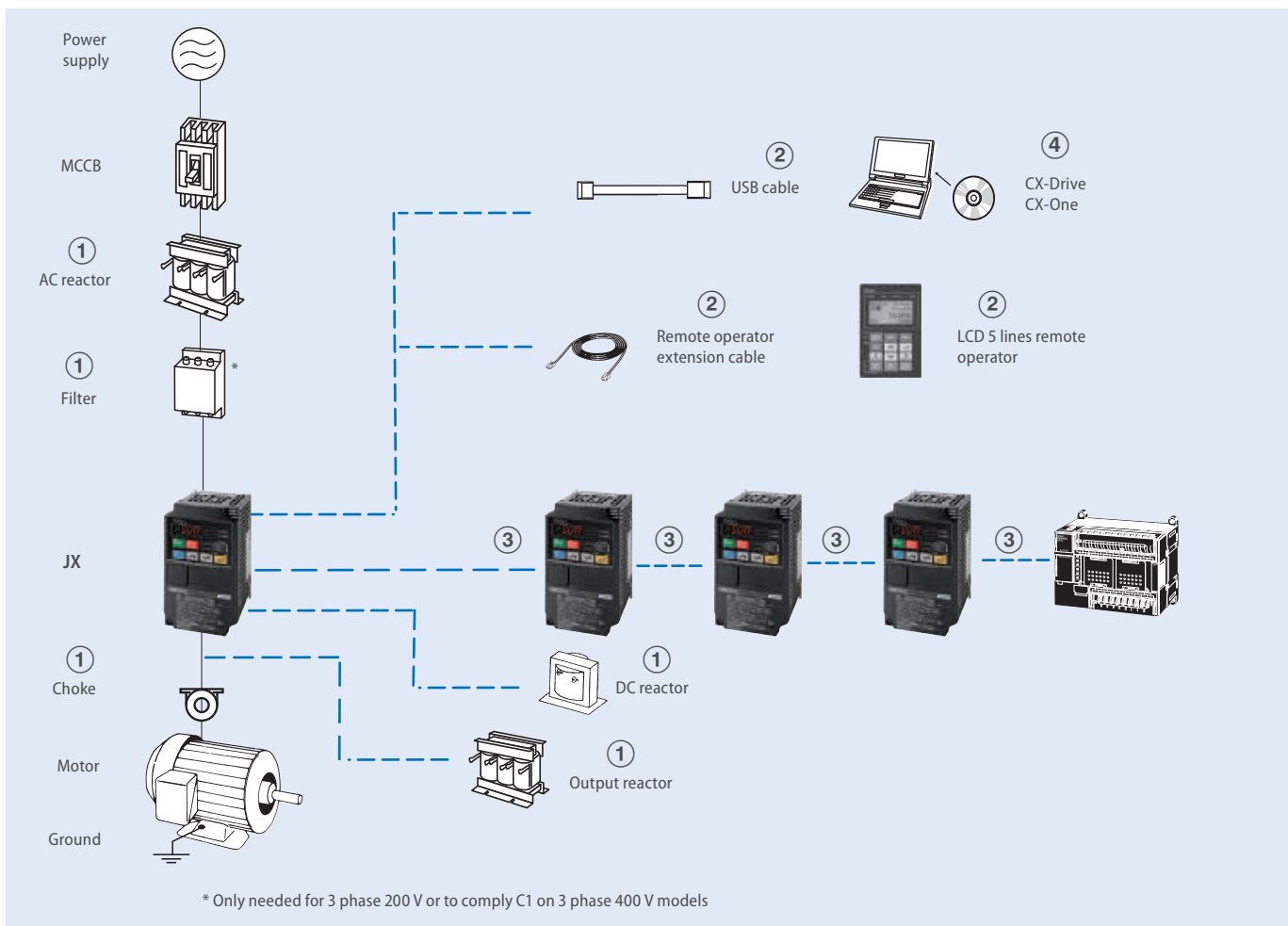

3G3JX

Specifications			Order code
Voltage class	Max. applicable motor output kW	Rated output current (A)	Standard
Single-phase 200 V	0.2	1.4	3G3JX-AB002-EF
	0.4	2.6	3G3JX-AB004-EF
	0.75	4	3G3JX-AB007-EF
	1.5	7.1	3G3JX-AB015-EF
	2.2	10	3G3JX-AB022-EF
Three-phase 200 V	0.2	1.4	3G3JX-A2002-E
	0.4	2.6	3G3JX-A2004-E
	0.75	4	3G3JX-A2007-E
	1.5	7.1	3G3JX-A2015-E
	2.2	10	3G3JX-A2022-E
	3.7	15.9	3G3JX-A2037-E
	5.5	24	3G3JX-A2055-E
Three-phase 400 V	0.4	1.5	3G3JX-A4004-EF
	0.75	2.5	3G3JX-A4007-EF
	1.5	3.8	3G3JX-A4015-EF
	2.2	5.5	3G3JX-A4022-EF
	4.0	8.6	3G3JX-A4040-EF
	5.5	13	3G3JXA4055-EF
	7.5	16	3G3JXA4075-EF

① Line filters

Inverter		Line filter Rasmi		
Voltage	Model 3G3JX-__	Rated current (A)	Weight (kg)	Order code
1-Phase 200 VAC	AB002/AB004	6	0.5	AX-FIJ1006-RE
	AB007	10	0.6	AX-FIJ1010-RE
	AB015/AB022	26	0.8	AX-FIJ1026-RE
3-Phase 200 VAC	A2002/A2004/A2007	6	1.0	AX-FIJ2006-RE
	A2015/A2022/A2037	20	1.3	AX-FIJ2020-RE
	A2055/A2075	40	2.3	AX-FIJ2040-RE
3-Phase 400 VAC	A4004/A4007 /A4015	5	0.9	AX-FIJ3005-RE
	A4022 /A4040	11	1.1	AX-FIJ3011-RE
	A4055/A4075	20	1.7	AX-FIJ3020-RE

① Input AC Reactors

Inverter		AC Reactor
Voltage	Model 3G3JX-__	Order code
3-Phase 200 VAC	A2002/A2004/A2007	AX-RAI02800080-DE
	A2015/A2022/A2037	AX-RAI00880175-DE
	A2055/A2075	AX-RAI00350335-DE
1-Phase 200 VAC	AB002/AB004	Under development
	AB007	
	AB015/AB022	
3-Phase 400 VAC	A4004/A4007/A4015	AX-RAI07700042-DE
	A4022/A4040	AX-RAI03500090-DE
	A4055/A4075	AX-RAI01300170-DE

① DC Reactors

200 V single-phase		200 V three-phase		400 V three-phase	
Inverter	Order code	Inverter	Order code	Inverter	Order code
3G3JX-AB002	AX-RC10700032-DE	3G3JX-A2002	AX-RC21400016-DE	-	
3G3JX-AB004	AX-RC06750061-DE	3G3JX-A2004	AX-RC10700032-DE	3G3JX-A4004	AX-RC43000020-DE
3G3JX-AB007	AX-RC03510093-DE	3G3JX-A2007	AX-RC06750061-DE	3G3JX-A4007	AX-RC27000030-DE
3G3JX-AB015	AX-RC02510138-DE	3G3JX-A2015	AX-RC03510093-DE	3G3JX-A4015	AX-RC14000047-DE
3G3JX-AB022	AX-RC01600223-DE	3G3JX-A2022	AX-RC02510138-DE	3G3JX-A4022	AX-RC10100069-DE
-		3G3JX-A2037	AX-RC01600223-DE	3G3JX-A4040	AX-RC06400116-DE
		3G3JX-A2055	AX-RC01110309-DE	3G3JX-A4055	AX-RC04410167-DE
		3G3JX-A2075	AX-RC00840437-DE	3G3JX-A4075	AX-RC03350219-DE

① Chokes

Diameter	Description	Order code
21	For 2.2 KW motors or below	AX-FER2102-RE
25	For 7.5 KW motors or below	AX-FER2515-RE

① Output AC Reactors

Inverter	AC Reactor	
Voltage	Model 3G3JX-□	Order code
200 VAC	A2001/A2002/A2004 AB001/AB002/AB004	AX-RAO11500026-DE
	A2007/AB007	AX-RAO07600042-DE
	A2015/AB015	AX-RAO04100075-DE
	A2022/AB022	AX-RAO03000105-DE
	A2037	AX-RAO01830160-DE
	A2055	AX-RAO01150220-DE
	A2075	AX-RAO00950320-DE
400 VAC	A4004/A4007/A4015	AX-RAO16300038-DE
	A4022	AX-RAO11800053-DE
	A4040	AX-RAO07300080-DE
	A4055	AX-RAO04600110-DE
	A4075	AX-RAO03600160-DE

② Accessories

Types	Description	Functions	Order code
Digital operator	LCD remote operator	5 Line LCD remote operator with copy function, cable length max. 3 m. ^{*1}	AX-OP05-E
	Remote operator cable	3 meters cable for connecting remote operator	3G3AX-CAJOP300-EE
	LED remote operator	LED remote operator, cable length max. 3 m	3G3AX-OP01
	Mounting kit for LED operator	Mounting kit for LED operator on panel	4X-KITMINI
Accessories	USB converter / USB cable	RJ45 to USB connection cable	3G3AX-PCACN2 USB-convertercable
	RJ45 T-Branch cable	T cable for RS-422 connection	3G3AX-CTB020-EE
	RJ45 Terminator resistor	Terminator resistor for RS-422 connection	3G3AX-CTR150-EE

*1 Please note, for 3G3JX inverters models, the operator will only display 2 lines of text.

④ Computer software

Description	Installation	Order code
Computer software	Configuration and monitoring software tool	CX-Drive
Computer software	Configuration and monitoring software tool	CX-One
Computer software	Software tool for Energy Saving calculation	€Saver

Specifications

200 V class

Single-phase: 3G3JX_		AB002	AB004	AB007	AB015	AB022	-	-	-		
Three-phase: 3G3JX_		A2002	A2004	A2007	A2015	A2022	A2037	A2055	A2075		
Output characteristics	Motor kW ^{*1}	Applicable motor capacity		0.2	0.4	0.75	1.5	2.2	3.7	5.5	7.5
	Inverter capacity kVA	200 V	0.4	0.9	1.3	2.4	3.4	5.5	8.3	11.0	
		240 V	0.5	1.0	1.6	2.9	4.1	6.6	9.9	13.3	
	Rated output current (A)		1.4	2.6	4.0	7.1	10.0	15.9	24.0	32.0	
	Max. output voltage		Proportional to input voltage: 0 to 240 V								
Max. output frequency		400 Hz									
Power supply	Rated input voltage and frequency		Single-phase 200 to 240 V 50/60 Hz Three-phase 200 to 240 V 50/60 Hz								
	Rated input current (A) Three-phase 200 V		1.8	3.4	5.2	9.3	13.0	20.0	30.0	40.0	
	Rated input current (A) Single-phase 200 V		3.1	5.8	9.0	16.0	22.5	-	-	-	
	Allowable voltage fluctuation		-15% to 10%								
	Allowable frequency fluctuation		5%								
Built-in filter		EMC filter (C1 single phase)									
Braking torque	At short-time deceleration	Approx. 50%				50% for 3-phase 20% to 40% for 1-phase		Approx 20% to 40%		Approx 20%	
	At capacitor feedback										
Cooling method		Self cooling				Forced-air-cooling					

*1 Based on a standard 3-Phase standard motor.

400 V class

Three-phase: 3G3JX_		A4004	A4007	A4015	A4022	A4040	A4055	A4075			
Output characteristics	Motor kW ^{*1}	Applicable motor capacity		0.4	0.75	1.5	2.2	4.0	5.5	7.5	
	Inverter capacity kVA	380 V	0.9	1.6	2.5	3.6	5.6	8.5	10.5		
		480 V	1.2	2.0	3.1	4.5	7.1	10.8	13.3		
	Rated output current (A)		1.5	2.5	3.8	5.5	8.6	13.0	16.0		
	Max. output voltage		Proportional to input voltage: 0 to 480 V								
Max. output frequency		400 Hz									
Power supply	Rated input voltage and frequency		3-phase 380 to 480 V 50/60 Hz								
	Rated input current (A)		2.0	3.3	5.0	7.0	11.0	16.5	20.0		
	Allowable voltage fluctuation		-15% to 10%								
	Allowable frequency fluctuation		5%								
Built-in filter		EMC filter C2 class									
Braking torque	At short-time deceleration	Approx. 50%			Approx. 20% to 40%			Approx. 20%			
	At capacitor feedback										
Cooling method		Self cooling			Forced-air-cooling						

*1 Based on a standard 3-Phase standard motor.

Dimensions

Voltage class	Max. applicable motor output kW	Inverter model	Dimensions in mm				Weight (kg)
			H	W	D		
Single-phase 200 V	0.2	3G3JX-AB002	155	80	95.5	0.8	
	0.4	3G3JX-AB004			109.5	0.9	
	0.75	3G3JX-AB007	189	110	130.5	1.5	
	1.5	3G3JX-AB015			157.5	2.3	
	2.2	3G3JX-AB022				2.4	
Three-phase 200 V	0.2	3G3JX-A2002	155	80	95.5	0.8	
	0.4	3G3JX-A2004			109.5	0.9	
	0.75	3G3JX-A2007	189	110	132.5	1.1	
	1.5	3G3JX-A2015			157.5	2.2	
	2.2	3G3JX-A2022				2.4	
	3.7	3G3JX-A2037	250	180	167.5	4.2	
	5.5	3G3JX-A2055					
	7.5	3G3JX-A2075					
Three-phase 400 V	0.4	3G3JX-A4004	189	110	130.5	1.5	
	0.75	3G3JX-A4007			157.5	2.3	
	1.5	3G3JX-A4015				2.4	
	2.2	3G3JX-A4022	250	180	167.5	4.2	
	4.0	3G3JX-A4040					
	5.5	3G3JX-A4055					
	7.5	3G3JX-A4075					

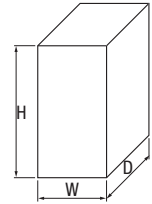

Sensing

Find information fast!

Quick Links shortens your search. Quick Links are unique codes assigned to Omron products listed in this guide. Enter Quick Link codes in the search box on industrial.omron.eu to access detailed information on products in this guide.

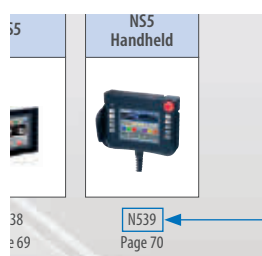

Quick Link

Sensing

Photoelectric sensors

Product overview	172
Selection table	174
Compact square	
E3Z	176
E3ZM	178
E3Z-Laser	180
Miniature and Photomicro	
E3T	192
E3H2	190
EE-SX47/67	194
Fork	
E3Z-G	196
Cylindrical	
E3FA/E3FB	184
E3F_-B/-V	201
E3F1	187
E3FC	188
E3H2	190
E3T-C	191
Longer distance	
E3S-CL	181
E3G-M	209
E3Z-Laser	180
E3G	173
Special application	
E3ZM-C	197
E3ZM-B	199
E3Z-B	200
E3JK	182
E3JM	208
E3NC	203
E3S-LS3	207
E3S-DB	202
Reflectors	
E39	210
Accessories	
AS	212
E39/Y92E-B	213

Mark and color sensors

Product overview	214
Selection table	216
Mark sensors	
E3ZM-V	217
E3X-DAC-S	218
FQ	214
FZ	214
Color sensors	
E3X-DACLR	220
FQ2-CLR	221
Xpectia lite	215

Lightcurtains and area sensors

Product overview	222
Selection table	224
Lightcurtains and area sensors	
F3ET2	225
F3E	226
E32 Area monitoring	227
F3EM2	228
E3Z	222
ZX-GT	223

Fiber optic sensors and amplifiers

Product overview	230
Selection table	232
Fiber sensor heads	
E32 Standard cylindrical	234
E32 Square shape	236

Fiber optic sensors and amplifiers

E32 Miniature	238
E32 Longer distance	240
E32 Chemical resistant	242
E32 Heat resistant	243
E32 Vacuum resistant	245
E32 Robot application	247
E32 Precision detection	248
E32 Special application	250
Fiber amplifiers	
E3X-HD	252
E3X-SD	255
E3X-NA	256
E3NX-FA	258
E3X-DAC-S	218
E3X-NA_F	231
E3X-MDA	231
E3X-DAH-S	231
Fiber accessories	
E39/E32	261

Inductive sensors

Product overview	262
Selection table	264
Compact – cylindrical	
E2A	266
E2A-S	268
E2A3	269
E2B	270
μPROX E2E Small Diameter	272
Square/block style	
TL-W	273
E2S	274
E2Q5	275
Special models	
E2EH	276
E2AU	277
E2E_-U	278
E2FM	279
E2C-EDA	281
E2FQ	264

Mechanical sensors/Limit switches

Product overview	282
Selection table	285
Limit switches	
D4N	286
D4B	288
WL-N	290
D4C	292
ZC	294
Z	296
EE-SX	282
D4C, D4E, X, Z, ZC	283
D4MC, HL, WL	283
D4E, SHL, WL	283
D5B	285

Rotary encoders

Product overview	298
Selection table	301
Rotary encoders	
E6A2-C, E6B2-C	302
E6C2-C/E6C3-C, E6F-C	303
E6H-C	304
E6C3-A, E6F-A	305

Cable connectors

Cable connectors	
XS2, XS3, Y92E	306

Photoelectric sensors

FOR MACHINES BUILT TO LAST

Reliability and accuracy confirmed by millions . . . every day

With more than one million units sold, OMRON Photoelectric sensors are among the world's most popular and successful photoelectric sensors.

Manufactured to exceptionally high engineering standards, you can take the performance reliability for granted.

- Optimal sensing performance tuned to your application
- Various housing designs fitting your application concept
- Proven performance and unmatched reliability

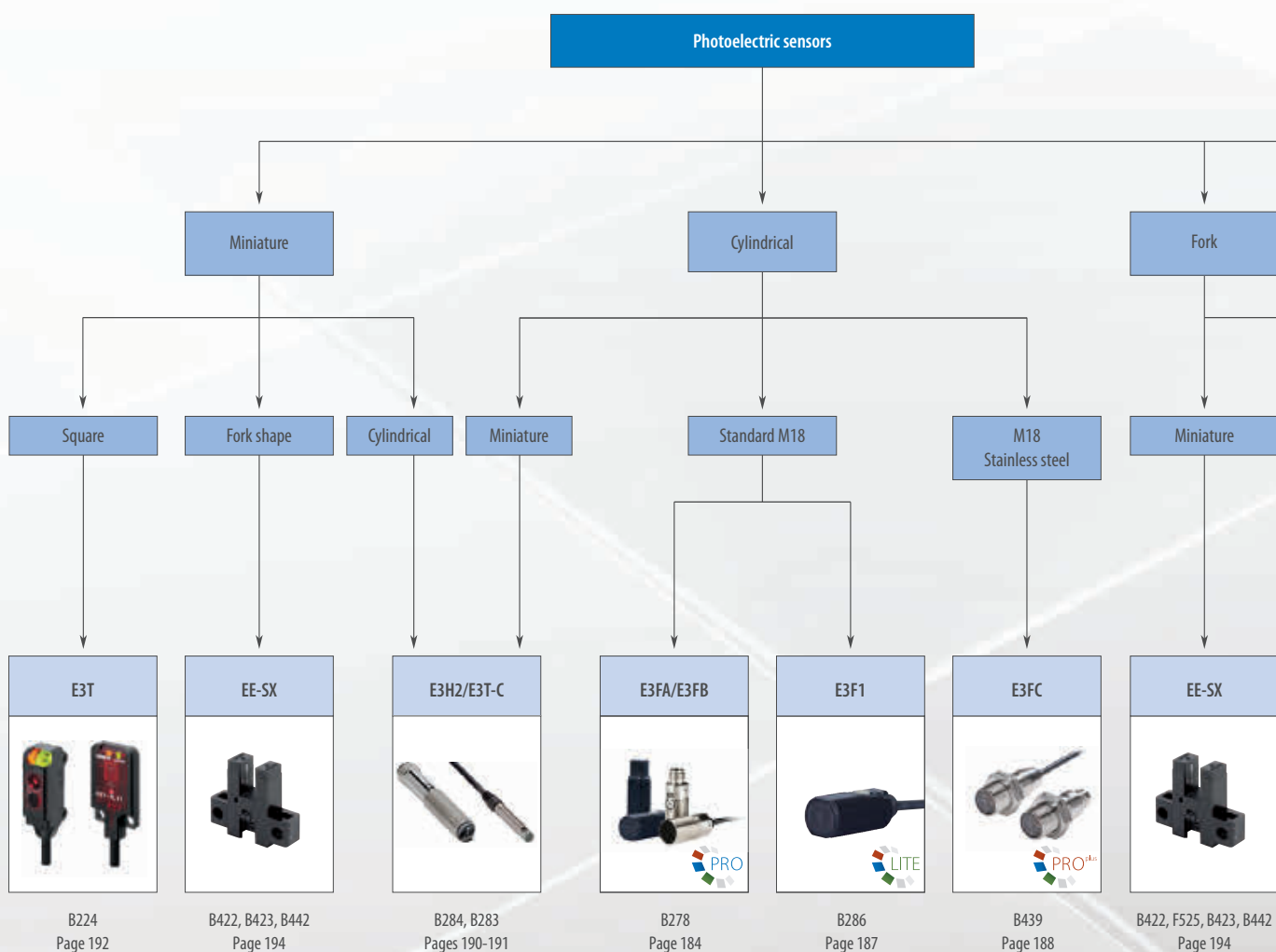

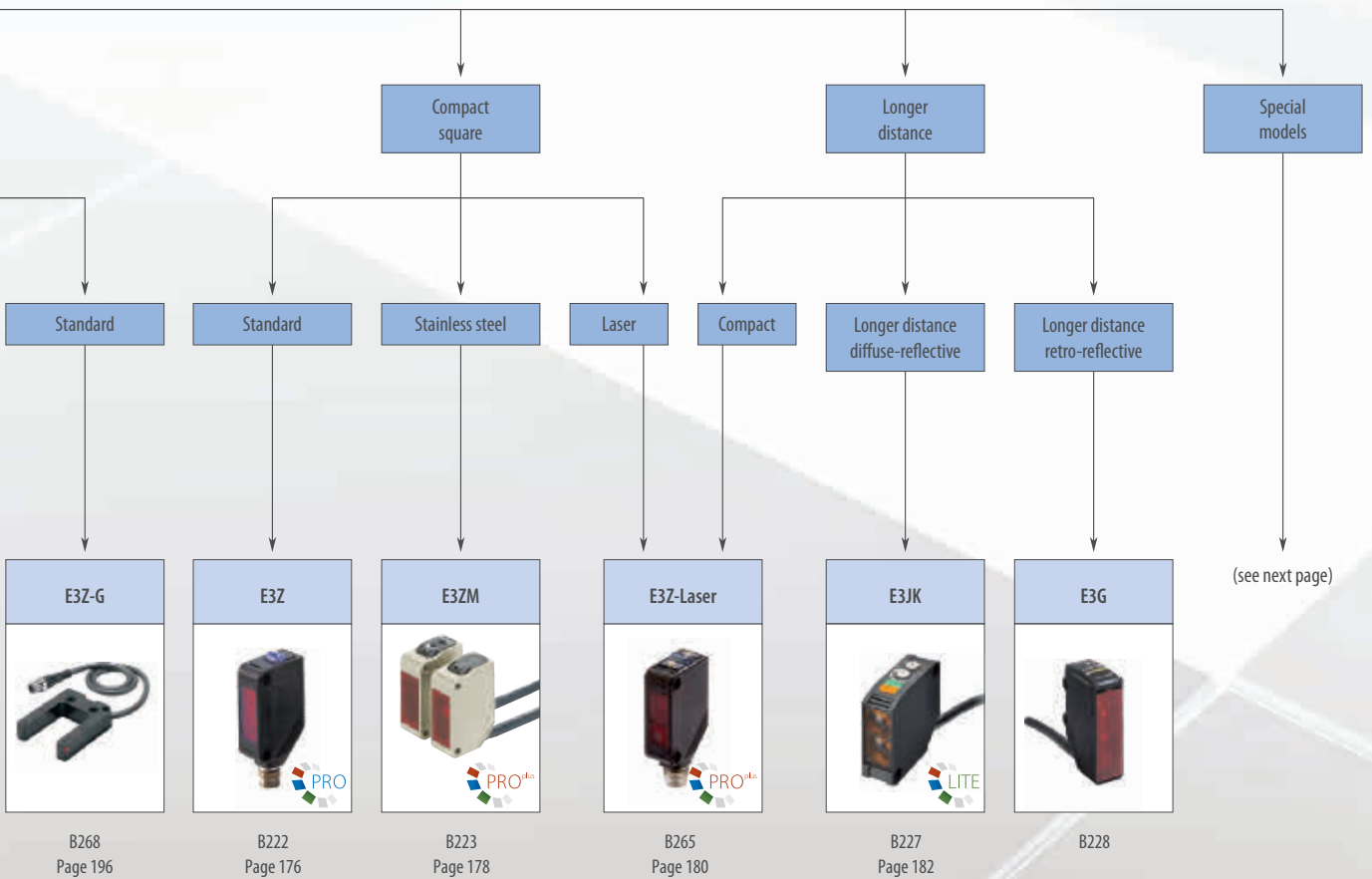









Selection table

Type	Compact square			Longer distance	
					
Model	E3Z	E3ZM	E3Z Laser	E3S-CL	E3JK
361°	PRO	PRO ^{plus}	PRO ^{plus}	n.a.	LITE
Housing	PBT	Stainless steel	PBT	Zinc diecast	ABS
Through-beam	15 m, 30 m	15 m	60 m	–	40 m
Retro-reflective with M.S.R.	5 m	4 m	15 m	–	7 m
Diffuse-reflective (energetic)	1 m	1 m	–	–	2.5 m
Diffuse-reflective (background suppression)	200 mm	200 mm	300 mm	500 mm	–
Page/Quick Link	176	178	180	181	182

Type	Cylindrical			
				
Model	E3FA/E3FB	E3F1	E3FC	E3H2
361°	PRO	LITE	PRO ^{plus}	n.a.
Housing	M18 PBT, metal	ABS	M18 stainless steel	M12 metal, M8 stainless steel
Through-beam	20 m	15 m	20 m	4 m, 2 m
Retro-reflective with M.S.R.	4 m	3 m	4 m	2 m
Diffuse-reflective (energetic)	1 m	300 mm	1 m	300 mm
Diffuse-reflective (background suppression)	200 mm	–	200 mm	–
Page/Quick Link	184	187	188	190

Type	Miniature			Fork
				
Model	E3T-C	E3T	EE-SX47/67	E3Z-G
361°	n.a.	n.a.	n.a.	n.a.
Housing	M5, M6 stainless steel	PBT	PBT	PBT
Through-beam	1 m	1 m, 2 m	5 mm (slot width)	25 mm
Retro-reflective with M.S.R.	–	200 mm	–	–
Diffuse-reflective (energetic)	50 mm	30 mm	–	–
Diffuse-reflective (background suppression)	–	30 mm	–	–
Page/Quick Link	191	192	194	196

Type	Oil resistant	Mark detection	Transparent detection			
						
Model	E3ZM-C	E3ZM-V	E3ZM-B	E3Z-B	E3F_-B/-V	E3S-DB
361°	PRO ^{plus}	PRO ^{plus}	PRO ^{plus}	PRO ^{plus}	PRO ^{plus}	PRO ^{plus}
Key features	Oil and lubricant resistant stainless steel housing	White LED for optimal contrast recognition	Optimised optical system for all transparent objects	Optical system for standard transparent objects	Optimised optical system for all transparent objects	Enhanced performance for all transparent objects, SmartTeach, Narrow spot
Housing	Stainless steel	Stainless steel	Stainless steel	PBT	M18 PBT/metal	PBT/ABS
Through-beam	20 m	–	–	–	–	–
Retro-reflective with M.S.R.	4 m	–	500 mm	500 mm, 2 m	2 m	4.5 m
Diffuse-reflective	1 m	12mm±2mm	–	–	–	–
Diffuse-reflective (background suppression)	200 mm	–	–	–	50 mm	–
Page/Quick Link	197	217	199	200	201	202

Type	High precision positioning	Structured object detection	Multi voltage power supply
			
Model	E3NC Laser Sensors	E3S-LS3	E3JK, E3JM, E3G-_M
361°	n.a.	n.a.	n.a.
Key features	0.1 mm Laser spot, line beam, CMOS BGS, EtherCAT connectivity	Wide beam	AC/DC power supply and relay output
Housing	PBT	PBT	ABS, ABS, PBT
Through-beam	–	–	40 m, 10 m, –
Retro-reflective with M.S.R.	8 m	–	9 m, 4 m, 10 m
Diffuse-reflective	1.2 m	60 mm	2.5 m, 700 mm, 2 m
Diffuse-reflective (background suppression)	250 mm	–	–, –, 1.2 m
Page/Quick Link	203	207	182/208/209

General purpose sensor in compact plastic housing

The compact housing size and the high-power LED provide an excellent performance-size ratio and the high optical precision and long sensor lifetime make the sensor the first choice for standard and challenging applications.

- Minimal optical axis deviation for easy alignment
- IP67 and IP69K for highest water resistance
- Intensive shielding for highest noise immunity (EMC)
- Multiple molding housing for high mechanical resistance



Ordering information

Sensor type	Sensing distance	Connection method				Order code*1	
						NPN output	PNP output
Through-beam 	30 m (Infrared light)	-	-	2 m	For ordering pigtail versions replace '2M' of cable types with: - M1J: M12 with 30 cm cable - M3J: M8 4-pin with 30 cm cable - M5J: M8 3-pin with 30 cm cable	E3Z-T62 2M	E3Z-T82 2M
	10 m (Red light)	-	-	2 m		E3Z-T67	E3Z-T87
Retro-reflective with M.S.R. 	0.1 to 4 m*2 (Red light)	-	-	2 m		E3Z-T61A 2M	E3Z-T81A 2M
	0.1 to 5 m*2 (Infrared light)	-	-	2 m		E3Z-T66A	E3Z-T86A
Retro-reflective without M.S.R. 	0.1 to 4 m*2 (Red light)	-	-	2 m		E3Z-R61 2M	E3Z-R81 2M
	0.1 to 5 m*2 (Infrared light)	-	-	2 m		E3Z-R66	E3Z-R86
Diffuse-reflective 	1 m (adjustable) (Infrared light)	-	-	2 m		E3Z-R61-4 2M	E3Z-R81-4 2M
	100 mm (adjustable) (Infrared light)	-	-	2 m		E3Z-R66-4	E3Z-R86-4
Diffuse-reflective wide beam 	1 m (adjustable) (Infrared light)	-	-	2 m		E3Z-D62 2M	E3Z-D82 2M
	100 mm (adjustable) (Infrared light)	-	-	2 m		E3Z-D67	E3Z-D87
Distance settable (background suppression) 	Small spot (Red light)	-	-	2 m		E3Z-D61 2M	E3Z-D81 2M
	Standard (Red light)	-	-	2 m		E3Z-D66	E3Z-D86
Distance settable (background suppression) 	Small spot (Red light)		-	-	2 m	E3Z-LS63 2M	E3Z-LS83 2M
	Standard (Red light)		-	-	2 m	E3Z-LS68	E3Z-LS88
Distance settable (background suppression) 	Small spot (Red light)		-	-	2 m	E3Z-LS61 2M*3	E3Z-LS81 2M*3
	Standard (Red light)		-	-	2 m	E3Z-LS66*3	E3Z-LS86*3

*1 Light-ON/Dark-ON switch selectable

*2 Measured with E39-R1S

*3 For infrared LED models contact your Omron representative

Specifications

Item	Through-beam		Retro-reflective with M.S.R	Retro-reflective without M.S.R	Diffuse-reflective	Diffuse-reflective (wide beam)	Distance-settable (background suppression)			
	NPN	E3Z-T62/T67	E3Z-T61A/T66A	Red LED	Infrared LED			Standard	Small spot	
	PNP	E3Z-T82/T87	E3Z-T81A/T86A	E3Z-R61/R66	E3Z-R6_-4	E3Z-D62/D67	E3Z-D61/D66	E3Z-LS61/66	E3Z-LS63/68	
Directional angle	Both emitter and receiver: 3° to 15°		2° to 10°		-					
Black/white error	-						10% of set distance max.	5% of set distance max.		
Light source (wave length)	Infrared LED (870 nm)	RED LED (700 nm)	Red LED (680 nm)	Infrared LED (870 nm)	Infrared LED (860 nm)		Red LED (680 nm)	Red LED (650 nm)		
Power supply voltage	12 to 24 VD±10%, ripple (p-p): 10% max.									
Protective circuits	Reverse polarity protection, short-circuit protection, output reverse polarity protection	Output short-circuit protection, power supply, reverse polarity protection	Reverse polarity protection, output short-circuit protection, mutual interference prevention, output reverse polarity protection				Reverse polarity protection, output short-circuit protection, mutual interference prevention			
Response time	2 ms max.		1 ms max.							
Ambient temperature	Operating	-25 to 55°C								
	Storage	-40 to 70°C (with no icing or condensation)								
Degree of protection	IEC 60529 IP67, IP69K after DIN 40050 part 9									
Material	Case	PBT (polybutylene terephthalate)								
	Lens	Denatured polyacrylate resin			Methacrylate resin		Denatured polyacrylate resin			



High ambient light immunity



High electromagnetic noise immunity



Robust and tight housing construction

Photoelectric sensor in compact stainless steel housing

Compact housing size and high power LED for excellent performance-size ratio in a rugged, detergent-resistant stainless steel housing for demanding environments.

- High grade stainless steel housing (SUS316L)
- IP67 and IP69k for highest water resistance
- ECOLAB tested and certified detergent resistance



Ordering information

Sensor type	Sensing distance	Connection method				Order code*1	
						NPN output	PNP output
Through-beam 	15 m	–	–	2 m	*2	E3ZM-T61 2M	E3ZM-T81 2M
	0.8 m with built-in slit	–	–	2 m		E3ZM-T66	E3ZM-T86
Retro-reflective with M.S.R. 	0.1 to 4 m	–	–	2 m		E3ZM-T63 2M	E3ZM-T83 2M
		–	–	–		E3ZM-T68	E3ZM-T88
Diffuse-reflective 	1 m (adjustable)	–	–	2 m		E3ZM-R61 2M	E3ZM-R81 2M
		–	–	–		E3ZM-R66	E3ZM-R86
Diffuse-reflective (background suppression) 	10 to 100 mm (fixed)	–	–	2 m		E3ZM-D62 2M	E3ZM-D82 2M
	10 to 200 mm (fixed)	–	–	–		E3ZM-D67	E3ZM-D87
		–	–	–		E3ZM-LS61X 2M*3	E3ZM-LS81X 2M*3
		–	–	–		E3ZM-LS66X*3	E3ZM-LS86X*3
		–	–	2 m	E3ZM-LS64X 2M*3	E3ZM-LS84X 2M*3	
		–	–	–	E3ZM-LS69X*3	E3ZM-LS89X*3	

*1 Light-ON / Dark-ON switch selectable except for E3ZM-LS

*2 For ordering pigtail versions replace '2M' of the cable types with:

- S1J: for M12 stainless steel plug with 30 cm cable
- S3J: for M8 4-pin stainless steel plug with 30cm cable
- S5J: for M8 3-pin stainless steel plug with 30cm cable (except for background suppression types)
- M1J: for M12 brass plug with 30cm cable
- M3J: for M8 4-pin brass plug with 30cm cable
- M5J: for M8 3-pin brass plug with 30cm cable (except for background suppression types)

*3 E3ZM-LS_X are fixed LIGHT-ON models. For fixed DARK-ON models please order E3ZM-LS_Y and for L-ON/D-ON selectable by wire please order E3ZM-LS_H.

Specifications

Item	Through-beam		Retro-reflective with M.S.R.		Diffuse-reflective
	NPN	E3ZM-T61 E3ZM-T66	E3ZM-T63 E3ZM-T68	E3ZM-R61 E3ZM-R66	E3ZM-D62 E3ZM-D67
	PNP	E3ZM-T81 E3ZM-T86	E3ZM-T83 E3ZM-T88	E3ZM-R81 E3ZM-R86	E3ZM-D82 E3ZM-D87
Light source (wave length)	Infrared LED (870 nm)			Red LED (660 nm)	Infrared LED (860 nm)
Power supply voltage	10 to 30 VDC, ±10% ripple (p-p)				
Protective circuits	Power supply reverse polarity protection, output short-circuit protection, output reverse polarity protection			Power supply reverse polarity protection, output short-circuit protection, mutual interference prevention, output reverse polarity protection	
Response time	1 ms max.				
Ambient temperature	Operating	–25 to 55°C			
	Storage	–40 to 70°C (with no icing or condensation)			
Degree of protection	IEC 60529 IP67, IP69K after DIN 40050 part 9				
Material	Case	SUS316L			
	Lens	Methacrylic resin			
	Display	PES (polyether sulfone)			
	Sensitivity adjustment and operation switch	PEEK (polyether ether ketone)			
	Seals	Fluoro rubber			

Item		Diffuse-reflective with background suppression (fixed distance)	
		NPN	PNP
Light source (adjustable)		Red LED (650 nm)	Red LED (660 nm)
Black/white error		5% of sensing distance max.	20% of sensing distance max.
Power supply voltage		10 to 30 VDC, ±10% ripple (p-p): 10% max.	
Protective circuits		Power supply reverse polarity protection, output short-circuit protection, output reverse polarity protection, mutual interference protection	
Response time		1 ms max.	
Ambient temperature range	Operating	-25 to 55°C	
	Storage	-40 to 70°C (with no icing or condensation)	
Degree of protection		IEC 60529 IP67, IP69K after DIN 40050 part 9	
Material	Case	SUS316L	
	Lens	Methacrylic resin	
	Display	PES (polyether sulfone)	
	Sensitivity adjustment and operation switch	PEEK (polyether ether ketone)	
	Seals	Fluoro rubber	



Robust construction



Tight housing

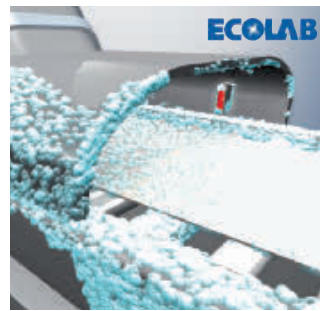

Detergent resistant



Pre-wired models with stainless steel plug connectors for best combination of highest water ingress protection with fast connect & disconnect.



LASER sensor in compact plastic housing

The E3Z LASER sensor in compact plastic housing features visible LASER light for precision positioning and detection applications.

- Visible LASER light for precision positioning and small object detection
- High power LD for long range precision
- Class 1 LASER
- Precise background suppression and low black/white error for accurate detection

Ordering information

Sensor type	Sensing distance	Response time	Connection method				Order code*1	
							NPN output	PNP output
Through-beam 	60 m	1 ms	-	-	2 m	For ordering pigtail versions replace '2M' of cable types with: - M1J: M12 with 30 cm cable - M3J: M8 4-pin with 30 cm cable - M5J: M8 3-pin with 30 cm cable	E3Z-LT61 2M	E3Z-LT81 2M
Retro-reflective with M.S.R. 	0.3 to 15 m*2		-	-	2 m		E3Z-LT66	E3Z-LT86
Distance-settable (background suppression) 		20 to 300 mm	-	-	2 m		E3Z-LR61 2M	E3Z-LR81 2M
	25 to 300 mm	0.5 ms	-	-	2 m		E3Z-LR66	E3Z-LR86
	-		-	2 m	E3Z-LL61 2M		E3Z-LL81 2M	
	-	-	-	2 m	E3Z-LL66		E3Z-LL86	
	-	-	-	2 m	E3Z-LL63 2M		E3Z-LL83 2M	
	-	-	-	2 m	E3Z-LL68		E3Z-LL88	

*1 Light-ON/Dark-ON switch selectable

*2 Measured with E39-R1

Specifications

Item	Through-beam	Retro-reflective with M.S.R.	Distance settable (background suppression)	
	Standard model			High-speed model
NPN output	E3Z-LT61/-LT66	E3Z-LR61/-LR66	E3Z-LL61/-LL66	E3Z-LL63/-LL68
PNP output	E3Z-LT81/-LT86	E3Z-LR81/-LR86	E3Z-LL81/-LL86	E3Z-LL83/-LL88
Black/white error	-		5% (at 160 mm)	5% (at 100 mm)
Light source (wave length)	Red LD (655 nm), JIS Class 1, IEC Class 1, FDA Class II			
Power supply voltage	12 to 24 VDC±10%, ripple (p-p): 10% max.			
Protective circuits	Power supply reverse polarity, protection, short circuit protection, output reverse polarity protection	Power supply reverse polarity protection, short circuit protection, output reverse polarity protection, mutual interference prevention		
Response time	1 ms max.			0.5 ms max.
Ambient temperature	Operating	-10 to 55°C		
	Storage	-25 to 70°C (with no icing or condensation)		
Degree of protection	IEC 60529 IP67, IP69K after DIN 40050 part 9			
Material	Case	PBT (polybutylene terephthalate)		
	Lens	Modified polyacrylate resin	Methacrylate	Modified polyacrylate resin

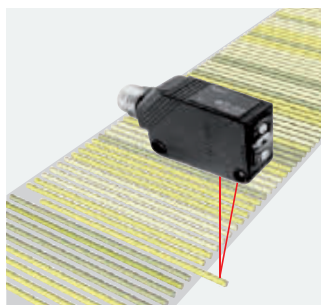

Low black/white error for precise detection



Visible laser light for precision positioning

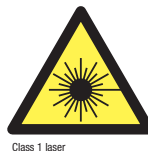

Class 1 laser



Distance-settable photoelectric sensor in metal housing

- Minimal black/white error for highest reliability detecting differently colored objects (E3S-CL1)
- Setting distance up to 500 mm with reliable background suppression

Ordering information

Sensortype	Sensing distance	Connection method				Order code*1
Distance-settable (background suppression) 		-	-		-	E3S-CL1 2M
		-	-	-		E3S-CL1-M1J
		-	-		-	E3S-CL2 2M
		-	-	-		E3S-CL2-M1J

*1 Light-ON/Dark-ON switch selectable. NPN/PNP switch selectable

Specifications

Item	Distance-settable (background suppression)	
	E3S-CL1	E3S-CL2
Light source (wave length)	Red LED (700 nm)	Infrared LED (860 nm)
Black/white error*1	2% max.	10% max.
Power supply voltage	10 to 30 VDC [ripple (p-p) 10% included]	
Protective circuits	Reverse polarity protection, output short-circuit protection, mutual interference prevention	
Response time	1 ms max.	2 ms max.
Ambient temperature	Operating	-25 to 55°C (with no icing or condensation)
	Storage	
Degree of protection	IEC 60529 IP67	
Material	Case	Zinc diecast
	Operation panel cover	Polyethyl sulfon
	Lens	Acrylics

*1 Sensing distance difference between standard white paper (reflectivity 90%) and standard black paper (reflectivity 5%)



All voltage photoelectric sensor with long sensing distance

The new generation of square sized E3JK family provides significantly enhanced sensing performance and ease of operation. The family features 24 to 240 VAC power models as well as models with PNP/NPN transistor output.

- High power and visible red LED for all models enabling easy alignment and long sensing distance
- Bright indicator LEDs that are visible even at a large distance
- Best price-value ratio

Ordering information

Sensor type	Sensing distance	Connection method				Order code		
						Relay models (AC/DC)	NPN models	PNP models
Through-beam 	40 m (adjustable)	–	–	2 m	–	E3JK-TR11 2M	E3JK-TN11 2M	E3JK-TP11 2M
Retro-reflective without M.S.R. 	9 m ^{*1} (adjustable)	–	–	–	–	E3JK-RR11 2M	E3JK-RN11 2M	E3JK-RP11 2M
Retro-reflective with M.S.R. 	7 m ^{*1} (adjustable)	–	–	–	–	E3JK-RR12 2M	E3JK-RN12 2M	E3JK-RP12 2M
Diffuse-reflective 	2.5 m (adjustable)	–	–	–	–	E3JK-DR11 2M	E3JK-DN11 2M	E3JK-DP11 2M
	300 mm (adjustable)	–	–	–	–	E3JK-DR12 2M	E3JK-DN12 2M	E3JK-DP12 2M

^{*1} Measured with E39-R15. Please order reflector separately.

Accessories

Appearance	Description	Order code
	Mounting bracket ^{*1} (A mounting bracket is not provided with the sensor. Order a mounting bracket separately if required.)	E39-L40

^{*1} When using a through-beam sensor, order one mounting bracket for the receiver and one for the emitter.

Specifications

AC models

Item	Through-beam	Retro-reflective without M.S.R.	Retro-reflective with M.S.R.	Diffuse-reflective	
	E3JK-TR11	E3JK-RR11	E3JK-RR12	E3JK-DR11	E3JK-DR12
Sensing distance	40 m	9 m	7 m	2.5 m	300 mm
Light source (wave length)	Red LED (624 nm)				
Power supply voltage	24 to 240 VDC±10% ripple (p-p): 10% max. 24 to 240 VAC±10% 50/60 Hz				
Control output	Relay output SPDT, 250 VAC, 3 A max. (cosφ= 1), 5 VDC, 10 mA min., Light-ON/Dark-ON selectable				
Response time	20 ms max.				
Sensitivity adjustment	One-turn adjuster				
Ambient temperature	Operating	–25 to 55°C			
	Storage	–30 to 70°C (with no icing or condensation)			
Degree of protection	IEC60529 IP64				
Material	Case	ABS			
	Lens	Methacrylics (PMMA)			

DC models

Item	Through-beam	Retro-reflective without M.S.R.	Retro-reflective with M.S.R.	Diffuse-reflective		
	NPN output PNP output	E3JK-TN11 E3JK-TP11	E3JK-RN11 E3JK-RP11	E3JK-RN12 E3JK-RP12	E3JK-DN11 E3JK-DP11	E3JK-DN12 E3JK-DP12
Sensing distance	40 m	9 m	7 m	2.5 m	300 mm	
Light source (wave length)	Red LED (624 nm)					
Power supply voltage	10 to 30 VDC, including ripple (p-p): 10%					
Control output	Open collector output (NPN/PNP), Load current: 100 mA max., Light-ON/Dark-ON selectable					
Response time	1 ms max.					
Sensitivity adjustment	One-turn adjuster					
Ambient temperature	Operating	-25 to 55°C				
	Storage	-30 to 70°C (with no icing or condensation)				
Degree of protection	IEC60529 IP64					
Material	Case	ABS				
	Lens	Methacrylics (PMMA)				



AC power-supply fits for building installations like industrial doors, elevators or car parks

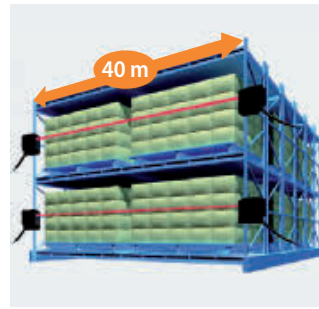

Long sensing distance up to 40 m

High performance photoelectric sensor in compact M18 housing

E3FA/E3FB series represents a new generation of OMRON photoelectric sensors with large varieties of reliable and easy-to use photoelectric sensors. Featuring many standard and special functions this line is addressing many kinds of industries such as packaging, ceramics and material handling.

- Large variety of standard and special types
- High power and visible red LED enabling easy alignment and long sensing distance
- Compact and robust housing for easy integration into machines



Ordering information

Straight types

Sensor type	Sensing distance	Connection method				Order code			
						E3FA (plastic housing)		E3FB (metal housing)	
						NPN output	PNP output	NPN output	PNP output
Through-beam (Red LED) 	20 m	–	–	2 m	–	E3FA-TN11 2M	E3FA-TP11 2M	E3FB-TN11 2M	E3FB-TP11 2M
		–	■	–	–	E3FA-TN21	E3FA-TP21	E3FB-TN21	E3FB-TP21
Through-beam (Infrared LED) 	15 m	–	–	2 m	–	E3FA-TN12 2M	E3FA-TP12 2M	–	–
		–	■	–	–	E3FA-TN22	E3FA-TP22	–	–
Retro-reflective with MSR ^{*1} 	0.1 to 4 m (with E39-R1S)	–	–	2 m	–	E3FA-RN11 2M	E3FA-RP11 2M	E3FB-RN11 2M	E3FB-RP11 2M
		–	■	–	–	E3FA-RN21	E3FA-RP21	E3FB-RN21	E3FB-RP21
Coaxial Retro-reflective with MSR ^{*1} 	0 to 500 mm (with E39-R1S)	–	–	2 m	–	E3FA-RN12 2M	E3FA-RP12 2M	E3FB-RN12 2M	E3FB-RP12 2M
		–	■	–	–	E3FA-RN22	E3FA-RP22	E3FB-RN22	E3FB-RP22
Diffuse-reflective (Red LED) 	100 mm	–	–	2 m	–	E3FA-DN11 2M	E3FA-DP11 2M	E3FB-DN11 2M	E3FB-DP11 2M
		–	■	–	–	E3FA-DN21	E3FA-DP21	E3FB-DN21	E3FB-DP21
	300 mm	–	–	2 m	–	E3FA-DN12 2M	E3FA-DP12 2M	E3FB-DN12 2M	E3FB-DP12 2M
		–	■	–	–	E3FA-DN22	E3FA-DP22	E3FB-DN22	E3FB-DP22
	1 m	–	–	2 m	–	E3FA-DN13 2M	E3FA-DP13 2M	E3FB-DN13 2M	E3FB-DP13 2M
		–	■	–	–	E3FA-DN23	E3FA-DP23	E3FB-DN23	E3FB-DP23
Diffuse-reflective (Infrared LED) 	100 mm	–	–	2 m	–	E3FA-DN14 2M	E3FA-DP14 2M	–	–
		–	■	–	–	E3FA-DN24	E3FA-DP24	–	–
	300 mm	–	–	2 m	–	E3FA-DN15 2M	E3FA-DP15 2M	–	–
		–	■	–	–	E3FA-DN25	E3FA-DP25	–	–
	1 m	–	–	2 m	–	E3FA-DN16 2M	E3FA-DP16 2M	–	–
		–	■	–	–	E3FA-DN26	E3FA-DP26	–	–
BGS (background suppression) 	100 mm	–	–	2 m	–	E3FA-LN11 2M	E3FA-LP11 2M	E3FB-LN11 2M	E3FB-LP11 2M
		–	■	–	–	E3FA-LN21	E3FA-LP21	E3FB-LN21	E3FB-LP21
	200 mm	–	–	2 m	–	E3FA-LN12 2M	E3FA-LP12 2M	E3FB-LN12 2M	E3FB-LP12 2M
		–	■	–	–	E3FA-LN22	E3FA-LP22	E3FB-LN22	E3FB-LP22

Radial types

Sensor type	Sensing distance	Connection method				Order code			
						E3RA (plastic housing)		E3RB (metal housing)	
						NPN output	PNP output	NPN output	PNP output
Through-beam 	15 m	-	-	2 m	-	E3RA-TN11 2M	E3RA-TP11 2M	E3RB-TN11 2M	E3RB-TP11 2M
		-	■	-	-	E3RA-TN21	E3RA-TP21	E3RB-TN21	E3RB-TP21
Retro-reflective with MSR ^{*1} 	0.1 to 3 m (with E39-R1S)	-	-	2 m	-	E3RA-RN11 2M	E3RA-RP11 2M	E3RB-RN11 2M	E3RB-RP11 2M
		-	■	-	-	E3RA-RN21	E3RA-RP21	E3RB-RN21	E3RB-RP21
Diffuse reflective 	100 mm	-	-	2 m	-	E3RA-DN11 2M	E3RA-DP11 2M	E3RB-DN11 2M	E3RB-DP11 2M
		-	■	-	-	E3RA-DN21	E3RA-DP21	E3RB-DN21	E3RB-DP21
	300 mm	-	-	2 m	-	E3RA-DN12 2M	E3RA-DP12 2M	E3RB-DN12 2M	E3RB-DP12 2M
		-	■	-	-	E3RA-DN22	E3RA-DP22	E3RB-DN22	E3RB-DP22
	700 mm	-	-	2 m	-	E3RA-DN13 2M	E3RA-DP13 2M	E3RB-DN13 2M	E3RB-DP13 2M
		-	■	-	-	E3RA-DN23	E3RA-DP23	E3RB-DN23	E3RB-DP23

*1 The Reflector is sold separately. Select the Reflector model most suited to the application.



Compact size and shape. Can be installed almost anywhere.



Visible LED light for easy alignment.

Specifications

Straight type

Model	Sensing method		Through-beam (Red LED)	Through-beam (Infrared LED)	Retro-reflective	Coaxial Retro-reflective	Diffuse-reflective		
	Item	NPN output	Pre-wired	E3F_-TN11 2M	E3F_-TN12 2M	E3F_-RN11 2M	E3F_-RN12 2M	E3F_-DN11 2M	E3F_-DN12 2M
M12 Connector			E3F_-TN21	E3F_-TN22	E3F_-RN21	E3F_-RN22	E3F_-DN21	E3F_-DN22	E3F_-DN23
Item	PNP output	Pre-wired	E3F_-TP11 2M	E3F_-TP12 2M	E3F_-RP11 2M	E3F_-RP12 2M	E3F_-DP11 2M	E3F_-DP12 2M	E3F_-DP13 2M
		M12 Connector	E3F_-TP21	E3F_-TP22	E3F_-RP21	E3F_-RP22	E3F_-DP21	E3F_-DP22	E3F_-DP23
Sensing distance			20 m	15 m	0.1 to 4 m	0 to 500 mm	100 mm	300 mm	1 m
Light source (wavelength)			Red LED (624 nm)	Infrared LED (850 nm)	Red LED (624 nm)				
Power supply voltage			10 to 30 VDC (include voltage ripple of 10%(p-p) max.)						
Operation mode			Light-ON/Dark-ON selectable by wiring						
Sensitivity adjustment			One-turn adjuster						
Protection circuits			Reversed power supply polarity protection, Output short-circuit protection and Reversed output polarity protection						
Response time			0.5 ms						
Ambient temperature		Operating	-25 to 55°C						
		Storage	-30 to 70°C (with no icing or condensation)						
Degree of protection			IEC: IP67, DIN 40050-9: IP69K						
Material	Case and Nut		E3FA: ABS, E3FB: Nickel brass						
	Lens and Display		PMMA						
	Adjuster		POM						

Model	Sensing method		Diffuse-reflective			BGS (Background suppression)	
	Item	NPN output	Pre-wired	E3F_-DN14 2M	E3F_-DN15 2M	E3F_-DN16 2M	E3F_-LN11 2M
M12 Connector			E3F_-DN24	E3F_-DN25	E3F_-DN26	E3F_-LN21	E3F_-LN22
Item	PNP output	Pre-wired	E3F_-DP14 2M	E3F_-DP15 2M	E3F_-DP16 2M	E3F_-LP11 2M	E3F_-LP12 2M
		M12 Connector	E3F_-DP24	E3F_-DP25	E3F_-DP26	E3F_-LP21	E3F_-LP22
Sensing distance			100 mm	300 mm	1 m	100 mm	200 mm
Light source (wavelength)			Infrared LED (850 nm)			Red LED (624 nm)	
Power supply voltage			10 to 30 VDC (include voltage ripple of 10%(p-p) max.)				
Operation mode			Light-ON/Dark-ON selectable by wiring				
Sensitivity adjustment			One-turn adjuster			Fixed	
Protection circuits			Reversed power supply polarity protection, Output short-circuit protection and Reversed output polarity protection				
Response time			0.5 ms				
Ambient temperature		Operating	-25 to 55°C				
		Storage	-30 to 70°C (with no icing or condensation)				
Degree of protection			IEC: IP67, DIN 40050-9: IP69K				
Material	Case and Nut		E3FA: ABS, E3FB: Nickel brass				
	Lens and Display		PMMA				
	Adjuster		POM				

Radial type

Model	Sensing method		Through-beam	Retro-reflective	Diffuse-reflective		
	Item	NPN output	Pre-wired	E3R_-TN11 2M	E3R_-RN11 2M	E3R_-DN11 2M	E3R_-DN12 2M
M12 Connector			E3R_-TN21	E3R_-RN21	E3R_-DN21	E3R_-DN22	E3R_-DN23
Item	PNP output	Pre-wired	E3R_-TP11 2M	E3R_-RP11 2M	E3R_-DP11 2M	E3R_-DP12 2M	E3R_-DP13 2M
		M12 Connector	E3R_-TP21	E3R_-RP21	E3R_-DP21	E3R_-DP22	E3R_-DP23
Sensing distance			15 m	0.1 to 3 m	100 mm	300 mm	700 mm
Light source (wavelength)			Red LED (624 nm)				
Power supply voltage			10 to 30 VDC (include voltage ripple of 10%(p-p) max.)				
Operation mode			Light-ON/Dark-ON selectable by wiring				
Sensitivity adjustment			One-turn adjuster				
Protection circuits			Reversed power supply polarity protection, Output short-circuit protection and Reversed output polarity protection				
Response time			0.5 ms				
Ambient temperature		Operating	-25 to 55°C				
		Storage	-30 to 70°C (with no icing or condensation)				
Degree of protection			IEC: IP67, DIN 40050-9: IP69K				
Material	Case and Nut		E3FA: ABS, E3FB: Nickel brass				
	Lens and Display		PMMA				
	Adjuster		POM				

Standard M18 Photosensor with best price-value ratio

OMRON E3F1 series represents an M18 size Photoelectric sensor with best value at competitive price. It features the same compact housing as E3FA and meets all requirements for standard industrial applications.

- Bright visible red LED enabling easy alignment
- Reliable operation in all industrial environments
- Compact and robust housing for easy integration into machines



Ordering information

Sensor type	Sensing distance	Connection method				Order code	
						NPN output	PNP output
Through-beam 	15 m	–	–	2 m	–	E3F1-TN11 2M*1	E3F1-TP11 2M*1
		–	■	–	–	E3F1-TN21*1	E3F1-TP21*1
Retro-reflective*2 	0.1 to 3 m (with E39-R1S)	–	–	2 m	–	E3F1-RN11 2M	E3F1-RP11 2M
		–	■	–	–	E3F1-RN21	E3F1-RP21
Diffuse-reflective 	100 mm	–	–	2 m	–	E3F1-DN11 2M	E3F1-DP11 2M
		–	■	–	–	E3F1-DN21	E3F1-DP21
	300 mm	–	–	2 m	–	E3F1-DN12 2M	E3F1-DP12 2M
		–	■	–	–	E3F1-DN22	E3F1-DP22

*1 Includes the emitter and receiver.
*2 The Reflector is sold separately.

Specifications

Model	Sensing method		Through-beam	Retro-reflective	Diffuse-reflective	
	NPN output	Pre-wired	E3F1-TN11 2M	E3F1-RN11 2M	E3F1-DN11 2M	E3F1-DN12 2M
Item	M12 Connector	Pre-wired	E3F1-TN21	E3F1-RN21	E3F1-DN21	E3F1-DN22
		M12 Connector	E3F1-TP11 2M	E3F1-RP11 2M	E3F1-DP11 2M	E3F1-DP12 2M
Sensing distance			15 m	0.1 to 3 m	100 mm	300 mm
Light source (wavelength)			Red LED (624 nm)			
Power supply voltage			10 to 30 VDC (include voltage ripple of 10%(p-p) max.)			
Operation mode			Light-ON/Dark-ON selectable by wiring			
Sensitivity adjustment			One-turn adjuster			
Protection circuits			Reversed power supply polarity protection, Output short-circuit protection and Reversed output polarity protection			
Response time			0.5 ms			
Ambient temperature	Operating		–25 to 55°C			
	Storage		–30 to 70°C (with no icing or condensation)			
Degree of protection			IEC: IP66			
Material	Case		ABS			
	Lens and Display		PMMA			



Compact size and shape. Can be installed almost anywhere.



Visible LED light for easy alignment.



M18 Photosensor in high-grade stainless steel housing

OMRON E3FC represents a compact M18 sensor with high housing protection for wash-down applications in Food & Beverage industry.

- High grade steel housing (SUS316L)
- Proven with various industrial detergents of Ecolab and Diversey
- Withstands heat shock conditions
- Epoxy resin at connector/cable end preventing water ingress
- Bright visible red LED enabling easy alignment



Ordering information

Sensor type	Sensing distance	Connection method				Order code	
						NPN output	PNP output
Through-beam 	20 m	–	–	2 m	–	E3FC-TN11 2M	E3FC-TP11 2M
		–	■	–	–	E3FC-TN21	E3FC-TP21
Retro-reflective with MSR ^{*1} 	0.1 to 4 m (with E39-R15)	–	–	2 m	–	E3FC-RN11 2M	E3FC-RP11 2M
		–	■	–	–	E3FC-RN21	E3FC-RP21
Diffuse-reflective ^{*2} 	300 mm (adjustable, red LED)	–	–	2 m	–	E3FC-DN12 2M	E3FC-DP12 2M
		–	■	–	–	E3FC-DN22	E3FC-DP22
	1 m (adjustable, red LED)	–	–	2 m	–	E3FC-DN13 2M	E3FC-DP13 2M
		–	■	–	–	E3FC-DN23	E3FC-DP23
	300 mm (adjustable, IR LED)	–	–	2 m	–	E3FC-DN15 2M	E3FC-DP15 2M
		–	■	–	–	E3FC-DN25	E3FC-DP25
	1 m (adjustable, IR LED)	–	–	2 m	–	E3FC-DN16 2M	E3FC-DP16 2M
		–	■	–	–	E3FC-DN26	E3FC-DP26
BGS ^{*2} (Background suppression) 	100 mm	–	–	2 m	–	E3FC-LN11 2M	E3FC-LP11 2M
		–	■	–	–	E3FC-LN21	E3FC-LP21
	200 mm	–	–	2 m	–	E3FC-LN12 2M	E3FC-LP12 2M
		–	■	–	–	E3FC-LN22	E3FC-LP22

^{*1} The Reflector is sold separately.

^{*2} Models with default L-On output logic for diffuse and BGS available. Please check with your OMRON representative.

Specifications

Model	Sensing method		Through-beam	Retro-reflective	Diffuse reflective				BGS (Background suppression)	
	NPN output	Pre-wired			E3FC-TN11 2M	E3FC-RN11 2M	E3FC-DN12 2M	E3FC-DN13 2M	E3FC-DN15 2M	E3FC-DN16 2M
		M12 connector	E3FC-TN21	E3FC-RN21	E3FC-DN22	E3FC-DN23	E3FC-DN25	E3FC-DN26	E3FC-LN21	E3FC-LN22
	PNP output	Pre-wired	E3FC-TP11 2M	E3FC-RP11 2M	E3FC-DP12 2M	E3FC-DP13 2M	E3FC-DP15 2M	E3FC-DP16 2M	E3FC-LP11 2M	E3FC-LP12 2M
Item		M12 connector	E3FC-TP21	E3FC-RP21	E3FC-DP22	E3FC-DP23	E3FC-DP25	E3FC-DP26	E3FC-LP21	E3FC-LP22
Sensing distance			20 m	0.1 to 4 m	300 mm	1 m	300 mm	1 m	100 mm	200 mm
Light source (wavelength)			red LED (624 nm)				Infrared LED (850 nm)		red LED (624 nm)	
Power supply voltage			10 to 30 VDC (include voltage ripple of 10%(p-p) max.)							
Operation mode			Light-ON/Dark-ON selectable by wiring							
Indicator			Operation indicator (orange) Stability indicator (green)							
Sensitivity adjustment			no adjuster				One-turn adjuster		no adjuster	
Protection circuits			Reversed power supply polarity protection, Output short-circuit protection and Reversed output polarity protection							
Response time			0.5 ms							
Ambient temperature		Operating	-25 to 55°C							
		Storage	-30 to 70°C (with no icing or condensation)							
Degree of protection			IP67, IP68 ^{*1} , IP69K							
Material		Case	Stainless Steel (SUS 316L)							
		Lens	PMMA							
		Cable	PVC							
		Adjuster	-				POM		-	

*1 IP68 test definition: Heat shock cycles in 3° and 60°C surface tensioned water (20 cycles with 30 min.)



Best fit for wash-down applications.

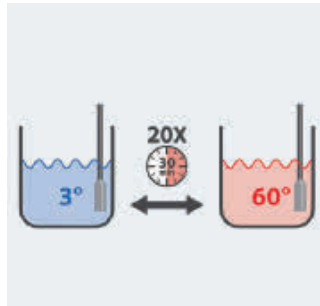

Proven in heat shock tests with surface tensioned water.

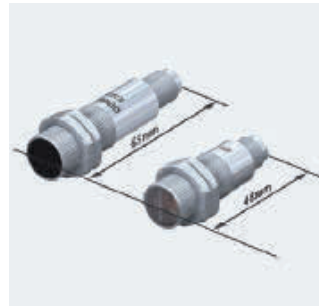

Compact size and shape. Can be installed almost anywhere.



Visible LED light for easy alignment.



Miniature photoelectric sensors in cylindrical M8 and M12 housing

- M8 or M12 sized cylindrical housings when mounting space is crucial
- Retro-reflective models with two teaching modes for standard and semi-transparent objects
- pre-wired and connector models

Ordering information

M12 cylindrical housing

Sensor type	Sensing distance	Connection method				Order code ^{*1}	
						NPN output	PNP output
Through-beam 	4 m (adjustable)	–	–	2 m	–	E3H2-T4C4M 2M	E3H2-T4B4M 2M
		–	■	–	–	E3H2-T4C4M-M1	E3H2-T4B4M-M1
Retro-reflective with M.S.R. 	2 m (teachable ^{*2})	–	–	2 m	–	E3H2-R2C4M 2M ^{*3}	E3H2-R2B4M 2M ^{*3}
		–	■	–	–	E3H2-R2C4M-M1 ^{*3}	E3H2-R2B4M-M1 ^{*3}
Diffuse-reflective 	300 mm (teachable)	–	–	2 m	–	E3H2-DS30C4M 2M	E3H2-DS30B4M 2M
		–	■	–	–	E3H2-DS30C4M-M1	E3H2-DS30B4M-M1
	100 mm (fixed)	–	–	2 m	–	E3H2-DS10C4M 2M	E3H2-DS10B4M 2M
		–	■	–	–	E3H2-DS10C4M-M1	E3H2-DS10B4M-M1

^{*1} Light-ON/Dark-ON selectable by wire

^{*2} Models without teach-button are available. Contact your OMRON representative.

^{*3} Without reflector; order reflector separately

M8 cylindrical housing

Sensor type	Sensing distance	Connection method				Operation mode	Order code	
							NPN output	PNP output
Through-beam 	2 m	–	–	2 m	–	dark on	E3H2-T2C2S 2M	E3H2-T2B2S 2M
		■	–	–	–		E3H2-T2C2S-M5	E3H2-T2B2S-M5
		–	–	2 m	–	light on	E3H2-T2C1S 2M	E3H2-T2B1S 2M
		■	–	–	–		E3H2-T2C1S-M5	E3H2-T2B1S-M5

Specifications

Item	Through-beam		Retro-reflective with M.S.R.	Diffuse-reflective	
	E3H2-T4	E3H2-T2	E3H2-R	E3H2-DS30	E3H2-DS10
Light source (wave length)	Infrared LED (880 nm)		Red LED (660 nm)	Infrared LED (880 nm)	
Power supply voltage	10 to 30 VDC, 10% ripple				
Protective circuits	Power supply reverse polarity protection, output short circuit protection				
Response time	2.5 ms max	1 ms max.	1.1 ms max		
Sensitivity adjustment	Potentiometer adjuster	–	Teach-in		–
Ambient temperature	Operating	–25 to 55°C	–25 to 50°C	–25 to 55°C	
Degree of protection	EN 60529: IP67				
Material	Case	nickel-plated brass	stainless steel	nickel-plated brass	
	Lens	plastic			



Miniature photoelectric sensors in M5 and M6 sized housing

The E3T-C family of miniature photoelectric sensors is the ideal solution when mounting space is crucial.

- axial and radial M5 sized through-beam sensors
- axial M6 sized diffuse-reflective sensors
- pre-wired models in stainless steel housing

Ordering information

M5 cylindrical housing

Sensor type	Sensing distance	Connection method				Operation mode	Order code	
							NPN output	PNP output
Through-beam (axial) 	1 m	–	–	2 m	–	dark on	E3T-CT12 2M	E3T-CT14 2M
Through-beam (radial) 	500 mm	–	–	2 m	–		E3T-CT22S 2M	E3T-CT24S 2M

M6 cylindrical housing

Sensor type	Sensing distance	Connection method				Operation mode	Order code	
							NPN output	PNP output
Diffuse-reflective 	50 mm (adjustable)	–	–	2 m	–	light on	E3T-CD11 2M	E3T-CD13 2M

Specifications

Item	E3T-CT1_	E3T-CT2_	E3T-CD1_
Light source (wave length)	Red LED (630 nm)	Red LED (625 nm)	Infrared LED (870 nm)
Power supply voltage	12 to 24 VDC±10%, ripple (p-p) 10% max.		
Protective circuits	Power supply reverse polarity protection, Output short-circuit protection		
Response time	0.5 ms max.		
Ambient temperature	Operating	–25 to 55°C	
	Storage	–30 to 70°C (with no icing or condensation)	
Degree of protection	IEC 60529 IP65		
Material	Case	SUS303	
	Display window	Polysulfone Epoxy	
	Lens	Polysulfone	



Photoelectric sensor in miniature plastic housing

Small sized photoelectric sensors in flat and side view shape for demanding mounting conditions.

- Small size with precision pinpoint LED where space is crucial
- 3.5 mm flat model with reliable background suppression and small black/white error
- Unique optical alignment technology ensuring minimal deviation of optical axis
- High EMC and ambient light immunity

Ordering information

Sensor type	Sensing distance	Connection method				Operation mode	Mounting screw size	Order code*1		
								NPN output	PNP output	
Through-beam 	2 m	—	—	2 m	For ordering pigtail versions replace '2M' of cable types with: - M1J: M12 with 30 cm cable - M3J: M8 4-pin with 30 cm cable - M5J: M8 3-pin with 30 cm cable	Light-ON	M2	E3T-ST31 2M	E3T-ST33 2M	
	1 m	—	—	2 m		Dark-ON	M2	E3T-ST32 2M	E3T-ST34 2M	
						Light-ON	M2	E3T-ST11 2M	E3T-ST13 2M	
	300 mm	—	—	2 m		Dark-ON	M2	E3T-ST12 2M	E3T-ST14 2M	
						M3	E3T-ST11M 2M	E3T-ST13M 2M		
	500 mm	300 mm	—	—		2 m	Light-ON	M2	E3T-ST21 2M	E3T-ST23 2M
							Dark-ON	M2	E3T-ST22 2M	E3T-ST24 2M
	300 mm	—	—	—		2 m	M3	E3T-ST21M 2M	E3T-ST23M 2M	
							M3	E3T-ST22M 2M	E3T-ST24M 2M	
	Retro-reflective 	30 to 200 mm*2	—	—		2 m	Light-ON	M2	E3T-ST11 2M	E3T-ST13 2M
		10 to 100 mm*2					Dark-ON	M2	E3T-ST12 2M	E3T-ST14 2M
	Diffuse-reflective 	5 to 30 mm	—	—		2 m	Light-ON	M2	E3T-ST21 2M	E3T-ST23 2M
5 to 15 mm		Dark-ON					M2	E3T-ST22 2M	E3T-ST24 2M	
Limited-reflective 	5 to 15 mm	—	—	2 m		M3	E3T-ST21M 2M	E3T-ST23M 2M		
	5 to 30 mm					M3	E3T-ST22M 2M	E3T-ST24M 2M		
Diffuse-reflective (background suppression) 	1 to 15 mm	—	—	2 m		Light-ON	M2	E3T-ST11 2M	E3T-ST13 2M	
	1 to 30 mm					Dark-ON	M2	E3T-ST12 2M	E3T-ST14 2M	
Through-beam 	500 mm	—	—	2 m		Light-ON	M2	E3T-ST11 2M	E3T-ST13 2M	
						Dark-ON	M2	E3T-ST12 2M	E3T-ST14 2M	
	300 mm	—	—	—		2 m	Light-ON	M2	E3T-ST21 2M	E3T-ST23 2M
							Dark-ON	M2	E3T-ST22 2M	E3T-ST24 2M
	30 to 200 mm*2	on reflectors/ 10 to 100 mm*2 on reflective foils	—	—		2 m	Light-ON	M2	E3T-ST41-C 2M*3	E3T-ST43-C 2M*3
							Dark-ON	M2	E3T-ST42-C 2M*3	E3T-ST44-C 2M*3
	5 to 30 mm	—	—	—		2 m	Light-ON	M2	E3T-FD11 2M	E3T-FD13 2M
					Dark-ON		M2	E3T-FD12 2M	E3T-FD14 2M	
	5 to 15 mm	—	—	—	2 m	M3	E3T-FD11M 2M	E3T-FD13M 2M		
						M3	E3T-FD12M 2M	E3T-FD14M 2M		
	5 to 30 mm	—	—	—	2 m	Light-ON	M2	E3T-SL11 2M	E3T-SL13 2M	
						Dark-ON	M2	E3T-SL12 2M	E3T-SL14 2M	
1 to 15 mm	—	—	—	2 m	M3	E3T-SL11M 2M	E3T-SL13M 2M			
					M3	E3T-SL12M 2M	E3T-SL14M 2M			
1 to 30 mm	—	—	—	2 m	Light-ON	M2	E3T-SL21 2M	E3T-SL23 2M		
					Dark-ON	M2	E3T-SL22 2M	E3T-SL24 2M		
1 to 30 mm	—	—	—	2 m	M3	E3T-SL21M 2M	E3T-SL23M 2M			
					M3	E3T-SL22M 2M	E3T-SL24M 2M			
1 to 15 mm	—	—	—	2 m	Light-ON	M2	E3T-FL11 2M	E3T-FL13 2M		
					Dark-ON	M2	E3T-FL12 2M	E3T-FL14 2M		
1 to 30 mm	—	—	—	2 m	Light-ON	M2	E3T-FL21 2M	E3T-FL23 2M		
					Dark-ON	M2	E3T-FL22 2M	E3T-FL24 2M		

*1 For pre-wired models with robotic cables add '-R' to the order code (example: E3T-FT21R 2M)
 *2 The distances are measured with reflector E39-R4 and reflective foil E39-R37-CA. For applications with shorter distances between the sensor and the reflector contact your OMRON representative.
 *3 Order reflector separately. Models with included reflectors are available.

Specifications

Item	Through-beam		Retro-reflective
	Side-view	Flat	Side-view
	E3T-ST1 E3T-ST2 E3T-ST3	E3T-FT1 E3T-FT2	E3T-SR4
Sensing distance	E3T-ST3 : 2 m E3T-ST1 : 1 m E3T-ST2 : 300 mm	E3T-FT1 : 500 mm E3T-FT2 : 300 mm	30 to 200 mm (with E39-R4) 10 to 100 mm (with E39-R37-CA)
Light source (wave length)	Red LED ("Pin-point" LED) $\lambda = 650$ nm		
Power supply voltage	12 to 24 VDC \pm 10%, ripple (p-p) 10% max.		
Protective circuits	Power supply and control output reverse polarity protection Output short-circuit protection		Power supply and control output reverse polarity protection Output short-circuit protection, mutual interference prevention, surge suppressor
Response time	1 ms max.		
Ambient temperature	Operating	-25 to 55°C (with no icing or condensation)	
	Storage	-40 to 70°C (with no icing or condensation)	
Degree of protection	IEC60529 IP67		
Material	Case	PBT (polybutylene terephthalate)	
	Display window	Denatured polyarylate	
	Lens	Denatured polyarylate	Methacrylic resin

Item	Diffuse-reflective	Limited-reflective		Diffuse-reflective (background suppression)	
	Flat	Side-view	Flat	Flat	Flat
	E3T-FD1	E3T-SL1	E3T-SL2	E3T-FL1	E3T-FL2
Sensing distance	5 to 30 mm	5 to 15 mm	5 to 30 mm	1 to 15 mm	1 to 30 mm
Black/white error	-			15% max.	
Light source (wave length)	Red LED ("Pin-point" LED) $\lambda = 650$ nm				
Power supply voltage	12 to 24 VDC \pm 10%, ripple (p-p) 10% max.				
Protective circuits	Power supply and control output reverse polarity protection Output short-circuit protection, Mutual interference prevention				
Response time	1 ms max.				
Ambient temperature	Operating	-25 to 55°C			
	Storage	-40 to 70°C (with no icing or condensation)			
Degree of protection	IEC60529 IP67				
Material	Case	PBT (polybutylene terephthalate)			
	Display window	Denatured polyarylate			
	Lens	Denatured polyarylate			

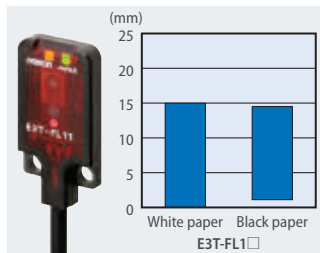

Minimal black / white error



The coaxial optics and the small focal lens of the retro-reflective models allow the detection of small (dia 2 mm) objects or through small holes (dia 2 mm).

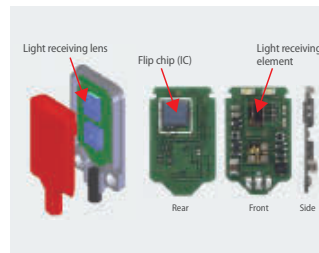

The unique light receiving lens shape and the chip mounting technology, provide appropriate sensing distances for very precise and reliable detection even through smallest slits and gaps with e.g. 0.5 mm dia.



Models with mounting holes for M2 or M3 screws

Photo microsensor in plastic fork shape housing



Standard photo microsensors with 50 to 100 mA direct switching capacity for best value-performance ratio to detect machine parts or end positions independent of material or magnetic fields.

- Response frequency up to 1 kHz
- Wide operating voltage range: 5 to 24 VDC

Ordering information

Connector models

Sensor type	Sensing distance	Connection method	Operation Mode	Shape ^{*1}	Order code ^{*2}	
					NPN output	PNP output
Through-beam with slot	5 mm (slot width) (Infrared light)	Connector (4 pin) ^{*3}	Dark-ON/Light-ON (selectable)	Standard	EE-SX670	EE-SX670P
				L-shaped	EE-SX671	EE-SX671P
				T-shaped, 7 mm	EE-SX672	EE-SX672P
				Close-mounting	EE-SX673	EE-SX673P
				Close-mounting	EE-SX674	EE-SX674P
				T-shaped, 10 mm	EE-SX675	EE-SX675P
				F-shaped	EE-SX676	EE-SX676P
				R-shaped	EE-SX677	EESX-677P

^{*1} For shape dimensions refer to datasheet on www.industrial.omron.eu
^{*2} For pre-wired models with 1 m cable add '-WR' to order reference (e.g. EE-SX670-WR)
^{*3} Order connector separately from accessories

Specifications

Item		Through-beam							
		Standard	L-shaped	T-shaped, slot center: 7 mm	Close-mounting		T-shaped, slot center: 10 mm	F-shaped	R-shaped
	NPN	EE-SX670	EE-SX671	EE-SX672	EE-SX673	EE-SX674	EE-SX675	EE-SX676	EE-SX677
	PNP	EE-SX670P	EE-SX671P	EE-SX672P	EE-SX673P	EE-SX674P	EE-SX675P	EE-SX676P	EE-SX677P
Sensing distance		5 mm (slot width)							
Power supply voltage		5 to 24 VDC ±10%, ripple (p-p): 10% max.							
Response frequency		1 kHz min. (3 kHz average)							
Ambient temperature		Operating: -25 to 55°C, Storage: -30 to 80°C							
Degree of protection		IEC60529 IP50							
Material	Case	PBT (polybutylene terephthalate)							
	Lens	Polycarbonate							

Accessories (order separately)

Type	Cable length	Material	Order code
Connector with Cable	2 m	PVC	EE-1010 2M
Connector with Robot Cable	2 m	PVC	EE-1010R 2M

Note: For mechanical limit switches see page 304

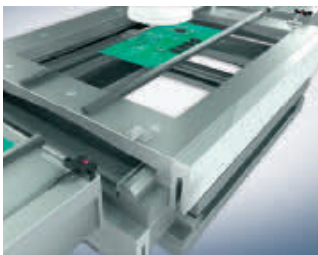

Easy to mount end position detection/limit sensors (contactless).



Photoelectric sensor in 25 mm plastic fork shape housing

The forked shape optical through-beam sensors combine simple installation with reliable passage detection of object, machine parts or transportation elements like hanggliders.

- Fork shape for simple installation
- 1 or 2 axis models

Ordering information

Sensor type	Sensing distance	Number of optical axes	Connection method				Order code*1	
							NPN output	PNP output
Through-beam 	25 mm (Infrared light)	1	–	–	2 m	–	E3Z-G61 2M	E3Z-G81 2M
			–	–	–		E3Z-G61-M3J	E3Z-G81-M3J
		2	–	–	2 m	–	E3Z-G62 2M	E3Z-G822M
			–	–	–		E3Z-G62-M3J	E3Z-G82-M3J

*1 Light-ON/Dark-ON switch selectable

Specifications

Item		Through-beam
		E3Z-G
Power supply voltage		12 to 24 VDC±10% max. ripple (p-p): 10%
Protective circuits		Output short-circuit protection, and mutual interference prevention, power supply, reverse polarity protection
Response time		1 ms max.
Ambient temperature	Operating	–25 to 55°C
	Storage	–40 to 70°C (with no icing or condensation)
Degree of protection		IEC60529 IP64
Material		ABS



Oil-resistant photoelectric sensor in compact stainless steel housing

The oil-resistant compact photoelectric sensor in a robust stainless steel housing features an enhanced functional reserve for reliable object detection in dirty and mechanically demanding environments such as automotive assembly lines.

- Oil-resistant stainless steel housing
- IP67 and IP69k for highest water resistance
- High visibility orange LED in through-beam model for easy alignment

Ordering information

Sensor type	Sensing distance	Connection method				Order code*1	
						NPN output	PNP output
Through-beam 	15 m (Infrared light)	–	–	2 m	–	E3ZM-CT61 2M	E3ZM-CT81 2M
		–	–	–	■*2	E3ZM-CT61-M1TJ	E3ZM-CT81-M1TJ
		■	–	–	–	E3ZM-CT66	E3ZM-CT86
	20 m (Orange light)	–	–	2 m	–	E3ZM-CT62B 2M	E3ZM-CT82B 2M
		–	–	–	■*2	E3ZM-CT62B-M1TJ	E3ZM-CT82B-M1TJ
		■	–	–	–	E3ZM-CT67B	E3ZM-CT87B
Retro-reflective with M.S.R. 	0.1 to 4m*3	–	–	2 m	–	E3ZM-CR61 2M	E3ZM-CR81 2M
		–	–	–	■*2	E3ZM-CR61-M1TJ	E3ZM-CR81-M1TJ
		■	–	–	–	E3ZM-CR66	E3ZM-CR86
Diffuse-reflective 	1 m (adjustable)	–	–	2 m	–	E3ZM-CD62 2M	E3ZM-CD82 2M
		–	–	–	■*2	E3ZM-CD62-M1TJ	E3ZM-CD82-M1TJ
		■	–	–	–	E3ZM-CD67	E3ZM-CD87
Diffuse-reflective (background suppression) 	10 to 100 mm (fixed)	–	–	2 m	–	E3ZM-CL61H 2M	E3ZM-CL81H 2M
		–	–	–	■*2	E3ZM-CL61H-M1TJ	E3ZM-CL81H-M1TJ
		■	–	–	–	E3ZM-CL66H	E3ZM-CL86H
	10 to 200 mm (fixed)	–	–	2 m	–	E3ZM-CL64H 2M	E3ZM-CL84H 2M
		–	–	–	■*2	E3ZM-CL64H-M1TJ	E3ZM-CL84H-M1TJ
		■	–	–	–	E3ZM-CL69H	E3ZM-CL89H

*1 Light-ON/ Dark-ON switch selectable for E3ZM-CT, E3ZM-CR and E3ZM-CD. Light-ON/ Dark-ON selectable by wire for E3ZM-CL.

*2 uses OMRON's Twist & Click M12 connector XS5.

*3 Measured with E39-R1S.

Specifications

Item	Through-beam		Retro-reflective with M.S.R.		Diffuse-reflective
	NPN	E3ZM-CT61 (-M1TJ) E3ZM-CT66	E3ZM-CT62B (-M1TJ) E3ZM-CT67B	E3ZM-CR61 (-M1TJ) E3ZM-CR66	E3ZM-CD62 (-M1TJ) E3ZM-CD67
	PNP	E3ZM-CT81 (-M1TJ) E3ZM-CT86	E3ZM-CT82B (-M1TJ) E3ZM-CT87B	E3ZM-CR81 (-M1TJ) E3ZM-CR86	E3ZM-CD82 (-M1TJ) E3ZM-CD87
Light source (wave length)	Infrared LED (870 nm)		Orange LED (615 nm)	Red LED (660 nm)	Infrared LED (860 nm)
Power supply voltage	10 to 30 VDC, including 10% ripple (p-p)				
Protective circuits	Power supply reverse polarity protection, output short-circuit protection, output reverse polarity protection		Power supply reverse polarity protection, output short-circuit protection, output reverse polarity protection, and mutual interference prevention		
Response time	1 ms max.	2 ms max.	1 ms max.		
Ambient temperature	Operating	-25 to 55°C			
	Storage	-40 to 70°C (with no icing or condensation)			
Degree of protection	IEC 60529 IP67, IP69K after DIN 40050 part 9				
Material	Case	SUS316L			
	Lens	PMMA (polymethylmethacrylate)			
	Display	PES (polyether sulfone)			
	Sensitivity adjustment and operation switch	PEEK (polyether ether ketone)			
	Seals	Fluoro rubber			

Item		Diffuse-reflective with background suppression (fixed distance)	
	NPN	E3ZM-CL61H (-M1TJ) E3ZM-CL66H	E3ZM-CL64H (-M1TJ) E3ZM-CL69H
	PNP	E3ZM-CL81H (-M1TJ) E3ZM-CL86H	E3ZM-CL84H (-M1TJ) E3ZM-CL89H
Light source (wave length)		Red LED (650 nm)	Red LED (660 nm)
Power supply voltage		10 to 30 VDC, ±10% ripple (p-p): 10% max.	
Protective circuits		Reversed power supply polarity protection, output short-circuit protection, reversed output polarity protection, mutual interference protection	
Response time		1 ms max.	
Ambient temperature	Operating	-25 to 55°C	
	Storage	-40 to 70°C (with no icing or condensation)	
Degree of protection		IEC 60529 IP67, IP69K after DIN 40050 part 9	
Material	Case	SUS316L	
	Cable	Oil-resistant vinyl cable	
	Lens	PMMA (polymethylmethacrylate)	
	Display	PES (polyethersulfone)	
	Seals	Fluoro rubber	

Oil Resistance

Test oil type	Product name	Kinetic viscosity at 40°C (mm ² /s)	pH (dilution rate)
Lubricants	Velocity Oil No. 3	2.02	-
Non-water-soluble cutting oils	Yushiron Oil No.2 AC	Less than 10	-
Water-soluble cutting oils	Yushiroken EC50T3	-	10.1 (×30)
	Yushiroken EC50T5	-	9.9 (×30)
	Yushiroken S46D	-	9.9 (×50)
	Yushiroken S50N	-	8.6 (×50)
	Yushiron Lubic HWC68	-	9.1 (×30)
	Yushiroken Synthetic #770TG	-	9.9 (×20)
	Emulcut FA-900ST	-	9.7 (×30)
	Multicool CSF-9000	-	9.7 (×20)
	Sugicut CS-68JS-1	-	9.6 (×20)
	Toyocool 3A-666	-	9.6 (×20)
	Gryton 1700	-	9.1 (×10)
Gryton 1700D	-	9.3 (×3)	

1. The Sensor was immersed in the above oils for 240 h at 55°C and then passed an insulation resistance test at 100 MΩ.
2. Use the kinetic viscosities and pHs in the above table as a guide when using the Sensor in environments containing oils not listed in the table. Additives in the oil may also affect performance. Always test applicability in advance.



Tested oil and lubricant resistance

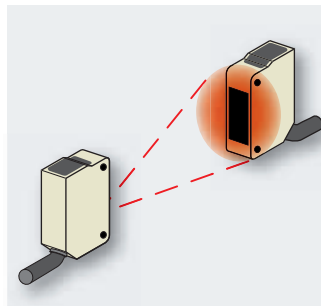

Highly visible orange LED



Transparent object detection sensor in compact stainless steel housing

The E3ZM-B family provides models for the general transparent material detection and specialized models providing highest stability for the detection of PET bottles.

- Stable PET detection using double refraction and AC³ power control technology
- Detergent resistant compact SUS316L housing

Ordering information

Sensor type		Sensing distance	Special reflector	Connection method				Order code*1	
								NPN output	PNP output
Retro-reflective with M.S.R. 	Optimised for PET bottles and trays	100 to 500 mm (teachable)	Order separately*2	–	–	2 m	–	E3ZM-B61 2M	E3ZM-B81 2M
				■	–	–	–	E3ZM-B66	E3ZM-B86
			E39-RP1 included	–	–	2 m	–	E3ZM-B61-C 2M	E3ZM-B81-C 2M
				■	–	–	–	E3ZM-B66-C	E3ZM-B86-C
Retro-reflective with M.S.R. 	For all transparent media (glass, PET, foils)	100 to 500 mm (potentiometer adjustment)*3	Order separately*4	–	–	2 m	–	E3ZM-B61T 2M	E3ZM-B81T 2M
				■	–	–	–	E3ZM-B66T	E3ZM-B86T

*1 PET optimised models are Light-ON/Dark-ON selectable by wire. E3ZM-B_T all transparent media types are Light-ON/ Dark-ON switch selectable
 *2 For higher signal stability using circular polarisation functionality for PET bottles, order special reflector E39-RP1 separately
 *3 Teachable all-transparent-media types are available. Contact your OMRON representative
 *4 Order reflector separately

Specifications

Item	PET optimised (teachable)		all-transparent-media (potentiometer adjustment)	
	NPN	E3ZM-B61(-C)/-B66(-C)	E3ZM-B6_T	E3ZM-B8_T
Light source (wave length)	Red LED (650 nm)			
Power supply voltage	10 to 30 VDC, ±10% ripple (p-p): 10% max.			
Protective circuits	Reversed power supply polarity protection, output short-circuit protection, mutual interference prevention, and reversed output polarity protection			
Response time	1 ms max.			
Ambient temperature	Operating	–40 to 60°C		–25 to 55°C
	Storage	–40 to 70°C (with no icing or condensation)		
Degree of protection	IEC 60529 IP67, IP69K after DIN 40050 part 9			
Material	Case	SUS316L		
	Lens	PMMA (polymethylmethacrylate)		
	Display	PES (polyether sulfone)		
	Seals	Fluoro rubber		
	Cable	PVC (polyvinyl chloride)		



Utilisation of double reflection effect in PET for higher detection stability (PET optimised models)

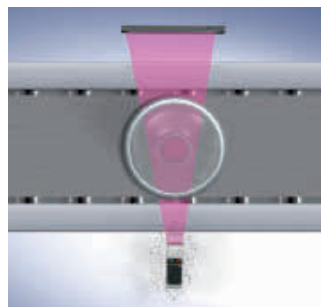

Automatic LED power adjustment (AC³) to compensate for soiling and temperature fluctuations (PET optimised models)

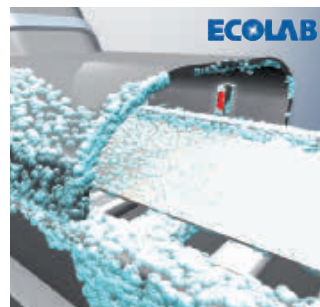

Detergent resistant

Transparent object detection photoelectric sensor in compact plastic housing

The E3Z-B provides easy adjustment for the detection of a large variety of standard transparent objects.

- Detects a wide range of bottles from single bottles to sets of stocked bottles
- IP67/IP69K tested for highest water resistance



Ordering information

Sensor type	Sensing distance	Connection method				Order code*1	
						NPN output	PNP output
Retro-reflective without M.S.R. 	80 to 500 mm*2 (adjustable)	–	–	2 m	–	E3Z-B61 2M	E3Z-B81 2M
		■	–	–	–	E3Z-B66	E3Z-B86
	0.5 to 2 m*2 (adjustable)	–	–	2 m	–	E3Z-B62 2M	E3Z-B82 2M
		■	–	–	–	E3Z-B67	E3Z-B87

*1 Light-ON / Dark-ON switch selectable

*2 Measured with E39-R15

Specifications

Item		Retro-reflective without M.S.R.	
	NPN output	E3Z-B61/E3Z-B66	E3Z-B62/E3Z-B67
	PNP output	E3Z-B81/E3Z-B86	E3Z-B82/E3Z-B87
Light source (wave length)		Red LED (680 nm)	
Power supply voltage		12 to 24 VDC±10%, ripple (p-p) : 10% max.	
Protective circuits		Reverse polarity protection, output short-circuit protection, mutual interference prevention	
Response time		1 ms max.	
Ambient temperature	Operating	–25 to 55°C	
	Storage	–40 to 70°C (with no icing or condensation)	
Degree of protection		IEC 60529 IP67, IP69K after DIN 40050 part 9	
Material	Case	PBT (polybutylene terephthalate)	
	Lens	Methacrylate resin	



Easy adjustment for the detection of a large variety of transparent objects

Transparent object detection sensor in compact M18 housing



The E3F_-B/-V provide enhanced detection stability for the detection of transparent objects. It allows an easy and intuitive adjustment to individual requirements.

- Easy adjustment to individual requirements for all transparent materials
- P-opaqing technology enables reliable detection of PET bottles also in dusty environments
- Coaxial optics (E3F_-B__1) for stable, position-independent detection



Ordering Information

Sensor type	Sensing distance	Connection method				Order code			
						E3FA (plastic housing)		E3FB (metal housing)	
						NPN output	PNP output	NPN output	PNP output
Limited distance reflective 	10 to 50 mm	-	-	2 m	-	E3FA-VN11 2M	E3FA-VP11 2M	E3FB-VN11 2M	E3FB-VP11 2M
		-	■	-	-	E3FA-VN21	E3FA-VP21	E3FB-VN21	E3FB-VP21
Coaxial retro-reflective with P-opaqing function*1 	0 to 500 mm (with E39-RP1)	-	-	2 m	-	E3FA-BN11 2M	E3FA-BP11 2M	E3FB-BN11 2M	E3FB-BP11 2M
		-	■	-	-	E3FA-BN21	E3FA-BP21	E3FB-BN21	E3FB-BP21
Retro-reflective with P-opaqing function*1 	0.1 to 2m (with E39-RP1)	-	-	2 m	-	E3FA-BN12 2M	E3FA-BP12 2M	E3FB-BN12 2M	E3FB-BP12 2M
		-	■	-	-	E3FA-BN22	E3FA-BN22	E3FB-BN22	E3FB-BN22

*1 The Reflector is sold separately. Select the Reflector model most suited to the application. For PET detection E39-RP1 is recommended for best detection stability.

Ratings and Specifications

Model	Sensing method		Limited distance reflective	Retro-reflective with P-opaqing function	
	NPN output	Pre-wired M12 Connector	E3F_-VN11 2M E3F_-VN21	E3F_-BN11 2M E3F_-BN21	E3F_-BN12 2M E3F_-BN22
Item	PNP output		E3F_-VP11 2M E3F_-VP21	E3F_-BP11 2M E3F_-BP21	E3F_-BP12 2M E3F_-BP22
	Sensing distance		10 to 50 mm		0 to 500 mm (coaxial)
Light source (wavelength)		Red LED (624 nm)			
Power supply voltage		10 to 30 VDC (include voltage ripple of 10%(p-p) max.)			
Operation mode		Light-ON/Dark-ON selectable by wiring			
Sensitivity adjustment		One-turn adjuster			
Protection circuits		Reversed power supply polarity protection, Output short-circuit protection and Reversed output polarity protection			
Response time		0.5 ms			
Ambient temperature		Operating		-25 to 55°C	
		Storage		-30 to 70°C (with no icing or condensation)	
Degree of protection		IEC: IP67, DIN 40050-9: IP69K			
Material		Case and Nut		E3FA: ABS, E3FB: Nickel brass	
		Lens and Display		PMMA	

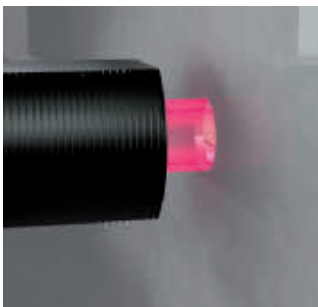

Coaxial optics (E3F_-B) for detection through small holes

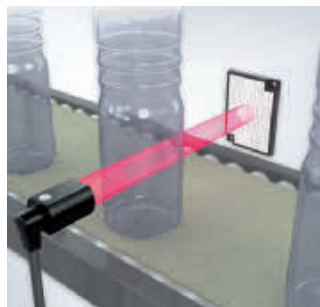

Reliable detection of PET bottles by unique p-opaqing technology



Limited-reflective types suitable for detecting transparent film to shiny, mirror film.

Transparent object sensor

E3S-DB sensor provides most reliable detection of all kinds of transparent objects such as PET bottles, glass bottles or transparent trays.

- Most reliable detection of all transparent objects
- SmartTeach enabling fast set up and optimum threshold setting
- Narrow beam types detecting smallest object gaps (min. 3 mm)
- Proven for environments in Food & Beverage industry



Ordering information

Sensor type			Sensing distance recommended (max.)	Connection method				Order code*1	
								NPN output	PNP output
Retro-reflective with MSR function 	Smart teach	Standard	3.5 m (4.5 m)*2	-	-	■	-	E3S-DBN11 2M	E3S-DBP11 2M
				-	■	-	-	E3S-DBN21	E3S-DBP21
		Narrow beam*3	0.5 m (0.7 m)*4	-	-	-	■	E3S-DBN31	E3S-DBP31
				-	■	-	-	E3S-DBN12 2M	E3S-DBP12 2M
	Trimmer	Standard	3.5 m (4.5 m)*2	-	-	■	-	E3S-DBN22	E3S-DBP22
				-	■	-	-	E3S-DBN32	E3S-DBP32
		Narrow beam*3	0.5 m (0.7 m)*4	-	-	■	-	E3S-DBN11T 2M	E3S-DBP11T 2M
				-	■	-	-	E3S-DBN21T	E3S-DBP21T
-	-	■	-	E3S-DBN31T	E3S-DBP31T				
-	■	-	-	E3S-DBN12T 2M	E3S-DBP12T 2M				
-	■	-	-	E3S-DBN22T	E3S-DBP22T				
-	-	■	-	E3S-DBN32T	E3S-DBP32T				

*1 Please order reflector separately.
 *2 Rated with E39-R8
 *3 For narrow beam type please use micro-triple reflector (e.g. E39-R21)
 *4 Rated with E39-R21

Specifications

Item	Sensing method		Retro-reflective with MSR function			
	NPN output	E3S-DBN_1	E3S-DBN_1T	E3S-DBN_2	E3S-DBN_2T	
Sensing distance, typ. max		0 to 4.5 m (with E39-R8)		0 to 700 mm (with E39-R21)		
Sensing distance, recommended		0 to 3.5 m (with E39-R8)		0 to 500 mm (with E39-R21)		
Light source (wavelength)	Red LED (624 nm)					
Power supply voltage	10 to 30 VDC, including 10% ripple (p-p)					
Operating modes	OUT1: L-ON/OUT2: D-ON (antivalent output)					
Protection circuits	Reversed power supply polarity protection, Output short-circuit protection, Reversed output polarity protection, Missconnection protection, Mutual interference suppression					
Response time	0.5 ms					
Sensitivity adjustment	SmartTeach	11-turn trimmer		SmartTeach	11-turn trimmer	
Degree of protection	IEC: IP67, DIN 40050-9: IP69K					
Connection method	Pre-wired cable (standard length: 2 m) or M12 4-pin connector or Pigtail (0.3 m/M12 4-pin)					
Indicators	Light indicator (orange), Stability indicator (green)					



SmartTeach providing fast & easy setting of optimum thresholds



Narrow beam models for detecting gaps down to 3 mm



PC Tool enables detailed identification of object attenuation level and optimizing sensor set up



Auto-compensation-control for contamination keeps light level stable in harsh environments





High precision laser sensor with separate amplifier

The separate amplifier laser sensors feature a comprehensive range of sensing heads with variable spot and advanced CMOS sensing heads for high precision positioning and demanding applications.

- High detection stability independent from color or surface structure
- Lens attachments for line beam applications
- Easy installation due to adjustable focus and smart tune functions
- Sensor heads with up to 1.2 m sensing distance covering a wide range of applications
- High speed network connectivity to EtherCat fieldbus

Ordering information

Sensor heads E3NC-L Sensor Series

Sensor type	Sensing distance	Remarks	Order code
Diffuse-reflective 	1,200 mm	Variable spot (diffuse reflective)	E3NC-LH02 2M
	70±15 mm	Fixed spot (limited reflective)	E3NC-LH01 2M
Coaxial retro-reflective with M.S.R. 	8 m ^{*1}	Fixed spot	E3NC-LH03 2M

*1 A Reflector is not included. Purchase a Reflector separately.

Sensor heads E3NC-S CMOS Laser Sensor Series

Sensor type	Sensing distance	Laser class	Order code
Diffuse-reflective (distance-settable) 	35 to 100 mm	1	E3NC-SH100 2M
	35 to 250 mm	1	E3NC-SH250 2M
	35 to 250 mm	2	E3NC-SH250H 2M

Amplifier units E3NC-L Sensor Series

Item	Order code					
	pre-wired		with connector ^{*1}		M8 connector	
	NPN output	PNP output	NPN output	PNP output	NPN output	PNP output
2 outputs + 1 input models	E3NC-LA21 2M	E3NC-LA51 2M	–	–	–	–
1 output + 1 input models	–	–	E3NC-LA7	E3NC-LA9	E3NC-LA24	E3NC-LA54
Networking model ^{*2}	E3NC-LA0					

*1 Order connector (E3X-CN21_) separately from accessories

*2 For network connection please order networking unit E3NW



Amplifier units E3NC-S CMOS Laser Sensor Series

Item	Order code					
	pre-wired		with connector ^{*1}		M8 connector	
	NPN output	PNP output	NPN output	PNP output	NPN output	PNP output
2 outputs + 1 input models	E3NC-SA21 2M	E3NC-SA51 2M	–	–	–	–
1 output + 1 input models	–	–	E3NC-SA7	E3NC-SA9	E3NC-SA24	E3NC-SA54
Networking model ^{*2}	E3NC-SA0					



*1 Order connector (E3X-CN21_) separately from accessories

*2 For network connection please order networking unit E3NW





Amplifier connectors

Shape	Type	Comment	Order code
	Amplifier connector	2 m PVC cable	E3X-CN21
		30 cm PVC cable with M12 plug connector (4 pin)	E3X-CN21-M1J 0.3M
		30 cm PVC cable with M8 plug connector (4 pin)	E3X-CN21-M3J-2 0.3M



Communication units

Shape	Communications method	Applicable Amplifier Units	Order code
	Sensor communication unit for EtherCAT	E3NX-FA0 E3NC-LA0 E3NC-SA0	E3NW-ECT
	Sensor dispersion (slave) unit		E3NW-DS





Reflectors

Appearance	Type	Size	Applicable sensor	Order code
	Micro-triple reflector	30 × 35 mm	E3NC-LH03	E39-R21
	Micro-triple reflector	55 × 40 mm		E39-R22
	Micro-triple reflector self-adhesive	25 × 25 mm		E39-RS10
	Micro-triple reflector self-adhesive	50 × 50 mm		E39-RS11

Lens Attachments for Sensor Heads

Appearance	Comment	Applicable sensor	Order code
	Lens attachment to a create line beam	E3NC-LH03	E39-P51
	Lens attachment to a create line beam	E3NC-LH02	E39-P52

Mounting Brackets for Sensor Heads

Appearance	Type	Applicable sensor	Order code
	L-shape mounting bracket	E3NC-LH03	E39-L190
	L-shape mounting bracket	E3NC-LH02	E39-L185
	L-shape mounting bracket	E3NC-LH01	E39-L186
	L-shape mounting bracket	E3NC-SH250 E3NC-SH250 E3NC-SH100	E39-L187
	L-shape mounting bracket		E39-L188

Specifications

Sensor heads E3NC-L Sensor Series

Item	Coaxial Retro-reflective (M.S.R.)	Diffuse-reflective	
	E3NC-LH03	E3NC-LH02	E3NC-LH01
Light source (emission wave length)	Red laser diode (660 nm), 315 µW max. (JIS Class 1, IEC/EN Class 1, and FDA Class 1)		
Sensing distance	Giga-power mode (GIGA): 8 m Standard mode (Std): 6 m High-speed mode (HS): 3.5 m Super-high-speed mode (SHS): 2 m	Giga-power mode (GIGA): 1,200 mm Standard mode (Std): 750 mm High-speed mode (HS): 250 mm Super-high-speed mode (SHS): 200 mm	70±15 mm
Beam size (typical)	2 mm dia. (at 1 m)	0.8 mm max. (at distances up to 300 mm)	0.1 mm (at 70 mm)
Degree of protection	IP67	IP65	

Amplifier units E3NC-L Sensor Series

Item	2 output/1 input models		1 output/1 input models	Networking models
	NPN output	E3NC-LA21	E3NC-LA7/E3NC-LA24	
	PNP output	E3NC-LA51	E3NC-LA9/E3NC-LA54	
Outputs	2 outputs		1 output	—*
Inputs	1 input			—*
Supply voltage	10 to 30 VDC±10%, ripple (p-p) 10% max.			
Response time	Super-high-speed mode	80 µs		
	High-speed mode	250 µs		
	Standard mode	1 ms		
	Giga-power mode	16 ms		
Functions	Smart tuning	2-point tuning, full auto tuning, position tuning, maximum sensitivity tuning, power tuning, or percentage tuning (–99% to 99%)		
	Timer function	Select from timer disabled, OFF-delay, ON-delay, one-shot, or ON-delay + OFF-delay timer: 1 to 9,999 ms		
	Eco mode	Select from OFF (digital displays lit) or ECO (digital displays not lit)		
	Bank switching	Select from banks 1 to 4		
	Dynamic Power Control (DPC)	Provided (automatically controls light intensity and compensates incident level changes)		
Ambient temperature range	Operating	–10 to 55°C		
	Storage	–25 to 70°C (with no icing or condensation)		
Digital display	7-segment displays (sub digital display: green, main digital display: white) Display direction: switchable between normal and reversed			
Degree of protection	IP50 (IEC 60529)			

* Two sensor outputs are allocated in the programmable logic controller PLC I/O table. PLC operation via Communications Unit enables reading detected values and changing settings.

Sensor heads E3NC-SH CMOS Laser Sensor series

Item	Diffuse-reflective (distance-settable)		
	E3NC-SH250H	E3NC-SH250	E3NC-SH100
Light source (emission wave length)	Red laser diode (660 nm), 1 mW (average output: 220 μ W), (JIS Class 2, IEC/EN Class 2, and FDA Class 2)	Red laser diode (660 nm), 100 μ W max. (JIS Class 1, IEC/EN Class 1, and FDA Class 1)	
Measurement range	35 to 250 mm (display value: 350 to 2,500)		35 to 100 mm (display value: 350 to 1,000)
Spot diameter	1 mm (at 250 mm)		0.5 mm (at 100 mm)
Degree of protection	IEC60529 IP67		

Amplifier units E3NC-SH CMOS Laser Sensor series

Item	2 output/1 input models		1 output/1 input models	Networking models
	NPN output	E3NC-SA21	E3NC-SA7/E3NC-SA24	E3NC-SA0
	PNP output	E3NC-SA51	E3NC-SA9/E3NC-SA54	
Outputs	2 outputs		1 output	—*
Inputs	1 input			—*
Supply voltage	10 to 30 VDC \pm 10%, ripple (p-p) 10% max.			
Response time	Super-high-speed mode	1.5 ms		
	High-speed mode	5 ms		
	Standard mode	10 ms		
	Giga-power mode	50 ms		
Functions	Smart tuning	2-point tuning, full auto tuning, 1-point tuning, tuning without workpiece, 2-point area tuning, 1-point area tuning, or area tuning without workpiece		
	Timer function	Select from timer disabled, OFF-delay, ON-delay, one-shot, or ON-delay + OFF-delay timer: 1 to 9,999 ms		
	Bank switching	Select from banks 1 to 4		
Ambient temperature range	Operating	-10 to 55°C		
	Storage	-25 to 70°C (with no icing or condensation)		
Digital display	7-segment displays (sub digital display: green, main digital display: white) Display direction: switchable between normal and reversed.			
Degree of protection	IP50 (IEC 60529)			

* Two sensor outputs are allocated in the programmable logic controller PLC I/O table. PLC operation via Communications Unit enables reading detected values and changing settings.



Integration into N-Smart platform

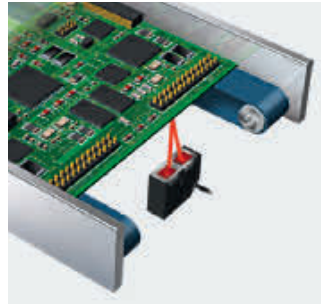

High precision positioning

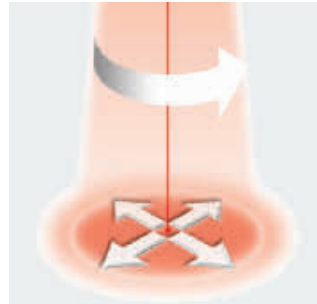

Focal point adjustment

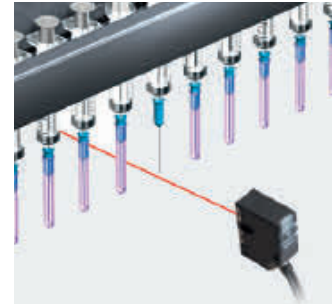

High precision detection over long range



Photoelectric sensor for structured object detection in plastic housing

The special wide beam and limited-reflective optics of the E3S-LS3 ensures reliable detection of structured objects (with holes or different heights) and can be used for example to detect printed circuit boards (PCBs).

- Wide beam and limited-reflective optics for the reliable detection of structured, shiny and irregularly shaped objects

Ordering information

Sensor type	Sensing distance	Connection method				Timer function	Output	Order code	
								Light ON	
Limited-reflective 	20 to 35 mm (Red light)	-	-	2 m	-	No	NPN	E3S-LS3N 2M	
	10 to 60 mm (Red light)	-	-	-	-	-	-	E3S-LS3NW 2M	
	20 to 35 mm	-	-	-	2 m	-	No	PNP	E3S-LS3P 2M
							Yes		E3S-LS3PT 2M
							No		E3S-LS3P-M5J
							Yes		E3S-LS3PT-M5J
							No		E3S-LS3P-M3J
							Yes		E3S-LS3PT-M3J
	10 to 60 mm	-	-	-	2 m	-	No	PNP	E3S-LS3PW 2M
							Yes		E3S-LS3PWT 2M
							No		E3S-LS3PW-M5J
							Yes		E3S-LS3PWT-M5J
No							E3S-LS3PW-M3J		
Yes							E3S-LS3PWT-M3J		

Specifications

Item		Limited-reflective E3S-LS3_
Light source (wave length)		Red LED (660 nm)
Power supply voltage		12 to 24 VDC±10%, ripple (p-p) 10% max.
Response time		1 ms max.
Timer function		Available with E3S-LS3P(W)T models only. Time range: 0.1 to 1.0 s (adjustable)
Ambient temperature	Operating	-10 to 55°C (with no icing or condensation)
	Storage	-25 to 70°C (with no icing or condensation)
Degree of protection		IEC60529 IP40
Material	Case	ABS
	Lens	Acrylic





All voltage photoelectric sensor in plastic housing with timer function

The square sized E3JM family provides 12 to 240 VDC and 24 to 240 VAC power supply voltage, an enhanced sensing distance and a timer function.

- 12 to 240 VDC and 24 to 240 VAC supply voltage
- Relay or solid state relay output
- Models with timer function

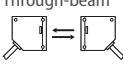
Ordering information

Sensor type	Sensing distance	Connection method	Timer function	Order code ^{*1}		
				Relay output	DC SSR output	
					minus common	plus common
Through-beam 	10 m	Terminal block (with PG 13.5)	–	E3JM-10M4-G-N	E3JM-10S4-G-N	E3JM-10R4-G-N
			ON or OFF delay 0.1 s to 5 s (adjustable)	E3JM-10M4T-G-N	E3JM-10S4T-G-N	E3JM-10R4T-G-N
Retro-reflective with M.S.R. 	4 m		–	E3JM-R4M4-G	E3JM-R4S4-G	E3JM-R4R4-G
			ON or OFF delay 0.1 s to 5 s (adjustable)	E3JM-R4M4T-G	E3JM-R4S4T-G	E3JM-R4R4T-G
Diffuse-reflective 	700 mm (adjustable)		–	E3JM-DS70M4-G	E3JM-DS70S4-G	E3JM-DS70R4-G
			ON or OFF delay 0.1 s to 5 s (adjustable)	E3JM-DS70M4T-G	E3JM-DS70S4T-G	E3JM-DS70R4T-G

*1 Light-ON / Dark-ON switch selectable

Specifications

Item	Through-beam		Retro-reflective with M.S.R.		Diffuse-reflective	
	E3JM-10	E3JM-10_T	E3JM-R	E3JM-R_T	E3JM-D	E3JM-D_T
Light source (wave length)	Infrared LED (950 nm)		Red LED (660 nm)		Infrared LED (950 nm)	
Power supply voltage	12 to 240 VDC±10% ripple (p-p) : 10% max. 24 to 240 VAC±10% 50/60 Hz					
Control output	Relay output	250 VAC, 3 A max.; 5 VDC, 10 mA min.				
	DC SSR output	48 VDC, 100 mA max.; residual voltage 2V				
Response time	Relay output	30 ms max.				
	DC SSR output	5 ms max.				
Timer function	ON/OFF delay	–	0.1 s to 5 s	–	0.1 s to 5 s	–
Ambient temperature	Operating	–25 to 55°C				
	Storage	–30 to 70°C (with no icing or condensation)				
Degree of protection	IEC60529 IP66					
Material	Case	ABS				
	Lens	Methacrylate resin				





Long distance all voltage photoelectric sensor in plastic housing

The E3G-M series offers the long sensing distance of the E3G family for all voltage (AC and DC) installations.

- 12 to 240 VDC and 24 to 240 VAC power supply
- Terminal block connection

Ordering information

Sensor type	Sensing distance	Connection method	Timer function	Order code* ¹
				Relay output
Retro-reflective with M.S.R. 	0.5 to 10 m* ² (Red light)	Terminal block (with PG 13.5 conduit)	–	E3G-MR19-G
			ON or OFF delay 0 to 5 s (adjustable)	E3G-MR19T-G
Distance-settable (background suppression) 	0.2 to 2 m (0.2 to 1.2 m distance settable)		–	E3G-ML79-G
			ON or OFF delay 0 to 5 s (adjustable)	E3G-ML79T-G

*¹ Light-ON/Dark-ON switch selectable

*² Measured with E39-R2

Specifications

Item	Retro-reflective with M.S.R.		Distance-settable (background suppression)	
	E3G-MR19-G	E3G-MR19T-G	E3G-ML79-G	E3G-ML79T-G
Light source (wave length)	Red LED (700 nm)		Infrared LED (860 nm)	
Power supply voltage	12 to 240 VDC±10% ripple (p-p): 10% max. 24 to 240 VAC±10% 50/60 Hz			
Response time	30 ms			
Timer function	–	ON delay/OFF delay 0 to 5 s (Adjuster variable system)	–	ON delay/OFF delay 0 to 5 s (Adjuster variable system)
Ambient temperature	Operating	–25 to 55°C		
	Storage	–30 to 70°C (with no icing or condensation)		
Degree of protection	IEC 60529 IP67 (with protective cover attached)			
Material	Case	PBT (polybutylene terephthalate)		
	Lens	Acrylics (PMMA)		

Reflectors for retro-reflective photoelectric sensors

Shape	Type	Housing material	Features	Size in mm	Applicable Sensor	Order code	
	General purpose reflectors	<ul style="list-style-type: none"> • ABS base • Acrylic surface 	Surface screw mounting (diagonal holes)	40 × 60 × 7.5	<ul style="list-style-type: none"> • Retro-reflective photoelectric sensors with and without M.S.R 	E39-R15	
				Surface screw mounting (holes on one side only)		35.4 × 42.3 × 8	E39-R9
						51.4 × 60.3 × 8.5	E39-R42
	Small size		Side screw mounting or surface selfadhesive	41.8 × 22.5 × 11		E39-R3	
				Surface screw mounting		23 × 13.7 × 4.9	E39-R4
	Large size			100 × 100 × 9		E39-R8	
				84.5 × 84.5 × 8.7		E39-R40	
	High precision		Microtripel for improved performance with fine beam sensors	52 × 40 × 4.8	Recommended for fine beam coaxial models (E3NC-LH03, E3S-DB, E3T-SR4)	E39-R6	
				30 × 45		E39-R12	
				14 × 23 × 1		E39-R37-CA	
				12 × 24		E39-R13	
	Simple mounting		Round shape with centered mounting hole for simple screw mounting	Diameter: 84 Depth: 7.4	Photoelectric sensors with and without M.S.R.	E39-R7	

Note: the ambient operating temperature is -25°C to 55°C unless otherwise specified









Shape	Type	Housing material	Features	Size in mm	Applicable Sensor	Order code		
	Enhanced detergent resistance	<ul style="list-style-type: none"> PVC 	<ul style="list-style-type: none"> Surface screw mounting IP69k after DIN 40050 part 9 	40 × 60 × 7.5	Recommended for harsh environment sensors	E39-R50		
				20 × 60 × 6		E39-R51		
	Highest detergent resistance	<ul style="list-style-type: none"> SUS316L Borosilicat 	<ul style="list-style-type: none"> Surface screw mounting 	43 × 30 × 5	Recommended for harsh environment sensors	E39-R16		
	Heat resistant	<ul style="list-style-type: none"> Borosilicat 	<ul style="list-style-type: none"> Surface screw mounting 450°C heat resistance Suitable for vacuum environment 	95 × 51 × 8		E39-R47		
	Non-fogging reflector	<ul style="list-style-type: none"> ABS Acrylic surface 	Anti-fogging coating	40 × 60 × 7.5		E39-R1K		
	Special polarizing	<ul style="list-style-type: none"> ABS base PMMA surface 	Special polarizing filter to PET	44 × 80 × 8.5		E3ZM-B, E3FA-B, E3FB-B, E3S-DB	E39-RP1	
	General purpose tape reflectors	<ul style="list-style-type: none"> Acrylic 	<ul style="list-style-type: none"> Self adhesive Pre cut 	35 × 10 × 0.6	Photoelectric sensors with and without M.S.R.	E39-RS1		
				40 × 35 × 0.6		Optimised for E3T-SR4	E39-RS1-CA	
				80 × 70 × 0.6		Optimised for E3T-SR4	E39-RS2-CA	
							E39-RS3	
							Optimised for E3T-SR4	E39-RS3-CA
						<ul style="list-style-type: none"> Self adhesive Cut-to-length, roll material 	25 mm × 5 m	E39-RS25 5 m
							25 mm × 22.8 m	E39-RS25 22.8 m
							50 mm × 5 m	E39-RS50 5 m
							50 mm × 22.8 m	E39-RS50 22.8 m
				High precision tape reflectors			<ul style="list-style-type: none"> Self adhesive Pre cut 	195 × 22
	108 × 46	E39-RS5						

Note: Note: the ambient operating temperature is -25°C to 55°C unless otherwise specified

Mounting brackets

Shape	Type	Material	Features	Order code	
	M8 nuts	brass	100 pcs	ASMM0800	
		stainless steel		ASMM0801	
	M12 nuts	brass	1 pc	ASMM1200	
	M18 nuts	brass		ASMM1800	
		stainless steel		ASMM1802	
	plastic	ASMK1802 (8 mm thickness)			
		100 pcs	ASMK1801 (4 mm thickness)		
	M30 nuts	brass	100 pcs	ASMM3000	
		M8 Washer	brass	1,000 pcs	ASZA0800
		M12 Washer	brass		ASZA1200
stainless steel			500pcs	ASZA1201	
M18 Washer		brass	100 pcs	ASZA1801	
		stainless steel	200 pcs	ASZA1802	
M30 Washer		brass	100 pcs	ASZA3001	

Mounting brackets

Shape	Type	Order code
	Quick access – snap fix for cylindrical sensors; sizes M8, M12, M18, M30	Y92E-BC08 Y92E-BC12 Y92E-BC18 Y92E-BC30
	Surface mounting for M18 cylindrical sensors (dia 18mm)	E39-L183
	Standard-surface mounting (for pre-wired or pigtail models)	E39-L104 ^{*1}
	Standard-backwall mounting	E39-L44 ^{*1}
	Protection-wall mounting (for pre-wired or pigtail models)	E39-L142 ^{*1}
	Protection-surface mounting	E39-L98 ^{*1}
	Telescope mounting	E39-L93FH
	3D rotation mounting	E39-EL4

^{*1} The order references are examples for the E3Z sensor family. Refer to the sensor accessory datasheet E26E for the complete list of mounting brackets.

FAST ADAPTION TO CHANGING PACKAGINGS



Choose the performance you need

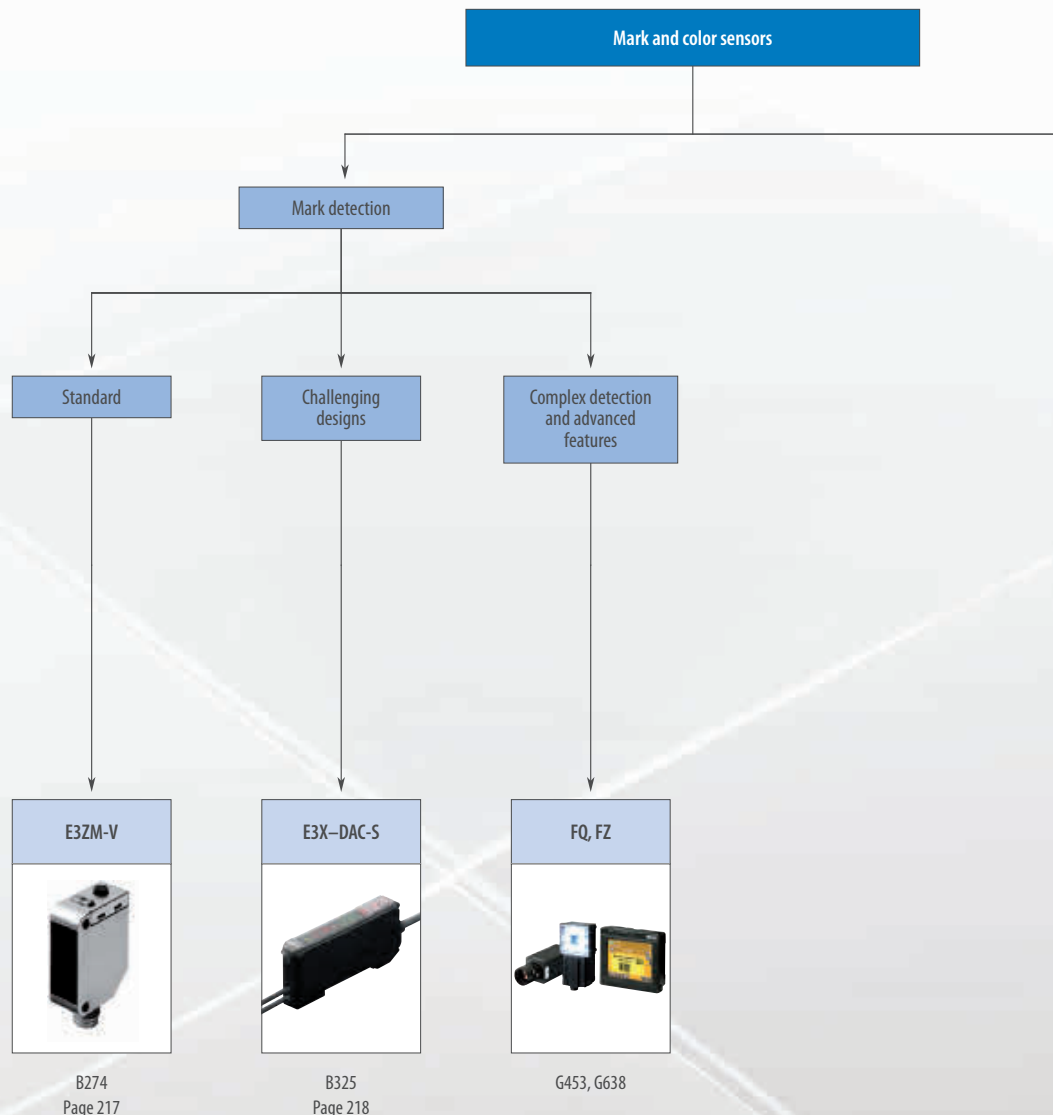

Packaging machines have to adapt quickly to a large variety of different packaging designs with minimal change-over time and no quality loss. For sensors detecting registration marks or colors this requires flexibility and simplicity in handling while keeping the precision and operational stability. At OMRON we closely work together with leading packaging machine makers to evaluate the requirements for sensors from commonly used packaging material as well as most critical designs or materials. Our portfolio is set up to balance the performance and budget requirements in these situations ... simply choose the performance you need.

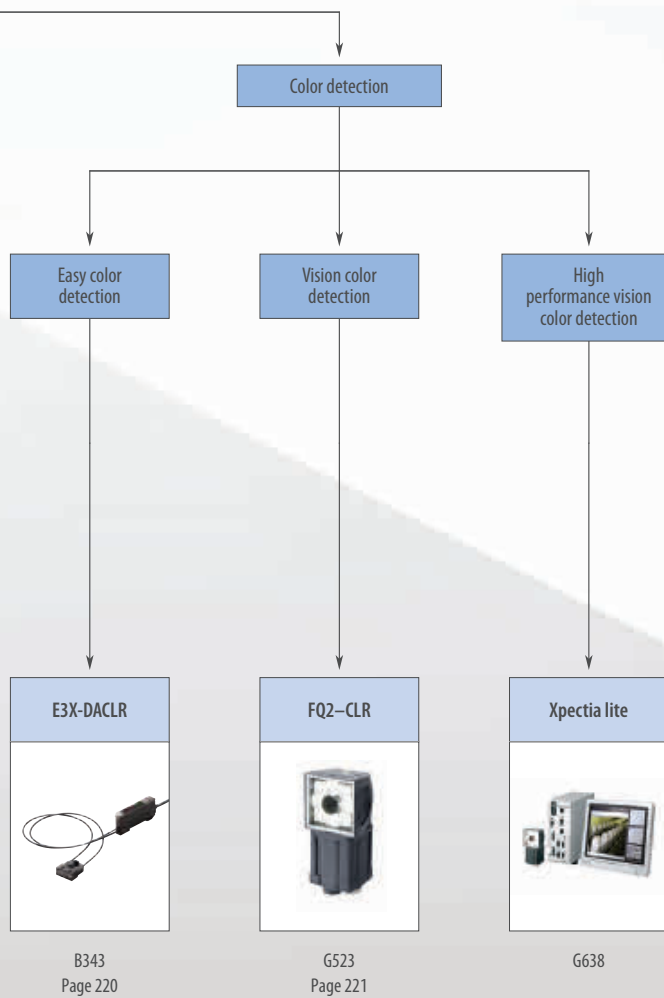
- Reliable mark detection even in changing environmental conditions during machine operation
- Fast and easy setup up after packaging material exchange
- Performance levels fitting the machine value concept





Type	Standard print mark detection	Challenging designs	Complex detection and advanced features
			
Model	E3ZM-V	E3X-DAC-S	FQ, FZ
Key feature	White LED, stainless steel housing	White LED, RGB ratio comparison and extended functionality	High performance vision inspection functionality
Detection distance	12±2 mm	5–50 mm	See QUALITY CONTROL AND INSPECTION GUIDE
Response time	50 µs	60 µs	
Page/Quick Link	217	218	

Type	Easy color detection	Vision color detection	High performace vision color detection
			
Model	E3X-DACL	FQ2-CLR	Xpectia lite
Key feature	Easy one-button teach operation		
No of simultaneous color inspections	1 to 4	1 to 32	1 to 128
Output	Color detected – digital out	■	■
	RGB value out (via ethernet)	–	■
	HSI value out (via ethernet)	–	■
Tolerance adjustment	Auto tolerance	■	–
	Teachable	■	■
	Manually adjustable	–	■
	Advanced	–	■
Page/Quick Link	220	221	See QUALITY CONTROL AND INSPECTION GUIDE



Registration mark sensor in compact stainless steel housing

The registration mark detection sensor in a compact stainless steel housing provides reliable detection of all common registration marks in food packaging applications.

- White LED for stable detection of differently colored or black print marks
- SUS 316L stainless steel housing
- Easy-to-use teach-in button or remote teach
- Fast response time of 50 μ s

Ordering information

Sensor type	Sensing distance	Connection method				Order code*1	
						NPN output	PNP output
Mark sensor 	12 \pm 2 mm	–	–	2 m	–	E3ZM-V61 2M	E3ZM-V81 2M
			–	–	–	–	E3ZM-V66

*1 The output configuration (ON or OFF when mark is detected) is teachable. Common operation is output is ON when mark is detected.

Specifications

Item	NPN	E3ZM-V6_
	PNP	E3ZM-V8_
Light source (wave length)	White LED (450 to 700 nm)	
Power supply voltage	10 to 30 VDC \pm 10%, ripple (p-p) 10% max.	
Protective circuits	Reversed power supply polarity protection, output short-circuit protection, Reversed output polarity protection, and mutual interference prevention	
Ambient temperature	Operating	–25 to 55°C
	Storage	–40 to 70°C (with no icing or condensation)
Response time	50 μ s	
Degree of protection	IEC: IP67, DIN 40050-9: IP69K	
Material	Case	SUS316L
	Lens	PMMA (polymethylmethacrylate)
	Display	PES (polyether sulfone)
	Sensitivity adjustment and operation switch	PEEK (polyether ether ketone)
	Seals	Fluoro rubber

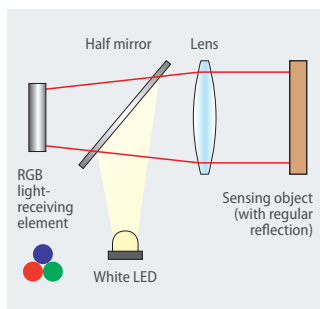

Coaxial optical system with white LED



Remote teaching

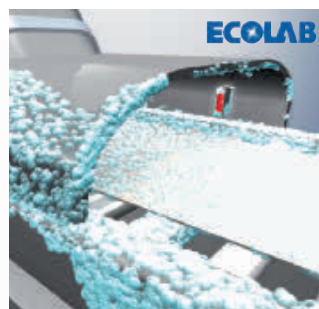

Detergent resistant



Reliable detection of standard or semi-transparent marks at normal or high speed



E3X-DAC-S high functionality mark detection sensor

The E3X-DAC-S provides reliable mark detection for standard as well as challenging applications. The separate sensing head setup allows the easy adaption to the mounting requirements even when space is crucial. The remote amplifier provides easy teaching for standard applications but also on demand full control over the detection performance for most challenging applications.

Ordering information

Pre-wired

Item	Functions	Order code (for pre-wired types with 2 m cable length)	
		NPN output	PNP output
Standard models	Timer, response speed change	E3X-DAC11-S	E3X-DAC41-S
Advanced models	Same as standard models + simultaneous determination (2 colors) AND/OR output, remote setting	E3X-DAC21-S	E3X-DAC51-S

Connector versions

Item	Functions	Order code	
		NPN output	PNP output
Standard models (fiber amplifier connector)*1	Timer, response speed change	E3X-DAC6-S	E3X-DAC8-S

*1 Order connector separately



Specifications

Item	Standard models		Advanced models
	E3X-DAC1, E3X-DAC4 E3X-DAC6, E3X-DAC8		E3X-DAC2, E3X-DAC5
Light source (wave length)	White LED (420 to 700 nm)		
Number of registered marks	1	2 (simultaneous determination)	
Power supply voltage	12 to 24 VDC±10%, ripple (p-p) 10% max.		
Protective circuits	Power supply reverse polarity protection, output short circuit protection, output reverse polarity protection, mutual interference prevention		
Ambient temperature	Operating	-25 to 55°C	
	Storage	-30 to 70°C (with no icing or condensation)	
Response time	Super-high-speed mode	Operation or reset: 60 µs	Operation or reset: 120 µs
	Standard mode	Operation or reset: 1 ms	Operation or reset: 2 ms
Sensitivity setting	Teaching (one-point teaching or teaching with/without workpiece) or manual adjustment		
Functions	Detection mode	Automode (automatic selection of C-mode or I-mode) C-mode (RGB ratio) I-mode (light intensity) Mark mode (Intensity and ratio of RGB values)	
	Operating mode	ON for match (ON for same color as registered color) or ON for mismatch (ON for different color from registered color)	
	Timer function	Timer type: OFF delay, ON delay, or one-short Timer time: 1 ms to 5 s (variable)	
	Control outputs	-	Output for each channel, AND output, and OR output
	Remote control	-	One-point teaching, teaching with/without workpiece, zero reset, and light emission OFF
Degree of protection	IEC60529 IP50 (with protective cover attached)		

Recommended fiber heads

Sensor type	Size	Recommended operating distance (mm)	Comment	Order code
	M6	5	Standard mark detection	E32-CC200 2M
	29x25.5x11.2 mm	40 to 50	Long distance – plastic	E32-L15 2M
	23x20x9 mm	25 to 30	Long distance – metal	E32-A09 2M
	M3	10	High precision mark detection (dia 1mm spot)	E32-EC31 2M + E39-EF51

Fiber amplifier connectors

Shape	Type	Comment	Order code
	Fiber amplifier connector	2 m PVC cable	E3X-CN21
		30 cm PVC cable with M12 plug connector (4 pin)	E3X-CN21-M1J 0.3M
		30 cm PVC cable with M8 plug connector (4 pin)	E3X-CN21-M3J-2 0.3M



Easy to operate detection of challenging or colored registration marks.



Detection of challenging registration marks e.g. with texts or graphics.



Easy-Teach Color Detection Sensor

The E3X-DACLR provides reliable and easy to set up one-touch color verification. Up to four colors can be identified. The separate amplifier allows mounting in easily accessible areas for operators while the small sensor head can be mounted in locations even when space is limited.

- Easy to set up one-touch color verification for 1 to 4 colors
- Model for remote teaching
- Small sensor head for easy mounting even when space is tight
- White LED and multi detection modes for reliable operation even for challenging applications

Ordering information

Type	Output	Tolerance adjustment	Connection method	Order code PNP ^{*1}
Single color detection	Digital color detected out	– Object teaching (good sample) with auto-tolerance	M8 4-pin pigtail (with 30 cm PVC cable) ^{*2}	E3X-DACLR1P-M3J 0.3M
1 to 4 color detection	Digital color detected out (with bank switching)	– 2-point teaching (good and bad sample)	2 m PVC cable	E3X-DACLR4P 2M

^{*1} NPN models are available. Contact your Omron representative.

^{*2} Models with 2 m PVC cable or M12 pigtail connector are available. Contact your Omron representative.

Specifications (amplifier and sensing head)

Item	Single color detection	1 to 4 color detection
Sensing distance	40 to 50 mm (E32-L15 sensing head)	
Light source (wave length)	White LED (420 to 700 nm)	
Number of registered marks	1	1 to 4 (2 banks switchable by external input with 2 colors each)
Power supply voltage	12 to 24 VDC±10%, ripple (p-p) 10% max.	
Protective circuits	Power supply reverse polarity protection, output short circuit protection, output reverse polarity protection, mutual interference prevention	
Ambient temperature	Operating	–25 to 55°C (amplifier) –40 to 70°C (sensing head)
	Storage	–30 to 70°C (amplifier); (without icing or condensation) –40 to 70°C (sensing head)
Response time	Super-high-speed mode	Operation or reset: 60 µs
	Standard mode	Operation or reset: 1 ms
Functions	Operating mode	ON for match (ON for same color as registered color) or ON for mismatch (ON for different color from registered color)
	Timer function	Timer type: OFF delay, ON delay, or one-short Timer time: 1 ms to 5 s (variable)
	Remote control	–
Degree of protection	IEC60529 IP50 (with protective cover attached)	



Vision Color Sensor with teachable inspection area and RGB value processing

The vision color sensor FQ2-CLR provides real color identification functionality in combination with the flexibility and functionality of a vision sensor. The teachable inspection area provides an easy and flexible set up. The color processing and evaluation can be carried out by the FQ2-CLR directly or the RGB values are available via Ethernet to other devices.

- Teachable inspection area
- Models with single color detection or up to 32 color and image processing tasks
- RGB values via Ethernet

Ordering information

Type	Output	Tolerance adjustment	Connection method	Order code PNP ^{*1}
Single color	Digital color detected out and/or RGB value out (via ethernet)	-Object teaching (good sample) with auto-tolerance -2-point teaching (good and bad sample)	3 m PVC cable or 3 m Ethernet cable ^{*2}	FQ2-CLR-V1P 3M ^{*3} FQ2-CLR-V32P 3M

^{*1} NPN models are available. Contact your Omron representative.

^{*2} I/O and Ethernet cables are included. Other cable lengths can be provided on request. Contact your Omron representative.

^{*3} Programming device 'Touch Finder FQ2-D31' is not included. Order separately incl. AC power supply and battery or use PC Tool to program FQ2-CLR.

Programming device

Type		Order code
	Touch Finder (included in FQ2-CLR-V32P) ^{*1}	FQ2-D31
	AC power supply (plug type c) for FQ2-D31	FQ-AC4
	Rechargeable battery for FQ2-D31	FQ-BAT1

^{*1} The FQ2-CLR can be programmed either with the Touch Finder or via a PC using the FQ2 PC Tool. After programming the FQ2-CLR, the programming device can be disconnected. Only one programming device is required for programming multiple FQ2-CLR. Contact your OMRON representative for FQ2-CLR-V32P version without included Touch Finder.

Specifications

Item	FQ2-CLR-V□	
Field of view	13 x 8.2 to 53 x 33 mm	
Installation distance	56 to 215 mm	
Ambient temperature	Operating	0 to 50°C
	Storage	-25 to 65°C (without icing or condensation)
Degree of protection	IEC 60529 IP67	

Lightcurtains and area sensors

PRESENCE, HEIGHT OR PROFILE ...

... choose the accuracy you need





Objects with varying positions or heights or objects with holes can create multiple signals or stay undetected when using single beam sensors. These objects (e.g. parcels, bikes or natural products like ham or fish) are then wrongly classified as multiple smaller items or are not detected correctly.

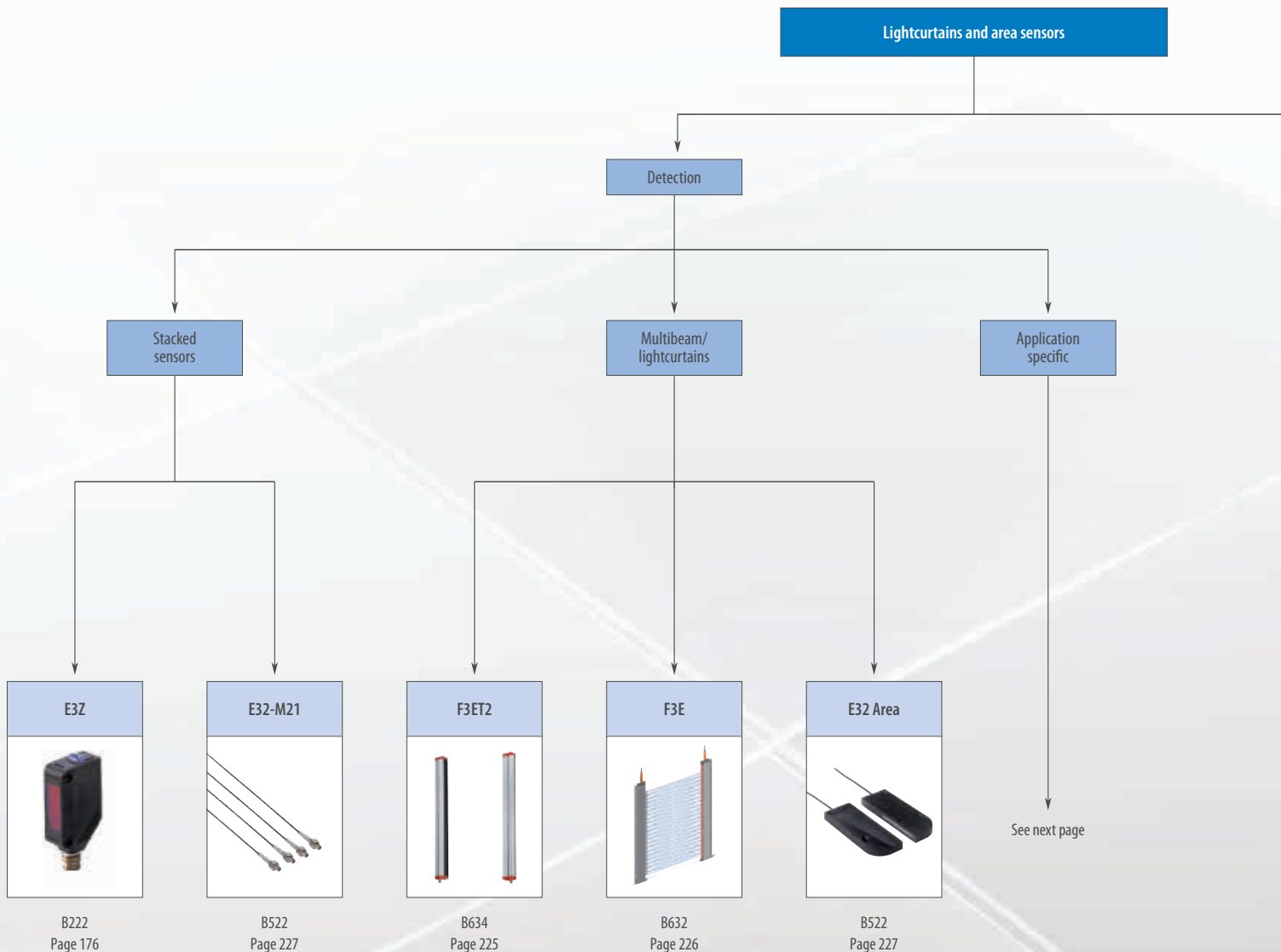

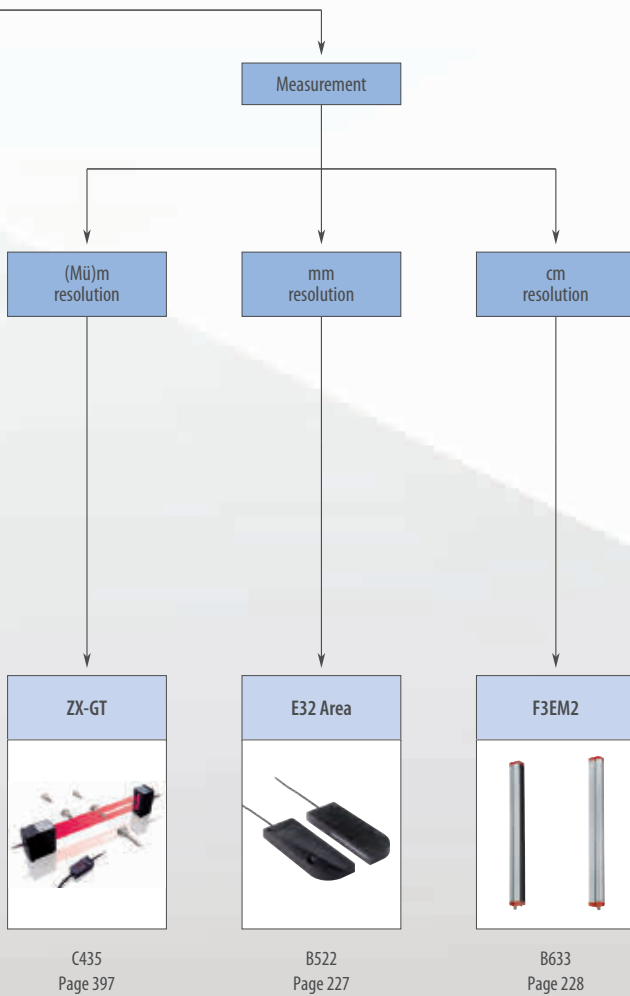
Detecting these objects over their whole length or acquiring the more detailed object profile can be realized using multiple sensors or light curtains.

Omron offers a wide range of models with varying max detection heights, different resolutions and with digital, analog or serial outputs to provide the best performance match fitting your application.

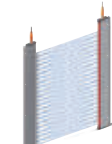

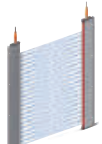

Type	Stacked sensors		Multibeam sensors/lightcurtains			Application specific lightcurtains	
							
Model	E3Z	E32-M21	F3ET2	F3E	E32 area	Safety lightcurtains	F3E Elevator lightcurtains
Key features	Mutual interference prevention	4 × M3 heads combined in one fiber	Models with 5 and 18 mm pitch	Thin aluminum housing	Teachable sensitivity	Type 2, type 4 or application specific	Fulfills EN81-70
Max. sensing distance	60 m	1.3 m	15 m	5 m	4 m	50 m	5 m
Max. detection height	n. a.	4 m	2.1 m	1.8 m	70 mm	2.4 m	1.8 m
Page/Quick Link	176	227	225	226	227	462	226

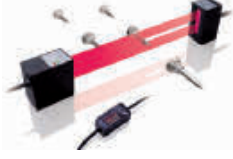
Type	Measuring lightcurtains		
			
Model	F3EM2	E32 area	ZX-GT
Key features	cm accuracy	mm accuracy	µm accuracy
Max. sensing distance	15 m	4 m	0.5 m
Max. measurement height	2.1 m	70 mm	28 mm
Page/Quick Link	228	227	397



Lightcurtain in robust aluminum housing

The F3ET2 lightcurtains provide a reliable area monitoring in a robust housing. The optical synchronisation between emitter and receiver allow a fast and simple installation without special requirements.

- Optical synchronisation for reliable operation without additional wiring
- Robust aluminum housing
- NPN/PNP and Light ON/Dark ON selectable

Ordering information

Sensor type	Detection area (mm)	Pitch	Sensing distance	Channels	Connection method				Output	Order code*1
Through-beam 	150	5 mm	3 m	30	–	5 pin	–	–	PNP/NPN	F3ET2-005-150
		18 mm	15 m	8	–		–	–		F3ET2-018-150
	300	5 mm	3 m	60	–		–	–		F3ET2-005-300
		18 mm	15 m	16	–		–	–		F3ET2-018-300
	450	5 mm	3 m	90	–		–	–		F3ET2-005-450
		18 mm	15 m	24	–		–	–		F3ET2-018-450
	600	5 mm	3 m	120	–		–	–		F3ET2-005-600
		18 mm	15 m	32	–		–	–		F3ET2-018-600
	900	5 mm	3 m	180	–		–	–		F3ET2-005-900
		18 mm	15 m	48	–		–	–		F3ET2-018-900
	1200	5 mm	3 m	240	–		–	–		F3ET2-005-1200
		18 mm	15 m	64	–		–	–		F3ET2-018-1200
	1500	5 mm	3 m	300	–		–	–		F3ET2-005-1500
		18 mm	15 m	80	–		–	–		F3ET2-018-1500
	1800	5 mm	3 m	360	–		–	–		F3ET2-005-1800
		18 mm	15 m	96	–		–	–		F3ET2-018-1800
	2100	18 mm	15 m	112	–		–	–		F3ET2-018-2100

*1 Light-ON/Dark-ON selectable

Connector cables

Type	Features	Material		Order code	
		Nut	Cable	Straight	Angled
M12	5 wires	CuZn	PVC 2 m	XS2F-M12PVC5S2M-EU	XS2F-M12PVC5A2M-EU
			PUR 2 m	XS2F-M12PUR5S2M-EU	XS2F-M12PUR5A2M-EU
			PVC 5 m	XS2F-M12PVC5S5M-EU	XS2F-M12PVC5A5M-EU
			PUR 5 m	XS2F-M12PUR5S5M-EU	XS2F-M12PUR5A5M-EU

Specifications

Item	Through-beam	
	F3ET2-005_	F3ET2-018_
Sensing distance	0 to 3 m	0 to 15 m
Vertical detection area	0 to Max _M mm; Max _M : 150, 300, 450, 600, 900, 1200, 1500, 1800*1	0 to Max _M mm; Max _M : 150, 300, 450, 600, 900, 1200, 1500, 1800, 2100
Minimum detectable object size	10 mm	30 mm
Pitch	5 mm	18 mm
Response time	4 ms + 80 μs × number of beams	
Light source (wave length)	Infrared LED (880 nm)	
Power supply voltage	24 VDC±20%	
Operating temperature	–10 to 55°C	
Degree of protection	IEC 60529 IP65	
Material	Case	Aluminum

*1 Models with different detection ranges are available in 150 mm intervals. Please contact your OMRON representative.

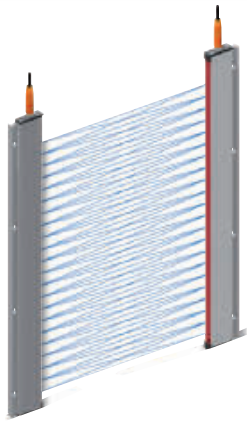

Lightcurtain in thin aluminum housing

The crossing of the multiple sensor beams provides a reliable area monitoring in a thin, easy to install housing. The thin housing makes the light curtain ideal for the installation where space is crucial.

- Thin 9 mm shape for easy design-in in elevator constructions
- High ambient light immunity
- Robust aluminum housing
- Fulfills requirements of EN81-70 (1800 mm models) for mounting in elevators

Ordering information

Sensor type	Detection area	Pitch	Sensing distance	Channels	Number of optical axis	Connection method				Order code*1 Potential free output
Through-beam 	200 mm	40 mm	5 m	6	16	–	–	5 m	–	F3E-06-T1 5M
						–	–	–	–	F3E-06-T6
	1320 mm	120 mm	12	34	–	–	5 m	–	F3E-12-T1 5M	
					–	–	–	–	F3E-12-T6	
	1800 mm	120 mm	16	46	–	–	5 m	–	F3E-16-T1 5M	
					–	–	–	–	F3E-16-T6	
	40 mm	46	136	–	–	5 m	–	F3E-46-T1 5M		
				–	–	–	–	F3E-46-T6		

*1 Light-ON/Dark-ON settable. Common operation is Dark-ON

Specifications

Item	Through-beam			
	F3E-06-T_	F3E-12-T_	F3E-16-T_	F3E-46-T_
Number of LEDs	6	12	16	46
Number of optical axes	16	34	46	136
Pitch	40 mm	120 mm	120 mm	40 mm
Vertical detection range	20 to 200 mm	20 to 1320 mm	20 to 1820 mm	
Response time	max. 110 ms (signal interruption)			
Light source (wave length)	Infrared LED (880 nm)			
Power supply voltage	10 to 30 VDC			
Ambient temperature	Operation	–20 to 60°C		
	Storage	–40 to 70°C		
EMC conformity/standards	73/23/EWG; 89/336/EWG; 95/16/EG; EN81-1; EN81-2; EN12015; EN12016; EN61000-6-x			
Degree of protection	IEC 60529 IP54			
Dimensions	400 × 40.7 × 9 mm	1590 × 40.7 × 9 mm	2070 × 40.7 × 9 mm	2000 × 40.7 × 9 mm
Material	Case Aluminum			

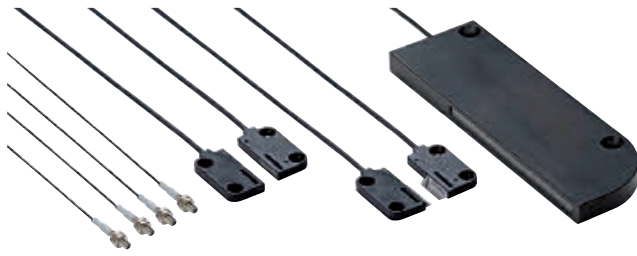

Area monitoring fiber sensor heads

When mounting space is crucial or the objects are very small, the area monitoring fibers provide a reliable object detection even when the object position varies within the monitored range.

In combination with the window monitoring function or the serial transmission of the received light level values of the fiber amplifiers, simple height comparison or measuring applications can be realized.

- Area monitoring up to 70 mm height
- Multi-beam sensor with 4 separate heads for flexible detection points
- Standard or high flex fibers

Ordering information

Sensor type	Sensing height (in mm)	Sensing distance (in mm) ^{*1}				Order code	
		Standard fiber		High-flex fiber		Standard fiber	High-flex fiber
		E3X-HD	E3NX-FA	E3X-HD	E3NX-FA		
	10	4000	4000	–	–	E32-T16	–
	11	2200	3300	1700	2550	E32-T16P	E32-T16PR 2M
	30	3600	4000	2600	3900	E32-T16W 2M	E32-T16WR 2M
	50	–	–	3000	4000	–	E32-ET16WR-2 2M
	70	–	–	3500	4000	–	E32-ET16WR-1 2M
	11	2000	3000	1500	2200	E32-T16J 2M	E32-T16JR 2M
	4 x separate M3 heads	1300	1900	–	–	E32-M21	–
	11	–	–	300	450	–	E32-D36P1 2M

*1 Sensing distance measured with Standard mode

*2 Sensing area aligned to top of housing.

Specifications

Item	Standard			High-flex			
	E32-T16	E32-M21	E32-T16J E32-T16P E32-T16W	E32-D36P1	E32-ET16WR-1 E32-ET16WR-2	E32-T16JR E32-T16PR E32-T16WR	
Permissible bending radius	R25			R4	R1		
Cut to length	Yes						
Ambient temperature	–40°C to 70°C						
Material	Head	ABS	Stainless steel	ABS	Brass-nickel plated	Aluminium	ABS
	Fiber	PMMA					
	Sheath	Polyethylene coating		PVC coating	Polyethylene coating		PVC coating
Degree of protection	IEC 60529 IP67			IEC 60529 IP50		IEC 60529 IP54	IEC 60529 IP50

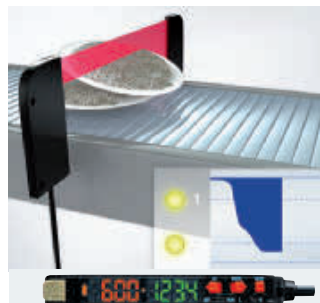
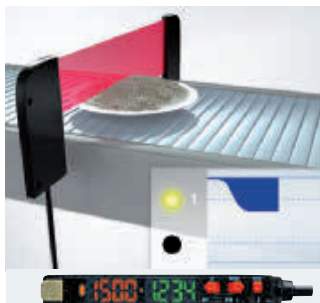

The two outputs of the E3NX-FA can be used to detect two different light levels

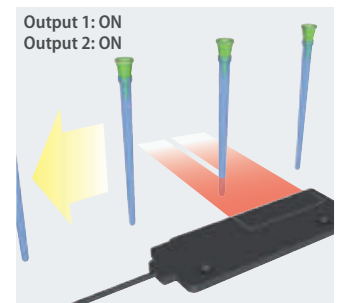
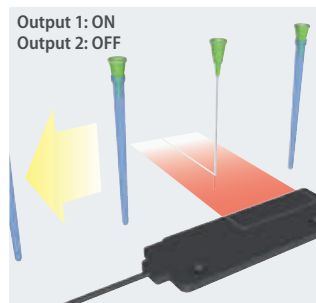

In combination with the twin output function of the E3NX-FA amplifier, the diffuse reflective area monitoring fibers can detect very small objects (e.g. needles) and a second state (e.g cover present). The area beam compensates for position variations at high speed.



Measuring lightcurtain in robust aluminum housing

The F3EM2 provides easy to install and set up height and profile measurement. The analog output provides a simple overall height detection and the serial output models provide single beam evaluation for profile measurements.

- Robust aluminum housing
- Analog output for simple height detections
- Serial output with single beam evaluation for profile measurement
- Various output modes to adapt output data to the given application

Ordering information

Sensor type	Measurement range (mm)	Pitch* ¹	Sensing distance	Channels	Connection method				Order code	
									RS-232-C serial/ analog output models* ²	Analog output models
Through-beam (measuring) 	150	5 mm	3 m	30	–	M12 8-pin/ M12 5-pin	–	–	F3EM2-005-150	F3EM2-005-150-AV
		18 mm	15 m	8	–		–	–	F3EM2-018-150	F3EM2-018-150-AV
	300	5 mm	3 m	60	–		–	–	F3EM2-005-300	F3EM2-005-300-AV
		18 mm	15 m	16	–		–	–	F3EM2-018-300	F3EM2-018-300-AV
	450	5 mm	3 m	90	–		–	–	F3EM2-005-450	F3EM2-005-450-AV
		18 mm	15 m	24	–		–	–	F3EM2-018-450	F3EM2-018-450-AV
	600	5 mm	3 m	120	–		–	–	F3EM2-005-600	F3EM2-005-600-AV
		18 mm	15 m	32	–		–	–	F3EM2-018-600	F3EM2-018-600-AV
	900	5 mm	3 m	180	–		–	–	F3EM2-005-900	F3EM2-005-900-AV
		18 mm	15 m	48	–		–	–	F3EM2-018-900	F3EM2-018-900-AV
	1200	5 mm	3 m	240	–		–	–	F3EM2-005-1200	F3EM2-005-1200-AV
		18 mm	15 m	64	–		–	–	F3EM2-018-1200	F3EM2-018-1200-AV
	1500	5 mm	3 m	300	–		–	–	F3EM2-005-1500	F3EM2-005-1500-AV
		18 mm	15 m	80	–		–	–	F3EM2-018-1500	F3EM2-018-1500-AV
1800	5 mm	3 m	360	–	–	–	F3EM2-005-1800	F3EM2-005-1800-AV		
	18 mm	15 m	96	–	–	–	F3EM2-018-1800	F3EM2-018-1800-AV		
2100	18 mm	15 m	112	–	–	–	F3EM2-018-2100	F3EM2-018-2100-AV		

*¹ Models with 7.5 mm pitch are available. Contact your OMRON representative.

*² Models with RS-485 serial output are available. Contact your OMRON representative.

Connector cables

Type	Features	Material		Order code	
		Nut	Cable	Straight	Angled
M12	8 wires	CuZn	PUR 2 m	Y92E-M12PURSH8S2M-L	
			PUR 5 m	Y92E-M12PURSH8S5M-L	
	5 wires	CuZn	PVC 2 m	XS2F-M12PVC5S2M-EU	XS2F-M12PVC5A2M-EU
			PUR 2 m	XS2F-M12PUR5S2M-EU	XS2F-M12PUR5A2M-EU
			PVC 5 m	XS2F-M12PVC5S5M-EU	XS2F-M12PVC5A5M-EU
			PUR 5 m	XS2F-M12PUR5S5M-EU	XS2F-M12PUR5A5M-EU

Specifications

Item	Through-beam	
	F3EM2-005_	F3EM2-018_
Sensing distance	0 to 3 m	0 to 15 m
Vertical measurement range	0 to Max _M mm; Max _M : 150, 300, 450, 600, 900, 1200, 1500, 1800 ^{*1}	0 to Max _M mm; Max _M : 150, 300, 450, 600, 900, 1200, 1500, 1800 ^{*1}
Minimum detectable object size	10 mm	30 mm
Pitch	5 mm	18 mm
Response time	4 ms + 80 μs × number of beams (+ transmitting time for serial operation)	
Light source (wave length)	Infrared LED (880 nm)	
Power supply voltage	24 VDC±20%	
Ambient temperature	-10 to 55°C	
Degree of protection	IEC 60529 IP65	
Material	Case	Aluminum

*1 Models with different measurement ranges are available in 150 mm intervals. Please contact your OMRON representative.

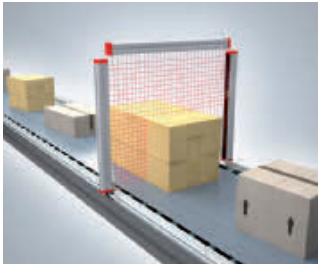

Volume measurement



Profile scan

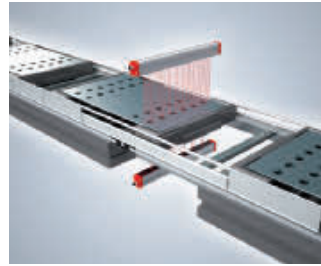

Hole detection



Position control

Fiber optic sensors and amplifiers

HIGH PRECISION IN SMALL SPACES

Precision and performance you can rely on

The requirements for fiber optic solutions can be very demanding particularly for applications with extreme temperatures and aggressive chemicals or for applications requiring highest precision with limited mounting space.

With the wide range of E32 fiber heads and the easy-usage amplifiers, the best performance fit for your application can be provided. The highest quality control procedures in design and manufacturing ensure that you get the precision and long service life that you can rely on.



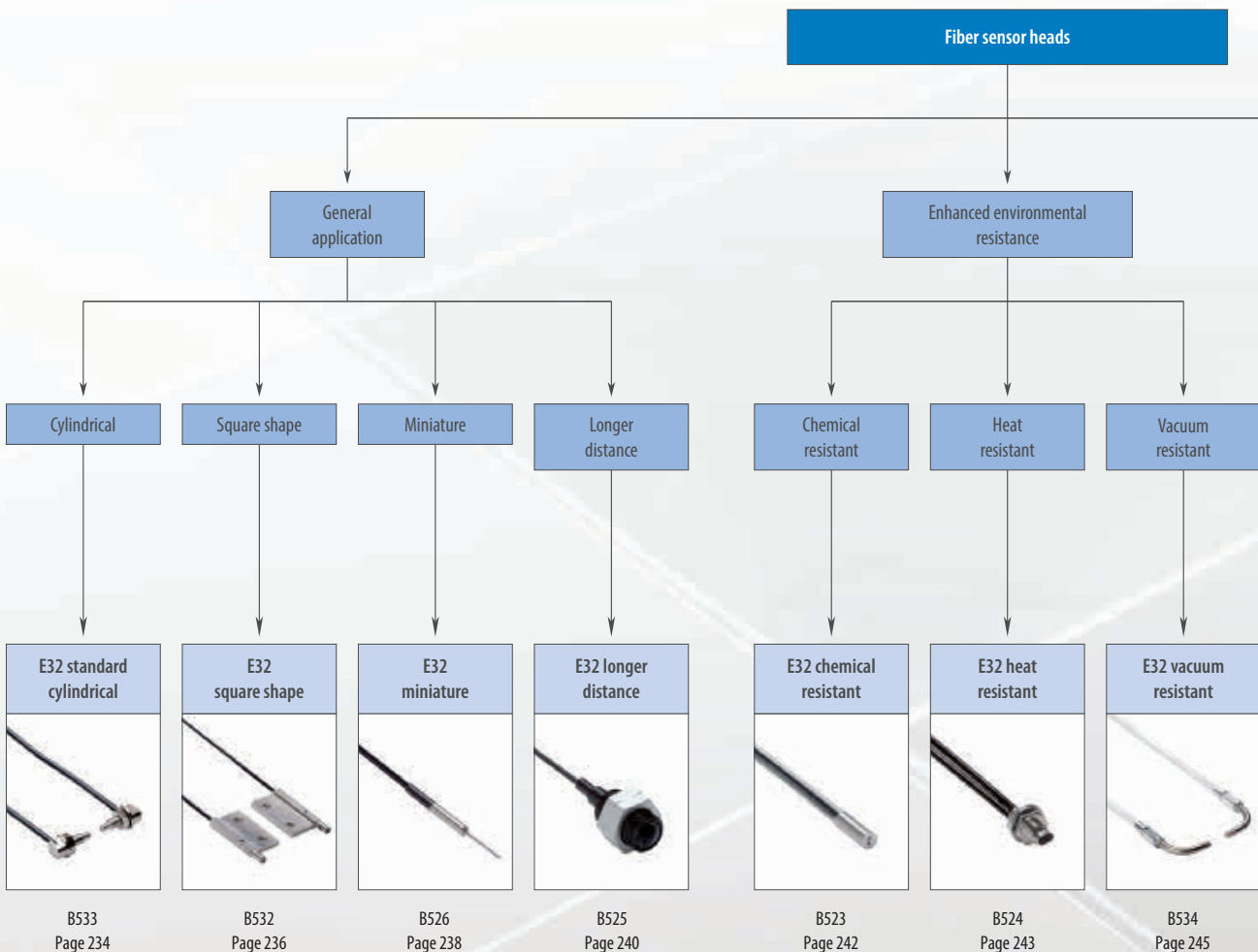

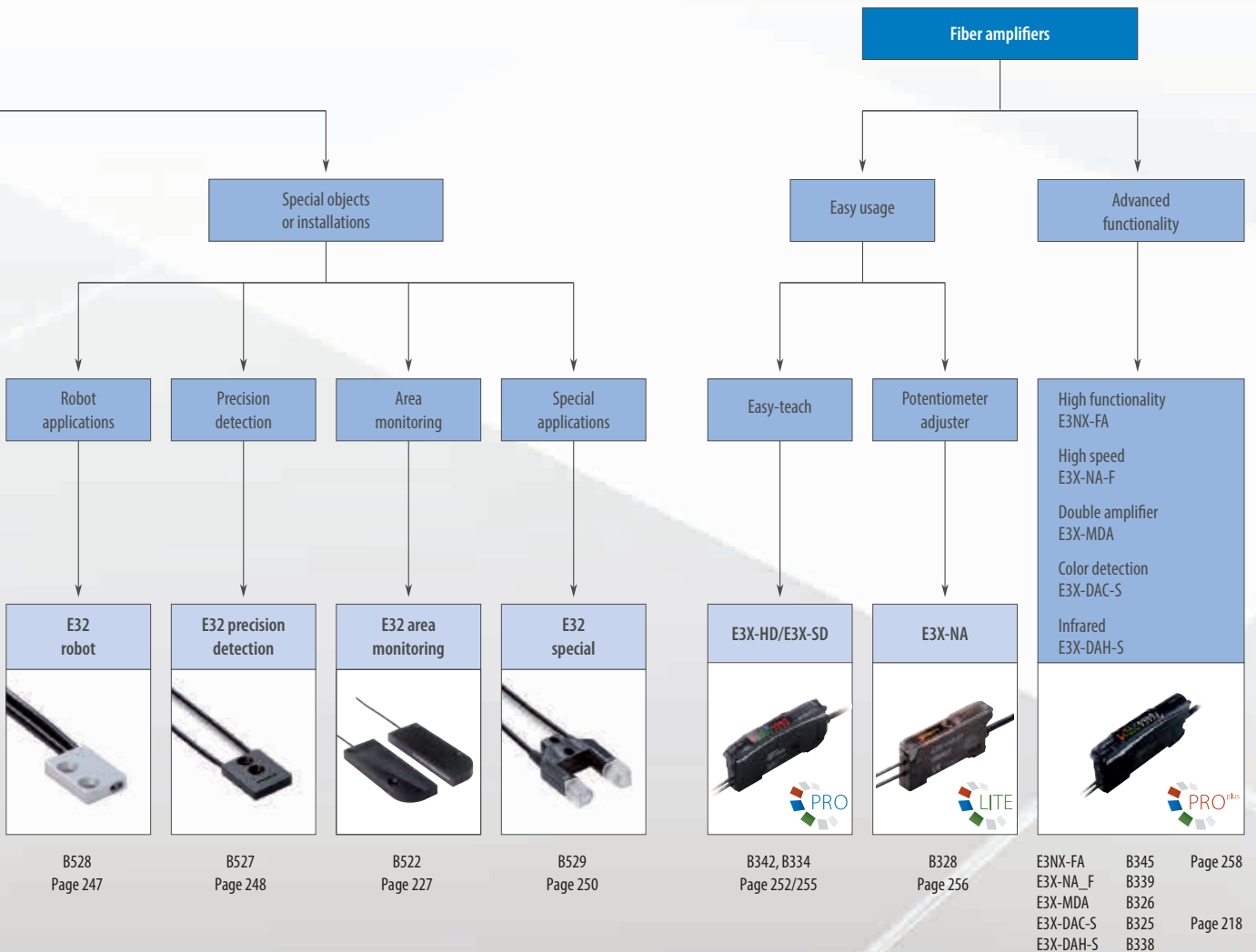
- Long operational life
- Easy to install and adjust
- Wide portfolio range for best performance fit









Selection table







Fiber sensor heads

Type	Cylindrical	Square shape	Miniature	Longer distance	Chemical resistant
					
Model	E32 standard cylindrical	E32 square shape	E32 miniature	E32 longer distance	E32 chemical resistant
Key features	<ul style="list-style-type: none"> Standard and high-flex fibers Sizes M3 to M6 	<ul style="list-style-type: none"> 3 or 4 mm thin housing Models in X,Y or Z-axis Direct mounting without bracket 	<ul style="list-style-type: none"> Sizes from dia 500 μm to 3 mm Bendable sleeves 	<ul style="list-style-type: none"> Built in focal lenses 	<ul style="list-style-type: none"> Fluoroplastic cover or coating
Through-beam	1,550 mm	1,550 mm	1,550 mm	20 m	4 m
Retro-reflective	250 mm	–	–	1.5 m	–
Diffuse-reflective	650 mm	600 mm	600 mm	1.4 m	350 mm
Page/Quick Link	234	236	238	240	242

Note: All sensing distances measured with E3X-DA-SE-S. Longer sensing distances up to 80% can be achieved with E3X-DA-S.

Fiber amplifiers

Type	Easy teach/double display	Easy teach/single display	Potentiometer adjuster	High performance	Double amplifier
					
Model	E3X-HD	E3X-SD	E3X-NA	E3NX-FA	E3X-MDA
361°	PRO	LITE	LITE	PRO ^{plus}	n.a.
Key features	<ul style="list-style-type: none"> Easy operation by smart tuning Dynamic power control Fieldbus connectivity 	<ul style="list-style-type: none"> 1 button object teaching Auto teach during operation 	<ul style="list-style-type: none"> Easy adjustment by potentiometer 	<ul style="list-style-type: none"> High functionality signal processing (timer, counter, dynamic power control, etc.) High signal resolution Increased sensing distance Double output/external input Fieldbus connectivity 	<ul style="list-style-type: none"> 2 inputs and AND, OR signal comparison
Response time (min.)	1 ms (50 μs in super-high-speed mode)	1 ms	200 μs	1 ms (30 μs in super-high-speed mode)	1 ms (130 μs in high speed mode)
Page/Quick Link	252	255	256	258	B326

Heat resistant	Vacuum resistant	Robot applications	Precision detection	Area monitoring	Special application
					
E32 heat resistant	E32 vacuum resistant	E32 robot	E32 precision detection	E32 area monitoring	E32 special
<ul style="list-style-type: none"> Heat resistant up to 400°C 	<ul style="list-style-type: none"> Leakage rate of 1×10^{-10} Pa*m³/s max 	<ul style="list-style-type: none"> Free moving multicore fibers for >1 Mio bending cycles 	<ul style="list-style-type: none"> Detection accuracy up to 100 µm Coaxial fibers Adjustable focal points 	<ul style="list-style-type: none"> Area monitoring up to 70 mm 	<ul style="list-style-type: none"> Detection of special objects (wafer, liquid level, flat glass, print mark ...)
3 m	950 mm	1,350 mm	3.8 m	4 m	3.8 m
–	–	–	–	–	–
500 mm	–	350 mm	600 mm	300 mm	20 mm
243	245	247	248	227	250

High speed	Color/print mark detection	Infrared LED
		
E3X-NA-F	E3X-DAC-S	E3X-DAH-S
n.a.	n.a.	n.a.
<ul style="list-style-type: none"> Short turn on time of 20 µs 	<ul style="list-style-type: none"> White LED and RGB ratio comparison 	<ul style="list-style-type: none"> Infrared LED
20 µs	1 ms (60 µs in super high speed mode)	1 ms (55 µs in super high speed mode)
B339	218	B338



Standard cylindrical fiber sensor heads

The standard cylindrical fiber optic sensor heads provide reliable object detection, easy installation and long sensor lifetime for all general applications.

- High-flex fibers and 90° cable exit for fiber breakage prevention
- Models with hexagonal back for simplified one-nut mounting
- Sizes M3 to M6

Ordering information

Sensor type	Size	Sensing distance (in mm) ^{*1}				Order code	
		Standard fiber		High-flex fiber		Standard fiber	High-flex fiber
		E3X-HD	E3NX-FA	E3X-HD	E3NX-FA		
	M4	1550	2300	1400	1400	E32-TC200 2M	E32-ET11R 2M
	M3	450	670	130	190	E32-TC200E 2M	E32-ET21R 2M
	dia 4 mm	1500	2300	-		E32-ETC220 2M	-
	M4	-		1000	1500	-	E32-T11N 2M
	M6	-		1200	1800	-	E32-LR11NP 2M
	M6	250	370	-		E32-R21	-
	M6	600	900	550	820	E32-DC200 2M	E32-ED11R 2M
	M4	160	240	60	90	E32-D211 2M	E32-D211R 2M
	M3	160	240	150	220	E32-DC200E 2M	E32-ED21R 2M
	M6	-		350	520	-	E32-D11N 2M
	M4	-		350	520	-	E32-D21N 2M
	dia 6 mm	220	300	100	150	E32-D14L 2M	E32-D14LR 2M

*1 Sensing distance measured with Standard Mode

Specifications

Item	Standard					High Flex				
	E32-_C200 E32-_C220	E32-D14L	E32-_C200E	E32-D211	E32-R21	E32-E_R E32-T11N E32-D11N	E32-D14LR E32-D211R	E32-D21N	E32-LR11NP	
Permissible bending radius	R25		R10			R1		R2		
Cut to length	Yes									
Ambient temperature	-40°C to 70°C									
Material	Head	Brass-nickel plated	Stainless steel	Brass-nickel plated	Stainless steel	Plastic (ABS)	Brass-nickel plated	Stainless steel	Brass-nickel plated	
	Fiber	PMMA								
	Sheath	Polyethylene coating					PVC coating			
Degree of protection	IEC 60529 IP67								IP50	



Hi-flex multicore fibers for flexibility in installation without fiber breakage

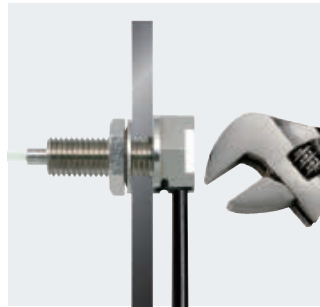

Models with hexagonal back for simple one-nut mounting

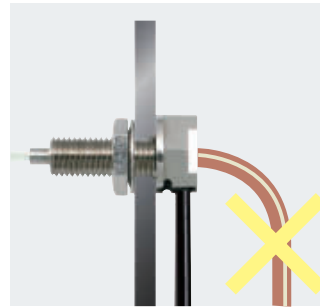

Cable exit shifted by 90° for preventing fiber breakage



Square shape fiber sensor heads

The fiber heads in square shaped housing provide fast and easy installation on flat surfaces.

- Models with sensing direction in X, Y or Z axis
- 3 or 4mm thick housings for minimal height requirement
- Standard or high-flex fibers

Ordering information

Sensor type	Size in mm (standard / high-flex)	Sensing distance (in mm) ^{*1}				Order code	
		Standard fiber		High-flex fiber		Standard fiber	High-flex fiber
		E3X-HD	E3NX-FA	E3X-HD	E3NX-FA		
	15x8x3 / 15x10x4	1550	1550	1400	2100	E32-T15X 2M	E32-ETS10R 2M
	15x8x3	950	1400	450	670	E32-T15Y 2M	E32-T15YR 2M
	15x8x3 / 15x9x4	950	1400	1300	1800	E32-T15Z 2M	E32-ETS14R 2M
	13x9x4	-		1300	1800	-	E32-ET15YR 2M
		-		1300	1800	-	E32-ET15ZR 2M
	15x10x3	600	900	350	520	E32-D15X 2M	E32-D15XR 2M
	15x10x3	200	300	100	150	E32-D15Y 2M	E32-D15YR 2M
	15x10x3 / 13x6x2.3	200	300	100	150	E32-D15Z 2M	E32-EDS24R 2M
	24.5x10x3	-		1780	2600	-	E32-A03-1 2M
	21x9x2	-		680	1000	-	E32-A04-1 2M

^{*1} Sensing distance measured with Standard Mode

Specifications

Item	Standard			High flex	
	E32-_15	E32-A03_	E32-A04_	E32-E	E32-_15_R
Permissible bending radius	R25	R10		R1	
Cut to length	Yes				
Ambient temperature	-40°C to 70°C				
Material	Head	Aluminium	Brass-nickel plated	Stainless steel	Aluminium
	Fiber	PMMA			
	Sheath	Polyethylene coating			PVC coating
Degree of protection	IEC 60529 IP67	IEC 60529 IP50		IEC 60529 IP67	

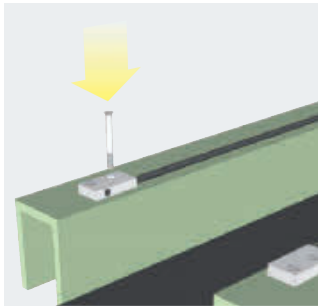

Space saving and fast mounting without additional brackets

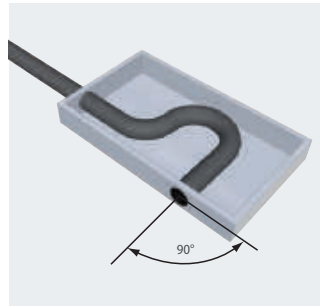

Precise positioning during manufacturing for 90° optics to achieve minimal tolerance variations in optical output axis angle



Miniature fiber sensor heads

The miniature fiber heads provide high accuracy in smallest spaces and reliable detection of minute objects.

- Sizes from dia 500 µm to 3 mm
- Side view models with precision axis alignment for highest accuracy
- Bendable sleeves for precision positioning

Ordering information

Sensor type	Size	Sensing distance (in mm) ^{*1}				Order code	
		Standard fiber		High-flex fiber		Standard fiber	High-flex fiber
		E3X-HD	E3NX-FA	E3X-HD	E3NX-FA		
	dia 3 mm	1550	2300	1000	1500	E32-T12 2M	E32-T12R 2M
	dia 2 mm	450	670	250	370	E32-T22 2M	E32-T22R 2M
	dia 1.5 mm	450	670	450	670	E32-T222 2M	E32-T222R 2M
	dia 1 mm	–	–	250	370	–	E32-T223R 2M
	dia 3 mm	950	1420	450	670	E32-T14L 2M	E32-T14LR 2M
	dia 2 mm	680	1020	–	–	E32-A04 2M	–
	dia 1 mm	250	370	100	150	E32-T24	E32-T24R 2M
	dia 1.2 mm	1550	2300	1000	1500	E32-TC200B ^{*2}	E32-TC200BR ^{*2}
	dia 0.9 mm	450	670	250	370	E32-TC200F ^{*2}	E32-TC200FR ^{*2}
	dia 3 mm	160	240	60	90	E32-D22 2M	E32-D22R 2M
	dia 2 mm	150	220	80	120	E32-D32 2M	E32-D32R 2M
	dia 1.5 mm	–	–	60	90	–	E32-D22B 2M
	dia 2 mm	60	90	30	40	E32-D24	E32-D24R 2M
	dia 2.5 mm	600	900	350	520	E32-DC200B 2M ^{*2 *3}	E32-DC200BR ^{*2 *3}
	dia 1.2 mm	160	240	60	90	E32-DC200F ^{*2}	E32-DC200FR ^{*2}
	dia 0.8 mm	–	–	30	40	–	E32-D33 2M
	dia 0.5 mm	–	–	6	9	–	E32-D331 2M

^{*1} Sensing distance measured in Standard Mode

^{*2} Models with 40 mm sleeve instead of 90 mm sleeve are available by adding '4' to the order code at the end, e.g. E32-TC200B4

^{*3} Sleeve cannot be bent

Specifications

Item	Standard						High-flex					
	E32-DC200B E32-T12 E32-TC200B	E32-T14L	E32-D32	E32-D22 E32-T222 E32-TC200F	E32-D24 E32-DC200F E32-T22 E32-T24	E32-A04	E32-D32R E32-D33 E32-D331	E32-D22B	E32-DC200BR E32-T12R E32-TC200BR	E32-D22R E32-T222R E32-TC200FR	E32-D24R E32-DC200FR E32-T14LR E32-T22R E32-T223R E32-T24R	
Permissible bending radius	R25			R10			R4		R1			
Cut to length	Yes											
Ambient temperature	-40°C to 70°C											
Material	Head	Brass-nickel plated	Stainless steel	Brass-nickel plated	Stainless steel	Brass-nickel plated	Stainless steel	Brass-nickel plated	Stainless steel	Brass-nickel plated	Stainless steel	
	Fiber	PMMA										
	Sheath	Polyethylene coating	PVC and polyethylene	Polyethylene coating	PVC and polyethylene	PVC coating	Polyethylene coating	PVC and polyethylene	PVC coating	Polyethylene coating	Polyethylene coating	
Degree of protection	IEC 60529 IP67					IEC 60529 IP50	IEC 60529 IP67					

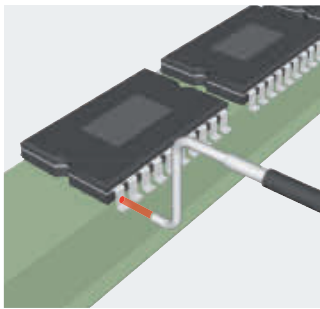

Bendable metal sleeves for precision positioning of sensors after installation

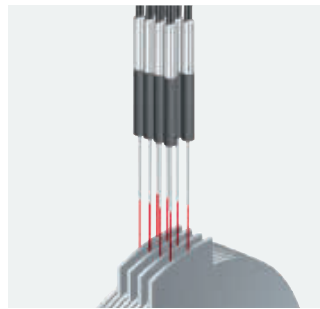

0.5 mm diameter (diffuse reflective) or 1 mm diameter (through beam) when mounting space is crucial

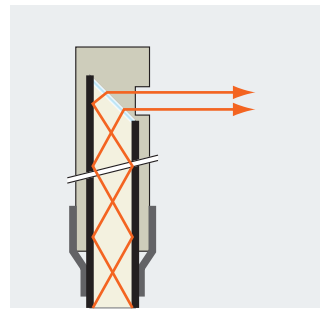

High precision fiber surface cutting and positioning during manufacturing to achieve minimal deviation of optical output axis angle



Longer distance fiber sensor heads

With built-in focal lenses the longer distance fiber heads provide enhanced operational stability in dusty environments or long distance applications

- Sensing distance up to 20 m
- Built-in focal lens
- Sizes from dia 2 mm to M14
- Easy installation - no need to attach auxiliary lenses

Ordering information

Sensor type	Size	Sensing distance (in mm) ^{*1}				Order code	
		Standard fiber		High-flex fiber		Standard fiber	High-flex fiber
		E3X-HD	E3NX-FA	E3X-HD	E3NX-FA		
	M14	20000	20000	-	-	E32-T17L	-
	25.2 × 10.5 × 8 mm	4000	4000	-	-	E32-T14	-
	M4	-	-	3500	4000	-	E32-LT11N 2M
	M4	4000	4000	3500	4000	E32-LT11 2M	E32-LT11R 2M
	M3	1350	2000	-	-	E32-TC200A 2M	-
	dia 3 mm	2600	3900	-	-	E32-T12L 2M	-
	dia 2 mm	850	1200	-	-	E32-T22L 2M	-
	21.5 × 27 × 10 mm	1500	2250	-	-	E32-R16 2M	-
	M6	-	-	350	520	-	E32-LD11N 2M
	22 × 17.5 × 9 mm	1400	2100	-	-	E32-D16 2M	-
	M6	360	540	350	520	E32-LD11 2M	E32-LD11R 2M
	M4	260	390	-	-	E32-D21L 2M	-
	dia 3 mm	450	670	-	-	E32-D12 2M	-

^{*1} Sensing distance measured in Standard Mode

Specifications

Item	Through-beam							
	E32-T17L/ E32-T14	E32-LT11N	E32-LT11	E32-T12L	E32-TC200A	E32-LT11R	E32-T22L	
Permissible bending radius	R25	R2	R25			R1	R10	
Cut to length	Yes							
Ambient temperature	-40°C to 70°C							
Material	Head	ABS	Brass-nickel plated				Stainless steel	
	Fiber	PMMA						
	Sheath	Polyethylene coating						
Degree of protection	IP67	IP50		IP67		IP50	IP67	

Item	Retro-reflective		Diffuse-reflective					
	E32-R16	E32-D16	E32-LD11N	E32-LD11	E32-LD11R	E32-D21L	E32-D12	
Permissible bending radius	R25	R4	R2	R25	R10	R10	R25	
Cut to length	Yes							
Ambient temperature	-40°C to 70°C							
Material	Head	ABS	Aluminium	Brass-nickel plated			Stainless steel	
	Fiber	PMMA						
	Sheath	Polyethylene coating	PVC coating	Polyethylene coating				
Degree of protection	IP67	IP40	IP50			IP67		

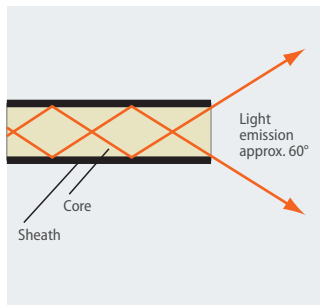

Light emission of conventional fibers

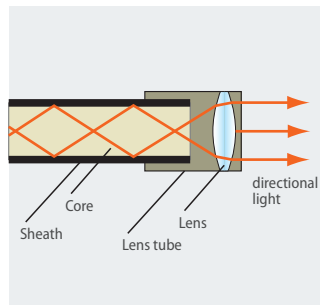

With built-in focal lenses, longer sensing distances can be achieved up to 5 times longer compared to conventional sensors

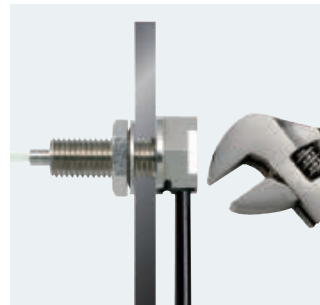

Models with hexagonal back for simple one-nut mounting

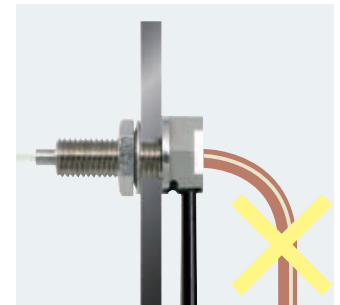

Cable exit shifted by 90° for preventing fiber breakage



Chemical resistant fiber sensor heads

The chemical resistant fibers provide long sensor lifetime in areas with frequent cleaning, usage of chemicals and higher temperatures.

- fluororesin cover for highest chemical resistance
- temperature resistance up to 200°C

Ordering information

Sensor type	Size	Sensing distance (in mm) ^{*1}		Key feature	Order code
		E3X-HD	E3NX-FA		
	M4	1350	2000	Fluororesin coating	E32-T11U 2M
	dia 5 mm	3200	4000	Fluororesin cover	E32-ET11F 2M
		4000	4000		E32-T12F
		800	1200		E32-T14F 2M
	M6	350	520	Fluororesin coating	E32-D11U 2M
	dia 7 mm	300	450	Fluororesin cover	E32-ED11F 2M
	dia 6 mm	190	280		E32-D12F
		80	120		E32-D14F 2M
		1400	2100	Fluororesin cover Heat resistant to 200°C	E32-T81F-S 2M
	dia 5 mm	2800	4000	Fluororesin cover Heat resistant to 150°C	E32-T51F 2M

^{*1} Sensing distance measured in Standard Mode

Specifications

Item	Fluororesin coating		Full fluororesin cover		Full fluororesin cover and heat resistance	
	E32-T11U	E32-D11U	E32-E_11F	E32-_12F/E32-_14F	E32-T51F	E32-T81F-S
Permissible bending radius (in mm)	R1	R4	R75	R40		R10
Cut to length	yes					no
Ambient temperature	-40°C to 70°C				-40°C to 150°C	-40°C to 200°C
Material	Head	Brass-nickel plated		Fluororesin		
	Fiber	PMMA				Glass
	Sheath	Fluororesin coating		Fluororesin cover		
Degree of protection	IEC60529 IP67					

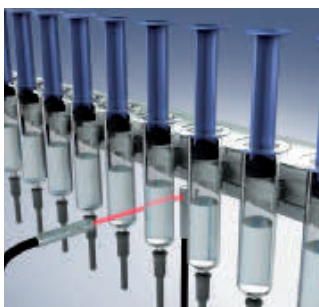

Enhanced temperature resistant models



Highest chemical resistance

The fluororesin cover provides highest chemical resistance for longest lifetime in frequently cleaned environments like aseptic filling in pharmaceutical applications



Heat resistant fiber sensor heads

The wide range of heat resistant fibers provides long sensor lifetime with highest protection in demanding environments

- heat resistant up to 400°C
- sizes from dia 2 mm to M6
- models for long distances or high detection accuracy

Ordering information

Sensor type	Size	Sensing distance (in mm) ^{*1}		Key feature	Order code	
		E3X-HD	E3NX-FA		For E3NX-FA and E3X-HD amplifiers	For E3X-NA amplifier
	M4	3000	4000	-40°C to 150°C	E32-ET51 2M	
		800	1200	-40°C to 100°C ^{*2} , high-flex	E32-T51R 2M	
		550	820	-40°C to 200°C	E32-T81R-S 2M	
		900	1350	-60°C to 350°C	E32-T61-S 2M	
	dia 2 mm	450	670	-40°C to 150°C	E32-T54 2M	
	dia 3 mm	2600	3900	-40°C to 200°C	E32-T84S-S 2M	
	M6	500	750	-40°C to 150°C	E32-ED51 2M	
		280	420	-40°C to 100°C ^{*2} , high-flex	E32-D51R 2M	
		180	270	-40°C to 200°C	E32-D81R-S 2M	E32-D81R 2M
		180	270	-60°C to 350°C	E32-D61-S 2M	E32-D61
	M4	120	180	-40°C to 400°C	E32-D73-S 2M	E32-D73
	23×20×9 mm	15-38		-40°C to 150°C	E32-A09H 2M	
	30×24×9 mm	20-30		-40°C to 300°C	E32-A09H2 2M	
	25×18×5 mm	1-5		-40°C to 300°C	E32-L64 2M	
	36×18×5 mm	5-18			E32-L66 2M	

^{*1} Sensing distance measured in Standard Mode
^{*2} Short term resistance. For continuous operation -40°C to 90°C

Specifications

Item	-40°C to 150°C	-40°C to 100°C	-40°C to 150°C		-40°C to 200°C		-40°C to 300°C		-60°C to 350°C	-40°C to 400°C
	E32-E_51	E32-D51R/T51R	E32-T54	E32-A09H	E32-_81_	E32-T84_	E32-A09H2	E32-L6_	E32-_61_	E32-D73_
Permissible bending radius (in mm)	R35	R2	R35		R10	R25				
Cut to length	Yes					No				
Material	Head	Brass-nickel plated	Stainless steel		Aluminium	Stainless steel				
	Fiber	PMMA	Acrylate resin	PMMA		Glass				
	Sheath	Fluoro resin	Polyurethane resin	Fluoro resin		Stainless steel spiral coating	Stainless steel tube	Stainless steel spiral coating		Stainless steel tube
Degree of protection	IEC 60529 IP67	IEC 60529 IP50	IEC 60529 IP67						IEC 60529 IP40	IEC 60529 IP67

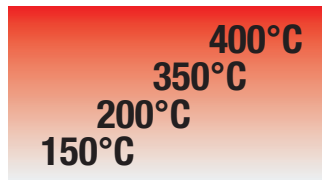

The temperature range optimised material selection provides best application fit and value - performance ratio.

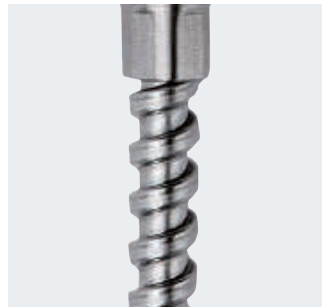

Stainless steel spiral coating for flexibility with highest mechanical protection.

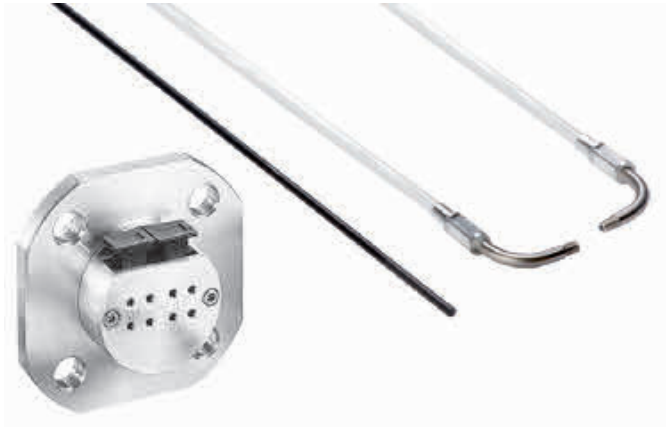

Vacuum resistant fiber sensor heads

For applications in cleanest and hot environments the vacuum resistant fibers and connecting flanges provide long operational lifetime and vacuum integrity.

- Leakage rate of 1×10^{-10} Pa*m³/s max
- Heat resistance up to 200°C
- Detergent resistant fluororesin or stainless steel fiber sheath

Ordering information

Sensor

Sensor type	Size	Sensing distance (in mm) ^{*1}		Temperature range	Order code
		E3X-HD	E3NX-FA		
	M4	400	600	-40°C to 120°C	E32-T51V 1M
	dia 3	250	370	-40°C to 120°C	E32-T54V 1M
	dia 3	950	1400	-60°C to 200°C	E32-T84SV 1M
	33 x 18 x 5.5 mm	5		-40°C to 70°C	E32-G86V-1 3M

*1 Sensing distance measured with Standard Mode

Flange

Type	Size	Order code
4 channel flange	80 x 80 x 49 mm	E32-VF4
1 channel flange	96 x dia 30 mm max.	E32-VF1
Flange-to-amplifier connection fiber	2 m length	E32-T10V 2M

Specifications

Item	Fiber sensor heads				Flange-to-amplifier fiber
	E32-T51V	E32-T54V	E32-T84SV	E32-G86V-1	E32-T10V
Permissible bending radius	R30		R25		
Cut to length	No				Yes
Material	Head	Aluminium	Stainless steel		-
	Fiber	Glass			PMMA
	Sheath	Fluororesin coating		Stainless steel spiral coating	Polyethylene coating
Degree of protection	-				

Item	Flange	
	E32-VF1	E32-VF4
Leakage rate	1×10^{-10} Pa*m ³ /s max	
Ambient temperature	-25°C to 55°C	
Material	Flange	Aluminium and stainless steel
	Seal	Fluorocarbon rubber (viton)

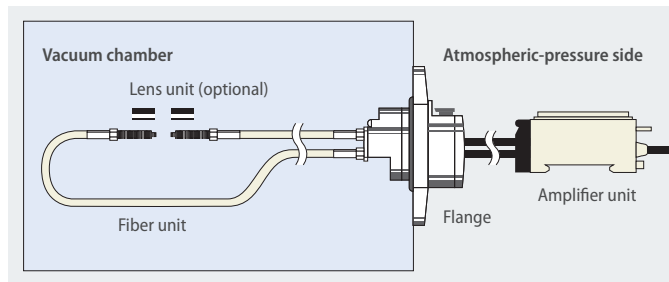

The vacuum resistant fiber heads and flanges are sealed to prevent gas leakage into vacuum areas



Robot application fiber sensor heads

For applications on frequently or fast moving parts, the robot fibers reduce the risk of fiber breakage with a guaranteed operational life of more than 1 million bending cycles

- Free moving multicore fibers for > 1 mio bending cycles
- Square shapes for easy surface installation
- Cylindrical sizes from dia 1.5 mm to M6

Ordering information

Sensor type	Size	Sensing distance (in mm) ^{*1}		Order code
		E3X-HD	E3NX-FA	
	M4	1350	2000	E32-T11 2M
	M3	400	600	E32-T21 2M
	dia 3 mm	1350	2000	E32-T12B
	dia 2 mm	400	600	E32-T21B
	dia 1.5 mm	400	600	E32-T22B
	15 × 18 × 3 mm	1350	2000	E32-T15XB 2M
	M6	350	520	E32-D11 2M
	M4	140	210	E32-D21B 2M
	M3	60	90	E32-D21 2M
	dia 1.5 mm	60	90	E32-D22B 2M
	15 × 10 × 3 mm	350	520	E32-D15XB 2M

*1 Sensing distance measured in Standard Mode

Specifications

Item	Square	Cylindrical			
	E32-D15XB E32-T15XB	E32-T21	E32-D11 E32-T11	E32-D21 E32-T12B E32-T22B	E32-D21B E32-D22B E32-T21B
Permissible bending radius	R4				
Cut to length	Yes				
Ambient temperature	-40°C to 70°C				
Material	Head	Aluminium	Brass-nickel plated		Stainless steel
	Fiber	PMMA			
	Sheath	PVC coating	Polyethylene coating	PVC coating	
Degree of protection	IEC 60529 IP67				

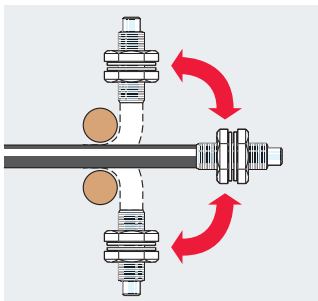

Guaranteed more than 1 mio bending operations

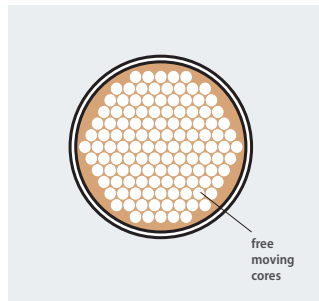

Free moving fiber cores prevent fiber breakage and light intensity loss when the fiber is bent.

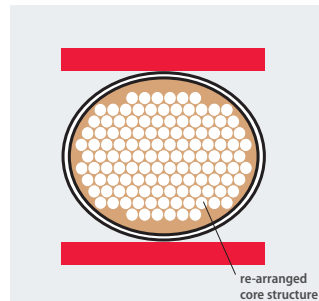



Precision detection fiber sensor heads

Highest precision in design and manufacturing of the fibers and focal lenses ensure highest beam and spot accuracy allowing the detection of smallest objects and height differences of less than 100 µm.

- Coaxial fibers with focal lenses for spot diameters of 100 µm
- Through-beam models with highly focused beam and precise optical axis alignment
- Limited reflective models for height difference detection of less than 100 µm

Ordering information

Sensor type	Preferred usage	Size	Key feature	Sensing distance *1 (in mm)		Order code
				E3X-HD	E3NX-FA	
	Precise thin object detection /accurate positioning	dia 3 mm	<ul style="list-style-type: none"> • High precision optical axis adjustment • Very focused beam 	3800	4000	E32-T22S
		dia 2 mm		1780	2650	E32-A03 2M
				680	1000	E32-A04 2M
 	Very small object detection	M6	–	600	900	E32-CC200 2M ^{*2}
		M3	Spot dia 0.5 mm	120	180	E32-EC31 2M
			Spot dia 0.2 mm	17		E32-EC41 1M + E39-F3B
			Spot dia 0.1 mm	7		E32-EC41 1M + E39-F3A-5
		dia 3 mm	–	300	450	E32-D32L
		dia 2 mm	–	150	220	E32-D32 2M ^{*2}
		M6	<ul style="list-style-type: none"> • 90° cable exit • Hexagonal back 	350	520	E32-C11N 2M
		M3		130	190	E32-C21N 2M
		M3	90° cable exit	50	70	E32-C31N 2M
		dia 2 mm ^{*3}	Spot dia 0.5 to 3mm	8 - 25 adjustable		E32-EC31 2M + E39-EF51
Spot dia 0.5 to 1 mm	6 - 15 adjustable		E32-D32 2M + E39-F3A			
Spot dia 0.1 to 0.6 mm	6 - 15 adjustable		E32-C42 1M + E39-F3A			
 	Precision height difference detection / flat surface detection Object detection in front of background	23 × 20 × 9 mm	–	26.5±11.5		E32-A09 2M
		16 × 18 × 4 mm	–	7.2±1.8		E32-L25L ^{*2}
		20 × 20 × 5 mm	–	3.3		E32-L25
		18 × 20 × 4 mm	Precise spot e.g. for detection of a flat / reflective surface	4±2		E32-L24L ^{*2}
		34 × 25 × 8 mm	High precision (detection accuracy 100 µm)	2.4		E32-EL24-1 2M
		20.5 × 14 × 3.8 mm	Limited reflective wide beam e.g. for object detection on a flat surface	15		E32-L16-N 2M

*1 Sensing distance measured in Standard Mode

*2 A high flex cable version is available. Add 'R' to the order code, e.g. E32-CC200R

*3 Outer diameter of the fiber. Outer diameter of the focal lens is dia 4mm (front part)

Specifications

Item	Through-beam			Diffuse reflective (coaxial)				Limited reflective				
	E32-T22S	E32-A03	E32-A04	E32-C11N E32-C31N	E32-C21N	E32-CC200	E32-C42 E32-D32/-D32L E32-EC31/-EC41	E32-EL24-1	E32-L24L E32-L25L	E32-L25	E32-L16	E32-A09
Permissible bending radius	R10	R1	R10	R4	R2	R25		R10		R25		
Cut to length	Yes											
Ambient temperature	-40°C to 70°C											
Material	Head	Brass-nickel plated		Stainless steel	Brass-nickel plated		Brass nickel plated	Brass-nickel plated and aluminium	Polycarbonate	ABS	Aluminium	
	Fiber	PMMA										
	Sheath	PVC coating	Polyethylene coating		PVC coating		PVC, polyethylene and polyolefin coating	Polyethylene coating				
Degree of protection	IEC 60529 IP67	IEC 60529 IP50		IEC 60529 IP67				IEC 60529 IP50			IEC 60529 IP40	

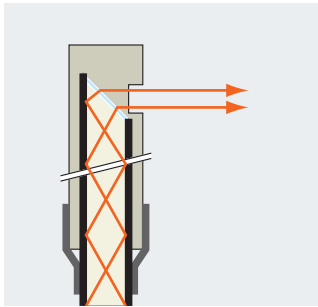

Focused and high precision beam alignment during manufacturing. Models available with typical deviation of 0.1° for very precise detections

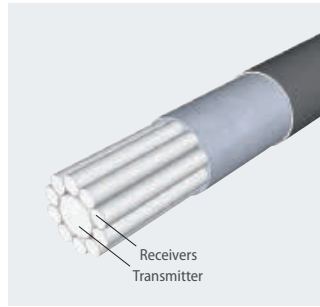

Coaxial fibers provide an enhanced positioning and detection accuracy and allow the easy adjustment of the focal point using adjustable focal lenses

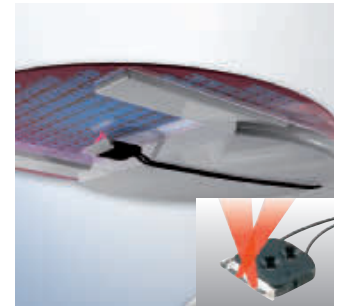
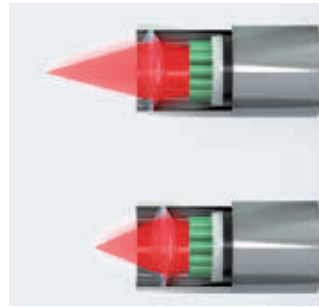

Limited reflective fibers utilize the total reflection on shiny surfaces to detect height differences or objects at a pre-defined distance.



Special application fiber sensor heads

For a wide range of special applications, the task optimised fiber heads provide best fitting sensing performance and adaption to environmental requirements.

- Detection of special objects (liquids, labels on foils, etc.)
- Fiber heads optimised for special tasks (wafer mapping, flat glass, etc.)

Ordering information

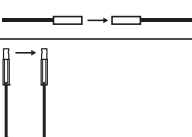
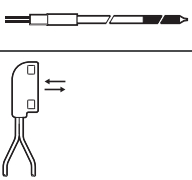
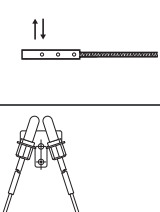
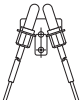
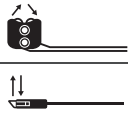
Sensor type	Size	Sensing distance (in mm) ^{*1}		Comment	Order code
		E3X-HD	E3NX-FA		
	Fork shape 36 × 24 × 8 mm	10		–	E32-G14
	dia 3 mm	3800	4000	–	E32-T22S
	dia 3 mm	2600	3900	–	E32-T24S
	dia 3 mm	1780	2650	–	E32-A03 2M
	dia 2 mm	680	1000	–	E32-A04 2M
	dia 6 mm	liquid contact		Liquid level contact	E32-D82F1 4M
	15 × 23.5 × 5 mm	tube contact		Liquid level detection through transparent tube or container	E32-D36T 2M
	21 × 16.5 × 4 mm	8		Metal housing	E32-A10 2M
	20.5 × 14 × 3.8 mm	15		Plastic housing	E32-L16-N 2M
	25 × 18 × 5 mm	1–5		Heat resistant up to 300°C	E32-L64 2M
	36 × 18 × 5.5 mm	5–18			E32-L66 2M
	Glass detection in wet processes 38.5 × 39 × 17.5 mm	8 to 20 (recommended: 11)		Heat resistant up to 85°C	E32-L11FS 2M
	20 × 20 × 5 mm	7.2±1.8		–	E32-L25L
	18 × 20 × 4 mm	4±2		–	E32-L24L
	34 × 25 × 8 mm	2.4		Very precise spot (detection accuracy 100 µm)	E32-EL24-1 2M

^{*1} Sensing distance measured in Standard Mode

Specifications

Item	E32-D82F1 E32-L11FS	E32-G14	E32-A10	E32-L16-N	E32-L66	E32-L64		
Permissible bending radius	R40	R25						
Cut to length	Yes					No		
Ambient temperature	-40°C to 70°C					-40°C to 300°C		
Material	Head	PFA	ABS	ABS	PVC	Stainless steel		
	Fiber	PMMA					Glass	
	Sheath	Polyethylene coating				Stainless steel spiral coating		
Degree of protection	IEC 60529 IP67			IEC 60529 IP30	IEC 60529 IP40	IEC 60529 IP40	IEC 60529 IP50	

Item	E32-EL24-1	E32-T24S	E32-L24L E32-L25L	E32-A04	E32-D36T	E32-A03	E32-T22S
Permissible bending radius	R10				R4	R1	
Cut to length	Yes						
Ambient temperature	-40°C to 70°C						
Material	Head	Brass-nickel plated and aluminium	Stainless steel	Brass-nickel plated	Stainless steel	ABS	Brass-nickel plated
	Fiber	PMMA					
	Sheath	Polyethylene coating	PVC coating	Polyethylene coating		PVC coating	Polyethylene coating
Degree of protection	IEC 60529 IP67		IEC 60529 IP50		IEC 60529 IP67	IEC 60529 IP50	IEC 60529 IP67

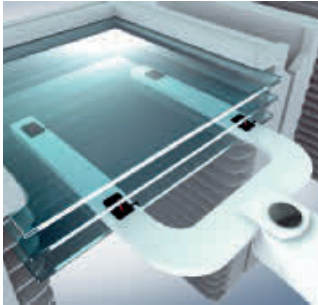

The limited reflective fiber heads for glass detection provide a stable detection of flat glass in standard, hot or wet environment. The shapes and materials are optimized to provide the best value - performance ratio depending on the requirements.



For the detection of very small height differences like labels on foils in applications where space is crucial, the small sized limited reflective sensors provide accurate detection up to 100 µm resolution.



Easy-teach digital fiber amplifier

The E3X-HD with 1-button Smart tune set-up provides fast and simple teaching. Dual digital display and advanced features make the E3X-HD ideal even for demanding applications.

- Easy teaching by Smart tuning within a few seconds
- Dynamic Power Control (DPC) for highest operational stability for changing environmental conditions or challenging objects
- M8 connector models
- EtherCAT and CompoNet Communication units for high-speed field bus connectivity

Ordering information

Item	Order code		
	Transistor output models		Communication unit model ^{*1}
	NPN output	PNP output	
Pre-wired	E3X-HD11 2M	E3X-HD41 2M	–
Fiber amplifier connector	E3X-HD6	E3X-HD8	E3X-HD0
M8 connector (4pin)	E3X-HD14	E3X-HD44	–

*1 For field bus connection please chose Communication unit E3X-ECT for EtherCAT or E3X-CRT for CompoNet.

Fiber amplifier connectors

Shape	Type	Comment	Order code
	Fiber amplifier connector	2 m PVC cable	E3X-CN11
		30 cm PVC cable with M12 plug connector (4 pin)	E3X-CN21-M1J 0.3M
		30 cm PVC cable with M8 plug connector (4 pin)	E3X-CN21-M3J-2 0.3M

Communication units

Shape	Communications method	Applicable Fiber Amplifier Units	Order code
	CompoNet	E3X-HD0 E3X-MDA0 E3X-DA0-S	E3X-CRT
	EtherCAT		E3X-ECT

Specifications

Item	Type	Standard models						For Communications Unit
	Model	E3X-HD11	E3X-HD41	E3X-HD6	E3X-HD8	E3X-HD14	E3X-HD44	E3X-HD0
	Connection method	Pre-wired		Wire-saving connector		M8-4pin connector		Communications unit connector
	Control output	NPN output	PNP output	NPN output	PNP output	NPN output	PNP output	-
Light source (wavelength)		Red, 4-element LED (625 nm)						
Power supply voltage		12 to 24 VDC±10%, ripple (p-p) 10% max.						
Power consumption		Normal Mode: 720 mW max. (Current consumption: 30 mA max. at 24 VDC, 60 mA max. at 12 VDC.) Power Saving Eco Mode: 530 mW max. (Current consumption: 22 mA max. at 24 VDC, 44 mA max. at 12 VDC.)						
Control output		Load power supply voltage: 26.4 VDC max., open-collector output (Varies with the model depending on output is PNP or NPN.) Load current: 50 mA max. (residual voltage: 2 V max.), OFF current: 0.5 mA max.						-
Response time	Super-high-speed Mode (SHS)	Operate or reset: 50 μs (NPN models) or 55 μs (PNP models)						
	High-speed Mode (HS)	Operate or reset: 250 μs						
	Standard Mode (STND)	Operate or reset: 1 ms						
	Giga-power Mode (GIGA)	Operate or reset: 1 ms						
Mutual interference prevention		Possible for up to 10 units						
Maximum connectable Units		16 units						with E3X-CRT: 16 units with E3X-ECT: 30 units

Easy One-Button-Teaching/Smart Tuning

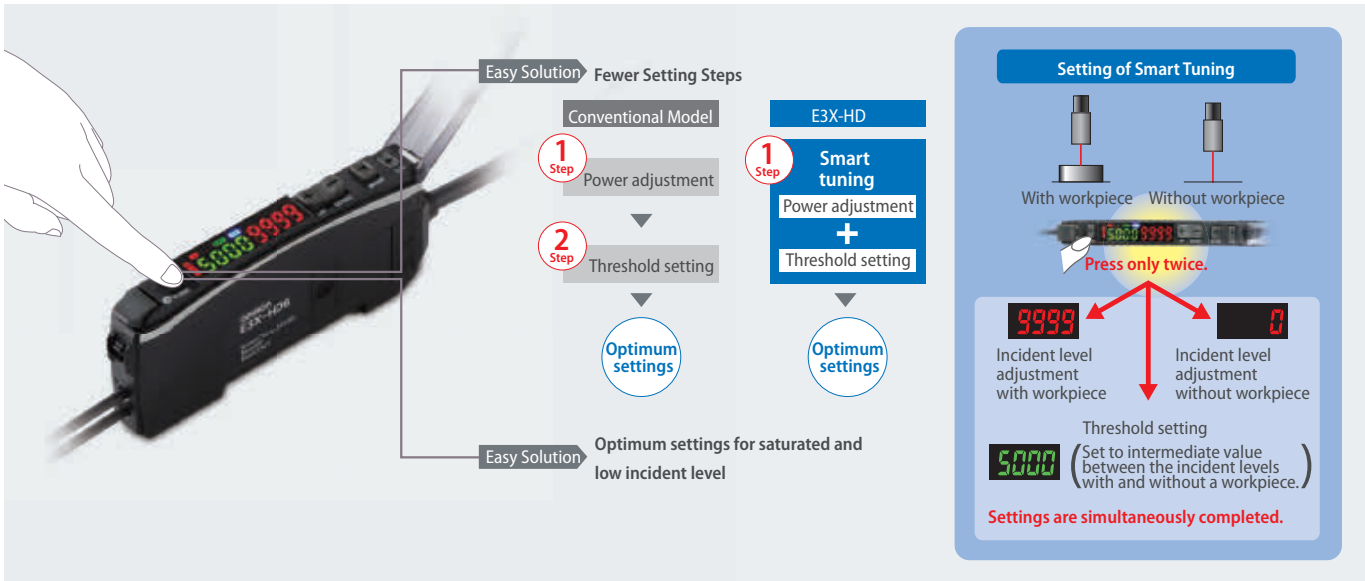

Easy setting of optimum power and threshold by pushing tune button twice.

Smart power control

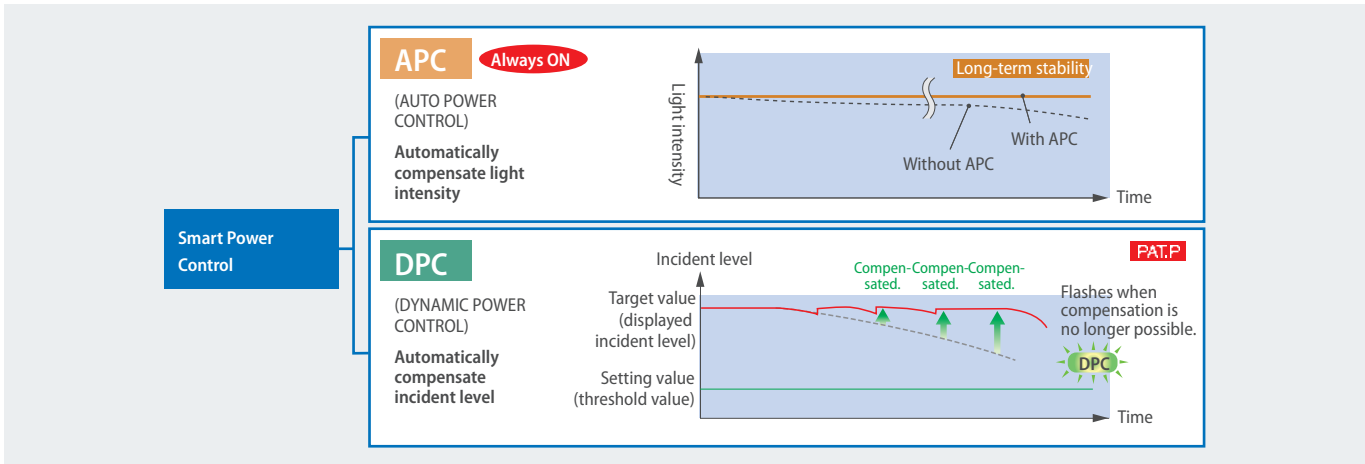

Enhanced signal stability control for compensating power reductions caused by temperature drift, dust or aging of LED.

Field bus connectivity



Field bus communication allows control by an external device to simplify setup and reduce wiring effort.



Single display digital fiber amplifier

E3X-SD allows easy one button setting and provide the best value performance ratio for standard applications.

- Auto-teaching during machine operation
- 2-point teaching within a few seconds
- Simple threshold adjustment with up/down keys

Ordering information

Item	Order code	
	NPN output	PNP output
Pre-wired	E3X-SD21 2M	E3X-SD51 2M
Fiber amplifier connector ^{*1}	E3X-SD7	E3X-SD9

^{*1} Order connector separately. For M8 connector models see E3X-HD.

Fiber amplifier connectors

Shape	Type	Comment	Order code
	Fiber amplifier connector	2 m PVC cable	E3X-CN11
		30 cm PVC cable with M12 plug connector (4 pin)	E3X-CN21-M1J 0.3M
		30 cm PVC cable with M8 plug connector (4 pin)	E3X-CN21-M3J-2 0.3M

Specifications

Item	E3X-SD	
Light source (wave length)	Red, 4-element LED (625 nm)	
Power supply voltage	12 to 24 VDC ±10%, ripple (p-p): 10% max.	
Protective circuits	Power supply reverse polarity protection, output short-circuit protection, mutual interference prevention	
Response time	Operation or reset: 200 μs max	
Sensitivity setting	Teaching and digital up/down keys	
Functions	Auto power control	High-speed control method for emission current
	Mutual interference prevention	Optical communication sync. possible for up to 5 units
Digital displays	Incident level or threshold	
Degree of protection	IEC 60529 IP50 (with protective cover attached)	

Easy operation by ergonomic buttons



Auto-teaching

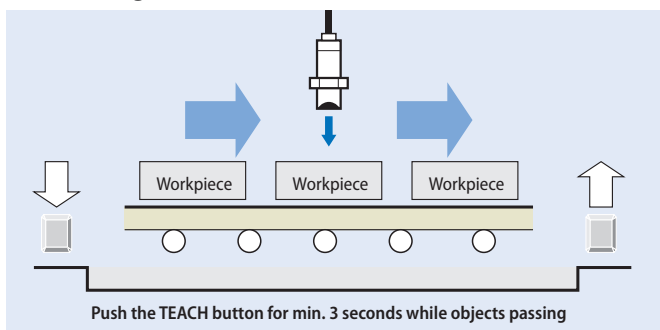

2-point teaching

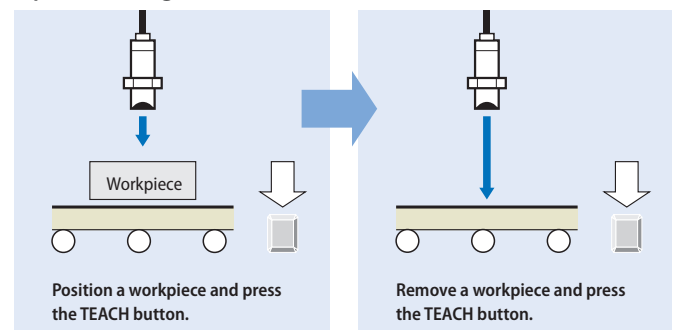

Digital fiber amplifier with potentiometer adjustment

The E3X-NA is the ideal amplifier for standard fiber applications providing quick & easy potentiometer adjustment and bargraph display.

- Easy adjustment with potentiometer
- Mutual interference prevention
- Enhanced water resistance types



Ordering information

Pre-wired



Item	Order code (for pre-wired types with 2 m cable length)	
	NPN output	PNP output
Standard	E3X-NA11 2M	E3X-NA41 2M
Enhanced water resistance	E3X-NA11V 2M	E3X-NA41V 2M

Connector version

Item	Order code	
	NPN output	PNP output
Standard (fiber amplifier connector)*1	E3X-NA6	E3X-NA8
Enhanced water resistance (M8 4-pin connector)	E3X-NA14V	E3X-NA44V

*1 Order connector separately.

Fiber amplifier connectors

Shape	Type	Comment	Order code
	Fiber amplifier connector	2 m PVC cable	E3X-CN21
		30 cm PVC cable with M12 plug connector (4 pin)	E3X-CN21-M1J 0.3M
		30 cm PVC cable with M8 plug connector (4 pin)	E3X-CN21-M3J-2 0.3M

Specifications

Item		Standard	Enhanced water resistance
Output	NPN output	E3X-NA11, E3X-NA6	E3X-NA11V, E3X-NA14V
	PNP output	E3X-NA41, E3X-NA8	E3X-NA41V, E3X-NA44V
Light source (wave length)		Red LED (625 nm)	
Power supply voltage		12 to 24 VDC±10%, ripple (p-p): 10% max.	
Protective circuit		Reverse polarity protection, output short-circuit protection, mutual interference prevention	
Response time		Operation or reset: 200 μs max.	
Sensitivity setting		8-turn endless adjuster (potentiometer)	
Functions		OFF-delay timer: 40 ms (fixed)	
Degree of protection		IEC 60529 IP50 (with protective cover attached)	IEC 60529 IP66 (with protective cover attached)



Bargraph display with light level, switching status and threshold indicators

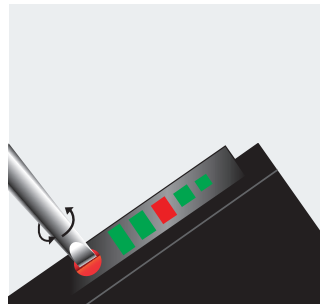

Simple sensitivity adjustment by potentiometer



High-performance digital fiber amplifier

The E3NX-FA amplifier is best choice for most challenging fiber applications in terms of long sensing distance, minute object detection or high speed processes.



- Easy teaching by Smart tuning within a few seconds
- New N-Smart technology provides significant improvement for sensing distance, minimum object detection and speed
- Easy and transparent information about sensor status by Solution Viewer and Change Finder function
- EtherCAT Communication unit for high-speed field bus connectivity

Ordering information



Item	Connection	Inputs/Outputs	Order code	
			NPN output	PNP output
Standard models	Pre-wired	1 output	E3NX-FA11 2M	E3NX-FA41 2M
	Fiber amplifier connector		E3NX-FA6	E3NX-FA8
Advanced models	Pre-wired	2 outputs + 1 input	E3NX-FA21 2M	E3NX-FA51 2M
	Fiber amplifier connector	1 output + 1 input	E3NX-FA7	E3NX-FA9
		2 outputs	E3NX-FA7TW	E3NX-FA9TW
	M8 connector	1 output + 1 input	E3NX-FA24	E3NX-FA54
2 output		–	E3NX-FA54TW	
Networking model ^{*1}	Connector for communication unit	via com. protocol	E3NX-FA0	

^{*1} For field bus connection please chose communication unit E3NW-ECT for EtherCAT.

Fiber amplifier connectors

Shape	Type	Comment	Order code
	Fiber amplifier connector	2 m PVC cable (4 pin)	E3X-CN21
		30 cm PVC cable with M12 plug connector (4 pin)	E3X-CN21-M1J 0.3M
		30 cm PVC cable with M8 plug connector (4 pin)	E3X-CN21-M3J-2 0.3M

Communication units

Shape	Communications method	Applicable Amplifier Units	Order code
	Sensor communication unit for EtherCAT	E3NX-FA0 E3NC-LA0 E3NC-SA0	E3NW-ECT
	Sensor dispersion (slave) unit		E3NW-DS

Specifications

Item	Type	Standard models		Advanced models					Model for sensor communications unit
	NPN output	E3NX-FA11	E3NX-FA6	E3NX-FA21	E3NX-FA7	E3NX-FA7TW	E3NX-FA24	-	E3NX-FA0
	PNP output	E3NX-FA41	E3NX-FA8	E3NX-FA51	E3NX-FA9	E3NX-FA9TW	E3NX-FA54	E3NX-FA54TW	
	Connection method	Pre-wired	Wire-saving connector	Pre-wired	Wire-saving connector		M8 connector		Connector for sensor communications unit
Inputs/outputs	Outputs	1 output		2 outputs	1 output	2 outputs	1 output	2 outputs	via com. protocol
	External inputs	-		1 input	1 input	-	1 input	-	-
Light source (wavelength)		Red, 4-element LED (625 nm)							
Power supply voltage		10 to 30 VDC, including 10% ripple (p-p)							
Power consumption		At power supply voltage of 24 VDC Standard model or model for sensor communications unit: Normal mode: 960 mW max. (current consumption: 40 mA max.), Power saving eco mode: 840 mW max. (current consumption: 35 mA max.) Advanced model: Normal mode: 1,080 mW max. (current consumption: 45 mA max.), Power saving eco mode: 930 mW max. (current consumption: 40 mA max.)							
Control output		Load power supply voltage: 30 VDC max., open-collector output Load current: groups of 1 to 3 amplifiers: 100 mA max., groups of 4 to 30 amplifiers: 20 mA max. Residual voltage: at load current of less than 10 mA: 1 V max. at load current of 10 to 100 mA: 2 V max. OFF current: 0.1 mA max.							-
Response time	Super-high-speed Mode (SHS) ^{*1}	Operate or reset for model with 1 output: 30 μs, with 2 outputs: 32 μs							
	High-speed Mode (HS)	Operate or reset: 250 μs							
	Standard Mode (Std)	Operate or reset: 1 ms							
	Giga-power Mode (GIGA)	Operate or reset: 16 ms							
No. of units for mutual interference prevention	Super-high-speed Mode (SHS) ^{*1}	0							
	High-speed Mode (HS)	10							
	Standard Mode (Std)	10							
	Giga-power Mode (GIGA)	10							
Functions		Auto power control (APC), dynamic power control (DPC), timer, zero reset, resetting settings, eco mode, bank switching, power tuning, and hysteresis width							
Maximum connectable units		30							

^{*1} The mutual interference prevention function is disabled if the detection mode is set to super-high-speed mode.

Easy One-Button-Teaching/Smart Tuning



Automatic setting of optimum values

Threshold + Incident level

5000 **9999**

Set to the intermediate value between the incident levels with and without a workpiece.

Incident level adjustment with and without a workpiece

Dynamic range increased by a factor of 40,000

Easy setting of optimum power and threshold by pushing tune button twice.

Smart power control

Smart Power Control

APC Always ON

(AUTO POWER CONTROL)

Automatically compensate light intensity

DPC

(DYNAMIC POWER CONTROL)

Automatically compensate incident level

Flashes when compensation is no longer possible.

















Enhanced signal stability control for compensating power reductions caused by temperature drift, dust or aging of LED. Alarm output added for predictive maintenance.

N-Smart platform



The N-Smart platform provides wide portfolio of advanced sensors – all with the same intuitive operation concept and field bus connectivity.

Accessories

Shape	Type	Comment	Order code
	Focal lens	<ul style="list-style-type: none"> Extends sensing distance by more than 500% For M4 Through beam fibers E32-TC200, E32-ET11R, E32-T11 (fits M2.6 thread) 2 pcs per set 	E39-F1
	Focal lens (side view)	<ul style="list-style-type: none"> For M4 through beam fibers E32-TC200, E32-ET11R, E32-T11, E32-T61-S, E32-T81R-S (fits M2.6 thread) Temperature range -40 to 200°C 2 pcs per set 	E39-F2
	Focal lens (variable)	<ul style="list-style-type: none"> For precision detection with E32-D32, E32-EC41 	E39-F3A
	Focal lens	<ul style="list-style-type: none"> For precision detection with E32-EC41 	E39-F3A-5
		<ul style="list-style-type: none"> For precision detection with E32-EC41 	E39-F3B
		<ul style="list-style-type: none"> For precision detection with M6 coaxial diffuse reflective fibers (e.g. E32-CC200) 	E39-F18
	Focal lens (side view, variable)	<ul style="list-style-type: none"> For precision detection with E32-EC31 	E39-EF51
	Focal lens (heat resistant)	<ul style="list-style-type: none"> Extends sensing distance by more than 500% For M4 through beam fibers E32-ET51, E32-T61, E32-T61-S, E32-T81R, E32-T81R-S (fits M4 thread) Temperature range -60 to 350°C 2 pcs per set 	E39-EF1-37-2
		<ul style="list-style-type: none"> For M4 through beam fibers E32-ET51, E32-T61, E32-T61-S, E32-T81R, E32-T81R-S (fits M4 thread) Temperature range -60 to 350°C 2 pcs per set 	E39-F16
	Focal lens (vacuum resistant, heat resistant)	<ul style="list-style-type: none"> Fits E32-T51V and E32-T54V (fits M2.6 thread) 2 units per set Heat resistant up to 120°C 	E39-F1V
	Fiber cutter	<ul style="list-style-type: none"> Included in applicable fiber 	E39-F4
	Thin fiber attachment	<ul style="list-style-type: none"> Amplifier adapter for thin fibers Included in applicable fiber (2 sets) 	E39-F9
	Sleeve bender	<ul style="list-style-type: none"> For E32-TC200B(4) For E32-TC200F(4) For E32-DC200F(4) 	E39-F11
	Single fiber extension connector	<ul style="list-style-type: none"> Fiber extension connector for 2.2 mm dia standard fibers One unit 	E39-F10
	Dual fiber extension connector	<ul style="list-style-type: none"> For fibers with dia 2.2 	E39-F13
		<ul style="list-style-type: none"> For fiber with dia 1.0 	E39-F14
		<ul style="list-style-type: none"> For fibers with dia between 1.0 and 2.2 	E39-F15
	Protective spiral tube ^{*1}	<ul style="list-style-type: none"> For M3 diffuse type sensors Length 1 m 	E39-F32A
		<ul style="list-style-type: none"> For M3 through beam type sensors Length 1 m 	E39-F32B
		<ul style="list-style-type: none"> For M4 through beam type sensors Length 1 m 	E39-F32C
		<ul style="list-style-type: none"> For M6 diffuse type sensors Length 1 m 	E39-F32D
	Fiber on roll ^{*2}	<ul style="list-style-type: none"> Dia 2.2 mm Standard moncore, 10 mm bending radius -40 to 80°C 	E32-E01 100M
		<ul style="list-style-type: none"> Dia 1.1 mm Standard moncore, 15 mm bending radius -40 to 80°C 	E32-E02 100M
		<ul style="list-style-type: none"> Dia 2.2 mm High flex multicore, 1 mm bending radius -40 to 80°C 	E32-E01R 100M
		<ul style="list-style-type: none"> Dia 1.1 mm High flex multicore, 1 mm bending radius -40 to 80°C 	E32-E02R 100M
		<ul style="list-style-type: none"> Dia 2.2 mm High temperature moncore, 20 mm bending radius -60 to 150°C 	E32-E05 100M

*1 Protective spiral tubes with 0.5 m length are available. Add '5' to order code ... e.g. E39-F32A5

*2 Fiber length 100 m on a roll – cut to length

ZERO TOLERANCE ON FAILURE

Tested reliability for demanding conditions

Our inductive sensors are designed and tested to ensure a long service life and to achieve maximum machine availability even in the harshest environments.



This trusted reliability makes the E2A one of the world's most popular and successful inductive proximity sensors with more than one million units sold every year.

- Wide portfolio and application range
- Highest reliability even in demanding environments
- Designed for flexibility - modular housing design for best performance fit

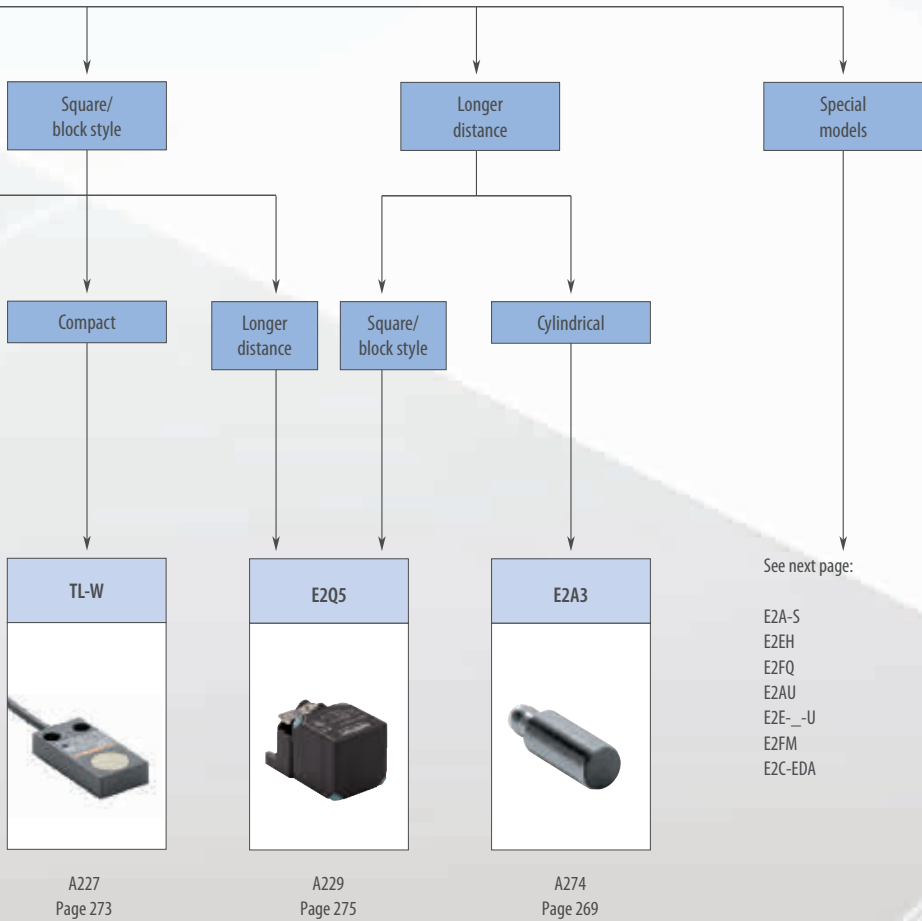







Selection table



Format		Cylindrical			
					
Model	E2A	E2A3	E2A-S	E2B	
361° product line	PRO	PRO ^{plus}	PRO	LITE	
Type	Compact	Long distance	Compact	Compact	
Material	Brass, SUS	Brass	Stainless steel	Stainless steel	
Max. sensing distance	dia. 3	-	-	-	
	dia. 4	-	-	-	
	M5	-	-	-	
	dia. 6.5	-	-	-	
	M8	2/4 mm	3 mm	2/4 mm	2/4 mm
	M12	4/8 mm	6 mm	4/8 mm	4/8 mm
	M18	8/16 mm	11 mm	8/16 mm	8/16 mm
	M30	15/30 mm	20 mm	15/20 mm	15/30 mm
	19 × 6 × 6	-	-	-	-
	22 × 8 × 6	-	-	-	-
	31 × 18 × 10	-	-	-	-
53 × 40 × 23	-	-	-	-	
67 × 40 × 40	-	-	-	-	
Mount.	Shielded	■	■	■	
	Non-shielded	■	-	■	
Oper. mode	NO	■	■	■	
	NC	■	■	■	
	NO + NC	■	-	■	
Wiring	DC 2-wire	■	-	-	
	DC 3-wire	■	■	■	
	DC 4-wire	■	-	■	
	AC 2-wire	-	-	-	
Voltage	10 to 30 VDC	■	■	■	
	12 to 240 VAC	-	-	-	
IP rating	IP67	■	■	■	
	IP69K	■	■	-	
Page/Quick Link	266	269	268	270	

Special models

Type	Vehicle usage certified	Detergent and heat resistant	Chemical resistant	Small diameter
				
Model	E2AU	E2EH	E2FQ	μPROX E2E
361° product line	PRO ^{plus}	PRO ^{plus}	PRO ^{plus}	PRO ^{plus}
Key features	<ul style="list-style-type: none"> e1 type approval (according to automotive directive 2005/83/EC) E1 (according to vehicle regulation ECE-R10) 	<ul style="list-style-type: none"> Stainless steel housing 120°C heat resistance 	<ul style="list-style-type: none"> PTFE housing 	<ul style="list-style-type: none"> High frequency of 5 kHz: suitable for high-speed counting All sizes are also available as non-shielded types
dia. 3	-	-	-	■
dia. 4	-	-	-	■
dia. 6.5	-	-	-	■
M5	-	-	-	■
M8	-	-	-	-
M12	■	■	■	-
M18	■	■	■	-
M30	■	■	■	-
Page/Quick Link	277	276	A246	272

Format		Square		
				
Model	TL-W	E2S	E2Q5	
Type	Compact	Miniature	Long distance	
Material	ABS	Polyarylate	PBT	
Max. sensing distance	dia. 3	–	–	
	dia. 4	–	–	
	M5	–	–	
	dia. 5.4	–	–	
	M8	–	–	
	M12	–	–	
	M18	–	–	
	M30	–	–	
	19 × 6 × 6	–	1.6 mm	
	22 × 8 × 6	3 mm	2.5 mm	
31 × 18 × 10	5 mm	–		
53 × 40 × 23	20 mm	–		
67 × 40 × 40	–	–	40 mm	
Mount.	Shielded	■	–	■
	Non-shielded	■	■	■
Oper. mode	NO	■	■	■
	NC	■	■	–
	NO + NC	–	–	■
Wiring	DC 2-wire	■	■	–
	DC 3-wire	■	■	■
	DC 4-wire	–	–	■
	AC 2-wire	–	–	–
Voltage	10 to 30 VDC	■	■	■
	12 to 240 VAC	–	–	–
IP rating	IP67	■	■	■
	IP69K	–	–	■
	Page/Quick Link	273	274	275

Special models

Type	Full metal face	Oil resistant	High precision positioning	
				
Model	E2FM	E2E_U	E2C-EDA	
361° product line	PRO ^{plus}	PRO ^{plus}	PRO ^{plus}	
Key features	<ul style="list-style-type: none"> Immune to aluminum and cast iron chips on sensing surface Oil resistant 	<ul style="list-style-type: none"> Tested oil resistance on commonly used lubricants 	<ul style="list-style-type: none"> Distance teaching up to μm accuracy 	
dia. 3	–	–	■	
dia. 4	–	–	–	
dia. 6.5	–	–	–	
M5	–	–	–	
M8	■	■	–	
M12	■	■	■	
M18	■	■	■	
M30	■	■	–	
	Page/Quick Link	279	278	281

■ Standard □ Available – No/not available



Extended sensing range inductive sensor in cylindrical brass housing

The high quality and the long-life design of the E2A extended sensing distance provide high operational reliability, accurate performance and long sensor lifetime for a wide range of applications.

- Extended (double) sensing distance
- IP67 and IP69k for highest water protection
- DC 3-wire (NO, NC)
- Wide temperature range –40 to 70°C
- 200 mA max load current
- Wide installation and connectivity range through modular concept



Ordering information

Pre-wired

Size			Sensing distance	Thread length (overall length)	Output configuration	Order code (for pre-wired types with 2 m PVC cable)		
						Operation mode NO	Operation mode NC	DC 4-wire (NO+NC-PNP models)
M8	■	–	2.0 mm	27 (40) mm	PNP ^{*1}	E2A-S08KS02-WP-B1 2M ^{*2}	E2A-S08KS02-WP-B2 2M ^{*2}	E2A-S08LS02-WP-B3 2M ^{*3}
	–	■	4.0 mm	21 (40) mm	PNP ^{*1}	E2A-S08KN04-WP-B1 2M ^{*2}	E2A-S08KN04-WP-B2 2M ^{*2}	E2A-S08LN04-WP-B3 2M ^{*3}
M12	■	–	4.0 mm	34 (50) mm	PNP ^{*1}	E2A-M12KS04-WP-B1 2M	E2A-M12KS04-WP-B2 2M	E2A-M12KS04-WP-B3 2M
	–	■	8.0 mm	27 (50) mm	PNP ^{*1}	E2A-M12KN08-WP-B1 2M	E2A-M12KN08-WP-B2 2M	E2A-M12KN08-WP-B3 2M
M18	■	–	8.0 mm	39 (59) mm	PNP ^{*1}	E2A-M18KS08-WP-B1 2M	E2A-M18KS08-WP-B2 2M	E2A-M18KS08-WP-B3 2M
	–	■	16.0 mm	29 (59) mm	PNP ^{*1}	E2A-M18KN16-WP-B1 2M	E2A-M18KN16-WP-B2 2M	E2A-M18KN16-WP-B3 2M
M30	■	–	15.0 mm	44 (64) mm	PNP ^{*1}	E2A-M30KS15-WP-B1 2M	E2A-M30KS15-WP-B2 2M	E2A-M30KS15-WP-B3 2M
	–	■	20.0 mm ^{*4}	29 (64) mm	PNP ^{*1}	E2A-M30KN20-WP-B1 2M	E2A-M30KN20-WP-B2 2M	E2A-M30KN20-WP-B3 2M

Connector types (M12)

Size			Sensing distance	Thread length (overall length)	Output configuration	Order code (for M12 connector types)		
						Operation mode NO	Operation mode NC	DC 4-wire (NO+NC-PNP models)
M8	■	–	2.0 mm	27 (43) mm	PNP ^{*1}	E2A-S08KS02-M1-B1 ^{*2}	E2A-S08KS02-M1-B2 ^{*2}	E2A-S08LS02-M3-B3 ^{*5}
	–	■	4.0 mm	21 (43) mm	PNP ^{*1}	E2A-S08KN04-M1-B1 ^{*2}	E2A-S08KN04-M1-B2 ^{*2}	E2A-S08LN04-M3-B3 ^{*5}
M12	■	–	4.0 mm	24 (48) mm	PNP ^{*1}	E2A-M12KS04-M1-B1	E2A-M12KS04-M1-B2	E2A-M12KS04-M1-B3
	–	■	8.0 mm	27 (48) mm	PNP ^{*1}	E2A-M12KN08-M1-B1	E2A-M12KN08-M1-B2	E2A-M12KN08-M1-B3
M18	■	–	8.0 mm	39 (53) mm	PNP ^{*1}	E2A-M18KS08-M1-B1	E2A-M18KS08-M1-B2	E2A-M18KS08-M1-B3
	–	■	16.0 mm	29 (53) mm	PNP ^{*1}	E2A-M18KN16-M1-B1	E2A-M18KN16-M1-B2	E2A-M18KN16-M1-B3
M30	■	–	15.0 mm	44 (58) mm	PNP ^{*1}	E2A-M30KS15-M1-B1	E2A-M30KS15-M1-B2	E2A-M30KS15-M1-B3
	–	■	20.0 mm ^{*4}	29 (58) mm	PNP ^{*1}	E2A-M30KN20-M1-B1	E2A-M30KN20-M1-B2	E2A-M30KN20-M1-B3

DC 2-Wire models

Size			Sensing distance	Thread length (overall length)	Body material	Operation mode	Order code (for pre-wired types with 2 m PVC cable)
							DC 2-wire (NO) ^{*1}
M8	■	–	2.0 mm	27 (40) mm	Stainless steel	NO	E2A-S08KS02-WP-D1 2M
	–	■	4.0 mm	21 (40) mm			E2A-S08KN04-WP-D1 2M
M12	■	–	4.0 mm	34 (50) mm	Brass-nickel plated		E2A-M12KS04-WP-D1 2M
	–	■	8.0 mm	27 (50) mm			E2A-M12KN08-WP-D1 2M
M18	■	–	8.0 mm	39 (59) mm			E2A-M18KS08-WP-D1 2M
	–	■	16.0 mm	29 (59) mm			E2A-M18KN16-WP-D1 2M
M30	■	–	15.0 mm	44 (64) mm			E2A-M30KS15-WP-D1 2M
	–	■	20.0 mm	29 (64) mm			E2A-M30KN20-WP-D1 2M

Gold-plated pins models

Size			Sensing distance	Thread length (overall length)	Output configuration	Connection	Body material	Operation mode	Order code
M8	■	–	2 mm	27 (40) mm	NPN	Connector M8 3 pin: gold-plated	Stainless steel	NO	E2A-S08KS02-M5-C1-4
	–	■	–	49 (62) mm					E2A-S08LS02-M5-C1-4
M12	■	–	4 mm	34 (48) mm	PNP	Connector M12 4 pin: gold-plated	Brass-nickel plated		E2A-M12KS04-M1-B1-4
	–	■	8 mm	–					E2A-M12KN08-M1-B1-4

^{*1} NPN models are available. For ordering replace “-B1”, “-B2”, “-B3” or “-D1” by “-C1”, “-C2” or “-C3”.

^{*2} M8 sized housings are only available in stainless steel (SUS 303).

^{*3} Longer housing with thread length 49 mm and overall length 62 mm.

^{*4} Models with longer sensing distances of 30 mm and 35 mm are available.

^{*5} Models with M8 4-pin connector and thread length 49 mm and overall length 61 mm.

Specifications

(Exemplary for shielded versions.)

Item	M8	M12	M18	M30
	E2A-S08KS	E2A-M12KS	E2A-M18KS	E2A-M30KS
Sensing distance	2 mm±10%	4 mm±10%	8 mm±10%	15 mm±10%
Response frequency	1,500 Hz	1,000 Hz	500 Hz	250 Hz
Power supply voltage (operating voltage)	12 to 24 VDC. Ripple (p-p): 10% max. (10 to 32 VDC)			
Protective circuits	Power supply reverse polarity protection, surge suppressor, short-circuit protection		Output reverse polarity protection, power supply reverse polarity protection, surge suppressor, short-circuit protection	
Ambient temperature	Operating	-40 to 70°C		
	Storage	-40 to 85°C (with no icing or condensation)		
Degree of protection	IP67 after IEC 60529; IP69K after DIN 40050 part 9			
Material	Case	Stainless steel	Brass-nickel plated	
	Sensing surface	PBT		

Optional features

Refer to complete datasheet or contact your OMRON representative for the below optional features

Sensing module and body

- single sensing distance (ideal for compatibility with previous machine generations)
- Long body (ideal for mounting through thicker constructions)

Connection

- M8 4-pin (for ordering replace -M1 by -M3 e.g. E2A-S08KS02-M3-B1)
- M8 3-pin (for ordering replace -M1 by -M5 e.g. E2A-S08KS02-M5-B1)
- PUR cable
- Pigtails with M8 or M12 plugs

Output

- 400 mA max. load current (ideal for switching higher load currents directly)
- DC 2-wire (ideal for reduced wiring; leakage current can be used to detect cable breakage)
- DC 4-wire (NO+NC output – ideal for reduced stock for spare parts; antivalent signal can be used to detect cable breakage)



High water resistance



Cable breakage protection



High mechanical resistance

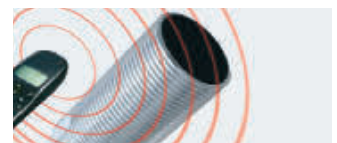

High electro-magnetic noise immunity



High resistance against temperature change



High vibration resistance



Extended sensing range inductive sensor in cylindrical stainless steel housing

The performance and operational reliability of the E2A family is also available in stainless steel housing.

- Stainless steel housing (SUS 303)



Ordering information

Pre-wired

Size			Sensing distance	Thread length (overall length)	Output configuration	Order code (for pre-wired types with 2 m PVC cable)	
						Operation mode NO	Operation mode NC
M8	■	–	2.0 mm	27 (40) mm	PNP ^{*1}	E2A-S08KS02-WP-B1 2M	E2A-S08KS02-WP-B2 2M
	–	■	4.0 mm	21 (40) mm	PNP ^{*1}	E2A-S08KN04-WP-B1 2M	E2A-S08KN04-WP-B2 2M
M12	■	–	4.0 mm	34 (50) mm	PNP ^{*1}	E2A-S12KS04-WP-B1 2M	E2A-S12KS04-WP-B2 2M
	–	■	8.0 mm	27 (50) mm	PNP ^{*1}	E2A-S12KN08-WP-B1 2M	E2A-S12KN08-WP-B2 2M
M18	■	–	8.0 mm	39 (59) mm	PNP ^{*1}	E2A-S18KS08-WP-B1 2M	E2A-S18KS08-WP-B2 2M
	–	■	16.0 mm	29 (59) mm	PNP ^{*1}	E2A-S18KN16-WP-B1 2M	E2A-S18KN16-WP-B2 2M
M30	■	–	15.0 mm	44 (64) mm	PNP ^{*1}	E2A-S30KS15-WP-B1 2M	E2A-S30KS15-WP-B2 2M
	–	■	20.0 mm ^{*2}	29 (64) mm	PNP ^{*1}	E2A-S30KN20-WP-B1 2M	E2A-S30KN20-WP-B2 2M

Connector types (M12)

Size			Sensing distance	Thread length (overall length)	Output configuration	Order code (for M12 connector types)	
						Operation mode NO	Operation mode NC
M8	■	–	2.0 mm	27 (43) mm	PNP ^{*1}	E2A-S08KS02-M1-B1	E2A-S08KS02-M1-B2
	–	■	4.0 mm	21 (43) mm	PNP ^{*1}	E2A-S08KN04-M1-B1	E2A-S08KN04-M1-B2
M12	■	–	4.0 mm	24 (48) mm	PNP ^{*1}	E2A-S12KS04-M1-B1	E2A-S12KS04-M1-B2
	–	■	8.0 mm	27 (48) mm	PNP ^{*1}	E2A-S12KN08-M1-B1	E2A-S12KN08-M1-B2
M18	■	–	8.0 mm	39 (53) mm	PNP ^{*1}	E2A-S18KS08-M1-B1	E2A-S18KS08-M1-B2
	–	■	16.0 mm	29 (53) mm	PNP ^{*1}	E2A-S18KN16-M1-B1	E2A-S18KN16-M1-B2
M30	■	–	15.0 mm	44 (58) mm	PNP ^{*1}	E2A-S30KS15-M1-B1	E2A-S30KS15-M1-B2
	–	■	20.0 mm ^{*2}	29 (58) mm	PNP ^{*1}	E2A-S30KN20-M1-B1	E2A-S30KN20-M1-B2

^{*1} NPN models are available. For ordering replace “-B1” or “-B2” by “-C1” or “-C2”.

^{*2} Models with longer sensing distances of 30 mm and 35 mm are available.

Specifications

(Exemplary for shielded versions)

Item	M8		M12	M18	M30
	E2A-S08KS		E2A-M12KS	E2A-M18KS	E2A-M30KS
Sensing distance	2 mm±10%		4 mm±10%	8 mm±10%	15 mm±10%
Response frequency	1,500 Hz		1,000 Hz	500 Hz	250 Hz
Power supply voltage (operating voltage)	12 to 24 VDC. Ripple (p-p): 10% max. (10 to 32 VDC)				
Protective circuits	Power supply reverse polarity protection, surge suppressor, short-circuit protection				
Ambient temperature	Operating	–40 to 70 °C			
	Storage	–40 to 85 °C (with no icing or condensation)			
Degree of protection	IP67 after IEC 60529; IP69K after DIN 40050 part 9				
Material	Case	Stainless steel (SUS 303)			
	Sensing surface	PBT			



Long (triple) distance inductive sensor in cylindrical brass housing

The E2A3 family features an optimised sensing performance to achieve triple sensing distance for quasi flush mounting requirements.

- Triple distance for enhanced sensor protection from mechanical damage
- IP67 and IP69k

Ordering information

Pre-wired

(For different cable materials and lengths, special housing length or special connectors, please refer to complete datasheet.)

Size			Sensing distance	Thread length (overall length)	Output configuration	Order code (for pre-wired types with 2 m PVC cable)	
						Operation mode: NO	Operation mode: NC
M8	■	–	3.0 mm	27 (40) mm	PNP	E2A3-S08KS03-WP-B1 2M	E2A3-S08KS03-WP-B2 2M
					NPN	E2A3-S08KS03-WP-C1 2M	E2A3-S08KS03-WP-C2 2M
M12	■	–	6.0 mm	34 (50) mm	PNP	E2A3-M12KS06-WP-B1 2M	E2A3-M12KS06-WP-B2 2M
					NPN	E2A3-M12KS06-WP-C1 2M	E2A3-M12KS06-WP-C2 2M
M18	■	–	11.0 mm	39 (60) mm	PNP	E2A3-M18KS11-WP-B1 2M	E2A3-M18KS11-WP-B2 2M
					NPN	E2A3-M18KS11-WP-C1 2M	E2A3-M18KS11-WP-C2 2M
M30	■	–	20.0 mm	44 (65) mm	PNP	E2A3-M30KS20-WP-B1 2M	E2A3-M30KS20-WP-B2 2M
					NPN	E2A3-M30KS20-WP-C1 2M	E2A3-M30KS20-WP-C2 2M

Connector types (M12)

Size			Sensing distance	Thread length (overall length)	Output configuration	Order code (for M12 connector types)	
						Operation mode: NO	Operation mode: NC
M8	■	–	3.0 mm	27 (44) mm	PNP	E2A3-S08KS03-M1-B1	E2A3-S08KS03-M1-B2
					NPN	E2A3-S08KS03-M1-C1	E2A3-S08KS03-M1-C2
M12	■	–	6.0 mm	34 (49) mm	PNP	E2A3-M12KS06-M1-B1	E2A3-M12KS06-M1-B2
					NPN	E2A3-M12KS06-M1-C1	E2A3-M12KS06-M1-C2
M18	■	–	11.0 mm	39 (54) mm	PNP	E2A3-M18KS11-M1-B1	E2A3-M18KS11-M1-B2
					NPN	E2A3-M18KS11-M1-C1	E2A3-M18KS11-M1-C2
M30	■	–	20.0 mm	44 (59) mm	PNP	E2A3-M30KS20-M1-B1	E2A3-M30KS20-M1-B2
					NPN	E2A3-M30KS20-M1-C1	E2A3-M30KS20-M1-C2

Specifications

Item	M8	M12	M18	M30
	E2A3-S08KS03	E2A3-M12KS06-	E2A3-M18KS11	E2A3-M30KS20
Sensing distance	3 mm±10%	6 mm±10%	11 mm±10%	20 mm±10%
Response frequency	700 Hz	350 Hz	250 Hz	80 Hz
Power supply voltage (operating voltage)	12 to 24 VDC. Ripple (p-p): 10% max. (10 to 32 VDC)			
Protective circuits	Power supply reverse polarity protection, surge suppressor, short-circuit protection		Output reverse polarity protection, power supply reverse polarity protection, surge suppressor, short-circuit protection	
Ambient temperature	–25 to 70°C			
Degree of protection	IP67 after IEC 60529; IP69K after DIN 40050 part 9			
Material	Case		Sensing surface	
	Stainless steel		Brass-nickel plated	
	PBT			



The ideal solution for standard industrial conditions

Thanks to the simple construction and Omron's innovative "hot melt" production process, the E2B sensors embody two characteristics: value-for-money and high reliability.

- All-round-visible indicator
- The laser printed part number
- Vibration shock resistance: IEC 60947-5-2 (10 to 55 Hz)
- Operating temperature: -25 to 70°C
- Water resistance: IP67



Ordering information

Pre-wired

Size			Sensing distance	Output configuration	Order code (for pre-wired types with 2 m PVC cable)	
					Operation mode NO	Operation mode NC
M8	■	–	2.0 mm	PNP ^{*1}	E2B-S08KS02-WP-B1 2M ^{*2}	E2B-S08KS02-WP-B2 2M ^{*2}
	–	■	4.0 mm	PNP ^{*1}	E2B-S08KN04-WP-B1 2M ^{*2}	E2B-S08KN04-WP-B2 2M ^{*2}
M12	■	–	4.0 mm	PNP ^{*1}	E2B-M12KS04-WP-B1 2M	E2B-M12KS04-WP-B2 2M
	–	■	8.0 mm	PNP ^{*1}	E2B-M12KN08-WP-B1 2M	E2B-M12KN08-WP-B2 2M
M18	■	–	8.0 mm	PNP ^{*1}	E2B-M18KS08-WP-B1 2M	E2B-M18KS08-WP-B2 2M
	–	■	16.0 mm	PNP ^{*1}	E2B-M18KN16-WP-B1 2M	E2B-M18KN16-WP-B2 2M
M30	■	–	15.0 mm	PNP ^{*1}	E2B-M30KS15-WP-B1 2M	E2B-M30KS15-WP-B2 2M
	–	■	30.0 mm	PNP ^{*1}	E2B-M30LN30-WP-B1 2M	E2B-M30LN30-WP-B2 2M

Connector types

Size			Sensing distance	Output configuration	Order code	
					Operation mode NO	Operation mode NC
M8	■	–	2.0 mm	PNP ^{*1}	E2B-S08KS02-MC-B1 ^{*2}	E2B-S08KS02-MC-B2 ^{*2}
	–	■	4.0 mm	PNP ^{*1}	E2B-S08KN04-MC-B1 ^{*2}	E2B-S08KN04-MC-B2 ^{*2}
M12	■	–	4.0 mm	PNP ^{*1}	E2B-M12KS04-M1-B1	E2B-M12KS04-M1-B2
	–	■	8.0 mm	PNP ^{*1}	E2B-M12KN08-M1-B1	E2B-M12KN08-M1-B2
M18	■	–	8.0 mm	PNP ^{*1}	E2B-M18KS08-M1-B1	E2B-M18KS08-M1-B2
	–	■	16.0 mm	PNP ^{*1}	E2B-M18KN16-M1-B1	E2B-M18KN16-M1-B2
M30	■	–	15.0 mm	PNP ^{*1}	E2B-M30KS15-M1-B1	E2B-M30KS15-M1-B2
	–	■	30.0 mm	PNP ^{*1}	E2A-M30LN30-M1-B1	E2B-M30LN30-M1-B2

^{*1} NPN models are available. For ordering replace "-B1" or "-B2" by "-C1" or "-C2".

^{*2} M8 sized housings are only available in stainless steel (SUS 303).

Optional features

Refer to complete datasheet or contact your OMRON representative for the below optional features

Sensing module and body

- Single sensing distance (ideal for compatibility with previous machine generations)
- Long body (ideal for mounting through thicker constructions)

Connection

- M8 3-pin -MC e.g. E2B-S08KS02-MC-B1

Output

- 200 mA max. load current

Specifications

(Exemplary for shielded versions.)

Item	M8	M12	M18	M30
	E2B-S08KS	E2B-M12KS	E2B-M18KS	E2B-M30KS
Sensing distance	2 mm±10%	4 mm±10%	8 mm±10%	15 mm±10%
Response frequency	1,500 Hz	1,000 Hz	500 Hz	250 Hz
Power supply voltage (operating voltage)	12 to 24 VDC. Ripple (p-p): 10% max. (10 to 32 VDC)			
Protective circuits	Output reverse polarity protection, Power source circuit reverse polarity protection			
Ambient temperature	Operating and storage: -25 to 70°C			
Degree of protection	IP67 after IEC 60529			
Material	Case	Stainless steel	Brass-nickel plated	
	Sensing surface	PBT		



High-visibility ring LED indicator



Laser printing part number



Small diameter proximity sensors for high precision detection

Omron's latest inductive technology has now been applied to a new range of small diameter inductive sensors. The new μPROX E2E provides precision detection and allows installation in even the most confined spaces. The portfolio has been extended to include non-shielded types and versions with pig-tail connector leads.

- Miniature size: 3, 4, 6.5 mm and M4, M5 diameters
- High frequency of 5 kHz: suitable for high-speed counting
- All sizes are also available as non-shielded types
- IP67 water ingress protection
- Highly visible indicators for easy operation confirmation

Ordering information

Size	Sensing distance		Connection	Output configuration	Order code	
	Operation mode NO	Operation mode NC				
dia 3 mm	■	0.8 mm	PW	PNP	E2E-C03SR8-WC-B1 2M OMS	E2E-C03SR8-WC-B2 2M OMS
		2 mm		NPN	E2E-C03SR8-WC-C1 2M OMS	E2E-C03SR8-WC-C2 2M OMS
		0.8 mm	PW	PNP	E2E-C03N02-WC-B1 2M OMS	E2E-C03N02-WC-B2 2M OMS
	■			NPN	E2E-C03N02-WC-C1 2M OMS	E2E-C03N02-WC-C2 2M OMS
M4	■	0.8 mm	PW	PNP	E2E-S04SR8-WC-B1 2M OMS	E2E-S04SR8-WC-B2 2M OMS
		2 mm		NPN	E2E-S04SR8-WC-C1 2M OMS	E2E-S04SR8-WC-C2 2M OMS
		0.8 mm	PW	PNP	E2E-S04N02-WC-B1 2M OMS	E2E-S04N02-WC-B2 2M OMS
	■			NPN	E2E-S04N02-WC-C1 2M OMS	E2E-S04N02-WC-C2 2M OMS
dia 4 mm	■	1.2 mm	PW	PNP	E2E-C04S12-WC-B1 2M OMS	E2E-C04S12-WC-B2 2M OMS
		3 mm		NPN	E2E-C04S12-WC-C1 2M OMS	E2E-C04S12-WC-C2 2M OMS
		1.2 mm	PW	PNP	E2E-C04N03-WC-B1 2M OMS	E2E-C04N03-WC-B2 2M OMS
	■			NPN	E2E-C04N03-WC-C1 2M OMS	E2E-C04N03-WC-C2 2M OMS
M5	■	1.2 mm	PW	PNP	E2E-S05S12-WC-B1 2M OMS	E2E-S05S12-WC-B2 2M OMS
		3 mm		NPN	E2E-S05S12-WC-C1 2M OMS	E2E-S05S12-WC-C2 2M OMS
		1.2 mm	PW	PNP	E2E-S05N03-WC-B1 2M OMS	E2E-S05N03-WC-B2 2M OMS
	■			NPN	E2E-S05N03-WC-C1 2M OMS	E2E-S05N03-WC-C2 2M OMS
dia 6.5 mm	■	2 mm	PW	PNP	E2E-C06S02-WC-B1 2M OMS	E2E-C06S02-WC-B2 2M OMS
				NPN	E2E-C06S02-WC-C1 2M OMS	E2E-C06S02-WC-C2 2M OMS
			M8(3P)	PNP	E2E-C06S02-MC-B1 OMS	E2E-C06S02-MC-B2 OMS
	■			NPN	E2E-C06S02-MC-C1 OMS	E2E-C06S02-MC-C2 OMS
		4 mm	PW	PNP	E2E-C06N04-WC-B1 2M OMS	E2E-C06N04-WC-B2 2M OMS
				NPN	E2E-C06N04-WC-C1 2M OMS	E2E-C06N04-WC-C2 2M OMS
			M8(3P)	PNP	E2E-C06N04-MC-B1 OMS	E2E-C06N04-MC-B2 OMS
	■			NPN	E2E-C06N04-MC-C1 OMS	E2E-C06N04-MC-C2 OMS

Specifications

Item	dia. 3/M4		dia. 4/M5		dia. 6.5	
	E2E-C03S/-S04S	E2E-C03N/-S04N	E2E-C04S/-S05S	E2E-C04N/-S05N	E2E-C06S	E2E-C06N
Sensing distance	0.8 mm±10%	2.0 mm±10%	1.2 mm±10%	3.0 mm±10%	2.0 mm±10%	4 mm±10.0%
Setting distance	0 to 0.56 mm	0 to 1.4 mm	0 to 0.84 mm	0 to 2.1 mm	0 to 1.4 mm	0 to 2.8 mm
Response frequency	5 kHz	3 kHz	4 kHz	2 kHz	3 kHz	4 kHz
Supply voltage	10 to 30 VDC					
Current consumption	≤10 mA					
Max. control output	≤50 mA		≤100 mA		≤200 mA	
Residual output voltage	≤2 V					
Ambient temperature range	-25 to 70°C					
Ambient temperature fluctuation	≤15%					
Degree of protection	IEC 60529 IP67					
Material	Case	Stainless steel (SUS303)				
	Sensing surface	Heat-resistant ABS				



Flat shape inductive sensor in compact plastic housing

The TL-W family offers a wide range of block style inductive sensors for simple mounting on flat surfaces. With sensing distances from 1.5 mm to 20 mm the TL-W is the ideal solution for all standard applications.

- IP67
- DC 2-wire and DC 3-wire models
- Sensing distances from 1.5 mm to 20 mm
- Side facing sensing face

Ordering information

DC 2-wire

Size in mm (H × W × D)	Sensing distance		Order code (for pre-wired types with 2 m PVC cable)		
	Operation mode normally open (NO)	Operation mode normally closed (NC)			
31 × 18 × 10	–	■	5 mm	TL-W5MD1	TL-W5MD2

DC 3-wire

Size in mm (H × W × D)	Sensing distance		Order code (for pre-wired types with 2 m PVC cable)				
	PNP-NO	PNP-NC	NPN-NO	NPN-NC			
25 × 8 × 5	–	■	1.5 mm	TL-W1R5MB1	–	TL-W1R5MC1	–
22 × 8 × 6			3 mm	TL-W3MB1	TL-W3MB2	TL-W3MC1	TL-W3MC2
31 × 18 × 10			5 mm	TL-W5MB1	TL-W5MB2	TL-W5MC1	TL-W5MC2
53 × 40 × 23			20 mm	–	–	TL-W20ME1	TL-W20ME2
31 × 18 × 10	■	–	5 mm	TL-W5F1	TL-W5F2	TL-W5E1	TL-W5E2

Specifications

Item	TL-W5MD_	TL-W1R5M_1	TL-W3M_	TL-W5M_	TL-W5E_/F_	TL-W20ME_
Sensing distance	5 mm±10%	1.5 mm±10%	3 mm±10%	5 mm±10%		20 mm±10%
Response frequency	500 Hz	1 kHz min.	600 Hz min.	500 Hz min.	300 Hz min.	40 Hz min.
Power supply voltage (operating voltage)	12 to 24 VDC (10 to 30 VDC) ripple (p-p): 10% max.				10 to 30 VDC with a ripple (p-p) of 20% max.	12 to 24 VDC (10 to 30 VDC) ripple (p-p): 10% max.
Protective circuits	Surge absorber; short-circuit protection		Surge suppressor; power supply reverse polarity protection			
Ambient temperature	Operating	–25 to 70°C (with no icing or condensation)				
	Storage					
Degree of protection	IEC60529 IP67					
Material	Case	Heat-resistant ABS resin			Diecast aluminum	Heat-resistant ABS resin
	Sensing surface	Heat-resistant ABS resin				







Miniature square inductive sensor in plastic housing

The E2S family features miniature block style plastic housings for simple mounting on flat surfaces. The durable plastic housing with front or side facing sensing surfaces, provide best value-performance ratio for machine part movement detection.





- Miniature housing
- Front and side facing sensing faces
- Models with simple one-screw mounting
- IP67

Ordering information

DC 2-wire

Size in mm (H × W × D)			Sensing distance	Sensing face		Order code (pre-wired types with 1 m cable length)	
						Operation mode NO	Operation mode NC
19 × 6 × 6	–	■	1.6 mm	■	–	E2S-W11 1M	E2S-W12 1M
23 × 8 × 8	–	■	2.5 mm	–	■	E2S-Q11 1M	E2S-Q12 1M
				■	–	E2S-W21 1M	E2S-W22 1M
				–	■	E2S-Q21 1M	E2S-Q22 1M

DC 3-wire

Size in mm (H × W × D)			Sensing distance	Sensing face		Output specifications	Order code (pre-wired types with 1 m cable length)	
							Operation mode NO	Operation mode NC
19 × 6 × 6	–	■	1.6 mm	■	–	NPN	E2S-W13 1M	E2S-W14 1M
27 × 8 × 8	–	■	2.5 mm	–	■		E2S-Q13 1M	E2S-Q14 1M
				■	–		E2S-W23 1M	E2S-W24 1M
19 × 6 × 6			1.6 mm	■	–	PNP	E2S-Q23 1M	E2S-Q24 1M
23 × 8 × 8			2.5 mm	–	■		E2S-W15 1M	E2S-W16 1M
				■	–		E2S-Q15 1M	E2S-Q16 1M
				–	■	E2S-W25 1M	E2S-W26 1M	
				–	■	E2S-Q25 1M	E2S-Q26 1M	

Specifications

Item	E2S-W1 E2S-Q1	E2S-W2 E2S-Q2
Sensing distance	1.6 mm ± 10%	2.5 mm ± 15%
Response frequency	1 kHz min.	
Power supply voltage (operating voltage)	12 to 24 VDC (10 to 30 VDC), ripple (p-p): 10% max.	
Protective circuits	Surge suppressor; power supply reverse polarity protection	
Ambient temperature	Operating	–25 to 70°C
	Storage	–40 to 85°C (with no icing or condensation)
Degree of protection	IEC60529 IP67	
Material	Case	Polyarylate





Long distance inductive proximity sensor in plastic housing

The long sensing distance and simple installation on flat surfaces make the E2Q5 ideal for the detection of large metal objects for example in automotive assembly lines.

- M12 Plug-in connection
- Integrated short circuit and reverse polarity protection
- Sensing face positioning: Y-axis 15°, X-axis 90° increments

Ordering information

Connector types (M12)

Size in mm (H × W × D)			Sensing distance	Sensing face	Output configuration	Order code (for M12 connector types)	
						Operation mode NO	Operation mode NO + NC
67 × 40 × 40	■	-	20 mm	Changeable	NPN	E2Q5-N20E1-M1	E2Q5-N20E3-M1
			40 mm		PNP	E2Q5-N20F1-M1	E2Q5-N20F3-M1
	-	■			NPN	E2Q5-N40ME1-M1	E2Q5-N40ME3-M1
			PNP		E2Q5-N40MF1-M1	E2Q5-N40MF3-M1	

Specifications

Item	E2Q5-N20__-M1	E2Q5-N40M_3-M1
Sensing distance	20 mm±10%	40 mm±10%
Response frequency	150 Hz	
Power supply voltage	10 to 30 VDC	
Protective circuits	Output reverse polarity protection, short-circuit protection	
Ambient temperature	Operating	-25 to 85°C
Degree of protection	IEC 60529 IP 67; IP69k after DIN 40050 part 9	
Material	Case	PBT
	Sensing face	PBT



Heat and detergent resistant inductive sensor in cylindrical stainless steel housing

The heat and detergent resistant inductive sensors allow reliable metal object or machine part detection in demanding environments such as food processing.

- Temperature resistant up to 120°C
- SUS316L housing with heat resistant plastic sensing face
- IP69k for highest water resistance
- ECOLAB tested and certified detergent resistance



Ordering information

Pre-wired

Size			Sensing distance	Output configuration	Order code (for pre-wired types with 2 m heat resistant PVC cable)	
					Operation mode NO	Operation mode NC
M12	■	-	3 mm	PNP	E2EH-X3B1 2M	E2EH-X3B2 2M
				NPN	E2EH-X3C1 2M	E2EH-X3C2 2M
				DC 2-wire	E2EH-X3D1 2M	E2EH-X3D2 2M
M18	■	-	7 mm	PNP	E2EH-X7B1 2M	E2EH-X7B2 2M
				NPN	E2EH-X7C1 2M	E2EH-X7C2 2M
				DC 2-wire	E2EH-X7D1 2M	E2EH-X7D2 2M
M30	■	-	12 mm	PNP	E2EH-X12B1 2M	E2EH-X12B2 2M
				NPN	E2EH-X12C1 2M	E2EH-X12C2 2M
				DC 2-wire	E2EH-X12D1 2M	E2EH-X12D2 2M

Connector types (M12)

Size			Sensing distance	Output	Order code (for M12 connector types)	
					Operation mode NO	Operation mode NC
M12	■	-	3 mm	PNP	E2EH-X3B1-M1	E2EH-X3B2-M1
				NPN	E2EH-X3C1-M1	E2EH-X3C2-M1
				DC 2-wire	E2EH-X3D1-M1G	E2EH-X3D2-M1G
M18	■	-	7 mm	PNP	E2EH-X7B1-M1	E2EH-X7B2-M1
				NPN	E2EH-X7C1-M1	E2EH-X7C2-M1
				DC 2-wire	E2EH-X7D1-M1G	E2EH-X7D2-M1G
M30	■	-	12 mm	PNP	E2EH-X12B1-M1	E2EH-X12B2-M1
				NPN	E2EH-X12C1-M1	E2EH-X12C2-M1
				DC 2-wire	E2EH-X12D1-M1G	E2EH-X12D2-M1G

Specifications

Item	M12	M18	M30
	E2EH-X3__	E2EH-X7__	E2EH-X12__
Sensing distance	3 mm±10%	7 mm±10%	12 mm±10%
Response frequency (average)	500 Hz	300 Hz	100 Hz
Power supply voltage (operating voltage range)	12 to 24 VDC, ripple (p-p): 10% max. (10 to 32 VDC) (24 VDC max. at 100°C or higher)		
Protective circuits	Surge suppression, short circuit protection, power supply reverse polarity protection, output reverse polarity protection		
Ambient temperature ^{*1}	DC 3-wire models: 0 to 100°C (0 to 120°C for 1,000 hours), DC 2-wire models: 0 to 100°C (0 to 110°C for 1,000 hours)		
Degree of protection	IEC 60529 IP67, IP69k after DIN 40050-9		
Material	Case, clamping nuts	Stainless steel (SUS316L)	
	Sensing surface	PBT (polybutylene terephthalate)	
	Cable	Heat-resistant PVC	

^{*1} Operation with power supplied for 1,000 h has been verified at 120°C for DC 3-wire models and at 110°C for DC 2-wire models. Do not bend the cable repeatedly at 100°C or higher.



Enhanced temperature resistance



Enhanced detergent resistance



Inductive sensor for mobile usage in cylindrical brass housing

Designed and tested to keep your mobile machines moving.

- IP69k tested and certified for highest water resistance
- e1 type approval (according to Automotive Directive 2005/83/EC)
- E1 type approval (according to vehicle regulation ECE-R10)
- Cable or connector breakage protection

Ordering information

Pre-wired

Size	Sensing distance		Sensing distance	Thread length (overall length)	Output configuration	Order code (for pre-wired types with 2 m PVC cable)*1	
	PNP	NC				Operation mode: NO	Operation mode: NC
M12	■	–	4.0 mm	34 mm (50 mm)	PNP	E2AU-M12KS04-WP-B1 2M	E2AU-M12KS04-WP-B2 2M
	■	–		56 mm (72 mm)	PNP	E2AU-M12LS04-WP-B1 2M	E2AU-M12LS04-WP-B2 2M
M18	■	–	8.0 mm	39 mm (59 mm)	PNP	E2AU-M18KS08-WP-B1 2M	E2AU-M18KS08-WP-B2 2M
	■	–		61 mm (81 mm)	PNP	E2AU-M18LS08-WP-B1 2M	E2AU-M18LS08-WP-B2 2M
M30	■	–	15.0 mm	44 mm (64 mm)	PNP	E2AU-M30KS15-WP-B1 2M	E2AU-M30KS15-WP-B2 2M
	■	–		66 mm (86 mm)	PNP	E2AU-M30LS15-WP-B1 2M	E2AU-M30LS15-WP-B2 2M

*1 NPN types and pre-wired types with PUR cable are available. Contact your OMRON representative

Connector types (M12)

Size	Sensing distance		Sensing distance	Thread length (overall length)	Output configuration	Order code (for M12 connector types)	
	PNP	NC				Operation mode: NO	Operation mode: NC
M12	■	–	4.0 mm	34 mm (48 mm)	PNP	E2AU-M12KS04-M1-B1	E2AU-M12KS04-M1-B2
	■	–		56 mm (70 mm)	PNP	E2AU-M12LS04-M1-B1	E2AU-M12LS04-M1-B2
M18	■	–	8.0 mm	39 mm (53 mm)	PNP	E2AU-M18KS08-M1-B1	E2AU-M18KS08-M1-B2
	■	–		61 mm (75 mm)	PNP	E2AU-M18LS08-M1-B1	E2AU-M18LS08-M1-B2
M30	■	–	15.0 mm	44 mm (58 mm)	PNP	E2AU-M30KS15-M1-B1	E2AU-M30KS15-M1-B2
	■	–		66 mm (80 mm)	PNP	E2AU-M30LS15-M1-B1	E2AU-M30LS15-M1-B2

Specifications

Item	M12		M18	M30
	E2AU-M12_		E2AU-M18_	E2AU-M30_
Sensing distance	4 mm±10%		8 mm±10%	15 mm±10%
Response frequency	1,000 Hz		500 Hz	250 Hz
Power supply voltage (operating voltage)	12 to 24 VDC. Ripple (p-p): 10% max.(10 to 32 VDC)			
Protective circuits	Output reverse polarity protection, power supply reverse polarity protection, surge suppressor, short-circuit protection			
Ambient temperature	Operating	–40 to 70°C		
	Storage	–40 to 85°C (with no icing or condensation)		
Degree of protection	IP67 after IEC 60529, IP69K after DIN 40050 part 9			
Material	Case	Brass-nickel plated		
	Sensing surface	PBT		

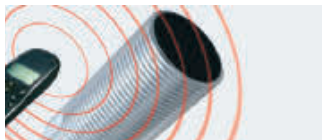

High electro-magnetic noise immunity (fields and cable induced)

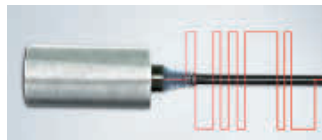

e1

e1 type approval after 2005/83/EC



E1 type approval after ECE-R10



Oil resistant inductive sensor in cylindrical brass housing

The E2E-_-U offers tested oil resistance on commonly used oils in the automotive industry for reliable long-life operation in automotive assembly lines.

- Oil resistant PUR cable
- M8, M12, M18 and M30 standard sizes
- IP67g (water and oil resistance)



Ordering information

DC 2-wire (pre-wired)

Size	Sensing distance		Order code (for pre-wired types with 2 m PUR cable)		
			Operation mode NO	Operation mode NC	
M8	■	–	2 mm	E2E-X2D1-U	E2E-X2D2-U
M12	■	–	3 mm	E2E-X3D1-U	E2E-X3D2-U
M18			7 mm	E2E-X7D1-U	E2E-X7D2-U
M30			10 mm	E2E-X10D1-U	E2E-X10D2-U

DC 2-wire (pre-wired with M12)

Size	Sensing distance		Order code (for pre-wired types with 30 cm PUR cable and M12 plug)		
			Operation mode NO	Operation mode NC	
M8	■	–	2 mm	E2E-X2D1-M1TGJ-U 0.3M	E2E-X2D2-M1TGJ-U 0.3M
M12	■	–	3 mm	E2E-X3D1-M1TGJ-U 0.3M	E2E-X3D2-M1TGJ-U 0.3M
M18			7 mm	E2E-X7D1-M1TGJ-U 0.3M	E2E-X7D2-M1TGJ-U 0.3M
M30			10 mm	E2E-X10D1-M1TGJ-U 0.3M	E2E-X10D2-M1TGJ-U 0.3M

Specifications

Item	M8	M12	M18	M30
	E2E-X2D_	E2E-X3D_	E2E-X7D_	E2E-X10D_
Sensing distance	2 mm±10%	3 mm±10%	7 mm±10%	10 mm±10%
Response frequency	1.5 kHz	1.0 kHz	0.5 kHz	0.4 kHz
Power supply voltage (operating voltage)	12 to 24 VDC (10 to 30 VDC), ripple (p-p): 10% max.			
Protective circuits	Surge suppressor, output short-circuit protection (for control and diagnostic output)			
Ambient temperature	Operating	–25 to 70°C		
	Storage	–40 to 85°C (with no icing or condensation)		
Degree of protection	IEC 60529 IP67 (JEM standard IP67g (waterproof and oil-proof))			
Material	Case	Stainless steel (SUS303)	Brass-nickel plated	
	Sensing surface	PBT (polybutylene terephthalate)		
	Cable	PUR for jacket, PE		



Inductive sensor in cylindrical full metal housing (case + sensing face)

The high durability stainless steel sensing face provides more than 20 times longer protection against mechanical damage than conventional sensors. The high mineral oil and coolant resistance and the immunity against small metal chips on the surface make this sensor ideal for metal cutting or drilling applications.

- Full body stainless steel housing for highest mechanical protection
- Low frequency modulation for metal chip immunity
- Flame retardant cable for high protection against welding spatter damage (pigtail models)

Ordering information

DC 2-wire (with M12 pigtail connector)

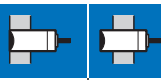
Size			Sensing distance	Order code* ¹ (for pre-wired types with 30 cm PVC cable and M12 plug)	
M8	■	—	1.5 mm	E2FM-X1R5D1-M1TGJ	
M12			2 mm	E2FM-X2D1-M1TGJ	
M18			5 mm	E2FM-X5D1-M1TGJ	
M30			10 mm	E2FM-X10D1-M1TGJ	

DC 3-wire, M12 Connector types

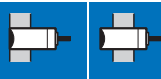
Size			Sensing distance	Order code* ¹ (for M12 connector types)	
				PNP	NPN
M8	■	—	1.5 mm	E2FM-X1R5B1-M1	E2FM-X1R5C1-M1
M12			2 mm	E2FM-X2B1-M1	E2FM-X2C1-M1
M18			5 mm	E2FM-X5B1-M1	E2FM-X5C1-M1
M30			10 mm	E2FM-X10B1-M1	E2FM-X10C1-M1

DC 3-wire, pre-wired types

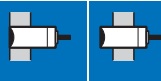
Size			Sensing distance	Order code* ¹ (for pre-wired types with 2 m PVC cable)	
				PNP	NPN
M8	■	—	1.5 mm	E2FM-X1R5B1 2M	E2FM-X1R5C1 2M
M12			2 mm	E2FM-X2B1 2M	E2FM-X2C1 2M
M18			5 mm	E2FM-X5B1 2M	E2FM-X5C1 2M
M30			10 mm	E2FM-X10B1 2M	E2FM-X10C1 2M

*¹ Output configuration normally open (NO)

Specifications)

Item	M8	M12	M18	M30
	E2FM-X1R5	E2FM-X2	E2FM-X5	E2FM-X10
Sensing distance	1.5 mm±10%	2 mm±10%	5 mm±10%	10 mm±10%
Response frequency	200 Hz	100 Hz	100 Hz	50 Hz
Power supply voltage (operating voltage range)	12 to 24 VDC (10 to 30 VDC), ripple (p-p): 10% max.			
Protective circuits	E2FM_D1: Surge suppressor, output short-circuit protection E2FM_B1/C1: Output reverse polarity protection (not E2FM-X1R5B1-M1), power supply reverse polarity protection, surge suppressor, short-circuit protection			
Ambient temperature	Operating	-25 to 70°C (with no icing or condensation)		
	Storage			
Degree of protection	IEC60529 IP67, IP69k after DIN 40050 part 9			
Material	Case	Stainless steel (SUS303)		
	Sensing surface	Stainless steel (SUS303)		
	Cable	PVC (flame retardant)		



E2FM extra strong sensing face



Conventional metal face product



No interference by small metal chips on sensing surface

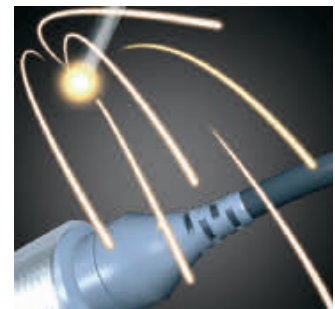

Cable resistant to welding spatter



High precision positioning inductive proximity sensor with separate amplifier

The separate amplifier inductive sensor family E2C-EDA offers high precision distance positioning and detection. The teach-in function allows simple installation, and with the window function (2 outputs) production tolerance checks can easily be set up and modified.

- Typically several hundred µm detection precision
- Precision distance teaching
- Window function (2 outputs) for production tolerance checks



Ordering information

Sensor heads

Appearance				Sensing distance	Repeat accuracy	Order code
Cylindrical	3 dia. × 18		-	0.6 mm	1 µm	E2C-EDR6-F
	5.4 dia. × 18			1 mm	1 µm	E2C-ED01* ¹
	8 dia. × 22			2 mm	2 µm	E2C-ED02* ¹
Screw	M10 × 22			2 mm	2 µm	E2C-EM02* ¹
Flat	30 × 14 × 4.8			5 mm	2 µm	E2C-EV05* ¹
Screw	M18 × 46.3	-		7 mm	5 µm	E2C-EM07M* ¹
Screw (heat resistant)	M12 × 22		-	2 mm	2 µm	E2C-EM02H

*¹ For models with cut-to-length cables add "-F" for example E2C-ED01-F
 For models with protective stainless steel spiral tubes add "-S" for example E2C-ED01-S

Amplifier units with cables

Item	Functions	Order code	
		NPN output	PNP output
Twin-output models	Area output, open circuit detection, differential operation	E2C-EDA11	E2C-EDA41
External-input models	Remote setting, differential operation	E2C-EDA21	E2C-EDA51

Amplifier units with connectors*¹

Item	Functions	Order code	
		NPN output	PNP output
Twin-output models	Area output, open circuit detection, differential operation	E2C-EDA6	E2C-EDA8
External-input models	Remote setting, differential operation	E2C-EDA7	E2C-EDA9

*¹ Order fitting connector (E3X-CN21_) separately from accessories.

Specifications

Sensor heads

Item		3 dia.	5.4 dia.	8 dia.	M10	M18	30×14×4.8 mm	M12
		E2C-EDR6-F	E2C-ED01(-_)	E2C-ED02(-_)	E2C-EM02(-_)	E2C-EM07(-_)	E2C-EV05(-_)	E2C-EM02H
Ambient temperature	Operating	-10 to 60°C (with no icing or condensation)						
	Storage	-10 to 200°C						
Degree of protection		IEC60529 IP67						IEC60529 IP60
Material	Case	Brass	Stainless steel	Brass			Zinc	Brass
	Sensing surface	Heat-resistant ABS						PEEK

Note: For amplifier specifications refer to complete datasheet

Mechanical sensors/Limit switches

THE RELIABLE AND FLEXIBLE WAY ...

... to stop your machines

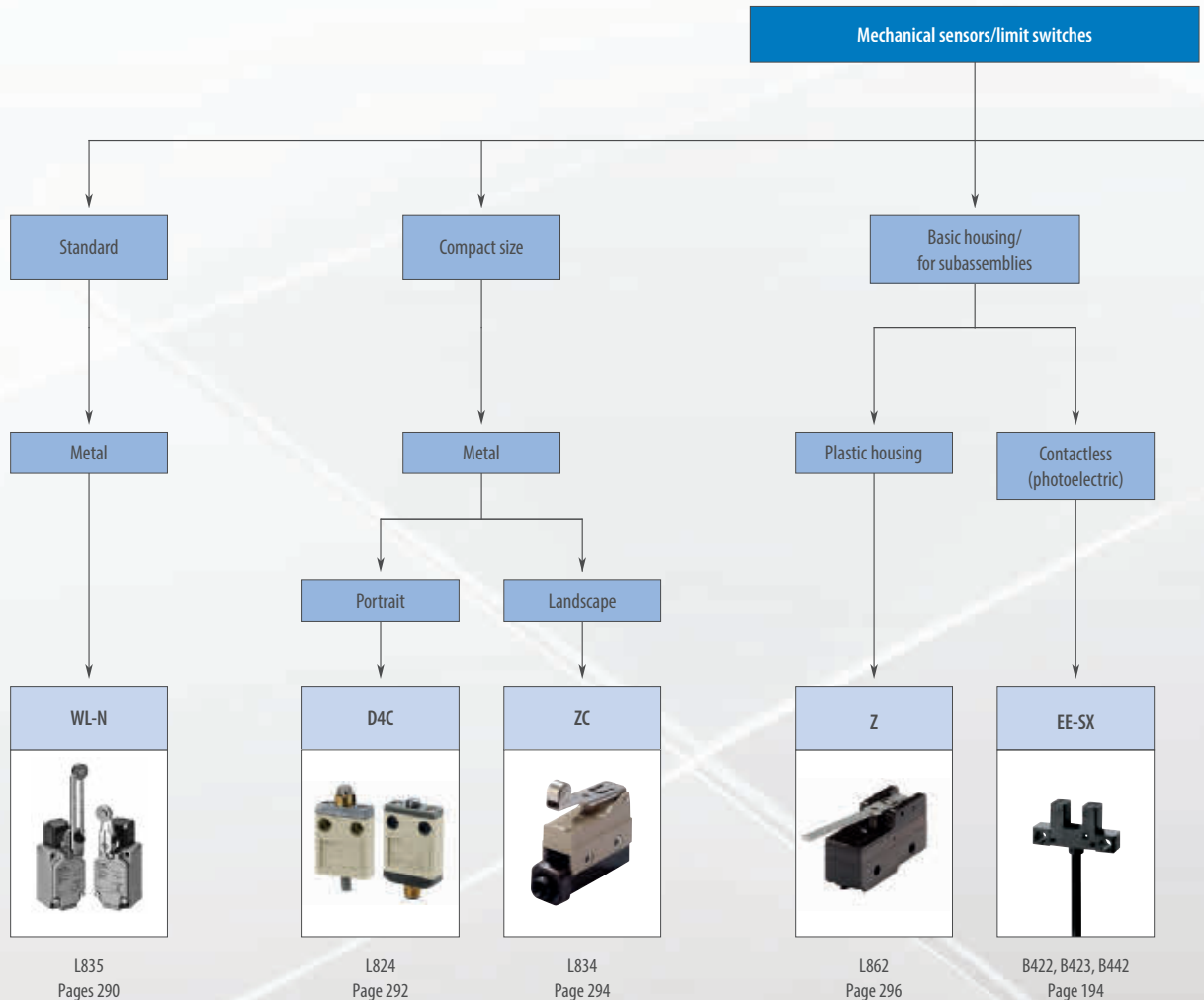

For the detection of machine part movement especially for the detection of end positions, the mechanical and optical limit switches provide accurate and reliable operation with a large variety of actuation possibilities optimized for a widest range of application and usage requirements. The easy positioning and intuitive installation, the high immunity to changing environmental influences (electromagnetic fields, sunlight, temperatures, etc.) as well as the possibility to directly switch loads with up to 15 A make these sensors ideal for a wide range of conveying and handling applications.

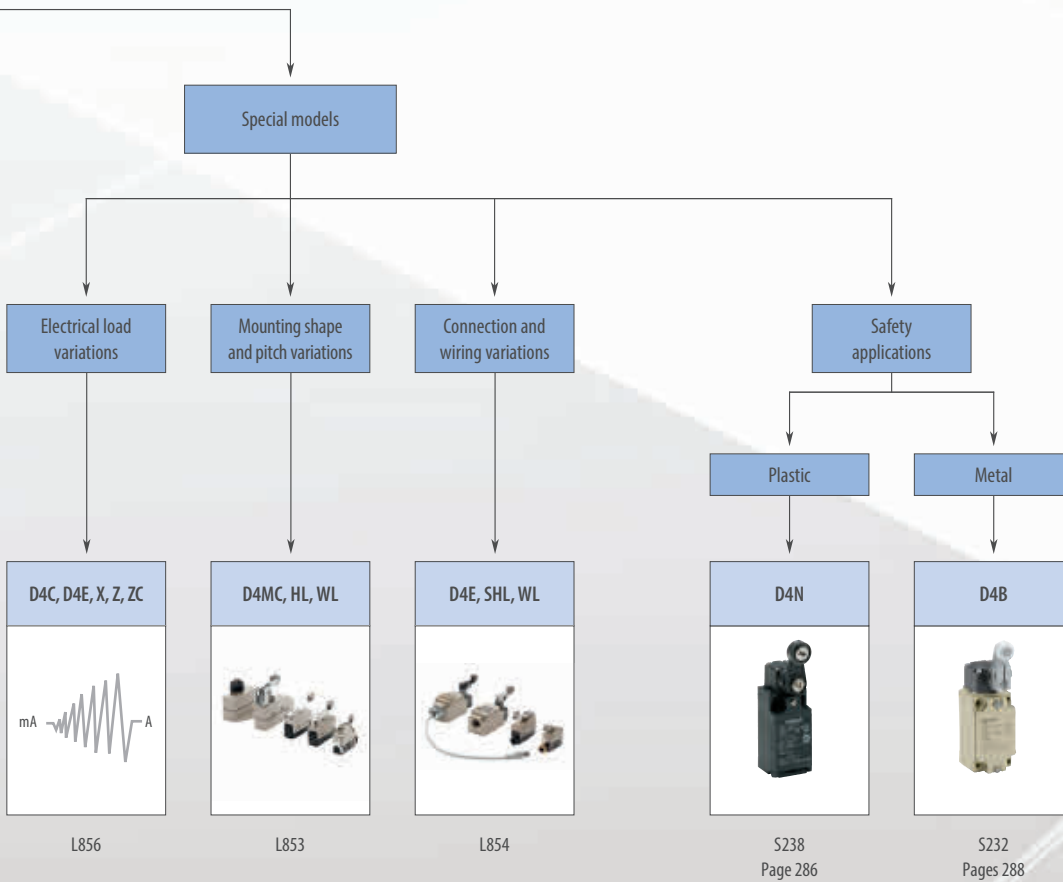







Type		Standard			Compact	Basic housing
						
Model		D4N	D4B	WL-N	D4C	Z
Material		Plastic	Metal	Metal	Metal	Plastic
Screw terminal	No conduit	–	–	–	–	■
	Cable dia. 8.5 to 10.5	–	–	–	–	–
	M20	■	■	■	–	–
	PG13.5	□	–	■	–	–
	G1/2	□	□	■	–	–
Cable connector	1/2-14NPT	□	□	■	–	–
	M12	■	–	■	■	–
Degree of protection		IP67				IP00
Page/Quick Link		286	288	290	292	296

Special models

Type	High precision multi direction	Compact
		
Model	D5B	ZC
Material	Metal	Metal
Key Features	<ul style="list-style-type: none"> – X, Y, Z action – several μm switching accuracy – M5, M8, M10 sizes 	<ul style="list-style-type: none"> – Small housing size – Screw terminals – IP67
Page/Quick Link	L833	294

Type	Highest precision tactile measurement	Electrical load variations	Mounting shape and pitch variations	Connection and wiring variations	Safety limit switches
					
Model	ZX-T	D4C, D4E, X, Z, ZC	D4MC, HL, WL	D4E, SHL, WL	D4 Safety
Material	Plastic	Plastic and Metal	Metal	Metal	Plastic and Metal
Key Features	Measurement resolution up to 0.1 μm	<ul style="list-style-type: none"> – Microloads (1 mA to 100 mA) – High current at high voltage switching (10 A at 125 VDC) – Double circuit switching 	<ul style="list-style-type: none"> – Mounting shapes and pitches popular in different countries in the world – Mounting pitch variations (base mounting, diagonal pitches, ...) – Alternative actuator positions 	<ul style="list-style-type: none"> – Screw conduit variations (PG13.5, G1/2, 1/2"14NPT) – Cable exit variations (pigtailed, rubber snap on covers, screw on covers, with or without cable breakage protection for different cable diameters) 	<ul style="list-style-type: none"> – Mechanical form lock – Manual reset – Door hinge switches
Page/Quick Link	391	Contact your OMRON representative			400









Limit switch with plastic housing

The D4N series of limit switches in plastic housing is the ideal switch for all standard mechanical position detection applications both for safety and non-safety applications.



- Direct opening mechanism and approval by notified body
- Rugged plastic housing with double insulation
- Wide range of actuators
- M12 connectors or terminal block with M20 conduit

Ordering information

Actuator type		Connection method	Order code*1			
			1NC/1NO (snap-action)	1NC/1NO (slow-action)	2NC (slow-action)	2NC/1NO (slow-action)
			Order code	Order code	Order code	Order code
 Roller lever (resin lever, resin roller)	M20	D4N-4120	D4N-4A20	D4N-4B20	D4N-4C20	
	M12 connector	D4N-9120	D4N-9A20	D4N-9B20	–	
 Plunger	M20	D4N-4131	D4N-4A31	D4N-4B31	–	
	M12 connector	D4N-9131	D4N-9A31	D4N-9B31	–	
 Roller plunger	M20	D4N-4132	D4N-4A32	D4N-4B32	D4N-4C32	
	M12 connector	D4N-9132	D4N-9A32	D4N-9B32	–	
 One-way roller arm lever (horizontal)	M20	D4N-4162	D4N-4A62	D4N-4B62	D4N-4C62	
	M12 connector	D4N-9162	D4N-9A62	D4N-9B62	–	
 One-way roller arm lever (vertical)	M20	D4N-4172	D4N-4A72	D4N-4B72	–	
 Adjustable roller lever, form lock (metal lever, resin roller)	M20	D4N-412G	D4N-4A2G	D4N-4B2G	–	
	M12 connector	D4N-912G	D4N-9A2G	D4N-9B2G	–	
 Adjustable roller lever, form lock (metal lever, rubber roller)	M20	D4N-412H	D4N-4A2H	D4N-4B2H	–	
	M12 connector	D4N-912H	D4N-9A2H	D4N-9B2H	–	

Switches with MBB contacts

MBB (Make Before Break) contacts have an overlapping structure, so that before the normally closed (NC) contact opens the normally open (NO) contact closes.

Actuator type		Connection method	Order code*1	
			1NC/1NO (slow-action)	2NC/1NO (slow-action)
 Roller lever (resin lever, resin roller)	M20	D4N-4E20	D4N-4F20	
	M12 connector	D4N-9E20	–	
 Roller plunger	M20	D4N-4E32	D4N-4F32	
	M12 connector	D4N-9E32	–	
 One-way roller arm lever (horizontal)	M20	D4N-4E62	D4N-4F62	
	M12 connector	D4N-9E62	–	

*1 The NC contacts provide the approved direct opening mechanism. 

Specifications

Durability*1	Mechanical	15,000,000 operations min.*2
	Electrical	500,000 operations min. for a resistive load of 3 A at 250 VAC 300,000 operations min. for a resistive load of 10 A at 250 VAC
Operating speed	Roller lever	1 mm/s to 0.5 m/s
Operating frequency		30 operations/minute max.
Minimum applicable load		Resistive load of 1 mA at 5 VDC (N-level reference value)
Protection against electric shock		Class II (double insulation)
Pollution degree (operating environment)		3 (EN60947-5-1)
Contact gap		Snap-action: 2x0.5 mm min Slow-action: 2x2 mm min
Conditional short-circuit current		100 A (EN60947-5-1)
Rated open thermal current (I _{th})		10 A (EN60947-5-1)
Ambient temperature	Operating	-30 to 70°C with no icing
Degree of protection		IP67 (EN60947-5-1)

*1 The durability is acquired for an ambient temperature of 5 to 35°C and an ambient humidity of 40% to 70%.

*2 10,000,000 operations min. for fork lever actuator.

1NO/1NC Contact (Snap-action)

If metal deposition between mating contacts occurs on the NC contact side, they can be pulled apart by the shearing force and tensile force generated when part B of the

safety cam or plunger engages part A of the movable contact blade. When the safety cam or plunger is moved in the direction of the arrow, the Limit Switch releases.

1. When metal deposition occurs.

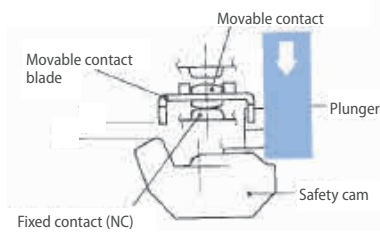

2. When contacts are being pulled apart.

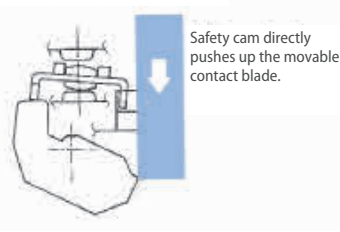

3. When contacts are completely pulled apart.

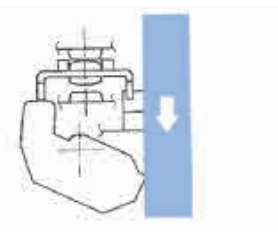

1NC/1NO Contact (Slow-action)

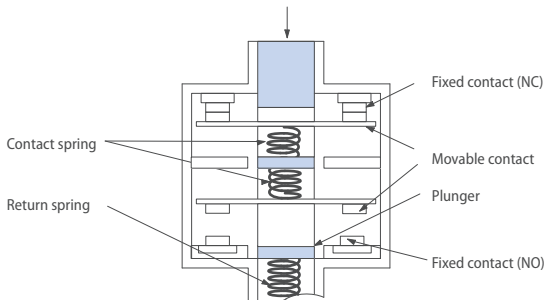

2NC Contact (Slow-action)

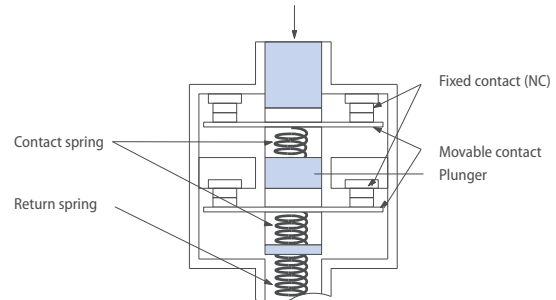

NC contacts conform to EN60947-5-1 Direct Opening

When metal deposition occurs, the contacts are separated from each other by the plunger being pushed in.

⊞ is marked on the product to indicate approval of direct opening.











Limit switch with metal housing

The D4B series of limit switches in a rugged metal housing is suitable for both safety and non-safety applications due to its direct opening mechanism and TÜV approval. Furthermore with the increased temperature range and enhanced mechanical switching lifetime, the D4B is first choice for all applications from standard to demanding environments and for highest flexibility in mounting and connectivity preferences.

- Direct opening mechanism and approval by notified body
- Rugged metal housing and extended mechanical switching lifetime (snap action models)
- Terminal block for direct wiring

Ordering information

Actuator type		Connection method	Order code*1		
			1NC/1NO (snap-action)	1NC/1NO (slow-action)	2NC (slow-action)
	Roller lever*2	Terminal block with M20 conduit*3	D4B-4111N	D4B-4511N	D4B-4A11N
	Adjustable roller lever		D4B-4116N	D4B-4516N	D4B-4A16N
	Adjustable rod lever		D4B-4117N	D4B-4517N	D4B-4A17N
	Plain		D4B-4170N	D4B-4570N	D4B-4A70N
	Roller		D4B-4171N	D4B-4571N	D4B-4A71N
	Coil spring		D4B-4181N*4	–	–
	Plastic rod		D4B-4187N*4	–	–

*1 The NC contacts provide the approved direct opening mechanism. 

*2 For models with stainless steel rollers and temperature resistance of -40°C refer to WL-TC.

*3 Models with G1/2 or 1/2"14NPT conduit are available. For ordering refer to complete datasheet. For PG13.5 conduit models for non-safety applications contact your OMRON representative.

*4 No direct opening mechanism.

Specifications

Item		Snap-action	Slow-action
Durability*1	Mechanical	30,000,000 operations min.	10,000,000 operations min.
	Electrical	500,000 operations min. (at a 250 VAC, 10 A resistive load)	
Operating speed		1 mm/s to 0.5 m/s	
Operating frequency	Mechanical	120 operations/min	
	Electrical	30 operations/min	
Rated frequency		50/60 Hz	
Contact resistance		25 mΩ max. (initial value)	
Pollution degree (operating environment)		3 (EN60947-5-1)	
Conditional short-circuit current		100 A (EN60947-5-1)	
Conventional enclosed thermal current (I _{th})		20 A (EN60947-5-1)	
Protection against electric shock		Class I (with ground terminal)	
Ambient temperature	Operating	-40 to 80°C (with no icing)*2	
Degree of protection		IP67 (EN60947-5-1)	

*1 The values are acquired for an ambient temperature of 5 to 35°C and an ambient humidity of 40% to 70%.

*2 -25 to 80°C for the flexible-rod actuator.

1NO/1NC Contact (Snap-action)

If metal deposition between mating contacts occurs on the NC contact side, they can be pulled apart by the shearing force and tensile force generated when part B of the

safety cam or plunger engages part A of the movable contact blade. When the safety cam or plunger is moved in the direction of the arrow, the Limit Switch releases.

1. When metal deposition occurs.

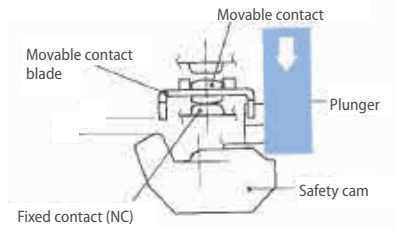

2. When contacts are being pulled apart.

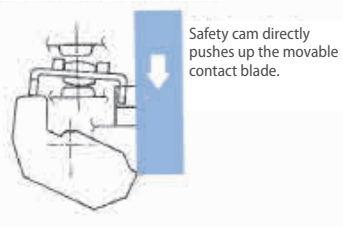

3. When contacts are completely pulled apart.

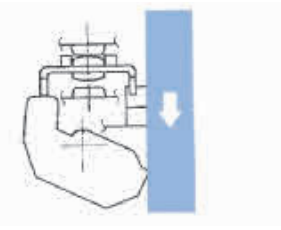

1NC/1NO Contact (Slow-action)

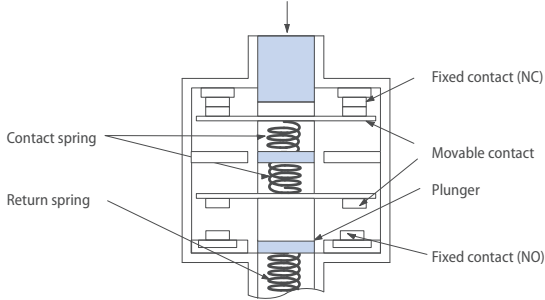

2NC Contact (Slow-action)

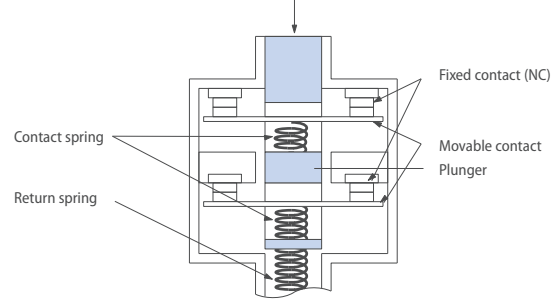

NC contacts conform to EN60947-5-1 Direct Opening

When metal deposition occurs, the contacts are separated from each other by the plunger being pushed in.

 is marked on the product to indicate approval of direct opening.

WL-N Series limit switches simplify installation

Models focus on the most popular features to make stocking easier.

- Improved durability and performance
- Applicable to either standard loads or microloads
- LED with 3D light-dispersing structure
- Reduced part numbers
- Easy wiring
- Direct and pre-wiring
- Ground terminal models are approved by EN and IEC and bear the CE marking UL,CSA



Ordering Information

Actuator type	Contact Form and features	Connection method	CE Mark	Order code
Roller lever R38	DPDB*1	Screw terminal (Pg13,5 conduit with ground terminal)*2	Yes	WLCA2-2NG-N
Adjustable roller lever: R25 to 89 mm, pretravel 15°±5°	DPDB, Heat-resistant: 5 to 120°C			WLCA12-THG-N
Adjustable roller lever: R25 to 89 mm, pretravel 15°±5°	DPDB, LED			WLCA12-GLD-N
Roller lever R50, pretravel 15°±5°	DPDB			WLCA2-7G-N
Roller lever R63, pre-travel 15°±5°	DPDB			WLCA2-8G-N
Adjustable rod lever: 25 to 140 mm, pretravel 15°±5°	DPDB, Heat-resistant: 5 to 120°C	Pre-wired Connector M12 (Smart Click), with ground terminal		WLCL-THG-N
Adjustable rod lever: 25 to 140 mm, pretravel 15°±5°	DPDB, LED,			WLCL-2NLD-DGJ-N
Roller lever R38, High sensitive pre-travel 10°+2/-1°	DPDB, LED			WLG2-LDFS-DGJS-N

*1 DPDB – The double-pole, double-break structure ensures circuit braking.

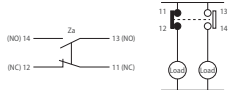

*2 Models with screw terminals with M20 conduit instead of PG13.5 are available. Contact your OMRON representative.

Specifications

Characteristics

Degree of protection		IP67
Durability* ¹	Mechanical	15,000,000 operations min.* ²
	Electrical	750,000 operations min.* ³
Operating speed		
Operating frequency		1 mm/s to 1 m/s (in case of WLCA2-N)
Operating frequency	Mechanical	120 operations/minute min.
	Electrical	30 operations/minute min.
Rated frequency		50/60 Hz
Insulation resistance		100 MΩ min. (at 500 VDC)
Contact resistance		25 mΩ max. (initial value for the built-in switch when tested alone)
Dielectric strength	Between terminals of the same polarity	1,000 VAC (600 VAC), 50/60 Hz for 1 min
	Between current-carrying metal part and ground	2,200 VAC (1,500 VAC), 50/60 Hz for 1 min
	Between each terminal and non-current-carrying metal part	2,200 VAC (1,500 VAC), 50/60 Hz for 1 min
Vibration resistance	Malfunction	10 to 55 Hz, 1.5-mm double amplitude
Shock resistance	Destruction	1,000 m/s ² max.
	Malfunction	300 m/s ²
Ambient operating temperature		-10 to 80°C (with no icing)* ⁴
Ambient operating humidity		35% to 95% RH
Weight		Approx. 255 g (in case of WLCA2-N)

*¹ The values are calculated at an operating temperature of 5 to 35°C and an operating humidity of 40% to 70% RH. Contact your OMRON sales representative for more detailed information on other operating environments.

*² Durability is 1,000,000 operations min. for high-sensitivity models. 500,000 operations min. for weather-proof models.

*³ Durability is 500,000 operations min. for high-sensitivity models. 500,000 operations min. for weather-proof models.

*⁴ For low-temperature models this is -40 to 40°C (with no icing). For heatresistant models the range is 5 to 120°C.

Note: 1. The above figures are initial values.
2. The figures in parentheses for dielectric strength are those for the high-sensitivity overtravel models.

Ratings

Item	Rated voltage (V)		Non-inductive load (A)				Inductive load (A)			
			Resistive load		Lamp load		Inductive load		Motor load	
			NC	NO	NC	NO	NC	NO	NC	NO
Basic switches	AC	125	10	3	1.5	10	5	2.5		
		250	10	2	1	10	3	1.5		
		500	10	1.5	0.8	3	1.5	0.8		
	DC	8	10	6	3	10	6			
		14	10	6	3	10	6			
		30	6	4	3	6	4			
		125	0.8	0.2	0.2	0.8	0.2			
250	0.4	0.1	0.1	0.4	0.1					
High-sensitivity switches	AC	125	5	–	–	–	–			
		250	5	–	–	–	–			
	DC	125	0.4	–	–	–	–			
		250	0.2	–	–	–	–			



Compact limit switch in metal housing

The 16 mm flat and compact size make the D4C range of limit switches very popular for all standard applications but especially where mounting space is limited or protruding housings may interfere with machine operation. The triple sealed construction, the rugged metal housing and the precisely manufactured movable parts ensure long operational life in standard or oily environments (special models).

- 16 mm flat compact size
- Rugged metal housing
- Models with M12 connector or oil resistant VCTF cable

Ordering Information

Actuator type	Load range (VDC)*1 0.8 W to 60 W max	Operation LED indicator		Connection method				Order code
		No	Yes					
Plunger 	n	■	-		■		*2	D4CC-3001
		-	■		■		3 m	D4C-1201
Sealed plunger 		■	-		■			D4CC-4001
		-	■		■		3 m	D4C-3201
Plunger with M14 mounting 		■	-		■			D4CC-3031
		-	■		■		3 m	D4C-1231
Roller plunger 		■	-		■			D4CC-4031
		-	■		■		3 m	D4C-3231
Sealed roller plunger 		■	-		■			D4CC-3041
		-	■		■		3 m	D4C-1241
Roller plunger with M14 mounting 		■	-		■			D4CC-4041
		-	■		■		3 m	D4C-3241
Crossroller plunger 		■	-		■			D4CC-3002
		-	■		■		3 m	D4C-1202
Sealed crossroller plunger 		■	-		■			D4CC-4002
		-	■		■		3 m	D4C-3202
Roller plunger with M14 mounting 		■	-		■			D4CC-3032
		-	■		■		3 m	D4C-1232
Crossroller plunger 		■	-		■			D4CC-4032
		-	■		■		3 m	D4C-3232
Sealed crossroller plunger 		■	-		■			D4CC-3042
		-	■		■		3 m	D4C-1242
Roller plunger with M14 mounting 		■	-		■			D4CC-4042
		-	■		■		3 m	D4C-3242
Crossroller plunger 		■	-		■			D4CC-3003
		-	■		■		3 m	D4C-1203
Sealed crossroller plunger 		■	-		■			D4CC-4003
		-	■		■		3 m	D4C-3203
Roller plunger with M14 mounting 		■	-		■			D4CC-3033
		-	■		■		3 m	D4C-1233
Crossroller plunger with M14 mounting 		■	-		■			D4CC-4033
		-	■		■		3 m	D4C-3233
Roller lever 		■	-		■			D4CC-3043
		-	■		■		3 m	D4C-1243
Coil spring 		■	-		■			D4CC-4043
		-	■		■		3 m	D4C-3243
		■	-		■			D4CC-3024
		-	■		■		3 m	D4C-1220
		■	-		■			D4CC-4024
		-	■		■		3 m	D4C-3220
		■	-		■			D4CC-3050
		-	■		■		3 m	D4C-1250
		■	-		■			D4CC-4050
		-	■		■		3 m	D4C-3250

*1 See specifications for details on max. current per rated voltage and load type. Micro load models with 5mW to 0.8W are available. For ordering refer to complete datasheet.

*2 Pre-wired models with 30 cm PVC cable and M12 plug (pigtail) are available. Contact your OMRON representative.

Specifications

Voltage and current rating

Model	Rated voltage	Rated current ^{*1}	Non-inductive load				Inductive load				Inrush current		Applicable load range (5 to 30 VDC)
			Resistive load		Lamp load		Inductive load		Motor load		NC	NO	
			NC	NO	NC	NO	NC	NO	NC	NO			
D4C-1□□□	125 VAC		5 A	5 A	1.5 A	0.7 A	3 A	3 A	2.5 A	1.3 A	20 A max.	10 A max.	–
	250 VAC	2 A	5 A	5 A	1 A	0.5 A	2 A	2 A	1.5 A	0.8 A			
	8 VDC		5 A	5 A	2 A	2 A	5 A	4 A	3 A	3 A			
	14 VDC		5 A	5 A	2 A	2 A	4 A	4 A	3 A	3 A			
	30 VDC	2 A	4 A	4 A	2 A	2 A	3 A	3 A	3 A	3 A			
	125 VDC		0.4 A	0.4 A	0.05 A	0.05 A	0.4 A	0.4 A	0.05 A	0.05 A			–
	250 VDC		0.2 A	0.2 A	0.03 A	0.03 A	0.2 A	0.2 A	0.03 A	0.03 A			
D4C-3□□□	30 VDC	2 A	4 A	4 A	2 A	2 A	3 A	3 A	3 A	3 A			0.8 W to 60 W
D4CC-3□□□	30 VDC	1 A	1 A	1 A	1 A	1 A	1 A	1 A	1 A	1 A	5 A max.	2.5 A max.	0.8 W to 30 W
D4CC-4□□□													
D4C-6□□□	30 VDC	0.1 A	0.1 A	0.1 A	–	–	–	–	–	–	20 A max.	10 A max.	5 mW to 0.8 W

^{*1} For D4C- cable types these ratings are certified by TÜV Rheinland according to EN60947-5-1 (file no R9451333).

General specifications

Item		D4C- (cable types)	D4CC- (connector types)
Durability ^{*1}	Mechanical	10,000,000 operations min	
	Electrical	200,000 operations min	
Operating frequency	Mechanical	120 operations/min	
	Electrical	30 operations/min	
LED indicator		D4C-3-, D4C-6-, D4CC-4-: Operation indicator (red) Operation indicator turns OFF when the switch operates. ^{*2}	
Ambient temperature	Operating	–10 to 70°C (with no icing)	
Degree of protection		IEC 60529: IP67	

^{*1} Values are acquired at 5 to 35°C operating temperature, 40% to 70% operating humidity.

^{*2} Models where operation indicator turns ON when the switch operates are available by adding “-B” to the order code. Contact your OMRON representative for availability.









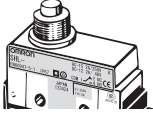

Limit switch in compact metal housing with terminal block

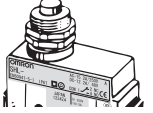
The compact housing size and the terminal block with side facing cable exit allow the mounting where space is crucial and self-wiring connection is preferred. The rugged and tight housing construction provides high protection while the low-force actuators make the ZC limit switch ideal for switching smaller or lighter objects.

- Terminal block for self-wiring with side facing cable exit
- Low-force actuators for switching smaller or lighter objects
- Rugged metal housing with IP67 protection

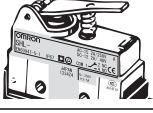
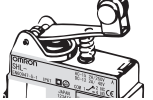
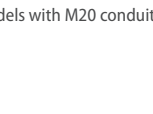
Ordering Information

Actuator type	Connection method	Order code
	 Terminal block with side facing cable exit (left/right changeable) for cables dia 8.5 to 10.5 mm*1	ZC-D55
		ZC-Q55
		ZC-N2255
		ZC-Q2255
		ZC-N2155
		ZC-Q2155
		ZC-W55
		ZC-W155
		ZC-W255
		ZC-W2155

*1 Models with M20 conduit or other connection variations are available. Refer to OPTIONAL FEATURES in complete datasheet for details.

Specifications

Voltage and current rating

Model	Rated voltage	Non-inductive load			Inductive load				Inrush current		
		Resistive load NC and NO	Lamp load		Inductive load		Motor load		NC	NO	
			NC	NO	NC	NO	NC	NO			
Standard type	125 VAC	10	3	1.5	10		5	2.5	30 A	15 A	
	250 VAC		2.5	1.25			3	1.5			
	8 VDC		3	1.5	6		5	2.5			
	14 VDC	6			5						
	30 VDC				5						
	125 VDC	0.5	0.4	0.4	0.05						
	250 VDC	0.25	0.2	0.2	0.03						
High current at high VDC switching type*1	8 VDC	10	3	1.5	10		5	2.5			
	14 VDC										
	30 VDC										
	125 VDC			7.5	6						
	250 VDC	3	1.5	0.75	2	1.5	2	1.5			

*1 Refer to OPTIONAL FEATURES in complete datasheet for details.

General specifications

Durability	Mechanical	10,000,000 operations min
	Electrical	500,000 operations min
Operating speed	Plunger	0.05 mm/s to 0.5 m/s
Operating frequency	Mechanical	120 operations/min
	Electrical	20 operations/min
Insulation resistance		100 MΩ min (at 500VDC)
Contact resistance (initial)		15 mΩ max
Dielectric strength		1,000 VAC, 50/60 Hz for 1 min between non-continuous terminals 2,000 VAC, 50/60 Hz for 1 min between each terminal and non-current-carrying metal part
Vibration resistance	Malfunction	10 to 55 Hz, 1.5 mm double amplitude
Shock resistance	Destruction	1,000 m/s ² min
	Malfunction	300 m/s ² min
Ambient temperature	Operating	-10 to 80°C (with no icing)
Ambient humidity	Operating	35% to 95% RH
Degree of protection		IEC 60529: IP67

Additional specifications after EN60947-5-1 (TÜV Rheinland File No J50041904)

Category	AC-12 10A/250 VAC
Rated insulation voltage	1,000 VAC
Short circuit protective device	10A fuse type gG (IEC60269)
Protection against electrical shock	Class II

Operating characteristics

Values for OF and RF are in N and values for PT, OT, MD and OP are in mm unless otherwise specified.

	ZC-D□	ZC-Q2□	ZC-Q5□	ZC-N2□	ZC-W1□	ZC-W21□	ZC-W25□	ZC-W5□
Operating force (OF)	11.8			6.86	2.75		3.92	
Release force (RF)	4.9			1.67	0.59		0.78	
Pre-travel (PT)	1.5				-			
Overtravel (OT)	2.4	3	2.5		8.4		6	
Movement differential (MD)	0.2				1.4		1	
Operating Position (OP)	32.4±0.8	47.4±0.8	38.2±0.8	47.4±0.8	28.5±1.2	43.0±1.2	28.5±1.2	











Limit switch with basic plastic housing

The Z series of basic switches in plastic housing provide the same electrical and mechanical switching capability and lifetime as standard limit switches. But with the basic plastic housing the basic switches are an ideal solution with best value for money for uncritical environments or when separately encased in subassemblies.

- Cost efficient basic plastic housing for subassemblies
- Same electrical and mechanical switching ratings as standard limit switches

Ordering information

Actuator type*1		Order code*2	
		Solder terminal	Screw terminal
	Pin plunger	Z-15G	Z-15G-B
	Short spring plunger	Z-15GD	Z-15GD-B
	Leaf spring	Z-15GL	Z-15GL-B
	Reverse hinge lever	Z-15GM	Z-15GM-B
	Reverse hinge roller lever	Z-15GM2	Z-15GM2-B
	Plunger with M12 mounting	Z-15GQ	Z-15GQ-B
	Hinge lever	Z-15GW	Z-15GW-B
	Hinge roller lever	Z-15GW2	Z-15GW2-B

*1 Other actuator types are available. For the full range refer to the complete datasheet.

*2 Contacts are directly accessible. Additional protective measures are required e.g. order covers from accessories.

Specifications



Rated voltage	Non-inductive load				Inductive load			
	Resistive load		Lamp load		Inductive load		Motor load	
	NC	NO	NC	NO	NC	NO	NC	NO
125 VAC	15 A		3 A	1.5 A	15 A		5 A	2.5 A
250 VAC	15 A		2.5 A	1.25 A	15 A		3 A	1.5 A
8 VDC	15 A		3 A	1.5 A	15 A		5 A	2.5 A
14 VDC	15 A		3 A	1.5 A	10 A		5 A	2.5 A
30 VDC	6 A		3 A	1.5 A	5 A		5 A	2.5 A
125 VDC	0.5 A*1		0.5 A	0.5 A	0.05 A		0.05 A	0.05 A

*1 For switching high currents at high voltages (e.g. 10A at 125VDC) contact your OMRON representative.

Durability	Mechanical	10,000,000 operations min.
	Electrical	500,000 operations min.
Operating speed	Plunger	0.01 mm to 1 m/s
Operating frequency	Mechanical	240 operations/min
	Electrical	20 operations/min
Ambient temperature	Operating	-25 to 80°C (with no icing)
Degree of protection		IP00

Accessories

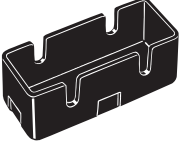
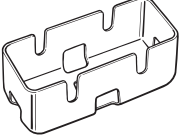
Terminal covers (protection of electrical contacts against accidental contact of e. g. fingers)

Type	Material	Order code	
		for soldering terminal models	for screw terminal models
 	plastic	AP-A	AP-B
	metal	AP1-A	AP1-B
		AP-Z	

Cover with 5 thinner parts (plastic type) or holes (metal type) as cable exit positions. Protective cover is fixed to basic switch with mounting screws of basic switch.

Cover with bottom cable exit

Rotary encoders

ACCURACY AND ROBUSTNESS MADE RELIABLE

Close the loop – angle, position and velocity on hand

Rotary encoders create information which represent the movement of your application. To meet challenging demands, Omron offers a wide range of absolute and incremental encoders.

- Wide resolution variety
- Models with rugged housing
- Models for multi- turn applications

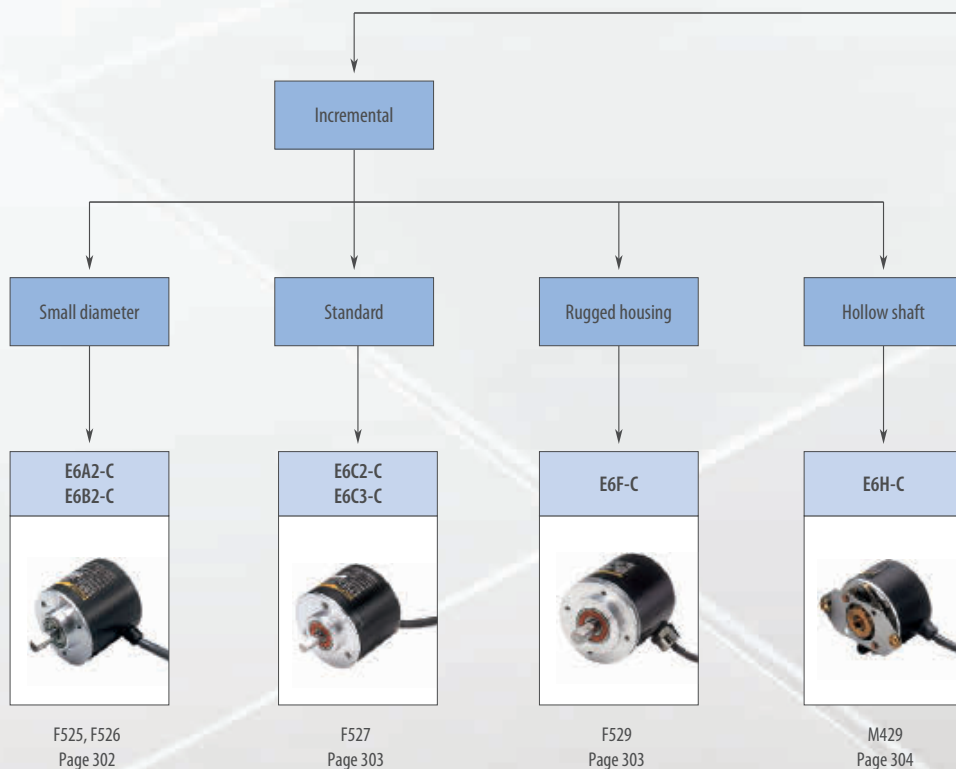

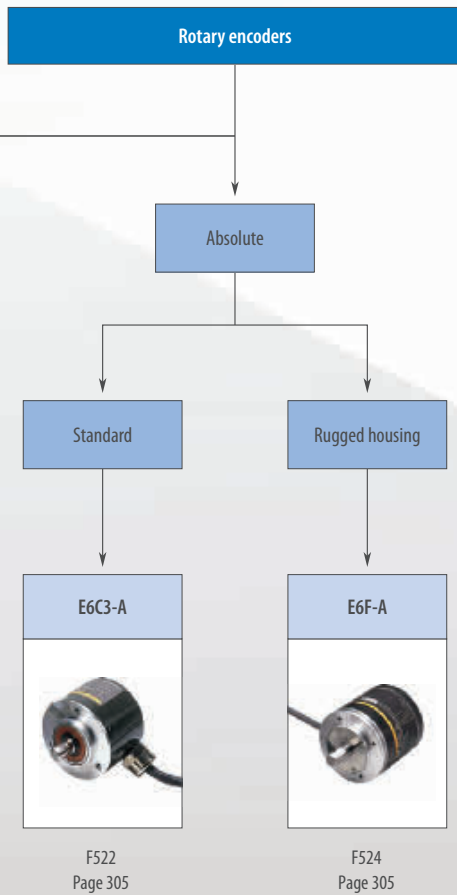

Output		Incremental				
						
Model		E6A2-C	E6B2-C	E6C2-C	E6C3-C	E6F-C
Type		Small diameter shaft			Standard	Rugged housing
Resolution range	Min.	10			100	
	Max.	500	2,000	3,600		1,000
Output	NPN	■	■	■	■	■
	PNP	–	■	■	–	–
Size dia. in mm		25	40	50	50	60
Max. force	Radial	10	30	50	80	120
	Axial	5	20	30	50	50
IP rating	IP50	■	■	–	–	–
	IP64	–	–	■	–	–
	IP65	–	–	–	■	■
Max. rotation frequency		5,000		6,000		5,000
Page/Quick Link		302		303		

Output		Incremental	Absolute			
						
Model		E6H-C	E6C3-A	E6F-A		
Type		Hollow shaft	Standard	Rugged housing		
Resolution Range	Min.	300	6	256		
	Max.	3,600	1,024			
Output	NPN	■	■	■		
	PNP	–	■	■		
Size dia. in mm		40 (hollow)	50	60		
Max. force	Radial	29.4	80	120		
	Axial	4.9	50	50		
IP rating	IP50	■	–	–		
	IP64	–	–	–		
	IP65	–	■	■		
Max. rotation frequency		10,000	5,000	5,000		
Page/Quick Link		304	305			

■ Standard □ Available – No/not available



Incremental rotary encoder in miniature housing

The E6A family of rotary encoders features a small sized dia. 25 mm housing.

- Small sized dia. 25 mm housing

Ordering information

Size dia. in mm	Output phase	Power supply voltage	Output form	Resolution (pulse/rotation)	Order code
25	A	5 to 12 VDC	NPN voltage output	10, 20, 60, 100, 200, 300, 360, 500	E6A2-CS3E
			NPN open collector	10, 20, 60, 100, 200, 300, 360, 500	E6A2-CS3C
		12 to 24VDC			E6A2-CS5C
	A, B	5 to 12 VDC	NPN voltage output	100, 200, 360, 500	E6A2-CW3E
			NPN open collector	100, 200, 360, 500	E6A2-CW3C
		12 to 24VDC			E6A2-CW5C
	A, B, Z	5 to 12 VDC	NPN voltage output	100, 200, 360, 500	E6A2-CWZ3E
			NPN open collector	100, 200, 360, 500	E6A2-CWZ3C
12 to 24VDC				E6A2-CWZ5C	

E6B2-C



Incremental rotary encoder in compact housing

The E6B family of incremental rotary encoders features a housing size dia. 40 mm.

- Line driver output models available

Ordering information

Size dia. in mm	Power supply voltage	Output form	Resolution (pulse/rotation)	Order code
40	5 to 24 VDC	NPN open collector output	10, 20, 30, 40, 50, 60, 100, 200, 300, 360, 400, 500, 600, 720, 800, 1,000, 1,024, 1,200, 1,500, 1,800, 2,000	E6B2-CWZ6C
		PNP open collector output	100, 200, 360, 500, 600, 1,000, 2,000	E6B2-CWZ5B
	5 to 12 VDC	NPN voltage output	10, 20, 30, 40, 50, 60, 100, 200, 300, 360, 400, 500, 600, 1,000, 1,200, 1,500, 1,800, 2,000	E6B2-CWZ3E
	5 VDC	Line driver output	10, 20, 30, 40, 50, 60, 100, 200, 300, 360, 400, 500, 600, 1,000, 1,024, 1,200, 1,500, 1,800, 2,000	E6B2-CWZ1X



Incremental rotary encoder with enhanced water resistant

The E6C family of dia. 50 mm incremental rotary encoders features an improved water resistance compared to standard models.

- IP64f or IP65f drip-proof, oil-proof construction

Ordering information

	Size dia. in mm	Power supply voltage	Output form	Resolution (pulse/rotation)	Order code
Standard models	50	5 to 24 VDC	NPN open collector output	10, 20, 30, 40, 50, 60, 100, 200, 300, 360, 400, 500, 600, 720, 800, 1,000, 1,024, 1,200, 1,500, 1,800, 2,000	E6C2-CWZ6C
		12 to 24VDC	PNP open collector output	100, 200, 360, 500, 600, 1,000, 2,000	E6C2-CWZ5B
		5 to 12 VDC	NPN voltage output	10, 20, 30, 40, 50, 60, 100, 200, 300, 360, 400, 500, 600, 720, 800, 1,000, 1,024, 1,200, 1,500, 1,800, 2,000	E6C2-CWZ3E
		5 VDC	Line driver output	10, 20, 30, 40, 50, 60, 100, 200, 300, 360, 400, 500, 600, 720, 800, 1,000, 1,024, 1,200, 1,500, 1,800, 2,000	E6C2-CWZ1X
8 dia. tough model	50	12 to 24VDC	Complimentary output	100, 200, 300, 360, 500, 600, 720, 800, 1,000, 1,024, 1,200, 1,500, 1,800, 2,000, 2,048, 2,500, 3,600	E6C3-CWZ5GH
		5 to 12 VDC	NPN voltage output	100, 200, 300, 360, 500, 600, 720, 800, 1,000, 1,024, 1,200, 1,500, 1,800, 2,000, 2,048, 2,500, 3,600	E6C3-CWZ3EH
		5 to 12 VDC	Line driver output	100, 200, 300, 360, 500, 600, 720, 800, 1,000, 1,024, 1,200, 1,500, 1,800, 2,000, 2,048, 2,500, 3,600	E6C3-CWZ3XH

E6F-C



Incremental rotary encoder in rugged housing

The E6F family of dia. 60 mm rotary encoders features a rugged housing.

- Strong shaft for max 120 N in radial direction and max 50 N in thrust direction)
- Water- and oil-proof structure (IP65f)

Ordering information

Size dia. in mm	Power supply voltage	Output form	Resolution (pulse/rotation)	Order code
60	12 to 24VDC	Complimentary output	100, 200, 360, 500, 600, 1000	E6F-CWZ5G



Incremental rotary encoder with hollow shaft

The E6H family of incremental encoders features a dia. 40 mm housing with hollow shaft.

- Wide operating voltage range from 5 to 24 VDC
- Line drive output available (100 m max.)

Ordering information

Size dia. in mm	Power supply voltage	Output form	Resolution (pulse/rotation)	Order code
40	5 to 24 VDC	Open collector output	300, 360, 500, 600, 720, 800, 1,000, 1,024, 1,200, 1,500, 1,800, 2,000, 2,048, 2,500, 3,600	E6H-CWZ6C
	5 to 12 VDC	Voltage output	300, 360, 500, 600, 720, 800, 1,000, 1,024, 1,200, 1,500, 1,800, 2,000, 2,048, 2,500, 3,600	E6H-CWZ3E
	5 to 12 VDC	Line drive output	300, 360, 500, 600, 720, 800, 1,000, 1,024, 1,200, 1,500, 1,800, 2,000, 2,048, 2,500, 3,600	E6H-CWZ3X



Absolute rotary encoder with enhanced water resistance

The E6C family of dia. 50 mm incremental rotary encoders features an improved water resistance compared to standard models.

- IP65f drip-proof, oil-proof construction

Ordering information

Size dia. in mm	Power supply voltage	Output form	Output code	Resolution (pulse/rotation)	Connection method	Order code
50	12 to 24VDC	NPN open collector output	Gray code	256, 360	Connector type	E6C3-AG5C-C
				256, 360, 720, 1,024	Pre-wired type	E6C3-AG5C
			Binary	32, 40		E6C3-AN5C
		BCD	6, 8, 12	E6C3-AB5C		
		PNP open collector output	Gray code	256, 360, 720, 1,024	E6C3-AG5B	
			Binary	32, 40	E6C3-AN5B	
	BCD		6, 8, 12	E6C3-AB5B		
	5 VDC	NPN voltage output	Binary	256		E6C3-AN1E
						E6C3-AN2E
	12 VDC					

E6F-A



Absolute rotary encoder in rugged housing

The E6F family of dia. 60 mm rotary encoders features a rugged housing.

- Stronger shaft and higher durability (120 N in radial direction and 50 N in thrust direction) than previous E6F Encoders
- Drip-proof construction meets IP64F standards
- High-resolution models (1024 pulses max. per revolution)
- Faster response for high-speed control applications (grey code: 20 kHz)

Ordering information

Size dia. in mm	Power supply voltage	Output form	Output code	Resolution (pulses/revolution)	Connection method	Order code	
60	12 to 24 VDC	NPN open collector	BCD	360	Pre-wired	E6F-AB5C	
					256, 360, 720, 1,024	Connector type ^{*1}	E6F-AB5C-C
			Gray code			Pre-wired	E6F-AG5C
		PNP open collector	BCD	360		Pre-wired	E6F-AB5B
					256, 360, 720, 1,024		
			Gray code			Pre-wired	E6F-AG5B





^{*1} For extension cables order E69-DF5 (5M) or E69-DF10 (10M).

Cable connectors

Size	Shape	Type	Features	Material		Order code					
				Nut	Cable						
M8		PRO	3 pin	Brass (CuZn)	PVC 2 m	XS3F-M8PVC3S2M-EU	XS3F-M8PVC3A2M-EU				
			4pin		PUR 2 m	XS3F-M8PUR3S2M-EU	XS3F-M8PUR3A2M-EU				
			4 pin		PVC 2 m	XS3F-M8PVC4S2M-EU	XS3F-M8PVC4A2M-EU				
					PUR 2 m	XS3F-M8PUR4S2M-EU	XS3F-M8PUR4A2M-EU				
		LITE	3 pin	Brass (CuZn)	PVC 2 m	XS3F-LM8PVC3S2M	XS3F-LM8PVC3A2M				
			4 pin		XS3F-LM8PVC4S2M	XS3F-LM8PVC4A2M					
		PRO ^{plus} Detergent resistant Wash-down	4 pin	Stainless steel (SUS316L)	PP* ¹ 2 m	Y92E-S08PP4S 2M	Y92E-S08PP4A 2M				
					PRO ^{plus} Robotic (drag chain)	Robotic PVC 2 m	XS3F-M421-402-R	XS3F-M422-402-R			
						Robotic PUR 2 m	Y92E-M08PUR4S2M-L	Y92E-M08PUR4A2M-L			
						High robotic (drag chain & torsion)	Y92E-M08PUR4S2M-R	Y92E-M08PUR4A2M-R			
	M12		PRO	3 wire	Brass (CuZn)	PVC 2 m	XS2F-M12PVC3S2M-EU	XS2F-M12PVC3A2M-EU			
				4 wire		PUR 2 m	XS2F-M12PUR3S2M-EU	XS2F-M12PUR3A2M-EU			
4 wire				PVC 2 m		XS2F-M12PVC4S2M-EU	XS2F-M12PVC4A2M-EU				
				PUR 2 m		XS2F-M12PUR4S2M-EU	XS2F-M12PUR4A2M-EU				
5 wire				PVC 2 m		XS2F-M12PVC5S2M-EU	XS2F-M12PVC5A2M-EU				
				PUR 2 m		XS2F-M12PUR5S2M-EU	XS2F-M12PUR5A2M-EU				
		LITE	3 wire	Brass (CuZn)	PVC 2 m	XS2F-LM12PVC3S2M	XS2F-LM12PVC3A2M				
			4 wire		XS2F-LM12PVC4S2M	XS2F-LM12PVC4A2M					
		PRO ^{plus} LED (power and output LED, PNP)	3 wire	Nickel plated brass	PVC 2 m	-	XS2F-M12PVC3A2MPLLED				
			4 wire		PUR 2 m	-	XS2F-M12PUR3A2MPLLED				
			3 wire		-	XS2F-M12PUR3A2MPLLED					
			4 wire		-	XS2F-M12PUR4A2MPLLED					
		PRO ^{plus} Detergent resistant Wash-down	4 wire	Stainless steel (SUS316L)	PP* ¹ 2 m	Y92E-S12PP4S 2M	Y92E-S12PP4A 2M				
					PRO ^{plus} 105°C Heat resistant	Heat resistant PVC 2 m	XS2F-E421-D80-E	XS2F-E422-D80-E			
						Twist & click	PVC 2 m	XS5F-D421-D80-F	XS5F-D422-D80-F		
					PUR 2 m		XS5F-D421-D80-P	XS5F-D422-D80-P			
						PRO ^{plus} Robotic (drag chain)	4 wire	Brass (CuZn)	Robotic PVC 2 m	XS2F-D421-D80-F	XS2F-D422-D80-F
									Robotic PUR 2 m	Y92E-M12PUR4S2M-L	Y92E-M12PUR4A2M-L
					High robotic (drag chain & torsion)	4 wire	Brass (CuZn)	High grade robotic PUR 2 m	Y92E-M12PUR4S2M-R	Y92E-M12PUR4A2M-R	
								8 pin	8 wire shielded ca- ble	Brass (CuZn)	Shielded PUR 2m
Fiber amplifier (E3X) connector		Fiber amplifier connec- tors	Special fiber connector - 4 wire	PBT	PVC 2 m	E3X-CN21					
			Special fiber connector + M8 plug	Plug: Zinc diecast	PVC 30 cm with M8 4-pin plug	E3X-CN21-M3J-2 0.3M					
			Special fiber connector + M12 plug		PVC 30 cm with M12 4-pin plug	E3X-CN21-M1J 0.3M					

*1 PP - polypropylene

Cable connectors

Size	Shape	Type	Features	Material		Order code	
				Nut	Cable		
M12		IDC (Insulation Displacement Contact)	<p>Fast and easy IDC pressure-welded assembly</p> <p>One connector for cable diameters of 3 mm to 8 mm</p> <p>IP 67 for waterproof connection</p> <p>Smartclick connection</p>	Brass	n.a.	XS5G-D418 XS5C-D418	
M8/M12		Confection-able	Plugs and connectors for self assembly	Brass	n.a.	XS2G, XS2C Y92E_conf	
M12		Field I/O boxes	Direct wiring or DeviceNet communication	-	-	XW3B, DRT2	
M8/M12		T-connectors, covers, accessories and extended wiring portfolio	n.a.	-	-	XS2R, XS3R, XY2F, ...	

Quality control & Inspection

Find information fast!

Quick Links shortens your search. Quick Links are unique codes assigned to Omron products listed in this guide. Enter Quick Link codes in the search box on industrial.omron.eu to access detailed information on products in this guide.

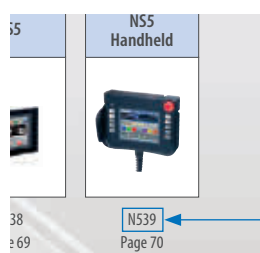

[Quick Link](#)

Quality control & Inspection

Inspection & Ident systems

Product overview	310
Selection table	312
Inspection systems	
FQ2	315
FQ-M	325
Xpectia FH/FZ5	333
FlexXpect	348
Accessories	310
Ident systems	
V400-H	311
FQ-CR2	311
FQ-CR1	311
FQ2-CH	311
FQ2-S4	311
RFID systems	
RFID system	358

Measurement sensors

Product overview	366
Selection table	368
Laser displacement sensor	
ZX1	371
ZX2	373
ZS-HL	376
ZX-L	381
Confocal fiber sensor	
ZW	384
Inductive displacement sensor	
ZX-E	389
Contact displacement sensor	
ZX-T	391
Profile sensor	
ZG2	393
Laser micrometer	
ZX-GT	397

EASY VISION: TOUCH, COMMUNICATE AND GO

Built-in LCD monitor for setup and immediate image visualization



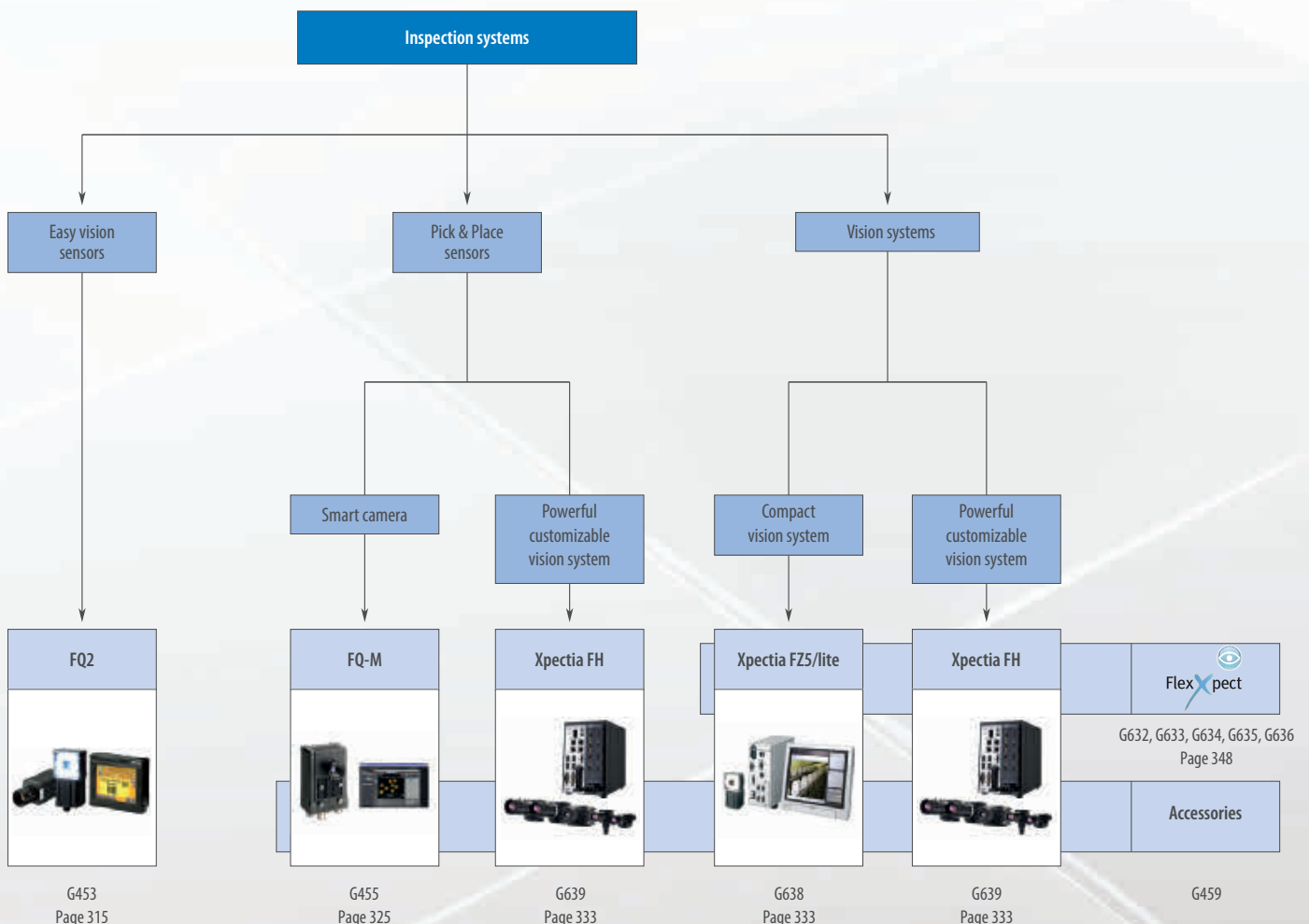

The easy vision sensor FQ2 solves the applications by an intuitive teach & go procedure. For advanced applications features such as multiple inspections, position correction, intelligent image filtering and ethernet communication are offered by the Xpectia lite. The high end is addressed by the Xpectia FJ.

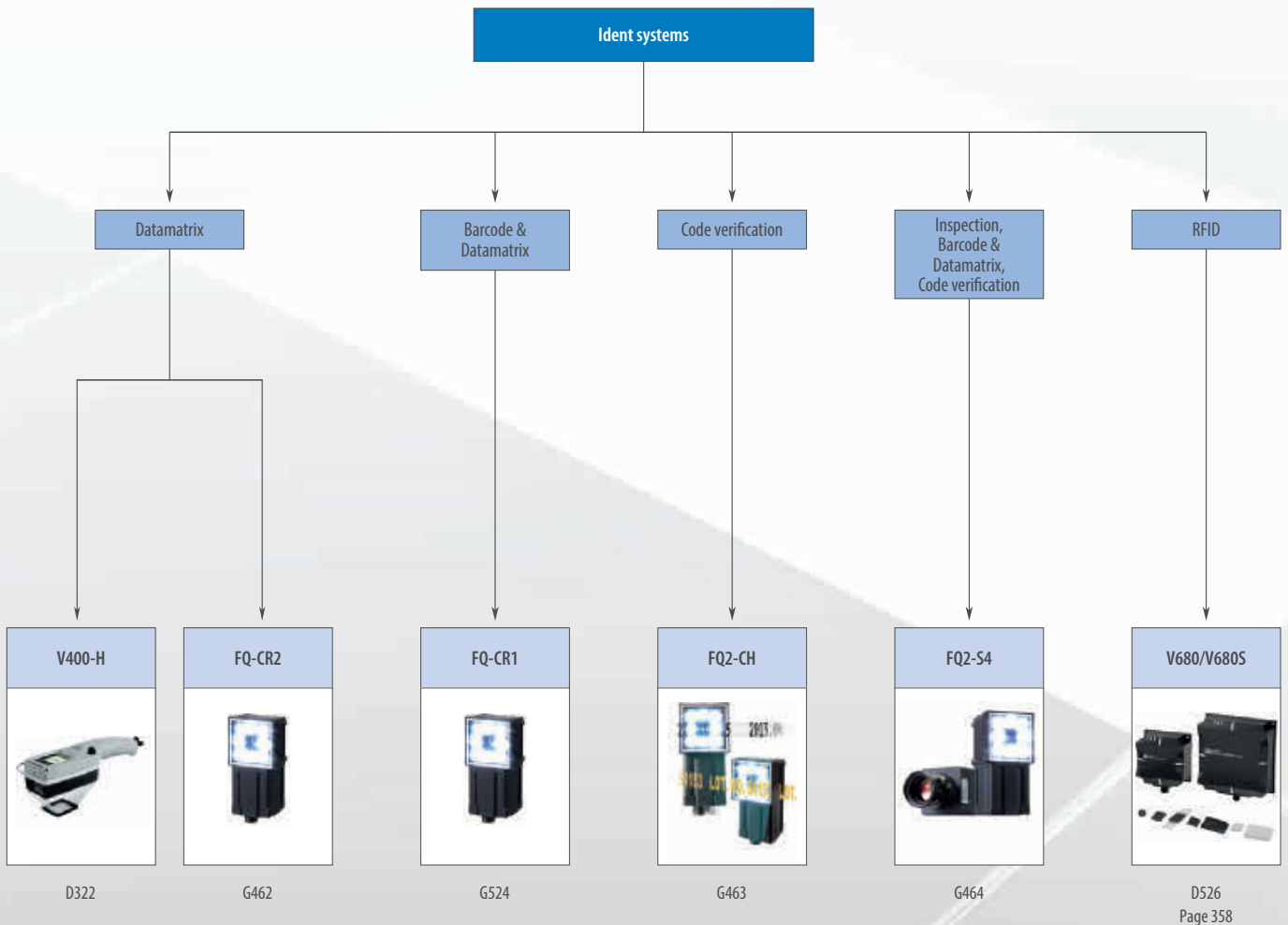



- Easy vision – intuitive user interfaces
- Communication – centralized set-up & inspection via Ethernet
- High-end vision – PC-based system for challenging applications
- True color – close to human eye identification and image processing





Selection table

		Vision sensor	Pick & Place	Vision systems			
							
Model		FQ2	FQ-M	Xpectia FH	Xpectia FZ5/Lite	Xpectia FH	
Selection criteria	Number of connectable cameras	Smart camera	Smart camera	8	4	8	
	Camera type	Monochrome/Color	Color	Digital color or black & white	Digital color or black & white	Digital color or black & white	
	Resolution (usable)	752 × 480	752 × 480	from 640 × 480 to 2,040 × 2,048	from 640 × 480 to 2,488 × 2,044	from 640 × 480 to 2,040 × 2,048	
	Display dots	928 × 828 1,280 × 1,024					
	Working distance mm	Min.	8	Depends on selected lens	Depends on selected lens	Depends on selected lens	Depends on selected lens
		Max.	970	–	–	–	–
	Field of view	Min.	7.5 × 4.7	Depends on selected lens	Depends on selected lens	Depends on selected lens	Depends on selected lens
		Max.	300 × 268	–	–	–	–
	Number of storable configurations	32	32	–	–	–	
	Number of tools/configuration	32	32	limited only by memory space	limited only by memory space	limited only by memory space	
IP-Rating camera head	IP67	IP40	Depends on setup & tools, IP20	Depends on setup & tools, IP20	Depends on setup & tools, IP20		
Supply voltage	24 VDC	24 VDC	–	–	–		
Features	Image processing tools	Search, shape search II, sensitive search, area, color data, edge position, edge pitch, edge width, labeling, FQ2-S4 has additional: OCR, Bar code, 2D-code, 2D-code (DMP) and Model dictionary The types of characters and codes to be read are the same as those of FQ2-CH and FQ-CR1 & FQ-CR2	Contour based search, labelling, edge position	App. 70 processing tools for object or defect recognition, measurements, calculations, input/output, display and more. Includes also character recognition and high precision edge code inspection tools	App. 70 processing tools for object or defect recognition, measurements, calculations, input/output, display and more. Includes also character recognition and high precision edge code inspection tools	App. 70 processing tools for object or defect recognition, measurements, calculations, input/output, display and more. Includes also character recognition and high precision edge code inspection tools	
	Image preprocessing	High dynamic range (HDR), polarizing filter (attachment), and white balance	High dynamic range (HDR), white balance	Smoothing, edge enhancement, edge extraction, erosion, dilation, median, background suppression - multiple passes, configurable	Smoothing, edge enhancement, edge extraction, erosion, dilation, median, background suppression - multiple passes, configurable	Smoothing, edge enhancement, edge extraction, erosion, dilation, median, background suppression - multiple passes, configurable	
	Flow programming	–	–	■	■	■	
	User interface	PC-Tool or Touch Display	PC-Tool or Touch Display	■	■	■	
	Optional PC configuration software	Yes	Yes	■	■	■	
	Security tools	–	■	–	–	–	
	Communication	RS-232C	Optional via FQ-SDU2	–	■	■	■
		USB	–	–	■	■	■
		Ethernet	Yes	■	■	■	■
		EtherCAT	–	Yes	Yes	–	Yes
Number of digital I/O		7 in/3 out	9 in/5 out	19 in/34 out	11 in/26 out	19 in/34 out	
Page/Quick Link	315	325	333	333	333		

		Code reader					
							
Model		FQ-CR1	FQ-CR2	FQ2-CH	FQ2-S4	V400-H	
Selection criteria	Number of connectable cameras	Smart camera	Smart camera	Smart camera	Smart camera	1	
	Camera type	Monochrome	Monochrome	Monochrome	Monochrome/Color	Digital black & white	
	Resolution (usable) Display dots	752 × 480	752 × 480	752 × 480	752 × 480 928 × 828 1,280 × 1,024	–	
	Working distance mm	Min.	8	8	8	8	40 mm
		Max.	970	970	970	970	40 mm
	Field of view	Min.	7.5 × 4.7	7.5 × 4.7	7.5 × 4.7	7.5 × 4.7	5 × 5 mm
		Max.	300 × 191	300 × 191	300 × 191	300 × 268	30 × 30 mm
	Number of storable configurations	32	32	32	32	limited by SD card	
	Number of tools/configuration	32	32	32	32	–	
	IP-Rating camera head	IP67	IP67	IP67	IP67	IP64	
Supply voltage	24 VDC	24 VDC	24 VDC	24 VDC	5 VDC		
Features	Image processing tools	2D-codes: Data Matrix, QR Code, Micro QR Code, PDF417, Micro PDF417, GS1-Data Matrix Bar codes: JAN/EAN/UPC, Code39, Codabar (NW-7), IFT (interleaved2 of 5), Code93, Code128/GS1-128, GS1-DataBar, GS1-128 Composite Code, Pharmacode	2D-codes: Data Matrix, QR Code	OCR - Alphabet A to Z - Number 0 to 9 - Symbol '-./: Model dictionary	Search, shape search II, sensitive search, area, color data, edge position, edge pitch, edge width, labeling, OCR, Bar code, 2D-code, 2D-code (DMP) and Model dictionary The types of characters and codes to be read are the same as those of FQ2-CH and FQ-CR1 & FQ-CR2	Data Matrix, ECC200, 10×10 to 64×64, 8×18 to 16×48, QR Code (Models 1, 2), 21×21 to 57×57 (Versions 1 to 10).	
	Image preprocessing	High dynamic range (HDR), polarizing filter (attach- ment), and white balance	High dynamic range (HDR), polarizing filter (attach- ment), and white balance	High dynamic range (HDR), polarizing filter (attach- ment), and white balance	High dynamic range (HDR), polarizing filter (attach- ment), and white balance	–	
	Flow programming	–	–	–	–	–	
	User interface	PC-Tool or Touch Display	PC-Tool or Touch Display	PC-Tool or Touch Display	PC-Tool or Touch Display	–	
	Optional PC configuration software	Yes	Yes	Yes	Yes	–	
	Security tools	–	–	–	–	–	
	Communication	RS-232C	–	–	Optional via FQ-SDU2	Optional via FQ-SDU2	–
		USB	–	–	–	–	–
		Ethernet	Yes	Yes	Yes	Yes	–
		EtherCAT	–	–	–	–	–
Number of digital I/O		7 in/3 out	7 in/3 out	7 in/3 out	7 in/3 out	–	
Page/Quick Link	G524	G462	G463	G464	D322		

■ Standard

– No/not available



The new standard in image inspection and code verification

The FQ2 vision sensor family is set to redefine the vision sensor market, providing advanced inspection, code reading and verification only previously available in higher end vision systems. With over 100 camera options, the FQ2 provides users with the ultimate flexibility to solve applications, whether you need high resolution, code reading, integrated lighting, or a cost effective solution to solve a simple application, there is an FQ2 which fits your needs.

- Powerful functionality with versatile line-up
- All-in-one-housing
- Easy searching with Shape Search II
- Direct Part Marked (DPM)
- Unique OCR technology
- Code verification

System Configuration

Up to 32 Sensors can be set up and monitored from a single Touch Finder or PC Tool.
 Various types of Sensors can be used at the same time.
 However, I/O type and wiring method vary depending on the Sensor, so select the necessary devices.

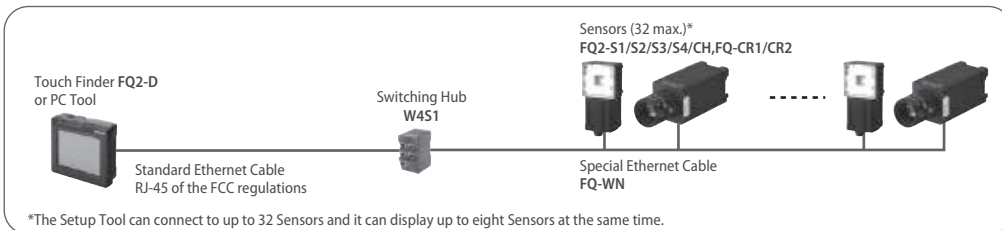

Note: If you register as a member after purchasing a Sensor, you can download free setup software that runs on a PC and can be used in place of Touch Finder. Refer to the member registration sheet for details.

Ethernet (EtherNet/IP, No-protocol, or PLC Link) Connection

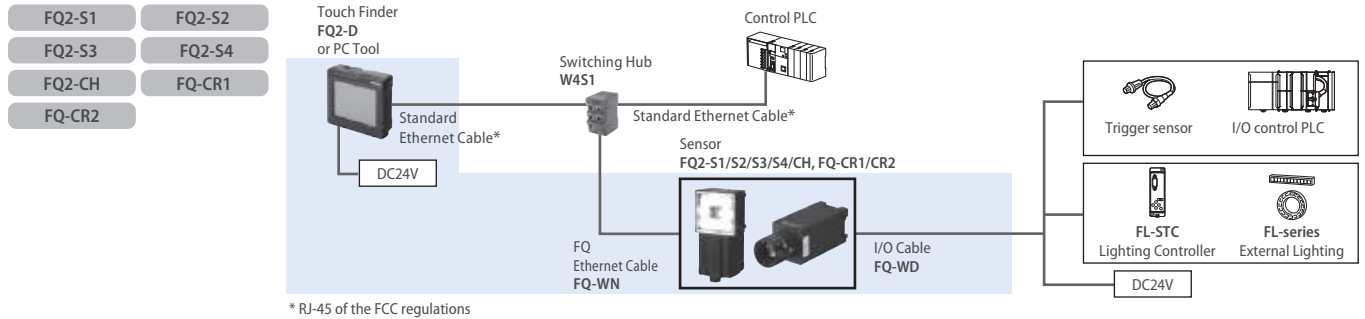

Parallel Interface Connection

Connection with Standard Parallel Interface of the Sensor

- | | |
|--------|--------|
| FQ2-S1 | FQ2-S2 |
| FQ2-S3 | FQ2-S4 |
| FQ2-CH | FQ-CR1 |
| FQ-CR2 | |

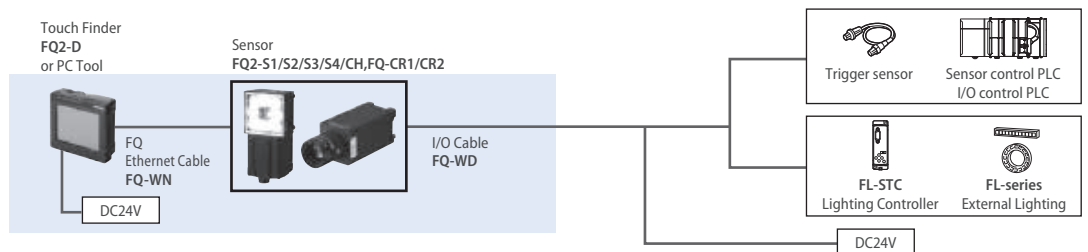

Connection through a Parallel Interface Sensor Data Unit

- | | |
|--------|--------|
| FQ2-S1 | FQ2-S2 |
| FQ2-S3 | FQ2-S4 |
| FQ2-CH | FQ-CR1 |
| FQ-CR2 | |

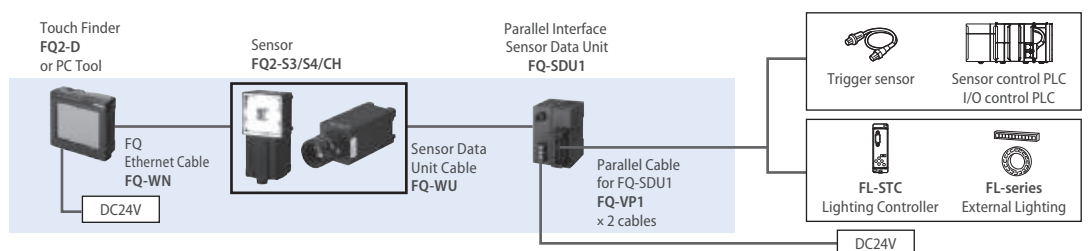

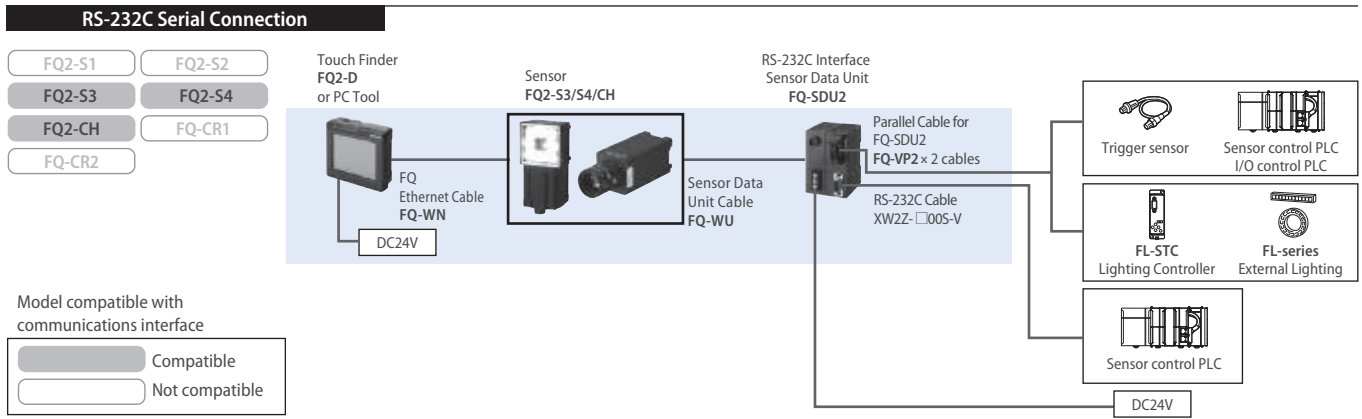

Ordering Information

Sensor

Inspection model

FQ2-S1 Series [Single-function Type]

Field of vision	Narrow View	Standard View	Wide View (Long-distance)	Wide View (Short-distance)
Number of pixels	350,000 pixels			
Color	NPN	FQ2-S10010F	FQ2-S10050F	FQ2-S10100F
	PNP	FQ2-S15010F	FQ2-S15050F	FQ2-S15100F
Field of vision/Installation distance	Refer to Figure 1 on page 317.	Refer to Figure 2 on page 317.	Refer to Figure 3 on page 317.	Refer to Figure 4 on page 317.

FQ2-S2 Series [Standard Type]

Field of vision	Narrow View	Standard View	Wide View (Long-distance)	Wide View (Short-distance)
Number of pixels	350,000 pixels			
Color	NPN	FQ2-S20010F	FQ2-S20050F	FQ2-S20100F
	PNP	FQ2-S25010F	FQ2-S25050F	FQ2-S25100F
Field of vision/Installation distance	Refer to Figure 1 on page 317.	Refer to Figure 2 on page 317.	Refer to Figure 3 on page 317.	Refer to Figure 4 on page 317.

FQ2-S3 Series [High-resolution Type]

Field of vision	Narrow View	Standard View	Wide View (Long-distance)	Wide View (Short-distance)	C-mount
Number of pixels	760,000 pixels				1.3 million pixels
Color	NPN	FQ2-S30010F-08	FQ2-S30050F-08	FQ2-S30100F-08	FQ2-S30100N-08
	PNP	FQ2-S35010F-08	FQ2-S35050F-08	FQ2-S35100F-08	FQ2-S35100N-08
Monochrome	NPN	FQ2-S30010F-08M	FQ2-S30050F-08M	FQ2-S30100F-08M	FQ2-S30100N-08M
	PNP	FQ2-S35010F-08M	FQ2-S35050F-08M	FQ2-S35100F-08M	FQ2-S35100N-08M
Field of vision/Installation distance	Refer to Figure 5 on page 317.	Refer to Figure 6 on page 317.	Refer to Figure 7 on page 317.	Refer to Figure 8 on page 317.	Refer to optical chart on p. 318

Inspection/ID model

FQ2-S4 Series [Standard Type]

Field of vision	Narrow View	Standard View	Wide View (Long-distance)	Wide View (Short-distance)
Number of pixels	350,000 pixels			
Color	NPN	FQ2-S40010F	FQ2-S40050F	FQ2-S40100F
	PNP	FQ2-S45010F	FQ2-S45050F	FQ2-S45100F
Monochrome	NPN	FQ2-S40010F-M	FQ2-S40050F-M	FQ2-S40100F-M
	PNP	FQ2-S45010F-M	FQ2-S45050F-M	FQ2-S45100F-M
Field of vision/Installation distance	Refer to Figure 1 on page 317.	Refer to Figure 2 on page 317.	Refer to Figure 3 on page 317.	Refer to Figure 4 on page 317.

[High-resolution Type]

Field of vision	Narrow View	Standard View	Wide View (Long-distance)	Wide View (Short-distance)	C-mount
Number of pixels	760,000 pixels				1.3 million pixels
Color	NPN	FQ2-S40010F-08	FQ2-S40050F-08	FQ2-S40100F-08	FQ2-S40100N-08
	PNP	FQ2-S45010F-08	FQ2-S45050F-08	FQ2-S45100F-08	FQ2-S45100N-08
Monochrome	NPN	FQ2-S40010F-08M	FQ2-S40050F-08M	FQ2-S40100F-08M	FQ2-S40100N-08M
	PNP	FQ2-S45010F-08M	FQ2-S45050F-08M	FQ2-S45100F-08M	FQ2-S45100N-08M
Field of vision/Installation distance	Refer to Figure 5 on page 317.	Refer to Figure 6 on page 317.	Refer to Figure 7 on page 317.	Refer to Figure 8 on page 317.	Refer to optical chart on p. 318

ID Model

FQ2-CH Series [Optical Character Recognition Sensor]

Field of vision		Narrow View	Standard View	Wide View (Long-distance)	Wide View (Short-distance)
Number of pixels		350,000 pixels			
Monochrome	NPN	FQ2-CH10010F-M	FQ2-CH10050F-M	FQ2-CH10100F-M	FQ2-CH10100N-M
	PNP	FQ2-CH15010F-M	FQ2-CH15050F-M	FQ2-CH15100F-M	FQ2-CH15100N-M
Field of vision/Installation distance		Refer to Figure 1 on page 317.	Refer to Figure 2 on page 317.	Refer to Figure 3 on page 317.	Refer to Figure 4 on page 317.

FQ-CR1 Series [Multi Code Reader]





Field of vision		Narrow View	Standard View	Wide View (Long-distance)	Wide View (Short-distance)
Number of pixels		350,000 pixels			
Monochrome	NPN	FQ-CR10010F-M	FQ-CR10050F-M	FQ-CR10100F-M	FQ-CR10100N-M
	PNP	FQ-CR15010F-M	FQ-CR15050F-M	FQ-CR15100F-M	FQ-CR15100N-M
Field of vision/Installation distance		Refer to Figure 1 on page 317.	Refer to Figure 2 on page 317.	Refer to Figure 3 on page 317.	Refer to Figure 4 on page 317.

FQ-CR2 Series [2D Code Reader]

Field of vision		Narrow View	Standard View	Wide View (Long-distance)	Wide View (Short-distance)
Number of pixels		350,000 pixels			
Monochrome	NPN	FQ-CR20010F-M	FQ-CR20050F-M	FQ-CR20100F-M	FQ-CR20100N-M
	PNP	FQ-CR25010F-M	FQ-CR25050F-M	FQ-CR25100F-M	FQ-CR25100N-M
Field of vision/Installation distance		Refer to Figure 1 on page 317.	Refer to Figure 2 on page 317.	Refer to Figure 3 on page 317.	Refer to Figure 4 on page 317.

Field of vision/Installation distance

(Unit: mm)

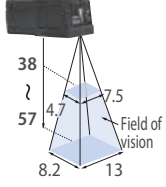
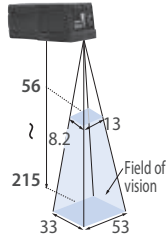
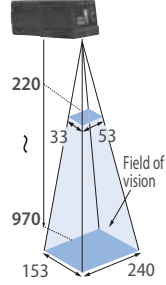
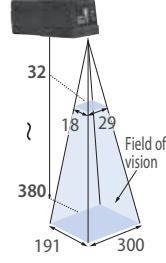
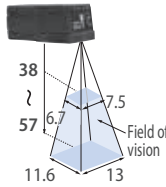
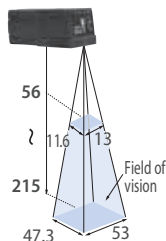
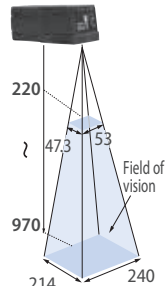
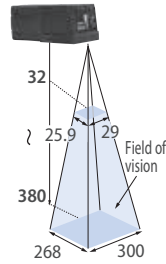
Field of vision	Narrow View	Standard View	Wide View (Long-distance)	Wide View (Short-distance)
Appearance				
350,000 pixels type	Figure 1 	Figure 2 	Figure 3 	Figure 4 
760,000 pixels type	Figure 5 	Figure 6 	Figure 7 	Figure 8 

Optical Chart for C-mount Camera FQ2-S3□-13□/-S4□-13□

High-resolution, Low-distortion Lenses 3Z4S-LE SV-□□□□H

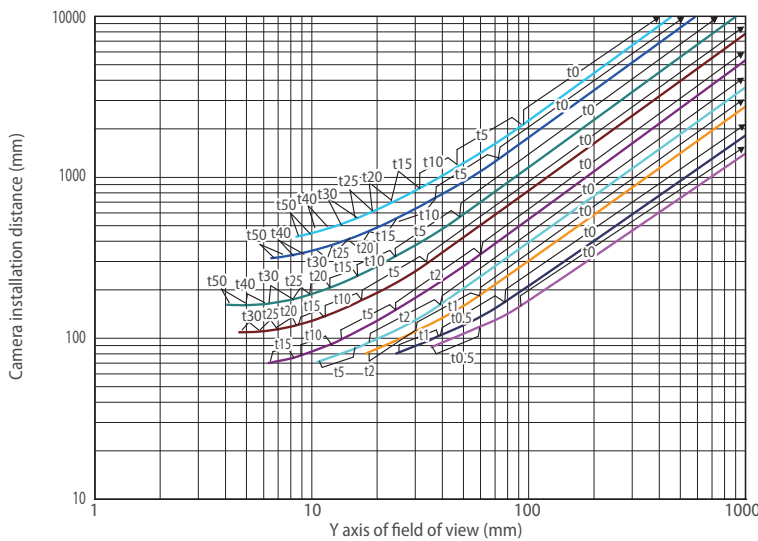

- 3Z4S-LE
- SV-0614H
 - SV-0814H
 - SV-1214H
 - SV-1614H
 - SV-2514H
 - SV-3514H
 - SV-5014H
 - SV-7525H
 - SV-10028H

Extension tube
 Examples
 t0: Extension tube is not required.
 t5: A 5-mm extension tube is required.

Meaning of Optical Chart

The X axis of the optical chart shows the field of vision (mm) (See Note.), and the Y axis of the optical chart shows the camera installation distance (mm).

Note: The lengths of the fields of vision given in the optical charts are the lengths of the Y axis.

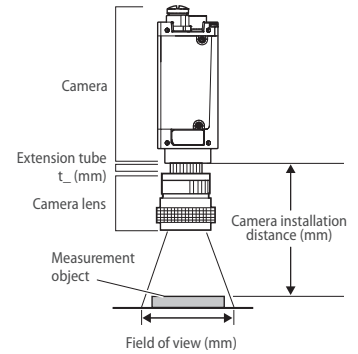

Touch Finder

Type	Appearance	Order code
DC power supply		FQ2-D30
AC/DC/battery		FQ2-D31

Cables

Type	Appearance	Cable length	Order code
FQ Ethernet Cables (connect Sensor to Touch Finder, Sensor to PC)		2m	FQ-WN002
		5m	FQ-WN005
		10m	FQ-WN010
		20m	FQ-WN020
I/O Cables		2m	FQ-WD002
		5m	FQ-WD005
		10m	FQ-WD010
		20m	FQ-WD020

Sensor Data Unit (FQ2-S3/S4/CH only)

Type	Appearance	Output type	Order code
Parallel Interface		NPN	FQ-SDU10
		PNP	FQ-SDU15
RS-232C Interface		NPN	FQ-SDU20
		PNP	FQ-SDU25

Cables for Sensor Data Unit

Type	Appearance	Cable length	Order code
Sensor Data Unit Cable		2m	FQ-WU002
		5m	FQ-WU005
		10m	FQ-WU010
		20m	FQ-WU020
Parallel Cable for FQ-SDU1 ^{*1}		2m	FQ-VP1002
		5m	FQ-VP1005
		10m	FQ-VP1010
Parallel Cable for FQ-SDU2 ^{*1}		2m	FQ-VP2002
		5m	FQ-VP2005
		10m	FQ-VP2010
RS-232C Cable for FQ-SDU2 ^{*1}		2m	XW2Z-2005-V
		5m	XW2Z-5005-V

*1 When using FQ-SDU□□, 2 cables are required for all I/O signals.

External Lighting

Type	Model
FLV series	Refer to FLV series catalog Q198

Accessories

Application	Appearance	Name	Order code
For Sensor		Mounting Bracket ^{*1}	FQ-XL
		Mounting Bracket	FQ-XL2
		Mounting Base for C-mount type ^{*2}	FQ-XLC
		Polarizing Filter Attachment ^{*1}	FQ-XF1
		Panel Mounting Adapter	FQ-XPM
For Touch Finder		AC Adapter (for AC/DC/battery model) ^{*4}	FQ-A□
		Battery (for AC/DC/battery model)	FQ-BAT1
		Touch Pen ^{*4}	FQ-XT
		Strap	FQ-XH
		SD CARD (4 GB)	HMC-SD491

*1 Included with Integrated Sensor.



*2 Included with Sensor with C-mount.

*4. AC Adapters for Touch Finder with DC/AC/Battery Power Supply. Select the model for the country in which the Touch Finder will be used.

Plug Type	Voltage	Certified standards	Order code
A	125 V max.	PSE	FQ-AC1
		UL/CSA	FQ-AC2
	250 V max.	CCC mark	FQ-AC3
C	250 V max.	-	FQ-AC4
BF	250 V max.	-	FQ-AC5
C	250 V max.	-	FQ-AC6









*4. Enclosed with Touch Finder.

Industrial Switching Hubs (Recommended)

Appearance	Number of ports	Failure detection	Current consumption	Order code
	3	None	0.22 A	W4S1-03B
	5	None	0.22 A	W4S1-05B
		Supported		W4S1-05C

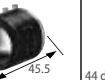
Lenses for C-mount Camera. Refer to optical chart on p. 318 for selection of a lens.

High-resolution, Low-distortion Lenses

Model	3Z4S-LE SV-0614H	3Z4S-LE SV-0814H	3Z4S-LE SV-1214H	3Z4S-LE SV-1614H	3Z4S-LE SV-2514H	3Z4S-LE SV-3514H	3Z4S-LE SV-5014H	3Z4S-LE SV-7525H	3Z4S-LE SV-10028H
Appearance									
Focal length	6 mm	8 mm	12 mm	16 mm	25 mm	35 mm	50 mm	75 mm	100 mm
Brightness	F1.4	F1.4	F1.4	F1.4	F1.4	F1.4	F1.4	F2.5	F2.8
Filter size	M40.5 P0.5	M35.5 P0.5	M27 P0.5	M27 P0.5	M27 P0.5	M35.5 P0.5	M40.5 P0.5	M34.0 P0.5	M37.5 P0.5

Extension Tubes

Model	3Z4S-LE SV-EXR
Contents	Set of 7 tubes (40 mm, 20 mm, 10 mm, 5 mm, 2.0 mm, 1.0 mm, and 0.5 mm) Maximum outer diameter: 30 mm dia.

Note: Do not use the 0.5-mm, 1.0-mm, and 2.0-mm Extension Tubes attached to each other. Since these Extension Tubes are placed over the threaded section of the Lens or other Extension Tube, the connection may loosen when more than one 0.5-mm, 1.0-mm or 2.0-mm Extension Tube are used together.

Note: Reinforcement is required to protect against vibration when Extension Tubes exceeding 30 mm are used.

Ratings and Performance

Sensor

Inspection Model FQ2-S1/S2/S3 Series

Item	Single-function type	Standard type	High-resolution type				
Model	NPN FQ2-S10□□□□	FQ2-S20□□□□	FQ2-S30□□□□-08	FQ2-S30□□□□-08M	FQ2-S30-13	FQ2-S30-13M	
	PNP FQ2-S15□□□□	FQ2-S25□□□□	FQ2-S35□□□□-08	FQ2-S35□□□□-08M	FQ2-S35-13	FQ2-S35-13M	
Field of view	Refer to Ordering Information on p.19. (Tolerance (field of vision): ±10% max.)					Select a lens according to the field of vision and installation distance. Refer to optical chart on p. 318.	
Installation distance							
Main functions	Inspection items	Search, shape search II, sensitive search, area, color data, edge position, edge pitch, edge width, and labeling					
	Number of simultaneous measurements	1	32				
	Position compensation	Supported (360° Model position compensation, Edge position compensation)					
	Number of registered scenes	8	32				
	Calibration	Supported					
Image input	Image processing method	Real color		Monochrome	Real color	Monochrome	
	Image filter	High dynamic range (HDR), image adjustment (Color Gray Filter, Weak smoothing, Strong smoothing, Dilate, Erosion, Median, Extract edges, Extract horizontal edges, Extract vertical edges, Enhance edges, Background suppression), polarizing filter (attachment), and white balance (Sensors with Color Cameras only)					
	Image elements	1/3-inch color CMOS		1/2-inch color CMOS	1/2-inch Monochrome CMOS	1/2-inch color CMOS	1/2-inch Monochrome CMOS
	Shutter	Built-in lighting ON: 1/250 to 1/50,000 Built-in lighting OFF: 1/1 to 1/50,000		Built-in lighting ON: 1/250 to 1/60,000 Built-in lighting OFF: 1/1 to 1/60,000		1/1 to 1/60,000	
	Processing resolution	752 × 480		928 × 828		1,280 × 1,024	
	Partial input function	Supported horizontally only.		Supported horizontally and vertically			
	Lens mounts	-				C-mount	
Lighting	Lighting method	Pulse				-	
	Lighting color	White				-	
Data logging	Measurement data	In Sensor: 1,000 items (If a Touch Finder is used, results can be saved up to the capacity of an SD card.)					
	Images	In Sensor: 20 images (If a Touch Finder is used, images can be saved up to the capacity of an SD card.)					
Auxiliary function	Math (arithmetic, calculation functions, trigonometric functions, and logic functions)						
Measurement trigger	External trigger (single or continuous) Communications trigger (Ethernet TCP no-protocol, Ethernet UDP no-protocol, Ethernet FINS/TCP no-protocol, EtherNet/IP, PLC Link, or PROFINET)						

Item	Single-function type	Standard type	High-resolution type				
Model	NPN	FQ2-S10□□□□	FQ2-S20□□□□	FQ2-S30□□□□-08	FQ2-S30□□□□-08M	FQ2-S30-13	FQ2-S30-13M
	PNP	FQ2-S15□□□□	FQ2-S25□□□□	FQ2-S35□□□□-08	FQ2-S35□□□□-08M	FQ2-S35-13	FQ2-S35-13M
I/O specifications	Input signals	7 signals Single measurement input (TRIG) Control command input (IN0 to IN5)					
	Output signals	3 signals Control output (BUSY) Overall judgement output (OR) Error output (ERROR) The assignments of the three output signals (OUT0 to OUT2) can be changed to the individual judgements of the inspection items, the image input ready output (READY), or the external lighting timing output (STGOUT).					
	Ethernet specifications	100Base-TX/10Base-T					
	Communications	Ethernet TCP no-protocol, Ethernet UDP no-protocol, Ethernet FINS/TCP no-protocol, EtherNet/IP, PLC Link, or PROFINET					
	I/O expansion	–	–	Possible by connecting FQ-SDU1_ Sensor Data Unit. 11 inputs and 24 outputs			
	RS-232C	–	–	Possible by connecting FQ-SDU2_ Sensor Data Unit. 8 inputs and 7 outputs			
Ratings	Power supply voltage	21.6 to 26.4 VDC (including ripple)					
	Current consumption	2.4 A max.					0.3 A max.
Environmental immunity	Ambient temperature range	Operating: 0 to 50°C Storage: –25 to 65°C (with no icing or condensation)			Operating: 0 to 40°C Storage: –25 to 65°C (with no icing or condensation)		
	Ambient humidity range	Operating and storage: 35% to 85% (with no condensation)					
	Ambient atmosphere	No corrosive gas					
	Vibration resistance (destruction)	10 to 150 Hz, single amplitude: 0.35 mm, X/Y/Z directions 8 min each, 10 times					
	Shock resistance (destruction)	150 m/s ² 3 times each in 6 direction (up, down, right, left, forward, and backward)					
	Degree of protection	IEC 60529 IP67 (Except when Polarizing Filter Attachment is mounted or connector cap is removed.)					IEC 60529 IP40
Materials	Sensor: PBT, PC, SUS Mounting Bracket: PBT Polarizing Filter Attachment: PBT, PC Ethernet connector: Oil-resistance vinyl compound I/O connector: Lead-free heat-resistant PVC					Cover: Zinc-plated steel, Thickness: 0.6 mm Case: Aluminum diecast alloy (ADC-12) Mounting base: Polycarbonate ABS	
Weight	Narrow View/Standard View: Approx. 160 g Wide View: Approx. 150 g					Approx. 160 g without base, Approx. 185 g with base	
Accessories included with sensor	Mounting Bracket (FQ-XL) (1) Polarizing Filter Attachment (FQ-XF1) (1) Instruction Manual, Quick Startup Guide Member Registration Sheet, Warning Label					Mounting Base (FQ-XLC) (1) Mounting Screw (M3 × 8mm) (4) Instruction Manual, Quick Startup Guide Member Registration Sheet	
LED class	Class 2 (Applicable standards: IEC 60825-1:1993 +A1:1997 +A2:2001, EN 60825-1:1994 +A1:2002 +A2:2001, and JIS C 6802:2005)						–
Applicable standards	EN standard EN 61326 and EC Directive No.2004/104/EC			EN 61326-1:2006 and IEC 61010-1			

Inspection/ID Model FQ2-S4 Series

Item	Inspection/ID Model						
Model	NPN	FQ2-S40□□□□	FQ2-S40□□□□-M	FQ2-S40□□□□-08	FQ2-S40□□□□-08M	FQ2-S40□□□□-13	FQ2-S40□□□□-13M
	PNP	FQ2-S45□□□□	FQ2-S45□□□□-M	FQ2-S45□□□□-08	FQ2-S45□□□□-08M	FQ2-S45□□□□-13	FQ2-S45□□□□-13M
Field of view	Refer to Ordering Information on p.19. (Tolerance (field of vision): ±10% max.)					Select a lens according to the field of vision and installation distance.	
Installation distance						Refer to optical chart on p.318.	
Main functions	Inspection items	Search, shape search II, sensitive search, area, color data, edge position, edge pitch, edge width, labeling, OCR ^{*1} , Bar code ^{*2} , 2D-code ^{*2} , 2D-code (DMP) ^{*3} , and Model dictionary					
	Number of simultaneous measurements	32					
	Position compensation	Supported (360° Model position compensation, Edge position compensation)					
	Number of registered scenes	32					
	Calibration	Supported					
	Retry function	Normal retry, Exposure retry, Scene retry, Trigger retry					
Image input	Image processing method	Real color	Monochrome	Real color	Monochrome	Real color	Monochrome
	Image filter	High dynamic range (HDR), image adjustment (Color Gray Filter, Weak smoothing, Strong smoothing, Dilate, Erosion, Median, Extract edges, Extract horizontal edges, Extract vertical edges, Enhance edges, Background suppression), polarizing filter (attachment), and white balance (Sensors with Color Cameras only)					
	Image elements	1/3-inch color CMOS	1/3-inch Monochrome CMOS	1/2-inch color CMOS	1/2-inch Monochrome CMOS	1/2-inch color CMOS	1/2-inch Monochrome CMOS
	Shutter	Built-in lighting ON: 1/250 to 1/50,000 Built-in lighting OFF: 1/1 to 1/50,000		Built-in lighting ON: 1/250 to 1/60,000 Built-in lighting OFF: 1/1 to 1/60,000		1/1 to 1/60,000	
	Processing resolution	752 × 480		928 × 828		1,280 × 1,024	
	Partial input function	Supported horizontally only.		Supported horizontally and vertically			
	Lens mounts	–					C-mount
Lighting	Lighting method	Pulse					–
	Lighting color	White					–

Item		Inspection/ID Model					
Model	NPN	FQ2-S40□□□□	FQ2-S40□□□□-M	FQ2-S40□□□□-08	FQ2-S40□□□□-08M	FQ2-S40□□□□-13	FQ2-S40□□□□-13M
	PNP	FQ2-S45□□□□	FQ2-S45□□□□-M	FQ2-S45□□□□-08	FQ2-S45□□□□-08M	FQ2-S45□□□□-13	FQ2-S45□□□□-13M
Data logging	Measurement data	In Sensor: 1,000 items (If a Touch Finder is used, results can be saved up to the capacity of an SD card.)					
	Images	In Sensor: 20 images (If a Touch Finder is used, images can be saved up to the capacity of an SD card.)					
Auxiliary function		Math (arithmetic, calculation functions, trigonometric functions, and logic functions)					
Measurement trigger		External trigger (single or continuous) Communications trigger (Ethernet TCP no-protocol, Ethernet UDP no-protocol, Ethernet FINS/TCP no-protocol, EtherNet/IP, PLC Link, or PROFINET)					
I/O specifications	Input signals	7 signals Single measurement input (TRIG) Control command input (IN0 to IN5)					
	Output signals	3 signals Control output (BUSY) Overall judgement output (OR) Error output (ERROR) The assignments of the three output signals (OUT0 to OUT2) can be changed to the individual judgements of the inspection items, the image input ready output (READY), or the external lighting timing output (STGOUT).					
	Ethernet specifications	100Base-TX/10Base-T					
	Communications	Ethernet TCP no-protocol, Ethernet UDP no-protocol, Ethernet FINS/TCP no-protocol, EtherNet/IP, PLC Link, or PROFINET					
	I/O expansion	Possible by connecting FQ-SDU1_ Sensor Data Unit. 11 inputs and 24 outputs					
	RS-232C	Possible by connecting FQ-SDU2_ Sensor Data Unit. 8 inputs and 7 outputs					
Ratings	Power supply voltage	21.6 to 26.4 VDC (including ripple)					
	Current consumption	2.4 A max.				0.3 A max.	
Environmental immunity	Ambient temperature range	Operating: 0 to 40°C Storage: -25 to 65°C (with no icing or condensation)					
	Ambient humidity range	Operating and storage: 35% to 85% (with no condensation)					
	Ambient atmosphere	No corrosive gas					
	Vibration resistance (destruction)	10 to 150 Hz, single amplitude: 0.35 mm, X/Y/Z directions 8 min each, 10 times					
	Shock resistance (destruction)	150 m/s ² 3 times each in 6 direction (up, down, right, left, forward, and backward)					
	Degree of protection	IEC 60529 IP67 (Except when Polarizing Filter Attachment is mounted or connector cap is removed.)				IEC 60529 IP40	
Materials	Sensor: PBT, PC, SUS Mounting Bracket: PBT Polarizing Filter Attachment: PBT, PC Ethernet connector: Oil-resistance vinyl compound I/O connector: Lead-free heat-resistant PVC				Cover: Zinc-plated steel, Thickness: 0.6 mm Case: Aluminum diecast alloy (ADC-12) Mounting base: Polycarbonate ABS		
Weight	Narrow View/Standard View: Approx. 160 g Wide View: Approx. 150 g				Approx. 160 g without base, Approx. 185 g with base		
Accessories included with sensor	Mounting Bracket (FQ-XL)(1) Polarizing Filter Attachment (FQ-XF1) (1) Instruction Manual, Quick Startup Guide Member Registration Sheet, Warning Label				Mounting Base (FQ-XLC) (1) Mounting Screw (M3 × 8mm)(4) Instruction Manual, Quick Startup Guide Member Registration Sheet		
LED class	Class 2 (Applicable standards: IEC 60825-1:1993 +A1:1997 +A2:2001, EN 60825-1:1994 +A1:2002 +A2:2001, and JIS C 6802:2005)				-		
Applicable standards	EN 61326-1:2006 and IEC 61010-1						

*1 The types of characters to be read are the same as those of FQ2-CH Optical Character Recognition Sensor.

*2 The types of codes to be read are the same as those of FQ-CR1 Multi Code Reader.

*3 The types of codes to be read are the same as those of FQ-CR2 2D Code Reader.

ID Model FQ2-CH, FQ-CR1/CR2 Series

Item		Optical Character Recognition Sensor	Multi Code Reader	2D Code Reader
Model	NPN	FQ2-CH10□□□□-M	FQ-CR10□□□□-M	FQ-CR20□□□□-M
	PNP	FQ2-CH15□□□□-M	FQ-CR15□□□□-M	FQ-CR25□□□□-M
Field of view		Refer to Ordering Information on page 316. (Tolerance (field of vision): ±10% max.)		
Installation distance				
Main functions	Inspection items	OCR · Alphabet A to Z · Number 0 to 9 · Symbol ' - . : / Model dictionary	2D Code (Data Matrix(EC200), QR Code, MicroQR Code, PDF417, MicroPDF417, GS1-Data Matrix) Bar Code (JAN/EAN/UPC, Code39, Codabar (NW-7), ITF (Interleaved 2 of 5), Code 93, Code 128/GS1-128, GS1 DataBar* (Truncated, Stacked, Omnidirectional, Stacked Omnidirectional, Limited, Expanded, Expanded Stacked), Pharmacode, GS1-128 Composite Code (CC-A, CC-B, CC-C)	2D Code (Data Matrix(EC200), QR Code)
	Image filter	Weak smoothing, Strong smoothing, Dilate, Erosion, Median, Extract edges, Extract horizontal edges, Extract vertical edges, Enhance edges, Background suppression	None	Filter function (Smooth, Dilate, Erosion, Median), Code Error Correction Position Display
	Verification function	Supported	Supported	None
	Retry function	Normal retry, Exposure retry, Scene retry, Trigger retry		
	Number of simultaneous measurements	32		
	Position compensation	Supported (360° Model position compensation, Edge position compensation)	None	
	Number of registered scenes	32		
Image input	Image processing method	Monochrome		
	Image filter	High dynamic range (HDR) and polarizing filter (attachment)		
	Image elements	1/3-inch Monochrome CMOS		
	Shutter	Built-in lighting ON: 1/250 to 1/50,000 Built-in lighting OFF: 1/1 to 1/50,000	1/250 to 1/30,000	1/250 to 1/32,258
	Processing resolution	752 × 480		
Partial input function	Supported horizontally only.			
Lighting	Lighting method	Pulse		
	Lighting color	White		
Data logging	Measurement data	In Sensor: 1,000 items (If a Touch Finder is used, results can be saved up to the capacity of an SD card.)		
	Images	In Sensor: 20 images (If a Touch Finder is used, images can be saved up to the capacity of an SD card.)		
Auxiliary function		Math (arithmetic, calculation functions, trigonometric functions, and logic functions)		
Measurement trigger		External trigger (single or continuous) Communications trigger (Ethernet TCP no-protocol, Ethernet UDP no-protocol, Ethernet FINS/TCP no-protocol, EtherNet/IP, PLC Link, or PROFINET)	External trigger (single or continuous)	
I/O specifications	Input signals	7 signals Single measurement input (TRIG) Control command input (IN0 to IN5)		
	Output signals	3 signals Control output (BUSY) Overall judgement output (OR) Error output (ERROR) The assignments of the three output signals (OUT0 to OUT2) can be changed to the individual judgements of the inspection items, the image input ready output (READY), or the external lighting timing output (STGOUT).	3 signals Control output (BUSY) Overall judgement output (OR) Error output (ERROR) Note: The three output signals can be allocated for the judgements of individual inspection items.	
	Ethernet specifications	100Base-TX/10Base-T		
	Communications	Ethernet TCP no-protocol, Ethernet UDP no-protocol, Ethernet FINS/TCP no-protocol, EtherNet/IP, PLC Link, or PROFINET	Ethernet TCP no-protocol	
	I/O expansion	Possible by connecting FQ-SDU1_ Sensor Data Unit. 11 inputs and 24 outputs	-	
	RS-232C	Possible by connecting FQ-SDU2_ Sensor Data Unit. 8 inputs and 7 outputs	-	
Ratings	Power supply voltage	21.6 to 26.4 VDC (including ripple)		
	Current consumption	2.4 A max.		
Environmental immunity	Ambient temperature range	Operating: 0 to 40°C, Storage: -25 to 65°C (with no icing or condensation)	Operating: 0 to 50°C, Storage: -25 to 65°C (with no icing or condensation)	
	Ambient humidity range	Operating and storage: 35% to 85% (with no condensation)		
	Ambient atmosphere	No corrosive gas		
	Vibration resistance (destruction)	10 to 150 Hz, single amplitude: 0.35 mm, X/Y/Z directions 8 min each, 10 times		
	Shock resistance (destruction)	150 m/s ² 3 times each in 6 direction (up, down, right, left, forward, and backward)		
	Degree of protection	IEC 60529 IP67 (Except when Polarizing Filter Attachment is mounted or connector cap is removed.)		

Item		Optical Character Recognition Sensor	Multi Code Reader	2D Code Reader
Model	NPN	FQ2-CH10□□□□-M	FQ-CR10□□□□-M	FQ-CR20□□□□-M
	PNP	FQ2-CH15□□□□-M	FQ-CR15□□□□-M	FQ-CR25□□□□-M
Materials	Sensor: PBT, PC, SUS, Mounting Bracket: PBT, Polarizing Filter Attachment: PBT, PC Ethernet connector: Oil-resistance vinyl compound, I/O connector: Lead-free heat-resistant PVC			
Weight	Narrow View/Standard View: Approx.160 g Wide View: Approx. 150 g			
Accessories included with sensor	Mounting Bracket (FQ-XL)(1), Polarizing Filter Attachment (FQ-XF1) (1), Instruction Manual, Quick Startup Guide, Member Registration Sheet, Warning Label			
LED class	Class 2(Applicable standards: IEC 60825-1:1993 +A1:1997 +A2:2001,EN 60825-1:1994 +A1:2002 +A2:2001, and JIS C 6802:2005)			
Applicable standards	EN 61326-1:2006 and IEC61010-1			

Touch Finder

Item	Type	Model with DC power supply	Model with AC/DC/battery power supply
	Model	FQ2-D30	FQ2-D31
Number of connectable Sensor		Number of sensors that can be recognized (switched): 32 max. number of sensor that can displayed on monitor: 8 max.	
Main functions	Types of measurement displays	Last result display, Last NG display, trend monitor, histograms	
	Types of display images	Through, frozen, zoom-in, and zoom-out images	
	Data logging	Measurement results, measured images	
	Menu language	English, German, French, Italian, Spanish, Traditional Chinese, Simplified Chinese, Korean, Japanese	
Indications	LCD	Display device	3.5-inch TFT color LCD
		Pixels	320 × 240
		Display colors	16.7 million
	Backlight	Life expectancy ^{*1}	50,000 hours at 25°C
		Brightness adjustment	Provided
Screen saver		Provided	
Operation interface	Touch screen	Method	Resistance film
		Life expectancy ^{*2}	1,000,000 touch operations
External interface	Ethernet	100BASE-TX/10BASE-T	
	SD card	SDHC-compliant, Class 4 or higher recommended	
Ratings	Power supply voltage	DC power connection: 21.6 to 26.4 VDC (including ripple)	DC power connection: 21.6 to 26.4 VDC (including ripple) AC adapter (manufactured by Sino-American Japan Co., Ltd) connection: 100 to 240 VAC, 50/60 Hz Battery connection: FQ-BAT1 Battery (1cell, 3.7 V)
	Continuous operation on Battery ^{*3}	–	1.5 h
	Power consumption	DC power connection: 0.2 A max.	DC power connection: 0.2 A max. Charging battery: 0.4 A max.
Environmental immunity	Ambient temperature range	Operating: 0 to 50°C Storage: –25 to 65°C (with no icing or condensation)	Operating: 0 to 50°C when mounted to DIN Track or panel Operation on Battery: 0 to 40°C: –25 to 65°C (with no icing or condensation)
	Ambient humidity range	Operating and storage: 35% to 85% (with no condensation)	
	Ambient atmosphere	No corrosive gas	
	Vibration resistance (destruction)	10 to 150 Hz, single amplitude: 0.35 mm, X/Y/Z directions 8 min each, 10 times	
	Shock resistance (destruction)	150 m/s ² 3 times each in 6 direction (up, down, right, left, forward, and backward)	
	Degree of protection	IEC 60529 IP20 (when SD card cover, connector cap, or harness is attached)	
Weight	Approx. 270 g (without Battery and hand strap attached)		
Materials	Case: ABS		
Accessories included with Touch Finder	Touch Pen (FQ-XT), Instruction Manual		

*1 This is a guideline for the time required for the brightness to diminish to half the initial brightness at room temperature and humidity. The life of the backlight is greatly affected by the ambient temperature and humidity and will be shorter at lower or higher temperatures.

*2 This value is only a guideline. No guarantee is implied. The value will be affected by operating conditions.

*3 This value is only a guideline. No guarantee is implied. The value will be affected by the operating environment and operating conditions.

Sensor Data Units (FQ2-S3/S4/CH only)

Item		Parallel Interface	RS-232C Interface
Model	NPN	FQ-SDU10	FQ-SDU20
	PNP	FQ-SDU15	FQ-SDU25
I/O specifications	Parallel I/O	Connector 1	16 outputs (D0 to D15)
		Connector 2	11 inputs (TRIG, RESET, IN0 to IN7, and DSA) 8 outputs (GATE, ACK, RUN, BUSY, OR, ERROR, STGOUT, and SHTOUT)
	RS-232C	–	6 inputs (IN0 to IN5)
	Sensor interface	FQ2-S3 connected with FQ-WU□□□□: OMRON interface *Number of connected Sensors: 1	
Ratings	Power supply voltage	21.6 to 26.4 VDC (including ripple)	
	Insulation resistance	Between all DC external terminals and case: 0.5 MΩ min (at 250 VDC)	
	Current consumption	2.5 A max.: FQ2-S□□□□□□□-□□□□ and FQ-SDU□□□ 0.4 A max.: FQ2-S3□□-□□□□ and FQ-SDU□□□ 0.1 A max.: FQ-SDU□□□ only	
Environmental immunity	Ambient temperature range	Operating: 0 to 50°C, Storage: –20 to 65°C (with no icing or condensation)	
	Ambient humidity range	Operating and storage: 35% to 85% (with no condensation)	
	Ambient atmosphere	No corrosive gas	
	Vibration resistance (destruction)	10 to 150 Hz, single amplitude: 0.35 mm, X/Y/Z directions, 8 min each, 10 times	
	Shock resistance (destruction)	150 m/s ² 3 times each in 6 directions (up, down, right, left, forward, and backward)	
	Degree of protection	IEC 60529 IP20	
Materials	Case: PC + ABS, PC		
Weight	Approx. 150 g		
Accessories included with Sensor Data Unit	Instruction Manual		

Battery

Item/Model	FQ-BAT1
Battery type	Secondary lithium ion battery
Nominal capacity	1,800 mAh
Rated voltage	3.7 V
Ambient temperature range	Operating: 0 to 40°C Storage: –25 to 65°C (with no icing or condensation)
Ambient humidity range	Operating and storage: 35% to 85% (with no condensation)
Charging method	Charged in Touch Finder (FQ2-D31). AC adapter (FQ-AC□) is required.
Charging time* ¹	2 h
Usage time* ¹	1.5 h
Battery backup life* ²	300 charging cycles
Weight	50 g max.

*¹ This value is only a guideline. No guarantee is implied. The value will be affected by operating conditions

*² This is a guideline for the time required for the capacity of the Battery to be reduced to 60% of the initial capacity. No guarantee is implied. The value will be affected by the operating environment and operating conditions.

System Requirements for PC tool for FQ

The following Personal Computer system is required to use the software.

OS	Microsoft Windows XP Home Edition/Professional SP2 or higher (32-bit version) Microsoft Windows 7 Home Premium or higher (32-bit/64-bit version)
CPU	Core 2 Duo 1.06 GHz or the equivalent or higher
RAM	1GB min.
HDD	500 MB min. available space* ¹
Monitor	1,024 × 768 dots min.

*¹ Available space is also required separately for data logging.

Windows is registered trademarks of Microsoft Corporation in the USA and other countries.
Other company names and product names in this document are the trademarks or registered trademarks of their respective companies.

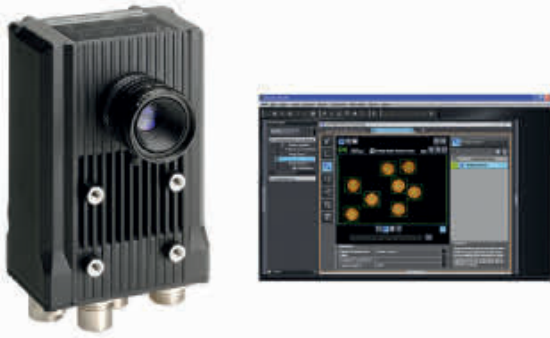

FQ-M Vision sensor

The new FQ-M series is a vision sensor designed specifically for Pick & Place applications. It comes with EtherCAT embedded and can be integrated easily into any environment. The FQ-M is compact, fast and includes an incremental encoder input for easy tracking calibration. Omron's Sysmac Studio software is the perfect tool for configuring the FQ-M and is complemented by the TouchFinder console for on-site monitoring.

Designed for motion tracking

- Made specifically for pick & place applications
- Connectivity with EtherCAT/Ethernet
- Encoder input for conveyor tracking and calibration
- Contour based object detection
- Smart calibration wizard
- Sysmac Studio software for vision system operation and setting

System configuration

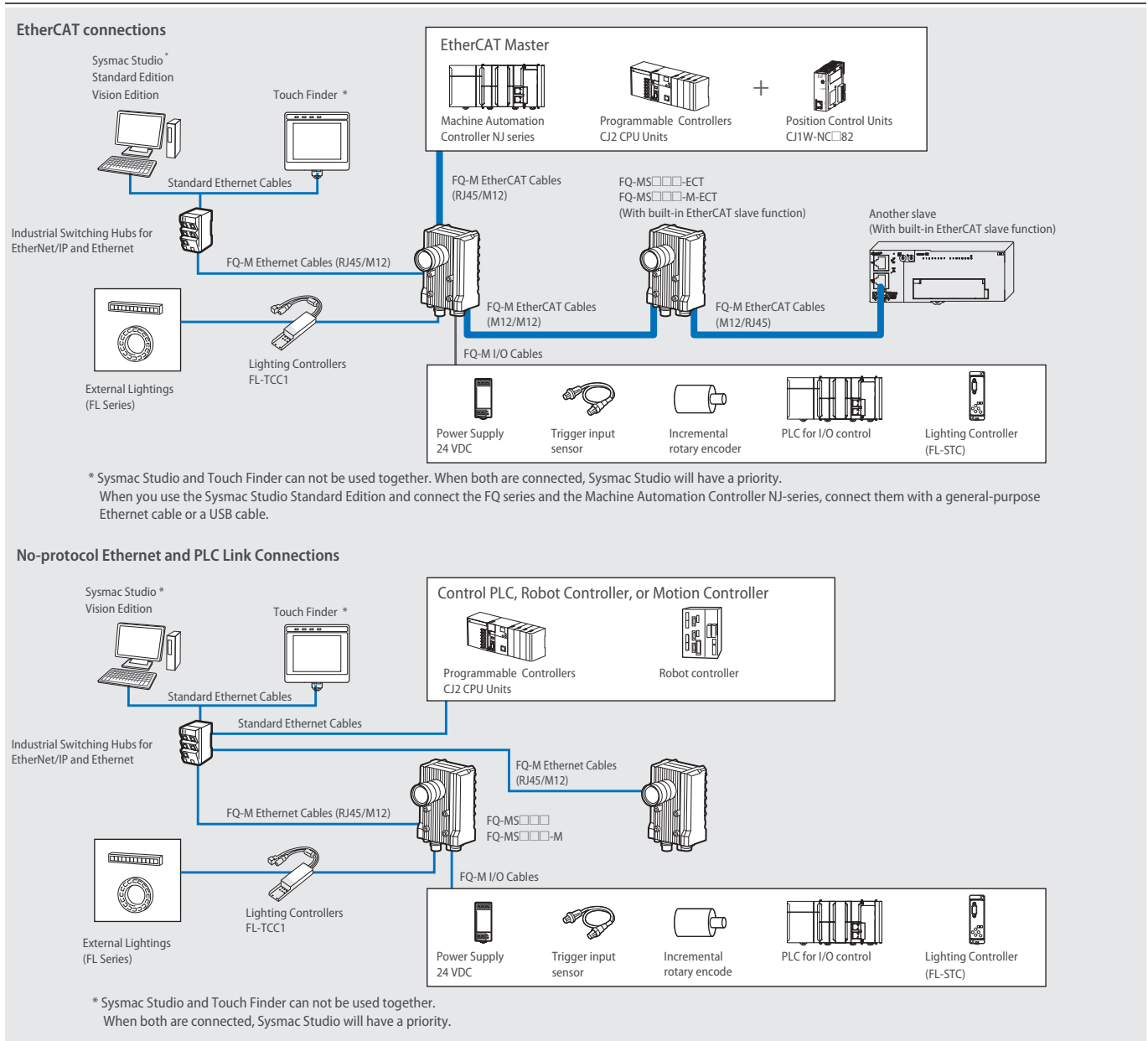

- Note:**
1. EtherCAT and Ethernet (PLC Link) can not be used simultaneously.
 2. It is not possible to configure and adjust the FQ-M via an NJ-series controller, when they are connected via an EtherCAT network. For configuration and adjustment of FQ-M, connect the FQ-M and a computer or a Touch Finder via an Ethernet network.

Sysmac is a trademark or registered trademark of OMRON Corporation in Japan and other countries for OMRON factory automation products. Windows is registered trademarks of Microsoft Corporation in the USA and other countries. EtherCAT[®] is registered trademark and patented technology, licensed by Beckhoff Automation GmbH, Germany. Other company names and product names in this document are the trademarks or registered trademarks of their respective companies.

Ordering Information

Sensors

Appearance	Type			Order code	
	Color	NPN	EtherCAT communication function not provided	FQ-MS120	
		PNP		FQ-MS125	
	Monochrome	NPN		FQ-MS120-M	
		PNP		FQ-MS125-M	
	Color	NPN		EtherCAT communication function provided	FQ-MS120-ECT
		PNP			FQ-MS125-ECT
Monochrome	NPN	FQ-MS120-M-ECT			
	PNP	FQ-MS125-M-ECT			

Automation Software Sysmac Studio

Please purchase a DVD and required number of licenses the first time you purchase the Sysmac Studio. DVDs and licenses are available individually. Each model of licenses does not include any DVD.

Product name	Specifications			Standards	Order code
		Number of licenses	Media		
Sysmac Studio Standard Edition Ver.1.□□ ^{*1}	The Sysmac Studio provides an integrated development environment to set up, program, debug, and maintain NJ-series Controllers and other Machine Automation Controllers, as well as EtherCAT slaves. Sysmac Studio runs on the following OS. Windows XP (Service Pack 3 or higher, 32-bit version) / Vista (32-bit version)/7 (32-bit/64-bit version) The Sysmac Studio Standard Edition DVD includes Support Software to set up EtherNet/IP Units, DeviceNet slaves, Serial Communications Units, and Support Software for creating screens on HMIs (CX-Designer). For details, refer to the Sysmac Integrated Catalogue (P072).	– (Media only)	DVD	–	SYSMAC-SE200D
		1 license ^{*2}	–	–	SYSMAC-SE201L
Sysmac Studio Vision Edition Ver.1.□□	Sysmac Studio Vision Edition is a limited license that provides selected functions required for Vision Sensor FQ-M settings. Because this product is a license only, you need the Sysmac Studio Standard Edition DVD media to install it.	1 license	–	–	SYSMAC-VE001L

^{*1} The FQ-M series is supported by Sysmac Studio version 1.01 or higher.







^{*2} Multi licenses are available for the Sysmac Studio (3, 10, 30, or 50 licenses).

Touch Finder







Appearance	Type	Order code
	DC power supply	FQ-MD30
	AC/DC/battery ^{*1}	FQ-MD31

^{*1} AC Adapter and Battery are sold separately.

Bend resistant Cables for FQ-M Series

Appearance	Type		Cable length	Order code
	For EtherCAT and Ethernet cable Angle: M12/ Straight: RJ45		5 m	FQ-MWNL005
			10 m	FQ-MWNL010
	For EtherCAT and Ethernet cable Straight type (M12/RJ45)		5 m	FQ-WN005-E
			10 m	FQ-WN010-E
	For EtherCAT cable Angle type (M12/M12)		5 m	FQ-MWNEL005
			10 m	FQ-MWNEL010
	For EtherCAT cable Straight type (M12/M12)		5 m	FQ-MWNE005
			10 m	FQ-MWNE010
	I/O Cables	Angle type	5 m	FQ-MWDL005
			10 m	FQ-MWDL010
		Straight type	5 m	FQ-MWDD005
			10 m	FQ-MWDD010



Accessories

Appearance	Type		Order code
	For Touch Finder	Panel Mounting Adapter	FQ-XPM
		AC Adapter (for models for DC/AC/Battery)	FQ-AC□*1
		Battery (for models for DC/AC/Battery)	FQ-BAT1
		Touch Pen (enclosed with Touch Finder)	FQ-XT
		Strap	FQ-XH
		SD Card (2 GB)	HMC-SD291

*1 AC Adapters for Touch Finder with DC/AC/Battery Power Supply. Select the model for the country in which the Touch Finder will be used.

Plug type	Voltage	Certified standards	Order code
A	125 V max.	PSE	FQ-AC1
		UL/CSA	FQ-AC2
	250 V max.	CCC mark	FQ-AC3
C	250 V max.	–	FQ-AC4
BF	250 V max.	–	FQ-AC5
O	250 V max.	–	FQ-AC6

Industrial Switching Hubs for EtherNet/IP and Ethernet

Appearance	Number of ports	Failure detection	Current consumption	Order code
	3	None	0.22 A	W4S1-03B
	5	None	0.22 A	W4S1-05B
		Supported		W4S1-05C

Note: 1. Industrial switching hubs are cannot be used for EtherCAT.

EtherCAT junction slaves

Appearance	Number of ports	Power supply voltage	Current consumption	Order code
	3	20.4 to 28.8 VDC (24 VDC –15% to 20%)	0.08 A	GX-JC03
	6		0.17 A	GX-JC06

Note: 1. Please do not connect EtherCAT junction slave with OMRON position control unit, Model CJ1W-NC□81/□82.
2. EtherCAT junction slaves cannot be used for EtherNet/IP and Ethernet.

Cameras peripheral devices

Type			Order code
Cameras peripheral devices	CCTV Lenses		3Z4S-LE Series
External Lightings			FL Series
Lighting Controllers	For FL Series		FL-TCC1

Specifications

Sensors

Item	Type	EtherCAT communication function not provided		EtherCAT communication function provided	
		Color	Monochrome	Color	Monochrome
Model	NPN	FQ-MS120	FQ-MS120-M	FQ-MS120-ECT	FQ-MS120-M-ECT
	PNP	FQ-MS125	FQ-MS125-M	FQ-MS125-ECT	FQ-MS125-M-ECT
Field of vision, Installation distance		Selecting a lens according to the field of vision and installation distance.			
Main functions	Inspection items	Shape search, Search, Labeling, Edge position			
	Number of simultaneous inspections	32			
	Number of registered scenes	32			
Image input	Image processing method	Real color	Monochrome	Real color	Monochrome
	Image elements	1/3-inch color CMOS	1/3-inch monochrome CMOS	1/3-inch color CMOS	1/3-inch monochrome CMOS
	Image filter	High dynamic range (HDR) and white balance	High dynamic range (HDR)	High dynamic range (HDR) and white balance	High dynamic range (HDR)
	Shutter	Electronic shutter; select shutter speeds from 1/10 to 1/30000 (sec)			
	Processing resolution	752 (H) × 480 (V)			
	Pixel size	6.0 (μm) × 6.0 (μm)			
	Frame rate (image read time)	60 fps (16.7 ms)			
External Lightings	Connecting method	Connection via a strobe light controller			
	Connectable lighting	FL series			
Data logging	Measurement data	In Sensor: Max. 32,000 items* ¹			
	Images	In Sensor: 20 images* ¹			
Measurement trigger	I/O trigger, Encoder trigger, Communications trigger (Ethernet No-protocol, PLC Link, or EtherCAT)				
I/O specifications	Input signals	9 signals Single measurement input (TRIG) Error clear input (INO) Encoder counter reset input (IN1) Encoder input (A±, B±, Z±)* ²			
	Output signals	5 signals* ³ OUT0 Overall judgement output (OR) OUT1 Control output (BUSY) OUT2 Error output (ERROR) OUT3 (Shutter output: SHTOUT) OUT4 (Strobe trigger output: STGOUT)			
	Ethernet specifications	100BASE-TX/10BASE-TX			
	EtherCAT specifications	-		Dedicated protocol for EtherCAT 100BASE-TX	
	Connection method	Special connector cables Power supply and I/O: 1 Special connector I/O cable Touch Finder, Computer and Ethernet: 1 Ethernet cable EtherCAT: 2 EtherCAT cable			
LED display		OR: Judgment result indicator ERR: Error indicator BUSY: BUSY indicator ETN: Ethernet communications indicator			
	EtherCAT display	-		L/A IN (Link/Activity IN) ×1 L/A OUT (Link/Activity OUT) ×1 RUN ×1 ERR ×1	
Ratings	Power supply voltage	21.6 to 26.4 VDC (including ripple)			
	Insulation resistance	Between all lead wires and case: 0.5 M Ω (at 250 V)			
	Current consumption	450mA max. (When the FL-series Strobe controller and lighting are used.) 250mA max. (When external lighting is not used.)			
Environmental immunity	Ambient temperature range	Operating: 0 to 50 °C, Storage: -20 to 65 °C (with no icing or condensation)			
	Ambient humidity range	Operating and storage: 35% to 85% (with no condensation)			
	Ambient atmosphere	No corrosive gas			
	Vibration resistance (destruction)	10 to 150 Hz, single amplitude: 0.35 mm, X/Y/Z directions, 8 min each, 10 times			
	Shock resistance (destruction)	150 m/s ² 3 times each in 6 direction (up, down, right, left, forward, and backward)			
Degree of protection	IEC60529 IP40				
Materials	Case: aluminium die casting, Rear cover: aluminium plate				
Weight	Approx. 390 g (Sensor only)		Approx. 480 g (Sensor only)		
Accessories	Instruction Manual				

*¹ If a Touch Finder is used, results can be saved up to the capacity of an SD card.

*² Encoder input specifications.

*³ The five output signals can be allocated for the judgements of individual inspection items.

Pulse input Specifications (When an open collector type encoder is used.)

Item	Specification		
Input voltage	24 VDC±10%	12 VDC±10%	5 VDC±5%
Input current	4.8 mA (at 24 VDC, typical value)	2.4 mA (at 12 VDC, typical value)	1.0 mA (at 5 VDC, typical value)
NPN	ON voltage ^{*1}	4.8 V max.	2.4 V max.
	OFF voltage ^{*2}	19.2 V min.	9.6 V min.
PNP	ON voltage ^{*1}	19.2 V min.	9.6 V min.
	OFF voltage ^{*2}	4.8 V max.	2.4 V max.
Maximum response frequency ^{*3}	50 kHz (I/O cable: when the FQ-MWD005 or FQ-MWDL005 cables is used.) 20 kHz (I/O cable: when the FQ-MWD010 or FQ-MWDL010 cables is used.)		
Input impedance	5.1 k		

^{*1} ON voltage: Voltage to change from OFF to ON state. The ON voltage is the difference of voltages between the GND terminal of the encoder power terminals and each input terminal.

^{*2} OFF voltage: Voltage to change from ON to OFF state. The ON voltage is the difference of voltages between the GND terminal of the encoder power terminals and each input terminal.

^{*3} Select maximum response frequency depending on length of the encoder cable and response frequency of the encoder.

Pulse input Specifications (When a line-driver output type encoder is used.)

Item	Specification
Input voltage	EIA standard RS-422-A line driver level
Input impedance ^{*1}	120 ±5%
Differential input voltage	0.2 V min.
Hysteresis voltage	50 mV
Maximum response frequency ^{*2}	200 kHz (I/O cable: when the FQ-MWD005, FQ-MWDL005, FQ-MWD010, or FQ-MWDL010 cables is used.)

^{*1} When terminating resistance function is used.

^{*2} Select maximum response frequency depending on length of the encoder cable and response frequency of the encoder.

Touch Finder

Item	Type	Model with DC power supply	Model with AC/DC/battery power supply	
Model		FQ-MD30	FQ-MD31	
Number of connectable Sensors		2 max.		
Main functions	Types of measurement displays	Last result display, Last NG display, trend monitor, histograms		
	Types of display images	Through, frozen, zoom-in, and zoom-out images		
	Data logging	Measurement results, measured images		
	Menu language	English, Japanese		
Indications	LCD	Display device	3.5-inch TFT color LCD	
		Pixels	320 × 240	
		Display colors	16,777,216	
	Backlight	Life expectancy* ¹	50,000 hours at 25°C	
		Brightness adjustment	Provided	
		Screen saver	Provided	
	Indicators	Power indicator (color: green)	POWER	
		Error indicator (color: red)	ERROR	
		SD card access indicator (color: yellow)	SD ACCESS	
		Charge indicator (color: orange)	-	CHARGE
Operation interface	Touch screen	Method	Resistance film	
		Life expectancy* ²	1,000,000 operations	
External interface	Ethernet	100 BASE-TX/10 BASE-T		
	SD card	Omron SD card (Model: HMC-SD291) or a SDHC card of Class4 or higher rating is recommended.		
Ratings	Power supply voltage	DC power connection	20.4 to 26.4 VDC (including ripple)	
		AC adapter connection	-	
		Battery connection	-	
	Continuous operation on Battery* ³	-	1.5 h	
	Current consumption	DC power connection: 0.2 A		
Insulation resistance	Between all lead wires and case: 0.5 M (at 250 V)			
Environmental immunity	Ambient temperature range	Operating: 0 to 50°C Storage: -25 to 65°C (with no icing or condensation)	Operating: 0 to 50°C when mounted to DIN Track or panel 0 to 40°C when operated on a Battery Storage: -25 to 65°C (with no icing or condensation)	
	Ambient humidity range	Operating and storage: 35% to 85% (with no condensation)		
Environmental immunity	Ambient atmosphere	No corrosive gas		
	Vibration resistance (destruction)	10 to 150 Hz, single amplitude: 0.35 mm, X/Y/Z directions 8 min each, 10 times		
	Shock resistance (destruction)	150 m/s ² 3 times each in 6 direction (up, down, right, left, forward, and backward)		
	Degree of protection	IEC 60529 IP20		
Dimensions	95 × 85 × 33 mm			
Materials	Case: ABS			
Weight	Approx. 270 g (without Battery and hand strap)			
Accessories	Touch Pen (FQ-XT), Instruction Manual			

*¹ This is a guideline for the time required for the brightness to diminish to half the initial brightness at room temperature and humidity. No guarantee is implied. The life of the backlight is greatly affected by the ambient temperature and humidity. It will be shorter at lower or higher temperatures.

*² This value is only a guideline. No guarantee is implied. The value will be affected by operating conditions.

*³ This value is only a guideline. No guarantee is implied. The value will be affected by the operating environment and operating conditions.

Battery Specifications

Item/Model	FQ-BAT1
Battery type	Secondary lithium ion battery
Nominal capacity	1,800 mAh
Rated voltage	3.7 V
Dimensions	35.3 × 53.1 × 11.4 mm
Ambient temperature range	Operating: 0 to 40°C Storage: -25 to 65°C (with no icing or condensation)
Ambient humidity range	Operating and storage: 35% to 85% (with no condensation)
Charging method	Charged in Touch Finder (FQ-MD31). AC adapter (FQ-AC□) is required.
Charging time *1	2.0 h
Battery backup life *2	300 charging cycles
Weight	50 g max.

*1 This value is only a guideline. No guarantee is implied. The value will be affected by operating conditions.

*2 This is a guideline for the time required for the capacity of the Battery to be reduced to 60% of the initial capacity. No guarantee is implied. The value will be affected by the operating environment and operating conditions.

Sysmac Studio

Item	Requirement
Operating system (OS) *1, *2 Japanese or English system	Windows XP (Service Pack 3 or higher, 32-bit version) / Vista (32-bit version) / 7 (32-bit/64-bit version)
CPU	Windows computers with Celeron 540 (1.8 GHz) or faster CPU. Core i5 M520 (2.4 GHz) or equivalent or faster recommended
Main memory	2 GB min.
Hard disk	At least 1.6 GB of available space*3
Display	XGA 1,024 × 768, 1,600 million colors. WXGA 1,280 × 800 min. recommended
Disk drive	DVD-ROM drive
Communications ports	USB port corresponded to USB 2.0, or Ethernet port

*1 Sysmac Studio Operating System Precaution:

System requirements and hard disk space may vary with the system environment.

*2 The following restrictions apply when Sysmac Studio is used with Microsoft Windows Vista or Windows 7.

Some Help files cannot be accessed.

The Help files can be accessed if the Help program distributed by Microsoft for Windows (WinHlp32.exe) is installed. Refer to the Microsoft homepage listed below or contact Microsoft for details on installing the file. (The download page is automatically displayed if the Help files are opened while the user is connected to the Internet.)

<http://support.microsoft.com/kb/917607/en-us>

*3 To use the file logging function, additional memory area to save the logging data is necessary.

FQ-M Series EtherCAT Communications Specifications

Item	Specifications
Communications standard	IEC 61158 Type12
Physical layer	100BASE-TX (IEEE802.3)
Connector	M12 × 2 E-CAT IN:EtherCAT (IN) E-CAT OUT:EtherCAT (OUT)
Communications media	Use the cables for FQ-MWN□□, or FQ-WN□□ series.
Communications distance	Use the communication cable within the length of FQ-MWN□□ or FQ-WN□□ series cables.
Process data	Variable PDO Mapping
Mailbox (CoE)	Emergency messages, SDO requests, SDO responses, and SDO information
Distributed clock	Synchronization with DC mode 1
LED display	L/A IN (Link/Activity IN) × 1, L/A OUT (Link/Activity OUT) × 1, RUN × 1, ERR × 1

Version Information

FQ-M Series and Programming Devices

FQ-M Series	Required Programming Device	
	Sysmac Studio Standard Edition/Vision Edition	
	Ver.1.00	Ver.1.01 or higher
FQ-MS□□□(-M) FQ-MS□□□(-M)-ECT	Not supported	Supported

Components and Functions

Sensor

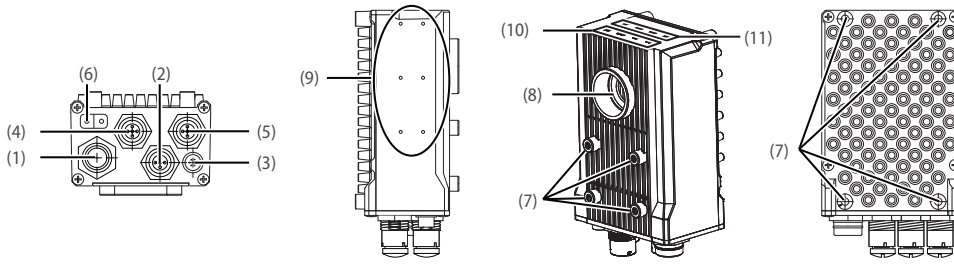

No.	Name	Description
(1)	I/O Cable connector	An I/O Cable is used to connect the Sensor to the power supply and external I/O.
(2)	Ethernet connector	An Ethernet cable is used to connect the Sensor to external devices such as PLCs, the Touch Finder, or computers.
(3)	Lighting connector	Connect an external lighting (strobe controller).
(4)	EtherCAT connector (IN) ^{*1}	Connect an EtherCAT compatible device.
(5)	EtherCAT connector (OUT) ^{*1}	Connect an EtherCAT compatible device.
(6)	Node address switch ^{*1}	Set the node address for EtherCAT communications.
(7)	Installation holes	Holes to install and secure the camera.
(8)	C-mount lens connection part	Install the C-mount lens in this part. Determine the field of view depending on the measurement target and select a suitable CCTV lens (C-mounting lens).

No.	Name	Description	
(9)	Strobe controller connection holes	Install the strobe controller in this part. FL-TCC1 can be mounted.	
(10)	Measurement process Operation indicators	OR	Lit in orange while OR signal is ON.
		ETN	Lit in orange while in Ethernet communications.
		ERROR	Lit in red when an error occurs.
(11)	EtherCAT Operation indicators	BUSY	Lit in green while the sensor is processing.
		L/A IN	Lit in green when Link with EtherCAT device is established and flickers in green when communicating (data IN).
		L/A OUT	Lit in green when Link with EtherCAT device is established and flickers in green when communicating (data OUT).
		ECAT RUN	Lit in green when EtherCAT communication is available.
		ECAT ERROR	Lit in red when an EtherCAT communications error occurs.

^{*1} FQ-MS□□□-ECT and FQ-MS□□□-M-ECT only.

Touch Finder

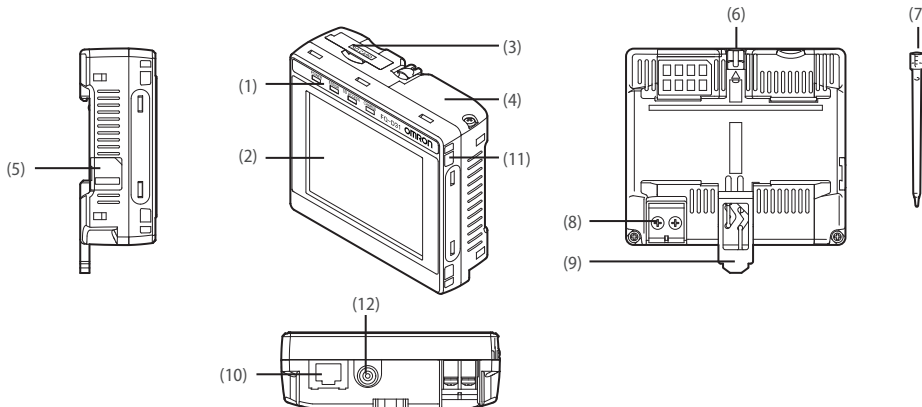

No.	Name	Description	
(1)	Operation indicators	POWER ^{*1}	Lights green when the Touch Finder is turned ON.
		ERROR	Lights red when an error occurs.
		SD ACCESS	Lights yellow when an SD card is inserted. Flashes yellow when the SD card is being accessed.
		CHARGE ^{*1}	Lights orange when the Battery is charging.
(2)	LCD/touch panel	Displays the setting menu, measurement results, and images input by the camera.	
(3)	SD card slot	An SD card can be inserted.	
(4)	Battery cover [*]	The Battery is inserted behind this cover. Remove the cover when mounting or removing the Battery.	
(5)	Power supply switch	The Battery is inserted behind this cover. Remove the cover when mounting or removing the Battery.	

No.	Name	Description
(6)	Touch pen holder	The touch pen can be stored here when it is not being used.
(7)	Touch pen	Used to operate the touch panel.
(8)	DC power supply connector	Used to connect a DC power supply.
(9)	Slider	Used to mount the Touch Finder to a DIN Track.
(10)	Ethernet port	Used when connecting the Touch Finder to the Sensor with an Ethernet cable. Insert the connector until it locks in place.
(11)	Strap holder	This is a holder for attaching the strap.
(12)	AC power supply connector ^{*1}	Used to connect the AC adapter.

^{*1} Applicable to the FQ-MD31 only.

^{*1} Applicable to the FQ-MD31 only.



Faster machine speed and high-precision operation

The new FH vision systems are specifically intended for seamless integration with PLCs, motion controllers and robotic control systems, and are ideally suited for applications in high-speed manufacturing machines of all types. FH vision systems featuring a new and exceptionally efficient vision algorithm, high-speed image bus, four-core processing and fast EtherCAT communications. A further benefit is that FH Vision Systems are fully compatible with the Sysmac Studio Automation software.

- Four-core image processing
- Fast EtherCAT communications
- Innovative Shape Search III
- Up to 8 high resolution cameras
- Supports Microsoft® .NET
- Compatible with Sysmac Studio Automation software

System configuration

EtherCAT connections for FH series

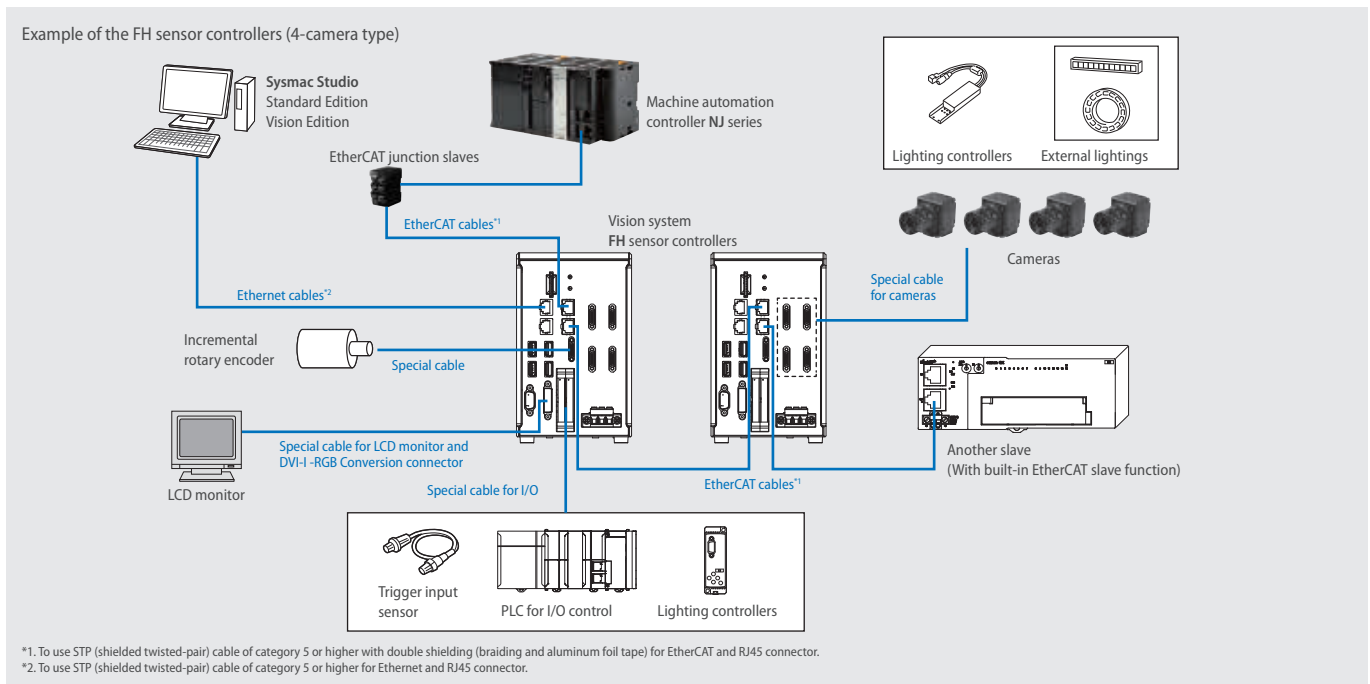

EtherNet/IP, No-protocol Ethernet and PLC Link connections for FZ5 series

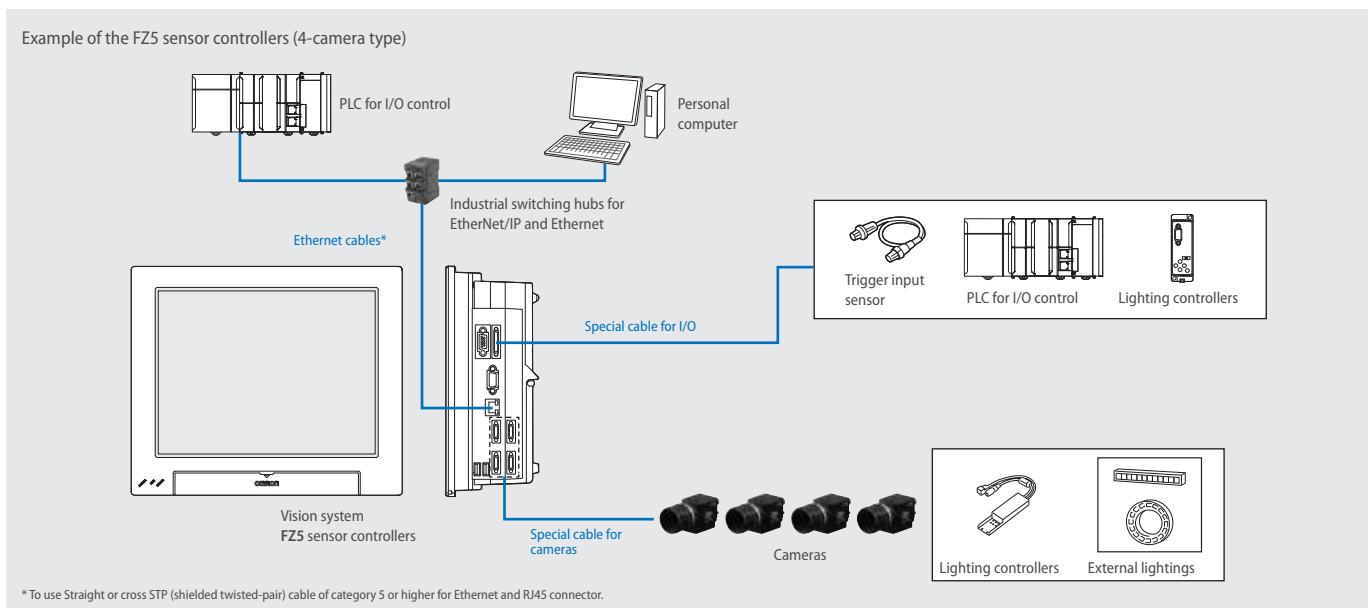



Ordering information







FH series sensor controllers

Item	CPU	No. of cameras	Output	Order code	
	Box-type controllers	High-speed controllers (4 core)	2	NPN/PNP	FH-3050
			4	NPN/PNP	FH-3050-10
			8	NPN/PNP	FH-3050-20
		Standard controllers (2 core)	2	NPN/PNP	FH-1050
			4	NPN/PNP	FH-1050-10
			8	NPN/PNP	FH-1050-20

FZ5 series sensor controllers

Item	CPU	No. of cameras	Output	Order code	
	Controllers integrated with LCD	High-speed controllers	NPN	FZ5-1100	
			PNP	FZ5-1105	
			4	NPN	FZ5-1100-10
		Standard controllers	PNP	FZ5-1105-10	
			2	NPN	FZ5-600
			PNP	FZ5-605	
	Box-type controllers	Lite controllers	NPN	FZ5-L350	
			PNP	FZ5-L355	
			4	NPN	FZ5-L350-10
			PNP	FZ5-L355-10	









Cameras

Item	Descriptions	Color/Monochrome	Image read time	Order code	
	High-speed CMOS Cameras (Lens required) For FH Sensor Controllers only	12 million pixels (Up to four cameras can be connected to one Controller. Up to eight cameras other than 12 million-pixel cameras can be connected to a FH-3050-20 or a FH-1050-20.)	Color	25.7 ms ^{*1}	FH-SC12
		Monochrome	FH-SM12		
	High-speed CMOS Cameras (Lens required) For FH Sensor Controllers only	4 million pixels	Color	8.5 ms ^{*1}	FH-SC04
			Monochrome		FH-SM04
		2 million pixels	Color	4.6 ms ^{*1}	FH-SC02
			Monochrome		FH-SM02
		300,000 pixels	Color	3.3 ms	FH-SC
			Monochrome		FH-SM
	Digital CCD Cameras (Lens required)	5 million pixels (When connecting FZ5-6□ or FZ5-L35□, up to two cameras can be connected.)	Color	62.5 ms	FZ-SC5M2
			Monochrome		FZ-S5M2
		2 million pixels	Color	33.3 ms	FZ-SC2M
			Monochrome		FZ-S2M
		300,000 pixels	Color	12.5 ms	FZ-SC
			Monochrome		FZ-S
	High-speed CCD Cameras (Lens required)	300,000 pixels	Color	4.9 ms	FZ-SHC
			Monochrome		FZ-SH
	Small Digital CCD Cameras (Lenses for small camera required)	300,000-pixel flat type	Color	12.5 ms	FZ-SFC
			Monochrome		FZ-SF
		300,000-pixel pen type	Color	12.5 ms	FZ-SPC
			Monochrome		FZ-SP
	Intelligent Compact CMOS Cameras (Camera + Manual Focus Lens + High power Lighting)	Narrow view	Color	16.7 ms	FZ-SQ010F
		Standard view			FZ-SQ050F
		Wide View (long-distance)			FZ-SQ100F
		Wide View (short-distance)			FZ-SQ100N









*1 When connected using two camera cables.

Lenses

C-mount Lens for 1/3-inch image sensor (Recommend: FZ-S□/FZ-SH□/FH-S□)

Model	3Z4S-LE SV-0614V	3Z4S-LE SV-0813V	3Z4S-LE SV-1214V	3Z4S-LE SV-1614V	3Z4S-LE SV-2514V	3Z4S-LE SV-3518V	3Z4S-LE SV-5018V	3Z4S-LE SV-7527V	3Z4S-LE SV-10035V
Appearance/Dimensions (mm)									
Focal length	6 mm	8 mm	12 mm	16 mm	25 mm	35 mm	50 mm	75 mm	100 mm
Brightness	F1.4	F1.3	F1.4	F1.4	F1.4	F1.8	F1.8	F2.7	F3.5
Filter size	M27.0 P0.5	M25.5 P0.5	M27.0 P0.5	M27.0 P0.5	M27.0 P0.5	M27.0 P0.5	M30.5 P0.5	M30.5 P0.5	M30.5 P0.5
Maximum sensor size	1/3 inch	1/3 inch	1/3 inch	1/3 inch	1/3 inch	1/3 inch	1/3 inch	1/3 inch	1/3 inch
Mount	C-mount								







C-mount Lens for 2/3-inch image sensor (Recommend: FZ-S□2M/FZ-S□5M2/FH-S□02)
(3Z4S-LE SV-7525H and 3Z4S-LE SV-10028H can also be used for FH-S□04)

Model	3Z4S-LE SV-0614H	3Z4S-LE SV-0814H	3Z4S-LE SV-1214H	3Z4S-LE SV-1614H	3Z4S-LE SV-2514H	3Z4S-LE SV-3514H	3Z4S-LE SV-5014H	3Z4S-LE SV-7525H	3Z4S-LE SV-10028H
Appearance/Dimensions (mm)									
Focal length	6 mm	8 mm	12 mm	16 mm	25 mm	35 mm	50 mm	75 mm	100 mm
Brightness	F1.4	F1.4	F1.4	F1.4	F1.4	F1.4	F1.4	F2.5	F2.8
Filter size	M40.5 P0.5	M35.5 P0.5	M27.0 P0.5	M27.0 P0.5	M27.0 P0.5	M35.5 P0.5	M40.5 P0.5	M34.0 P0.5	M37.5 P0.5
Maximum sensor size	2/3 inch	2/3 inch	2/3 inch	2/3 inch	2/3 inch	2/3 inch	2/3 inch	1 inch	1 inch
Mount	C-mount								







C-mount Lens for 1-inch image sensor (Recommend: FH-S□02/FH-S□04)
(3Z4S-LE SV-7525H with focal length of 75 mm and 3Z4S-LE SV-10028H with focal length of 100 mm are also available.)

Model	3Z4S-LE VS-0618H1	3Z4S-LE VS-0814H1	3Z4S-LE VS-1214H1	3Z4S-LE VS-1614H1N	3Z4S-LE VS-2514H1	3Z4S-LE VS-3514H1	3Z4S-LE VS-5018H1
Appearance/Dimensions (mm)							
Focal length	6 mm	8 mm	12 mm	16 mm	25 mm	35 mm	50 mm
Aperture (F No.)	1.8 to 16	1.4 to 16	1.4 to 16	1.4 to 16	1.4 to 16	1.4 to 16	1.8 to 16
Filter size	Can not be used a filter	M55.0 P0.75	M35.5 P0.5	M30.5 P0.5	M30.5 P0.5	M30.5 P0.5	M40.5 P0.5
Maximum sensor size	1 inch	1 inch	1 inch	1 inch	1 inch	1 inch	1 inch
Mount	C mount						

M42-mount Lens for large image sensor (Recommend: FH-S□12)















Model	3Z4S-LE VS-L1828/M42-10	3Z4S-LE VS-L2526/M42-10	3Z4S-LE VS-L3528/M42-10	3Z4S-LE VS-L5028/M42-10	3Z4S-LE VS-L8540/M42-10	3Z4S-LE VS-L10028/M42-10
Appearance/Dimensions (mm)						
Focal length	18 mm	25 mm	35 mm	50 mm	85 mm	100 mm
Aperture (F No.)	2.8 to 16	2.6 to 16	2.8 to 16	2.8 to 16	4.0 to 16	2.8 to 16
Filter size	M55.0 P0.75	M55.0 P0.75	M62.0 P0.75	M62.0 P0.75	M52.0 P0.75	M52.0 P0.75
Maximum sensor size	1.8 inch					
Mount	M42 mount					

Camera Accessories

Item	Descriptions		Order code	
-	External Lighting		FLV Series ^{*1}	
			FL Series ^{*1}	
	Lighting Controller (Required to control external lighting from a Controller)	For FLV-Series	Camera Mount Lighting Controller (One channel)	FLV-TCC1 ^{*1}
			Camera Mount Lighting Controller (Four channels)	FLV-TCC4 ^{*1}
			Analog Lighting Controller	FLV-ATC Series ^{*1}
		For FL-Series	Camera Mount Lighting Controller	FL-TCC1 ^{*1}
	For Intelligent Compact Camera		Mounting Bracket	FQ-XL
			Mounting Brackets	FQ-XL2
			Polarizing Filter Attachment	FQ-XF1
-	Mounting Bracket for FZ-S□		FZ-S-XLC	
	Mounting Bracket for FZ-S□2M		FZ-S2M-XLC	
	Mounting Bracket for FZ-SH□		FZ-SH-XLC	
	Mounting Bracket for FH-S□, FZ-S□5M2		FH-SM-XLC	
	Mounting Bracket for FH-S□12		FH-SM12-XLC	

^{*1} Refer to the Vision Accessory Catalog (Cat. No. Q198) for details.

Cables

Item	Descriptions	Order code
	Camera Cable Cable length: 2 m, 3 m, 5m, or 10 m ^{*1}	FZ-VS3
	Bend resistant Camera Cable Cable length: 2 m, 3 m, 5m, or 10 m ^{*1}	FZ-VSB3
	Right-angle Camera Cable ^{*2} Cable length: 2 m, 3 m, 5m, or 10 m ^{*1}	FZ-VSL3
	Bend resistant Right-angle Camera Cable ^{*2} Cable length: 2 m, 3 m, 5 m, or 10 m ^{*1}	FZ-VSLB3
	Long-distance Camera Cable Cable length: 15 m ^{*1}	FZ-VS4
	Long-distance Right-angle Camera Cable ^{*2} Cable length: 15 m ^{*1}	FZ-VSL4
	Cable Extension Unit Up to two Extension Units and three Cables can be connected. (Maximum cable length: 45 m ^{*1})	FZ-VSJ
	Monitor Cable Cable length: 2 m or 5 m (When you connect a LCD Monitor FZ-M08 to FH sensor controller, please use it in combination with a DVI-I -RGB Conversion Connector FH-VMRGB.)	FZ-VM
	DVI-I -RGB Conversion Connector For FH Sensor Controllers only	FH-VMRGB
	Parallel I/O Cable Cable length: 2 m or 5 m, For FZ Sensor Controllers only	FZ-VP
	Parallel I/O Cable for Connector-terminal Conversion Unit Cable length: 2 m or 5 m, For FZ Sensor Controllers only Connector-Terminal Block Conversion Units can be connected (Terminal Blocks Recommended Products: OMRON XW2R-J50G-T, XW2R-E50G-T, XW2R-P50G-T)	FZ-VPX
	Parallel I/O Cable ^{*3} Cable length: 2 m or 5 m, For FH Sensor Controllers only	XW2Z-S013-□ ^{*4}
	Parallel I/O Cable for Connector-terminal Conversion Unit ^{*3} Cable length: 0.5 m, 1 m, 1.5 m, 2 m, 3 m, 5 m, For FH Sensor Controllers only Connector-Terminal Block Conversion Units can be connected (Terminal Blocks Recommended Products: OMRON XW2R-□34G-T)	XW2Z-□□□EE ^{*5}
	Connector-Terminal Block Conversion Units, General-purpose devices	XW2R-□34G-T ^{*6}
	Encoder Cable for line-driver Cable length: 1.5 m, For FH Sensor Controllers only	FH-VR

^{*1} The maximum cable length depends on the Camera being connected, and the model and length of the Cable being used. For further information, please refer to the "Cameras/Cables" table. When a high-speed CMOS camera FH-S□02/-S□04/-S□12 is used in the high speed mode of transmission speed, two camera cables are required.

^{*2} This Cable has an L-shaped connector on the Camera end.

^{*3} 2 Cables are required for all I/O signals.

^{*4} Insert the cables length into □ in the model number as follows. 2 m = 2, 5 m = 5

^{*5} Insert the cables length into □□□ in the model number as follows. 0.5 m = 050, 1 m = 100, 1.5 m = 150, 2 m = 200, 3 m = 300, 5 m = 500





^{*6} Insert the wiring method into □ in the model number as follows. Phillips screw = J, Slotted screw (rise up) = E, Push-in spring = P

Refer to the XW2R Series catalog (Cat. No. G077) for details.

Recommended EtherCAT and EtherNet/IP communications cables

Use Straight STP (shielded twisted-pair) cable of category 5 or higher with double shielding (braiding and aluminum foil tape) for EtherCAT.

Use Straight or cross STP (shielded twisted-pair) cable of category 5 or higher for EtherNet/IP.

Item	Descriptions		Order code		
	For EtherCAT ^{*1}	Standard type cable with connectors on both ends (RJ45/RJ45) Wire gauge and number of pairs: AWG27, 4-pair cable, cable sheath material: LSZH ^{*2} , Cable color: Blue, Yellow, or Green, Cables length: 0.2 m, 0.3 m, 0.5 m, 1 m, 1.5 m, 2 m, 3 m, 5 m, 7.5 m, 10 m, 15 m, 20 m	XS6W-6LSZH8SS□CM-Y ^{*3}		
		Rugged type cable with connectors on both ends (RJ45/RJ45) Wire gauge and number of pairs: AWG22, 2-pair cable Cables length: 0.3 m, 0.5 m, 1 m, 2 m, 3 m, 5 m, 10 m, 15 m	XS5W-T421-□MD-K ^{*3}		
		Rugged type cable with connectors on both ends (M12/RJ45) Wire gauge and number of Pairs: AWG22, 2-pair cable Cables length: 0.3 m, 0.5 m, 1 m, 2 m, 3 m, 5 m, 10 m, 15 m	XS5W-T421-□MC-K ^{*3}		
		Rugged type cable with connectors on both ends (M12 L/RJ45) Wire gauge and number of pairs: AWG22, 2-pair cable Cables length: 0.3 m, 0.5 m, 1 m, 2 m, 3 m, 5 m, 10 m, 15 m	XS5W-T422-□MC-K ^{*3}		
-	For EtherCAT ^{*1} and EtherNet/IP	Wire gauge and number of pairs: AWG24, 4-pair cable	Cables	Hitachi Cable, Ltd.	NETSTAR-C5E SAB 0.5 × 4P ^{*4}
-				Kuramo Electric Co.	KETH-SB ^{*4}
-				SWCC Showa Cable Systems Co.	FAE-5004 ^{*4}
-			RJ45 connectors	Panduit Corporation	MPS588-C ^{*4}
-		Wire gauge and number of pairs: AWG22, 2-pair cable	Cables	Kuramo Electric Co.	KETH-PSB-OMR ^{*5}
-				Nihon Electric Wire&Cable Co.,Ltd.	PNET/B ^{*5}
			RJ45 assembly connector	OMRON	XS6G-T421-1 ^{*5}
-	For EtherNet/IP	Wire gauge and number of pairs: 0.5 mm, 4-pair cable	Cables	Fujikura Ltd.	F-LINK-E 0.5mm × 4P ^{*6}
-				RJ45 connectors	Panduit Corporation

^{*1} The FH series supports the EtherCAT communication. It cannot be used in FZ series.

^{*2} The lineup features Low Smoke Zero Halogen cables for in-cabinet use and PUR cables for out-of-cabinet use.

^{*3} For details, refer to Cat.No.G019.









^{*4} We recommend you to use above cable for EtherCAT and EtherNet/IP, and RJ45 connector together.

^{*5} We recommend you to use above cable for EtherCAT and EtherNet/IP, and RJ45 assembly connector together.

^{*6} We recommend you to use above cable For EtherNet/IP and RJ45 connectors together.

Note: Please be careful while cable processing, for EtherCAT, connectors on both ends should be shield connected and for EtherNet/IP, connectors on only one end should be shield connected.

Peripheral devices

Item	Descriptions				Order code
	LCD monitor For Box-type controllers				FZ-M08
	USB memory		2 GB		FZ-MEM2G
			8 GB		FZ-MEM8G
	SD card For FH Controller only		2 GB		HMC-SD291
			4 GB		HMC-SD491
	VESA attachment For installing the LCD integrated-type controller				FZ-VESA
	Desktop controller stand For installing the LCD integrated-type controller				FZ-DS
	Display/USB switcher				FZ-DU
—	Mouse recommended products Driverless wired mouse (A mouse that requires the mouse driver to be installed is not supported.)				—
	EtherCAT junction slaves For FH series	3 port	Power supply voltage: 20.4 to 28.8 VDC (24 VDC -15 to 20%)	Current consumption: 0.08 A	GX-JC03
		6 port			Current consumption: 0.17 A
	Industrial Switching Hubs for EtherNet/IP and Ethernet	3 port	Failure detection: None	Current consumption: 0.22 A	W4S1-03B
		5 port	Failure detection: None		W4S1-05B
		5 port	Failure detection: Supported		W4S1-05C

Automation software Sysmac Studio

Please purchase a DVD and licenses the first time you purchase the Sysmac Studio. DVDs and licenses are available individually. The license does not include the DVD.

Product	Specifications			Order code
		Number of model standards licenses	Media	
Sysmac Studio Standard Edition Ver.1.□□□	The Sysmac Studio provides an integrated development environment to set up, program, debug, and maintain NJ-series controllers and other Machine Automation controllers, as well as EtherCAT slaves. Sysmac Studio runs on the following OS. Windows XP (Service Pack 3 or higher, 32-bit version)/Vista (32-bit version)/7 (32-bit/64-bit version)	— (Media only)	DVD *1	SYSMAC-SE200D
		1 license	—	SYSMAC-SE201L
		3 license	—	SYSMAC-SE203L
		10 license	—	SYSMAC-SE210L
		30 license	—	SYSMAC-SE230L
		50 license	—	SYSMAC-SE250L
Sysmac Studio Vision Edition Ver.1.□□□*2	Sysmac Studio Vision Edition is a limited license that provides selected functions required for FH-series/ FQ-M-series vision sensor settings.	1 license	—	SYSMAC-VE001L

*1 The same media is used for both the Standard Edition and the Vision Edition.

*2 With the Vision Edition, you can use only the setup functions for FH-series/FQ-M-series vision sensors.

- Note:** 1. Site licenses are available for users who will run Sysmac Studio on multiple computers. Ask your OMRON sales representative for details.
2. Sysmac Studio version 1.07 or higher supports the FH series. Sysmac Studio does not support the FZ5 series.

Development Environment

Please purchase a DVD and licenses the first time you purchase the Sysmac Studio. DVDs and licenses are available individually. The license does not include the DVD.

Product	Specifications			Order code
		Number of model standards licenses	Media	
Application Producer	Software components that provide a development environment to further customize the standard controller features of the FH series. System requirements: • CPU: Intel Pentium Processor (SSE2 or higher) • OS: Windows 7 Professional (32bit) or Enterprise (32bit) or Ultimate (32bit) • .NET Framework: .NET Framework 3.5 or higher • Memory: At least 2 GB RAM Available disk space: At least 2 GB • Browser: Microsoft® Internet Explorer 6.0 or later • Display: XGA (1,024 × 768), True Color (32-bit) or higher • Optical drive: CD/DVD drive The following software is required to customize the software: Microsoft® Visual Studio® 2010 Professional or Microsoft® Visual Studio® 2008 Professional	— (Media only)	CD	FH-AP1
		1 license	—	FH-AP1L

Specifications

FH sensor controllers

Type		High-speed Controllers (4 core)			Standard Controllers (2 core)		
Model	NPN	FH-3050	FH-3050-10	FH-3050-20	FH-1050	FH-1050-10	FH-1050-20
	PNP						
Controller type		Box-type controllers					
No. of Cameras		2	4	8	2	4	8
Connected Camera		Can be connected to all cameras. (FZ-S series/FH-S series)		Can be connected to all cameras. (FZ-S series/FH-S series) (Can be connected to up to four 12 million-pixel cameras or up to eight cameras other than 12 million-pixel cameras.)	Can be connected to all cameras. (FZ-S series/FH-S series)		Can be connected to all cameras. (FZ-S series/FH-S series) (Can be connected to up to four 12 million-pixel cameras or up to eight cameras other than 12 million-pixel cameras.)
Processing resolution (FZ-S)	When connected to an intelligent compact camera	752 (H) × 480 (V)					
	When connected to a 300,000-pixel camera	640 (H) × 480 (V)					
	When connected to a 2 million-pixel camera	1,600 (H) × 1,200 (V)					
	When connected to a 5 million-pixel camera	2,448 (H) × 2,044 (V)					
Processing resolution (FH-S)	When connected to a 300,000-pixel camera	640 (H) × 480 (V)					
	When connected to a 2 million-pixel camera	2,040 (H) × 1,088 (V)					
	When connected to a 4 million-pixel camera	2,040 (H) × 2,048 (V)					
	When connected to a 12 million-pixel camera	4,084 (H) × 3,072 (V)					
No. of scenes		128					
Main functions	Number of logged images ¹	When connected to an intelligent compact camera Connected to 1 camera(Color): 232, Connected to 2 camera(Color): 116 Connected to 3 camera(Color): 77, Connected to 4 camera(Color): 58 Connected to 5 camera(Color): 46, Connected to 6 camera(Color): 38 Connected to 7 camera(Color): 33, Connected to 8 camera(Color): 29					
		When connected to a 300,000-pixel camera (FZ-S/FH-S) Connected to 1 camera(Color): 270, Connected to 1 camera(Monochrome): 272 Connected to 2 camera(Color): 135, Connected to 2 camera(Monochrome): 136 Connected to 3 camera(Color/Monochrome): 90 Connected to 4 camera(Color): 67, Connected to 4 camera(Monochrome): 68 Connected to 5 camera(Color/Monochrome): 54 Connected to 6 camera(Color/Monochrome): 45 Connected to 7 camera(Color/Monochrome): 38 Connected to 8 camera(Color): 33, Connected to 8 camera(Monochrome): 34					
		When connected to a 2 million-pixel camera (FH-S) Connected to 1 camera(Color/Monochrome): 37, Connected to 2 camera(Color/Monochrome): 18 Connected to 3 camera(Color/Monochrome): 12, Connected to 4 camera(Color/Monochrome): 9 Connected to 5 camera(Color/Monochrome): 7, Connected to 6 camera(Color/Monochrome): 6 Connected to 7 camera(Color/Monochrome): 5, Connected to 8 camera(Color/Monochrome): 4					
		When connected to a 2 million-pixel camera (FZ-S) Connected to 1 camera(Color/Monochrome): 43, Connected to 2 camera(Color/Monochrome): 21 Connected to 3 camera(Color/Monochrome): 14, Connected to 4 camera(Color/Monochrome): 10 Connected to 5 camera(Color/Monochrome): 8, Connected to 6 camera(Color/Monochrome): 7 Connected to 7 camera(Color/Monochrome): 6, Connected to 8 camera(Color/Monochrome): 5					
		When connected to a 4 million-pixel camera (FH-S) Connected to 1 camera(Color/Monochrome): 20, Connected to 2 camera(Color/Monochrome): 10 Connected to 3 camera(Color/Monochrome): 6, Connected to 4 camera(Color/Monochrome): 5 Connected to 5 camera(Color/Monochrome): 4, Connected to 6 camera(Color/Monochrome): 3 Connected to 7 camera(Color/Monochrome): 2, Connected to 8 camera(Color/Monochrome): 2					
		When connected to a 5 million-pixel camera (FZ-S) Connected to 1 camera(Color/Monochrome): 16, Connected to 2 camera(Color/Monochrome): 8 Connected to 3 camera(Color/Monochrome): 5, Connected to 4 camera(Color/Monochrome): 4 Connected to 5 camera(Color/Monochrome): 3, Connected to 6 camera(Color/Monochrome): 2 Connected to 7 camera(Color/Monochrome): 2, Connected to 8 camera(Color/Monochrome): 2					
		When connected to a 12 million-pixel camera (FH-S) Connected to 1 camera(Color/Monochrome): 6, Connected to 2 camera(Color/Monochrome): 3 Connected to 3 camera(Color/Monochrome): 2, Connected to 4 camera(Color/Monochrome): 2					
	Operation		Mouse or similar device				
Settings		Create series of processing steps by editing the flowchart (Help messages provided).					
Serial communications		RS-232C: 1 CH					
EtherNet communications		No-protocol (TCP/UDP) 100BASE-T					
		1 port	2 port	2 port	1 port	2port	2port
EtherNet/IP communications		Ethernet port baud rate: 1 Gbps (1000 BASE-T)					
EtherCAT communications		EtherCAT protocol (100BASE-TX)					
Parallel I/O		(In the 2-line random trigger mode) 17 inputs (STEP0/ENCTRIG_Z0, STEP1/ENCTRIG_Z1, ENCTRIG_A0 to 1, ENCTRIG_B0 to 1, DSA0 to 1, DIO to 7, DL_LINE0) 37 outputs (RUN0 to 1, READY0 to 1, BUSY0 to 1, OR0 to 1, ERROR0 to 1, GATE0 to 1, STGOUT0/SHTOUT0, STGOUT1/SHTOUT1, STGOUT2 to 7, DO0 to 15, ACK) (In the 5-line to 8-line random trigger mode) 19 inputs, STEP0 to 7, DL_LINE0 to 2, DIO to 7) 34 outputs (READY0 to 7, BUSY0 to 7, OR0 to 7, ACK, ERROR, STGOUT/SHTOUT0 to 7)					
Encoder interface		RS422-A line driver level. Phase A/B: single-phase 4MHz (multiplying phase difference of 1MHz by 4 times), Phase Z: 1MHz					
Monitor interface		DVI-I (Single Link) output IF × 1ch					
USB interface		4 channels (supports USB 1.1 and 2.0)					
SD card interface		SDHC card of Class4 or higher rating is recommended.					
External interface							

Type			High-speed Controllers (4 core)			Standard Controllers (2 core)			
Model		NPN	FH-3050	FH-3050-10	FH-3050-20	FH-1050	FH-1050-10	FH-1050-20	
		PNP							
Ratings	Power supply voltage		20.4 to 26.4 VDC						
	Current consumption (at 24.0 VDC) *2	When connected to a intelligent compact camera	Connected to 2 cameras	5.0 A max.	5.4 A max.	6.4 A max.	4.7 A max.	5.0 A max.	5.9 A max.
			Connected to 4 cameras	–	7.0 A max.	8.1 A max.	–	6.5 A max.	7.5 A max.
			Connected to 8 cameras	–	–	11.5 A max.	–	–	10.9 A max.
		When connected to a 300,000-pixel camera, 2 million-pixel camera, 4 million-pixel camera, 5 million-pixel camera or 12 million-pixel camera	Connected to 2 cameras	4.1 A max.	4.2 A max.	5.2 A max.	3.6 A max.	3.7 A max.	4.5 A max.
			Connected to 4 cameras	–	4.8 A max.	5.6 A max.	–	4.3 A max.	5.0 A max.
Connected to 8 cameras			–	–	6.8 A max.	–	–	6.2 A max.	
Insulation resistance			Between DC power supply and controller FG: 20 MΩ or higher (rated voltage 250 V)						
Operation Environment	Noise Immunity	Fast transient burst	DC Power Supply	Direct infusion: 2 kV Pulse rising: 5 ns Pulse width: 50 ns Burst continuation time: 15 ms/0.75 ms Period: 300 ms Application time: 1 min					
			I/O line	Cramp: 1 kV Pulse rising: 5 ns Pulse width: 50 ns Burst continuation time: 15 ms/0.75 ms Period: 300 ms Application time: 1 min					
	Ambient temperature range			Operating: 0 to 50 °C Storage: –20 to 65 °C (with no icing or condensation)					
	Ambient humidity range			Operating and storage: 35% to 85% (with no condensation)					
	Ambient atmosphere			No corrosive gases					
	Grounding			Type D grounding (100Ω or less grounding resistance) Conventional type 3 grounding					
Degree of protection			IEC60529 IP20						
Dimensions	Dimensions			190 × 115 × 182.5 mm					
	Weight			Approx. 3.2 kg	Approx. 3.4 kg	Approx. 3.4 kg	Approx. 3.2 kg	Approx. 3.4 kg	Approx. 3.4 kg
	Case materials			Cover: zinc-plated steel plate, side plate: aluminum (A6063)					
Accessories			Controller (1)/user manual (one Japanese and one English versions)/Instruction Installation Manual (1)/Power supply terminal block connector (1)/Ferrite core (2, FH-3050 and FH-1050), 4 (FH-3050-10 and FH-1050-10), and 8 (FH-3050-20 and FH-1050-20)						

*1 The image logging capacity changes when multiple cameras of different types are connected at the same time.

*2 The current consumption when the maximum number of cameras supported by each controller are connected. If a lighting controller model is connected to a lamp, the current consumption is as high as when an intelligent compact camera is connected.

FZ5 sensor controllers

Type		High-speed controllers		Standard controllers		Lite controllers		
Model	NPN	FZ5-1100	FZ5-1100-10	FZ5-600	FZ5-600-10	FZ5-L350	FZ5-L350-10	
	PNP	FZ5-1105	FZ5-1105-10	FZ5-605	FZ5-605-10	FZ5-L355	FZ5-L355-10	
Controller type		Controllers integrated with LCD					Box-type controllers	
High-grade processing items		No						
No. of cameras		2	4	2	4	2	4	
Connected camera		Can be connected to FZ-S series. (Can not be connected to FH-S series.)		Can be connected to FZ-S series. (Can not be connected to FH-S series. When connecting 5 million-pixel cameras, up to two cameras can be connected.)				
Processing resolution	When connected to a intelligent compact camera	752 (H) × 480 (V)						
	When connected to a 300,000-pixel camera	640 (H) × 480 (V)						
	When connected to a 2 million-pixel camera	1,600 (H) × 1,200 (V)						
	When connected to a 5 million-pixel camera	2,448 (H) × 2,044 (V)						
No. of scenes		32						
Number of logged images*1	When connected to a intelligent compact camera	Connected to 1 camera	232		214			
		Connected to 2 cameras	116		107			
		Connected to 3 cameras	77		71			
		Connected to 4 cameras	58		53			
	When connected to a 300,000-pixel camera	Connected to 1 camera	Color camera: 270, Monochrome Camera: 272		Color camera: 250, Monochrome Camera: 252			
		Connected to 2 cameras	Color camera: 135, Monochrome Camera: 136		Color camera: 125, Monochrome Camera: 126			
		Connected to 3 cameras	Color camera: 90, Monochrome Camera: 90		Color camera: 83, Monochrome Camera: 84			
		Connected to 4 cameras	Color camera: 67, Monochrome Camera: 68		Color camera: 62, Monochrome Camera: 63			
	When connected to a 2 million-pixel camera	Connected to 1 camera	Color camera: 43, Monochrome Camera: 43		Color camera: 40, Monochrome Camera: 40			
		Connected to 2 cameras	Color camera: 21, Monochrome Camera: 21		Color camera: 20, Monochrome Camera: 20			
		Connected to 3 cameras	Color camera: 14, Monochrome Camera: 14		Color camera: 13, Monochrome Camera: 13			
		Connected to 4 cameras	Color camera: 10, Monochrome Camera: 10		Color camera: 10, Monochrome Camera: 10			
	When connected to a 5 million-pixel camera	Connected to 1 camera	Color camera: 16, Monochrome Camera: 16		Color camera: 11, Monochrome Camera: 11			
		Connected to 2 cameras	Color camera: 8, Monochrome Camera: 8		Color camera: 5, Monochrome Camera: 5			
		Connected to 3 cameras	Color camera: 5, Monochrome Camera: 5		-			
		Connected to 4 cameras	Color camera: 4, Monochrome Camera: 4		-			
	Operation		Touch pen, mouse, etc.					Mouse or similar device
	Settings		Create series of processing steps by editing the flowchart (Help messages provided).					
	Serial communications		RS-232C/422A: 1 CH					RS-232: 1CH
	EtherNet communications		Ethernet 100BASE-TX/10BASE-T					Ethernet 1000BASE-T/100BASE-TX/10BASE-T
EtherNet/IP communications		Ethernet port baud rate: 100 Mbps (100Base-TX)						
Parallel I/O		(When used in Multi-line random-trigger mode) 17 inputs (RESET, STEP0/ENCTRIG_Z0, STEP1/ENCTRIG_Z1, DSA0 to 1, ENCTRIG_A0 to 1, ENCTRIG_B0 to 1, DIO to 7), 29 outputs (RUN/BUSY1, BUSY0, GATE0 to 1, ORO to 1, READY0 to 1, ERROR, STGOUT0 to 3, DO0 to 15) (When used in other mode) 13 inputs (RESET, STEP0/ENCTRIG_Z0, DSA0, ENCTRIG_A0, ENCTRIG_B0, DIO to 7), 26 outputs (RUN, BUSY0, GATE0, ORO, READY0, ERROR, STGOUT0 to 3, DO0 to 15) STGOUT 2 to 3 only for camera 4 ch type		13 inputs (RESET, STEP0/ENCTRIG_Z0, DSA0, ENCTRIG_A0, ENCTRIG_B0, DIO to 7), 26 outputs (RUN, BUSY0, GATE0, ORO, READY0, ERROR, STGOUT0 to 3, DO0 to 15) STGOUT 2 to 3 only for camera 4 ch type		11 inputs (RESET, STEP, DSA, and DIO to 7), 26 outputs (RUN, BUSY, GATE, OR, READY, ERROR, STGOUT 0 to 3, and DO 0 to 15) STGOUT 2 to 3 only for camera 4 ch type		
Monitor interface		Integrated controller and LCD 12.1 inch TFT color LCD (Resolution: XGA 1,024 × 768 dots)					Analog RGB video output, 1 channel (Resolution: XGA 1,024 × 768 dots)	
USB interface		4 channels (supports USB 1.1 and 2.0)					2CH (supports USB1.1/2.0)	
Power supply voltage*2		20.4 to 26.4 VDC						
Current consumption (at 24.0 VDC)*3	When connected to a intelligent compact camera	5.0 A max.	7.5 A max.	5.0 A max.	7.5 A max.	4.0 A max.	5.5 A max.	
	When connected to a intelligent or autofocus camera							
	When connected to a 300,000-pixel camera	3.7 A max.	4.9 A max.	3.7 A max.	4.9 A max.	2.6 A max.	2.9 A max.	
	When connected to a 2 million-pixel camera							
	When connected to a 5 million-pixel camera							

Type	High-speed controllers				Standard controllers		Lite controllers	
Model	NPN	FZ5-1100	FZ5-1100-10	FZ5-600	FZ5-600-10	FZ5-L350	FZ5-L350-10	
	PNP	FZ5-1105	FZ5-1105-10	FZ5-605	FZ5-605-10	FZ5-L355	FZ5-L355-10	
Ambient temperature range	Operating: 0 to 45°C for low cooling fan speeds, 0 to 50°C for high cooling fan speeds Storage: -20 to 65°C (with no icing or condensation)					Operating: 0 to 45°C, 0 to 50°C Storage: -20 to 65°C (with no icing or condensation)		
Ambient humidity range	Operating and storage: 35% to 85% (with no condensation)							
Weight	Approx. 3.2 kg		Approx. 3.4 kg		Approx. 3.2 kg		Approx. 3.4 kg	
Accessories	Touch pen (one, inside the front panel), instruction manual, 6 mounting brackets					Instruction manual		

- *1 The image logging capacity changes when multiple cameras of different types are connected at the same time.
- *2 Do not ground the positive terminal of the 24-VDC power supply to a Lite controller.
If the positive terminal is grounded, electrical shock may occur when an SG (0-V) part, such as the case of the controller or camera, is touched.
- *3 The current consumption when the maximum number of cameras supported by each controller are connected.
If a strobe controller model is connected to a lamp, the current consumption is as high as when an intelligent camera is connected.

Cameras

High-speed CMOS cameras

Model	FH-SM		FH-SC		FH-SM02		FH-SC02		FH-SM04		FH-SC04		FH-SM12		FH-SC12	
Image elements	CMOS image elements (1/3-inch equivalent)				CMOS image elements (2/3-inch equivalent)				CMOS image elements (1-inch equivalent)				CMOS image elements (1.76-inch equivalent)			
Color/Monochrome	Monochrome		Color		Monochrome		Color		Monochrome		Color		Monochrome		Color	
Effective pixels	640 (H) × 480 (V)				2,040 (H) × 1,088 (V)				2,040 (H) × 2,048 (V)				4,084 (H) × 3,072 (V)			
Imaging area H × V (opposing corner)	4.8 × 3.6 (6.0 mm)				11.26 × 5.98 (12.76 mm)				11.26 × 11.26 (15.93 mm)				22.5 × 16.9 (28.14 mm)			
Pixel size	7.4 (μm) × 7.4 (μm)				5.5 (μm) × 5.5 (μm)				5.5 (μm) × 5.5 (μm)				5.5 (μm) × 5.5 (μm)			
Shutter function	Electronic shutter; Shutter speeds can be set from 20 μs to 100 ms.				Electronic shutter; Shutter speeds can be set from 25 μs to 100 ms.				Electronic shutter; Shutter speeds can be set from 60 μs to 100 ms.				Electronic shutter; Shutter speeds can be set from 60 μs to 100 ms.			
Partial function	1 to 480 lines		2 to 480 lines		1 to 1,088 lines		2 to 1,088 lines		1 to 2,048 lines		2 to 2,048 lines		4 to 3,072 lines (4-line increments)			
Frame rate (image read time)	308 fps (3.3 ms)				219 fps (4.6 ms) ^{*1}				118 fps (8.5 ms) ^{*1}				38.9 fps (25.7 ms) ^{*1}			
Lens mounting	C mount												M42 mount			
Field of vision, installation distance	Selecting a lens according to the field of vision and installation distance															
Ambient temperature range	Operating: 0 to 40 °C, Storage: -25 to 65 °C (with no icing or condensation)															
Ambient humidity range	Operating and storage: 35% to 85% (with no condensation)															
Weight	Approx.105 g				Approx.110 g				Approx.320 g				Approx.320 g			
Accessories	Instruction manual															

*1 Frame rate in high speed mode when the camera is connected using two camera cables.

Digital CCD cameras

Model	FZ-S		FZ-SC		FZ-S2M		FZ-SC2M		FZ-S5M2		FZ-SC5M2	
Image elements	Interline transfer reading all pixels, 1/3-inch CCD image elements				Interline transfer reading all pixels, 1/1.8-inch CCD image elements				Interline transfer reading all pixels, 2/3-inch CCD image elements			
Color/Monochrome	Monochrome		Color		Monochrome		Color		Monochrome		Color	
Effective pixels	640 (H) × 480 (V)				1,600 (H) × 1,200 (V)				2,448 (H) × 2,044 (V)			
Pixel size	7.4 (μm) × 7.4 (μm)				4.4 (μm) × 4.4 (μm)				3.45 (μm) × 3.45 (μm)			
Shutter function	Electronic shutter; select shutter speeds from 20 μs to 100 ms											
Partial function	12 to 480 lines				12 to 1,200 lines				12 to 2,044 lines			
Frame rate (image read time)	80 fps (12.5 ms)				30 fps (33.3 ms)				16 fps (62.5 ms)			
Lens mounting	C-mount											
Field of vision, installation distance	Selecting a lens according to the field of vision and installation distance											
Ambient temperature range	Operating: 0 to 50°C Storage: -25 to 65°C (with no icing or condensation)				Operating: 0 to 40°C Storage: -25 to 65°C (with no icing or condensation)							
Ambient humidity range	Operating and storage: 35% to 85% (with no condensation)											
Weight	Approx. 55 g				Approx. 76 g				Approx.140 g			
Accessories	Instruction manual											

Small CCD Digital cameras

Model	FZ-SF	FZ-SFC	FZ-SP	FZ-SPC
Image elements	Interline transfer reading all pixels, 1/3-inch CCD image elements			
Color/Monochrome	Monochrome	Color	Monochrome	Color
Effective pixels	640 (H) × 480 (V)			
Pixel size	7.4 (μm) × 7.4 (μm)			
Shutter function	Electronic shutter; select shutter speeds from 20 μm to 100 ms			
Partial function	12 to 480 lines			
Frame rate (image read time)	80 fps (12.5 ms)			
Lens mounting	Special mount (M10.5 P0.5)			
Field of vision, installation distance	Selecting a lens according to the field of vision and installation distance			
Ambient temperature range	Operating: 0 to 50°C (camera amp) 0 to 45°C (camera head) Storage: -25 to 65°C (with no icing or condensation)			
Ambient humidity range	Operating and storage: 35% to 85% (with no condensation)			
Weight	Approx. 150 g			
Accessories	Instruction manual, installation bracket, Four mounting brackets (M2)		Instruction manual	

High-speed CCD cameras

Model	FZ-SH	FZ-SHC
Image elements	Interline transfer reading all pixels, 1/3-inch CCD image elements	
Color/Monochrome	Monochrome	Color
Effective pixels	640 (H) × 480 (V)	
Pixel size	7.4 (μm) × 7.4 (μm)	
Shutter function	Electronic shutter; select shutter speeds from 1/10 to 1/50,000 s	
Partial function	12 to 480 lines	
Frame rate (image read time)	204 fps (4.9ms)	
Field of vision, installation distance	Selecting a lens according to the field of vision and installation distance	
Ambient temperature range	Operating: 0 to 40°C Storage: -25 to 65°C (with no icing or condensation)	
Ambient humidity range	Operating and storage: 35% to 85% (with no condensation)	
Weight	Approx. 105 g	
Accessories	Instruction manual	

Intelligent Compact CMOS cameras

Model	FZ-SQ010F	FZ-SQ050F	FZ-SQ100F	FZ-SQ100N
Image elements	1/3-inch CMOS image elements			
Color/Monochrome	Color			
Effective pixels	752 (H) × 480 (V)			
Pixel size	6.0 (μm) × 6.0 (μm)			
Shutter function	1/250 to 1/32,258			
Partial function	8 to 752 lines			
Frame rate (image read time)	60 fps			
Field of vision	7.5 × 4.7 to 13 × 8.2 mm	13 × 8.2 to 53 × 33 mm	53 × 33 to 240 × 153 mm	29 × 18 to 300 × 191 mm
Installation distance	38 to 60 mm	56 to 215 mm	220 to 970 mm	32 to 380 mm
LED class*1	Class 2			
Ambient temperature range	Operating: 0 to 50°C Storage: -25 to 65°C			
Ambient humidity range	Operating and storage: 35% to 85% (with no condensation)			
Weight	Approx. 150 g		Approx. 140 g	
Accessories	Mounting bracket (FQ-XL), polarizing filter attachment (FQ-XF1), instruction manual and warning label			

*1 Applicable standards: IEC62471-2

LCD Monitor

Model	FZ-M08
Size	8.4 inches
Type	Liquid crystal Color TFT
Resolution	1,024 × 768 dots
Input signal	Analog RGB video input, 1 channel
Power supply voltage	21.6 to 26.4 VDC
Current consumption	Approx. 0.7 A max.
Ambient temperature range	Operating: 0 to 50°C; Storage: -25 to 65°C (with no icing or condensation)
Ambient humidity range	Operating and storage: 35% to 85% (with no condensation)
Weight	Approx. 1.2 kg
Accessories	Instruction sheet and 4 mounting brackets

Camera cables

Model	FZ-VS3 (2 m)	FZ-VSB3 (2 m)	FZ-VSL3 (2 m)	FZ-VSLB3 (2 m)
Shock resistiveness (durability)	10 to 150 Hz single amplitude 0.15 mm 3 directions, 8 strokes, 4 times			
Ambient temperature range	Operation and storage: 0 to 65 °C (with no icing or condensation)			
Ambient humidity range	Operation and storage: 40% to 70%RH (with no condensation)			
Ambient atmosphere	No corrosive gases			
Material	Cable sheath, connector: PVC			
Minimum bending radius	69 mm	69 mm	69 mm	69 mm
Weight	Approx. 170 g	Approx. 180 g	Approx. 170 g	Approx. 180 g

Monitor cable

Model	FZ-VM
Vibration resistiveness	10 to 150 Hz single amplitude 0.15 mm 3 directions, 8 strokes, 4 times
Ambient temperature range	Operation: 0 to 50°C; Storage: -20 to 65°C (with no icing or condensation)
Ambient humidity range	Operation and storage: 35% to 85%RH (with no condensation)
Ambient atmosphere	No corrosive gases
Material	Cable sheath: heat-resistant PVC, connector: PVC
Minimum bending radius	75 mm
Weight	Approx. 170 g

Cable extension unit

Model	FZ-VSJ
Power supply voltage ^{*1}	11.5 to 13.5 VDC
Current consumption ^{*2}	1.5 A max.
Ambient temperature range	Operating: 0 to 50°C; Storage: -25 to 65°C (with no icing or condensation)
Ambient humidity range	Operating and storage: 35% to 85% (with no condensation)
Maximum units connectable	2 Units per camera
Weight	Approx. 240 g
Accessories	Instruction sheet and 4 mounting screws

^{*1} A 12-VDC power supply must be provided to the cable extension unit when connecting the Intelligent camera, the Autofocus camera, the Intelligent compact camera, the Strobe controller, or the Lighting controller.

^{*2} The current consumption shows when connecting the cable extension unit to an external power supply.

Long-distance camera cables

Model	FZ-VS4 (15 m)	FZ-VSL4 (15 m)
Shock resistiveness (durability)	10 to 150 Hz single amplitude 0.15 mm 3 directions, 8 strokes, 4 times	
Ambient temperature range	Operation and storage: 0 to 65 °C (with no icing or condensation)	
Ambient humidity range	Operation and storage: 40% to 70%RH (with no condensation)	
Ambient atmosphere	No corrosive gases	
Material	Cable sheath, connector: PVC	
Minimum bending radius	78 mm	
Weight	Approx. 1,400 g	

Parallel cable

Model	FZ-VP	FZ-VPX
Vibration resistiveness	10 to 150 Hz single amplitude 0.15 mm 3 directions, 8 strokes, 4 times	
Ambient temperature range	Operation: 0 to 50°C; Storage: -20 to 65°C (with no icing or condensation)	
Ambient humidity range	Operation and storage: 35% to 85%RH (with no condensation)	
Ambient atmosphere	No corrosive gases	
Material	Cable sheath: heat-resistant PVC, Connector: resin	
Minimum bending radius	75 mm	
Weight	Approx. 160 g	Approx. 180 g

Note: FZ-VP/FZ-VPX is only for the FZ series. The FH series can use XW2Z-S013-2/-S013-5.

Encoder cable

Model	FH-VR
Vibration resistiveness	10 to 150 Hz single amplitude 0.1 mm 3 directions, 8 strokes, 10 times
Ambient temperature range	Operation: 0 to 50°C; Storage: -10 to 60°C (with no icing or condensation)
Ambient humidity range	Operation and storage: 35% to 85%RH (with no condensation)
Ambient atmosphere	No corrosive gases
Material	Cable Jacket: Heat, oil and flame resistant PVC Connector: polycarbonate resin
Minimum bending radius	65 mm
Weight	Approx. 104 g

Cameras/Cables connection table

Type of camera	Model	Cable length	High-speed CMOS cameras*1						
			300,000-pixel		2 million-pixel		4 million-pixel		12 million-pixel
			FH-SM/SC		FH-SM02/SC02		FH-SM04/SC04		FH-SM12/SC12
			-		High speed mode of transmission speed select	Standard mode of transmission speed select	High speed mode of transmission speed select	Standard mode of transmission speed select	High speed mode of transmission speed select
Camera Cables Right-angle camera cables	FZ-VS3 FZ-VSL3	2 m	Yes	Yes	Yes	Yes	Yes	Yes	Yes
		3 m	Yes	Yes	Yes	Yes	Yes	Yes	Yes
		5 m	Yes	Yes	Yes	Yes	Yes	Yes	Yes
		10 m	Yes	No	Yes	No	Yes	No	Yes
Bend resistant camera cables	FZ-VSB3 FZ-VSLB3	2 m	Yes	Yes	Yes	Yes	Yes	Yes	Yes
		3 m	Yes	Yes	Yes	Yes	Yes	Yes	Yes
		5 m	Yes	Yes	Yes	Yes	Yes	Yes	Yes
		10 m	Yes	No	Yes	No	Yes	No	Yes
Long-distance camera cable Long-distance right-angle camera cable	FZ-VS4 FZ-VSL4	15 m	Yes	No	Yes	No	Yes	No	Yes

*1 High-speed CMOS camera is only for the FH series.

Type of camera	Model	Cable length	Digital CCD cameras			Small digital CCD cameras Pen type/flat type	High-speed CCD cameras	Intelligent compact CMOS cameras
			300,000-pixel	2 million-pixel	5 million-pixel			
			FZ-S/SC	FZ-S2M/SC2M	FZ-S5M2/SC5M2	FZ-SF/SFC FZ-SP/SPC	FZ-SH/SHC	FZ-SQ□
Camera Cables Right-angle camera cables	FZ-VS3 FZ-VSL3	2 m	Yes	Yes	Yes	Yes	Yes	Yes
		3 m	Yes	Yes	Yes	Yes	Yes	Yes
		5 m	Yes	Yes	Yes	Yes	Yes	Yes
		10 m	Yes	Yes	No	Yes	Yes	Yes
Bend resistant camera cables	FZ-VSB3 FZ-VSLB3	2 m	Yes	Yes	Yes	Yes	Yes	Yes
		3 m	Yes	Yes	Yes	Yes	Yes	Yes
		5 m	Yes	Yes	Yes	Yes	Yes	Yes
		10 m	Yes	Yes	No	Yes	Yes	Yes
Long-distance camera cable Long-distance right-angle camera cable	FZ-VS4 FZ-VSL4	15 m	Yes	Yes	No	Yes	Yes	Yes

EtherCAT communications specifications

Item	Specifications	
Communications standard	IEC61158 Type 12	
Physical layer	100 BASE-TX (IEEE802.3)	
Modulation	Base band	
Baud rate	100 Mbps	
Topology	Depends on the specifications of the EtherCAT master.	
Transmission media	Twisted-pair cable of category 5 or higher (double-shielded straight cable with aluminum tape and braiding)	
Transmission distance	Distance between nodes: 100 m or less	
Node address setting	00 to 9	
External connection terminals	RJ45 × 2 (shielded) IN: EtherCAT input data, OUT: EtherCAT output data	
Send/receive PDO data sizes	Input	56 to 280 bytes/line (including input data, status, and unused areas) Up to 8 lines can be set.*1
	Output	28 bytes/line (including output data and unused areas) Up to 8 lines can be set.*1
Mailbox data size	Input	512 bytes
	Output	512 bytes
Mailbox	Emergency messages, SDO requests, and SDO information	
Refreshing methods	I/O-synchronized refreshing (DC)	

*1 This depends on the upper limit of the master.

Version information

FH Series and programming devices

FH series	Required programming device	
	Sysmac Studio Standard Edition/Vision Edition	
	Ver.1.06	Ver.1.07 or higher
FH-3050 (-)	Not supported	Supported
FH-1050 (-)		

Note: 1. The auto-update to Sysmac Studio version 1.07 will be available soon.
2. Sysmac Studio does not support the FZ5 series.

Components and functions

Example of the FH sensor controllers BOX type (4-camera type)

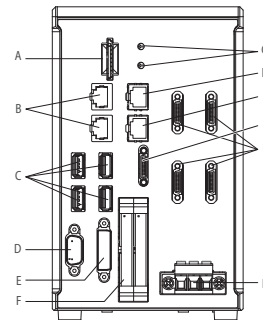
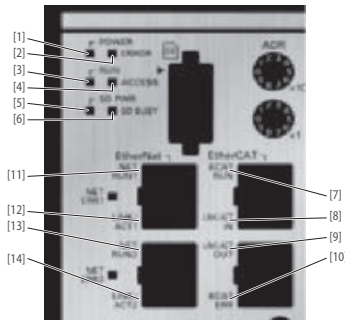

Name	Description
[1] POWER LED	Lit while power is ON.
[2] ERROR LED	Lit when an error has occurred.
[3] RUN LED	Lit while the controller is in Measurement Mode.
[4] ACCESS LED	Lit while the memory is accessed.
[5] SD POWER LED	Lit while power is supplied to the SD card and the card is usable.
[6] SD BUSY LED	Blinks while the SD memory card is accessed.
[7] EtherCAT RUN LED	Lit while EtherCAT communications are usable.
[8] EtherCAT LINK/ACT IN LED	Lit when connected with an EtherCAT device, and blinks while performing communications.
[9] EtherCAT LINK/ACT OUT LED	Lit when connected with an EtherCAT device, and blinks while performing communications.
[10] EtherCAT ERR LED	Lit when EtherCAT communications have become abnormal.
[11] EtherNet NET RUN1 LED	Lit while EtherNet communications are usable.
[12] EtherNet NET LINK/ACK1 LED	Lit when connected with an EtherNet device, and blinks while performing communications.
[13] EtherNet NET RUN2 LED	Lit when EtherNet communications are usable.
[14] EtherNet NET LINK/ACK2 LED	Lit when connected with an EtherNet device, and blinks while performing communications.

Name	Description
A SD memory card installation connector	Install the SD memory card. Do not plug or unplug the SD card during measurement operation. Otherwise measurement time may be affected or data may be destroyed.
B EtherNet connector	Connect an EtherNet device.
C USB connector	Connect a USB device. Do not plug or unplug it during measurement operation. Otherwise measurement time may be affected or data may be destroyed.
D RS-232C connector	Connect an external device such as a programmable controller.
E DVI-I connector	Connect a monitor.
F I/O connector (control lines, data lines)	Connect the controller to external devices such as a sync sensor and PLC.
G EtherCAT address setup volume	Used to set a node address (00 to 99) as an EtherCAT communication device.
H EtherCAT communication connector (IN)	Connect the opposed EtherCAT device.
I EtherCAT communication connector (OUT)	Connect the opposed EtherCAT device.
J Encoder connector	Connect an encoder.
K Camera connector	Connect cameras.
L Power supply terminal connector	Connect a DC power supply. Wire the controller independently on other devices. Wire the ground line. Be sure to ground the controller alone. Perform wiring using the attached power supply connector.

Example of the FZ5 sensor controllers LCD-integrated type (4-camera type)

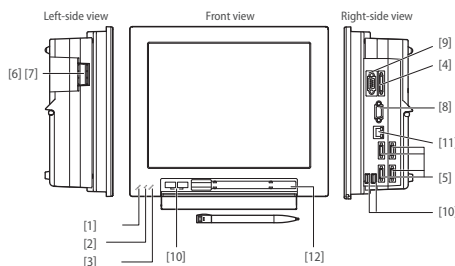

Example of the FZ5-Lite sensor controllers LCD-integrated type (4-camera type)

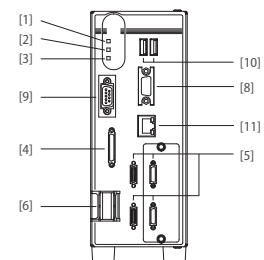

Name	Description
[1] POWER LED	Lit while power is ON.
[2] RUN LED	Lit while the controller is in Run Mode.
[3] ERROR LED	Lit when an error has occurred.
[4] I/O connector (control lines, data lines)	Connect the controller to external devices such as a sync sensor and PLC.
[5] Camera connector	Connect cameras.
[6] Power	Connect a DC power supply. Wire the power supply unit independently of other devices. After wiring, replace the terminal cover.
[7] Ground terminal	Connect the ground wire. Make sure that the controller is grounded with a separate ground wire.
[8] Monitor connector (analog RGB)	Connect a monitor. (Provided with Lite controller type only)
[9] RS-232C/RS-422 connector	Connect an external device such as a personal computer or PLC.
[10] USB connector	Connect a track ball, mouse and USB memory. A total of four USB ports are provided and any of them can be used. However, when connecting two or more USB memories, do not connect them to adjacent ports. Doing so may cause the USB memories to come into contact, resulting in malfunction or damage.
[11] EtherNet connector	Connect the controller to a personal computer.
[12] Touch pen (holder)	A touch pen is stored. (Provided with the LCD integrated type only)

FlexXpect vision platform



FlexXpect is a modular Vision platform featuring industry specific functionality. In combination with the powerful Xpectia-hardware, the FlexXpect software modules take you into a new dimension of specialisation. FlexXpect is simple to use and can be customised easily, to focus on your individual needs. The combination of Xpectia's real colour sensing, high resolution and intuitive user guidance combined with the FlexXpect value added tools represents an unbeatable duo.

Depending on industry, different requirements and regulations are in place for quality inspection. Premium class add-on functionality, tailored for industry, is delivered by FlexXpect.

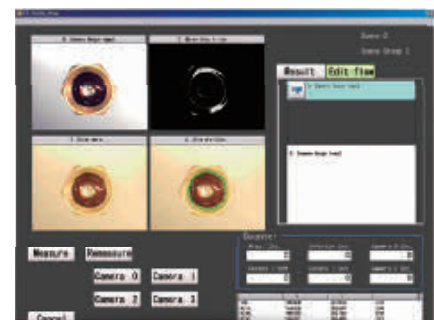

Simplicity – easy to use

FlexXpect features an easy and intuitive user interface, which allows inspection solutions to be set-up quickly and efficiently. With a built in touch screen interface and icon based menu structure, the complexity of programming the system is kept to a minimum. The Flow-Menu is an ideal tool to re-build the process sequences inside the vision platform.

Customised to your needs

The FlexXpect platform can be further customized to the needs of the individual application. Different levels of product modifications are supported. Based on the skill of the user and required functionality it offers:

- Flow programming
- GUI modifications
- Processing items & communication



Your benefits

- FlexXpect-Glue Bead: Automatic one shot seal inspection
- FlexXpect-Pharma: 21 CFR Part 11 compliant
- FlexXpect- Labelling: 360° bottle inspection
- FlexXpect-PV: alignment & inspection of wafers

FlexXpect Pharma



FlexXpect is a modular Vision platform. In combination with the powerful Xpectia-hardware, it takes you into a new dimension of specialisation. The FlexXpect-Pharma is targeting challenging inspections in the Pharmaceutical industry. It offers powerful inspection tools and all functions, necessary for the validation under the FDA 21 CFR Part 11. With the powerful code verification and OCR features, FlexXpect-Pharma is the ideal solution for Track & Trace applications.

Inspect any applications in Pharma:

- Blister pack
- Vials
- Syringes
- Label inspection

Inspect any applications in Pharma

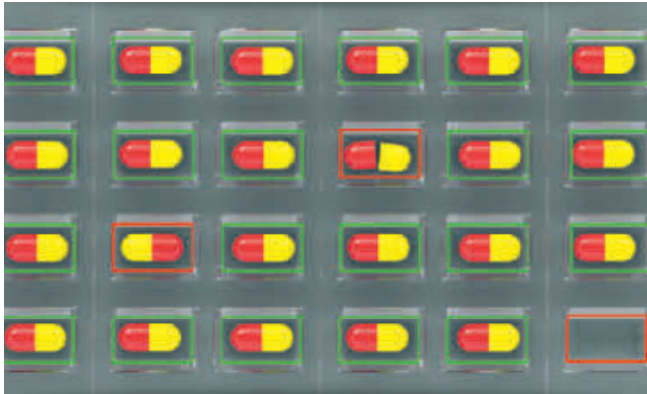

Pill inspection in blisters



Polar transformation of round strings



Date/Batch code verification (OCR/OCV)

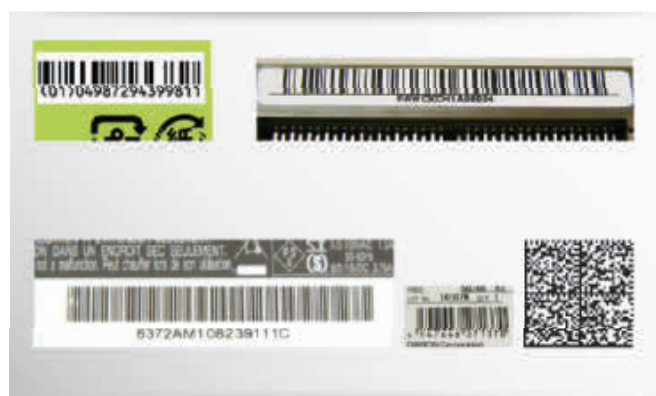

High speed code reading

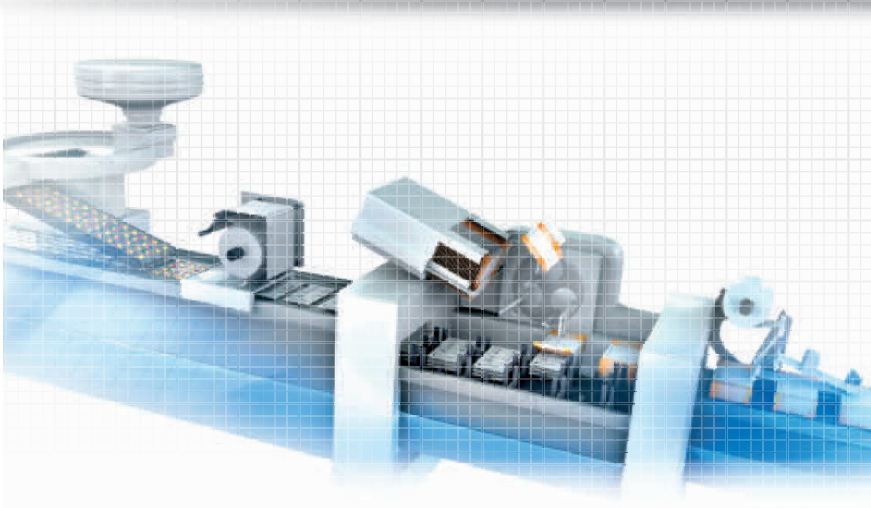

Your benefits

- Strong OCR/OCV (any font & print type)
- Barcode/Datamatrix
- Braille
- Pattern and edge tools
- Real colour inspection
- High resolution to detect minute defects

Optimize your set-up with a click

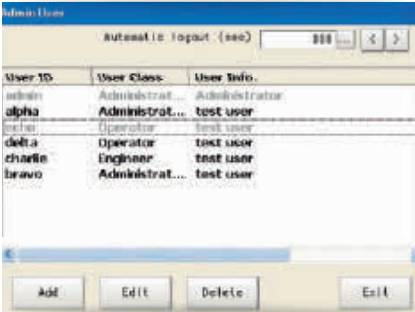

User access administration

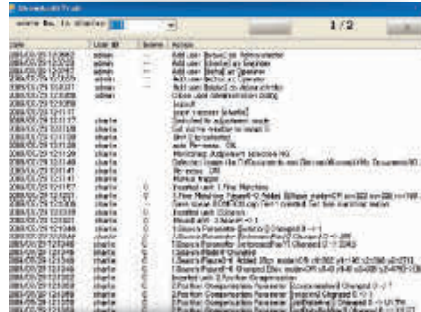

Audit trail

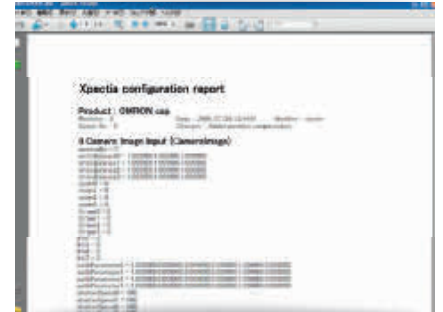

Generate and export configuration data

Item description	Order code	Quick Link
FlexXpect-Pharma software module	FLEXXPECT-PHARMA	G634

Note: FlexXpect software modules require Xpectia/FZW hardware. This is not part of the item and needs to be ordered independently.

FlexXpect Labelling



FlexXpect is a modular Vision platform. In combination with the powerful Xpectia-hardware, it takes you into a new dimension of specialisation. FlexXpect-Labelling has been designed to deliver tailored functionality for inspection of labels and packages.

Powerful image processing tools for labelling:

- OCR/OCV
- Barcode/Datamatrix
- Pattern and edge tools
- Real colour inspection
- High resolution to detect minute defects

Label unwrapping from bottles for inspection of premium beverages:

- Acquire images from up to 4x cameras
- Compensate the distortion
- Identify the overlapping areas
- Stitch the images together

Powerful image processing tools for labelling



Strong OCR/OCV



Polar transformation of round strings



Date/Batch code verification (OCR/OCV)



High speed code reading



Your benefits

- Strong OCR/OCV
- Code reading (Barcode, Datamatrix)
- 360° inspections of bottles
- Real colour processing items
- High resolution
- Easy & intuitive configuration



Position and defect inspection

Produce aesthetically perfect products is a key point. FlexXpect-Labeling offers a suite of image processing tools to inspect the label for position and defects.

Reading different codes at a time

Two or more different codes in the same field of view can be read by utilizing a high resolution camera. This function helps to reduce the inspection time.

Item description	Order code	Quick Link
FlexXpect-Labeling software module	FLEXXPECT-LABELLING	G633

Note: FlexXpect software modules require Xpectia/FZW hardware. This is not part of the item and needs to be ordered independently.

FlexXpect Glue Bead



FlexXpect is a modular Vision platform. In combination with the powerful Xpectia-hardware, it takes you into a new dimension of specialisation. The FlexXpect-Glue Bead inspects the complete sealing of automotive parts in one shot. Driven by the real colour functionality, any sealing can be identified and checked, independent how visible it is. Featuring a simple set-up procedure and automatic calculation of the path, it represents a powerful and straight forward solution for any glue application.

Glue Bead inspection:

- Correct path
- Thickness
- Interrupt

Inspect any applications in Pharma

FlexXpect-Glue Bead features an intuitive and easy set-up procedure. No expert knowledge of the user is required.

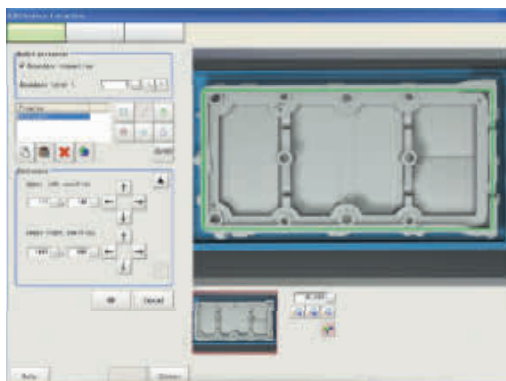

Step 1

Define inspection area.

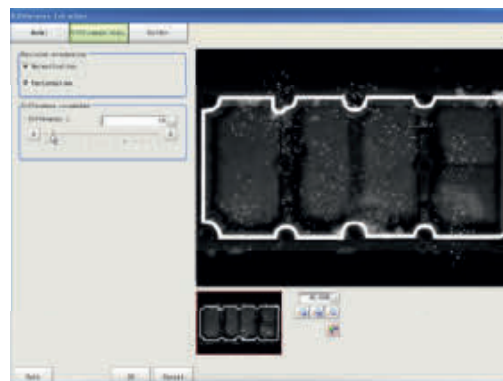

Step 2

Teach the glue.

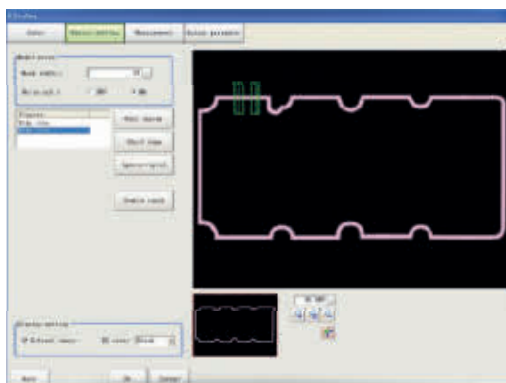

Step 3

Define start & end point of the glue.

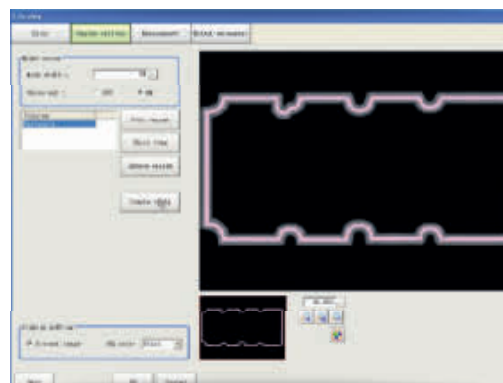

Step 4

Automatic calculation of the path of the Glue Bead.

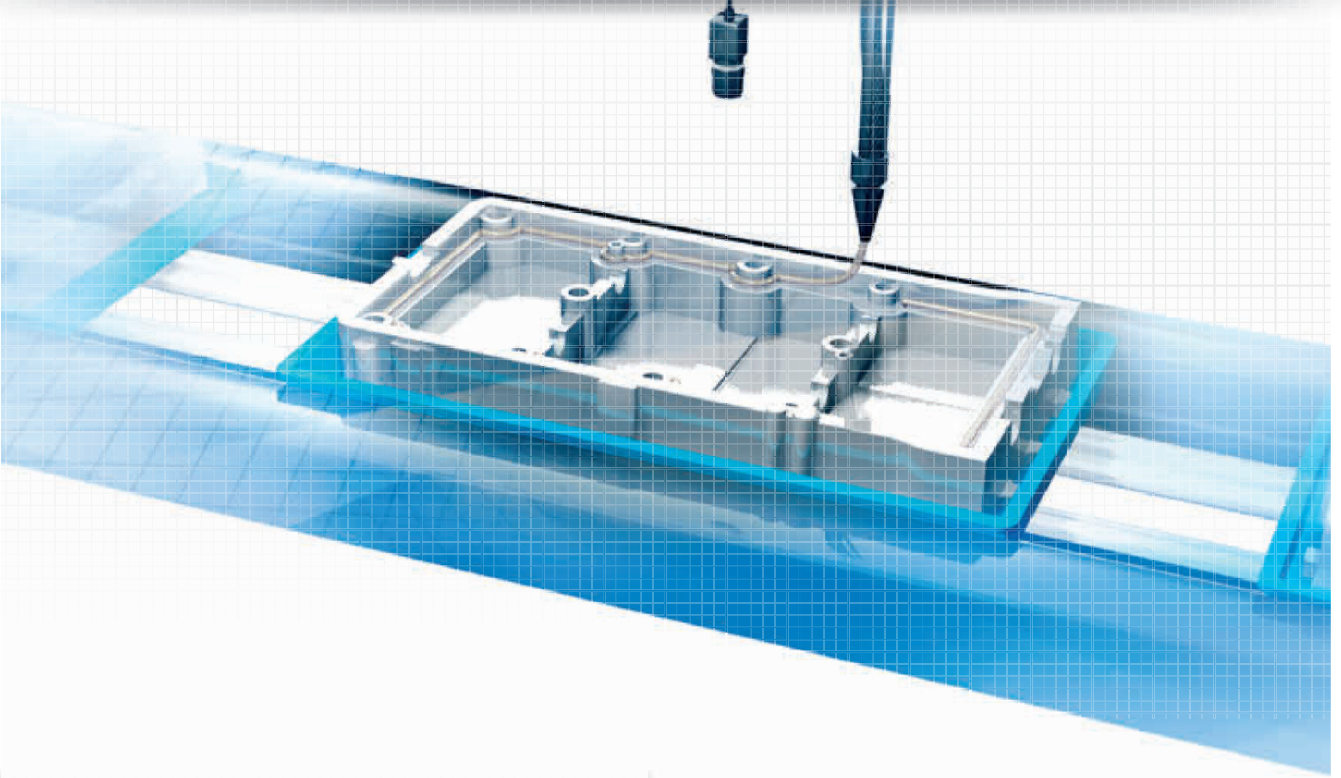

Your benefits

- One shot inspection of the complete path
- Easy set-up
- Automatic path calculation
- Real colour glue extraction

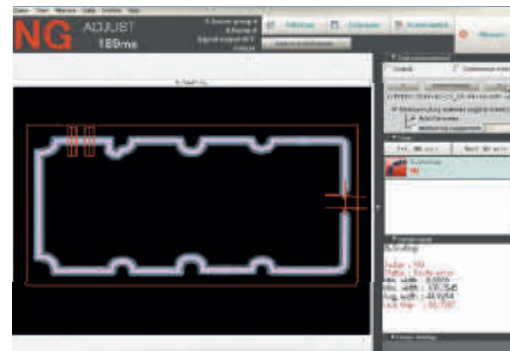
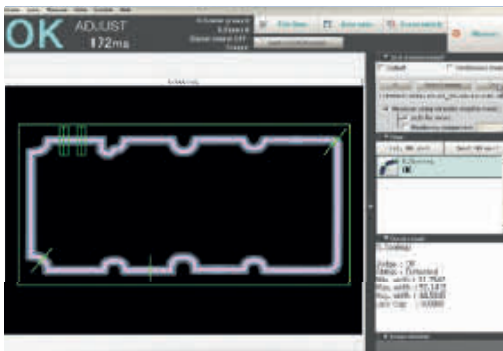

Item description	Order code	Quick Link
FlexXpect-Glue Bead software module	FLEXXPECT-GLUE BEAD	G632

Note: FlexXpect software modules require Xpectia/FZW hardware. This is not part of the item and needs to be ordered independently.

FlexXpect PV



FlexXpect is a modular Vision platform. In combination with the powerful Xpectia hardware, it takes you into a new dimension of specialisation. FlexXpect-PV delivers tailored functionality for alignment and the inspection of wafers for chips and cracks.

Features of FlexXpect-PV:

- Easy and intuitive set-up
- Automatic extraction and teaching of the PV wafer
- Precise inspections with high resolution cameras
- Automatic robot calibration
- Fade-out strings and conveyor belts

Supported PV inspections:

- Precise wafer and string alignment
- Accurate chamfer chip inspection
- Detection of minute edge cracks
- Bus bar alignment on the wafer

Quick set-up in simple steps:



Step 1:

Select the inspection function

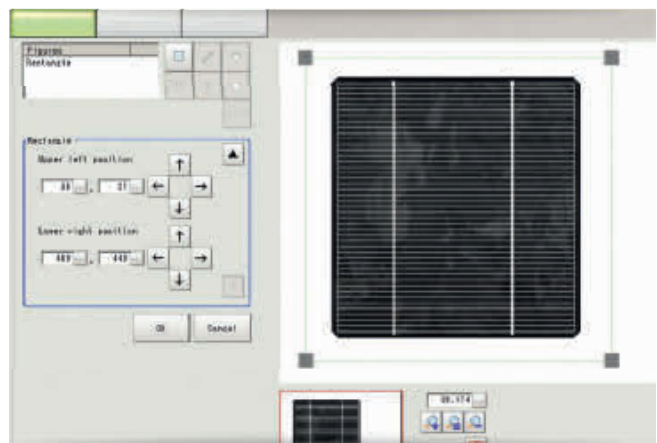

Step 2:

Draw a rectangle around the wafer

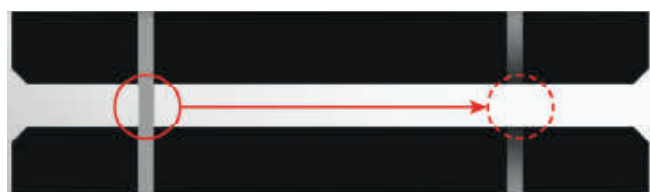

Step 3:

One step deletion of bus bars and conveyor belts (optional)



Step 4:

Start the inspection
Accurate chamfer chip inspection (0.1 mm)

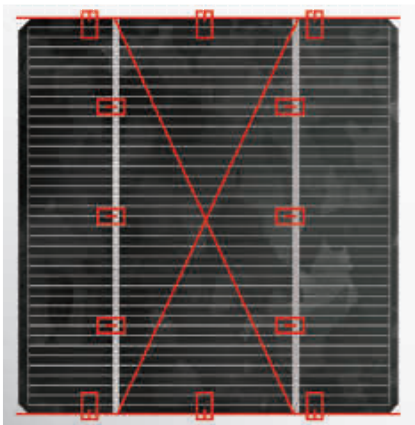
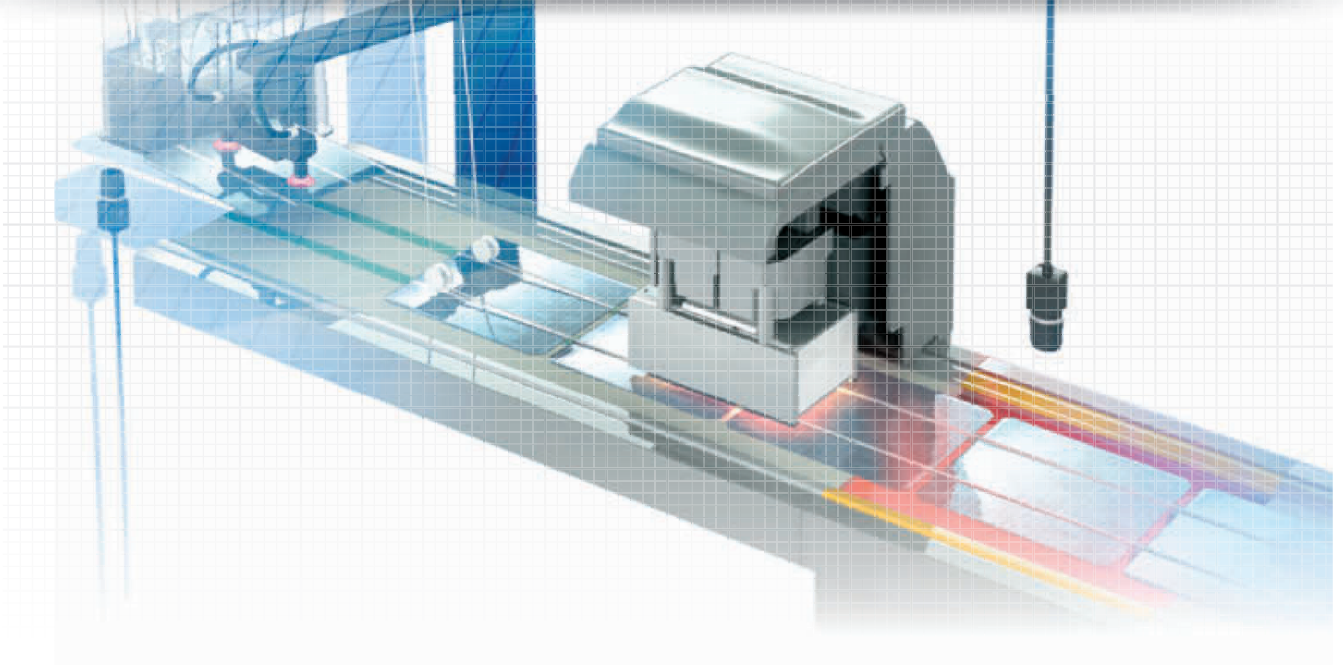

Bus bar alignment

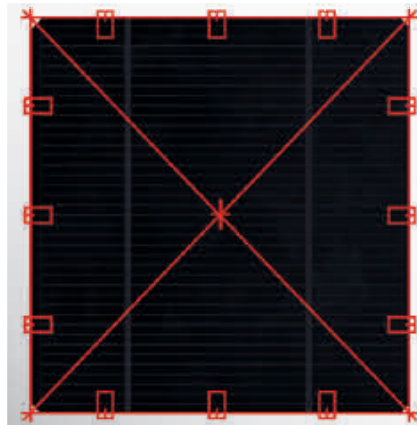

Outline edge alignment

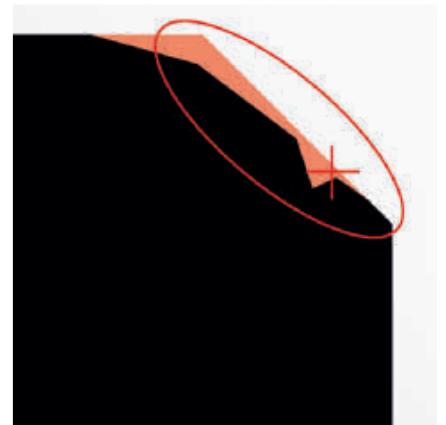

Precise detection of edge breakage

Your benefits

- One shot inspection of the complete path
- Easy set-up
- Automatic path calculation
- Real colour glue extraction

Item description	Order code	Quick Link
FlexXpect-PV software module	FLEXXPECT-PV	G636

Note: FlexXpect software modules require Xpectia/FZW hardware. This is not part of the item and needs to be ordered independently.

V680 RFID System

One for all

Whenever you need to have full transparency of your production process or logistic application V680 is helping you to manage your data most comfortably and reliably.

- Diagnostic functions for maintenance
- One for all: modular platform concept
- Flexible installation: long reach antennas
- Fit for speed: high turn around time
- Save time & costs: easy setup & maintenance



Production ID system for the paint shop

A RFID system is used to store the process parameters needed for the production of the car throughout the process. Harsh conditions through chemicals and high temperatures occur during the production steps. RFID is ideal for this application as it features high resistance tags for harsh conditions.

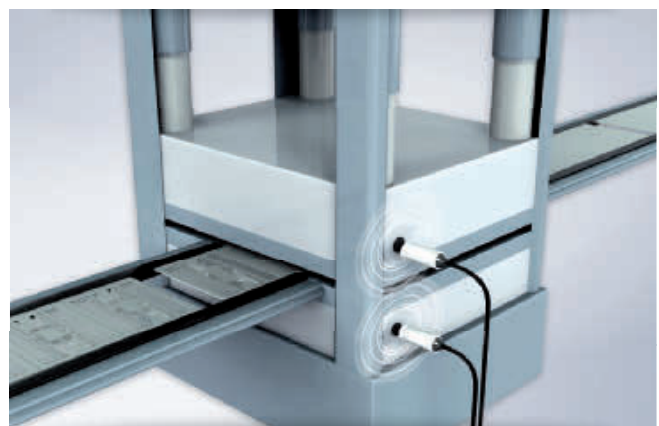

Monitoring of the moulding history

Process and maintenance related information of a moulding press can be stored by using RFID. The information can be read out permanently or on demand from a remote location and can be used to control the process.



Your benefits

- High speed air communication
- Standardized protocol (ISO 15693)
- Large memory (up to 32kByte) and very compact tags
- Long life time of tags (FERAM variants)
- All protocols for PLC communication

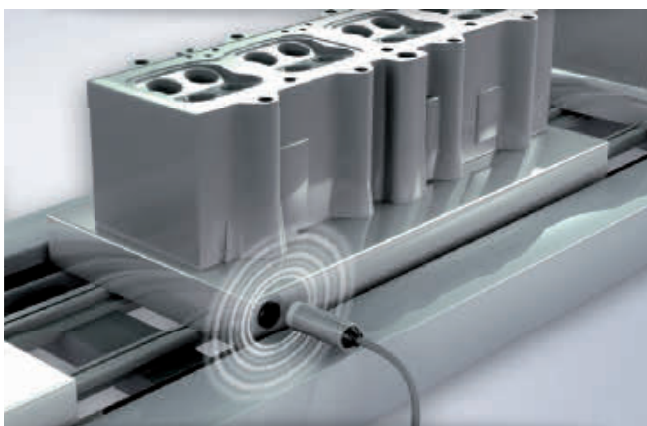

Traceability of automotive parts

Track the parts in the production process. Process related information can be stored to guarantee high quality production.



Carrier Management

For the administration and traceability of transport carriers along the whole process RFID represents a smart solution. V680 is working on the standardized universal frequency of 13.56MHz. The flexible platform with its versatile and compact design can be easily integrated into any point in the production process.



3 in 1 RFID: Antenna, amplifier & controller

- Conforms to ISO/IEC 18000-3 (15693).
- Standard-feature Ethernet (Modbus TCP) enables easy connection with one cable.
- Easy installation and “visualized” communications status minimize startup work and downtime.
- WEB browser can be used for setting, monitoring, and communications with RF tags.

Ordering information

V680S-series

RF tag

Type	Memory capacity	Appearance	Size	Installation	Order code
Battery-less	2 kbytes		40 × 40 × 5 mm	For flush mounting on metallic surface	V680S-D2KF67M
				For flush mounting on nonmetallic surface	V680S-D2KF67
	8 kbytes		86 × 54 × 10 mm	For flush mounting on metallic surface	V680S-D2KF68M
				For flush mounting on nonmetallic surface	V680S-D2KF68
	8 kbytes		40 × 40 × 5 mm	For flush mounting on metallic surface	V680S-D8KF67M ^{*1}
				For flush mounting on nonmetallic surface	V680S-D8KF67 ^{*1}
8 kbytes		86 × 54 × 10 mm	For flush mounting on metallic surface	V680S-D8KF68M ^{*1}	
			For flush mounting on nonmetallic surface	V680S-D8KF68 ^{*1}	

^{*1} V680S-D8KF6_M/V680S-D8KF6_ can be used with V680S series Reader/Writer version 2.00 or higher.

V680-series

RF tag



Type	Memory capacity	Appearance	Size	Installation	Order code
Battery-less	1 kbyte		20 dia. × 2.7 mm	For flush mounting on nonmetallic surface	V680-D1KP54T
				For flush mounting on metallic surface	V680-D1KP66MT
					For flush mounting on nonmetallic surface
Environment-resistant type Battery-less			95 × 36.5 × 6.5 mm	For flush mounting on nonmetallic surface	V680-D1KP66T-SP
High-temperature type Battery-less			80 dia. × t10 mm	For mounting with special attachment	V680-D1KP58HTN

Note: V680 series 8kbyte RF Tag (V680-D8KF67, V680-D8KF67M and V680-D8KF68A) can communicate with V680S series Reader/Writer. For details, refer to the User's Manual (Cat. No. Z339).

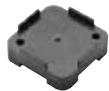

Reader/Writer

Type	Appearance	Size	Interface	Order code
Reader/Writer		75 × 75 × 40 mm	Ethernet (TCP/IP: Modbus TCP)	V680S-HMD64-ETN
		120 × 120 × 40 mm	Ethernet (TCP/IP: Modbus TCP)	V680S-HMD66-ETN

RF tag attachment

Type	Appearance	Order code
For the V680-D1KP66T		V600-A86
For the V680-D1KP58HTN		V680-A80
For the V680-D1KP54T		V700-A80

Cable

Type	Appearance	Length	Order code
Special connector – RJ45		2 m	V680S-A41 2M
		5 m	V680S-A41 5M
		10 m	V680S-A41 10M
Special connector – Loose wires		2 m	V680S-A42 2M
		5 m	V680S-A42 5M
		10 m	V680S-A42 10M

Extension cable

Type	Appearance	Length	Order code
Special connector – Special connector		10 m	V680S-A40 10M
		20 m	V680S-A40 20M
		50 m	V680S-A40 50M

Note: The maximum extendable cable length using the cable and extension cable is 60 m. Only one extension cable can be used.

Industrial switching hubs (Recommended hubs)

Type	Appearance	Specifications			Order code
		Functions	No. of ports	Failure detection	
Industrial switching hubs		Quality of Service (QoS): EtherNet/IP control data priority Failure detection: Broadcast storm and LSI error detection 10/100BASE-TX, Auto-Negotiation	3	No	W4S1-03B
			5	No	W4S1-05B
			5	Yes	W4S1-05C

Specifications

V680S-series

RF tag (2-kbyte Memory)

Item	V680S-D2KF67	V680S-D2KF67M	V680S-D2KF68	V680S-D2KF68M
Memory capacity	2,000bytes (user area)			
Memory type	FRAM			
Data retention	10 years after writing (85°C or less)			
Memory life	One trillion writes for each block (85°C or less), Access frequency*1: One trillion accesses			
Ambient operating temperature	-20 to 85°C (with no icing)			
Ambient storage temperature	-40 to 125°C (with no icing)			
Ambient operating humidity	35% to 85%			
Degree of protection	IP68 (IEC 60529:2001), Oil resistance equivalent to IP67G (JIS C 0920:2003, Appendix 1)*2. IPX9K (DIN 40 050)			
Vibration resistance	No abnormality after application of 10 to 2,000 Hz, 1.5-mm double amplitude, acceleration: 150 m/s ² , 10 sweeps each in X, Y, and Z directions for 15 minutes each		No abnormality after application of 10 to 500 Hz, 1.5-mm double amplitude, acceleration: 100 m/s ² , 10 sweeps each in X, Y, and Z directions for 11 minutes each	
Shock resistance	No abnormality after application of 500 m/s ² , 3 times each in X, Y, and Z directions (Total: 18 times)			
Dimensions (W×H×D)	40 × 40 × 5 mm		86 × 54 × 10 mm	
Materials	Exterior: PPS resin			
Weight	Approx. 11.5 g	Approx. 12 g	Approx. 44 g	Approx. 46 g
Metal countermeasures	None	Provided	None	Provided

*1 The number of accesses is the total number of reads and writes.

*2 Oil resistance has been tested using a specific oil as defined in the OMRON test method.

Note: For details, refer to the User's Manual (Cat. No. Z339).

RF Tag (8-kbyte Memory)

Item	V680S-D8KF67	V680S-D8KF67M	V680S-D8KF68	V680S-D8KF68M
Memory capacity	8,192 bytes (user area)			
Memory type	FRAM			
Data retention	10 years after writing (85°C or less)			
Memory life	One trillion writes for each block (85°C or less), Access frequency*1: One trillion accesses			
Ambient operating temperature	-20 to 85°C (with no icing)			
Ambient storage temperature	-40 to 125°C (with no icing)			
Ambient operating humidity	35% to 85%			
Degree of protection	IP68 (IEC 60529:2001), Oil resistance equivalent to IP67G (JIS C 0920:2003, Appendix 1)*2. IPX9K (DIN 40 050)			
Vibration resistance	No abnormality after application of 10 to 2,000 Hz, 1.5-mm double amplitude, acceleration: 150 m/s ² , 10 sweeps each in X, Y, and Z directions for 15 minutes each		No abnormality after application of 10 to 500 Hz, 1.5-mm double amplitude, acceleration: 100 m/s ² , 10 sweeps each in X, Y, and Z directions for 11 minutes each	
Shock resistance	No abnormality after application of 500 m/s ² , 3 times each in X, Y, and Z directions (Total: 18 times)			
Dimensions (W×H×D)	40 × 40 × 5 mm		86 × 54 × 10 mm	
Materials	Exterior: PPS resin			
Weight	Approx. 11.5 g	Approx. 12 g	Approx. 44 g	Approx. 46 g
Metal countermeasures	None	Provided	None	Provided

*1 The number of accesses is the total number of reads and writes.

*2 Oil resistance has been tested using a specific oil as defined in the OMRON test method.

Note: For details, refer to the User's Manual (Cat. No. Z339).

V680-series

RF Tag (1-kbyte Memory)

Item	V680-D1KP54T	V680-D1KP66T	V680-D1KP66MT	V680-D1KP66T-5P
Memory capacity	1,000 bytes (user area)			
Memory type	EEPROM			
Data retention time	10 years after writing (85°C or less), 0.5 year after writing (85 to 125°C) Total data retention at high temperatures exceeding 125°C is 10 hours*1			10 years after writing (85°C or less)
Write endurance	100,000 writes for each block (25°C)			
Ambient operating temperature (during transmission)	-25 to 85°C (with no icing)			During RF Tag communications: -25 to 70°C (with no icing) Not during RF Tag communications: -40 to 110°C (with no icing)
Ambient storage temperature (during data backup)	-40 to 125°C (with no icing) Heat resistance: 1,000 thermal cycles each of 30 minutes at -10°C/150°C, High temperature storage: 1,000 hours at 150°C*2 200 thermal cycles each of 30 minutes at -10°C/180°C, High temperature storage: 200 hours at 180°C*3			-40 to 110°C (with no icing)
Ambient operating humidity	35 to 95%			
Degree of protection	IP67 (IEC 60529:2001) Oil resistance equivalent to IP67G (JIS C 0920:2003, Appendix 1)*4	IP68 (IEC 60529:2001) Oil resistance equivalent to IP67G (JIS C 0920:2003, Appendix 1)*4	IP67	IP67
Vibration resistance	No abnormality after application of 10 to 2,000 Hz, 1.5-mm double amplitude, acceleration: 150 m/s ² , 10 sweeps each in X, Y, and Z directions for 15 minutes each			
Shock resistance	No abnormality after application of 500 m/s ² , 3 times each in X, Y, and Z directions (Total: 18 times)			

Item	V680-D1KP54T	V680-D1KP66T	V680-D1KP66MT	V680-D1KP66T-SP
Appearance	20 dia. × 2.7 mm	34 × 34 × 3.5 mm		95 × 36.5 × 6.5 mm (excluding protruding parts)
Materials	PPS resin			Exterior: PFA fluororesin RF Tag filling: PPS resin
Weight	Approx. 2 g	Approx. 6 g	Approx. 7.5 g	Approx. 20 g
Metal countermeasures	None	None	Provided	None

*1 After storing data at high temperatures, rewrite the data even if changes are not required. High temperatures are those exceeding 125°C up to 180°C.

*2 150°C heat resistance: The heat resistance has been checked at 150°C for up to 1,000 hours, and thermal shock has been checked through testing 1,000 thermal cycles each of 30 minutes at -10/150°C. (Test samples: 22, defects: 0)

*3 180°C heat resistance: The heat resistance has been checked at 180°C for up to 200 hours, and thermal shock has been checked through testing 200 thermal cycles each of 30 minutes at -10°C/180°C. (Test samples: 22, defects: 0)

*4 Oil resistance has been tested using a specific oil as defined in the OMRON test method.

Note: For details, refer to the User's Manual (Cat. No. Z339).

RF Tag (1-kbyte Memory with High-temperature Capability)

Item	V680-D1KP58HTN
Memory capacity	1,000 bytes (user area)
Memory type	EEPROM
Data retention	10 years after writing (85°C or less), 0.5 year after writing (85 to 125°C) Total data retention at high temperatures exceeding 125°C is 10 hours*1
Write endurance	100,000 writes for each block (25°C)
Ambient operating temperature (during transmission)	-25 to 85°C (with no icing)
Ambient storage temperature (during data backup)	-40 to 250°C (with no icing) (Data retention: -40 to 125°C)
Ambient storage humidity	No restrictions.
Degree of protection	IP67 (IEC 60529:2001) Oil resistance equivalent to IP67G (JIS C 0920:2003, Appendix 1)*2
Vibration resistance	No abnormality after application of 10 to 2,000 Hz, 1.5-mm double amplitude, acceleration: 150 m/s ² , 10 sweeps each in X, Y, and Z directions for 15 minutes each
Shock resistance	No abnormality after application of 500 m/s ² , 3 times each in X, Y, and Z directions (Total: 18 times)
Materials	Exterior: PPS resin
Weight	Approx. 70 g

*1 After storing data at high temperatures, rewrite the data even if changes are not required. High temperatures are those exceeding

*2 Oil resistance has been tested using a specific oil as defined in the OMRON test method.

Note: For details, refer to the User's Manual (Cat. No. Z339).

Reader/Writer

Item	V680S-HMD64-ETN	V680S-HMD66-ETN
Dimensions (W×H×D)	75 × 75 × 40 mm (excluding protruding parts)	120 × 120 × 40 mm (excluding protruding parts)
Power supply voltage	24 VDC (-15% to +10%)	
Consumption current	0.2 A max.	
Ambient operating temperature	-10 to +55°C (with no icing)	
Ambient operating humidity	25% to 85% (with no condensation)	
Ambient storage temperature	-25 to 70°C (with no icing)	
Ambient storage humidity	25% to 85% (with no condensation)	
Insulation resistance	20 MΩ min. (at 500 VDC) between cable terminals and case	
Dielectric strength	1,000 VAC, 50/60 Hz for 1 min between cable terminals and case	
Vibration resistance	No abnormality after application of 10 to 500 Hz, 1.5-mm double amplitude, acceleration: 100 m/s ² , 10 sweeps in each of 3 axis directions (up/down, left/right, and forward/backward) for 11 minutes each	
Shock resistance	No abnormality after application of 500 m/s ² , 3 times each in 6 directions (Total: 18 times)	
Degree of protection	IP67 (IEC 60529: 2001) Oil resistance equivalent to IP67F (JIS C 0920: 2003, Appendix 1)*1	
Materials	Case: PBT resin, Filled resin: Urethane resin	
Mass	Approx. 270g	Approx. 640g
Installation method	Four M4 screws (Use a screw of 12 mm or more in length.)	
Host device communications interface	Ethernet 10BASE-T/100BASE-TX	
Host device communications protocol	MODBUS TCP	
Accessories	Instruction sheet, Copy of Description of Regulations and Standard, IP address label, Ferrite core*2	

*1 Oil resistance has been tested using a specific oil as defined in the OMRON test method.

*2 Provided only with the V680S-HMD66-ETN.

System configuration

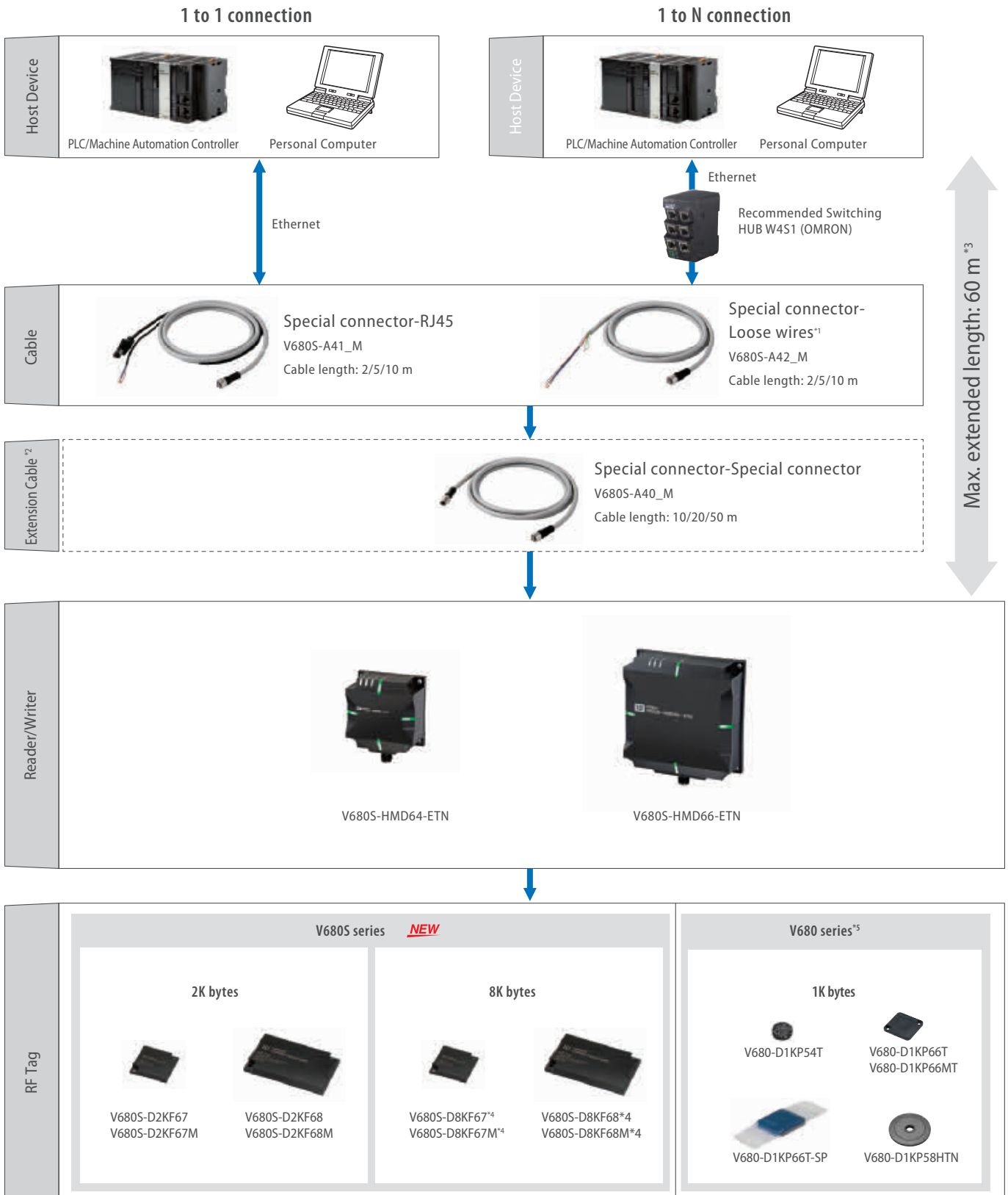

Max. extended length: 60 m^{*3}

Inspection & Ident systems

¹⁾ A customer should treat wires terminal of the connector.
²⁾ Only one extension cable can be used.
³⁾ When the industrial Switching Hub is used, the maximum extendable cable length between the Reader/Writer and the Industrial Switching Hub is 60 m.
⁴⁾ V680S-D8KF6_M/V680S-D8KF6_ can be used with V680S series Reader/Writer version 2.00 or higher.
⁵⁾ V680 series 8K byte RF Tag (V680-D8KF67,V680-D8KF67M and V680-D8KF68A) can communicate with V680S series Reader/Writer. For details, refer to the User's Manual (Cat. No. Z339).

HIGH PRECISION QUALITY INSPECTION

Zero defect becomes reality – scalable accuracy in inspection

The Smart displacement sensor family offers a modular and scalable approach to solve the most challenging measurement tasks. The powerful portfolio enables you to measure profiles, thickness, distance, evenness/warpage, as well as width, edge, etc. Several measurement profiles can be performed simultaneously, using a single- or multi-controller unit. Aided by Omron's advanced technologies, the highest accuracy over long distances, speed and reliability will be achieved.

- Accurate and fast – 0.25 μm at less than 110 μs sampling time
- Scalable – multi-controller unit to coordinate and calculate up to 9 units
- Smart – data storage and remote control via networking capabilities

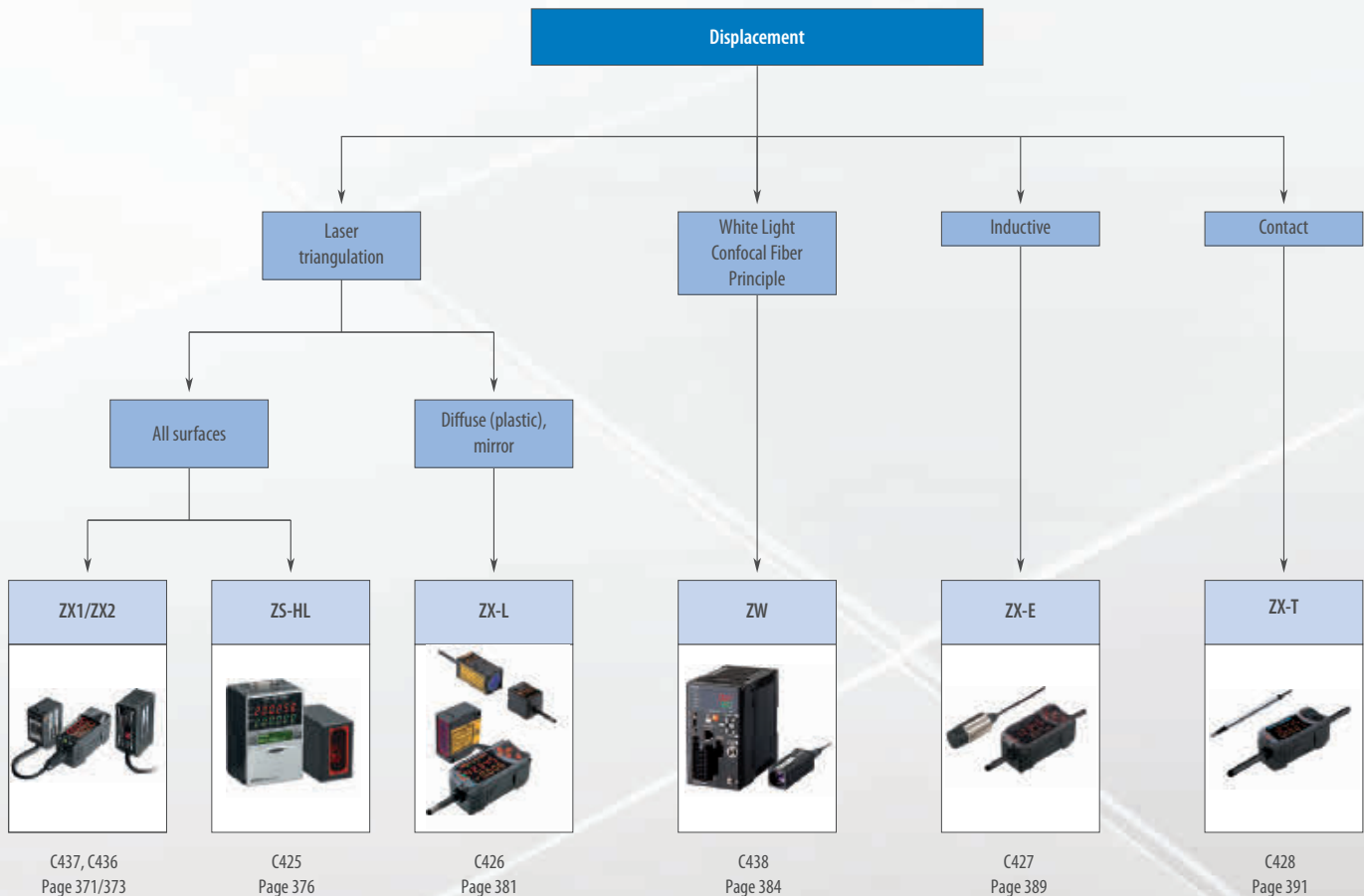



Profile

Position/
Diameter/Width

ZG2

ZX-GT

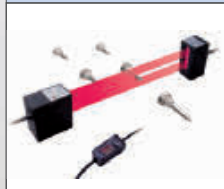

C422
Page 393

C435
Page 397

Selection table

		Laser displacement sensor			Confocal fiber sensor
					
		ZX1/ZX2	ZS-HL	ZX-L	ZW
Selection criteria	Model	ZX1/ZX2	ZS-HL	ZX-L	ZW
	Measurement range Z Min.	50±10 mm	10±0.5 mm	30±2 mm	7 mm
	Max.	600±400 mm	1500±500 mm	300±200 mm	40 mm
	Measurement range X Min.	–	–	–	–
	Max.	–	–	–	–
	Resolution Z	1.5 µm	0.25 µm	0.25 µm	0.01 µm
	Resolution X	–	–	–	–
	Linearity (±% of full scale)	0.05%	0.05%	0.2%	0.1%
	Response time	60 µs	110 µs	150 µs	500 µs
	Spot beam	■	■	■	■
	Line beam	■	■	■	–
	IP-rating head	IP67	IP64/IP67	IP50	IP40
	IP-rating controller	IP40	IP40	IP40	IP20
	Ambient oper. temperature	0 to 50°C	0 to 50°C	0 to 50°C	0 to 40°C
Number of connectable sensors	5	9	5	4	
Features	Thickness measurement	■	■	■	■
	Eccentricity	■	■	■	–
	Height	■	■	■	■
	Step	■	■	■	–
	Profile	–	–	–	–
	Distance	–	–	–	–
	Evenness	–	–	–	–
	Warpage	–	–	–	–
	Edge	–	–	–	–
	Width	–	–	–	–
	Peak	■	■	■	–
	Peak to peak	■	■	■	–
	Bottom	■	■	■	–
	Self-trigger	■	■	■	–
Calibration	■	■	■	■	
Signal scaling	■	–	–	■	
PC-software	–	■	■	■	
Application	Mirror	■	■	–	■
	Glass	■	■	–	■
	Metal	■	■	□	■
	Plastic	■	■	■	■
	Black rubber	■	■	–	■
	Paper	■	■	□	■
Supply voltage	12 to 24 VDC	■	–	■	■
	21.6 to 26.4 VDC	–	■	–	■
Control I/O	4 to 20 mA	■	■	■	■
	1 to 5 VDC	■	–	■	–
	Judgement output High/Pass/Low	■	■	■	■
	Trigger	■	■	■	■
Communication	RS-232C	■	■	■	–
	USB2.0	■	■	–	–
	Page/Quick Link	371/373	376	381	384

	Inductive displacement sensor	Contact displacement sensor	Profile sensor	Laser micrometer	
					
Selection criteria	Model	ZX-E	ZX-T	ZG2	ZX-GT
	Measurement range Z Min.	0.5 mm	1 mm	20 ±0.5 mm	–
	Max.	7 mm	10 mm	210 ±30 mm	28 mm
	Measurement range X Min.	–	–	3 mm	–
	Max.	–	–	70 mm	–
	Resolution Z	1 µm	0.1 µm	0.2 µm	10 µm
	Resolution X	–	–	3 mm/631 pixels	–
	Linearity (±% of full scale)	0.5%	0.3%	0.5%	0.1%
	Response time	150 µs	1 ms	5 ms	150 µs
	Spot beam	–	–	–	–
	Line beam	–	–	☐	–
	IP-rating head	IP67	IP67	IP64/66	IP40
	IP-rating controller	IP40	IP40	IP20	IP40
Ambient oper. temperature	0 to 50°C	0 to 50°C	0 to 50°C	0 to 50°C	
Number of connectable sensors	5	7	1	5	
Features	Thickness measurement	■	■	■	■
	Eccentricity	■	■	■	■
	Height	■	■	■	■
	Step	■	■	■	■
	Profile	–	–	☐	–
	Distance	■	■	–	–
	Evenness	■	■	–	–
	Warpage	■	■	–	–
	Edge	–	–	–	■
	Width	–	–	☐	■
	Peak	■	■	■	■
	Peak to peak	■	■	■	■
	Bottom	■	■	■	■
	Self-trigger	■	■	■	■
	Calibration	–	–	■	–
Signal scaling	■	■	–	■	
PC-software	■	■	■	■	
Application	Mirror	–	■	■	■
	Glass	–	■	■	■
	Metal	■	■	■	■
	Plastic	–	■	■	■
	Black rubber	–	■	■	■
	Paper	–	–	■	■
Supply voltage	12 to 24 VDC	■	■	–	■
	21.6 to 26.4 VDC	–	–	■	■
Control I/O	4 to 20 mA	■	■	■	■
	1 to 5 VDC	■	■	–	■
	Judgement output High/Pass/Low	■	■	■	■
	Trigger	■	■	■	■
Communication	RS-232C	■	■	■	■
	USB2.0	■	–	■	–
	Page/Quick Link	389	391	393	397

■ Standard

☐ Available

– No/not available



Highest performance for optimized productivity

Highest performance is now available in matchbox size. We are defining a new class of measurement sensors using an advanced HSDR-CMOS (High Speed and Dynamic Range) camera chip.

- Stable measurement for objects with any surface
- Best in class performance for accuracy and speed
- Compact size for quick mounting
- Increased measurement range
- Simple configuration by one-button, Smart Tuning
- Reliable measurement in harsh environments
- Integrated display

Ordering information

Sensors

Appearance	Connection method	Cable length	Sensing distance	Order code	
				NPN output	PNP output
	Pre-wired	2 m		ZX1-LD50A61 2M	ZX1-LD50A81 2M
		5 m		ZX1-LD50A61 5M	ZX1-LD50A81 5M
	Pre-wired connector	0.5 m	ZX1-LD50A66 0.5M	ZX1-LD50A86 0.5M	
	Pre-wired	2 m		ZX1-LD100A61 2M	ZX1-LD100A81 2M
		5 m		ZX1-LD100A61 5M	ZX1-LD100A81 5M
	Pre-wired connector	0.5 m	ZX1-LD100A66 0.5M	ZX1-LD100A86 0.5M	
	Pre-wired	2 m		ZX1-LD300A61 2M	ZX1-LD300A81 2M
		5 m		ZX1-LD300A61 5M	ZX1-LD300A81 5M
	Pre-wired connector	0.5 m	ZX1-LD300A66 0.5M	ZX1-LD300A86 0.5M	
	Pre-wired	2 m		ZX1-LD600A61 2M	ZX1-LD600A81 2M
		5 m		ZX1-LD600A61 5M	ZX1-LD600A81 5M
	Pre-wired connector	0.5 m	ZX1-LD600A66 0.5M	ZX1-LD600A86 0.5M	

Accessories (sold separately)

Extension cables for pre-wired connector models

An Extension cable is not provided with the sensor. Order an extension cable separately.

Cable length	Order code
10 m	ZX0-XC10R
20 m	ZX0-XC20R

Specifications

Model	NPN output	ZX1-LD50A61 ZX1-LD50A66	ZX1-LD100A61 ZX1-LD100A66	ZX1-LD300A61 ZX1-LD300A66	ZX1-LD600A61 ZX1-LD600A66
Item	PNP output	ZX1-LD50A81 ZX1-LD50A86	ZX1-LD100A81 ZX1-LD100A86	ZX1-LD300A81 ZX1-LD300A86	ZX1-LD600A81 ZX1-LD600A86
Measurement range		50±10 mm	100±35 mm	300±150 mm	600±400 mm
Light source (wave length)		Visible-light semiconductor laser (wavelength: 660 nm, 1 mW max., IEC/EN Class 2, FDA Class II ^{*1})			
Spot diameter (typical) (Defined at the measurement center distance) ^{*2}		0.17 mm dia.	0.33 mm dia.	0.52 mm dia.	0.56 mm dia.
Power supply voltage		10 to 30 VDC, including 10% ripple (p-p)			
Current consumption		250 mA max. (at power supply voltage 10 VDC)			
Control output		Load power supply voltage: 30 VDC max., Load current: 100 mA max. (Residual voltage: 1 V max. (load current 10 mA or less), 2 V max. (load current of 10 to 100 mA))			
Analog output		Current output: 4 to 20 mA, maximum load resistance: 300 Ω			
Indicators		Digital display (red), output indicator (OUT1, OUT2) (orange), zero reset indicator (orange), menu indicator (orange), laser ON indicator (green), and smart tuning indicator (blue)			
Response time	Judgment output	Super-high-speed (SHS) Mode: 1 ms High-speed (HS) Mode: 10 ms Standard (Std) Mode: 100 ms			
	Laser OFF input	200 ms max.			
	Zero reset input	200 ms max.			
Temperature characteristic ^{*3}		0.03% F.S./°C			0.04% F.S./°C
Linearity ^{*4}		±0.15% F.S.		±0.25% F.S.	±0.25% F.S. (200 to 600 mm) ±0.5% F.S. (entire range)
Resolution ^{*5}		2 μm	7 μm	30 μm	80 μm
Ambient illumination		Illumination on received light surface: 7,500 lx or less (incandescent light)		Illumination on received light surface: 5,000 lx or less (incandescent light)	
Ambient temperature		Operating: -10 to 55°C, Storage: -15 to 70°C (with no icing or condensation)			
Ambient humidity		Operating and storage: 35% to 85% (with no condensation)			
Dielectric strength		1,000 VAC, 50/60 Hz, 1 minute ³			
Vibration resistance (destruction)		10 to 55 Hz, 1.5-mm double amplitude, 2 hours each in X, Y, and Z directions			
Shock resistance (destruction)		500 m/s ² 3 times each in X, Y, and Z directions			
Degree of protection ^{*6}		IEC 60529, IP67			
Connection method		Pre-wired model (Standard cable length: 2 m, 5 m) Pre-wired connector model (Standard cable length: 0.5 m)			
Weight (packed state/ sensor only)	Pre-wired models (2 m)	Approx. 240 g / Approx. 180 g		Approx. 270 g / Approx. 210 g	
	Pre-wired models (5 m)	Approx. 450 g / Approx. 330 g		Approx. 480 g / Approx. 360 g	
	Pre-wired connector models (0.5 m)	Approx. 170 g / Approx. 110 g		Approx. 200 g / Approx. 140 g	
Materials		Case and cover: PBT (polybutylene terephthalate), Optical window: Glass, Cable: PVC, Mounting hole part: SUS303			
Accessories		Instruction sheet and Laser warning label (English)			

^{*1} Classified as Class 2 by EN60825-1 criteria in accordance with the FDA standard provisions of Laser Notice No. 50. Notification to CDRH planned. (Center for Devices and Radiological Health)

^{*2} Spot diameter: Defined as $1/e^2$ (13.5%) of the central intensity at the measurement center distance.

False detections can occur in the case there is light leakage outside the defined region and the surroundings of the target object have a high reflectance in comparison to the target object.

Accurate measurements may not be possible for workpieces that are smaller than the spot diameter.

^{*3} Temperature characteristic: Value for the case the space between the sensor and Omron's standard target object is secured by an aluminum jig. (Measured at the measurement center distance)

^{*4} Linearity: Indicates the error with respect to the ideal straight line of the displacement output in the case of measuring Omron's standard target object (white ceramic) at a temperature of 25°C. Linearity and measured value may vary depending on target object.

^{*5} Resolution: Defined in Standard Mode for Omron's standard target object (white ceramic) after executing Smart Tuning.

The resolution indicates the repetition accuracy for a still workpiece. Not an indication of the distance accuracy.

Resolution performance may not be satisfied in a strong electromagnetic field.

^{*6} IP67 protection applies to the connector on pre-wired connector models if an extension cable is connected.

Note: False detection outside the measurement range can occur in the case of an object with high reflectance.



Stable, easy & affordable laser measurement sensor

High accuracy and measurement stability, at an affordable price. The new ZX2 laser sensor offers best in class performance for accuracy and speed for all linear displacement applications. Utilising an advanced HSDR-CMOS image sensor, high measurement stability is achieved, even on the most challenging of surfaces.

- One touch setup
- Accurate: 1.5 to 5 µm
- Any surface
- High speed: 30 µs

Ordering information

Sensor heads

Optical system	Beam shape	Sensing distance	Resolution	Order code
Diffuse-reflective	Line beam		1.5 µm	ZX2-LD50L
	Spot beam			ZX2-LD50
	Line beam		5 µm	ZX2-LD100L
	Spot beam			ZX2-LD100
Regular reflective	Spot beam		1.5 µm	ZX2-LD50V

Amplifier units

Power supply	Output type	Order code
DC	NPN	ZX2-LDA11
	PNP	ZX2-LDA41

Accessories (order separately)

These are not included with the sensor head or amplifier unit. Please order as necessary.

Calculating unit

	Order code
Calculating unit	ZX2-CAL

Sensor head extension cables*1

Cable length	Order code
1 m	ZX2-XC1R
4 m	ZX2-XC4R
9 m	ZX2-XC9R
20 m	ZX2-XC20R

*1. Extension cables cannot be coupled and used together.

Mounting brackets

Applicable Sensor Heads	Appearance	Contents	Order code
ZX2-LD50V ZX2-LD50L ZX2-LD50		Mounting Bracket: 1 Nut plate: 1 Phillips screws (M3×30): 2	E39-L178
ZX2-LD100L ZX2-LD100			E39-L179

Specifications

Diffuse reflective Sensor Heads

Item Model	ZX2-LD50L	ZX2-LD50	ZX2-LD100L	ZX2-LD100
Optical system	Diffuse reflective			
Light source (wave length)	Visible-light semiconductor laser with a wavelength of 660 nm and an output of 1 mW max. EN class 2, FDA class II ⁵			
Measurement center point	50 mm		100 mm	
Measurement range	±10 mm		±35 mm	
Beam shape	Line	Spot	Line	Spot
Beam size ^{*1}	Approx. 60 μm×2.6 mm	Approx. 60 μm dia.	Approx. 110 μm×2.7 mm	Approx. 110 μm dia.
Resolution ^{*2}	1.5 μm		5 μm	
Linearity ^{*3}	±0.05% F.S. (40 to 50 mm) ±0.1% F.S. (entire range)	±0.1% F.S. (40 to 50 mm) ±0.15% F.S. (entire range)	±0.05% F.S. (65 to 100 mm) ±0.1% F.S. (entire range)	±0.1% F.S. (65 to 100 mm) ±0.15% F.S. (entire range)
Temperature characteristic ^{*4}	0.02% F.S./°C			
Ambient illumination	Incandescent lamp: 10,000 lx max. (on light receiving side)			
Ambient temperature	Operating: 0 to 50°C, Storage: -15 to 70°C (with no icing or condensation)			
Ambient humidity	Operating and storage: 35% to 85% (with no condensation)			
Dielectric strength	1,000 VAC, 50/60 Hz for 1 minute.			
Vibration resistance (destruction)	10 to 150 Hz, 0.7-mm double amplitude, 80 minutes, each in X,Y,and Z directions			
Shock resistance (destruction)	300 m/s ² 3 times each in six directions (up/down,left/right,forward/backward)			
Degree of protection	IEC60529, IP67			
Connection method	Connector connection (standard cable length: 500 mm)			
Weight (packed state)	Approx. 160 g (Sensor Head only: Approx. 75 g)			
Materials	Case and cover: PBT (polybutylene terephthalate), Optical window: Glass, Cable: PVC			
Accessories	Instruction sheet, Ferrite core, Laser warning label (English), FDA certification label			

Regular-reflective Sensor Heads

Item Model	ZX2-LD50V
Optical system	Regular reflective
Light source (wave length)	Visible-light semiconductor laser with a wavelength of 660 nm and an output of 0.24 mW max. EN class 1, FDA class I
Measurement center point	48 mm
Measurement range	±5 mm
Beam shape	Spot
Beam size ^{*1}	Approx. 60 μm dia.
Resolution ^{*2}	1.5 μm
Linearity ^{*3}	±0.3% F.S. (entire range)
Temperature characteristic ^{*4}	0.06% F.S./°C
Ambient illumination	Incandescent lamp: 10,000 lx max. (on light receiving side)
Ambient temperature	Operating: 0 to 50°C, Storage: -15 to 70°C (with no icing or condensation)
Ambient humidity	Operating and storage: 35% to 85% (with no condensation)
Dielectric strength	1,000 VAC, 50/60 Hz for 1 minute.
Vibration resistance (destruction)	10 to 150 Hz, 0.7-mm double amplitude, 80 minutes, each in X,Y,and Z directions
Shock resistance (destruction)	300 m/s ² 3 times each in six directions (up/down,left/right,forward/backward)
Degree of protection	IEC 60529, IP67
Connection method	Connector connection (standard cable length: 500 mm)
Weight (packed state)	Approx. 160 g (Sensor Head only: Approx. 75 g)
Materials	Case and cover: PBT (polybutylene terephthalate), Optical window: Glass, Cable: PVC
Accessories	Instruction sheet, Ferrite core, Laser warning label (English)

^{*1} Beam size: Defined as 1/e² (13.5%) of the central intensity at the smallest value of diameter for the measurement range (typical value) False detections can occur in the case there is light leakage outside the defined region and the surroundings of the target object have a high reflectance in comparison to the target object.

^{*2} Resolution: indicates the degree of fluctuation (±3σ) of analog output when connected to the ZX2-LDA. (The measured value is given for the center distance for OMRON's standard target object (diffuse-reflective models: white ceramic object, regular-reflective models: 1/4 λ flat mirror) when the response time of the ZX2-LDA is set to 128 ms.)

Indicates the repetition accuracy for when the workpiece is in a state of rest. Not an indication of distance accuracy. Resolution performance may not be satisfied in a strong electromagnetic field.

^{*3} Linearity: indicates the error with respect to the ideal straight line of the displacement output in the case of measuring Omron's standard target object. Linearity and measured value may vary depending on target object. F.S. indicates the full scope of the measurement range. (ZX2-LD50 (L): 20mm)

^{*4} Temperature characteristic: Value for the case the space between the sensor head and Omron's standard target object is secured by an aluminum jig. (Measured at the measurement center distance)

^{*5} These Sensors are classified as Class 2 laser devices for diffuse-reflective models and Class 1 for regular-reflective models under EN 606825-1 and the regulations of Laser Notice No. 50 for FDA certification. CDRH registration has been completed for diffuse-reflective models and is scheduled for regular-reflective models.

Note: False detection outside the measurement range can occur in the case of an object with high reflectance.

Amplifier units

Item	ZX2-LDA11	ZX2-LDA41
Measurement period*1	Min 30 μ s	
Response time	60 μ s, 120 μ s, 240 μ s, 500 μ s, 1 ms, 2 ms, 4 ms, 8 ms, 12 ms, 20 ms, 36 ms, 66 ms, 128 ms, 250 ms, 500 ms	
Analog output*2	4 to 20 mA, Max. load resistance: 300 Ω , \pm 5VDC or 1 to 5 VDC, Output impedance: 100 Ω	
Judgement outputs (HIGH/PASS/LOW: 3 outputs), error output	NPN open-collector outputs, 30 VDC, 50 mA max.(residual voltage: 1 V max. for load current 10 mA max., 2 V max. for load current above 10 mA)	PNP open-collector outputs, 30 VDC, 50 mA max.(residual voltage: 1 V max. for load current 10 mA max., 2 V max. for load current above 10 mA)
Laser OFF input, zero reset input, timing input, reset input, bank input	ON: Short-circuited with 0-V terminal or 1.5 V or less OFF: Open (leakage current: 0.1 mA max.)	ON: Supply voltage short-circuited or supply voltage within 1.5 V OFF: Open (leakage current: 0.1 mA max.)
Functions	Smart tuning, scaling, sample hold, peak hold, bottom hold, peak-to-peak hold, self-peak hold, self-bottom hold, average hold, zero reset, On-delay timer, OFF-delay timer, keep/clamp switch, (A-B)calculations*3, thickness calculation*3, mutual interference prevention*3, laser deterioration detection, bank function (4 banks)	
Indications	Judgement indicators: HIGH (orange), PASS (green), LOW (orange), 11-segment main display (red), 11-segmentsub-display (orange), laser ON (green), zero reset (green), enable (green), menu (green), HIGH threshold (orange), LOW threshold (orange)	
Power supply voltage	10 to 30 VDC, including 10% ripple(p-p)	
Power consumption	3,000 mW max. with power supply voltage of 30 VDC and power supply current of 100 mA (with Sensor connected)	
Ambient temperature	Operating: 0 to 50°C, Storage: -15 to 70°C (with no icing or condensation)	
Ambient humidity	Operating and storage: 35% to 85% (with no condensation)	
Dielectric strength	1,000 VAC, 50/60 Hz for 1 min.	
Vibration resistance (destruction)	10 to 150 Hz, 0.7-mm double amplitude, 80 min. each in X,Y,and Z directions	
Shock resistance (destruction)	300 m/s ² 3 times each in six directions (up/down,left/right,forward/backward)	
Degree of protection	IEC60529, IP40P	
Connection method	Prewired (standard cable length: 2 m)	
Weight (packed state)	Approx. 200 g (unit only: Approx.135 g)	
Materials	Case: PBT(polybutylene terephthalate), Cover: Polycarbonate, Display: Acrylic resin, Button: Polyacetal, Cable: PVC	
Accessories	Instruction sheet	

*1 In the case of Omron's standard target object (white ceramic)

*2 Configure current output (4 to 20mA) and voltage output (\pm 5 V or 1 to 5 V) by MENU mode.

*3 Calculating unit (ZX2-CAL) is necessary.

Calculating unit

Item	ZX2-CAL
Applicable amplifier units	ZX2-LDA11/ZX2-LDA41
Current consumption	12 mA max. (supplied from the smart sensor amplifier unit)
Ambient temperature	Operating: 0 to 50°C, storage: -15 to 70°C (with no icing or condensation)
Ambient humidity	Operating and storage: 35% to 85% RH (with no condensation)
Connection method	Connector
Dielectric strength	1,000 VAC, 50/60 Hz for 1 min
Insulation resistance	100 M Ω (at 500 VDC)
Vibration resistance (destructive)	10 to 150 Hz, 0.7-mm double amplitude 80 min each in X, Y, and Z directions
Shock resistance (destructive)	300 m/s ² 3 times each in six directions (up/down, left/right, forward/backward)
Materials	Case: PBT (polybutylene terephthalate), Display: Acrylic resin
Weight (packed state)	Approx. 50 g
Accessories	Instruction sheet



The scalable high-precision laser measurement sensor

The ZS laser sensor family provides outstanding measurement performance on all kind of materials. Its huge range of sensor heads and scalable concept makes it a versatile platform for all high precision sensing applications.

- Highest resolution and dynamic sensing range for all surfaces
- Modular and scalable platform concept for up to 9 sensors
- Easy to use, install and maintain for all user levels
- Fast response time of 110 μs
- Multi-tasking capability – manages up to 4 measurement tools in one controller

Ordering information

Sensors

ZS-HL-series sensor heads

Optical system	Sensing distance	Beam shape	Beam diameter	Resolution*1	Order code
Regular reflective models	20±1 mm	Line beam	1.0 mm × 20 μm	0.25 μm	ZS-HLDS2T
	25±2 mm		2.2 mm × 45 μm	0.6 μm	ZS-HLDS2VT
Diffuse reflective models	50±5 mm	Line beam	1.0 mm × 30 μm	0.25 μm	ZS-HLDS5T
	100±20 mm		3.5 mm × 60 μm	1 μm	ZS-HLDS10
	600±350 mm		16 mm × 0.3 mm	8 μm	ZS-HLDS60
	1500±500 mm		40 mm × 1.5 mm	500 μm	ZS-HLDS150

*1 Refer to the table of ratings and specifications for details.

ZS-HL-series sensor heads (for nozzle gaps) also compatible with ZS-L controller

Optical system	Sensing distance	Beam shape	Beam diameter	Resolution*1	Order code
Regular reflective models	10±0.5 mm	Line beam	900x25 μm	0.25 μm	ZS-LD10GT
	15±0.75 mm				ZS-LD15GT

*1 Refer to the table of ratings and specifications for details.

ZS-L-series sensor heads

Optical system	Sensing distance	Beam shape	Beam diameter	Resolution*1	Order code
Regular reflective models	20±1 mm	Line beam	900 × 25 μm	0.25 μm	ZS-LD20T
		Spot beam	25 μm dia.		ZS-LD20ST
	40±2.5 mm	Line beam	2000 × 35 μm	ZS-LD40T	
Diffuse reflective models	50±5 mm	Line beam	900 × 60 μm	0.8 μm	ZS-LD50
		Spot beam	50 μm dia.		ZS-LD50S
	80±15 mm	Line beam	900 × 60 μm	2 μm	ZS-LD80
	130±15 mm	Line beam	600 × 70 μm	3 μm	ZS-LD130
	200 ±50 mm	Line beam	900 × 100 μm	5 μm	ZS-LD200
350 ±135 mm	Spot beam	240 μm dia.	20 μm	ZS-LD350S	

*1 This is the peak-to-peak displacement conversion value in the displacement output at the measuring center distance in high-precision mode when the number of samples to average is set to 128 and the measuring mode is set to the high-resolution mode. The standard workpiece is white aluminum ceramics in diffuse reflection mode and glass in the regular reflection mode.

ZS-HL-series sensor controllers

Supply voltage	Control outputs	Order code
24 VDC	NPN outputs	ZS-HLDC11
	PNP outputs	ZS-HLDC41
		ZS-HLDC41A (incl. USB cable + Smart monitor)

Multi-controllers

Supply voltage	Control outputs	Order code
24 VDC	NPN outputs	ZS-MDC11
	PNP outputs	ZS-MDC41

Data storage units

Supply voltage	Control outputs	Order code
24 VDC	NPN outputs	ZS-DSU11
	PNP outputs	ZS-DSU41

Accessories (sold separately)

Controller link

Item	Order code
Controller link	ZS-XCN

Panel mount adapter

Model	Order code
For 1st controller	ZS-XPM1
For expansion (from 2nd controller on)	ZS-XPM2

Cables for connecting to a Personal Computer

Type	Quantity	Order code
RS-232C	1	ZS-XRS2
USB	1	ZS-XUSB2

Extension cables for sensor heads

Cable length	Quantity	Order code
1 m	1	ZS-XC1A
4 m	1	ZS-XC4A
5 m	1	ZS-XC5B*1,*2
8 m	1	ZS-XC8A
10 m	1	ZS-XC10B*1

*1 Up to two ZS-XC_B cables can be connected (22 m max.).

*2 A robot cable (ZS-XC5BR) is also available.

Logging software

Item	Order code
Smart monitor zero professional	ZS-SW11E

Memory card

Model	Order code
64 MB	F160-N64S(S)
128 MB	QM300-N128S
256 MB	F160-N256S

Safety precautions for using laser equipment

Laser Label Indications
Attach the following warning label to the side of the ZS-L-series Sensor Head.



Specifications

Sensor heads

ZS-HL-series sensor heads

Item	ZS-HLDS2T	ZS-HLDS2VT	ZS-HLDS5T	ZS-HLDS10	ZS-HLDS60	ZS-HLDS150
Applicable controllers	ZS-HLDC series					
Optical system	Regular reflection	Diffuse reflection	Regular reflection	Regular reflection	Diffuse reflection	Diffuse reflection
Measuring center distance	20 mm	5.2 mm	25 mm	44 mm	50 mm	94 mm
Measuring range	±1 mm	±1 mm	±2 mm	±4 mm	±5 mm	±16 mm
Light source	Visible semiconductor laser (wavelength: 650 nm, 1 mW max., JIS Clas				Visible semiconductor laser (wavelength 658 nm, 1 mW max., Class 2)	
Beam shape	Line beam					
Beam diameter*1	1.0 mmx20 μm		2.2 mmx45 μm		1.0 mmx30 μm	
Linearity*2	±0.05% F.S.		±0.2 %F.S.		±0.1% F.S.	
Resolution*3	0.25 μm (No. of samples to average: 256)		0.5 μm (No. of samples to average: 128)		0.25 μm (No. of samples to average: 512)	
Temperature characteristic*4	0.01% F.S./°C		0.1% F.S./°C		0.01% F.S./°C	
Sampling cycle	110 μs (high-speed mode), 500 μs (standard mode), 2.2 ms (high-precision mode), 4.4 ms (high-sensitivity mode)					
Indicators	NEAR indicator	Lits near the measurement center, and nearer than the measurement center distance inside the measuring range. Flashes when the measurement target is outside of the measuring range or when the received light amount is insufficient.				
	FAR indicator	Lits near the measurement center, and further than the measurement center distance inside the measuring range. Flashes when the measurement target is outside of the measuring range or when the received light amount is insufficient.				
Operating ambient illumination	Illumination on received light surface 3,000 lx or less (incandescent light)				Illumination on received light surface 1,000 lx or less (incandescent light)	Illumination on received light surface 500 lx or less (incandescent light)
Ambient temperature	Operating: 0 to 50°C, storage: -15 to 60°C (with no icing or condensation)					
Ambient humidity	Operating and storage: 35% to 85% (with no condensation)					
Degree of protection	IP64		IP67		Cable length 0.5 m: IP66, cable length 2 m: IP67	
Vibration resistance (destructive)	10 to 150 Hz, 0.7 mm double amplitude, 80 min each in X, Y, and Z directions					
Shock resistance (destructive)	150 m/s ² 3 times each in six directions (up/down, left/right, forward/backward)					
Materials	Case: aluminum die-cast, front cover: glass					
Cable length	0.5 m, 2 m		2 m		0.5 m, 2 m	
Weight	Approx. 350 g			Approx. 600 g		Approx. 800 g

*1 Defined as 1/e² (13.5%) of the center optical intensity in the measurement center distance. The beam diameter is sometimes influenced by the ambient conditions of the workpiece such as leaked light from the main beam.

*2 This is the error on the measured value with respect to an ideal straight line. Linear curve may change according to the workpiece. The following lists the workpieces

Model	Diffusive reflection	Mirror reflection
ZS-HLDS2T	SUS block	Glass
ZS-HLDS5T/HLDS10	White alumina ceramic	Glass
ZS-HLDS60/HLDS150	White alumina ceramic	-
ZS-HLDS2VT	-	Glass

*3 This is the "peak-to-peak" displacement conversion value of the displacement output in the measurement center distance when high-resolution mode and the average number in the table are set (For ZS-HLDS60, the maximum resolution at 250 mm is also included). The following lists the workpieces.

Model	Diffusive reflection	Mirror reflection
ZS-HLDS2T	SUS block	Glass
ZS-HLDS5T	White alumina ceramic	Glass
ZS-HLDS10	White alumina ceramic	-
ZS-HLDS60/HLDS150	White alumina ceramic	-
ZS-HLDS2VT	-	Glass

*4 Value obtained when the sensor part and object part are fixed with an aluminum jig.

ZS-L-series sensor heads

Item	ZS-LD20T	ZS-LD20ST	ZS-LD40T	ZS-LD10GT	ZS-LD15GT
Applicable controllers	ZS-HLDC/LDC series				
Optical system	Regular reflection	Diffuse reflection	Regular reflection	Diffuse reflection	Regular reflection
Measuring center distance	20 mm	6.3 mm	20 mm	6.3 mm	40 mm
Measuring range	±1 mm	±1 mm	±1 mm	±1 mm	±2.5 mm
Light source	Visible semiconductor laser (wavelength: 650 nm, 1 mW max., JIS Class 2)				
Beam shape	Line beam	Spot beam	Line beam		
Beam diameter ^{*1}	900 x 25 µm	25 µm dia.	2,000 x 35 µm	Approx. 25 x 900 µm	
Linearity ^{*2}	±0.1%F.S.				
Resolution ^{*3}	0.25 µm	0.25 µm	0.4 µm	0.25 µm	0.25 µm
Temperature characteristic ^{*4}	0.04% FS/°C	0.04% FS/°C	0.02% FS/°C	0.04% FS/°C	
Sampling cycle ^{*5}	110 µs (high-speed mode), 500 µs (standard mode), 2.2 ms (high-precision mode), 4.4 ms (high-sensitivity mode)				
Indicators	NEAR indicator	Lights near the measuring center distance, and nearer than the measuring center distance inside the measuring range. Flashes when the measurement target is outside of the measuring range or when the received light amount is insufficient.			
	FAR indicator	Lights near the measuring center distance, and further than the measuring center distance inside the measuring range. Flashes when the measurement target is outside of the measuring range or when the received light amount is insufficient.			
Operating ambient illumination	Illumination on received light surface: 3,000 lx or less (incandescent light)				
Ambient temperature	Operating: 0 to 50°C, storage: -15 to 60°C (with no icing or condensation)				
Ambient humidity	Operating and storage: 35% to 85% (with no condensation)				
Degree of protection	Cable length 0.5 m: IP66, cable length 2 m: IP67				IP40
Materials	Case: Aluminum die-cast, front cover: Glass				
Cable length	0.5 m, 2 m				
Weight	Approx. 350 g				Approx. 400 g
Accessories	Laser labels (1 each for JIS/EN, 3 for FDA), ferrite cores (2), insure Locks (2), instruction sheet				Laser safety labels (1 each for JIS/EN), ferrite cores (2), insure locks (2)

^{*1} Defined as $1/e^2$ (13.5%) of the center optical intensity at the actual measurement center distance (effective value). The beam diameter is sometimes influenced by the ambient conditions of the workpiece, such as leaked light from the main beam.

^{*2} This is the error in the measured value with respect to an ideal straight line. The standard workpiece is white aluminum ceramics in diffuse reflection mode and glass in the regular reflection mode of the ZS-LD20T/40T/50. Linearity may change according to the workpiece.

^{*3} This is the peak-to-peak displacement conversion value in the displacement output at the measuring center distance in high-precision mode when the number of samples to average is set to 128 and the measuring mode is set to the high-resolution mode. The standard workpiece is white aluminum ceramics in diffuse reflection mode and glass in the regular reflection mode.

^{*4} This is the value obtained at the measuring center distance when the Sensor and workpiece are fixed by an aluminum jig.

^{*5} This value is obtained when the measuring mode is set to the high-speed mode.

ZS-L-series sensor heads

Item	ZS-LD50	ZS-LD50S	ZS-LD80	ZS-LD130	ZS-LD200	ZS-LD350S
Applicable controllers	ZS-HLDC/LDC series					
Optical system (reflection)	Diffuse	Regular	Diffuse	Regular	Diffuse	Regular
Measuring center distance	50 mm	47 mm	50 mm	47 mm	80 mm	78 mm
Measuring range	±5 mm	±4 mm	±5 mm	±4 mm	±15 mm	±14 mm
Light source	Visible semiconductor laser (wavelength: 650 nm, 1 mW max., JIS Class 2)					
Beam shape	Line beam	Spot beam	Line beam	Line beam	Line beam	Spot beam
Beam diameter ^{*1}	900 x 60 µm	50 µm dia.	900 x 60 µm	600 x 70 µm	900 x 100 µm	240 µm dia.
Linearity ^{*2}	±0.1%F.S.			±0.25%F.S.	±0.1%F.S.	±0.25%F.S.
Resolution ^{*3}	0.8 µm	0.8 µm	2 µm	3 µm	5 µm	20 µm
Temperature characteristic ^{*4}	0.02% FS/°C	0.02% FS/°C	0.01% FS/°C	0.02% FS/°C	0.02% FS/°C	0.04% FS/°C
Sampling cycle ^{*5}	110 µs (high-speed mode), 500 µs (standard mode), 2.2 ms (high-precision mode), 4.4 ms (high-sensitivity mode)					
Indicators	NEAR indicator	Lights near the measuring center distance, and nearer than the measuring center distance inside the measuring range. Flashes when the measurement target is outside of the measuring range or when the received light amount is insufficient.				
	FAR indicator	Lights near the measuring center distance, and further than the measuring center distance inside the measuring range. Flashes when the measurement target is outside of the measuring range or when the received light amount is insufficient.				
Operating ambient illumination	Illumination on received light surface: 3,000 lx or less (incandescent light)			Illumination on received light surface: 2,000 lx or less (incandescent light)	Illumination on received light surface: 3,000 lx or less (incandescent light)	
Ambient temperature	Operating: 0 to 50°C, storage: -15 to 60°C (with no icing or condensation)					
Ambient humidity	Operating and storage: 35% to 85% (with no condensation)					
Degree of protection	Cable length 0.5 m: IP66, cable length 2 m: IP67					
Materials	Case: Aluminum die-cast, front cover: Glass					
Cable length	0.5 m, 2 m					
Weight	Approx. 350 g					
Accessories	Laser labels (1 each for JIS/EN, 3 for FDA), ferrite cores (2), insure Locks (2), instruction sheet					

^{*1} Defined as $1/e^2$ (13.5%) of the center optical intensity at the actual measurement center distance (effective value). The beam diameter is sometimes influenced by the ambient conditions of the workpiece, such as leaked light from the main beam.

^{*2} This is the error in the measured value with respect to an ideal straight line. The standard workpiece is white aluminum ceramics in diffuse reflection mode and glass in the regular reflection mode of the ZS-LD20T/40T/50. Linearity may change according to the workpiece.

^{*3} This is the peak-to-peak displacement conversion value in the displacement output at the measuring center distance in high-precision mode when the number of samples to average is set to 128 and the measuring mode is set to the high-resolution mode. The standard workpiece is white aluminum ceramics in diffuse reflection mode and glass in the regular reflection mode.

^{*4} This is the value obtained at the measuring center distance when the sensor and workpiece are fixed by an aluminum jig.

^{*5} This value is obtained when the measuring mode is set to the high-speed mode.

Sensor controllers

ZS-HL-series sensor controllers

Item		ZS-HLDC11	ZS-HLDC41
NPN/PNP		NPN	PNP
No. of samples to average		1, 2, 4, 8, 16, 32, 64, 128, 256, 512, 1,024, 2,048, or 4,096	
Number of mounted sensors		1 per sensor controller	
External interface	Connection method		Serial I/O: connector, other: pre-wired (standard cable length: 2 m)
	Serial I/O	USB 2.0	1 port, full speed (12 Mbps max.), MINI-B
		RS-232C	1 port, 115,200 bps. max.
	Output	Judgement output	HIGH/PASS/LOW 3 outputs NPN open collector, 30 VDC, 50 mA max., residual voltage 1.2 V max
Linear output		Selectable from 2 types of output, voltage or current (selected by slide switch on bottom). Voltage output: .10 to 10 V, output impedance: 40 Ω Current output: 4 to 20 mA	
Inputs	Laser OFF, ZERO reset timing, RESET	ON: Short-circuited with 0 V terminal or 1.5 V or less OFF: Open (leakage current: 0.1 mA max.)	ON: Short-circuited to supply voltage or within 1.5 V of supply voltage. OFF: Open (leakage current: 0.1 mA max.)
Functions		Display: Measured value, threshold value, voltage/current, received light amount, and resolution/terminal block output Sensing: Mode, gain, measurement object, head installation Measurement point: Average, peak, bottom, thickness, step, and calculations Filter: Smooth, average, and differentiation Outputs: Scaling, various hold values, and zero reset I/O settings: Linear (focus/correction), judgments (hysteresis and timer), non-measurement, and bank (switching and clear) System: Save, initialization, measurement information display, communications settings, key lock, language, and data load Task: Single task or multitask (up to 4)	
Status indicators		HIGH (orange), PASS (green), LOW (orange), LDON (green), ZERO (green), and ENABLE (green)	
Segment display	Main digital	8-segment red LED, 6 digits	
	Sub-digital	8-segment green LEDs, 6 digits	
LCD		16 digitsx2 rows, color of characters: green, resolution per character: 5x8 pixel matrix	
Setting inputs	Setting keys	Direction keys (UP, DOWN, LEFT, and RIGHT), SET key, ESC key, MENU key, and function keys (1 to 4)	
	Slide switch	Threshold switch (2 states: High/Low), mode switch (3 states: FUN, TEACH, and RUN)	
Power supply voltage		21.6 V to 26.4 VDC (including ripple)	
Current consumption		0.5 A max. (when sensor head is connected)	
Ambient temperature		Operating: 0 to 50°C, storage: -15 to 60°C (with no icing or condensation)	
Ambient humidity		Operating and storage: 35% to 85% (with no condensation)	
Degree of protection		IP20	
Materials		Case: Polycarbonate (PC)	
Weight		Approx. 280 g (excluding packing materials and accessories)	
Accessories		Ferrite core (1), instruction sheet	

ZS-MDC11/MDC41 multi controllers

Basic specifications are the same as those for the sensor controllers. The following points, however, are different.

- (1) Sensor heads cannot be connected.
- (2) A maximum 9 of controllers can be connected. Control link units are required to connect controllers.
- (3) Processing functions between controllers: Math functions

Controller link unit

Connection using the ZS-XCN

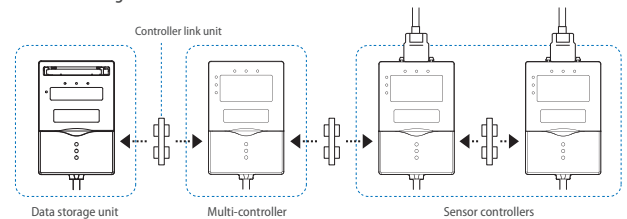

Data storage units

Sensor controllers		Model	ZS-DSU11	ZS-DSU41
Number of mounted sensor heads		Cannot be connected		
Number of connectable controllers		10 controllers max. (ZS-MDC: 1 controller, ZS-HLDC: 9 controllers max.) ^{*1}		
Connectable controllers		ZS-HLDC__, ZS-MDC__		
External interface	Connection method		Serial I/O: connector, other: pre-wired (standard cable length: 2 m)	
	Serial I/O	USB 2.0	1 port, full speed (12 Mbps), MINI-B	
		RS-232C	1 port, 115,200 bps. max.	
	Outputs	3 outputs: HIGH, PASS, and LOW NPN open-collector, 30 VDC, 50 mA max., residual voltage: 1.2 V max.		3 outputs: HIGH, PASS, and LOW PNP open-collector, 50 mA max., residual voltage: 1.2 V max.
Inputs	ON: Short-circuited with 0V terminal or 1.5 V or less OFF: Open (leakage current: 0.1 mA max.)		ON: Short-circuited to supply voltage or within 1.5 V of supply voltage OFF: Open (leakage current: 0.1 mA max.)	
Data resolution		32 bits		
Function ^s	Logging trigger functions		Start and stop triggers can be set separately; external triggers, data triggers (self-triggers), and time triggers	
	Other functions		External banks, alarm outputs, saved data format customization, and clock	
Status indicators		OUT (orange), PWR (green), ACCESS (orange), and ERR (red)		
Segment display		8-segment green LEDs, 6 digits		
LCD		16 digitsx2 rows, color of characters: green, resolution per character: 5x8 pixel matrix		
Setting inputs	Setting keys	Direction keys (UP, DOWN, LEFT, and RIGHT), SET key, ESC key, MENU key, and function keys (1 to 4)		
	Slide switch	Threshold switch (2 states: High/Low), mode switch (3 states: FUN, TEACH, and RUN)		

Sensor controllers	Model	ZS-DSU11	ZS-DSU41
Power supply voltage		21.6 V to 26.4 VDC (including ripple)	
Current consumption		0.5 A max.	
Ambient temperature		Operating: 0 to 50°C, storage: -15 to 60°C (with no icing or condensation)	
Ambient humidity		Operating and storage: 35% to 85% (with no condensation)	
Materials		Case: Polycarbonate (PC)	
Weight		Approx. 280 g (excluding packing materials and accessories)	
Accessories		Ferrite core (1) instruction sheet, tools for data storage unit: CSV file converter for data storage unit, smart analyzer macro edition (Excel macros for analysis of collected data)	

*1 Control link units are required to connect controllers.



Smart, fast and accurate laser measurement sensor

Smart ZX-L-N offers plug & measure technology for applications where high resolution and fast response time is required. A wide range of interchangeable sensor heads provides greater flexibility in solving most demanding applications.

- Small and light sensor heads for easy integration
- High speed response time of 150 μs
- Easy sensor head replacement
- Scalability through a modular platform concept
- Multipoint measurement with up to 5 sensors
- Wide range of sensor heads offering laser beam width from 1 mm to 30 mm

Ordering information

Sensors

Sensor head (reflection type)

Optical method	Beam shape	Sensing distance	Resolution *1	Size in mm (H × W × D)	Order code
Diffuse-reflective	Spot beam	40±10 mm	2 μm	39 × 33 × 17	ZX-LD40
		100±40 mm	16 μm		ZX-LD100
		300±200 mm	300 μm		ZX-LD300
	Line beam	40±10 mm	2 μm		ZX-LD40L
		100±40 mm	16 μm		ZX-LD100L
		300±200 mm	300 μm		ZX-LD300L
Regular reflection type	Spot beam	30±2 mm	0.25 μm	45 × 55 × 25	ZX-LD30V
	Line beam				ZX-LD30VL

*1 At average count of 4,096 times

Sensor head (through-beam)

Optical method	Measurement width	Sensing distance	Resolution *1	Size in mm (H × W × D)		Order code
				Transmitter	Receiver	
Through-beam	1 mm dia.	0 to 2,000 mm	4 μm	15 × 15 × 34	15 × 15 × 19	ZX-LT001
	5 mm	0 to 500 mm				ZX-LT005
	10 mm		12 μm	20 × 20 × 42	20 × 20 × 25	ZX-LT010
	30 mm			64.25 × 70 × 22.6	64.25 × 54 × 22.6	ZX-LT030

*1 At average count of 64 times

Amplifier units

Power supply	Output specifications	Order code
DC	NPN output	ZX-LDA11-N
	PNP output	ZX-LDA41-N

Note: Compatible with sensor head connection.

Accessories (order separately)

Calculating unit

	Order code
Calculating unit	ZX-CAL2

Side-view attachments

Applicable sensor head	Order code
ZX-LT1001/LT005	ZX-XF12
ZX-LT010	ZX-XF22

SmartMonitor sensor setup tool for Personal Computer connection

Name	Order code
ZX-series communications interface unit	ZX-SF11
ZX-series communications interface unit + Setup Software (CD-ROM)	ZX-SFW11EV3*1,*2
ZX-series sensor setup and logging software (CD-ROM)	ZX-SW11EV3*1

*1 When using the ZX-TDA11/41 with the SmartMonitor, either the ZX-SFW11EV3 or the ZX-SW11EV3 SmartMonitor must be used. Earlier versions cannot be used.

*2 The ZX-SFW11EV3 SmartMonitor can be used only to set functions and monitor wave-forms.

Cables with connectors on both ends (for extension)*1

Cable length	Order code
1 m	ZX-XC1A
4 m	ZX-XC4A
8 m	ZX-XC8A
9 m*2	ZX-XC9A

*1. Robot cable models are also available. The model numbers are ZX-XC_R.

*2. For use only with reflective sensors.

Specifications

Sensor head (reflection type)

Item	ZX-LD40	ZX-LD100	ZX-LD300	ZX-LD30V	ZX-LD40L	ZX-LD100L	ZX-LD300L	ZX-LD30VL
Optical method	Diffuse reflection			Regular reflection	Diffuse reflection			Regular reflection
Light source (wave length)	Visible-light semiconductor laser (wavelength 650 nm, 1 mW or less, Class 2)							
Measurement center distance	40 mm	100 mm	300 mm	30 mm	40 mm	100 mm	300 mm	30 mm
Measurement range	±10 mm	±40 mm	±200 mm	±2 mm	±10 mm	±40 mm	±200 mm	±2 mm
Beam shape	Spot			Line				
Beam diameter ^{*1}	50 μm dia.	100 μm dia.	300 μm dia.	75 μm dia.	75 μm×2mm	150 μm×2 mm	450 μm×2 mm	100 μm×1.8 mm
Resolution ^{*2}	2 μm	16 μm	300 μm	0.25 μm	2 μm	16 μm	300 μm	0.25 μm
Linearity ^{*3}	±0.2% F.S. (entire range)	±0.2% F.S. (80 to 121 mm)	±2% F.S. (200 to 401 mm)	±0.2% F.S. (entire range)	±0.2% F.S. (32 to 49 mm)	±0.2% F.S. (80 to 121 mm)	±2% F.S. (200 to 401 mm)	±0.2% F.S. (entire range)
Temperature characteristic ^{*4}	±0.03% FS/°C (except for ZX-LD300 and ZX-LD300L, which are ±0.1% FS/°C.)							
Ambient illumination	Incandescent lamp: 3,000 lx max. (on light receiving side)							
Ambient temperature	Operating: 0 to 50°C, storage: -15 to 60°C (with no icing or condensation)							
Ambient humidity	Operating and storage: 35% to 85% (with no condensation)							
Insulation resistance	20 MΩ min. at 500 VDC							
Dielectric strength	1,000 VAC, 50/60 Hz for 1 min							
Vibration resistance (destruction)	10 to 150 Hz, 0.7-mm double amplitude 80 min each in X, Y, and Z directions							
Shock resistance (destruction)	300 m/s ² 3 times each in six directions (up/down, left/right, forward/backward)							
Protective structure	IEC 60529 IP50			IEC standard IP40	IEC 60529 IP50			IEC standard IP40
Connection method	Connector relay (standard cable length: 500 mm)							
Weight (packed state)	Approx. 150 g			Approx. 250 g	Approx. 150 g			Approx. 250 g
Materials	Case: PBT (polybutylene terephthalate), Cover: Aluminum, lens: Glass			Case and cover: Aluminum, lens: Glass	Case: PBT (polybutylene terephthalate), Cover: Aluminum, lens: Glass			Case and cover: Aluminum, lens: Glass
Accessories	Instruction sheet, Laser warning label (English)							

^{*1} Beam diameter: This is the value of the measurement center distance (actual value), and is defined at 1/e² (13.5%) of the central light intensity. If there is stray light outside, the defined area and the area around the object has a higher reflectance than the object.

^{*2} Resolution: Indicates the amount of fluctuation (±3 δ) in the linear output when connected to the ZX-LDA. (The measured value when the average count of the ZX-LDA is set to 4,096 and our standard object (white ceramic) is used for the central distance.) This indicates the repeatability precision when the work is in a static state, and does indicate the distance precision. The resolution performance may not be satisfactory in a strong electromagnetic field.

^{*3} Linearity: This indicates the error with respect to the ideal straight line of the displacement output when measuring our standard object.

^{*4} Temperature characteristic: The temperature characteristic is measured at the measurement point with the sensor and reference object (Omron's standard reference object) secured with an aluminum jig.

Note: Highly reflective objects can result in incorrect detection by causing out-of-range measurements.

Sensor head (through-beam)

Item	ZX-LT001	ZX-LT005	ZX-LT010	ZX-LT030
Optical method	Through-beam			
Light source (wave length)	Visible-light semiconductor laser (wavelength 650 nm, 1 mW or less, Class 1)			
Maximum output	0.2 mW max.		0.2 mW max.	
Measurement width	1 mm dia.	1 to 2.5 mm dia.	5 mm	10 mm
Sensing distance	0 to 500 mm	500 to 2,000 mm	0 to 500 mm	
Min. sensing object	8 mm dia. opaque object	8 to 50 μm opaque object	opaque: 0.05 mm dia.	opaque: 0.1 mm dia. opaque: 0.3 mm dia.
Resolution ^{*1}	4 μm ^{*2}	–	4 μm ^{*3}	
Temperature characteristic	±0.2% FS/°C			±0.3% FS/°C
Ambient illumination	Incandescent lamp: 10,000 lx max. (on light-receiving side)			
Ambient temperature	Operating: 0 to 50°C, storage: -25 to 70°C (with no icing or condensation)			
Ambient humidity	Operating: 35% to 85% (with no condensation)			
Protective structure	IEC 60529 IP40			IP 40
Connection method	Connector relay (standard cable length: 500 mm)			
Weight (packed state)	Approx. 220 g			Approx. 450 g
Cable length	Extendable up to 10 m with special extension cable.			
Materials	Case	Polyetherimide		Zinc die-cast
	Cover	Polycarbonate		
	Front filter	Glass		
Tightening torque	0.3 Nm max.			
Accessories	Instruction sheet, sensor head-amplifier connection cable			
	Optical axis adjustment seal			Mounting Bracket

^{*1} The amount of fluctuation (±3 δ) of the linear output when connected to an amplifier unit, converted to a detection span.

^{*2} When the average count is 64. 5 μm when the count is 32. The value when the smallest detection object shades the vicinity of the center of the 1 mm dia. detection span.

^{*3} When the average count is 64. 5 μm when the count is 32.

^{*4} For an average count of 64. The value is 15 μm for an average count of 32.

Amplifier units

Item	ZX-LDA11-N	ZX-LDA41-N
Measurement period	150 μs	
Possible average count settings*1	1, 2, 4, 8, 16, 32, 64, 128, 256, 512, 1,024, 2,048, or 4,096	
Temperature characteristic	When connected to a reflective sensor head: 0.01% FS/°C, when connected to a through-beam sensor head: 0.1% FS/°C	
Linear output*2	4 to 20 mA/FS, max. load resistance: 300 Ω, ±4 V (±5 V, 1 to 5 V*3), output impedance: 100 Ω	
Judgement outputs (3 outputs: HIGH/PASS/LOW)*1	NPN open-collector outputs, 30 VDC, 50 mA max. Residual voltage: 1.2 V max.	PNP open-collector outputs, 30 VDC, 50 mA max. Residual voltage: 2 V max.
Laser OFF input, zero reset input, timing input, reset input	ON: Short-circuited with 0-V terminal or 1.5 V or less OFF: Open (leakage current: 0.1 mA max.)	ON: Supply voltage short-circuited or supply voltage within 1.5 V OFF: Open (leakage current: 0.1 mA max.)
Functions	Measurement value display, present value/set value/light level/resolution display, scaling, display reverse, display OFF mode, ECO mode, number of display digit changes, sample hold, peak hold, bottom hold, peak-to-peak hold, self-peak hold, self-bottom hold, average hold, delay hold, intensity mode, zero reset, initial reset, ON-delay timer, OFF-delay timer, one-shot timer, deviation, previous value comparison, sensitivity adjustment, keep/clamp switch, direct threshold value setting, position teaching, 2-point teaching, automatic teaching, hysteresis width setting, timing inputs, reset input, monitor focus, linear output compensation, (A-B) calculations*4, (A+B) calculations*4, mutual interference*4, laser deterioration detection, zero reset memory, zero reset display, key lock	
Indications	Operation indicators: High (orange), pass (green), low (yellow), 7-segment main display (red), 7-segment subdisplay (yellow), laser ON (green), zero reset (green), enable (green)	
Power supply voltage	12 to 24 VDC±10%, Ripple (p-p): 10% max.	
Current consumption	140 mA max. with power supply voltage of 24 VDC (with sensor connected)	
Ambient temperature	Operating: 0 to 50°C, storage: -15 to 60°C (with no icing or condensation)	
Ambient humidity	Operating and storage: 35% to 85% (with no condensation)	
Insulation resistance	20 MΩ min. at 500 VDC	
Dielectric strength	1,000 VAC, 50/60 Hz for 1 min	
Vibration resistance (destruction)	10 to 150 Hz, 0.7-mm double amplitude 80 min each in X, Y, and Z directions	
Shock resistance (destruction)	300 m/s ² 3 times each in six directions (up/down, left/right, forward/backward)	
Connection method	Prewired (standard cable length: 2 m)	
Weight (packed state)	Approx. 350 g	
Materials	Case: PBT (polybutylene terephthalate), cover: Polycarbonate	
Accessories	Instruction sheet	

*1 The response speed of the linear output is calculated as the measurement period x (average count setting + 1) (with fixed sensitivity).

The response speed of the judgement outputs is calculated as the measurement period x (average count setting + 1) (with fixed sensitivity).

*2 The output can be switched between a current output and voltage output using a switch on the bottom of the amplifier unit.

*3 Setting is possible via the monitor focus function.

*4 A calculating unit (ZX-CAL2) is required.

Calculating unit

Item	ZX-CAL2
Applicable amplifier units	ZX-LDA11-N/41-N/ZX-EDA11/41/ZX-TDA11/41
Current consumption	12 mA max. (supplied from the smart sensor amplifier unit)
Ambient temperature	Operating: 0 to 50°C, storage: -15 to 60°C (with no icing or condensation)
Ambient humidity	Operating and storage: 35% to 85% (with no condensation)
Connection method	Connector
Dielectric strength	1,000 VAC, 50/60 Hz for 1 min
Insulation resistance	100 MΩ (at 500 VDC)
Vibration resistance (destructive)	10 to 150 Hz, 0.7-mm double amplitude 80 min each in X, Y, and Z directions
Shock resistance (destructive)	300 m/s ² 3 times each in six directions (up/down, left/right, forward/backward)
Materials	Display: Acrylic, case: ABS resin
Weight (packed state)	Approx. 50 g

ZX-series Communications Interface Unit

Item	ZX-SF11	
Current consumption	60 mA max. (supplied by the amplifier unit)	
Applicable amplifier units	ZX series	
Applicable amplifier unit versions	ZX-LDA_1-N Ver. 1.000 or higher ZX-EDA_1 Ver. 1.100 or higher ZX-TDA_1 Ver. 1.000 or higher	
Max. No. of amplifier units	5	
Communications functions	Communications port	RS-232C port (9-pin D-Sub connector)
	Communications protocol	CompoWay/F*1
	Baud rate	38,400 bps
	Data configuration	Data bits: 8, parity: none, start bits: 1, stop bits: 1, flow control: none
Indicators	Power supply: green, sensor communications: green, sensor communications error: red, external terminal communications: green, external terminal communications error: red	
Protective circuits	Reverse polarity protection	
Ambient temperature	Operating: 0 to 50°C, storage: -15 to 60°C (with no icing or condensation)	
Ambient humidity	Operating and storage: 35% to 85% (with no condensation)	
Insulation resistance	20 MΩ min. (at 500 VDC)	
Dielectric strength	1,000 VAC, 50/60 Hz for 1 min, Leakage current: 10 mA max.	
Materials	Case: PBT (polybutylene terephthalate), cover: Polycarbonate	
Accessories	Instruction sheet, 2 clamps	

*1 Contact your Omron representative for CompoWay/F communications specifications.



Ultra-compact, lightweight sensor measures any material

The ZW confocal fiber displacement sensor delivers stable, non-contact, in-line measurement of heights, thicknesses and other dimensions. It solves the problems of traditional laser triangulation sensors: deviation between different material and inclination tolerance. The compact sensing head has no electronic parts to eliminate problems of installation space and mutual interference, electrical/magnetic noise, temperature rise and mechanical positioning.

- Minimum resolution: 0.01 μm
- Ultra-compact sensing head: 24 × 24 mm; weighs only 105 g
- High flexibility robotic cable from sensor to controller, extends 32 m
- Mount sensing head one time: no need to re-tune for changing materials
- Separate amplifier provides white LED light source, spectroscope and processor to convert reflected color light to distance
- Automation Software Sysmac Studio simplifies system operation and setting

Ordering information

Sensor heads

Type	Measuring range	Spot diameter	Static resolution	Order code*1
Straight type	7±0.3 mm	18 μm dia.	0.01 μm ⁺² /0.25 μm	ZW-S07
	20±1 mm	40 μm dia.	0.02 μm ⁺² /0.25 μm	ZW-S20
	30±3 mm	60 μm dia.	0.06 μm ⁺² /0.25 μm	ZW-S30
	40±6 mm	80 μm dia.	0.08 μm ⁺² /0.25 μm	ZW-S40
Right-angle type	7±0.3 mm	18 μm dia.	0.25 μm	ZW-SR07
	20±1 mm	40 μm dia.	0.25 μm	ZW-SR20
	40±6 mm	80 μm dia.	0.25 μm	ZW-SR40

*1 When ordering, specify the cable length (0.3 m, 2.0 m).

*2 The high resolution types are subject to the export control restrictions

Controller with EtherCAT

Power supply	Output type	Order code
24 VDC	NPN	ZW-CE10T/ZW-C10*1
	PNP	ZW-CE15T/ZW-C15*1

*1 The high resolution types are subject to the export control restrictions

Note: Controllers with binary outputs are also available (ZW-C10T/-C15T). Please contact your OMRON sales representative for details.

Cable

Item	Cable length	Order code
Sensor Head - Controller Extension Fiber Cable (flexible cable) (Fiber Adapter ZW-XFC provided)	2 m	ZW-XF02R
	5 m	ZW-XF05R
	10 m	ZW-XF10R
	20 m	ZW-XF20R
	30 m	ZW-XF30R
Fiber Adapter (between Sensor Head pre-wired cable and Extension Fiber Cable)	-	ZW-XFC
Parallel cable for ZW-CE1□ 32-pole*1	2 m	ZW-XCP2E
RS-232C Cable for personal computer	2 m	ZW-XRS2
RS-232C Cable for PLC/programmable terminal	2 m	ZW-XPT2

*1 A parallel cable for Controllers with binary outputs is also available (ZW-XCP2). Please contact your OMRON sales representative for details.

Automation Software Sysmac Studio

Please purchase a DVD and required number of licenses the first time you purchase the Sysmac Studio. DVDs and licenses are available individually. Each model of licenses does not include any DVD.

Product name	Specifications	Order code		
		Number of licenses	Media	
Sysmac Studio Standard Edition Ver.1.□□*1	The Sysmac Studio provides an integrated development environment to set up, program, debug, and maintain NJ-series controllers and other machine automation controllers, as well as EtherCAT slaves. Sysmac Studio runs on the following OS. Windows XP (Service Pack 3 or higher, 32-bit version)/Vista (32-bit version)/7 (32-bit/64-bit version) This software provides functions of the Measurement Sensor Edition. Refer to Sysmac Catalog (P072) for details such as supported models and functions.	- (Media only)	DVD	SYSMAC-SE200D
		1 license*2	-	SYSMAC-SE201L
Sysmac Studio Measurement Sensor Edition Ver.1.□□*3	Sysmac Studio Measurement Sensor Edition is a limited license that provides selected functions required for ZW-series Displacement Sensor settings. Because this product is a license only, you need the Sysmac Standard Edition DVD media to install it.	1 license	-	SYSMAC-ME001L
		3 licenses	-	SYSMAC-ME003L

*1 ZW-series is supported by Sysmac Studio version 1.05 or higher.

*2 Multi licenses are available for the Sysmac Studio (3, 10, 30, or 50 licenses).

*3 Setting Software Smart Monitor ZW is also available (ZW-SW101). Please contact your OMRON representative for details.

Setting software

Item	Order code
Smart Monitor ZW	ZW-SW101

Accessories

Item	Order code
Fiber Connector Cleaner	ZW-XCL

Recommended EtherCAT communications cables

Use Straight STP (shielded twisted-pair) cable of category 5 or higher with double shielding (braiding and aluminum foil tape) for EtherCAT.

Cable with connectors

Item	Recommended manufacturer	Cable length (m) ^{*1}	Order code
Standard type Cable with connectors on both ends (RJ45/RJ45) Wire gauge and number of pairs: AWG27, 4-pair Cable Cable Sheath material: LSZH ^{*2} Cable color: Yellow ^{*3}	OMRON	0.3	XS6W-6LSZH85S30CM-Y
		0.5	XS6W-6LSZH85S50CM-Y
		1	XS6W-6LSZH85S100CM-Y
		2	XS6W-6LSZH85S200CM-Y
		3	XS6W-6LSZH85S300CM-Y
Rugged type Cable with connectors on both ends (RJ45/RJ45) Wire gauge and number of pairs: AWG22, 2-pair cable	OMRON	0.3	XS5W-T421-AMD-K
		0.5	XS5W-T421-BMD-K
		1	XS5W-T421-CMD-K
		2	XS5W-T421-DMD-K
		5	XS5W-T421-GMD-K
Rugged type Cable with connectors on both ends (M12 Straight/RJ45) Wire gauge and number of pairs: AWG22, 2-pair cable	OMRON	0.3	XS5W-T421-AMC-K
		0.5	XS5W-T421-BMC-K
		1	XS5W-T421-CMC-K
		2	XS5W-T421-DMC-K
		5	XS5W-T421-GMC-K
Rugged type Cable with connectors on both ends (M12 Right-angle/RJ45) Wire gauge and number of pairs: AWG22, 2-pair cable	OMRON	0.3	XS5W-T422-AMC-K
		0.5	XS5W-T422-BMC-K
		1	XS5W-T422-CMC-K
		2	XS5W-T422-DMC-K
		5	XS5W-T422-GMC-K
		10	XS5W-T421-JMD-K
		10	XS5W-T421-JMC-K
		10	XS5W-T422-JMC-K
		10	XS5W-T422-JMC-K
		10	XS5W-T422-JMC-K

^{*1} Standard type cables length 0.2, 0.3, 0.5, 1, 1.5, 2, 3, 5, 7.5, 10, 15 and 20m are available.

Rugged type cables length 0.3, 0.5, 1, 2, 3, 5, 10 and 15m are available.

^{*2} The lineup features Low Smoke Zero Halogen cables for in-cabinet use and PUR cables for out-of-cabinet use.

^{*3} Cables colors are available in blue, yellow, or Green

Note: For details, refer to Cat.No.G019.

Cables/connectors

Wire gauge and number of pairs: AWG24, 4-pair cable

Item	Recommended manufacturer	Order code
Cables	Hitachi Cable, Ltd.	NETSTAR-CSE SAB 0.5 × 4P ^{*1}
	Kuramo Electric Co.	KETH-SB ^{*1}
	SWCC Showa Cable Systems Co.	FAE-5004 ^{*1}
RJ45 connectors	Panduit Corporation	MP5588-C ^{*1}

^{*1} We recommend you to use above cable and connector together.

Wire gauge and number of pairs: AWG22, 2-pair cable

Item	Recommended manufacturer	Order code
Cables	Kuramo Electric Co.	KETH-PSB-OMR ^{*1}
	Nihon Electric Wire&Cable Co.,Ltd.	PNET/B ^{*1}
RJ45 Assembly connector	OMRON	XS6G-T421-1 ^{*1}

^{*1} We recommend you to use above cable and connector together.

Note: Connect both ends of cable shielded wires to the connector hoods.

Industrial switching hubs for Ethernet

Number of ports	Failure detection	Current consumption	Order code
3	None	0.22 A	W4S1-03B
5	None	0.22 A	W4S1-05B
	Supported		W4S1-05C

Note: Industrial switching hubs are cannot be used for EtherCAT.

EtherCAT junction slaves

Number of ports	Power supply voltage	Current consumption	Order code
3	20.4 to 28.8 VDC	0.08 A	GX-JC03
6	(24 VDC –15 to 20%)	0.17 A	GX-JC06

- Note: 1 Please do not connect EtherCAT junction slave with OMRON position control unit, Model CJ1W-NC_81/_82.
2 EtherCAT junction slaves cannot be used for EtherNet/IP™ and Ethernet.

Specifications

Sensor head

Item	ZW-S07	ZW-S20	ZW-S30	ZW-S40	ZW-SR07	ZW-SR20	ZW-SR40
Measuring center distance	7 mm	20 mm	30 mm	40 mm	7 mm	20 mm	40 mm
Measuring range	±0.3 mm	±1 mm	±3 mm	±6 mm	±0.3 mm	±1 mm	±6 mm
Static resolution ^{*1}	0.25 μm	0.25 μm	0.25 μm	0.25 μm	0.25 μm	0.25 μm	0.25 μm
Linearity ^{*2}	±0.8 μm	±1.2 μm	±4.5 μm	±7.0 μm	±1.1 μm	±1.6 μm	±9.3 μm
Spot diameter ^{*3}	Near	20 μm dia.	45 μm dia.	70 μm dia.	90 μm dia.	20 μm dia.	45 μm dia.
	Center	18 μm dia.	40 μm dia.	60 μm dia.	80 μm dia.	18 μm dia.	40 μm dia.
	Far	20 μm dia.	45 μm dia.	70 μm dia.	90 μm dia.	20 μm dia.	45 μm dia.
Measuring cycle	500 μs to 10 ms						
Operating ambient illumination	Illumination on object surface 10,000 lx or less: incandescent light						
Ambient temperature range	Operating: 0 to 50°C, Storage: -15 to 60°C (with no icing or condensation)						
Ambient humidity range	Operating and storage: 35% to 85% (with no condensation)						
Degree of protection	IP40 (IEC60529)						
Vibration resistance (destructive)	10 to 150 Hz, 0.35 mm single amplitude, 80 min each in X, Y, and Z directions						
Shock resistance (destructive)	150 m/s ² 3 times each in six directions (up/down, left/right, forward/backward)						
Temperature characteristic ^{*4}	0.6 μm/°C (0.45 μm/°C)	1.5 μm/°C (1.0 μm/°C)	2.8 μm/°C (2.0 μm/°C)	4.8 μm/°C (3.8 μm/°C)	0.6 μm/°C (0.45 μm/°C)	1.5 μm/°C (1.0 μm/°C)	4.8 μm/°C (3.8 μm/°C)
Materials	Case: aluminum die-cast Fiber cable sheat: PVC Calibration ROM: PC						
Fiber cable length	0.3 m, 2 m (Flex-resistant cable)						
Fiber cable minimum bending radius	20 mm						
Insulation resistance (Calibration ROM)	Between case and all terminals: 20 MΩ (by 250 V megger)						
Dielectric strength (Calibration ROM)	Between case and all terminals: 1,000 VAC, 50/60 Hz, 1 min						
Weight	Approx. 105 g (Chassis, fiber cable total)						
Accessories included with sensor head	Instruction sheet, Fixing screw (M2) for Calibration ROM, Precautions for correct use						

^{*1}. Capacity value when Omron standard mirror surface target is measured at the measurement center distance as the average of 4,096 times.

^{*2}. Material setting for the Omron standard mirror surface target: Error from an ideal straight line when measuring on mirror surface.
The reference values for linearity when targets to measure other than the above are as in the table below

Item	ZW-S07	ZW-S20	ZW-S30	ZW-S40	ZW-SR07	ZW-SR20	ZW-SR40
Glass	±1.0 μm	±1.2 μm	±4.5 μm	±7.0 μm	±1.1 μm	±1.6 μm	±9.3 μm
SUS BA	±1.2 μm	±1.4 μm	±5.5 μm	±8.5 μm	±1.2 μm	±1.8 μm	±9.3 μm
White ceramic	±1.6 μm	±1.7 μm	±6.4 μm	±9.5 μm	±1.6 μm	±1.9 μm	±11.0 μm

^{*3}. Capacity value defined by 1/e² (13.5%) of the center optical intensity in the measured area.

^{*4}. Temperature characteristic at the measurement center distance when the sensor head and the target are fastened with an aluminum jig and the sensor head and the controller are set in the same temperature environment.

Figures in parentheses are converted value obtained by subtracting the effect of expansion or contraction of the aluminum jig itself.

Automation software Sysmac Studio

System requirements

Item	Condition
Operating system (OS) ^{*1, *2}	Windows XP (Service Pack 3 or higher, 32-bit version)/Vista(32-bit version)/7(32-bit/64-bit version)
CPU	Windows computers with Celeron 540 (1.8 GHz) or faster CPU. Core i5 M520 (2.4 GHz) or equivalent or faster recommended
Main memory	2 GB min.
Recommended video memory/video card for using 3D motion trace	Video memory: 512 MB min. Video card: Either of the following video cards: • NVIDIA GeForce 200 Series or higher • ATI RadeonHD5000 Series or higher
Hard disk	At least 1.6 GB of available space
Display	XGA 1024 × 768, 16 million colors. WXGA 1280 × 800 min. recommended
Disk drive	DVD-ROM drive
Communication ports	USB port corresponded to USB 2.0, or Ethernet port ^{*3}
Supported languages	Japanese, English, German, French, Italian, Spanish, simplified Chinese, traditional Chinese, Korean

^{*1} Sysmac Studio operating system precaution: System requirements and hard disk space may vary with the system environment.

^{*2} The following restrictions apply when Sysmac Studio is used with Microsoft Windows Vista or Windows 7.

Some Help files cannot be accessed.

The Help files can be accessed if the Help program distributed by Microsoft for Windows (WinHlp32.exe) is installed. Refer to the Microsoft homepage listed below or contact Microsoft for details on installing the file. (The download page is automatically displayed if the Help files are opened while the user is connected to the Internet.)

<http://support.microsoft.com/kb/917607/en-us>

^{*3} Refer to the hardware manual for your Controller for hardware connection methods and cables to connect the computer and Controller.

Setting software Smart Monitor ZW ZW-SW101

System requirements

Item	Condition
Operating System(OS)	Windows 7 (32 or 64-bit version) Windows XP (Service Pack3 or more, 32-bit version)
CPU	Intel Pentium III, 850 MHz or more (2 GHz or more is recommended.)
Main memory	1 GB or more
Hard disk	50 MB or more
Display	1024 × 768 dots or more, 16 million colors or more
Supported languages	Japanese/English
Communication port	Ethernet port

Controller

Item	ZW-CE10T	ZW-CE15T	
Input/Output type	NPN	PNP	
Number of connected sensor heads	1 per Controller		
Sensor head compatibility	Available		
Light source for measurement	White LED		
Segment display	Main display	11-segment red display, 6 digits	
	Sub-display	11-segment green display, 6 digits	
LED display	Status indicators	HIGH (orange), PASS (green), LOW (orange), STABILITY (green), ZERO (green), ENABLE (green), THRESHOLD-H (orange), THRESHOLD-L (orange), RUN (green)	
	EtherCAT indicators	L/A IN (Link Activity IN) (green), L/O OUT (Link Activity OUT) (green), ECAT RUN (green), ECAT ERR (red)	
External interface	Ethernet	100BASE-TX, 10BASE-T, No-protocol communications (TCP/UDP), EtherNet/IP™	
	EtherCAT	EtherCAT-specific protocol 100BASE-TX	
	RS-232C	115,200 bps max.	
	Analog output terminal block	Analog voltage output (OUT1V)	-10 to 10 V, output impedance: 100 Ω
		Analog current output (OUT1A)	4 to 20 mA, maximum load resistance: 300 Ω
	32-pole extension connector	Judgment output (HIGH1/PASS1/LOW1)	Transistor output system Output voltage: 21.6 to 30 VDC
		BUSY output (BUSY1)	Load current: 50 mA or less
		ALARM output (ALARM1)	Residual voltage when turning ON: 1.2 V or less
		ENABLE output (ENABLE)	Leakage voltage when turning OFF: 0.1 mA or less
		LED OFF input (LED OFF1)	DC input system
ZERO RESET input (ZERO)		Input voltage: 24 VDC -10% (21.6 to 26.4 VDC)	
TIMING output (TIMING1)		Input current: 7 mA Typ. (24 VDC)	
RESET output (RESET1)		Voltage/Current when turning ON: 19 V/3 mA or more Voltage/Current when turning OFF: 5 V/1 mA or less	
Bank	Selected bank output (BANK_OUT 1 to 3)	Transistor output system Output voltage: 21.6 to 30 VDC Load current: 50 mA or less Residual voltage when turning ON: 1.2 V or less Leakage voltage when turning OFF: 0.1 mA or less	
	Selected bank input (BANK_SEL 1 to 3)	DC input system Input voltage: 21.6 to 26 VDC Input current: 7 mA Typ. (24 VDC) Voltage/Current when turning ON: 19 V/3 mA or more Voltage/Current when turning OFF: 5 V/1 mA or less	
Main functions	Exposure time	Auto/Manual	
	Measuring cycle	500 μs to 10 ms	
	Material setting	Standard/Mirror/Diffusion surfaces	
	Measurement Item	Height/Thickness/Calculation	
	Filtering	Median/Average/Differentiation/High pass/Low pass/Band pass	
	Outputs	Scaling/Different holds/Zero reset/Logging for a measured value	
	Display	Measured value/Threshold value/Analog output voltage or current value/Judgment result/Resolution/Exposure time	
	Number of configurable banks	Max. 8 banks	
	Task process	Multi-task (up to 4 tasks per bank)	
	System	Save/Initialization/Display measurement information/Communication settings/Sensor Head calibration/Key-lock/Trigger-key input	
Ratings	Power supply voltage	21.6 to 26.4 VDC (including ripple)	
	Current consumption	600 mA max.	
	Insulation resistance	Across all lead wires and controller case: 20 MΩ (by 250 V megger)	
	Dialectic strength	Across all lead wires and controller case: 1,000 VAC, 50/60 Hz, 1 min.	
Environmental	Degree of protection	IP20 (IEC60529)	
	Vibration resistance (destructive)	10 to 55 Hz, 0.35-mm single amplitude, 50 min each in X, Y, and Z directions	
	Shock resistance (destructive)	150 m/s ² , 3 times each in six directions (up/down, left/right, forward/backward)	
	Ambient temperature	Operating: 0 to 40°C Storage: -15 to 60°C (with no icing or condensation)	
	Ambient humidity	Operating and storage: 35% to 85% (with no condensation)	
Grounding	D-type grounding (Grounding resistance of 100 Ω or less) Note: For conventional Class D grounding		
Materials	Case: PC		

Item	ZW-CE10T	ZW-CE15T
Weight	Approx. 750 g (main unit only), approx. 150 g (Parallel cable)	
Accessories included with controller	Instruction sheet, Member registration sheet, Parallel cable ZW-XCP2E	

Note: Controllers with binary outputs are also available (ZW-C10T/-C15T). Please contact your OMRON sales representative for details.

ZW series EtherCAT communications specifications

Item	Specification
Communications standard	IEC61158 Type12
Physical layer	100BASE-TX (IEEE802.3)
Connectors	RJ45 × 2 ECAT IN: EtherCAT input ECAT OUT: EtherCAT output
Communications media	Category 5 or higher (cable with double, aluminum tape and braided shielding) is recommended.
Communications distance	Distance between nodes: 100 m max.
Process data	Variable PDO mapping
Mailbox (CoE)	Emergency messages, SDO requests, SDO responses, and SDO information
Distributed clock	Synchronization in DC mode.
LED display	L/A IN (Link/Activity IN) × 1, AL/A OUT (Link/Activity OUT) × 1, AECAT RUN × 1, AECAT ERR × 1



Smart inductive measurement sensor

ZX-E offers the best solution for the accurate measurement of metallic objects. It is highly recommended in harsh environments such as automotive and metal working machines.

- High resolution of 1 μm
- High-speed response time of 150 μs
- Easy sensor head replacement
- Modular platform concept for different sensing technologies
- Easy linearity adjustment for any metal

Ordering information

Sensors

Sensor heads

Shape	Dimensions	Sensing distance	Resolution*1	Order code
Cylindrical	3 dia. × 18 mm	0.5 mm	1 μm	ZX-EDR5T
	5.4 dia. × 18 mm	1 mm		ZX-ED01T*2
	8 dia. × 22 mm	2 mm		ZX-ED02T*2
Screw-shaped	M10×22 mm	2 mm		ZX-EM02T*2
	M18×46.3 mm	7 mm		ZX-EM07MT*2
Flat	30×14×4.8 mm	4 mm		ZX-EV04T*2,*3
Heat-resistant, cylindrical	M12×22 mm	2 mm	ZX-EM02HT*4	

*1 For an average count of 4,096.

*2 Models with protective spiral tubes are also available. Add a suffix of “-S” to the above model numbers when ordering. (Example: ZX-ED01T-S)

*3 Be sure to use ZX-EDA amplifier unit version 1,200 or later with the ZX-EV04.

*4 Be sure to use ZX-EDA amplifier unit version 1,300 or later with the ZX-EM02H.

Amplifier units

Power supply	Output type	Order code
DC	NPN	ZX-EDA11
	PNP	ZX-EDA41

Note: Compatible connection with the sensor head.

Accessories (order separately)

Calculating unit

	Model
Calculating unit	ZX-CAL2

Amplifier mounting brackets

Remarks	Model
Attached to each sensor head	ZX-XBE1
For DIN track mounting	ZX-XBE2

SmartMonitor sensor setup tool for Personal Computer connection

Name	Model
ZX-series communications interface unit	ZX-SF11
ZX-series communications interface unit + setup software (CD-ROM)	ZX-SFW11EV3*1
ZX-series sensor setup and logging software (CD-ROM)	ZX-SW11EV3

*1 The ZX-SFW11EV3 SmartMonitor can be used only to set functions and monitor waveforms.

Cables with connectors on both ends (for extension)*

Cable length	Model
1 m	ZX-XC1A
4 m	ZX-XC4A
8 m	ZX-XC8A

* Robot cable models are also available. The model numbers are ZX-XC_R.

Specifications

Sensor heads

Item	ZX-EDR5T	ZX-ED01T	ZX-ED02T/EM02T	ZX-EM07MT	ZX-EV04T	ZX-EM02HT
Measurement range	0 to 0.5 mm	0 to 1 mm	0 to 2 mm	0 to 7 mm	0 to 4 mm	0 to 2 mm
Sensing object	Magnetic metals (Measurement ranges and linearities are different for non-magnetic metals. Refer to engineering data on B-67.)					
Standard reference object	18 × 18 × 3 mm		30 × 30 × 3 mm	60 × 60 × 3 mm		45 × 45 × 3 mm
	Material: Ferrous (S50C)					
Resolution*1	1 μm					
Linearity*2	±0.5% F.S.					±1% F.S.*3
Linear output range	Same as measurement range.					
Temperature characteristic*4 (including amplifier unit)	0.15% F.S./°C		0.07% F.S./°C		0.1% F.S./°C	
Ambient temperature	Operating*5		-10 to 60°C (with no icing or condensation)		-10 to 200°C	
	Storage*5		-20 to 70°C (with no icing or condensation)		-20 to 200°C	

Item	ZX-EDR5T	ZX-ED01T	ZX-ED02T/EM02T	ZX-EM07MT	ZX-EV04T	ZX-EM02HT
Ambient humidity	Operating and storage: 35% to 85% (with no condensation)					
Insulation resistance	50 MΩ min. (at 500 DC)					
Dielectric strength	1,000 VAC, 50/60 Hz for 1 min between charged parts and case					
Vibration resistance (destruction)	10 to 55 Hz with 1.5-mm double amplitude for 2 h each in X, Y, and Z directions					
Shock resistance (destruction)	500 m/s ² , 3 times each in X, Y, and Z directions					
Degree of protection (sensor head)	IEC60529, IP65	IEC60529, IP67				IEC60529, IP60 ^{*6}
Connection method	Connector relay (standard cable length: 2 m)					
Weight (packed state)	Approx. 120 g	Approx. 140 g		Approx. 160 g	Approx. 130 g	Approx. 160 g
Materials	Sensor head	Brass	Stainless steel	Brass		Zinc (nickel-plated)
	Case	Heat-resistant ABS				
	Sensing surface					PEEK
Preamplifier	PES					
Accessories	Amplifier mounting brackets (ZX-XBE1), instruction manual					

^{*1} Accuracy: The resolution is the deviation ($\pm 3\sigma$) in the linear output when connected to the ZX-EDA amplifier unit. The above values indicate the deviations observed 30 minutes after the power is turned ON.

(The resolution is measured with Omron's standard reference object at 1/2 of the measurement range with the ZX-EDA set for the maximum average count of 4,096 per period.) The resolution is given at the repeat accuracy for a stationary workpiece, and is not an indication of the distance accuracy. The resolution may be adversely affected under strong electromagnetic fields.

^{*2} Linearity: The linearity is given as the error in an ideal straight line displacement output when measuring the standard reference object. The linearity and measurement values vary with the object being measured.

^{*3} The value given is for an ambient temperature of 25°C.

^{*4} Temperature characteristic: The temperature characteristic is measured with Omron's standard reference object at 1/2 of the measurement range.

^{*5} The ambient temperature given is only for the sensor head. It is -10 to 60°C for the preamp.

^{*6} Do not use in moist environments because the case is not waterproof.

Amplifier units

Item	ZX-EDA11	ZX-EDA41
Measurement period	150 μs	
Possible average count settings ^{*1}	1, 2, 4, 8, 16, 32, 64, 128, 256, 512, 1,024, 2,048, or 4,096	
Linear output ^{*2}	Current output: 4 to 20 mA/F.S., max. load resistance: 300 Ω Voltage output: ±4 V (±5 V, 1 to 5 V ^{*3}), output impedance: 100 Ω	
Judgement outputs (3 outputs: HIGH/PASS/LOW)	NPN open-collector outputs, 30 VDC, 50 mA max. Residual voltage: 1.2 V max.	PNP open-collector outputs, 30 VDC, 50 mA max. Residual voltage: 2 V max.
Zero reset input, timing input, reset input, judgement output hold input	ON:Short-circuited with 0-V terminal or 1.5 V or less OFF:Open (leakage current: 0.1 mA max.)	ON:Supply voltage short-circuited or supply voltage within 1.5 V OFF:Open (leakage current: 0.1 mA max.)
Function	<ul style="list-style-type: none"> - Measurement value display - Linearity adjustment (materials selection) - Display reverse - Number of display digit changes - Bottom hold, peak-to-peak hold - Average hold - Initial reset - OFF-delay timer - Non-measurement setting - Automatic teaching - Reset input - Linear output correction - K-(A+B) calculation^{*4} - Sensor disconnection detection - Key lock 	<ul style="list-style-type: none"> - set value/output value/ resolution display - display OFF mode - sample hold - self-peak hold - delay hold - linearity initialization - one-shot timer - direct threshold value setting - hysteresis width setting - judgement output hold input - (A-B) calculations^{*4} - mutual interference prevention^{*4} - zero reset memory
Indications	Judgement indicators: High (orange), pass (green), low (yellow), 7-segment main digital display (red), 7-segment sub-digital display (yellow), power ON (green), zero reset (green), enable (green)	
Voltage influence (including sensor)	0.5% F.S. of linear output value at ±20% of power supply voltage	
Power supply voltage	12 to 24 VDC±10%, ripple (p-p): 10% max.	
Current consumption	140 mA max. with power supply voltage of 24 VDC (with sensor connected)	
Ambient temperature	Operating and storage: 0 to 50°C (with no icing or condensation)	
Ambient humidity	Operating and storage: 35% to 85% (with no condensation)	
Insulation resistance	20 MΩ min. (at 500 DC)	
Dielectric strength	1,000 VAC, 50/60 Hz for 1 min	
Vibration resistance (destruction)	10 to 150 Hz with 0.7-mm double amplitude for 80 min each in X, Y, and Z directions	
Shock resistance (destruction)	300 m/s ² , 3 times each in 6 directions (up, down, left, right, forward, backward)	
Connection method	Prewired (standard cable length: 2 m)	
Weight (packed state)	Approx. 350 g	
Materials	Case: PBT (polybutylene terephthalate), cover: Polycarbonate	
Accessories	Instruction manual	

^{*1} The response speed of the linear output is calculated as the measurement period x (average count setting + 1) (with fixed sensitivity).

The response speed of the judgement outputs is calculated as the measurement period x (average count setting + 1) (with fixed sensitivity).

^{*2} The output can be switched between a current output and voltage output using a switch on the bottom of the amplifier unit.

^{*3} Setting is possible via the monitor focus function.

^{*4} A calculating unit (ZX-CAL or ZX-CAL2) is required.



Smart contact measurement sensor

ZX-T is ideal for applications where the target object may contain oil deposits or other micro-structures. In this case contact measurement is the most reliable way.

- Modular platform concept for different sensing technologies
- Air-retracting types for automated inspection
- Multipoint measurement with up to 8 sensors
- Pressing force alarm prevents malfunction
- Strong ball bearing structure assures long life time

Ordering information

Sensors

Sensor heads

Size	Type	Sensing distance	Resolution (See note.)	Order code
6 dia.	Short type	1 mm	0.1 μm	ZX-TDS01T
	Standard type	4 mm		ZX-TDS04T
	Low-load type			ZX-TDS04T-L
8 dia.	Standard type	10 mm	0.4 μm	ZX-TDS10T
	Ultra-low-load type			ZX-TDS10T-L
	Air lift type			ZX-TDS10T-V
	Air lift/air push type			ZX-TDS10T-VL

Note: The resolution refers to the minimum value that can be read when a ZX-TDA_1 amplifier unit is connected.

Amplifier units

Power supply	Output type	Order code
DC	NPN	ZX-TDA11
	PNP	ZX-TDA41

Accessories (order separately)

Calculating unit

	Order code
Calculating unit	ZX-CAL2

SmartMonitor sensor setup tool for Personal Computer connection

Name	Order code
ZX-series communications interface unit	ZX-SF11
ZX-series communications interface unit + setup software (CD-ROM)	ZX-SFW11EV3 ^{*1,*2}
ZX-series sensor setup and logging software (CD-ROM)	ZX-SW11EV3 ^{*1}

^{*1} When using the ZX-TDA11/41 with the SmartMonitor, either the ZX-SFW11EV3 or the ZX-SW11EV3 SmartMonitor must be used. Earlier versions cannot be used.

^{*2} The ZX-SFW11EV3 SmartMonitor can be used only to set functions and monitor waveforms.

ZX-series communications interface unit

Name	Order code
ZX-series communications interface unit	ZX-SF11

Cables with connectors on both ends (for extension)*





Cable length	Order code
1 m	ZX-XC1A
4 m	ZX-XC4A
8 m	ZX-XC8A





* Robot cable models are also available. The model numbers are ZX-XC_R.

Preamplifier mounting brackets

Remarks	Order code
Attached to each sensor head	ZX-XBT1
For DIN track mounting	ZX-XBT2

Actuators

Type (material)	Screw section	Appearance	Application	Applicable sensor (see note.) ZX-TDS_T	Order code
Ball type (steel)	Female screw M2.5x0.45		Measuring ordinary flat surfaces (standard actuator supplied with the ZX-TDS series)	○	D55N-TB1
Ball type (carbide steel)	Female screw M2.5x0.45		Measurements where abrasion resistance is critical Measured objects: Carbide (HR90) or lower.	○	D55N-TB2
Ball type (ruby)	Female screw M2.5x0.45		Measurements where abrasion resistance is critical Measured objects: Carbide (HR90) or higher.	○	D55N-TB3
Needle type (carbide steel)	Male screw M2.5x0.45		Measuring the bottom of grooves and holes	△	D55N-TN1

Type (material)	Screw section	Appearance	Application	Applicable sensor (see note.) ZX-TDS_T	Order code
Flat (carbide steel)	Male screw M2.5x0.45		Measuring spherical objects		D5SN-TF1
Conversion adapter (stainless steel)	Through-hole female screw M2.5x0.45		Mounting D5SN-TN1/-TF1 or commercially available actuators on ZX-TDS-series sensors		D5SN-TA

Note: ○ Replacement possible △ Conversion adapter required

Specifications

Amplifier units

Item	ZX-TDA11	ZX-TDA41
Measurement period	1 ms	
Possible average count settings ^{*1}	1, 16, 32, 64, 128, 256, 512, or 1,024	
Linear output ^{*2}	Current output: 4 to 20 mA/F.S., max. load resistance: 300 Ω Voltage output: ±4 V (±5 V, 1 to 5 V ³), output impedance: 100 Ω	
Judgement outputs (3 outputs: HIGH/PASS/LOW)	NPN open-collector outputs, 30 VDC, 30 mA max. Residual voltage: 1.2 V max.	PNP open-collector outputs, 30 VDC, 30 mA max. Residual voltage: 2 V max.
Zero reset input, timing input, reset input, judgement output hold input	ON: Short-circuited with 0-V terminal or 1.5 V or less OFF: Open (leakage current: 0.1 mA max.)	ON: Supply voltage short-circuited or supply voltage of 1.5 V or less OFF: Open (leakage current: 0.1 mA max.)
Function	<ul style="list-style-type: none"> – Measurement value display – Display reverse – Sample hold – Self-peak hold – Initial reset – Hysteresis width setting – Judgement output hold input – (A+B) calculations (see note 4.) – Zero reset memory – Clamp value setting – Span adjustment 	<ul style="list-style-type: none"> – present value/set value/output value display – ECO mode – peak hold – self-bottom hold – direct threshold value setting – timing inputs – monitor focus – sensor disconnection detection – function lock – scale inversion – warming-up display – number of display digit changes – bottom hold, peak-to-peak hold – zero reset – position teaching – reset input – (A-B) calculations^{*4} – non-measurement setting – zero reset indicator – pressing force alarm
Indicators	Judgement indicators: High (orange), pass (green), low (yellow), 7-segment main digital display (red), 7-segment sub-digital display (yellow), power ON (green), zero reset (green), enable (green)	
Power supply voltage	12 to 24 VDC±10%, ripple (p-p): 10% max.	
Current consumption	140 mA max. (with sensor connected), for 24-VDC power supply voltage: 140 mA max. (with sensor connected)	
Ambient temperature	Operating and storage: 0 to 50°C (with no icing or condensation)	
Temperature characteristic	0.03% F.S./°C	
Connection method	Prewired (standard cable length: 2 m)	
Weight (packed state)	Approx. 350 g	
Materials	Case: PBT (polybutylene terephthalate), cover: Polycarbonate	

^{*1} The response speed of the linear output is calculated as the measurement period x (average count setting + 1).

The response speed of the judgement outputs is calculated as the measurement period x (average count setting + 1).

^{*2} The output can be switched between a current output and voltage output using a switch on the bottom of the amplifier unit.

^{*3} Setting is possible via the monitor focus function.

^{*4} A calculating unit (ZX-CAL2) is required.

Sensor heads

Item	ZX-TDS01T	ZX-TDS04T	ZX-TDS04T-L
Measurement range	1 mm	4 mm	
Maximum actuator travel distance	Approx. 1.5 mm	Approx. 5 mm	
Resolution ^{*1}	0.1 μm		
Linearity ^{*2}	±0.3% F.S.		
Operating force ^{*3}	Approx. 0.7 N		Approx. 0.25 N
Degree of protection (sensor head)	IEC60529, IP67		IEC60529, IP54
Mechanical durability	10,000,000 operations min.		
Ambient temperature	Operating: 0 to 50°C, storage: -15 to 60°C (with no icing or condensation)		
Ambient humidity	Operating and storage: 35% to 85% (with no icing or condensation)		
Temperature characteristic ^{*4}	Sensor head	0.03% F.S./°C	
	Preamplifier	0.01% F.S./°C	
Weight (packed state)	Approx. 100 g		
Materials	Sensor head	Stainless steel	
	Preamplifier	Polycarbonate	
Accessories	Instruction manual, preamplifier mounting brackets (ZX-XBT1)		

^{*1} The resolution is given as the minimum value that can be read when a ZX-TDA_1 amplifier unit is connected. This value is taken 15 minutes after turning ON the power with the average number of operations set to 256.

^{*2} The linearity is given as the error in an ideal straight line displacement output.

^{*3} These figures are representative values that apply for the measurement mid-point, and are for when the provided actuator is used, with the actuator moving downwards. If the actuator moves horizontally or upwards, the operating force will be reduced. Also, if an actuator other than the standard one is used, the operating force will vary with the weight of the actuator itself.

^{*4} These figures are representative values that apply for the mid-point of the measurement range.



Easy profile measurement – “teach&go”

The ZG2 enables precise shape measurement on challenging materials and surfaces. An easy and intuitive user interface enables efficient installation, setup and operation. A built-in LCD monitor indicates the measurement result in real time.

- Easy to use – intuitive user interface
- Live – built-in LCD monitor for setup and immediate profile display
- Versatile – 18 measurement tools
- Accurate – 5 µm resolution (3 mm / 631 pixels)
- Wide profiles – up to 70 mm

Ordering information

Sensor heads

Optical method	Sensing distance		Resolution		Order code
	Height direction	Width direction	Height direction	Width direction	
Diffuse reflective	210±48 mm	70 mm	6 µm	111 µm	ZG2-WDS70
Diffuse reflective	100±12 mm	22 mm	2.5 µm	35 µm	ZG2-WDS22
Diffuse reflective	50±3 mm	8 mm	1 µm	13 µm	ZG2-WDS8T
Regular reflective	22.3±0.5 mm	3 mm	0.25 µm	5 µm	ZG2-WDS3VT

Note: - For details, refer the ratings and specifications table.
- Designate the cable length (0.5 m, 2 m) when ordering.

Sensor controllers

Power supply	Output type	Order code
24 VDC	NPN	ZG2-WDC11A*1
	PNP	ZG2-WDC41A

*1 Setup support software for PC is attached

Accessories (order separately)

Real-time parallel output unit

Output type	Order code
NPN	ZG-RPD11
PNP	ZG-RPD41

RS-232C cable

Connecting device	Order code
For personal computer connection (2 m)	ZS-XRS2
For PLC/PT connection (2 m)	ZS-XPT2

Sensor head extension cable

Name	Order code
3 m extension cable	ZG2-XC3CR
8 m extension cable	ZG2-XC8CR
15 m extension cable	ZG2-XC15CR
25 m extension cable	ZG2-XC25CR
Digital equalizer (relay device)	ZG2-XEQ
0.2 m digital equalizer connection cable	ZG2-XC02D

Parallel mounting adaptor

	Order code
For 1 unit	ZS-XPM1
For 2 units or more	ZS-XPM2

Controller link unit

Item	Order code
Controller link unit	ZS-XCN

Memory card

Capacity	Order code
128 MB	F160-N1285
256 MB	F160-N2565

Specifications

Sensor heads

Item	ZG2-WDS70	ZG2-WDS22	ZG2-WDS8T	ZG2-WDS3VT	
Optical system	Diffuse reflective	Diffuse reflective	Regular reflective	Regular reflective	
Measurement range	Height direction	210±48 mm (In the high-precision mode)	100±12 mm	94±10 mm	
	Width direction (typical)	70 mm	22 mm	8 mm	
Resolution	Height direction ^{*1}	6 µm	2.5 µm	1 µm	
	Width direction	111 µm (70 mm/631 pixels)	35 µm (22 mm/631 pixels)	13 µm (8 mm/631 pixels)	
Linearity (in the height direction) ^{*2}	±0.1% F.S.				
Temperature characteristic ^{*3}	0.02% F.S./°C		0.03% F.S./°C	0.08% F.S./°C	
Light source	Type	Visible semiconductor laser			
	Wavelength	658 nm		650 nm	
	Output	5 mW max. output, 1 mW max. exposure (without using optical instruments)			1 mW max.
	Laser class	Class 2M of EN60825-1 / IEC60825-1 Class III B of FDA (21CFR 1040.10 and 1040.11)		Class 2 of EN60825-1 / IEC60825-1 Class II of FDA (21CFR 1040.10 and 1040.11)	
Beam shape (at measurement center distance) ^{*4}	120 µm × 75 mm (typical)	60 µm × 45 mm (typical)	30 µm × 24 mm (typical)	25 µm × 4 mm (typical)	
LED	STANDBY: Lights when laser irradiation preparation is complete (indication color: green)				
	LD_ON: Lights when the laser is irradiating (indication color: green)				
Measurement object	Surface of non-transparent objects	Surface of non-transparent/transparent objects			
Environmental resistance	Ambient light intensity	Illumination on the photo-receiving face 7,000 lx max.: Incandescent lamp			
	Ambient temperature	Operating: 0 to 50°C, Storage: -15 to 60°C (with no icing or condensation)			
	Ambient humidity	Operating and storage: 35% to 85% (with no condensation)			
	Degree of protection	IP66 (IEC60529)		IP67 (IEC60529)	
	Vibration resistance (destruction)	10 to 150 Hz with 0.35 mm single amplitude for 80 min each in X, Y, and Z directions			
Shock resistance (destruction)	150 m/s ² , 3 times each in 6 directions (up / down, right / left, forward / backward)				
Materials	Case: Aluminum diecast, Front cover: Glass, Cable insulation : Heat-resistive polyvinyl chloride (PVC), Connector: Zinc alloy or brass				
Cable length	0.5 m, 2 m (flexible cable)				
Weight	Approx. 650 g	Approx. 500 g		Approx. 300 g	
Accessories	Laser labels (EN : 2 labels, FDA : 3 labels), Ferrite core (1), Instruction manual				

^{*1} Obtained by setting an Omron standard measurement object at the measurement center distance and determining the average height of the beam line. The conditions are given in the table below. However, satisfactory resolution cannot be attained in strong electromagnetic fields. The minimum resolution of the ZG2-WDS8T/WDS3VT is 0.25 fEm, even when the average number of operations is increased. Resolution does not go any lower.

Model	CCD Mode	Average No. of operations	Measurement object	
			Regular reflective	Diffuse reflective
ZG2-WDS70/WDS22/WDS8T	Standard mode	64	Omron standard white alumina ceramic object	
ZG2-WDS3VT	Standard mode		Omron standard mirrored object	Omron standard diffuse reflective object

^{*2} The tolerance for an ideal straight line obtained by determining the average height of an Omron standard measurement object for the beam line. The CCD high-resolution mode is used. Linearity varies depending on the measurement object.

Model	Measurement object	
	Regular reflective	Diffuse reflective
ZG2-WDS70/WDS22/WDS8T	Omron standard white alumina ceramic object	
ZG2-WDS3VT	Omron standard mirrored object	Omron standard diffuse reflective object

^{*3} A value attained by using an aluminum jig to secure the distance between the Sensor head and the measurement object. The CCD standard mode is used.

^{*4} Defined as $1/e^2$ (13.5%) of the center light intensity. This may be influenced when light leakage also exists outside the defined area and the reflectivity of the light around the measurement object is higher than that of the measurement object.

Sensor controllers

Item		ZG2-WDC11/WDC11A	ZG2-WDC41/WDC41A
Input/output type		NPN	PNP
No. of connectable Sensor Heads		1 per Controller	
No. of connectable Controllers		2	
Measurement cycle ^{*1}		16 ms (high-precision mode), 8 ms (standard mode), 5 ms (high-speed mode)	
Min. display unit		10 nm	
Display range		-999.99999 to 999.99999	
Display	LCD monitor	1.8-inch TFT color LCD (557x234 pixels)	
	LEDs	<ul style="list-style-type: none"> Judgment indicators for each task (indication color: orange): T1, T2, T3, T4 Laser indicator (indication color: green): LD_ON Zero reset indicator (indication color: green): ZERO Trigger indicators (indication color: green): TRIG 	
External interface	Input/output signal lines	Analog outputs	Select voltage or current (using the sliding switch on the bottom surface) <ul style="list-style-type: none"> Voltage output: 10 to 10 V, output impedance: 40 Ω Current output: 4 to 20 mA, maximum load resistance: 300 Ω
		Judgment output (ALL-PASSING/ERROR)	NPN open collector 30 VDC, 50 mA max.
		Trigger auxiliary output (ENABLE/GATE)	Residual voltage: 1.2 V max.
		Laser stop input (LD-OFF)	ON: 0 V short or 1.5 V max.
		Zero reset input (ZERO)	OFF: Open (leakage current: 0.1 mA max.)
		Measurement trigger input (TRIG)	
	Bank switching input (BANK A, B)		
	Serial I/O	USB2.0	1 port, full speed (12 Mbps), MINI-B
		RS-232C	1 port, 115,200 bps max.
	Parall output ^{*2}	Output	18 - terminal
Main functions	No. of settings banks	16	
	Sensitivity adjustment	Multi, High-speed multi, Auto, Fixed	
	Measurement items	Height, 2-point Step, 3-point Step, Edge position, Edge width, Angle, Intersection coordinates, Intersection angle, Sectional area (up to eight items can be measured simultaneously)	
	Auxiliary functions	Filter, Laser power adjustment, Position correction (height, position, lope), Linked operation, Point of inflection measurement	
	Profiles saved	16 profiles (1 profile per bank)	
	Trigger modes	External trigger/continuous	
Ratings	Power supply voltage	21.6 to 26.4 VDC (including ripple current)	
	Current consumption	0.8 A max. (per sensor head)	
	Insulation resistance	20 MΩ at 250 V between lead wires and Controller case	
	Dielectric strength	1,000 VAC, 50 / 60 Hz for 1 min between lead wires and Controller case	
Environmental resistance	Ambient temperature	Operating: 0 to 50°C, Storage: -15 to 60°C (with no icing or condensation)	
	Ambient humidity	Operating and storage: 35% to 85% (with no condensation)	
	Degree of protection	IP20 (IEC 60529)	
	Vibration resistance (destruction)	Vibration frequency: 10 to 150 Hz, single amplitude: 0.35 mm, acceleration: 50 m/s ²	
	Shock resistance (destruction)	150 m/s ² , 3 times each in 6 directions (up/down, right/left, forward/backward)	
Material	Case: Polycarbonate (PC), Cable insulation : Heat-resistive polyvinyl chloride (PCV)		
Cable length	2 m		
Weight	Approx. 300 g (including cable) (Packed state: Approx. 450 g)		
Accessories	ZG2-WDC_1: Large Ferrite Core (1 piece), Instruction Manual ZG2-WDC_1A: Large Ferrite Core (1 piece), Small Ferrite Core (2 pieces), Instruction Manual, Setup Support Software (CD-ROM), USB cable (1 m)		

^{*1} The image input periods listed here are for fixed/auto sensitivity. The image input period will be longer for multi-sensitivity, high-speed multi-sensitivity, or other settings. When the high-power mode is ON, the shortest image input period is 95 ms regardless of the setting of the CCD mode. Use the eco monitor in the RUN mode to determine the actual image input period.

^{*2} when ZG-RPD is mounted

Data storage unit

Item		ZG2-DSU11	ZG2-DSU41
Input/output type		NPN	PNP
No. of connectable Controllers		2 ^{*1}	
Connectable controllers			
External interface	Input/output signal lines	Inputting starting/terminating logging	ON: 0 V short or 1.5 V max. OFF: Open (leakage current : 0.1 mA max.)
		Judgment output (HIGH/PASS/LOW/ERROR)	NPN open collector 30 VDC, 50 mA max. Residual voltage : 1.2 V max.
	Serial I/O	USB2.0	1 port, full speed (12 Mbps), MINI-B
		RS-232C	1 port, 115,200 bps max.
Functions	No. of logged data ^{*2}	Memory of the main unit	Profiles saved: 5,120 profiles Measurement values saved: 65,000 values max. ^{*3}
		Memory card (256 MB) ^{*4}	Profiles saved: 35,328 profiles max. (256 profiles x 138 files) Measurement values saved: 7,150,000 values max. (65,000 values x 110 files)
	Logging trigger functions		External triggers, data triggers (self-triggers), and time triggers
	External banks functions		4096
	Other functions		Alarm output functions
Ratings	Power supply voltage	21.6 to 26.4 VDC (including ripple current)	
	Current consumption	0.5 A max.	
Environmental resistance	Ambient temperature	Operating: 0 to 50°C, Storage: 0 to 60°C (with no icing or condensation)	
	Ambient humidity	Operating and storage: 35% to 85% (with no condensation)	
Material		Case : Polycarbonate (PC)	
Cable length		2 m	
Weight		Approx. 280 g	
Accessories		Ferrite Core (1 piece), Instruction Manual	

^{*1} The controller link unit is necessary for linking.

^{*2} Data is saved in the memory of the main unit during logging. The data is automatically saved in a memory card after logging is completed. The maximum number of logging differs according to set conditions. For details, refer to the Users Manual.

^{*3} Measurement values for 65,000 measurements can be saved even when two sensor controllers are connected and each performs eight tasks.

^{*4} The value is the maximum number achieved in the following conditions:

- One sensor controller performs one measurement task.
- Either profiles or measurement values are logged.

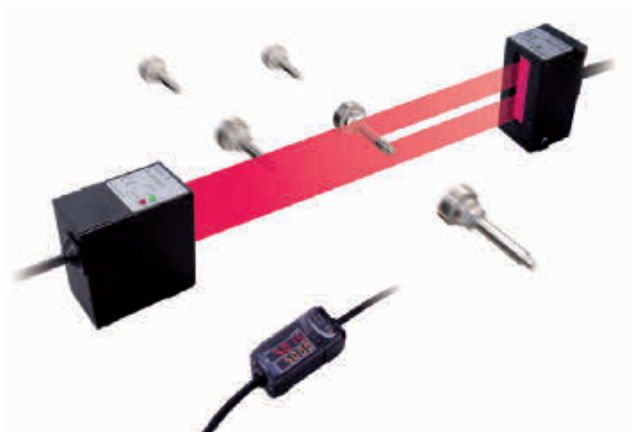

Smart laser micrometer

- High accuracy: 5 to 10 μm
- All surfaces
- Long sensing distance: < 500 mm
- Line width up to 28 mm
- Calculation unit for multiple heads
- Fast sampling time: 0.5 ms
- PC software for setup

Ordering information

Sensors

Type	Optical system	Measuring width	Sensing distance	Resolution	Output type	Order code
Separate type	Through-beam	28 mm	0 to 500 mm	10 μm	NPN	ZX-GT28S11
Integrated type			40 mm		PNP	ZX-GT28S41
					NPN	ZX-GT2840S11
					PNP	ZX-GT2840S41

Controller

Power supply	Output type	Order code
DC	NPN	ZX-GTC11
	PNP	ZX-GTC41

Accessories (order separately)

Set of interface unit and setup software PCs

Output type	Order code
NPN	ZX-GIF11A
PNP	ZX-GIF41A

Interface unit(RS-232C/binary output)

Power supply	Output type	Order code
DC	NPN	ZX-GIF11
	PNP	ZX-GIF41

Setup software PCs

Name	Order code
Smart monitor GT	ZX-GSW11

Calculating units

	Order code
Calculating unit	ZX-CAL2

Receiver-controller extension cable

Cable length	Quantity	Order code	
		Standard cable	Flexible cable
1 m	1 m	ZX-XGC1A	ZX-XGC1R
2 m		ZX-XGC2A	ZX-XGC2R
5 m		ZX-XGC5A	ZX-XGC5R
8 m		ZX-XGC8A	ZX-XGC8R
20 m		ZX-XGC20A	ZX-XGC20R

Up to two extension cables can be connected. However, be sure to limit the total extension cable length between the receiver and the controller to 30 meters (including the receiver cable).

Specifications

Sensor				
Item	ZX-GT28S11	ZX-GT2840S11	ZX-GT28S41	ZX-GT2840S41
Output type	NPN		PNP	
Appearance	Separate type	Integrated type	Separate type	Integrated type
Light source	Visible semiconductor laser diode (wavelength 650 nm, CLASS 1 of EN60825-1/IEC60825-1, CLASS of FDA(21CFR 1040.10 and 1040.11)			
Measuring width	28 mm			
Sensing distance	0 to 500 mm	40 mm	0 to 500 mm	40 mm
Minimum sensing object	0.5 mm dia.* ¹	0.2 mm dia.	0.5 mm dia.* ¹	0.2 mm dia.
Linearity	±0.1% F.S.* ²			
Resolution	10 μm (number of process values to average: 16) ^{*3}			
Temperature characteristic	±0.01% F.S./C ^{*4}			
Indicators (emitter)	Laser ON indicator (green), laser alarm indicator (red)			
Indicator (receiver)	Optical axis setting indicator (green)			
Laser OFF input/sync input	ON: Short-circuited with 0 V or 1.5 V max. OFF: Open (leakage current: 0.1 mA max.)		ON: Short-circuited with power supply voltage or power supply voltage -1.5 V max. OFF: Open (leakage current: 0.1 mA max.)	
Laser deterioration alarm output	NPN open-collector output 30 VDC 20 mA max. Residual voltage 1.2 V max.		PNP open-collector output 30 VDC 20 mA max. Residual voltage 2 V max.	
Power consumption (emitter)	30 mA max.			
Power supply voltage (emitter)	24 VDC+10%, -15% ripple (p-p) 10% max.			
Dielectric strength	1,000 VAC, 50/60 Hz for 1 min			
Insulation resistance	20 MΩ (at 500 VDC megger)			
Operating ambient illumination (emitter)	3,000 lx (incandescent light)			
Operating ambient illumination (receiver)	1,000 lx (incandescent light) ^{*5}			
Ambient temperature	Operating: 0 to 40°C, storage: -15 to 50°C (with no icing or condensation)			
Ambient humidity	Operating and storage: 35% to 85% (with no condensation)			
Vibration resistance (durability)	10 to 150 Hz single-amplitude: 0.75 mm for 80 min each in X, Y and Z directions			
Degree of protection	IEC60529 IP40			
Cable length	2 m			
Material	Case: aluminum die-cast, Lens: glass			
Weight (packed state)	Approx. 550 g	Approx. 570 g	Approx. 550 g	Approx. 570 g
Accessories	Laser warning labels, instruction sheet			

F.S.: 28 mm measuring range of receiver

*¹ Distance between emitter and receiver: 500 mm, measurement object at 250 mm from receiver. Glass ends of chamfer 0.1 mm or more can be detected in glass edge measurement mode. (at binary level 70%)

*² Linearity is given to be a typical error with respect to an ideal straight line when the distance between the emitter and receiver is 100 mm and light is blocked at a distance of 50 mm from the receiver. (On the ZX-GT2840_, the measurement object is measured at a distance of 20 mm from the receiver.)

*³ The amount of fluctuation (±3 σ) in the analog output when the distance between the emitter and receiver is 100 mm and a ZX-GTC_ is connected

*⁴ Change in the light cutoff value on one side when the distance between the emitter and receiver is 100 mm and the light is half-cutoff at a distance of 50 mm from the receiver (On the ZX-GT2840_, the measurement object is measured at a distance of 20 mm from the receiver.)

*⁵ Standard mode (NORM) used

Controller

Item		ZX-GTC11	ZX-GTC41
Output type		NPN	PNP
Measurement cycle* ¹		1.5 ms (standard mode (NORM)) 0.5 ms (high-speed mode (FAST)) ^{*2}	
Samples to average		1/2/4/8/16/32/64/128/256/512/1024/2048/4096	
Analog output* ³		For current output: 4 to 20 mA/F.S., max. load resistance 300 Ω For voltage output: ±4 V, (±5 V, 1 to 5 V ^{*4}), output impedance 100 Ω	
Timing input, bank switching input, zero reset input, reset input		ON: short-circuited with 0 V or 1.5 V max. OFF: Open (leakage current: 0.1 mA max.)	ON: short-circuited with power supply voltage or power supply voltage -1.5 V max. OFF: Open (leakage current: 0.1 mA max.)
HIGH/PASS/LOW Judgment output* ⁵ Sync output* ⁶		NPN open-collector output 30 VDC 50 mA max. Residual voltage 1.2 V max.	PNP open-collector output 30 VDC 50 mA max. Residual voltage 2 V max.
Indicator		Judgment output indicator: HIGH (orange), PASS (green), LOW (orange) Main display (red) sub-display (yellow) bank 1/2 (orange), zero reset (green)	
Main functions	Number of registered setups	2 banks	
	Measurement mode	Interrupted beam width measurement, incident beam width measurement, outer diameter measurement, center position measurement, IC lead pitch, IC lead width judgment, specified edge measurement, wire position measurement, glass edge position measurement	
	Display during measurement	Measured value, resolution, threshold, voltage output value, current output value (number of display digits can be changed)	
	Zero reset functions	Offset setting of zero reset value, zero reset value memory	
	Hold	Sample hold, peak hold, bottom hold, peak-to-peak hold, average hold, delay hold	
	Timer functions	ON-delay, OFF-delay, one-shot	
	Adjustment functions	Optical axis adjust mode/light intensity writing mode, variable binary level, variable edge filter, analog output scaling	
	Calculation	2 possible on up to two controllers (calculation Unit ZX-CAL2 is required for connecting controllers to each other.) A-B, A+B, width	
Other		Measurement cycle setting, threshold setting, hysteresis setting, initialization, key lock	

Item	ZX-GTC11	ZX-GTC41
Temperature characteristic	±0.005% F.S./°C	
Current consumption	150 mA max. (including receiver)	
Power supply voltage	24 VDC+10%, -15% ripple (p-p) 10% max.	
Dielectric strength	1,000 VAC, 50/60 Hz for min	
Insulation resistance	20 MΩ (at 500 VDC megger)	
Ambient temperature	Operating: 0 to 50°C, storage: -15 to 60°C (with no icing or condensation)	
Ambient humidity	Operating and storage: 35% to 85% (with no condensation)	
Vibration resistance(durability)	10 to 150 Hz single-amplitude: 0.35 mm for 80 min each in X, Y and Z directions	
Degree of protection	IEC60529 IP20	
Cable length	2 m	
Material	Case: PBT (polybutylene terephthalate), cover: Polycarbonate	
Weight (packed state)	Approx. 330 g	
Accessories	Instruction sheet	

*1 The first response time is "measurement cycle x (number of samples to average setting + 1) + 1 ms" max. For the second response time onwards, the specified measurement cycle time is output.

*2 The response time in the high-speed mode (FAST) for the IC lead pitch and IC lead width judgment modes is 1 ms.

*3 Current/voltage can be switched using the switch provided on the rear of the Controller.

*4 Can be set by the analog output scaling function.

*5 The error (ERR) state is displayed when all HIGH/PASS/LOW outputs turn OFF.

*6 Normally, wire the sync output wire directly to the emitter's sync input wire and run the controller in the standard mode. On an NPN type controller, use an NPN type emitter, and on a PNP type controller, use a PNP type emitter. Wiring of the sync wires is not required when the controller is run in the high-speed mode.

(Note, however, that the controller becomes more susceptible to the influence of ambient light in this case.)

Interface unit

Item	ZX-GIF11/-GIF11A	ZX-GIF41/-GIF41A
Compatible controller	ZX-GTC11	ZX-GTC41
Indicator	Power ON (green), controller communications (orange), controller communications error (red), RS-232C communications (orange), RS-232C communications error (red), binary output (orange)	
Communications port	RS-232C (9-pin D-sub connector)	
12-bit binary output (D11 to D0, GATE)	NPN open-collector output 30 VDC 20 mA max. Residual voltage 1.2 V max.	PNP open-collector output 30 VDC 20 mA max. Residual voltage 2 V max.
Power supply voltage	Supplied from controller (power consumption: 60 mA max.)	
Dielectric strength	1,000 VAC, 50/60 Hz for 1 min	
Insulation resistance	20 MΩ (at 500 VDC megger)	
Ambient temperature	Operating: 0 to 50°C, storage: -15 to 60°C (with no icing or condensation)	
Ambient humidity	Operating and storage: 35% to 85% (with no condensation)	
Vibration resistance(durability)	10 to 150 Hz single-amplitude: 0.35 mm for 80 min each in X, Y and Z directions	
Degree of protection	IEC60529 IP20	
Cable length	RS-232C 0.5 m, binary output 2 m	
Material	Case: PBT (polybutylene terephthalate), cover: Polycarbonate	
Weight (packed state)	ZX-GIF_1A: Approx. 550 g ZX-GIF_1: Approx. 330 g	
Accessories	ZX-GIF_1A: Setup software (CD-ROM), 2 clamps, instruction sheet ZX-GIF_1: 2 clamps, instruction sheet	

Safety

Find information fast!

Quick Links shortens your search. Quick Links are unique codes assigned to Omron products listed in this guide. Enter Quick Link codes in the search box on industrial.omron.eu to access detailed information on products in this guide.

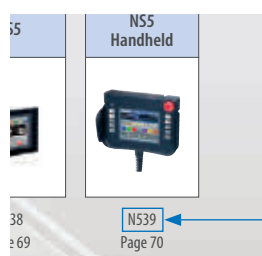

Quick Link

Safety

Control- and Signalling devices

Product overview	402
Selection table	404
Standard pushbutton switches	
A16	406
A22	409
Emergency stop pushbutton switches	
A165E	408
A22E	411
Rope pull emergency stop switches	
ER-series rope pulls	412
Signalling devices	
LU5	415
LU7	419
MP/MPS	422
LME	424

Safety limit switches

Product overview	426
Selection table	428
Safety limit switch with metal housing	
D4B	429
Safety limit switch with plastic housing	
D4N	431
Safety door hinge switch	
D4NH	433
Safety limit switch with manual reset	
D4N-_R.....	427

Safety door switches

Product overview	434
Selection table	436
Non-contact switches	
F3S-TGR-N_C	439
F3S-TGR-N_R	442
F3S-TGR-N_M/-N_U	445
F3S-TGR-S_A/-S_D	447
F3S-TGR-N_X	450
Safety door switches	
D4NS	452
D4BS	453
F3S-TGR-KM15/-KM16/-KH16	454
Guard-lock safety door switch	
D4NL	456
D4GL	457
D4SL-N	458
F3S-TGR-KHL1	460
F3S-TGR-KHL3	461
Compact non-contact door switch/flexible safety unit	
D40A/G9SX-NS.....	434

Safety sensors

Product overview	462
Selection table	464
Type 4 safety light curtain	
F3SJ-E	466
F3SJ-B	470
F3SJ-A	474
Type 4/2 safety light curtain	
MS4800/2800	480
F3S-TGR-CL	482
F3S-TGRCL_-K_	463
F3S-TGRCL_-K_C.....	463
Muting actuators	
F39-TGR-MCL	487
Single-beam safety sensor in compact housing	
E3FS	488
Safety laser scanner	
OS32C	489

Safety control systems

Product overview	492
Selection table	494
Expandable safety relay unit	
G9SA	496
Slim-size safety unit	
G9SB	497
Safety relays	
G9SR	498
Flexible safety unit	
G9SX	499
Safety guard switching unit	
G9SX-GS/A4EG	500
Limited speed monitoring unit	
G9SX-LM	502
Standstill monitoring unit	
G9SX-SM	504
Relays with forcibly guided contacts	
G7SA	505
G7S_-E	506
Standalone safety controller	
G9SP-N_	507
Compact non-contact door switch/flexible safety unit	
G9SX-NS.....	493
Safety network controller	
NE1A-SCPU_.....	493
DeviceNet safety I/O terminal block family	
DST1-ID/-MD/-MRD	493
Remote I/O	
NX-series modular I/O system	48

INTERACT WITH YOUR MACHINE

Patlite Signal towers

Machines that are stopped during production are creating extra cost, our signal towers are used to show this status and guide workers to service the machines efficiently, minimizing downtime and production loss.

- LED technology
- Optional sound system
- 30 mm, 50 mm, 60 mm and 70 mm diameter
- Modular and monolithic systems





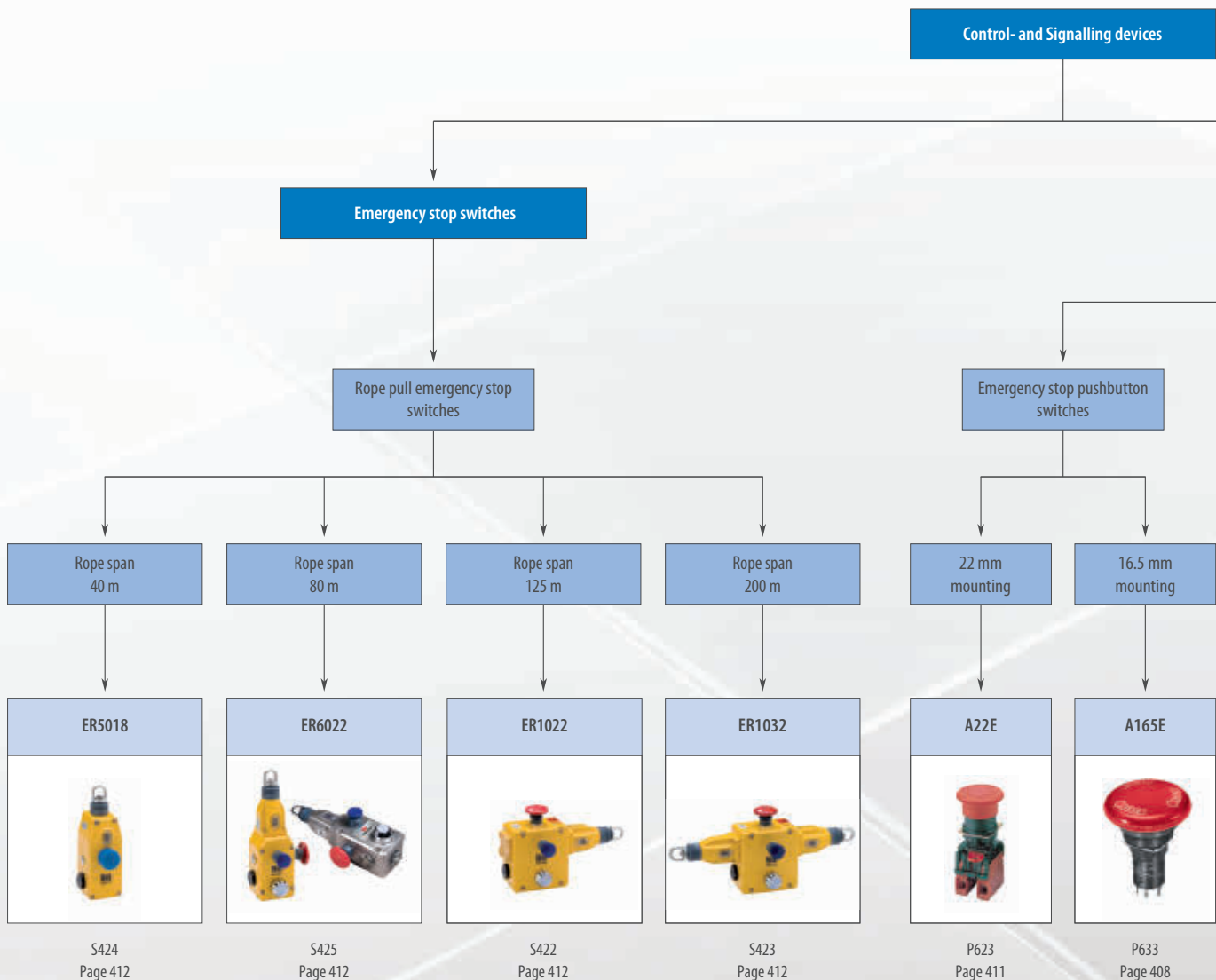

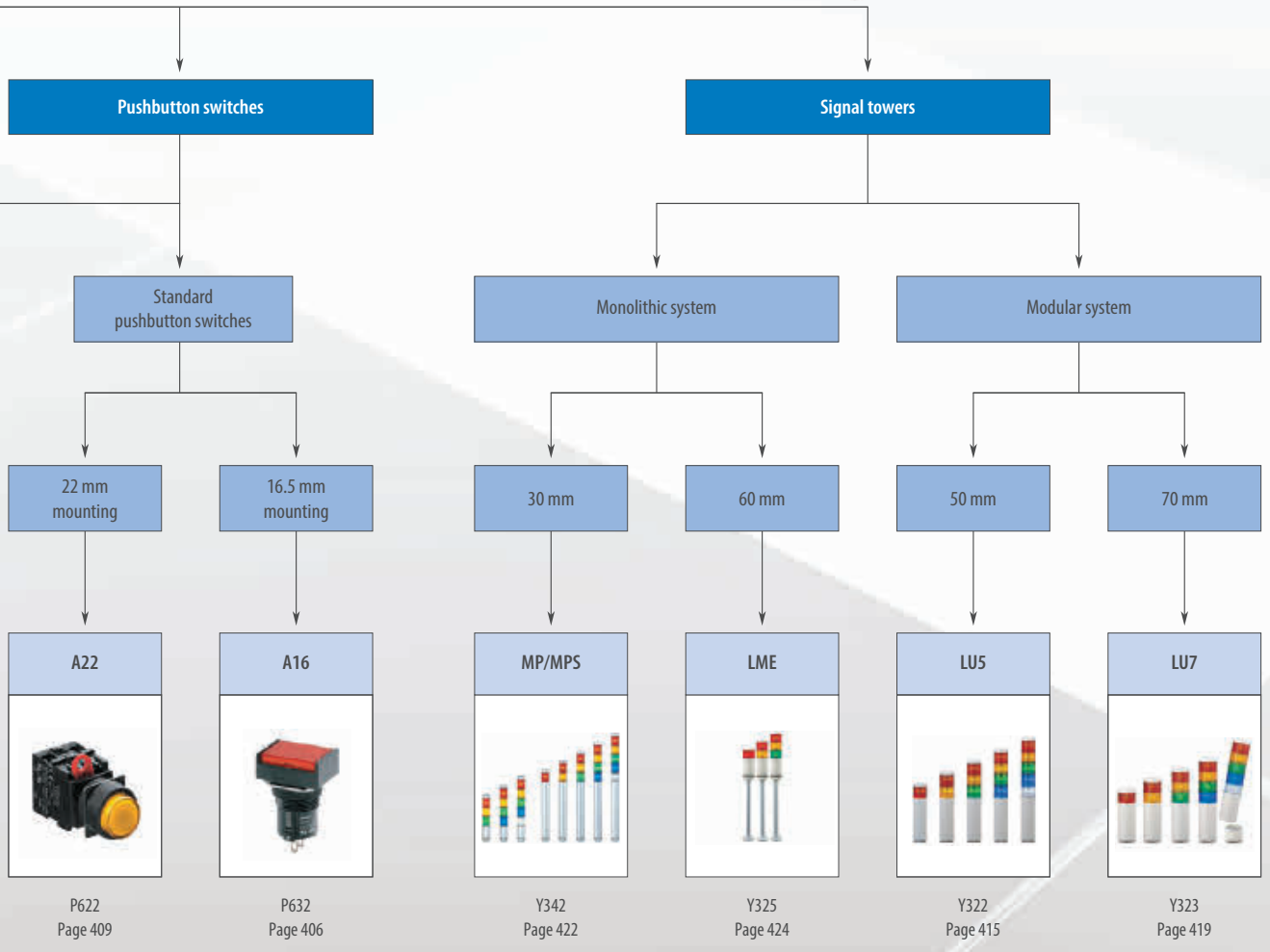

Select your signal tower in a split second:
www.omron-industrial.com/safety





Selection table





Category		Pushbutton switch		
				
Model		A16	A22	
Selection criteria	Mounting	Nut-mounting		
	Size	16 mm	22 mm	
	Shape			
Pushbutton color	Incandescent lamp-lighted	Red	■	■
		Yellow	■	■
		Pure yellow	■	
		Green	■	■
		White	■	■
		Blue	■	■
	LED-lighted	Red	■	■
		Yellow	■	■
		Pure yellow	■	
		Green	■	■
		White	■	■
		Blue	■	■
	Non-lighted	Red	■	■
		Yellow	■	■
		Green	■	■
White		■	■	
Blue		■	■	
Features	Momentary operation	■	■	
	Self-holding	■	■	
	Number of contacts	2	6	
	IP rating	IP65		
	Legend plate	■	■	
Switch ratings [A]	125 VAC	5	10	
	250 VAC	3	6	
	30 VDC	3	10	
	Rated load	5 A at 125 VAC, 3 A at 250 VAC, 3 A at 30 VDC	10 A at 110 VAC, 6 A at 220 VAC	
	Terminals	Solder	■	–
PCB		–	–	
Screw-less Clamp		–	–	
Operating voltage	5 VDC	■	■	
	12 VDC	■	■	
	24 VDC	■	■	
Form	SPDT	■	–	
	DPDT	■	–	
	SPST-NO	–	■	
	SPST-NC	–	■	
	SPST-NO + SPST-NC	–	■	
	DPST-NO	–	■	
DPST-NC	–	■		
Page/Quick Link		406	409	





Category		Emergency stop pushbutton switches	
			
Model		A165E	A22E
Selection criteria Features	Housing	Plastic	
	Protection class	IP65	
	Operating temperature range	–10 to 55°C	–20 to 70°C
	Head size	30 mm, 40 mm	30 mm, 40 mm, 60 mm
	Conformity	EN 60947-5-1	
	Max. rope span	–	
	Conduit size M20	–	
	Additional E-Stop button	–	
	LED indicator beacon	–	
	Stainless steel housing	–	
	Explosion proof housing	–	
	Lighted head	■	
	Push lock – pull reset	–	■
Push lock – turn reset	■		
Application	E-Stop application	■	
	General safety application	■	
Contact configuration	SPST (NC)	■	
	DPST (NC)	■	
	SPST (NO) + SPST (NC)	–	■
	TPST (NC)	■	–
Page/Quick Link		408	411

■ Standard

□ Available

– No/not available

Category		Rope pull switches			
					
Model		ER 5018	ER 6022	ER 1022	ER 1032
Selection criteria	Housing	Metal			
	Protection class	IP67			
	Operating temperature range	-25 to 80°C			
	Head size	-			
	Conformity	EN60947-5-1:2004, EN60947-5-5:1997+A1:2005; EN60204-1; EN ISO 13850:2006			
Features	Max. rope span	40 m	80 m	125 m	200 m
	Conduit size M20	■			
	Additional E-Stop button	■			
	LED indicator beacon	-	■	■	■
	Stainless steel housing	-	Available	-	-
	Explosion proof housing	-	■	■	■
	Lighted head	-			
	Push lock – pull reset	-			
	Push lock, turn reset	-			
Push lock, lock key reset	-				
Application	E-Stop application	■			
	General safety application	■			
Contact configuration	2NC+1NO	■	■	-	-
	3NC	■	■	-	-
	4NC+2NO	-	-	■	■
Page/Quick Link		412			

Category		Signalling devices			
					
		MP/MPS	LME	LU5	LU7
System		monolithic		modular	
Diameter		30 mm	60 mm	50 mm	70 mm
LED technology		■	■	■	■
Sound system		-	■	■	■
IP65		■	■	■	■
Maximum modules		5	5	5	5
Input voltage 24 VDC		■	■	■	■
Unit color		silver	white or silver or black	white or silver	white or silver or black
Page/Quick Link		422	424	415	419



16 mm pushbutton switch

These sub-assembled pushbutton switches have a modular construction: pushbutton + case + lamp (if applicable) + switch. A16 is a nut-mounted pushbutton switch with a short mounting depth of less than 28.5 mm below panel.

- Wide variety of control and signal devices: lighted, non-lighted and buzzer
- Quick and easy assembly, snap-in switch
- Wide range of switching capacity from standard load to micro load
- High reliability, IP65
- UL, cUL, CSA and VDE approved, conforms to EN60947-5-1 and IEC947-5-1

Ordering information

Type	Color	Order code		
		Degree of protection: Oil-resistant IP65		
		Rectangular	Square	Round
Non-lighted LED Incandescent lamp	Red	A165L-JR	A165L-AR	A165L-TR
	Yellow	A165L-JY	A165L-AY	A165L-TY
	Pure yellow	A165L-JPY	A165L-APY	A165L-TPY
	White	A165L-JW	A165L-AW	A165L-TW
	Blue	A165L-JA	A165L-AA	A165L-TA
Non-lighted	Black	A165L-JB	A165L-AB	A165L-TB
LED	Green	A165L-TGY	A165L-AGY	A165L-TGY
Non-lighted/incandescent lamp	Green	A165L-JG	A165L-AG	A165L-TG

Cases

Appearance	Classification	Order code	
		Oil-resistant IP65	
	Momentary operation	Rectangular (2-way guard)	A165-CJM
		Square	A165-CAM
		Round	A165-CTM
	Alternate operation	Rectangular (2-way guard)	A165-CJA
		Square	A165-CAA
		Round	A165-CTA

Switches

Appearance	Classification			Order code	
	Lighted/ non-lighted (common use)	Standard load/ microload (com- mon use)	SPDT	Solder terminal	A16-1
			DPDT		A16-2
			SPDT	PCB terminal	A16-1P
			DPDT		A16-2P
			DPDT	Screw- less clamp	A16-2S

Switches with reduced voltage lighting



Appearance	Classification			Order code	
	100 V	Standard load/ microload (common use)	SPDT	Solder terminal	A16-T1-1
			DPDT		A16-T1-2
	100 V 200 V		DPDT	Screw-less clamp	A16-T1-2S
					A16-T2-2S

Lamps

Type	Color	Order code		
		5 VDC	12 VDC	24 VDC
LED	Red	A16-5DSR	A16-12DSR	A16-24DSR
	Yellow	A16-5DSY	A16-12DSY	A16-24DSY
	Green	A16-5DSG	A16-12DSG	A16-24DSG
	White*1	A16-5DSW	A16-12DSW	A16-24DSW
	Blue	A16-5DA	A16-12DA	A16-24DA
Type		5 VAC/VDC	12 VAC/VDC	24 VAC/VDC
Incandescent lamp		A16-5	A16-12	A16-24

*1 Use the white LED together with white or pure yellow pushbuttons.

Accessories

Name	Appearance	Classification	Remarks	Order code
Switch guards		For rectangular models	Cannot be used with the dust cover	A16ZJ-5050
		For square and round models		A16ZA-5050
Dust covers		For rectangular models	Cannot be used with the switch guard	A16ZJ-5060
		For square models		A16ZA-5060
		For round models		A16ZT-5060
Panel plugs		For rectangular models	Used for covering the panel cutouts for future panel expansion	A16ZJ-3003
		For square models		A16ZA-3003
		For round models		A16ZT-3003

Specifications

Allowable operating frequency	Mechanical	Momentary operation: 120 operations/minute max. Alternate operation: 60 operations/minute max.
	Electrical	20 operations/minute max.
Durability	Mechanical	Momentary operation: 2,000,000 operations min. Alternate operation: 200,000 operations min.
	Electrical	100,000 operations min.
Ambient temperature		Operating: -10 to 55°C (with no icing or condensation) Storage: -25 to 65°C (with no icing or condensation)
Weight		Approx. 10 g (in the case of a lighted DPDT switch with solder terminals)
Size in mm (H×W×D)		Round/square:18×18×28.5 rectangular:18×24×28.5

Operating characteristics	Pushbutton switch	
	Oil-resistant IP65	
	SPDT	DPDT
Operating force (OF) max.	2.94 N	4.91 N
Releasing force (RF) min.	0.29 N	
Total travel (TT)	Approx. 3 mm	
Pretravel (PT) max.	2.5 mm	
Lock stroke (LTA) min.	0.5 mm	

Item	Screw-less clamp				
Recommended wire size	0.5 mm ² twisted wire or 0.8 mm dia. solid wire				
Usable wires and tensile strength	Twisted wire	0.3 mm ²	0.5 mm ²	0.75 mm ²	1.25 mm ²
	Solid wire	0.5 mm dia.	0.8 mm dia.	1.0 mm dia.	
	Tensile strength	10 N	20 N	30 N	40 N
Length of exposed wire	10 ±1 mm				



Emergency stop switch

The A165E line-up offers E-Stop switches with various head types. For flexible application, a wide range of accessories is provided. To set up easy installation and maintenance, various contact combinations are available.

- Direct opening mechanism with minimum contact separation of 3 mm
- Safety lock mechanism prevents misuse
- Short mounting depth
- Modular construction; easy installation using snap-in switch

Ordering information

Switches	Rated voltage	Pushbutton color	Pushbutton size	Terminal	Contact	Order code
						Standard load (125 VAC at 5 A, 250 VAC at 3 A, 30 VDC at 3 A)
LED	24 VDC	Red	30 dia.	Solder terminal	SPST-NC	A165E-LS-24D-01
None	-				DPST-NC	A165E-LS-24D-02
			SPST-NC		A165E-S-01	
LED	24 VDC		40 dia.		DPST-NC	A165E-S-02
		TPST-NC		A165E-S-03U		
None	-				SPST-NC	A165E-LM-24D-01
					DPST-NC	A165E-LM-24D-02
					SPST-NC	A165E-M-01
					DPST-NC	A165E-M-02
					TPST-NC	A165E-M-03U

Note: The above models have a surface indication of "RESET." Models with "STOP" indication are also available. For further information, contact your Omron representative.

Accessories (order separately)

Item	Type	Precautions	Order code
Yellow plate	Yellow, 45 dia.	Use this as an emergency stop nameplate.	A16Z-5070
Panel plug	Round	Used for covering the panel cutouts for future panel expansion.	A16ZT-3003
Tightening tool	-	Useful for repetitive mounting. Be careful not to tighten excessively.	A16Z-3004
Extractor	-	Convenient for extracting the switch and lamp.	A16Z-5080

Specifications

Rated voltage	Resistive load	
	A165E series	A165E_U series
125 VAC	5 A	1 A
250 VAC	3 A	0.5 A
30 VDC	3 A	1 A
Minimum applicable load	150 mA at 5 VDC	1 mA at 5 VDC

Features	Characteristics
Operating force (OF) max.	14.7 N
Releasing force (RF) min.	0.1 N·m
Pretravel (PT)	3.5±0.5 mm (3±0.5 mm in case of A165E_U series)

Item	Emergency stop switch	
Allowable operating frequency	Mechanical	20 operations/minute max.
	Electrical	10 operations/minute max.
Insulation resistance	100 MΩ min. (at 500 VDC)	
Dielectric strength	1,000 VAC, 50/60 Hz for 1 min between terminals of same polarity 2,000 VAC, 50/60 Hz for 1 min between terminals of different polarity and also between each terminal and ground 1,000 VAC, 50/60 Hz for 1 min between lamp terminals ^{*1}	
Durability	Mechanical	100,000 operations min.
	Electrical	100,000 operations min.
Ambient temperature	Operating: -10 to 55°C (with no icing or condensation) Storage: -25 to 65°C (with no icing or condensation)	
Protection against electric shock	Class II	

*1 LED not mounted. Test them with the LED removed.



22 mm pushbutton switch

A22 comes in a wide variety of shapes and colors and is installable in 22-dia. or 25-dia. panel cutouts. The switch unit can easily be mounted. A22 is mounted using either open-type (fork-type) or closed-type (round-type) crimp terminals.

- Finger-protection mechanism on switch unit provided as standard feature
- Increased wiring efficiency with three-row mounting of standard blocks
- IP65 oil-resistant (non-lighted models), IP65 (lighted models)
- Lighted and non-lighted, flat, projection and half- and full-guard versions
- EN60947-5-1, UL and cUL approved

Ordering information

Pushbutton

Illumination	Color	Order code							
		Flat type	Projection type	Full-guard type	Half-guard type	Square/projection type	Square/full-guard type	Round/mushroom type (30-dia. head)	Round/mushroom type (40-dia. head)
Non-lighted	Red	A22-FR	A22-TR	A22-GR	A22-HR	A22-CR	A22-DR	A22-SR	A22-MR
	Green	A22-FG	A22-TG	A22-TG	A22-HG	A22-CG	A22-DG	A22-SG	A22-MG
	Yellow	A22-FY	A22-TY	A22-GY	A22-HY	A22-CY	A22-DY	A22-SY	A22-MY
	White	A22-FW	A22-TW	A22-GW	A22-HW	A22-CW	A22-DW	A22-SW	A22-MW
	Blue	A22-FA	A22-TA	A22-GA	A22-HA	A22-CA	A22-DA	A22-SA	A22-MA
	Black	A22-FB	A22-TB	A22-GB	A22-HB	A22-CB	A22-DB	A22-SB	A22-MB
Lighted	Red	–	A22L-TR	A22L-GR	A22L-HR	A22L-CR	A22L-DR	–	–
	Green	–	A22L-TG	A22L-GG	A22L-HG	A22L-CG	A22L-DG	–	–
	Yellow	–	A22L-TY	A22L-GY	A22L-HY	A22L-CY	A22L-DY	–	–
	White	–	A22L-TW	A22L-GW	A22L-HW	A22L-CW	A22L-DW	–	–
	Blue	–	A22L-TA	A22L-GA	A22L-HA	A22L-CA	A22L-DA	–	–
Buttonsize in mm		29.7 dia. × 12D	29.7 dia. × 19D	29.7 dia. × 19D	29.7 dia. × 12/18.5D	29.8 mm ² × 18D	29.8 mm ² × 18D	30 dia. × 32D	40 dia. × 32D

Switches

Switch operation	Contacts	Order code			
		Non-lighted models		Lighted models	
		Without voltage reduction unit		With voltage reduction unit	
				110 VAC	220 VAC
Momentary	SPST-NO	A22-10M	A22L-10M	A22L-10M-T1	A22L-10M-T2
	SPST-NC	A22-01M	A22L-01M	A22L-01M-T1	A22L-01M-T2
	SPST-NO + SPST-NC	A22-11M	A22L-11M	A22L-11M-T1	A22L-11M-T2
	DPST-NO	A22-20M	A22L-20M	A22L-20M-T1	A22L-20M-T2
	DPST-NC	A22-02M	A22L-02M	A22L-02M-T1	A22L-02M-T2
	Alternate	SPST-NO	A22-10A	A22L-10A	A22L-10A-T1
SPST-NC		A22-01A	A22L-01A	A22L-01A-T1	A22L-01A-T2
SPST-NO + SPST-NC		A22-11A	A22L-11A	A22L-11A-T1	A22L-11A-T2
DPST-NO		A22-20A	A22L-20A	A22L-20A-T1	A22L-20A-T2
DPST-NC		A22-02A	A22L-02A	A22L-02A-T1	A22L-02A-T2

Switch blocks

Switch blocks	Standard load	Order code
	SPST-NO	A22-10
	SPST-NC	A22-01
	DPST-NO	A22-20
	DPST-NC	A22-02

Lamp – LED

AC/DC	LED light	Order code			
		Operating voltage			
		6 V	12 V	24 V	24 V superbright
DC	Red	A22-6DR	–	–	–
	Green	A22-6DG	–	–	–
	Yellow ^{*1}	A22-6DY	–	–	–
	Blue	A22-6DA	–	–	–
AC	Red	A22-6AR	–	–	–
	Green	A22-6AG	–	–	–
	Yellow ^{*1}	A22-6AY	–	–	–
	Blue	A22-6AA	–	–	–
AC and DC	Red	–	A22-12AR	A22-24AR	A22-24ASR
	Green	–	A22-12AG	A22-24AG	A22-24ASG
	Yellow ^{*1}	–	A22-12AY	A22-24AY	A22-24ASY
	Blue	–	A22-12AA	A22-24AA	A22-24ASA

*1 Used when the pushbutton color is yellow or white

Lamp - incandescent lamp

Order code	Operating voltage		
	5 VAC/VDC	12 VAC/VDC	24 VAC/VDC
A22-5		A22-12	A22-24

Accessories

Item		Remarks	Order code	
Lamp sockets	Direct lighting	Used when changing the lighting method (LED only)	A22-TN	
	Voltage-reduction lighting		220 VAC	A22-T2
Mounting latches	For momentary models	Order mounting latches only when mounting switch blocks or lamp sockets are purchased individually	A22-3200	
Legend plate frames	Large size	With snap-in legend plate, without text, black	A22Z-3333	
		Without snap-in legend plate	A22Z-3330	
Sealing caps	For projection models	Used to prevent dust or water from entering the operation unit (pushbutton, etc.), color: Opaque, material: Silicon	A22Z-3600T	
Three-throw spacer		Used when mounting three non-lighted switches	A22Z-3003	
Control boxes (enclosures)	Exclusively for A22	One hole	A22Z-B101	
		Two holes	A22Z-B102	
		Three holes	A22Z-B103	
Snap-in legend plates	Standard size	Without text	White	A22Z-3443W
			Transparent	A22Z-3443C
		White text on black background	ON	A22Z-3443B-5
			OFF	A22Z-3443B-6
			DOWN	A22Z-3443B-8
	Large size	Without text	White	A22Z-3453W
			Transparent	A22Z-3453C
	For emergency stop switch	60-dia. round plate with black letters on a yellow background	"EMERGENCY STOP" is engraved on the plate. Used as an emergency stop switch legend plate	A22Z-3466-1
		90-dia. round plate with black letters on a yellow background		A22Z-3476-1
	Lamp extractor		Rubber tool used to easily replace lamps	A22Z-3901
Tightening wrench		Tool used to tighten nuts from the back of the panel	A22Z-3905	

Specifications

Recognized organization	Standards	File number
UL, cUL	UL508	E41515
-	EN60947-5-1	-

Contact ratings (standard load)

Rated carry current (A)	Rated voltage	Rated current (A)			
		AC15 (inductive load)	AC12 (resistive load)	DC13 (inductive load)	DC12 (resistive load)
10	24 VAC	10	10	-	-
	110 VAC	5	10	-	-
	220 VAC	3	6	-	-
	380 VAC	2	3	-	-
	440 VAC	1	2	-	-
	24 VDC	-	-	1,5	10
	110 VDC	-	-	0,5	2
	220 VDC	-	-	0,2	0,6
	380 VDC	-	-	0,1	0,2

Contacts (microload)

Rated applicable load	Minimum applicable load
50 mA at 5 VDC (resistive load)	1 mA at 5 VDC

LED indicators without voltage reduction unit

Rated voltage	Rated current	Operating voltage
6 VDC	60 mA (20 mA)	6 VDC ±5%
6 VAC	60 mA (20 mA)	6 VAC/VDC ±5%
12 VAC/VDC	30 mA (10 mA)	12 VAC/VDC ±5%
24 VAC/VDC	15 mA (10 mA)	24 VAC/VDC ±5%

Super-bright LED indicator

Rated voltage	Rated current	Operating voltage
24 VAC/VDC	15 mA	24 VAC/VDC ±5%

Incandescent lamp

Rated voltage	Rated current	Operating voltage
6 VAC/VDC	200 mA	5 VAC/VDC
14 VAC/VDC	80 mA	12 VAC/VDC
28 VAC/VDC	40 mA	24 VAC/VDC
130 VAC/VDC	20 mA	100 VAC/VDC

Voltage-reduction lighting

Rated voltage	Operating voltage	Applicable lamp (BA8S/13_gold)
110 VAC	95 to 115 VAC	LED Lamp (A22-24A_)
220 VAC	190 to 230 VAC	

Item	Pushbutton switches		Emergency stop switches		Knob-type selector switches		Key-type selector switch
	Non-lighted	Lighted	Non-lighted	Lighted	Non-lighted	Lighted	Non-lighted
Allowable operating frequency	Mechanical	Momentary operation: 60 operations/minute max.	30 operations/minute max.		Manual release: 30 operations/minute max., automatic release: 30 operations/minute max.		
	Electrical	30 operations/minute max.		30 operations/minute max.			
Durability (number of operations min.)	Mechanical	Momentary operation: 5,000,000	Momentary operation: 300,000		500,000	100,000	500,000
	Electrical	500,000	300,000		500,000	100,000	500,000
Ambient temperature	Operating	-20 to 70°C	-20 to 55°C	-20 to 70°C	-20 to 55°C	-20 to 70°C	-20 to 70°C
	Storage	-40 to 70°C	-40 to 70°C	-40 to 70°C	-40 to 70°C	-40 to 70°C	-40 to 70°C
Degree of protection	IP65 (oil-resistant)	IP65	IP65 (oil-resistant)	IP65	IP65 (oil-resistant)	IP65	IP65 (oil-resistant)
Size in mm (in-panel only)	34H × 34W × 54.7D, 34H × 34W × 72.7D for DPST switches						



Emergency stop switch

The A22E line-up of E-Stop switches offers various head types as well as lighted models. E-stop shrouds and control boxes as accessories provide flexibility in application.

- Direct opening mechanism with minimum contact separation of 3 mm
- Safety lock mechanism prevents misuse
- Easy mounting of switch block
- Lighted models for easy diagnosis and maintenance
- Modular design for flexibility in application

Ordering information

Non-lighted models

Description	Output	Color of cap	Order code
30-dia. head Push-lock Turn-reset	SPST-NC	Red	A22E-S-01
	SPST-NO/SPST-NC		A22E-S-11
	DPST-NC		A22E-S-02
40-dia. head Push-lock Turn-reset	SPST-NC		A22E-M-01
	SPST-NO/SPST-NC		A22E-M-11
	DPST-NC		A22E-M-02
60-dia. head Push-lock Turn-reset	SPST-NC		A22E-L-01
	SPST-NO/SPST-NC		A22E-L-11
	DPST-NC		A22E-L-02

Lighted models

Description	Output	Lighting	Rated voltage	Color of cap	Order code
40-dia. head Push-lock Turn-reset	SPST-NC	LED	24 VAC/VDC	Red	A22EL-M-24A-01
	SPST-NO/SPST-NC		24 VAC/VDC		A22EL-M-24A-11
	DPST-NC		24 VAC/VDC		A22EL-M-24A-02
40-dia. head Push-lock Turn-reset	SPST-NC		220 VAC		A22EL-M-T2-01
	SPST-NO/SPST-NC		220 VAC		A22EL-M-T2-11
	DPST-NC		220 VAC		A22EL-M-T2-02

Accessories (Order separately)

Item	Classification	Remarks	Order code
Control boxes (enclosures)	One hole	Material: Polycarbonate resin	A22Z-B101
	One hole, yellow box (for emergency stop)		A22Z-B101Y
	Two holes		A22Z-B102
	Three holes		A22Z-B103
Legend plates for emergency stop	60-dia. black letters on yellow back-ground	"EMERGENCY STOP" is indicated on the plate.	A22Z-3466-1
	90-dia. black letters on yellow back-ground		A22Z-3476-1
Lock plate	Locks the mounting latch of the switch assembly	-	A22Z-3380

Specifications

Contacts (standard load)

Rated carry current	Rated voltage	Rated current (A)			
		AC15	AC12	DC13	DC12
10	24 VAC	10	10	-	-
	220 VAC	3	6	-	-
	24 VDC	-	-	1.5	10
	220 VDC	-	-	0.2	0.6

Note 1. Rated current values are determined according to the testing conditions. The above ratings were obtained by conducting tests under the following conditions.

- (1) Ambient temperature: $20 \pm 2^\circ\text{C}$
- (2) Ambient humidity: $65\% \pm 5\%$
- (3) Operating frequency: 20 operations/minute

2. Minimum applicable load: 10 mA at 5 VDC

Contacts (microload)

Rated applicable load	Minimum applicable load
50 mA at 5 VDC (resistive load)	1 mA at 5 VDC

Characteristics

Item	Emergency stop switches	
	Non-lighted model: A22E	Lighted model: A22EL
Dielectric strength	2,500 VAC, 50/60 Hz for 1 min between terminals of same polarity 2,500 VAC, 50/60 Hz for 1 min between terminals of different polarity and also between each terminal and ground	
Durability	Mechanical	Momentary operation: 300,000 operations min.
	Electrical	300,000 operations min.
Degree of protection	IP65 (oil-resistant)	IP65



Emergency stop switch

- Tension indicator – the tension indicator makes the system easy to set up and to maintain the proper rope tension
- Heavy-duty housing – the die-cast housing and stainless steel eye nut makes the ER-series rope pull switches suitable for demanding industrial applications
- Vibration tolerant – the snap-acting switch contacts protect against nuisance tripping due to vibration
- Integral E-stop – the E-stop button provides emergency stopping capability at the extreme end of the installation and is field serviceable
- ER6022 available in stainless steel housing
- ER6022, ER1022 and ER1032 available in explosion proof housing

Ordering information

Standard models

Aluminum die-cast housing

E-Stop	Indicator beacon	Contacts	Wiring entry	Order code
Not included	–	2 N/C + 1 N/O	3 × M20	44506-4010 ER5018-021M
Not included	–	3 N/C	3 × M20	44506-4030 ER5018-030M
Included	–	2 N/C + 1 N/O	3 × M20	44506-4110 ER5018-021ME
Included	–	3 N/C	3 × M20	44506-4130 ER5018-030ME
Not included	Not included	2 N/C + 1 N/O	3 × M20	44506-5010 ER6022-021M
Not included	Not included	3 N/C + 1 N/O	3 × M20	44506-5050 ER6022-031M
Not included	Included (24 VDC)	2 N/C + 1 N/O	3 × M20	44506-5110 ER6022-021ML
Not included	Included (24 VDC)	3 N/C + 1 N/O	3 × M20	44506-5150 ER6022-031ML
Included	Not included	2 N/C + 1 N/O	3 × M20	44506-5210 ER6022-021ME
Included	Not included	3 N/C + 1 N/O	3 × M20	44506-5250 ER6022-031ME
Included	Included (24 VDC)	2 N/C + 1 N/O	3 × M20	44506-5410 ER6022-021MEL
Included	Included (24 VDC)	3 N/C + 1 N/O	3 × M20	44506-5450 ER6022-031MEL
Included	Included (24 VDC)	4 N/C + 2 N/O	4 × M20	44506-6410 ER1022-042MELL
Included	Included (24 VDC)	4 N/C + 2 N/O	4 × M20	44506-6510 ER1022-042MELR
Included	Included (24 VDC)	4 N/C + 2 N/O	4 × M20	44506-7410 ER1032-042MEL

Stainless steel housing

E-Stop	Indicator beacon	Contacts	Wiring entry	Order code
Not included	Not included	2 N/C + 2 N/O	3 × M20	44506-5810 ER6022-022MSS
Not included	Not included	3 N/C + 1 N/O	3 × M20	44506-5830 ER6022-031MSS
Not included	Included	2 N/C + 2 N/O	3 × M20	44506-5910 ER6022-022MLSS
Not included	Included	3 N/C + 1 N/O	3 × M20	44506-5930 ER6022-031MLSS
Included	Not included	2 N/C + 2 N/O	3 × M20	44506-5850 ER6022-022MESS
Included	Not included	3 N/C + 1 N/O	3 × M20	44506-5870 ER6022-031MESS
Included	Included	2 N/C + 2 N/O	3 × M20	44506-5950 ER6022-022MELSS
Included	Included	3 N/C + 1 N/O	3 × M20	44506-5970 ER6022-031MELSS

Explosion proof models

Aluminum die-cast housing

E-Stop	Indicator beacon	Contacts	Wiring entry	Order code
Not included	Not included	1 N/C + 1 N/O	pre-wired, 3 m	44506-5600 XER6022-011C3
Not included	Not included	1 N/C + 1 N/O	pre-wired, 3 m	44506-6600 XER1022-011C3L
Not included	Not included	1 N/C + 1 N/O	pre-wired, 3 m	44506-6610 XER1022-011C3R
Not included	Not included	1 N/C + 1 N/O	pre-wired, 3 m	44506-7600 XER1032-011C3

Stainless steel housing

E-Stop	Indicator beacon	Contacts	Wiring entry	Order code
Not included	Not included	1 N/C + 1 N/O	pre-wired, 3 m	44506-5610 XER6022-011C3SS
Not included	Not included	2 N/C	pre-wired, 3 m	44506-5620 XER6022-020C3SS

Accessories

Item	Applicable model	Order code
Replacement Lid	ER5018	44506-3700 SM06-SL400
	ER6022	44506-5700 SM06-SL500
	ER6022-SS stainless steel	44506-5730 SM06-SLXER6022SS
Replacement Lid/LED, 24 VDC	ER1022	44506-6710 SM06-SL710
	ER1032	44506-7710 SM06-SL711
	ER6022-SS stainless steel	44506-5740 SLER6022LSS

Item	Applicable model	Order code
Replacement Lid/LED	ER6022	44506-5710 SM06-SL510
Rope kit, 5 m, stainless steel	ER5018, ER6022, ER1022, ER1032	44506-2705 RK5
Rope kit, 10 m, stainless steel	ER5018, ER6022, ER1022, ER1032	44506-2710 RK10
Rope kit, 20 m, stainless steel	ER5018, ER6022, ER1022, ER1032	44506-2720 RK20
Rope kit, 50 m, stainless steel	ER5018, ER6022, ER1022, ER1032	44506-2750 RK50
Rope kit, 80 m, stainless steel	ER6022, ER1022, ER1032	44506-2780 RK80
Rope kit 100 m, stainless steel	ER6022, ER1022, ER1032	44506-2711 RK100
Rope kit 126 m, stainless steel	ER1032	44506-2726 RK126
Rope only, 5 m	ER5018, ER6022, ER1022, ER1032	44506-3705 R5M
Rope only, 10 m	ER5018, ER6022, ER1022, ER1032	44506-3710 R10M
Rope only, 20 m	ER5018, ER6022, ER1022, ER1032	44506-3720 R20M
Rope only, 50 m	ER5018, ER6022, ER1022, ER1032	44506-3750 R50M
Rope only, 100 m	ER5018, ER6022, ER1022, ER1032	44506-3711 R100M
Rope only, 126 m	ER5018, ER6022, ER1022, ER1032	44506-3726 R126M
Tensioner gripper, stainless steel	ER5018, ER6022, ER1022, ER1032	44506-4700 SM06-TG00
Eye bolt stainless steel, 8 per pack	ER5018, ER6022, ER1022, ER1032	44506-4710 SM06-EB10
Double loop clip, stainless steel, 4 per pack	ER5018, ER6022, ER1022, ER1032	44506-4720 SM06-DL20
Thimble stainless steel, 4 per pack	ER5018, ER6022, ER1022, ER1032	44506-4770 SM06-THSS
Turnbuckle, stainless steel	ER5018, ER6022, ER1022, ER1032	44506-4730 SM06-TB30
Spring, stainless steel	ER5018, ER6022, ER1022, ER1032	44506-4750 SM06-SP50
Rope pulley, stainless steel	ER5018, ER6022, ER1022, ER1032	44506-4780 SM06-RPSS
E-Stop mechanism	ER5018, ER6022, ER1022, ER1032	44506-4760 SM06-ES60
Yellow E-Stop Background Label	ER5018, ER6022, ER1022, ER1032	44506-4791 SM06-YLES

Specifications

Standard models

Item	Applicable model					
	ER5018	ER6022	ER60225S	ER1022	ER1032	
Electrical	Contact configurations	2 N/C + 1 N/O, 3 N/C	2 N/C + 1 N/O, 3N/C + 1N/O	3 N/C+1 N/O, 2 N/C+2 N/O	4 N/C + 2 N/O	
	Safety contacts	2 N/C, 3 N/C	2 N/C, 3 N/C	2 N/C, 3 N/C	4 N/C	
	Switching ability	AC: 120 V–6 A, 240 V–3 A, inductive DC: 24 V–2.5 A, inductive				
	Auxiliary contacts	1 N/O		1 N/O, 2 N/O	2 N/O	
	Max. switching current/Volt/Amp	240 V/720 VA				
	Electrical life	1,000,000 minimum				
Mechanical	LED indicator beacon	–	24 VDC			
	Max. rope span	40 m	80 m	100 m	125 m	
	Case material	Die-cast aluminum alloy		Die-cast 316 stainless steel casing	Die-cast aluminum alloy	
	Eye nut material	Stainless steel				
	Wiring entry	3 × M20			4 × M20	
Environmental	Mechanical life	1,000,000 minimum				
	Protection	IP67 (NEMA 6)				
	Operating temperature	–25 to 80°C				
Compliance	Cleaning	Water washdown				
	Standards	EN60947-5-1:2004, EN60947-5-5:1997+A1:2005; EN60204-1; EN ISO 13850:2006				
Approvals/listings	CE marked for all applicable directives, UL and C-UL					

Explosion proof models

Item	Applicable model			
	XER6022	XER1022	XER1032	
Electrical	Contact configuration	1 N/C + 1 N/O, 2 N/C		
	Safety contact	1 N/C, 2 N/C		
	Auxiliary contact	1 N/O		
	Rated voltage and current (AC15)	400 VAC/2 A AC, 250 VAC/4 A AC		
	Rated voltage and current (DC)	250 VDC/0.15 A DC		
	Switching ability AC ratings	Resistive load	125 VAC/5 A, 250 VAC/5 A	
		Inductive load	125 VAC/3 A, 250 VAC/3 A	
	Switching ability DC ratings	Resistive load	30 VDC/7 A, 250 VDC/0.15 A	
Inductive load		30 VDC/5 A, 250 VDC/0.03 A		
Compliance	Ex-classification	II 2 G Ex d II C T6		
	Certification	PTB00 ATEX 1093X IBE XU 01 ATEX 1007X		

Accessories

RK rope tension kit



The RK rope tension kit comes with all of the required hardware for most installations. A spring is required as shown in the installation example below.

Installation Hardware

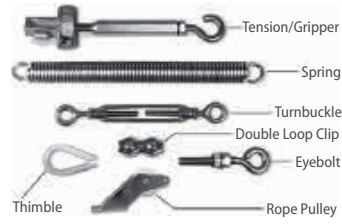

Individual hardware items may be purchased for specific installation requirements.

PATLITE distributed by Omron



Versatile modular signal tower featuring easy assembly and wiring designed for every need.

LU5 Series - Medium size modular system provides hybrid prism cut lens for enhanced visibility from any direction and distance and two selectable sound patterns up to 85 dB. Main features are the interchangeable LED modules and the color coordinated wiring for easy alignment.

- Diameter: 50 mm
- Base modules available in ivory white or in silver
- Up to 5 LED modules can be used on the light tower
- Modules of the same color operate from different terminals
- Two, user - selectable, alarms integrated in the base module with adjustable volume up to 85 dB at 1 m

Ordering information

LED module

LU5-E-R
1 2

1. E: LED unit
2. Color of LED
 - R: Red
 - Y: Yellow
 - G: Green
 - B: Blue
 - C: Clear/White

Base module

LU5-02UFB
1 2 3

1. Rated voltage
02: 24 VDC
2. Unit color
Blank: Ivory white
U: Silver color
3. Type
Blank: Continuous light
FB: Continuous or flashing light with audible alarm

Ordering information

LED module

Module color	Power consumption	Rated voltage	Operation voltage	Operation temperature range	Mass	Order code
Red	52 mA/1.25 W	24 VDC	Rated voltage ±10% (21.6~26.4 V)	-30°C~+60°C	44 g ±10%	LU5-E-R
Yellow	42 mA/1.0 W					LU5-E-Y
Green		LU5-E-G				
Blue		LU5-E-B				
Clear		LU5-E-C				

Base module

Typ	Alarm/Flash	Power consumption	Rated voltage	Operation voltage	Operation temperature range	Mass	Open collector	Order code
Standard body	Continuous	1.2 W	24 VDC	Rated voltage ±10% (21.6 ~ 26.4 V)	-30°C~+60°C	182g ±10%	PNP/ NPN	LU5-02 ^{*1}
	2 Sounds/Flashlight							200g ±10%

*1 Ivory white: black, silver: add "U"

Optional parts

Typ	Material	Order code
Wall mount bracket	Aluminum alloy die-cast	SZ-017
	ABS resin	SZ-020
Upper bracket	Metal	SZ-60NPT
		SZ-60U
Mount bracket	Aluminum alloy die-cast	SZ-016A
		SZ-70B

Typ	Height	Material	Order code
Pole	100 mm	Aluminum	Pole-100A21
	300 mm	Aluminum	Pole-300A21
	800 mm	Aluminum	Pole-800A21

Features



LED module is stackable and reconfigurable even after installation
 IP 65: Implemented o rings seal out liquids so that the tower can be used in wet conditions.

Dimensions

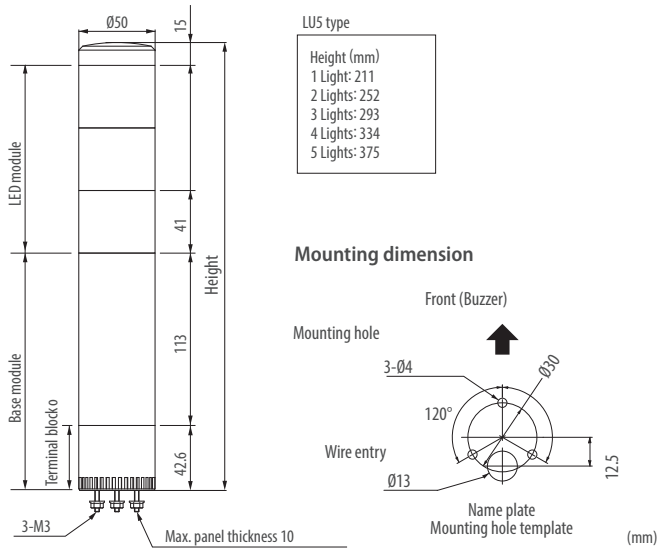

Wiring diagram

LU5-02FB
24 VDC

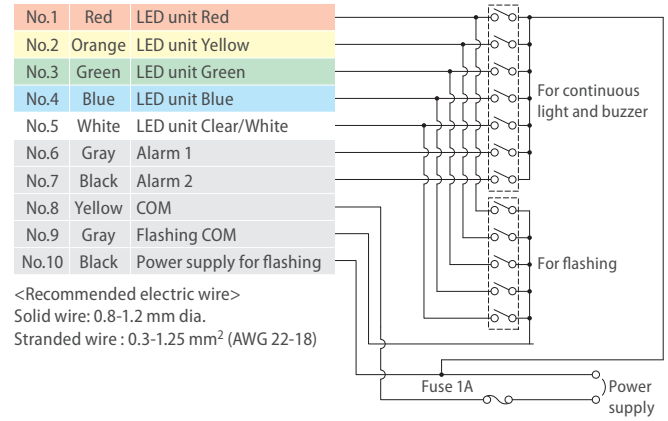

How to order

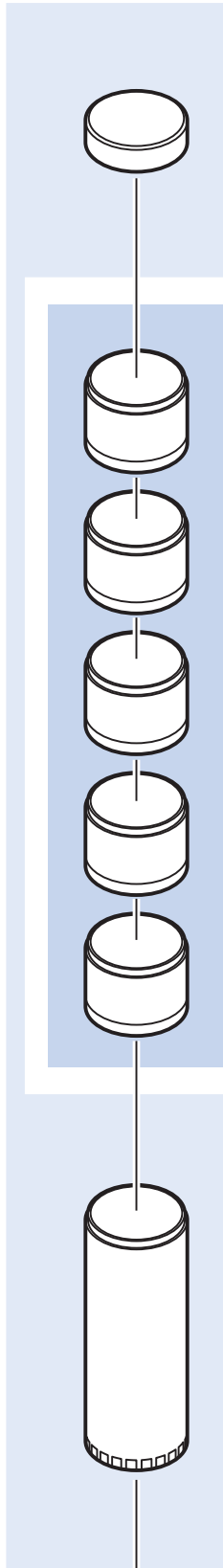

Optional parts

LED units



Model	LU5-E-R	LU5-E-Y	LU5-E-G	LU5-E-B	LU5-E-C
Unit color					
Rated voltage	24 VDC				
Operating voltage range	Rated voltage±10% (21.6~26.4 V)				
Current/power consumption	52 mA/1.25 W		42 mA/1.0 W		
Operating temperature range	-30°C~+60°C				
Mass	44 g±10%				



BASE units



Model	LU5-02	LU5-02FB	
Color			
Standard body/short body	Standard		
Rated voltage	24 VDC		
Operating voltage range	Rated voltage±10%(21.6~26.4 V)		
Buzzer	-	*Buzzer 1	**Buzzer 2
Current consumption	-	50±10 mA	24±10 mA
Power consumption	-	1.2±0.25 W	0.58±0.25 W
Sound level	-	Max: 85±5 dB (at 1 m)	
Flashing cycle	-	6±12 flashes per minutes	
Operating temperature Range	-30°C~+60°C		
Mounting direction	Upright, indoor only		
Protection rating	IP65		
Mass	182 g±10%	200 g±10%	
Open collector	PNP/NPN		

* Buzzer 1: Continuous sound **Buzzer 2: Intermittent sound



Optional parts

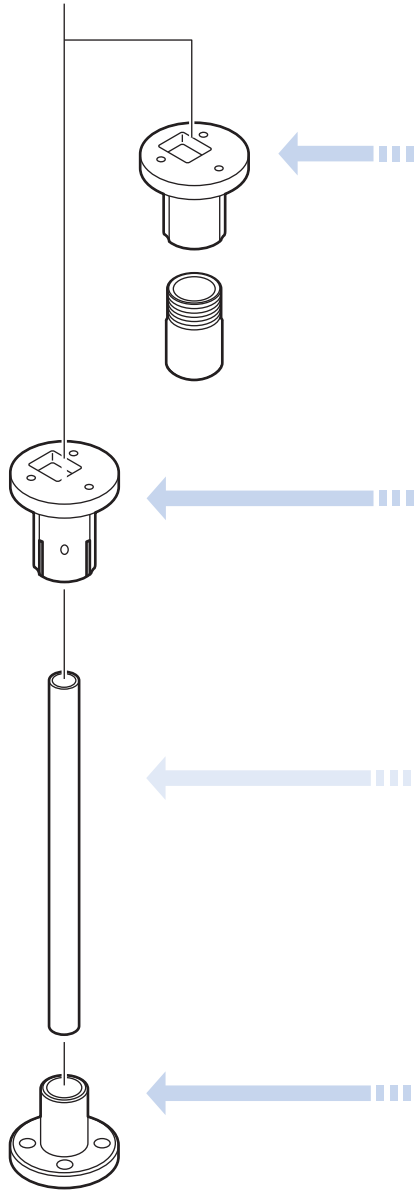

Upper bracket

SZ-60NPT (for 1/2" NPT pole)

Upper bracket

SZ-60-U

Pole

21.7 mm

Steel pole

Model	POLE-800S21	POLE-300S21	POLE-100S21
Height	800 mm	300 mm	100 mm

Aluminum pole

Model	POLE-800A21	POLE-300A21	POLE-100A21
Height	800 mm	300 mm	100 mm

Mount bracket

SZ-016A
(For Ø21.7 mm pole)

SZ-70-B
(For Ø21.7 mm aluminum pole only)

Wall mount bracket

SZ-020
(For Ø21.7 mm pole)

SZ-017
(For Ø21.7 mm pole)

Specifications

Size	50 mm diameter
Input voltage options	24 VDC
Functions available	<ul style="list-style-type: none"> • Continuous only • Continuous, flashing, alarms
Mounting options	Direct mount only, includes 3 mounting nuts
Body styles	<ul style="list-style-type: none"> • Component style, wiring terminals provided • Interchangeable and stackable after purchase
Body colors	Beige
Tiers	1-5 modules can be stacked
Module colors	Red / Yellow / Green / Blue / Clear
Alarms (FB style only)	<ul style="list-style-type: none"> • Alarm 1: selectable, single-tone, continuous alarm, 85 dB (at 1 m) • Alarm 2: selectable, single tone, intermittent (slow beep) alarm, 85 dB (at 1 m)
Ratings	<ul style="list-style-type: none"> • CE • UL listed (US) • UL listed (Canada) • RoHS
Protection	<ul style="list-style-type: none"> • IP-65 • Type 4 / 4X / 13 (indoor only)
Control options	<ul style="list-style-type: none"> • Dry contact closure such as switches or relay contacts • Open-collector transistor (NPN or PNP) for 24 VDC • Direct voltage control for 24 VDC, continuous and alarm functions only

PATLITE distributed by Omron



Versatile modular signal tower featuring easy assembly and wiring designed for every need.

LU7 presents ultra bright LEDs combined with an innovative prism lens design. 1 to 5 modules can be arranged in tiers.

- Diameter: 70 mm
- Base module in 2 sizes and 3 colors
- Different modules: standard LED, strobe LED and sound
- Two, user - selectable, alarms integrated in the base module with adjustable volume up to 90 dB at 1 m.
- Color-coordinated and spring-loaded terminal block

Ordering information

LED module

Typ	Module color	Power consumption	Rated voltage	Operation voltage	Operation temperature range	Mass	Order code
Standard	Red	52 mA/1.25 W	24 VDC	Rated voltage ±10% (21.6~26.4 V)	-30°C~+60°C	60 g ±10%	LU7-E-R
	Yellow						LU7-E-Y
	Green	42 mA/1.0 W					LU7-E-G
	Blue						LU7-E-B
	Clear/White						LU7-E-C
Strobe	Red	290 mA	24 VDC	Rated voltage ±10% (21.6~26.4 V)	-30°C~+60°C	0,07 kg	LU7-XE-R
	Yellow	140 mA					LU7-XE-Y
	Green						LU7-XE-G
	Blue						270 mA
	Clear/White	280 mA					LU7-XE-C

Base module

Typ	Alarm/Flash	Power consumption	Rated voltage	Operation voltage	Operation temperature range	Mass	Open collector	Order code
Short body	Continuous	1.2 W	24 VDC	Rated voltage ± 10% (21.6~26.4 V)	-30°C~+60°C	150 g ±10%	PNP/ NPN	LU7-02S*1
Standard body	Continuous					250 g ±10%		LU7 - 02*1
	2 Sounds/Flashlight					280 g ±10%		LU7 - 02FB*1

*1 Ivory white: blank, black: add "K", silver: add "U"

Optional parts

Typ	Material	Order code
Wall mount bracket	Aluminum alloy die-cast	SZ-017
	PBT/ ABS resin	SZ-018
		SZ-018U
		SZ-018K
	ABS resin	SZ-020
Upper bracket	Metal	SZ - 50U
		SZ - 50UU
		SZ - 50KU
		SZ - 50NPT
Mount bracket	Aluminum alloy die-cast	SZ-016A
		SZ-70B

Typ	Height	Material	Order code
Pole	100 mm	Aluminum	Pole-100A21
		Steel	Pole-100S21
	300 mm	Aluminum	Pole-300A21
		Steel	Pole-300S21
	800 mm	Aluminum	Pole-800A21
		Steel	Pole-800S21

Voice and sound module (unique sound module in all directions)

Rated voltage	Power consumption	Mass	Order code
24 VDC	3.5 W	0.17 kg	LU7-V1

Features

Easy alignment:
Color-coordinated terminal block:
Corresponds to the lens colors for quick wiring verification in the base unit.

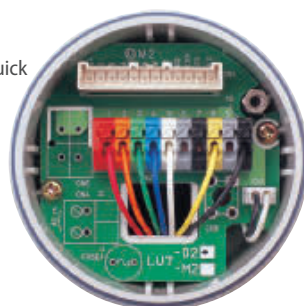

LU7-02FB

LU7 Standard body

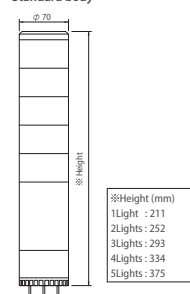

LU7-02S Short body

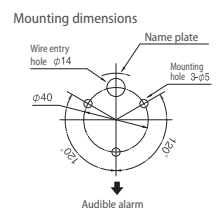
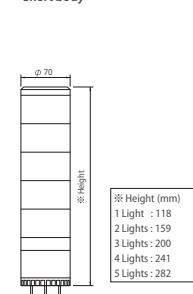

How to order



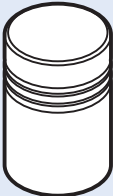

Voice and sound module



Model	LU7-V1
Type	Voice synthesizer
Rated voltage	24 VDC
Power consumption	3.5 W
Weight	0.17 kg





LED units



Model	LU7-E-R	LU7-E-Y	LU7-E-G	LU7-E-B	LU7-E-C
Unit color					
Rated voltage	24 VDC				
Operating voltage range	Rated voltage±10% (21.6~26.4 V)				
Current/power consumption	52 mA/1.25 W		42 mA/1.0 W		
Operating temperature range	-30°C~+60°C				
Mass	60 g±10%				



LED strobe module





Model	LU7-XE-R	LU7-XE-Y	LU7-XE-G	LU7-XE-B	LU7-XE-C
Unit color					
Rated voltage	24 VDC				
Power consumption	290 mA	290 mA	140 mA	270 mA	280 mA
Mass	0.07 kg				



BASE units

Model	LU7-02S	LU7-02	LU7-02FB
Color		  	
Standard body/short body	Short	Standard	
Rated voltage	24 VDC		
Operating voltage range	Rated voltage±10% (21.6~26.4 V)		
Buzzer	-	*Buzzer 1	**Buzzer 2
Current consumption	-	50±10 mA	24±10 mA
Power Consumption	-	1.2±0.25 W	0.58±0.25 W
Sound level	-	Max: 90±5dB (at 1 m) Min: 70 dB or Less (at 1 m)	
Flashing cycle	-	60±12 flashes per minute	
Operating temperature Range	-30°C~+60°C		
Mounting direction	Upright, indoor only		
Protection rating	IP65		
Mass	150 g±10%	250 g±10%	280 g±10%
Open collector	PNP/NPN		

* Buzzer 1: Continuous sound **Buzzer 2: Intermittent sound



Optional parts

Optional parts

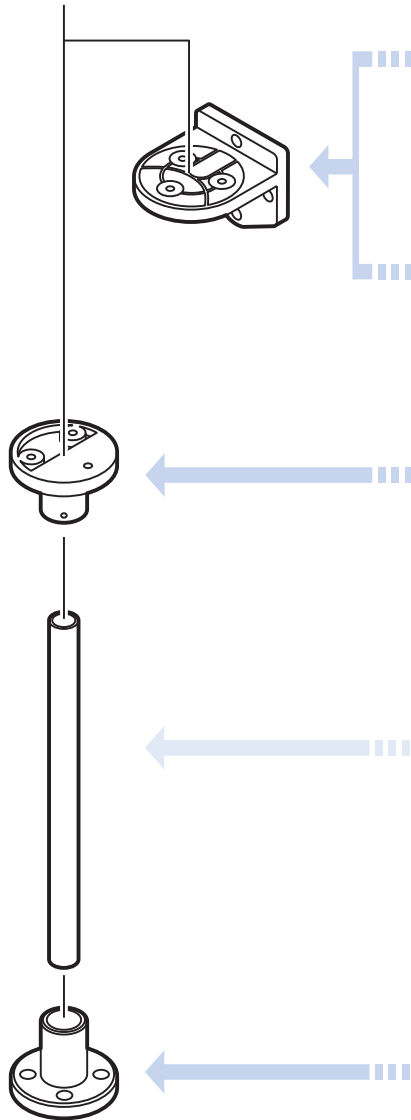

Wall mount bracket

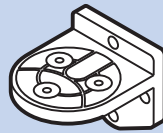

Model	SZ-18	SZ-18U	SZ-18K
Color	Ivory white	Silver color (U)	Black (K)

Upper bracket

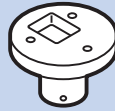

SZ-50NPT(For 1/2" NPT pole)

Upper bracket

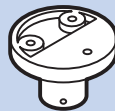

Model	SZ-50-U	SZ-50U-U	SZ-50K-U
Color	Ivory white	Silver color (U)	Black (K)

Pole



Steel pole

Model	POLE-800S21	POLE-300S21	POLE-100S21
Height	800 mm	300 mm	100 mm

Aluminum pole

Model	POLE-800A21	POLE-300A21	POLE-100A21
Height	800 mm	300 mm	100 mm

Mount bracket

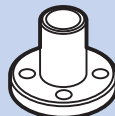

SZ-016A
(For Ø21.7 mm pole)

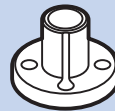

SZ-70-B
(For Ø21.7 mm Aluminum pole only)

Wall mount bracket



SZ-020
(For Ø21.7 mm pole)

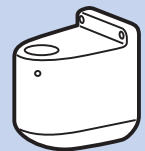

SZ-017
(For Ø21.7 mm pole)

Specifications

Size	70 mm diameter
Input voltage options	• 24 VDC
Functions available	• Continuous only • Continuous, flashing, alarms
Mounting options	Direct mount only: includes three mounting nuts
Body style	• Component style, wiring terminals provided • Interchangeable and stackable after purchase
Body color	• Beige • Black • Silver
Tiers	1-5 modules can be stacked
Module colors	• Red / Yellow / Green / Blue / Clear • Standard LED modules • Strobe-flash LED modules (24 V bases only)
Alarms (FB style only)	• Alarm 1: selectable, single-tone, continuous alarm, 90 dB (at 1 m) • Alarm 2: selectable, single tone, intermittent (slow beep) alarm, 90 dB (at 1 m)
Ratings	• CE • UL listed (US) • UL listed (Canada) • RoHS
Protections	• IP-65 • Type 4/4X/13 (indoor only)
Control options	• Dry contact closure such as switches or relay contacts • Open-collector transistor (NPN or PNP for 24 VDC) • Direct voltage control for 24 VDC, continuous and alarm functions only

PATLITE distributed by Omron

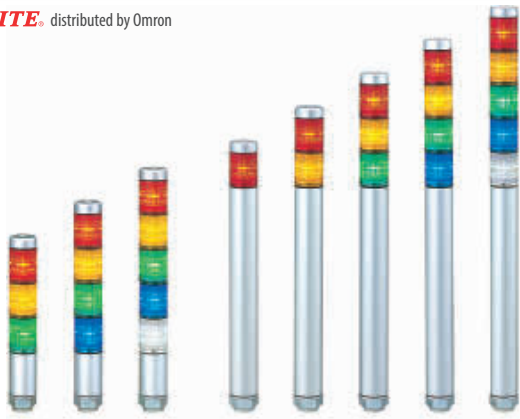

Super slim 30 mm silver body signal tower ideal for small devices

MP/MPS signal towers provide double insulation and superior UV and light translucent AS resin lenses for enhanced durability and reliability in the application environment. The 30mm diameter is ideal for small and mid-sized machines. Up to 5 colored modules can be combined using a single mounting hole. Modules can be easily added without dismantling the whole signal tower to reduce installation effort.

- Special pre-wired versatile with 1 connection cable
- NPN/ PNP compactible
- IP65
- Each color of LED module corresponds to the lead wire color.
- Available colors are Red, Yellow, Green, Blue and Clear/White. All colors as clear-lens modules available

Ordering information

MP-502-RYGBC-B0738
 1 2 3 4 5

- | | | |
|---|--|---|
| 1. MP: Standard body
MPS: Short body | 4. Color of LED
R: Red
Y: Yellow
G: Green
B: Blue
C: Clear/White
Top to bottom | 5. Color of lense
Blank: Colored lens
B0738: Clear lens |
|---|--|---|

Ordering information

Number of stacks	Rated voltage	Power consumption	Open collector	Order code
1	24 VAC/VDC	0.7 W	NPN/PNP	MP/MPS-102
2		1.4 W		MP/MPS-202
3		2.0 W		MP/MPS-302
4		2.6 W		MP/MPS-402
5		3.2 W		MP/MPS-502

Features

Patented reflection system increases visibility.

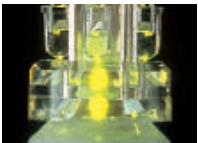

High intensity LED



Good visibility from any direction

Interchangeable LED modules

- Changeable color sequence: Easy to add/remove up to 5 colored modules even after installation.
- Note: LED modules of the same color will light up simultaneously.

The wiring remains the same.

Each color of LED module corresponds to the lead wire color.



Dimensions

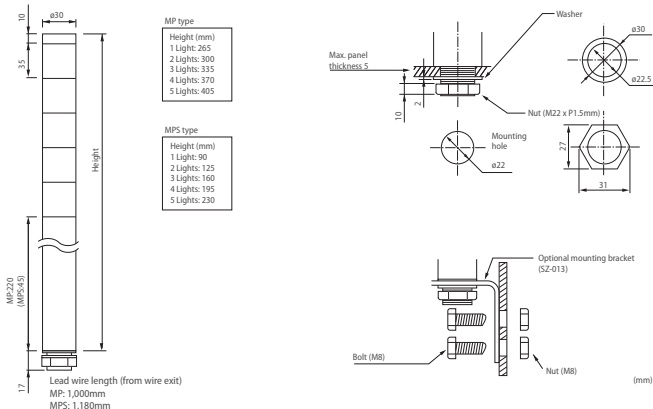

Wiring diagram

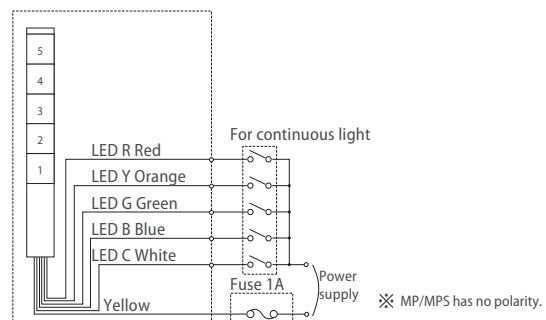

Specifications

Size	30 mm diameter
Input voltage options	24 VAC/VDC
Functions available	Continuous only
Mounting options	Direct mount only: includes M22 mounting nut and sealing gasket
Body style	<ul style="list-style-type: none"> • pre-assembled, pre-wired • Interchangeable and stackable after purchase
Body color	Silver
Tiers	1-5 modules can be stacked
Module colors	Red / Yellow / Green / Blue / Clear-White (for sunlight applications: clear-lense modules in all colors available)
Alarms (FB style only)	<ul style="list-style-type: none"> • CE • UL component recognition (US) • UL component recognition (Canada) • RoHS
Protection	IP-65
Control options	<ul style="list-style-type: none"> • Dry contact closure such as switches or relay contacts • Open-collector transistor (NPN or PNP) for 24 VDC • Direct voltage control

PATLITE® distributed by Omron



Versatile, cost and energy efficient LED signal tower for every need

The LME series indicating light provides the latest in LED technology. 1 to 5 modules can be arranged in tiers. The original dual reflection system for enhanced light diffusion, creates bright distinctive illumination while saving energy (patent pending). LME signal towers provide double insulation and superior UV resistant and light translucent AS resin lenses for enhanced durability and reliability in application environment.

Available Colors are Red, Yellow, Green, Blue and Clear/White.

All colors as clear-lense modules are available

- Diameter: 60 mm
- 2 selectable built-in alarms with adjustable volume up to 90 dB at 1 m for FB type
- Special pre-wired versatile and flexible cable connection of 3 m
- NPN/ PNP compatible
- IP 65

Ordering information

LME-502UFBW-C-RYGBC-Z
 1 2 3 4 5 6 7 8

- | | | |
|---|---|---|
| <p>1. Stack
1 ~ 5</p> <p>2. Rated voltage
02: 24V AC/DC</p> <p>3. Body color
Blank: Ivorywhite
N: Black color
U: Silver color</p> | <p>4. Type
Blank: Continuous light
FB: Continuous light or flashing light with audible alarm</p> <p>5. Mount
Blank: Pole mount
K: Polemount (with SZ-020)
W: Direct mount</p> <p>6. Connection
C: pre-wired cable 3 m</p> | <p>7. Color of LED
R: Red
Y: Yellow
G: Green
B: Blue
C: Clear/White</p> <p>8. Color of Lens
Blank: Colored lens
Z: Clear lens</p> |
|---|---|---|

Ordering information

Number of stacks	Mount	Model	Rated voltage	Power consumption	Open collector	Order code	
						Continuous light	Continuous light with audible alarm
1	Pole mount	LME-102	24 VAC/DC	2.2 W	NPN/PNP	LME-102-C	LME-102-FB-C
	Direct mount		24 VAC/DC			LME-102W-C	LME-102-FBW-C
2	Pole mount	LME-202	24 VAC/DC	3.4 W		LME-202-C	LME-202-FB-C
	Direct mount		24 VAC/DC			LME-202W-C	LME-202-FBW-C
3	Pole mount	LME-302	24 VAC/DC	3.8 W		LME-302-C	LME-302-FB-C
	Direct mount		24 VAC/DC			LME-302W-C	LME-302-FBW-C
4	Pole mount	LME-402	24 VAC/DC	4.2 W		LME-402-C	LME-402-FB-C
	Direct mount		24 VAC/DC			LME-402W-C	LME-402-FBW-C
5	Pole mount	LME-502	24 VAC/DC	4.6 W		LME-502-C	LME-502-FB-C
	Direct mount		24 VAC/DC			LME-502W-C	LME-502-FBW-C

Optional parts

Typ	Material	Order code
Wall mount bracket	Aluminum alloy die-cast	SZ-017
	ABS resin	SZ-020
	PBT/ ABS resin	SZ-028
Mount bracket	Aluminum alloy die-cast	SZ-016A
	Aluminum alloy die-cast	SZ-010

Typ	Height	Material	Order code
Pole	100 mm	Aluminum	Pole-100A21
		Steel	Pole-100S21
	300 mm	Aluminum	Pole-300A21
		Steel	Pole-300S21
	800 mm	Aluminum	Pole-800A21
		Steel	Pole-800S21

Dimensions

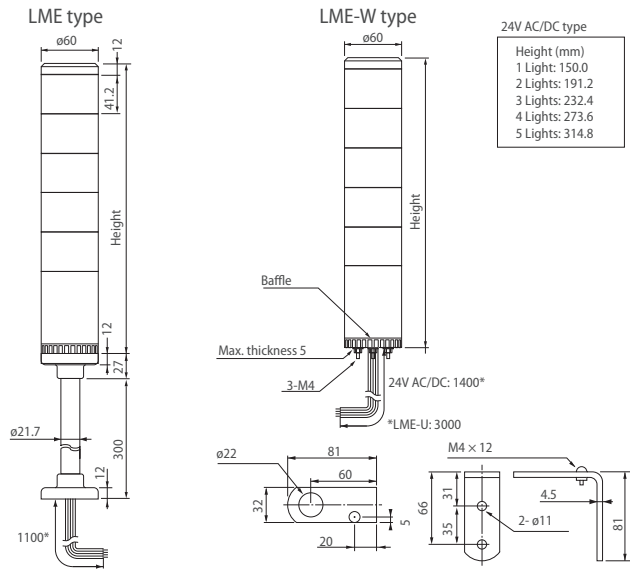

Wiring diagram

LME(-W)/LME(-W)-S-Q/LMS [Continuous type]

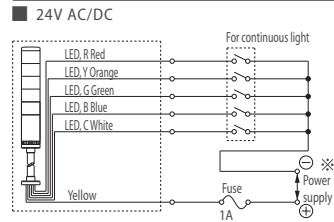

Features

Interchangeable LED modules

- Changeable color sequence: Easy to add / remove up to 5 colored modules even after installation.
- Note: LED modules of the same color within a signal tower will light up simultaneously.

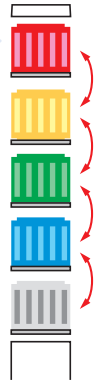

Easy to add and remove

If the number of LED module is changed, center shaft must be purchased.

The wiring remains the same

Each color of LED module corresponds to the lead wire color.

Dual reflection system

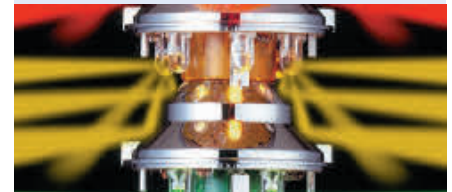

PATLITE's original dual reflection system with its exclusive hybrid prism-cut lens and 5 color LED modules create bright, distinctive, even illumination.



To bring more attention to certain conditions, two, User-selectable, Alarms integrated in the Base module with adjustable volume up to 85 dB at 1m are available.

Specifications

Size	60 mm diameter
Input voltage options	• 24 VAC/VDC
Functions available	• Continuous only • Continuous, flashing, alarms
Mounting options	• Pole mount: with 300 mm aluminum pole, plastic circular bracket • Direct mount: includes 3 mounting nuts
Body style	• Pre-assembled, pre-wired • Interchangeable and stackable after purchase
Body color	Beige (optional: Black or silver)
Tiers	1-5 modules can be stacked
Module colors	Red / Yellow / Green / Blue / Clear/White (for sunlight applications: clear-lense modules in all colors available)
Alarms (FB style only)	• Alarm 1: selectable, single-tone, intermittent (fast beep) alarm, 85 dB (at 1 m) • Alarm 2: selectable, single tone, intermittent (slow beep) alarm, 85 dB (at 1 m)
Ratings	• CE • UL component recognition (US) • UL component recognition (Canada) • RoHS
Protection	• IP-65 (LME, LME-W) • IP-54 (LME-FB, LME-FBW) • Type 4/4X/13 (indoor, direct-mount only)
Control options	• Dry contact closure such as switches or relay contacts • Open-collector transistor (NPN or PNP for 24 VDC) • Direct voltage control for 24 VDC, continuous and alarm functions only

Safety limit switches

PRECISE MONITORING OF GUARD POSITION

Detect linear or rotational movement of guards: D4N

Guards and covers on machines protect workers. They limit access to the dangerous parts of the machine. Our safety limit switches guarantee that the guards and covers are in place before the machine is started.

- Wide variety of actuators to fit wide range of applications
- Gold-plated contacts for reliable operation with micro loads

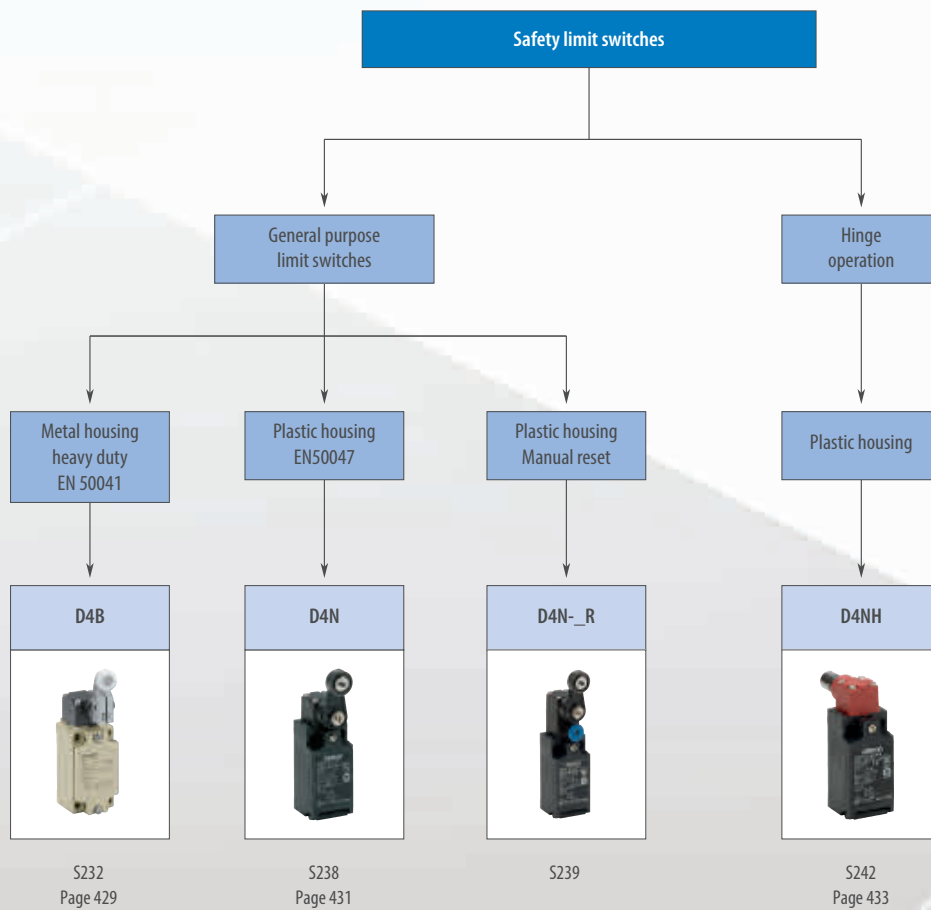

		Safety limit switches			
					
Model		D4B	D4N	D4NH	D4N- R
Selection criteria	Housing	Metal	Plastic	Plastic	Plastic
	M12 Plug connector	-	■	■	-
	Protection class	IP67			
	Operating Temperature Range	-40 to 80°C	-30 to 70°C	-30 to 70°C	-30 to 70°C
	Conformity	EN50047, EN1088			
Features	Conduit size M20	■	■	■	■
	Gold clad contacts	■	■	■	■
	Actuators				
	Resin roller, resin lever	-	■	-	■
	Resin roller, metal lever	■	■	-	-
	Metal roller, metal lever	-	■	-	-
	Bearing lever, metal lever	-	■	-	-
	Adj. resin roller, metal lever	■	■	-	■
	Adj. Rubber roller, metal lever	-	■	-	■
	Adj. Rod lever	■	-	-	-
	Top plunger	■	■	-	■
	Top roller plunger	■	■	-	■
	Horizontal roller arm lever	-	■	-	■
	Vertical roller arm lever	-	■	-	■
	Cat whisker	-	■	-	-
	Plastic Rod	■	■	-	-
	Fork lever lock (right operation)	-	■	-	-
	Fork lever lock (left operation)	-	■	-	-
Hinge operation	■	-	■	-	
Application	Position monitoring	■	■	■	■
Contact configuration	1NC/1NO snap action	■	■	-	-
	2NC snap action	-	■	-	-
	1NC/1NO slow action	■	■	■	■
	2NC slow action	■	■	■	■
	2NC/1NO slow action	-	■	■	■
	3NC slow action	-	■	■	■
	1NC/1NO (MBB slow action)	-	■	■	-
	2NC/1NO (MBB slow action)	-	■	■	-
Page/Quick Link	429	431	433	S239	

■ Standard

- No/not available









Limit switch with metal housing

The D4B series of limit switches in a rugged metal housing is suitable for both safety and non-safety applications due to its direct opening mechanism and TÜV approval. Furthermore with the increased temperature range and enhanced mechanical switching lifetime, the D4B is first choice for all applications from standard to demanding environments and for highest flexibility in mounting and connectivity preferences.

- Direct opening mechanism and approval by notified body
- Rugged metal housing and extended mechanical switching lifetime (snap action models)
- Terminal block for direct wiring

Ordering information

Actuator type		Connection method	Order code*1		
			1NC/1NO (snap-action)	1NC/1NO (slow-action)	2NC (slow-action)
	Roller lever*2	Terminal block with M20 conduit	D4B-4111N	D4B-4511N	D4B-4A11N
	Adjustable roller lever		D4B-4116N	D4B-4516N	D4B-4A16N
	Adjustable rod lever		D4B-4117N	D4B-4517N	D4B-4A17N
	Plain		D4B-4170N	D4B-4570N	D4B-4A70N
	Roller		D4B-4171N	D4B-4571N	D4B-4A71N
	Coil spring		D4B-4181N*3	–	–
	Plastic rod		D4B-4187N*3	–	–

*1 The NC contacts provide the approved direct opening mechanism. 

*2 For models with stainless steel rollers and temperature resistance of –40°C refer to WL-_-TC.

*3 No direct opening mechanism

Specifications

Item		Snap-action	Slow-action
Durability*1	Mechanical	30,000,000 operations min.	10,000,000 operations min.
	Electrical	500,000 operations min. (at a 250 VAC, 10 A resistive load)	
Operating speed		1 mm/s to 0.5 m/s	
Operating frequency	Mechanical	120 operations/min	
	Electrical	30 operations/min	
Rated frequency		50/60 Hz	
Contact resistance		25 mΩ max. (initial value)	
Pollution degree (operating environment)		3 (EN60947-5-1)	
Conditional short-circuit current		100 A (EN60947-5-1)	
Conventional enclosed thermal current (I _{th})		20 A (EN60947-5-1)	
Protection against electric shock		Class I (with ground terminal)	
Ambient temperature	Operating	–40 to 80°C (with no icing)*2	
Degree of protection		IP67 (EN60947-5-1)	

*1 The values are acquired for an ambient temperature of 5 to 35°C and an ambient humidity of 40 to 70%.

*2 –25 to 80°C for the flexible-rod actuator.

1NO/1NC Contact (Snap-action)

If metal deposition between mating contacts occurs on the NC contact side, they can be pulled apart by the shearing force and tensile force generated when part B of the

safety cam or plunger engages part A of the movable contact blade. When the safety cam or plunger is moved in the direction of the arrow, the Limit Switch releases.

1. When metal deposition occurs.

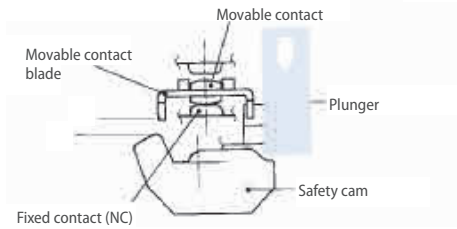

2. When contacts are being pulled apart.

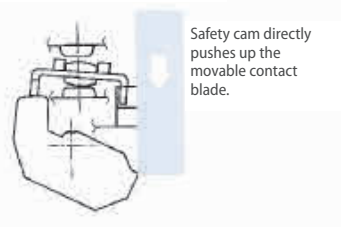

3. When contacts are completely pulled apart.

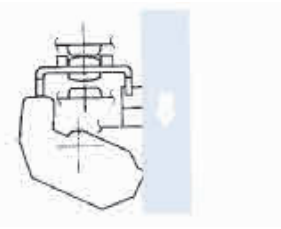

1NC/1NO Contact (Slow-action)

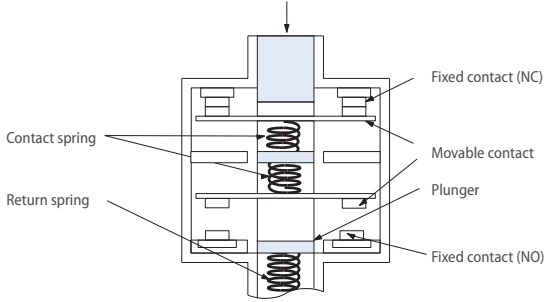

2NC Contact (Slow-action)

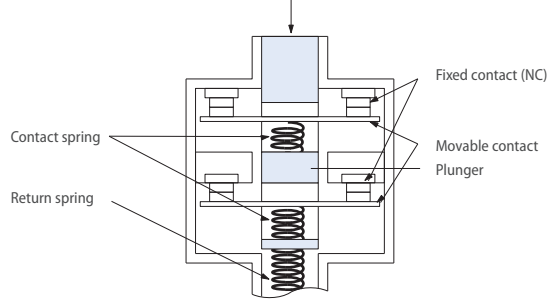

NC contacts conform to EN60947-5-1 Direct Opening

When metal deposition occurs, the contacts are separated from each other by the plunger being pushed in.

⊖ is marked on the product to indicate approval of direct opening.









Limit switch with plastic housing

The D4N series of limit switches in plastic housing is the ideal switch for all standard mechanical position detection applications both for safety and non-safety applications.



- Direct opening mechanism and approval by notified body
- Rugged plastic housing with double insulation
- Wide range of actuators
- M12 connectors or terminal block with M20 conduit

Ordering information

Actuator type		Connection method	Order code ^{*1}			
			1NC/1NO (snap-action)	1NC/1NO (slow-action)	2NC (slow-action)	2NC/1NO (slow-action)
	Roller lever (resin lever, resin roller)	M20	D4N-4120	D4N-4A20	D4N-4B20	D4N-4C20
		M12 connector	D4N-9120	D4N-9A20	D4N-9B20	–
	Plunger	M20	D4N-4131	D4N-4A31	D4N-4B31	–
		M12 connector	D4N-9131	D4N-9A31	D4N-9B31	–
	Roller plunger	M20	D4N-4132	D4N-4A32	D4N-4B32	D4N-4C32
		M12 connector	D4N-9132	D4N-9A32	D4N-9B32	–
	One-way roller arm lever (horizontal)	M20	D4N-4162	D4N-4A62	D4N-4B62	D4N-4C62
		M12 connector	D4N-9162	D4N-9A62	D4N-9B62	–
	One-way roller arm lever (vertical)	M20	D4N-4172	D4N-4A72	D4N-4B72	–
	Adjustable roller lever, form lock (metal lever, resin roller)	M20	D4N-412G	D4N-4A2G	D4N-4B2G	–
		M12 connector	D4N-912G	D4N-9A2G	D4N-9B2G	–
	Adjustable roller lever, form lock (metal lever, rubber roller)	M20	D4N-412H	D4N-4A2H	D4N-4B2H	–
		M12 connector	D4N-912H	D4N-9A2H	D4N-9B2H	–

Switches with MBB contacts

MBB (Make Before Break) contacts have an overlapping structure, so that before the normally closed (NC) contact opens the normally open (NO) contact closes.

Actuator type		Connection method	Order code ^{*1}	
			1NC/1NO (slow-action)	2NC/1NO (slow-action)
	Roller lever (resin lever, resin roller)	M20	D4N-4E20	D4N-4F20
		M12 connector	D4N-9E20	–
	Roller plunger	M20	D4N-4E32	D4N-4F32
		M12 connector	D4N-9E32	–
	One-way roller arm lever (horizontal)	M20	D4N-4E62	D4N-4F62
		M12 connector	D4N-9E62	–

^{*1} The NC contacts provide the approved direct opening mechanism. 

Specifications

Durability*1	Mechanical	15,000,000 operations min.*2
	Electrical	500,000 operations min. for a resistive load of 3 A at 250 VAC 300,000 operations min. for a resistive load of 10 A at 250 VAC
Operating speed	Roller lever	1 mm/s to 0.5 m/s
Operating frequency		30 operations/minute max.
Minimum applicable load		Resistive load of 1 mA at 5 VDC (N-level reference value)
Protection against electric shock		Class II (double insulation)
Pollution degree (operating environment)		3 (EN60947-5-1)
Contact gap		Snap-action: 2x0.5 mm min Slow-action: 2x2 mm min
Conditional short-circuit current		100 A (EN60947-5-1)
Rated open thermal current (I _{th})		10 A (EN60947-5-1)
Ambient temperature	Operating	-30°C to 70°C with no icing
Degree of protection		IP67 (EN60947-5-1)

*1 The durability is acquired for an ambient temperature of 5°C to 35°C and an ambient humidity of 40 to 70%.

*2 10,000,000 operations min. for fork lever actuator.

1NO/1NC Contact (Snap-action)

If metal deposition between mating contacts occurs on the NC contact side, they can be pulled apart by the shearing force and tensile force generated when part B of the

safety cam or plunger engages part A of the movable contact blade. When the safety cam or plunger is moved in the direction of the arrow, the Limit Switch releases.

1. When metal deposition occurs.
2. When contacts are being pulled apart.
3. When contacts are completely pulled apart.

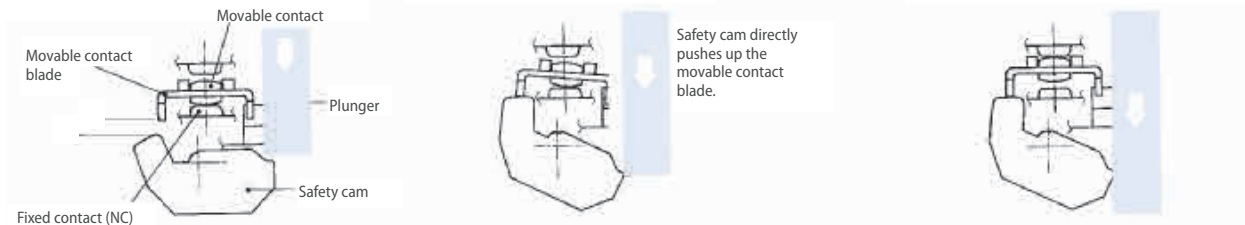

1NC/1NO Contact (Slow-action)

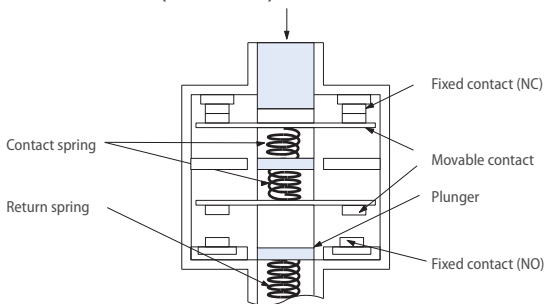

2NC Contact (Slow-action)

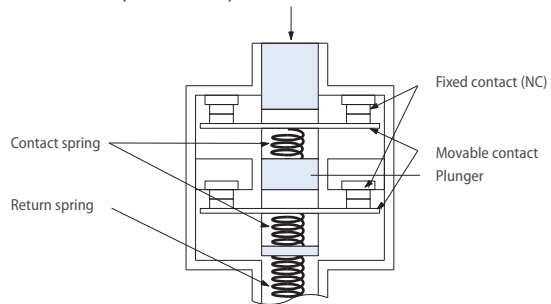

NC contacts conform to EN60947-5-1 Direct Opening

When metal deposition occurs, the contacts are separated from each other by the plunger being pushed in.

⊖ is marked on the product to indicate approval of direct opening.



Safety door hinge switch

D4NH safety-door hinge switches are available with one or two built-in contacts, shaft or arm lever actuator and various conduit types, e.g. M20.

- Direct opening mechanism
- Shaft or arm lever actuator
- Wide temperature range
- Metric conduit and M12 connector types are available

Ordering information

Switches

Actuator	Conduit size		Built-in switch mechanism		
			1NC/1NO (slow-action)	2NC (slow-action)	2NC/1NO (slow-action)
Shaft	1-conduit	M20	D4NH-4AAS	D4NH-4BAS	D4NH-4CAS
		M12 connector	D4NH-9AAS	D4NH-9BAS	–
Arm lever	1-conduit	M20	D4NH-4ABC	D4NH-4BBC	D4NH-4CBC
		M12 connector	D4NH-9ABC	D4NH-9BBC	–

Actuator	Conduit size		Built-in switch mechanism		
			3NC (slow-action)	1NC/1NO MBB (slow-action)	2NC/1NO MBB (slow-action)
Shaft	1-conduit	M20	D4NH-4DAS	D4NH-4EAS	D4NH-4FAS
		M12 connector	–	D4NH-9EAS	–
Arm lever	1-conduit	M20	D4NH-4DBC	D4NH-4EBC	D4NH-4FBC
		M12 connector	–	D4NH-9EBC	–

Specifications

Degree of protection		IP67 (EN60947-5-1)
Durability	Mechanical	1,000,000 operations min.
	Electrical	500,000 operations min. for a resistive load of 3 A at 250 VAC 300,000 operations min. for a resistive load of 10 A at 250 VAC
Operating speed		2 to 360°/s
Operating frequency		30 operations/minute max.
Protection against electric shock		Class II (double insulation)
Pollution degree (operating environment)		3 (EN60947-5-1)
Contact gap		Snap-action: 2 × 9.5 mm min Slow-action: 2 × 2 mm min
Conditional short-circuit current		100 A (EN60947-5-1)
Rated open thermal current (I _{th})		10 A (EN60947-5-1)
Ambient temperature		Operating: –30°C to 70°C with no icing

BREAK CONVENTIONAL BARRIERS IN SAFETY DESIGN

Flexibility selecting best fit control device for non-contact switch application: F3S-TGR-N

Omron has introduced a series of magnetic coded contactless switches for interlocking machine guard doors. The switches feature a built-in control function, thus saving the cost and space required for an external controller. The non-contact switches offer advantages in applications where a precise approach of the guard and lock is not possible. Applications with a large amount of dirt or high hygienic standards can also be addressed.

- Operates with all Omron safety relay units and safety bus interfaces
- Operates behind stainless steel fittings
- Non-contact – no abrasion – no particles
- Conforms to safety categories up to 4 acc. EN 954-1 and PLe acc. EN ISO 13849-1

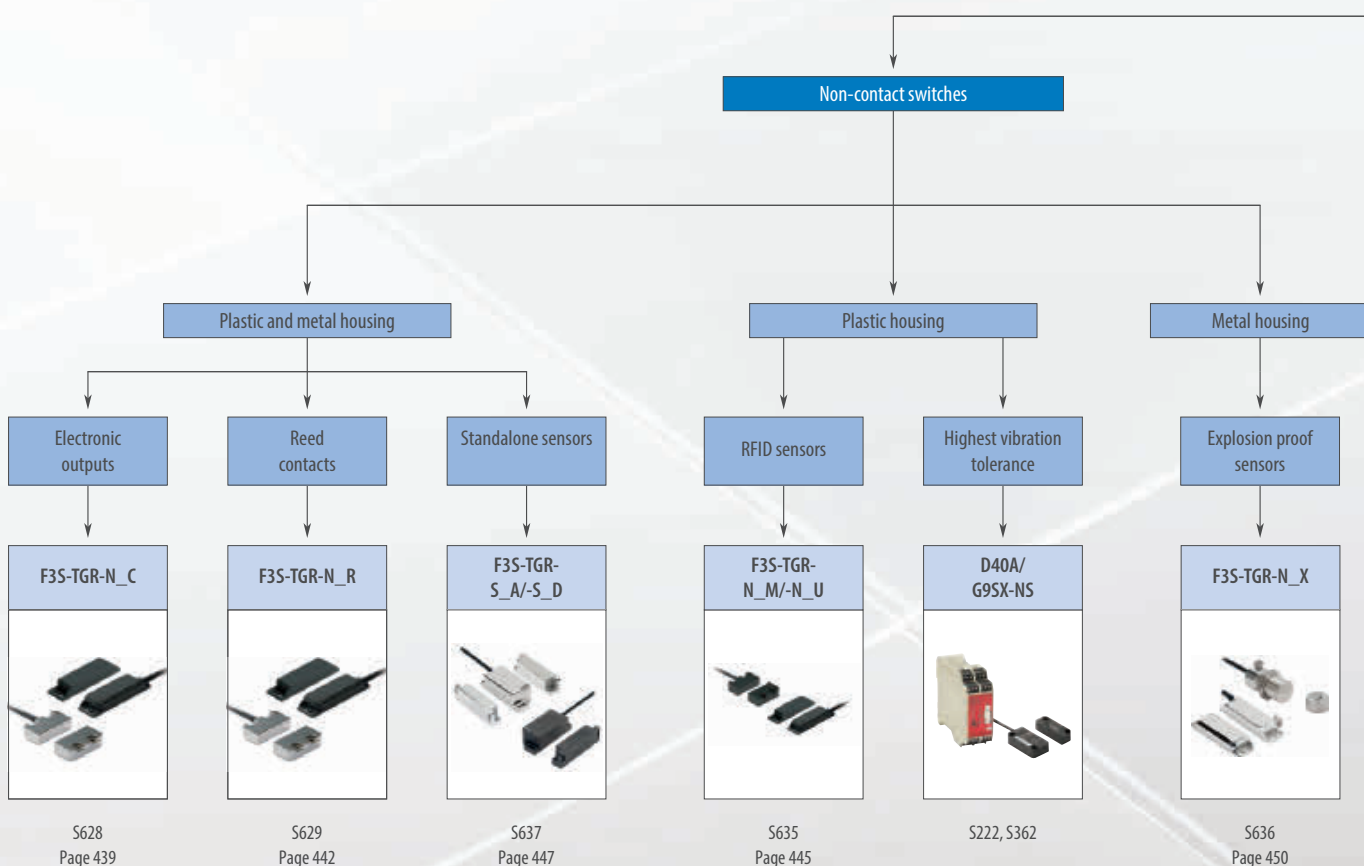





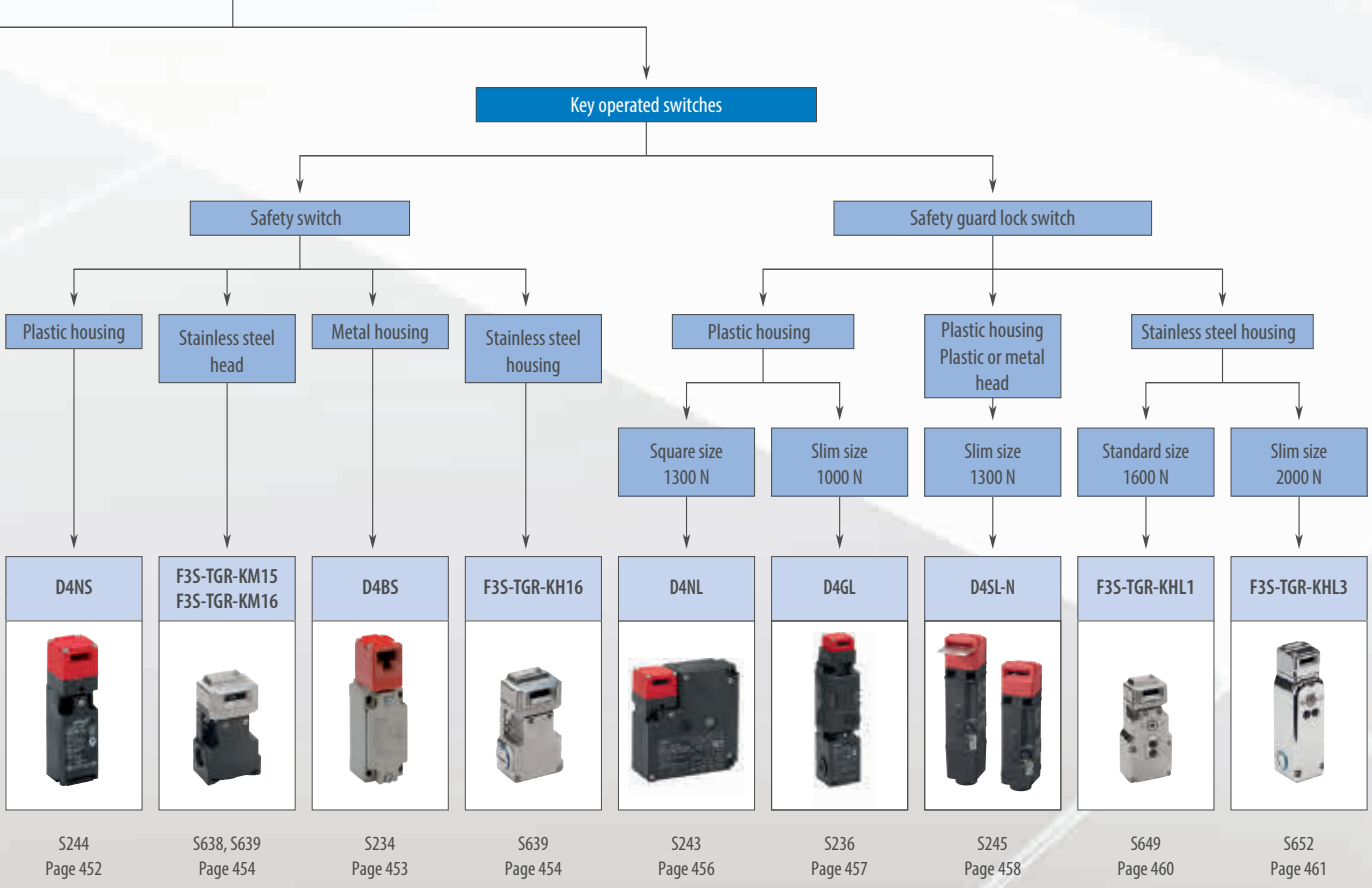





Safety door switches



Selection table

		Non-contact safety door switches					
							
Model		F35-TGR-N_C	F35-TGR-N_R	F35-TGR-N_M/-N_U	F35-TGR-S_A/-S_D	F35-TGR-N_X	D40A/G95X-NS
Selection criteria	Housing	Plastic/Metal	Plastic/Metal	Plastic	Plastic/Metal	Metal	Plastic
	Protection class	IP67/IP69K	IP67/IP69K	IP67/IP69K	IP67/IP69K	IP67	IP67
	Conformity	EN ISO 13849-1, EN60947-5-3	EN ISO 13849-1, EN60947-5-3	EN ISO 13849-1, EN60947-5-3	EN ISO 13849-1, EN60947-5-3	EN ISO 13849-1, EN60947-5-3	EN ISO 13849-1
Features	Cable length 2 m	■	■	-	-	-	■
	Cable length 5 m	■	■	■	■	■	■
	Cable length 10 m	■	■	■	■	■	-
	Connector type M12	■	■	■	■	■	-
	High temperature sensor	■	■	-	-	-	-
	Operates with G95A, G95B	■	■	■	■	■	-
	Operates with G95X	■	■	■	■	■	■
	Operates with programmable safety units G95P and NE1A	■	■	■	■	■	-
Application	Door monitoring	■	■	■	■	■	■
Contact configuration	1NC/1NO	-	-	-	-	-	■
	2NC	■	■	-	-	-	-
	2NC/1NO	■	■	■	■	■	-
	Force guided relays	-	-	-	■	-	-
Page/Quick Link		439	442	445	447	450	S222, S362

		Safety door switches					Safety door lock switches				
											
Model		D4NS	F35-TGR-KM15	F35-TGR-KM16	D4BS	F35-TGR-KH16	D4NL	D4GL	D4SL-N	F35-TGR-KHL1	F35-TGR-KHL3
Selection criteria	Housing	Plastic	Plastic body Metal head	Plastic body Metal head	Metal	Stainless steel	Plastic	Plastic	Plastic/metal head available	Stainless steel	Stainless steel
	Head mounting	4 directions	2 directions	2 directions	4 directions	2 directions	4 directions	4 directions	4 directions	2 directions	4 directions
	Actuation	Straight	Straight	Straight	Straight	Straight	Straight	Straight	Straight	Straight	Straight
	Key holding force	-	-	-	-	-	1,300 N	1,000 N	1,300 N	1,600 N	2,000 N
	Protection class	IP67	IP67	IP67	IP67	IP69k	IP67	IP67	IP67	IP69k	IP69k
	Conformity	EN50047, EN1088	EN1088	EN1088	EN50047, EN1088	EN1088	EN1088	EN1088	EN1088	EN1088	EN1088
Features	Conduit size M20	■	■	■	PG 13.5	■	■	■	■	■	■
	Screw terminal	■	■	■	■	■	■	■	■	■	■
	Connector terminal	-	-	-	-	-	-	-	■	-	-
	Operation key horizontal	■	■	■	■	■	■	■	■	■	■
	Operation key vertical	■	■	■	■	■	■	■	■	■	■
	Operation key adjustable horizontal	■	■	■	■	■	■	■	■	■	■
	Operation key adjustable horizontal and vertical	■	■	■	-	■	■	■	■	■	■
	Mechanical lock/ 24 VDC solenoid release	-	-	-	-	-	■	■	■	■	■
	Mechanical lock/ 110 VAC solenoid release	-	-	-	-	-	■	-	-	-	-
	Mechanical lock/ 230 VAC solenoid release	-	-	-	-	-	■	-	-	-	-
	24 VDC solenoid lock/ mechanical release	-	-	-	-	-	■	■	■	-	-
	110 VAC solenoid lock mechanical release	-	-	-	-	-	■	-	-	-	-
	240 VAC solenoid lock mechanical release	-	-	-	-	-	■	-	-	-	-
	High temperature sensor	-	-	-	-	-	-	-	-	-	-
	Operates with G9SR	■	■	■	■	■	■	■	■	■	■
	Operates with G9SA, G9SB	■	■	■	■	■	■	■	■	■	■
	Operates with G9SX	■	■	■	■	■	■	■	■	■	■
	Operates with programmable safety units G9SP and NE1A	■	■	■	■	■	■	■	■	■	■
Application	Door monitoring	■	■	■	■	■	■	■	■	■	■
	Door locking	-	-	-	-	-	■	■	■	■	■
Contact configuration	2 contact models	■	-	-	■	-	-	-	-	-	-
	3 contact models	■	■	■	-	■	-	-	-	-	-
	4 contact models	-	-	-	-	-	-	■	■	■	■
	5 contact models	-	-	-	-	-	■	■	■	-	-
	6 contact models	-	-	-	-	-	-	-	■	-	-
	Slow action contacts	■	■	■	-	■	-	-	-	■	■
Page/Quick Link	452	454	454	453	454	456	457	458	460	461	

■ Standard

- No/not available







Hall coded non-contact for monitoring the status of guarding doors

Hall coded non-contact switches monitor the status of guarding doors. Stainless steel housing for high hygiene demands in the food industry are available.

- Based on hall technology
- Connect up to 3 switches in series
- LED supports easy diagnosis
- Operates with all OMRON safety controllers
- Operates behind stainless steel fittings
- Non-contact – no abrasion – no particles
- Compensation of mechanical tolerances
- Suitable for high pressure cleaning, CIP/SIP processes due IP69K (pre-wired types)
- Conforms to safety categories up PLe acc. EN ISO13849-1



Ordering information

Polyester housing



Type	Cable connection	Contact configuration	Order code
Elongated sensors 	5 m pre-wired	2NC/1NO	F3S-TGR-NLPC-21-05
	10 m pre-wired		F3S-TGR-NLPC-21-10
	M12, 8-pin		F3S-TGR-NLPC-21-M1J8
Small sensors 	5 m pre-wired		F3S-TGR-NSPC-21-05
	10 m pre-wired		F3S-TGR-NSPC-21-10
	M12, 8-pin		F3S-TGR-NSPC-21-M1J8
Miniature sensors 	5 m pre-wired ^{*1}		F3S-TGR-NMPC-21-05
	10 m pre-wired ^{*1}		F3S-TGR-NMPC-21-10
	M12, 8-pin ^{*1}		F3S-TGR-NMPC-21-M1J8
Barrel sensors 	5 m pre-wired	F3S-TGR-NBPC-21-05	
	10 m pre-wired	F3S-TGR-NBPC-21-10	
	M12, 8-pin	F3S-TGR-NBPC-21-M1J8	

^{*1} Optional cable exit to the right side is available for F3S-TGR-NMPC-types. Please add “-R” to the order code (i.e. F3S-TGR-NMPC-21-05-R)

Stainless steel housing

Type	Cable connection	Contact configuration	Order code
Elongated sensors 	5 m pre-wired	2NC/1NO	F3S-TGR-NLMC-21-05
	10 m pre-wired		F3S-TGR-NLMC-21-10
	M12, 8-pin		F3S-TGR-NLMC-21-M1J8
Small sensors 	5 m pre-wired		F3S-TGR-NSMC-21-05
	10 m pre-wired		F3S-TGR-NSMC-21-10
	M12, 8-pin		F3S-TGR-NSMC-21-M1J8
Barrel sensors 	5 m pre-wired		F3S-TGR-NBMC-21-05
	10 m pre-wired		F3S-TGR-NBMC-21-10
	M12, 8-pin		F3S-TGR-NBMC-21-M1J8

Hygienic and food types

Type	Cable connection	Contact configuration	Order code
 <p>Small sensors</p>	5 m pre-wired	2NC/1NO	F3S-TGR-NSHC-21-05
	10 m pre-wired		F3S-TGR-NSHC-21-10
	M12, 8-pin		F3S-TGR-NSHC-21-M1J8
 <p>Small sensors (Special food type)</p>	5 m pre-wired		F3S-TGR-NSFC-21-05
	10 m pre-wired		F3S-TGR-NSFC-21-10
	M12, 8-pin		F3S-TGR-NSFC-21-M1J8
 <p>Miniature sensors</p>	5 m pre-wired* ¹		F3S-TGR-NMHC-21-05
	10 m pre-wired* ¹		F3S-TGR-NMHC-21-10
	M12, 8-pin* ¹		F3S-TGR-NMHC-21-M1J8

*¹ Optional cable exit to the right side is available for F3S-TGR-NMHC-types. Please add "R" to the order code (i.e. F3S-TGR-NMHC-21-05-R)

Specifications

Mechanical data

Item	Model	Polyester types	Stainless steel types
Serial switching		up to 3 pcs.	
Indicator LED	-	LED green - Indication of safety circuit closed	
Operating distance* ¹	OFF → ON (Sao)	Min. 8 mm/max. 10 mm	
	ON → OFF (Sar)	Min. 12 mm/max. 22 mm	
Actuator approach speed	Min.	4 mm/s	
	Max.	1,000 mm/s	
Operating temperature	-	-25 to 80°C	-25 to 105°C
Enclosure protection	Flying lead	IP69K	
	M12 connector	IP67	
Material cable	Flying lead	PVC, Ø 6 mm o.d.	
	M12 connector	250 mm, PVC, Ø 6 mm o.d.	
Material housing	-	Black polyester	Stainless steel 316

*¹ Depends on type. Please see online data sheet.

Electrical data

Item	Model	Polyester types	Stainless steel types
Sensor technology	-	Hall	
Power supply	-	24 VDC±15%	
Power consumption	Max.	50 mA	
Switching current	Min.	10 mA, 10 VDC	
Rated loads	NC contacts NO contact	Max.	200 mA, 24 VDC
			200 mA, 24 VDC
Output type	-	Electronic output (potential-free optocoupler output)	

Approved standards

EN standards certified by TÜV Rheinland
EN ISO13849-1
EN 62061
EN ISO 14119
EN 60204-1
EN/IEC 60947-5-3
UL 508, CSA C22.2
BS 5304
EN 1088-1 conformance

Accessories

		Order code
Cables 8-pin	2 m	Y92E-M12PURSH8S2M-L
	5 m	Y92E-M12PURSH8S5M-L
	10 m	Y92E-M12PURSH8S10M-L
	25 m	Y92E-M12PURSH8S25M-L
T-connector connection cable	M12 T-connector for M12 connector-types	F39-TGR-NT
	0.6 m, M12-8pin	Y92E-M12FSM12MSPURSH806M-L
	2 m, M12-8pin	Y92E-M12FSM12MSPURSH82M-L
	5 m, M12-8pin	Y92E-M12FSM12MSPURSH85M-L
	10 m, M12-8pin	Y92E-M12FSM12MSPURSH810M-L
Actuators	for F3S-TGR-NLPC	F39-TGR-NLPC-A
	for F3S-TGR-NSPC	F39-TGR-NSPC-A
	for F3S-TGR-NMPC	F39-TGR-NMPC-A
	for F3S-TGR-NCPC	F39-TGR-NCPC-A
	for F3S-TGR-NWPC	F39-TGR-NWPC-A
	for F3S-TGR-NBPC	F39-TGR-NBPC-A
	for F3S-TGR-NLMC	F39-TGR-NLMC-A
	for F3S-TGR-NSMC	F39-TGR-NSMC-A
	for F3S-TGR-NBMC	F39-TGR-NBMC-A
	for F3S-TGR-NSHC	F39-TGR-NSHC-A
	for F3S-TGR-NSFC	F39-TGR-NSFC-A
for F3S-TGR-NMHC	F39-TGR-NMHC-A	
Mounting screws	Set of Torx safety screws (M4, 4 × 30 mm, 4 × 20 mm, 4 × 10 mm; incl. washers and Torx bit)	F39-TGR-N-SCREWS

Wiring examples (Single head connection)

G9SA

Single sensor application with G9SA-301
(up to PLe acc. EN ISO 13849-1)

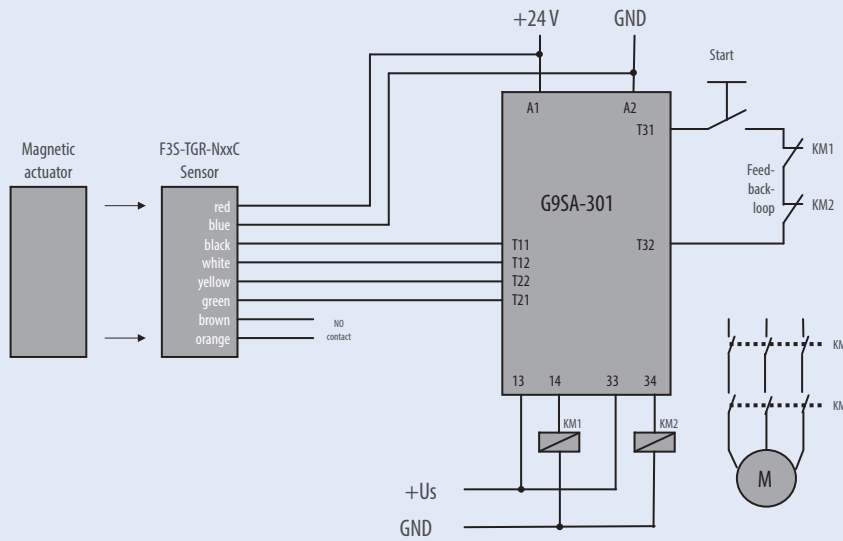

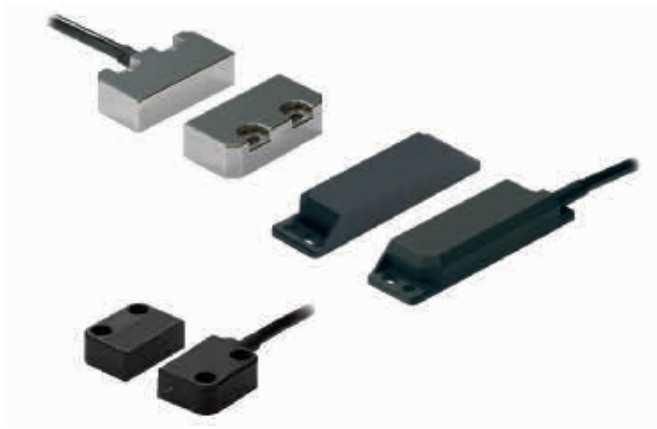





Reed non-contact switches for monitoring the status of guarding doors

Reed non-contact switches monitor the status of guarding doors. Stainless steel housing for high hygiene demands in the food industry are available.

- Based on reed technology
- Connect up to 6 switches in series
- Operates with all Omron safety controllers
- Operates behind stainless steel fittings
- Non-contact – no abrasion – no particles
- Compensation of mechanical tolerances
- Suitable for high pressure cleaning, CIP/SIP processes due IP69K (pre-wired types)
- Conforms to safety categories up PLe acc. EN ISO13849-1

Ordering information

Polyester housing



Type	Cable connection	Contact configuration	Order code	
 Elongated sensors	5 m pre-wired	2NC/1NO ^{*1}	F3S-TGR-NLPR-21-05	
	10 m pre-wired		F3S-TGR-NLPR-21-10	
	M12, 8-pin		F3S-TGR-NLPR-21-M1J8	
 Small sensors	5 m pre-wired		F3S-TGR-NSPR-21-05	
	10 m pre-wired		F3S-TGR-NSPR-21-10	
	M12, 8-pin		F3S-TGR-NSPR-21-M1J8	
 Miniature sensors	5 m pre-wired ^{*2}		2NC/1NO ^{*3}	F3S-TGR-NMPR-21-05
	10 m pre-wired ^{*2}			F3S-TGR-NMPR-21-10
	M12, 8-pin ^{*2}			F3S-TGR-NMPR-21-M1J8
 Barrel sensors	5 m pre-wired	F3S-TGR-NBPR-21-05		
	10 m pre-wired	F3S-TGR-NBPR-21-10		
	M12, 8-pin	F3S-TGR-NBPR-21-M1J8		

^{*1} 2NC: 1 A, 250 VAC/1NC: 0.2 A, 24 VDC

^{*2} Optional cable exit to the right side is available for F3S-TGR-NMPR-types. Please add “-R” to the order code (i.e. F3S-TGR-NMPR-21-05-R)

^{*3} 2NC: 0.5 A, 24 VDC/1NC: 0.2 A, 24 VDC



Stainless steel housing

Type	Cable connection	Contact configuration	Order code	
 Elongated sensors	5 m pre-wired	2NC/1NO ^{*1}	F3S-TGR-NLMR-21-05	
	10 m pre-wired		F3S-TGR-NLMR-21-10	
	M12, 8-pin		F3S-TGR-NLMR-21-M1J8	
 Small sensors	5 m pre-wired		F3S-TGR-NSMR-21-05	
	10 m pre-wired		F3S-TGR-NSMR-21-10	
	M12, 8-pin		F3S-TGR-NSMR-21-M1J8	
 Barrel sensors	5 m pre-wired		2NC/1NO ^{*2}	F3S-TGR-NBMR-21-05
	10 m pre-wired			F3S-TGR-NBMR-21-10
	M12, 8-pin			F3S-TGR-NBMR-21-M1J8

^{*1} 2NC: 1 A, 250 VAC/1NC: 0.2 A, 24 VDC

^{*2} 2NC: 0.5 A, 24 VDC/1NC: 0.2 A, 24 VDC

Hygienic and food types

Type	Cable connection	Contact configuration	Order code
Small sensors 	5 m pre-wired	2NC/1NO ^{*1}	F3S-TGR-NSHR-21-05
	10 m pre-wired		F3S-TGR-NSHR-21-10
	M12, 8-pin		F3S-TGR-NSHR-21-M1J8
Small sensors (Special food type) 	5 m pre-wired		F3S-TGR-NSFR-21-05
	10 m pre-wired		F3S-TGR-NSFR-21-10
	M12, 8-pin		F3S-TGR-NSFR-21-M1J8
Miniature sensors 	5 m pre-wired ^{*2}	2NC/1NO ^{*3}	F3S-TGR-NMHR-21-05
	10 m pre-wired ^{*2}		F3S-TGR-NMHR-21-10
	M12, 8-pin ^{*2}		F3S-TGR-NMHR-21-M1J8

^{*1} 2NC: 1 A, 250 VAC/1NC: 0.2 A, 24 VDC

^{*2} Optional cable exit to the right side is available for F3S-TGR-NMHR-types. Please add "-R" to the order code (i.e. F3S-TGR-NMHR-21-05-R

^{*3} 2NC: 0.5 A, 24 VDC/1NC: 0.2 A, 24 VDC

Specifications

Mechanical data

Item	Model	Plastic housing	Stainless steel housing
Serial switching		up to 6 pcs.	
Operating distance	OFF → ON (Sao)	10 mm Close	
	ON → OFF (Sar)	20 mm* Open	
Actuator approach speed	Min.	4 mm/s	
	Max.	1,000 mm/s	
Operating temperature	-	-25 to 80°C	-25 to 105°C
Enclosure protection	Flying lead	IP69K	
	M12 connector	IP67	
Material cable	Flying lead	PVC, Ø 6 mm o.d.	
	M12 connector	250 mm, PVC, Ø 6 mm o.d.	
Material housing	-	Black polyester	Stainless steel 316

* max. 22 mm, depends on the type

Electrical data

Item	Model	Plastic housing	Stainless steel housing
Indicator LED		none	
Contact release time	Max.	2 ms	
Initial contact resistance	Max.	500 mΩ	
Switching current	Min.	1 mA, 10 VDC	

Approved standards

EN standards certified by TÜV Rheinland
EN ISO13849-1
EN 60204-1
EN 62061
EN/IEC 60947-5-3
UL 508, CSA C22.2
BS 5304
EN 1088-1 conformance

Accessories

		Order code
Cables 8-pin	2 m	Y92E-M12PURSH8S2M-L
	5 m	Y92E-M12PURSH8S5M-L
	10 m	Y92E-M12PURSH8S10M-L
	25 m	Y92E-M12PURSH8S25M-L
Actuators	for F3S-TGR-NLPR	F39-TGR-NLPR-A
	for F3S-TGR-NSPR	F39-TGR-NSPR-A
	for F3S-TGR-NMPR	F39-TGR-NMPR-A
	for F3S-TGR-NCPR	F39-TGR-NCPR-A
	for F3S-TGR-NWPR	F39-TGR-NWPR-A
	for F3S-TGR-NBPR	F39-TGR-NBPR-A
	for F3S-TGR-NLMR	F39-TGR-NLMR-A
	for F3S-TGR-NSMR	F39-TGR-NSMR-A
	for F3S-TGR-NBMR	F39-TGR-NBMR-A
	for F3S-TGR-NSHR	F39-TGR-NSHR-A
for F3S-TGR-NSFR	F39-TGR-NSFR-A	
for F3S-TGR-NMHR	F39-TGR-NMHR-A	
Mounting screws	Set of Torx safety screws (M4, 4 × 30 mm, 4 × 20 mm, 4 × 10 mm; incl. washers and Torx bit)	F39-TGR-N-SCREWS
Spacer (8 mm, Set of 2pcs.) ^{*1}	for elongated sensors	F39-TGR-NLR-SPACER
	for small sensors	F39-TGR-NSR-SPACER
	for miniature sensors	F39-TGR-NMR-SPACER
	for long sensors	F39-TGR-NLR-SPACER
	for wide sensors	F39-TGR-NWR-SPACER

^{*1} Spacers are needed to prevent influences if switch is mounted on ferromagnetic background (e. g. reduced switching distance, EMC influences)

Wiring examples (Single head connection)

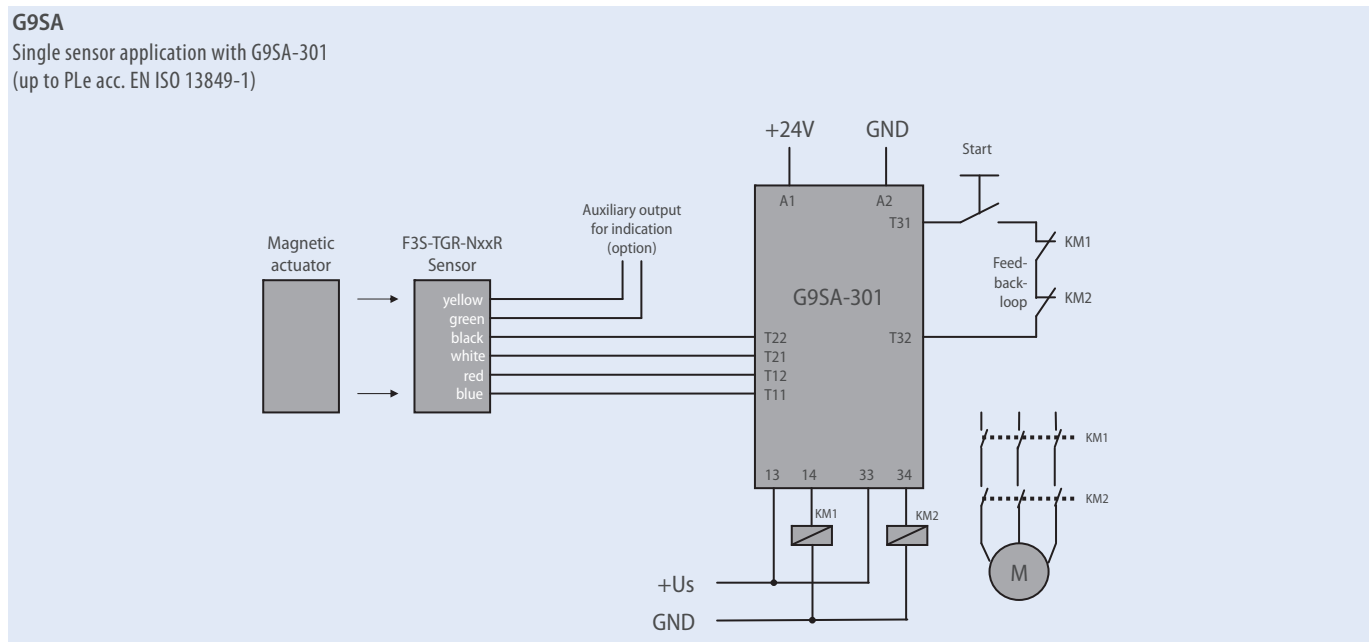



RFID non-contact switches

RFID Non-contact switches are designed to monitor hinge, sliding or removal guard doors.

- Based on RFID technology (code) and hall technology (distance check)
- The RFID-design covers two operation models with very high anti-tamper level:
- M-types (Master coded): Any sensor works with any actuator, like traditional switches
- U-types (Unique coded): Each sensor and actuator use a unique code. This is a solution for applications that requires even a higher anti-tamper level
- Connect up to 20 switches in series
- LED supports easy diagnosis
- Compensation of mechanical tolerances
- Non-contact – no abrasion – no particles
- Operates with all OMRON safety controllers
- Suitable for CIP/SIP processes and high pressure cleaning due IP69K (pre-wired types)
- Conforms to safety categories up to PLe acc. EN ISO 13849-1

Ordering information

Master coded: Any actuator will operate with any sensor (Power down - power up re-teach needed if exchange of actuator)

Unique coded: Only one actuator fits to the code of the sensor

Elongated sensors

Type	Cable connection	Contact configuration	Order code	
			Master coded	Unique coded
	5 m pre-wired	2NC/1NO	F3S-TGR-NLPM-21-05	F3S-TGR-NLPU-21-05
	10 m pre-wired		F3S-TGR-NLPM-21-10	F3S-TGR-NLPU-21-10
	M12, 8-pin		F3S-TGR-NLPM-21-M1J8	F3S-TGR-NLPU-21-M1J8

Small sensors

Type	Cable connection	Contact configuration	Order code	
			Master coded	Unique coded
	5 m pre-wired	2NC/1NO	F3S-TGR-NSPM-21-05	F3S-TGR-NSPU-21-05
	10 m pre-wired		F3S-TGR-NSPM-21-10	F3S-TGR-NSPU-21-10
	M12, 8-pin		F3S-TGR-NSPM-21-M1J8	F3S-TGR-NSPU-21-M1J8

Specifications

Mechanical data

Item		
Serial switching		up to 20 pcs.
Indicator LED		LED green - Indication of safety circuit closed
Operating distance	OFF → ON (Sao)	10 mm Close
	ON → OFF (Sar)	20 mm Open
Actuator approach speed	Min.	4 mm/s
	Max.	1,000 mm/s
Operating temperature		-25 to 80°C
Enclosure protection	Flying lead	IP69K
	M12 connector	IP67
Material cable	Flying lead	PVC, Ø 6 mm o.d.
	M12 connector	250 mm, PVC, Ø 6 mm o.d.
Material		UL approved Polyester

Electrical data

Item		F3S-TGR-N_M	F3S-TGR-N_U
Code		Master coded: Every switch same code (Power down - Power up re-teach needed, if actuator interchanged)	Unique coded: 32 x 16 ⁶ different codes
Technology		RFID (code) and Hall (distance check)	
Power supply		24 VDC±15%	
Power consumption	Max.	0.2 A	
Switching current	Min.	1 mA, 10 VDC	
Rated loads	NC contacts	Max.	0.2 A, 24 VDC
	NO contact	Max.	0.2 A, 24 VDC
Output type		Electronic output (potential-free optocoupler output)	

Approved standards

EN standards certified by TÜV Rheinland
EN 62061
EN ISO 14119
EN ISO13849-1
EN 60204-1

EN standards certified by TÜV Rheinland
EN/IEC 60947-5-3
UL 508, CSA C22.2
BS 5304
EN 1088-1 conformance

Accessories

		Order code
Cables 8-pin	2 m	Y92E-M12PURSH8S2M-L
	5 m	Y92E-M12PURSH8S5M-L
	10 m	Y92E-M12PURSH8S10M-L
	25 m	Y92E-M12PURSH8S25M-L
T-Connector connection cable	T-Connector for M12 connector	F39-TGR-NT
	0.6 m, M12-8pin	Y92E-M12FSM12MSPURSH806M-L
	2 m, M12-8pin	Y92E-M12FSM12MSPURSH82M-L
	5 m, M12-8pin	Y92E-M12FSM12MSPURSH85M-L
	10 m, M12-8pin	Y92E-M12FSM12MSPURSH810M-L
Actuators (only for master coded types)	for F3S-TGR-NLPM	F39-TGR-NLPM-A
	for F3S-TGR-NSPM	F39-TGR-NSPM-A
Mounting screws	Set of Torx safety screws (M4, 4 × 30 mm, 4 × 20 mm, 4 × 10 mm; incl. washers and Torx bit)	F39-TGR-N-SCREWS

Wiring examples (Single head connection)

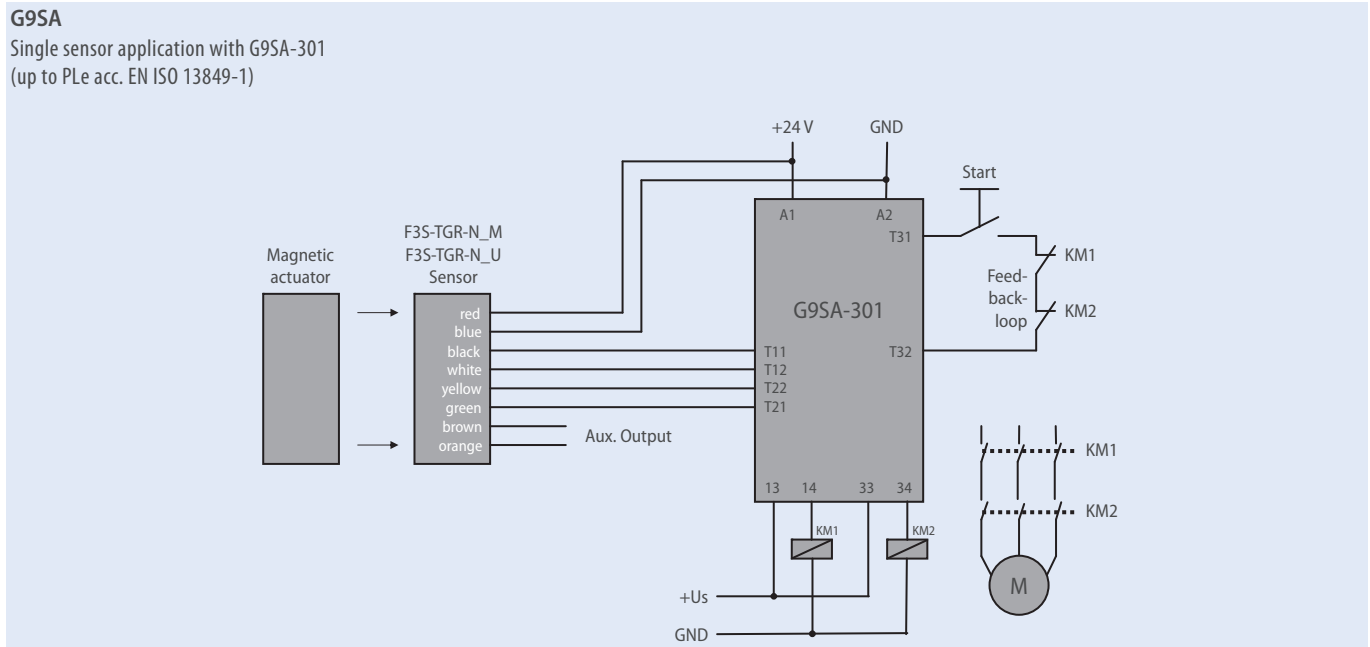



Standalone non-contact safety switches



Standalone non-contact switches support applications like guarding doors or position monitoring in machines. They are using the proven Omron non-contact technology allowing to cover mechanical tolerances and vibrations

- Models with single or dual actuator available (For one or two door systems in e.g.)
- Based on hall technology
- Connect up to 20 switches in series
- LED for easy diagnosis
- Operates behind stainless steel fittings
- Non-contact – no abrasion – no particles
- Compensation of mechanical tolerances
- Suitable for high pressure cleaning, CIP and SIP processes due IP69K (pre-wired types)
- Conforms to safety categories up to PLe acc. EN ISO 13849-1



Ordering information

Switches

Polyester housing

Type	Cable connection	Order code
Single actuator sensing 	5 m pre-wired	F3S-TGR-SPSA-05
	10 m pre-wired	F3S-TGR-SPSA-10
	M12, 8-pin	F3S-TGR-SPSA-M1J8
Dual actuator sensing 	5 m pre-wired	F3S-TGR-SPSD-05
	10 m pre-wired	F3S-TGR-SPSD-10
	M12, 8-pin	F3S-TGR-SPSD-M1J8

Stainless steel housing

Type	Cable connection	Order code
Single actuator sensing 	5 m pre-wired	F3S-TGR-SMSA-05
	10 m pre-wired	F3S-TGR-SMSA-10
	M12, 8-pin	F3S-TGR-SMSA-M1J8
Dual actuator sensing 	5 m pre-wired	F3S-TGR-SMSD-05
	10 m pre-wired	F3S-TGR-SMSD-10
	M12, 8-pin	F3S-TGR-SMSD-M1J8

Accessories

		Order code
Cables 8-pin	2 m	Y92E-M12PURSH8S2M-L
	5 m	Y92E-M12PURSH8S5M-L
	10 m	Y92E-M12PURSH8S10M-L
	25 m	Y92E-M12PURSH8S25M-L
Actuators (only for master coded types)	for F3S-TGR-SPSA and -SPSD	F39-TGR-SPS-A
	for F3S-TGR-SMSA and -SMSD	F39-TGR-SMS-A
Mounting screws	Set of Torx safety screws (M4, 4 × 30 mm, 4 × 20 mm, 4 × 10 mm; incl. washers and Torx bit)	F39-TGR-N-SCREWS

Specifications

Mechanical data

Item	Model	Polyester Sensor	Stainless steel sensor
Indicator	–	Green LED: Indication of safety circuits closed (Guard closed, actuator present, feedback circuit checked) Yellow LED: Indication of safety circuits open (Actuator removed)	
Operating distance	OFF → ON (Sao)	10 mm Close	
	ON → OFF (Sar)	15 mm Open	
Actuator approach speed	Min.	4 mm/s	
	Max.	1,000 mm/s	
Operating temperature		–25 to 45°C	
Enclosure protection	Flying lead	IP69K	
	M12 connector	IP67	
Material cable	Flying lead	PVC, Ø 6 mm o.d.	
	M12 connector	250 mm, PVC, Ø 6 mm o.d.	
Material housing		UL approved Polyester	Stainless steel 316

Electrical data

Item	Model	Polyester sensor	Stainless steel sensor
Sensing technology	–	Hall	
Serial connection	–	up to 20 switches	
Power supply		24 VDC±10%	
Power consumption	Max.	0.1 A	
Switching current	Min.	10 mA, 5 VDC	
Rated loads	Safety outputs	Max.	3 A, 250 VAC/3A, 24 VDC
	Auxiliary output	Max.	0.2 A, 24 VDC

Approved standards

EN standards certified by TÜV Rheinland

EN ISO13849-1

EN 62061

EN ISO 14119

EN 60204-1

EN/IEC 60947-5-3

UL 508, CSA C22.2

BS 5304

EN 1088-1 conformance

Wiring example (serial connection with manual restart)

(up to PLe acc. EN ISO 13849-1)

Safety Circuit 1 (Black/White) utilises internally checked force guided relay contacts and is connected in series with the corresponding Safety Circuit 2 (Yellow/Green) of the next switch. Allows minimal wiring and higher current switching to K1 and K2 contactors.

A manual start and contactor feedback check is achieved by connecting K1(Aux) and K2(Aux) feedback contacts and momentary start button through the orange and brown feedback check.

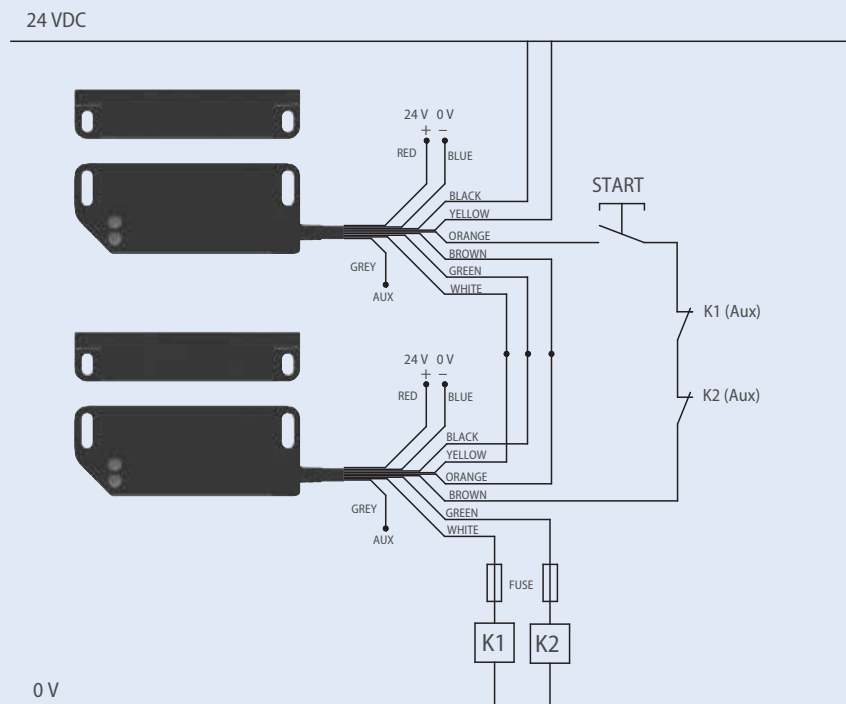



Explosion proof non-contact switches

Explosion proof reed non-contact switches monitor the status of guarding doors in petro-chemical and food applications with explosive atmospheres.

- Based on reed technology
- Connect up to 6 switches in series
- Operates with all Omron safety controllers
- Operates behind stainless steel fittings
- Non-contact – no abrasion – no particles
- Compensation of mechanical tolerances
- Suitable for high pressure cleaning, CIP/SIP processes
- Conforms to safety categories up PLe acc. EN ISO13849-1
- For use in hazardous areas IECEx and ATEX EExd IIC T6 (Gas and Dust). Designed for Petro-chemical and food applications where explosive atmospheres are present.

Ordering information

Elongated sensors

Type	Cable connection	Contact configuration	Order code
	5 m pre-wired	2NC/1NO	F3S-TGR-NLMX-21-05
	10 m pre-wired	2NC/1NO	F3S-TGR-NLMX-21-10

Barrel sensors

Type	Cable connection	Contact configuration	Order code
	5 m pre-wired	2NC/1NO	F3S-TGR-NBMX-21-05
	10 m pre-wired	2NC/1NO	F3S-TGR-NBMX-21-10

Specifications

Mechanical data

		Elongated sensors	Barrel sensors
Serial switching		up to 6 pcs.	
Indicator	–	None	
Operating distance	OFF → ON (Sao)	10 mm close	
	ON → OFF (Sar)	22 mm open	
Actuator approach speed	Min.	4 mm/s	
	Max.	1000 mm/s	
Operating temperature	–	–20°C to +60°C	
Enclosure protection	Flying lead	IP 67 Certification for IP67 but can be used for SIP/CIP and high pressure cleaning like IP69K)	
Material	–	Stainless steel 316	

Electrical data

		Elongated sensors	Barrel sensors
Sensor technology	–	Reed	
Power supply	–	24 VDC±15%	
Switching current	Min.	1 mA, 10 VDC	
Rated loads	NC contacts	0.6 A, 230 VAC/24 VDC (internally fused)	
	NO contact		

Ex specification

II 2G Ex mb IIC T6Gb, II 2D Ex mb IIC T80 Db IP67* (*Product is fully encapsulated which is considered to provide Ingress Protection to at least IP67)
Zones 0, 1, 2 (Gas), Zones 20, 21, 22 (Dust) (An area where Gas and Dust is likely to occur in use)
IEC/EN 60079-0, IEC/EN 60079-18

Approved standards

EN standards certified by TÜV Rheinland
EN ISO 13849-1
EN 60204-1
EN 62061
EN ISO 14119
EN/IEC 60947-5-3
UL 508, CSA C22.2
BS 5304
EN 1088-1

Accessories

		Order code
Actuators	for F3S-TGR-NLXM	F39-TGR-NLXM-A
	for F3S-TGR-NBMX	F39-TGR-NBMX-A
Mounting screws	Set of Torx safety screws (M4, 4 × 30 mm, 4 × 20 mm, 4 × 10 mm; incl. washers and Torx bit)	F39-TGR-N-Screws
Spacer (8 mm, Set of 2pcs.)*1	for F3S-TGR-NLXM	F39-TGR-NLR-SPACER

*1 Spacers are needed to prevent influences if switch is mounted on ferromagnetic background (e. g. reduced switching distance, EMC influences)

Wiring examples (Single head connection)

G9SA

Single sensor application with G9SA-301
(up to PLe acc. EN ISO 13849-1)

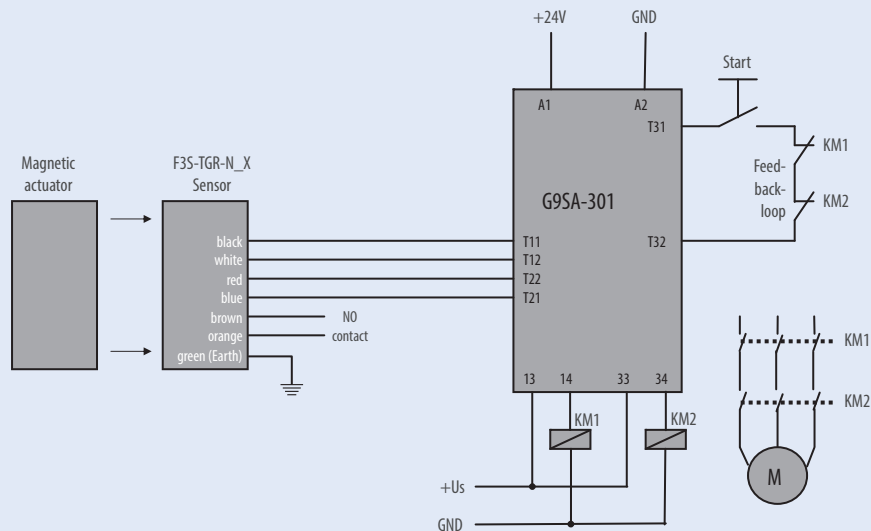



Safety door switch with plastic housing

The D4NS line-up includes three-contact models with 2NC/1NC and 3NC contact forms in addition to the previous contact forms, 1NC/1NO and 2NC. All models have a M20 conduit opening.



- Line-up with three contacts: 2NC/1NC and 3NC contact forms
- Line-up with two contacts 1NC/1NO and 2NC
- Standardised gold-clad contacts for high contact reliability
- Applicable for standard loads and micro loads

Ordering information

Switches (with approved direct opening contacts)

Type	Contact configuration	Conduit opening/connector	Order code
1-conduit	Slow-action	1NC/1NO	D4NS-4AF
		2NC	D4NS-4BF
		2NC/1NO	D4NS-4CF
		3NC	D4NS-4DF
	Slow-action MBB contact	1NC/1NO	D4NS-4EF
		2NC/1NO	D4NS-4FF

Operation keys (order separately)

Type	Order code
Horizontal mounting 	D4DS-K1
Vertical mounting 	D4DS-K2

Type	Order code
Adjustable mounting (horizontal) 	D4DS-K3
Adjustable mounting (horizontal/vertical) 	D4DS-K5

Specifications

Degree of protection		IP67 (EN60947-5-1) (This applies for the switch only. The degree of protection for the key hole is IP00.)
Durability *1	Mechanical	1,000,000 operations min.
	Electrical	500,000 operations min. for a resistive load of 3 A at 250 VAC 300,000 operations min. for a resistive load of 10 A at 250 VAC
Operating speed		0.05 to 0.5 m/s
Operating frequency		30 operations/minute max.
Direct opening force *2		60 N min.
Direct opening travel *2		10 mm min.
Minimum applicable load		Resistive load of 1 mA at 5 VDC (N-level reference value)
Protection against electric shock		Class II (double insulation)
Pollution degree (operating environment)		3 (EN60947-5-1)
Contact gap		2×2 mm min
Conditional short-circuit current		100 A (EN60947-5-1)
Rated open thermal current (I_{th})		10 A (EN60947-5-1)
Ambient temperature		Operating: -30°C to 70°C with no icing

*1 The durability is for an ambient temperature of 5°C to 35°C and an ambient humidity of 40 to 70%. For more details, consult your Omron representative.

*2 These figures are minimum requirements for safe operation.

Note: The above values are initial values.



Safety door switch with metal housing

The D4BS line-up includes two-contact models with 1NC/1NO and 2NC in a robust metal housing with 1 PG 13.5 conduit opening.



- Robust metal housing
- Line-up with two contacts: 1NC/1NO and 2NC
- Standardised gold-clad contacts for high contact reliability
- Applicable for standard loads and micro loads

Ordering information

Switches

Type	Mounting direction	Conduit size	Order code	
			1NC/1NO (slow-action)	2NC (slow-action)
1-conduit	Front-side mounting	Pg13.5	D4BS-15FS	D4BS-1AFS

Operation keys (order separately)

Type		Order code
Horizontal mounting		D4BS-K1
Vertical mounting		D4BS-K2
Adjustable mounting (horizontal)		D4BS-K3

Specifications

Degree of protection ^{*1}	IP67 (EN60947-5-1)
Durability ^{*2}	Mechanical: 1,000,000 operations min. Electrical: 500,000 operations min. (10 A at 250 VAC, resistive load)
Operating speed	0.1 m/s to 0.5 m/s
Operating frequency	30 operations/min max.
Rated frequency	50/60 Hz
Contact gap	2×2 mm min.
Direct opening force ^{*3}	19.61 N min. (EN60947-5-1)
Direct opening travel ^{*3}	20 mm min. (EN60947-5-1)
Full stroke	23 mm min.
Conventional enclosed thermal current (I _{th})	20 A (EN60947-5-1)
Conditional short-circuit current	100 A (EN60947-5-1)
Pollution degree (operating environment)	3 (EN60947-5-1)
Protection against electric shock	Class I (with ground terminal)
Ambient temperature	Operating: -40 to 80°C (with no icing)

^{*1} Although the switch box is protected from dust, oil, or water penetration, do not use the D4BS in places where dust, oil, water, or chemicals may penetrate through the key hole on the head, otherwise switch damage or malfunctioning may occur.

^{*2} The durability is for an ambient temperature of 5°C to 35°C and an ambient humidity of 40 to 70%. Contact your Omron sales representative for more detailed information on other operating environments.

^{*3} These figures are minimum requirements for safe operation.

Note: The above values are initial values.





Safety door switches with stainless steel head or full stainless steel body

This safety door switches use a stainless steel head or even a full stainless steel body to increase the robustness.





- 2NC/1NO or 3NC contacts
- Key entry turnable to back side
- 4 key insertion positions
- 3 M20 conduit entries
- Positive break contacts (to IEC 60947-5-1)

Ordering information

Switches

Type	Housing	Conduit	Contacts	Order code
	Plastic body with metal head	M20	2NC/1NO Slow action	F3S-TGR-KM15-21
			3NC Slow action	F3S-TGR-KM15-30
	Plastic body with metal head		2NC/1NO Slow action	F3S-TGR-KM16-21
			3NC Slow action	F3S-TGR-KM16-30
	Full stainless steel body		2NC/1NO Slow action	F3S-TGR-KH16-21
			3NC Slow action	F3S-TGR-KH16-30

Keys (order separately)

Type	Order code
for metal head 	F39-TGR-KAM
Horizontal mounting 	F39-TGR-KF
plastic flexible 	F39-TGR-KPF
heavy flexible 	F39-TGR-KHF
hygienic flexible 	F39-TGR-KHFH

Accessories

Item	Remarks	Order code
M20 Gland	Stainless steel 316 for F3S-TGR-KH16 types	F39-TGR-M20
Mounting screws	Set of Torx safety screws (M4, 4 × 30 mm, 4 × 20 mm, 4 × 10 mm; incl. washers and Torx bit)	F39-TGR-N-SCREWS

Specifications

Item	F3S-TGR-KM15	F3S-TGR-KM16	F3S-TGR-KH16
Standards	EN1088, IEC 60947-5-1, EN 60204-1, UL508 EN ISO 13849-1: up to PLe ^{*1} EN 62061: up to SIL3 ^{*1}		
Mechanical reliability B10d	2.5 × 10 ⁶ operations at 100mA load		
PFHd	3.44 × 10 ⁻⁸		
Proof test interval (Life)	35 years		
MTTFd	356 years		
Utilization category	AC15 A300 3 A		
Thermal current (Ith)	5 A		
Rated insulation/Withstand voltages	500 VAC/2,500 VAC		
Rated travel for positive opening	8 mm		
Actuator entry minimum radius	175 mm standard, 100mm flexible		
Maximum approach/Withdrawal speed	600 mm/s		
Body dimensions (W × H × D)	54 × 88.4 × 34.5 mm	58 × 100.4 × 34.5 mm	58 × 103.5 × 39.5 mm
Fixing	2 × M5, 40 mm distance	4 × M5, 40 mm distance	
Conduit entry	M20		
Material	Body	Polyester	
	Head	Stainless steel 316	
Enclosure Protection	IP67		
Temperature Range	-25 to 80°C		
Vibration	IEC 68-2-6, 10-55 Hz +1 Hz, Excursion: 0.35 mm, 1 octave/min		

*1 Depending upon system architecture



Guard-lock safety door switch

The D4NL guard-lock safety-door switches are available with four or five built-in contacts. When locked, they have a key holding force of up to 1300 N. Mechanical lock/solenoid release types and vice versa set up the complete range.

- Safety-door switch with electromagnetic lock or unlock mechanism
- Models with four or five built-in contacts
- Strong key holding force: 1300 N
- For standard loads and micro loads
- Keys are compatible with D4GL and D4NS

Ordering information

Switches (with approved direct opening contacts)



For 110 V and 230 V version ask your local Omron representative

Lock and release types	Contact configuration	Conduit opening	Order code
Mechanical lock solenoid release	1NC/1NO + 1NC/1NO	M20	D4NL-4AFA-B
	1NC/1NO + 2NC	M20	D4NL-4BFA-B
	2NC + 1NC/1NO	M20	D4NL-4CFA-B
	2NC + 2NC	M20	D4NL-4DFA-B
	2NC/1NO + 1NC/1NO	M20	D4NL-4EFA-B
	2NC/1NO + 2NC	M20	D4NL-4FFA-B
	3NC + 1NC/1NO	M20	D4NL-4GFA-B
	3NC + 2NC	M20	D4NL-4HFA-B



Note

- Conduit sizes of G1/2 and Pg 13,5 are also available.
- Solenoid: 24 VDC, Orange LED: 10 to 115 VAC/VDC

Operation keys (order separately)

Type		Order code
Horizontal mounting		D4DS-K1
Vertical mounting		D4DS-K2

Lock and release types	Contact configuration	Conduit opening	Order code
Solenoid lock mechanical release	1NC/1NO + 1NC/1NO	M20	D4NL-4AFG-B
	1NC/1NO + 2NC	M20	D4NL-4BFG-B
	2NC + 1NC/1NO	M20	D4NL-4CFG-B
	2NC + 2NC	M20	D4NL-4DFG-B
	2NC/1NO + 1NC/1NO	M20	D4NL-4EFG-B
	2NC/1NO + 2NC	M20	D4NL-4FFG-B
	3NC + 1NC/1NO	M20	D4NL-4GFG-B
		3NC + 2NC	M20

Type		Order code
Adjustable mounting (horizontal)		D4DS-K3
Adjustable mounting (horizontal/vertical)		D4DS-K5

Specifications

Degree of protection	IP67 (EN60947-5-1) (This applies for the switch only. The degree of protection for the key hole is IP00.)	
Durability ^{*1}	Mechanical	1,000,000 operations min.
	Electrical	500,000 operations min. for a resistive load of 3 A at 250 VAC
Operating speed	0.05 to 0.5 m/s	
Operating frequency	30 operations/minute max.	
Rated frequency	50/60 Hz	
Contact gap	2x2 mm min	
Direct opening force ^{*2}	60 N min. (EN60947-5-1)	
Direct opening travel ^{*2}	10 mm min. (EN60947-5-1)	
Holding force	1,300 N min.	
Minimum applicable load	Resistive load of 1 mA at 5 VDC (N-level reference value)	
Thermal current (I _{th})	10 A (EN60947-5-1)	
Conditional short-circuit current	100 A (EN60947-5-1)	
Pollution degree (operating environment)	3 (EN60947-5-1)	
Protection against electric shock	Class II (double insulation)	
Ambient temperature	Operating: -10°C to 55°C (with no icing or condensation)	

^{*1} The durability is for an ambient temperature of 5°C to 35°C and an ambient humidity of 40 to 70%. For more details, consult your Omron representative.

^{*2} These figures are minimum requirements for safe operation.

Note: The above values are initial values.



Guard-lock safety door switch

The D4GL guard-lock safety-door switches are available with four or five built-in contacts. When locked, they have a key holding force of up to 1000 N. Mechanical lock/solenoid release types and vice versa set up the complete range.

- Slim safety-door switch with electromagnetic lock or unlock mechanism
- Models with four or five built-in contacts
- Strong key holding force: 1000 N
- For standard loads and micro loads
- Keys are compatible with D4NL and D4NS

Ordering information

Switches (with approved direct opening contacts)

Lock and release types	Contact configuration	Conduit size	Order code
Mechanical lock solenoid release	1NC/1NO + 1NC/1NO	M20	D4GL-4AFA-A
	1NC/1NO + 2NC	M20	D4GL-4BFA-A
	2NC + 1NC/1NO	M20	D4GL-4CFA-A
	2NC + 2NC	M20	D4GL-4DFA-A
	2NC/1NO + 1NC/1NO	M20	D4GL-4EFA-A
	2NC/1NO + 2NC	M20	D4GL-4FFA-A
	3NC + 1NC/1NO	M20	D4GL-4GFA-A
	3NC + 2NC	M20	D4GL-4HFA-A

Lock and release types	Contact configuration	Conduit size	Order code
Solenoid lock mechanical release	1NC/1NO + 1NC/1NO	M20	D4GL-4AFG-A
	1NC/1NO + 2NC	M20	D4GL-4BFG-A
	2NC + 1NC/1NO	M20	D4GL-4CFG-A
	2NC + 2NC	M20	D4GL-4DFG-A
	2NC/1NO + 1NC/1NO	M20	D4GL-4EFG-A
	2NC/1NO + 2NC	M20	D4GL-4FFG-A
	3NC + 1NC/1NO	M20	D4GL-4GFG-A
	3NC + 2NC	M20	D4GL-4HFG-A

Note

- conduit sizes of G1/2 and Pg13,5 are also available.
- solenoid: 24 VDC, orange/green LED: 24 VDC

Operation keys (order separately)

Type		Order code
Horizontal mounting		D4DS-K1
Vertical mounting		D4DS-K2

Type		Order code
Adjustable mounting (horizontal)		D4DS-K3
Adjustable mounting (horizontal/vertical)		D4DS-K5

Specifications

Degree of protection	IP67 (EN60947-5-1) (This applies for the switch only. The degree of protection for the key hole is IP00.)	
Durability *1	Mechanical	1,000,000 operations min.
	Electrical	500,000 operations min. for a resistive load of 4 mA at 24 VDC; 150,000 operations min. for a resistive load of 1 A at 125 VAC in 2 circuits and 4 mA at 24 VDC in 2 circuits
Operating speed	0.05 to 0.5 m/s	
Operating frequency	30 operations/minute max.	
Rated frequency	50/60 Hz	
Contact gap	2x2 mm min.	
Direct opening force *2	60 N min. (EN60947-5-1)	
Direct opening travel *3	10 mm min. (EN60947-5-1)	
Holding force	1,000 N min.	
Minimum applicable load	Resistive load of 4 mA at 24 VDC (N-level reference value)	
Thermal current (I _{th})	2.5 A (EN60947-5-1)	
Conditional short-circuit current	100 A (EN60947-5-1)	
Pollution degree (operating environment)	3 (EN60947-5-1)	
Protection against electric shock	Class II (double insulation)	
Ambient temperature	Operating: -10°C to 55°C with no icing	

*1 The durability is for an ambient temperature of 5°C to 35°C and an ambient humidity of 40 to 70%. For more details, consult your Omron representative.

*2 These figures are minimum requirements for safe operation.

*3 These figures are minimum requirements for safe operation.

Note: The above values are initial values.



Guard-lock safety door switch

The D4SL-N guard-lock safety door switches safety door switches provides a wide range of models for the safe monitoring of entries and positions of guards.

- Key holding force 1,300 N
- 4, 5 and 6 contact types
- Terminal block type and connector type
- Drive solenoid directly from the controller
- Turning key insertion point without detaching head

Ordering information

Contact configuration

Contact model	Built-in Switch
4-contact model	Door monitor and Lock monitor are connected in series internally. A: 1NC/1NO + 1NC/1NO B: 1NC/1NO + 2NC C: 2NC + 1NC/1NO D: 2NC + 2NC
	Door monitor and Lock monitor are NOT connected in series internally. S: 1NC/1NO + 1NC/1NO T: 1NC/1NO + 2NC U: 2NC + 1NC/1NO V: 2NC + 2NC

Contact model	Built-in Switch
5-contact model	E: 2NC/1NO + 1NC/1NO
	F: 2NC/1NO + 2NC
	G: 3NC + 1NC/1NO
	H: 3NC + 2NC
6-contact model	N: 2NC/1NO + 2NC/1NO
	P: 2NC/1NO + 3NC
	Q: 3NC + 2NC/1NO
	R: 3NC + 3NC

Models



Housing	Release key type	Wiring method	Solenoid voltage/Indicator	Lock and release type	Contact configuration (door open/closed detection switch and lock monitor switch contacts)	Conduit size ^{*1}	Order code
Head Resin/ Body Resin ^{*2}	Standard (metal) ^{*3} 	Connector	24 VDC (Orange)	Mechanical lock Solenoid release	6-contact Model Insert the built-in switch (N, P, Q or R) into the blank _.	M20	D4SL-N4_FA-DN
					5-contact Model Insert the built-in switch (E, F, G or H) into the blank _.	M20	D4SL-N4_FA-DN
			4-contact Model Insert the built-in switch (A, B, C, D, S, T, U or V) into the blank _.		M20	D4SL-N4_FA-N	
			6-contact Model Insert the built-in switch (N, P, Q or R) into the blank _.		M20	D4SL-N4_FA-D	
			5-contact Model Insert the built-in switch (E, F, G or H) into the blank _.		M20	D4SL-N4_FA-D	
			4-contact Model Insert the built-in switch (A, B, C, D, S, T, U or V) into the blank _.		M20	D4SL-N4_FA	
		Terminal block	24 VDC (Orange)	Solenoid lock Mechanical release	6-contact Model Insert the built-in switch (N, P, Q or R) into the blank _.	M20	D4SL-N4_FG-DN
					5-contact Model Insert the built-in switch (E, F, G or H) into the blank _.	M20	D4SL-N4_FG-DN
			4-contact Model Insert the built-in switch (A, B, C, D, S, T, U or V) into the blank _.		M20	D4SL-N4_FG-N	
			6-contact Model Insert the built-in switch (N, P, Q or R) into the blank _.		M20	D4SL-N4_FG-D	
			5-contact Model Insert the built-in switch (E, F, G or H) into the blank _.		M20	D4SL-N4_FG-D	
			4-contact Model Insert the built-in switch (A, B, C, D, S, T, U or V) into the blank _.		M20	D4SL-N4_FG	



^{*1} Types also with G1/2 and 1/2-14NPT available - see online data sheet

^{*2} 'Head metal/Body resin' also available - see online data sheet

^{*3} Release key type also resin available - see online data sheet

Operation keys (order separately)

Type	Order code
Horizontal mounting 	D4SL-NK1
Horizontal mounting (Short) 	D4SL-NK1S
Horizontal mounting (Cushion rubber) 	D4SL-NK1G

Type	Order code
Vertical mounting 	D4SL-NK2
Vertical mounting (Cushion rubber) 	D4SL-NK2G
Adjustable (Horizontal) 	D4SL-NK3

Connector cables for connector types

Cable length	Order code
1 m	D4SL-CN1
3 m	D4SL-CN3
5 m	D4SL-CN5

Specifications

Degree of protection*1	IP67 (EN60947-5-1)	
Durability*2	Mechanical	1,000,000 operations min.
	Electrical	150,000 operations min. (1 A resistance at 125 VAC)*3
Operating speed	0.05 to 1 m/s	
Operating frequency	5 operations minute max.	
Direct opening force*4	60 N min. (EN60947-5-1)	
Direct opening travel*4	15 mm min. (EN60947-5-1)	
Holding force	1,300 N min.	
Minimum applicable load	1 mA resistive load at 5 VDC (N-level reference value)	
Rated insulation voltage (Ui)	150 V (EN60947-5-1)	
Rated frequency	50/60 Hz	
Protection against electric shock	Class II(double insulation)	
Pollution degree (operating environment)	3 (EN60947-5-1)	
Conditional short-circuit current	100 A (EN60947-5-1)	
Conventional free air thermal current (Ith)	2.5 A (11-42, 21-52, 21-22) 1 A (Others)	
Ambient operating temperature	-10 to 55°C (with no icing)	
Ambient operations humidity	95% max.	

*1 This applies for the switch only. The degree of protection for the key hole is IP00.

*2 The durability is for an ambient temperature of 5 to 35°C and an ambient humidity of 40% to 70%. For more details, consult your OMRON representative.

*3 Do not pass the 1 A, 125 VAC load through more than 3 circuits.

*4 These figures are minimum requirements for safe operation.

Note 1. The above values are initial values.
2. The switch contacts can be used with either standard loads or microloads.



Stainless steel guard-lock safety door switch

The F3S-TGR-KHL1 safety-door switch keeps medium to large guard doors closed until hazards have been removed. It has a stainless steel body and is designed to cope with the rigorous applications of the food processing and chemical industries.





- Safety-door switch with electromagnetic lock and unlock mechanism (mechanical lock/solenoid unlock)
- 2NC (safety), 1NO (Guard open), 1NO (Lock open)
- Strong key holding force: 1600 N
- LED for diagnosis
- IP69K suitable for SIP and CIP processes
- Positive break contacts to IEC 60947-5-1

Ordering information

Switches

Type	Housing	Conduit	Contacts	Order code
	Stainless steel 316	M20	2NC safety contacts 2NO Auxiliary contact (guard open, lock status)	F3S-TGR-KHL1

Keys (order separately)

Type	Order code
for metal head 	F39-TGR-KAM
Horizontal mounting 	F39-TGR-KF
heavy flexible 	F39-TGR-KHF
hygienic flexible 	F39-TGR-KHFH

Accessories

Item	Remarks	Order code
M20 Gland	Stainless steel 316	F39-TGR-M20

Specifications

Item	F3S-TGR-KHL1
Standards	EN1088, IEC 60947-5-1, EN 60204-1, UL508 EN ISO 13849-1: up to PLe ^{*1} EN 62061: up to SIL3 ^{*1}
Lock principle	Mechanical lock/solenoid unlock
Indicator LED	Status of solenoid
Utilization category	AC15 A300 3 A
Thermal current (I _{th})	5 A
Rated insulation/Withstand voltages	500 VAC/2,500 VAC
Rated travel for positive opening	10 mm
Actuator entry minimum radius	175 mm standard, 100mm flexible
Maximum approach/Withdrawal speed	600 mm/s
Body dimensions (W × H × D)	63 × 143 × 41.5 mm
Fixing	2 × M5, 40 mm distance
Conduit entry	M20
Material	Stainless steel 316
Enclosure Protection	IP69K
Temperature Range	-25 to 55°C
Vibration	IEC 68-2-6, 10 to 55 Hz +1 Hz, Excursion: 0.35 mm, 1 octave/min

*1 Depending upon system architecture





Stainless steel guard-lock safety door switch

The F3S-TGR-KHL3 safety-door switch keeps medium to large guard doors closed until hazards have been removed. It has a stainless steel body and is designed to cope with the rigorous applications of the food processing and chemical industries.

- Safety-door switch with electromagnetic lock and unlock mechanism (mechanical lock/solenoid unlock)
- 4NC (safety), 1NO (Guard open), 1NO (Lock open)
- Strong key holding force: 2000 N
- LED for diagnosis
- IP69K suitable for SIP and CIP processes
- Positive break contacts to IEC 60947-5-1





Ordering information

Switches

Type	Housing	Conduit	Contacts	Order code
	Stainless steel 316	M20	2NC safety contacts 2NO Auxillary contact (guard open, lock status)*1	F3S-TGR-KHL3
	Stainless steel 316 with rear push button manual release			F3S-TGR-KHL3R

*1 1NO lock status if LED2 Lock Status Indicator not used

Keys (order separately)

Type	Order code
for metal head 	F39-TGR-KAM
Horizontal mounting 	F39-TGR-KF
heavy flexible 	F39-TGR-KHF
hygienic flexible 	F39-TGR-KHFH

Accessories

Item	Remarks	Order code
M20 Gland	Stainless steel 316	F39-TGR-M20
Key	Manual release key	F39-TGR-MRK

Specifications

	F3S-TGR-KHL3
Standards	EN1088, IEC 60947-5-1, EN 60204-1, UL508 EN ISO 13849-1: up to PLe*1 EN 62061: up to SIL3*1
Lock principle	Mechanical lock/solenoid unlock
Indicator LEDs	LED1: Status of solenoid LED2: Lock status indication (if 1NO Auxillary contact not used)
Utilization category	AC15 A300 3 A
Thermal current (Ith)	5 A
Rated insulation/Withstand voltages	500 VAC/2,500 VAC
Rated travel for positive opening	10 mm
Actuator entry minimum radius	175 mm standard, 100 mm flexible
Maximum approach/Withdrawal speed	600 mm/s
Body dimensions (W × H × D)	48 × 177 × 47 mm
Fixing	4 × M5, mounted from backside
Conduit entry	M20
Material	Stainless steel 316
Enclosure Protection	IP69K
Temperature Range	-25 to 55°C
Vibration	IEC 68-2-6, 10-55 Hz +1 Hz, Excursion: 0.35 mm, 1 octave/min

*1 Depending upon system architecture

PROTECT OPERATORS AND PRODUCTION

Total consistency across the board

Safety Sensors are the first choice in safeguarding workplaces where persons and machines cooperate. Built-in intelligence stops the machine in conditions that are dangerous for the worker. Our F3S-TGR-CL and F3SJ range offers safety light curtains with included safe control functions for finger-, hand- and body protection.

- Finger- and Hand and body protection models
- Control functions
 - X-, T- and L-muting
 - fixed and floating blanking
 - single and double break operation
 - pre-reset access control
- Easy mounting and common wiring for all types for simple design and installation
- Certified acc. EN61496 and EN ISO 13849-1.

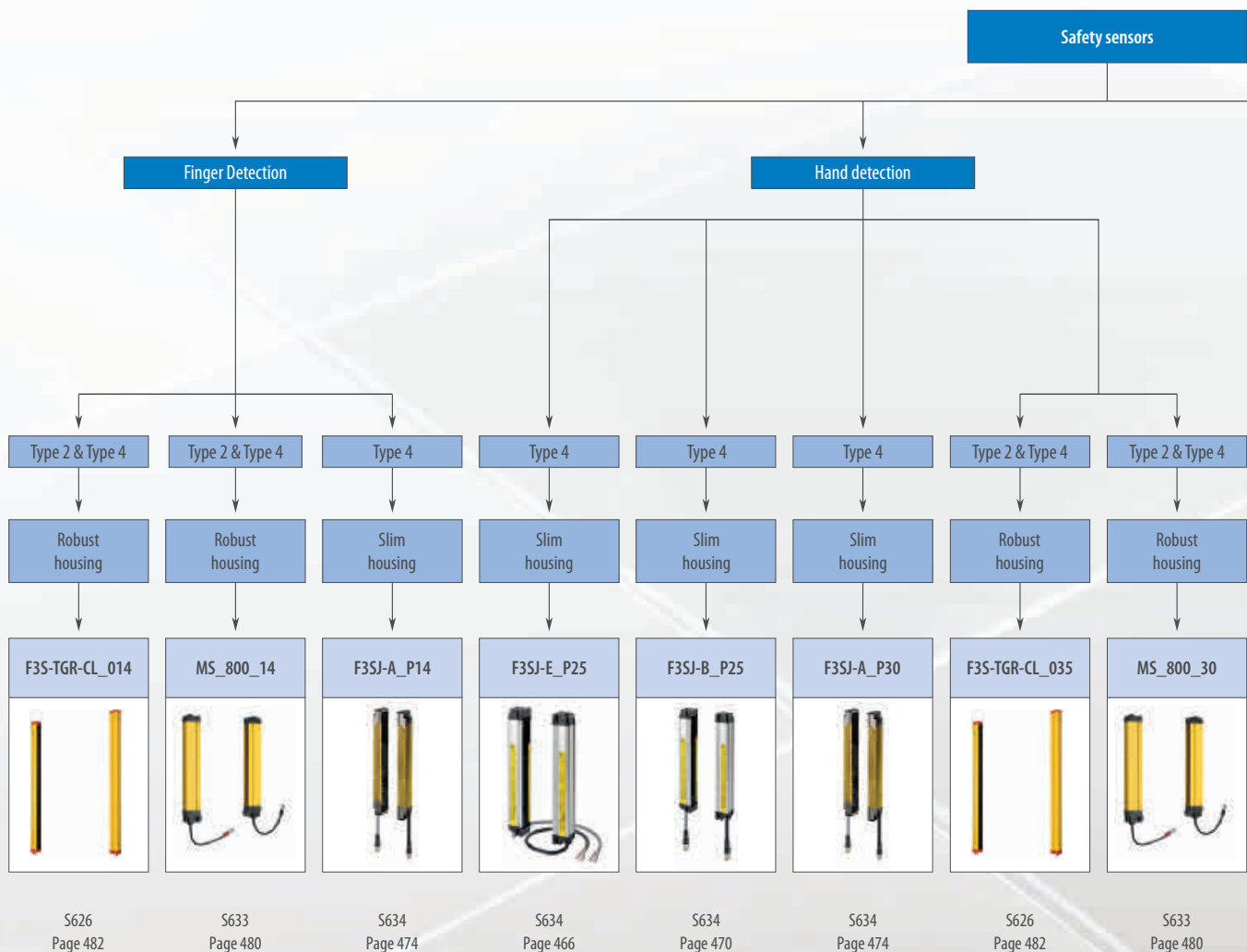



Human body detection and Muting applications

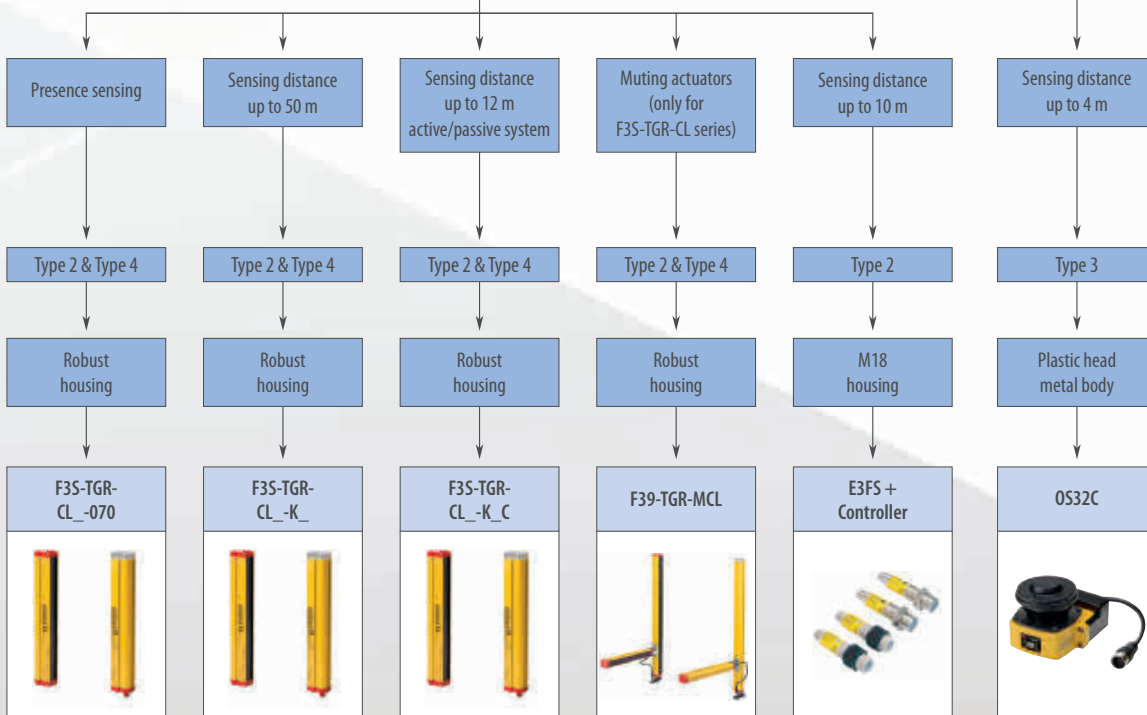

S626
Page 482

S627





S627



S644
Page 487

S223, S623
Page 488

S224
Page 489

Selection table

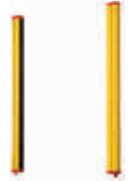
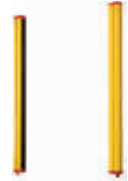
		Safety Sensors			
					
Model		F3SJ-E	F3SJ-B	F3SJ-A	MS2800 and MS4800
Selection criteria	Safety category	Type 4	Type 4	Type 4	Type 2 & 4
	Safety integrity level (IEC 61508)	–	–	–	SIL 3
	Protective height	185 to 1,105 mm	185 to 2,065 mm	245 to 2,495 mm	280 to 2,120 mm
	Resolution	25 mm	25 mm	14, 30 mm	14, 30 mm
	Reaction time	15 ms	15 ms	10 to 25 ms	14 to 59 ms
	Temperature range	–10 to 55°C	–10 to 55°C	–10 to 55°C	–10 to 55°C
	IP class	IP65	IP65	IP65	IP65
Features	Blanking function	–	–	internal	internal
	Muting function	–	■	–	option
	EDM function	internal	internal	internal	internal
	Interlock function	–	internal	internal	internal
	Series connection	–	up to 3 sets	up to 4 sets	up to 4 sets
	Mounting kits	option	option	inclusive	inclusive
	Parameter setting	–	–	option (software incl., console)	internal DIP switch
	External control unit	–	–	–	–
Application	Finger protection	–	–	■	■
	Hand protection	■	■	■	■
	Arm protection	■	■	■	■
	Body protection	■	■	■	■
	Presence detection	–	–	–	■
	Muting application	–	–	–	–
	Blanking application	–	–	■	■
Supply voltage	24 VDC	■	■	■	■
In- and Outputs	Safety outputs	2 PNP OSSD transistor outputs	2 PNP OSSD transistor outputs	2 PNP OSSD transistor outputs	2 PNP OSSD transistor outputs
	Auxiliary output	–	1 PNP (non safety)	2 PNP (non safety)	1 PNP (non safety)
	Test input	■	■	■	■
	EDM input	■	–	■	■
	Reset input	■	–	■	■
	Muting sensor input	–	–	–	–
	Page/Quick Link	466	470	474	480

		Safety Sensors			
					
Model		F3S-TGR-CL	F3S-TGR-CL_-K_ / -K_C	E3FS + F3SP-U3P	OS32C
Selection criteria	Safety category	Type 2 & 4	Type 2 & 4	Type 2	Type 3
	Safety integrity level (IEC 61508)	–	–	–	SIL 2
	Protective height	150 to 2,400 mm	500 to 1,200 mm	–	Sensing range 4 m
	Resolution	14, 35, 70 mm	–	–	–
	Beam pitch	–	300, 400, 500 mm	–	–
	Reaction time	13 to 103 ms	13 ms	32 ms	80 ms
	Temperature range	–10 to 55°C	–10 to 55°C	–10 to 55°C	–10 to 50°C
Features	IP class	IP65	IP65	IP67	IP65
	Blanking function	internal	–	–	–
	Muting function	internal	internal	option	–
	EDM function	internal	internal	option	internal
	Interlock function	internal	internal	option	internal
	Series connection	option	–	–	–
	Mounting kits	inclusive	inclusive	–	option
	Parameter setting	internal DIP switch	internal DIP switch	–	Software (included)
Application	External control unit	–	–	■	–
	Finger protection	■	–	–	■
	Hand protection	■	–	–	■
	Arm protection	■	–	–	■
	Body protection	■	■	■	■
	Presence detection	■	–	–	■
	Muting application	■	■	■	–
	Blanking application	■	–	–	–
Supply voltage	24 VDC	■	■	■	–
In- and Outputs	Safety outputs	2 PNP OSSD transistor outputs	2 PNP OSSD transistor outputs	2 PNP OSSD transistor outputs	2 PNP OSSD transistor outputs
	Auxiliary output	–	–	–	■
	Test input	■	■	■	–
	EDM input	■	■	–	■
	Reset input	■	■	■	■
	Muting sensor input	■	■	■	–
	EtherNet/IP	–	–	–	■
Page/Quick Link	482	S627	488	489	



Easy type for simple and affordable hand protection

The F3SJ-E-family is a type 4 safety light curtain with an optical resolution of 25 mm. An operation range of up to 7 m and a protective height up to 1,105 mm are provided with no dead zone

- Detection height = sensor height
- Small housing
- Simple and affordable hand protection
- Reduced wiring, quick mount brackets and easy-to-view-alignment beams reduce mounting time
- Type 4 sensor complying with EN 61496-1 and up to PLe according EN ISO 13849

Ordering information

Application	Detection capability	Beam gap	Operating range	Protective height (mm)	Order code
Hand protection	Dia. 25 mm	20 mm	0.2 to 7 m	185 to 1,105	F3SJ-E____P25







Note: F3SJ-E uses a 3 m prewired discrete cable.

Number of beams	Protective height (mm) ^{*1}	Order code
8	185	F3SJ-E0185P25
10	225	F3SJ-E0225P25
14	305	F3SJ-E0305P25
18	385	F3SJ-E0385P25
22	465	F3SJ-E0465P25
26	545	F3SJ-E0545P25
30	625	F3SJ-E0625P25
34	705	F3SJ-E0705P25
38	785	F3SJ-E0785P25
42	865	F3SJ-E0865P25
46	945	F3SJ-E0945P25
50	1,025	F3SJ-E1025P25
54	1,105	F3SJ-E1105P25

^{*1} Protective height (mm) = Total sensor length

Accessories (sold separately)

Sensor mounting bracket

Appearance	Specifications	Application	Remarks	Order code
	Top/bottom bracket	Top/bottom bracket for F3SJ-E/B	2 for an emitter, 2 for a receiver, total of 4 per set	F39-LJB1
	Intermediate bracket	In combination use with top/bottom bracket for F3SJ-E/B Can be used as free-location bracket.	1 set with 2 pieces	F39-LJB2 ^{*1} ^{*2}
	Quick mount bracket	Quick mount bracket for F3SJ-E/B Supports M6 slide nut for aluminum frame.	1 set with 2 pieces	F39-LJB3-M6 ^{*1}
		Quick mount bracket for F3SJ-E/B Supports M8 slide nut for aluminum frame.		F39-LJB3-M8 ^{*2}
	Quick mount M6 bracket Quick mount M8 bracket	Bracket to mount an intermediate bracket to the aluminum frame with a single touch.	Hexagon socket head cap screws (M6 × 10) are included.	F39-LJB3-M6K ^{*1}
			Hexagon socket head cap screws (M8 × 14) are included.	F39-LJB3-M8K ^{*2}
	Compatible mounting bracket	Mounting bracket used when replacing existing area sensors (F3SJ-A or F3SN) with the F3SJ-E/B.	2 for an emitter, 2 for a receiver, total of 4 per set	F39-LJB4
	Contact mount bracket	Bracket to closely contact the back side of the sensor.	2 for an emitter, 2 for a receiver, total of 4 per set	F39-LJB5

*1 Combining F39-LJB2 and F39-LJB3-M6K makes F39-LJB3-M6.

*2 Combining F39-LJB2 and F39-LJB3-M8K makes F39-LJB3-M8.

Laser pointer

Appearance	Output	Order code
	Laser pointer for F3SJ	F39-PTJ

Specifications

Model		F3SJ-E____P25
Sensor type		Type 4 safety light curtain
Setting tool connection ^{*1}		Parameter settings: Not available
Safety category		Safety purpose of category 4, 3, 2, 1, or B
Detection capability		Opaque objects 25 mm in diameter
Beam gap (P)		20 mm
Number of beams (n)		8 to 54
Protective height (PH)		185 to 1,105 mm
Lens diameter		Diameter 5 mm
Operating range ^{*2}		0.2 to 7 m
Response time (under stable light incident condition)	ON to OFF	15 ms max.
	OFF to ON	70 ms max.
Startup waiting time		2 s max.
Power supply voltage (Vs)		SELV/PELV 24 VDC±20% (ripple p-p 10% max.)
Consumption current (no load)		Emitter: Up to 22 beams: 41 mA max., 26 to 42 beams: 57 mA max., 46 to 54 beams: 63 mA max. Receiver: Up to 22 beams: 42 mA max., 26 to 42 beams: 47 mA max., 46 to 54 beams: 51 mA max.
Light source (emitted wavelength)		Infrared LED (870 nm)
Effective aperture angle (EAA)		Based on IEC 61496-2. Within ±2.5° for both emitter and receiver when the detection distance is 3 m or over
Safety outputs (OSSD)		Two PNP transistor outputs, load current 200 mA max., residual voltage 2 V max. (except for voltage drop due to cable extension), Leakage current 1 mA max., load inductance 2.2 H max. ^{*3} , Maximum capacity load 1 μF ^{*4}
Output operation mode		Safety output: On when receiving light
Input voltage		ON voltage: Vs-3 V to Vs, OFF voltage: 0 V to 1/2 Vs or open ^{*5}
Mutual interference prevention function		Mutual interference prevention algorithm prevents interference in up to 3 sets.
Test function		Self test (at power-ON and at power distribution) External test (emission stop function by test input)
Protection circuit		Output short-circuit protection, and power supply reverse polarity protection
Ambient temperature		Operating: -10 to 55°C (non-freezing), Storage: -25 to 70°C
Ambient humidity		Operating: 35% to 85% (no condensation), Storage: 35% to 95% RH
Operating ambient light intensity		Incandescent lamp: 3,000 lx max., Sunlight: 10,000 lx max.
Insulation resistance		20 MΩ min. (at 500 VDC)
Dielectric strength		1,000 VAC 50/60 Hz, 1 min
Degree of protection		IP65 (IEC 60529)
Vibration resistance		Malfunction: 10 to 55 Hz, Multiple amplitude of 0.7 mm, 20 sweeps in X, Y, and Z directions
Shock resistance		Malfunction: 100 m/s ² , 1,000 times each in X, Y, and Z directions
Pollution degree		Pollution degree 3 (IEC 60664-1)
Power cable		Connection method: Pull-out type, cable length 3 m Number of wires: Emitter: 5 wires, receiver: 6 wires Cable diameter: Dia. 6 mm Allowable bending radius: R5 mm
Extension cable		30 m max. ^{*6}
Material		Case: Aluminum Cap: ABS resin, PBT Optical cover: PMMA resin (acrylic) Cable: Oil resistant PVC
Weight (packed state)		Weight (g) = (protective height) × 2.6 + 800
Accessories		Test rod, Instruction Manual, User's Manual (CD-ROM) ^{*7}
Applicable standards		IEC 61496-1, EN 61496-1 UL 61496-1, Type 4 ESPE (Electro-Sensitive Protective Equipment) IEC 61496-2, CLC/TS 61496-2, UL 61496-2, Type 4 AOPD (Active Opto-electronic Protective Devices) IEC 61508-1 to -3, EN 61508-1 to -3 SIL3 IEC 13849-1: 2006, EN ISO 13849-1: 2008 (PLe, Cat.4) UL 508, UL 1998, CAN/CSA C22.2 No.14, CAN/CSA C22.2 No.0.8

^{*1} Do not use the support software and setting console for F3SJ-A. Operation cannot be guaranteed.

^{*2} Use of the spatter protection cover causes a 10% maximum sensing distance attenuation.

^{*3} The load inductance is the maximum value when the safety output frequently repeats ON and OFF. When you use the safety output at 4 Hz or less, the usable load inductance becomes larger.

^{*4} These values must be taken into consideration when connecting elements including a capacitive load such as capacitor.

^{*5} The Vs indicates a voltage value in your environment.

^{*6} To extend a cable of the F3SJ-E, refer to the user's manual (SCHG-733/732).

^{*7} Mounting brackets are sold separately.

Connections

Basic wiring diagram

Minimum wiring required to check the operation of the F3SJ-E

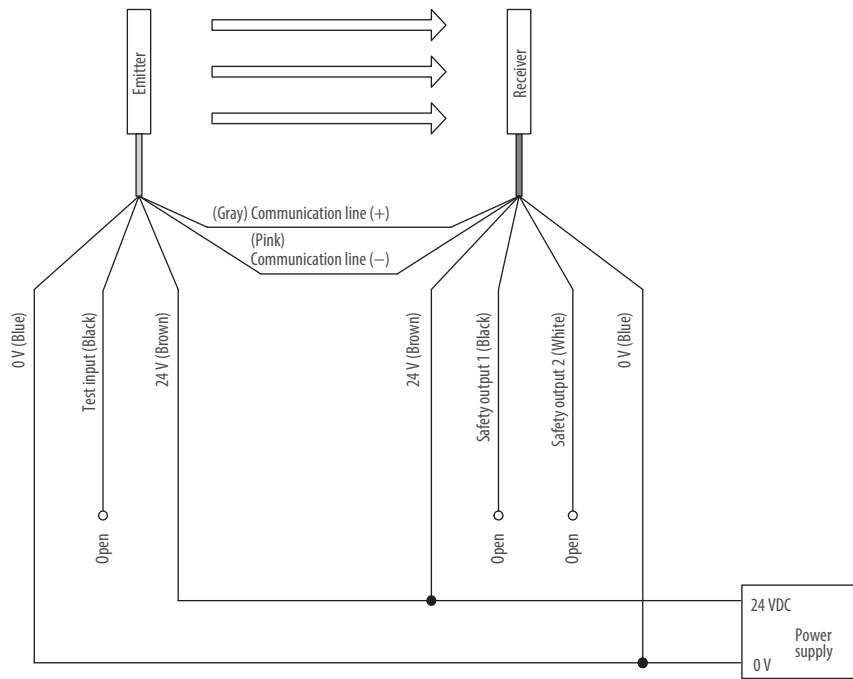



Basic type with a combination of performance and functionality

The F3SJ-B-family is a type 4 safety light curtain with an optical resolution of 25 mm. An operation range of up to 7 m and a protective height up to 2,065 mm are provided with no dead zone

- Detection height = sensor height
- Simple hand protection
- Muting function available
- Series connection up to three sets
- Type 4 sensor complying with EN 61496-1 and up to PLe according EN ISO 13849

Ordering information







Application	Detection capability	Beam gap	Operating range	Protective height (mm)	Order code
Hand protection	Dia. 25 mm	20 mm	0.2 to 7 m	185 to 2,065	F3SJ-B____P25

Number of beams	Protective height (mm) ^{*1}	Order code
8	185	F3SJ-B0185P25
10	225	F3SJ-B0225P25
14	305	F3SJ-B0305P25
18	385	F3SJ-B0385P25
22	465	F3SJ-B0465P25
26	545	F3SJ-B0545P25
30	625	F3SJ-B0625P25
34	705	F3SJ-B0705P25
38	785	F3SJ-B0785P25
42	865	F3SJ-B0865P25
46	945	F3SJ-B0945P25
50	1,025	F3SJ-B1025P25
54	1,105	F3SJ-B1105P25
58	1,185	F3SJ-B1185P25
62	1,265	F3SJ-B1265P25
66	1,345	F3SJ-B1345P25
70	1,425	F3SJ-B1425P25
74	1,505	F3SJ-B1505P25
78	1,585	F3SJ-B1585P25
82	1,665	F3SJ-B1665P25
86	1,745	F3SJ-B1745P25
90	1,825	F3SJ-B1825P25
94	1,905	F3SJ-B1905P25
98	1,985	F3SJ-B1985P25
102	2,065	F3SJ-B2065P25

^{*1} Protective height (mm) = Total sensor length

Accessories (sold separately)

Sensor mounting bracket

Appearance	Specifications	Application	Remarks	Order code
	Top/bottom bracket	Top/bottom bracket for F3SJ-E/B	2 for an emitter, 2 for a receiver, total of 4 per set	F39-LJB1
	Intermediate bracket	In combination use with top/bottom bracket for F3SJ-E/B Can be used as free-location bracket.	1 set with 2 pieces	F39-LJB2 ^{*1} ^{*2}
	Quick mount bracket	Quick mount bracket for F3SJ-E/B Supports M6 slide nut for aluminum frame.	1 set with 2 pieces	F39-LJB3-M6 ^{*1}
		Quick mount bracket for F3SJ-E/B Supports M8 slide nut for aluminum frame.		F39-LJB3-M8 ^{*2}
	Quick mount M6 bracket Quick mount M8 bracket	Bracket to mount an intermediate bracket to the aluminum frame with a single touch.	Hexagon socket head cap screws (M6 × 10) are included.	F39-LJB3-M6K ^{*1}
			Hexagon socket head cap screws (M8 × 14) are included.	F39-LJB3-M8K ^{*2}
	Compatible mounting bracket	Mounting bracket used when replacing existing area sensors (F3SJ-A or F3SN) with the F3SJ-E/B.	2 for an emitter, 2 for a receiver, total of 4 per set	F39-LJB4
	Contact mount bracket	Bracket to closely contact the back side of the sensor.	2 for an emitter, 2 for a receiver, total of 4 per set	F39-LJB5

^{*1} Combining F39-LJB2 and F39-LJB3-M6K makes F39-LJB3-M6.

^{*2} Combining F39-LJB2 and F39-LJB3-M8K makes F39-LJB3-M8.

Laser pointer

Appearance	Output	Order code
	Laser pointer for F3SJ	F39-PTJ

Specifications

Model		F3SJ-B___P25
Sensor type		Type 4 safety light curtain
Setting tool connection *1		Parameter settings: Not available
Safety category		Safety purpose of category 4, 3, 2, 1, or B
Detection capability		Opaque objects 25 mm in diameter
Beam gap (P)		20 mm
Number of beams (n)		8 to 102
Protective height (PH)		185 to 2,065 mm
Lens diameter		Diameter 5 mm
Operating range *2		0.2 to 7 m
Response time (under stable light incident condition)	ON to OFF	15 ms max. (response time at 1 set connection, series connection of 2 sets or 3 sets)
	OFF to ON	70 ms max. (response time at 1 set connection, series connection of 2 sets or 3 sets)
Startup waiting time		2 s max.
Power supply voltage (Vs)		SELV/PELV 24 VDC±20% (ripple p-p 10% max.)
Consumption current (no load)		Emitter: Up to 22 beams: 52 mA max., 26 to 42 beams: 68 mA max., 46 to 62 beams: 75 mA max., 66 to 82 beams: 88 mA max., 86 to 102 beams: 101 mA max. Receiver: Up to 22 beams: 45 mA max., 26 to 42 beams: 50 mA max., 46 to 62 beams: 56 mA max., 66 to 82 beams: 61 mA max., 86 to 102 beams: 67 mA max.
Light source (emitted wavelength)		Infrared LED (870 nm)
Effective aperture angle (EAA)		Based on IEC 61496-2. Within ±2.5° for both emitter and receiver when the detection distance is 3 m or over
Safety outputs (OSSD)		Two PNP transistor outputs, load current 200 mA max., residual voltage 2 V max. (except for voltage drop due to cable extension), Leakage current 1 mA max., load inductance 2.2 H max.*3, Maximum capacity load 1 µF*4
Auxiliary output 1		One PNP transistor outputs, load current 100 mA max., residual voltage 2 V max. (except for voltage drop due to cable extension), leak current 1 mA max.
Output operation mode		Safety output: On when receiving light Auxiliary output: – Reverse output of safety output for a basic system – ON when muting/override for a muting system
Input voltage		ON voltage: Vs-3 V to Vs, OFF voltage: 0 V to 1/2 Vs or open*5
Mutual interference prevention function		Mutual interference prevention algorithm prevents interference in up to 3 sets.
Series connection		Time division emission by series connection Number of connections: up to 3 sets (between F3SJ-Bs only) Other models cannot be connected. Total number of beams: up to 192 beams Maximum cable length for 2 sets: no longer than 7 m
Test function		Self test (at power-ON and at power distribution) External test (emission stop function by test input)
Safety-related functions		Interlock (basic system) External device monitoring (basic system) Muting (muting system) Override (muting system)
Connection type		Connector method (M12, 8-pin)
Protection circuit		Output short-circuit protection, and power supply reverse polarity protection
Ambient temperature		Operating: -10 to 55°C (non-freezing), Storage: -25 to 70°C
Ambient humidity		Operating: 35% to 85% (no condensation), Storage: 35% to 95% RH
Operating ambient light intensity		Incandescent lamp: 3,000 lx max., Sunlight: 10,000 lx max.
Insulation resistance		20 MΩ min. (at 500 VDC)
Dielectric strength		1,000 VAC 50/60 Hz, 1 min
Degree of protection		IP65 (IEC 60529)
Vibration resistance		Malfunction: 10 to 55 Hz, Multiple amplitude of 0.7 mm, 20 sweeps in X, Y, and Z directions
Shock resistance		Malfunction: 100 m/s ² , 1,000 times each in X, Y, and Z directions
Pollution degree		Pollution degree 3 (IEC 60664-1)
Power cable		Connection method: Prewired connector cable, cable length 0.3 m, connector type (M12, 8-pin), connector: IP67 rated (when mated) Number of wires: 8 wires Cable diameter: Dia. 6 mm Allowable bending radius: R5 mm
Extension cable		30 m max.
Material		Case: Aluminum Cap: ABS resin, PBT Optical cover: PMMA resin (acrylic) Cable: Oil resistant PVC
Weight (packed state)		Weight (g) = (protective height) × 2.7 + 500
Accessories		Test rod, Instruction manual, User's manual (CD-ROM)*6
Applicable standards		IEC 61496-1, EN 61496-1 UL 61496-1, Type 4 ESPE (Electro-sensitive protective equipment) IEC 61496-2, CLC/TS 61496-2, UL 61496-2, Type 4 AOPD (Active opto-electronic protective devices) IEC 61508-1 to -3, EN 61508-1 to -3 SIL3 IEC 13849-1: 2006, EN ISO 13849-1: 2008 (PLe, Cat.4) UL 508, UL 1998, CAN/CSA C22.2 No.14, CAN/CSA C22.2 No.0.8

*1 Do not use the support software and setting console for F3SJ-A. Operation cannot be guaranteed.

*2 Use of the spatter protection cover causes a 10% maximum sensing distance attenuation.

*3 The load inductance is the maximum value when the safety output frequently repeats ON and OFF. When you use the safety output at 4 Hz or less, the usable load inductance becomes larger.

*4 These values must be taken into consideration when connecting elements including a capacitive load such as capacitor.

*5 The Vs indicates a voltage value in your environment.

*6 Mounting brackets are sold separately.

Connections

Basic Wiring Diagram

Wiring when using manual reset mode, external device monitoring (F3SJ-B ____ P25) (PNP output)

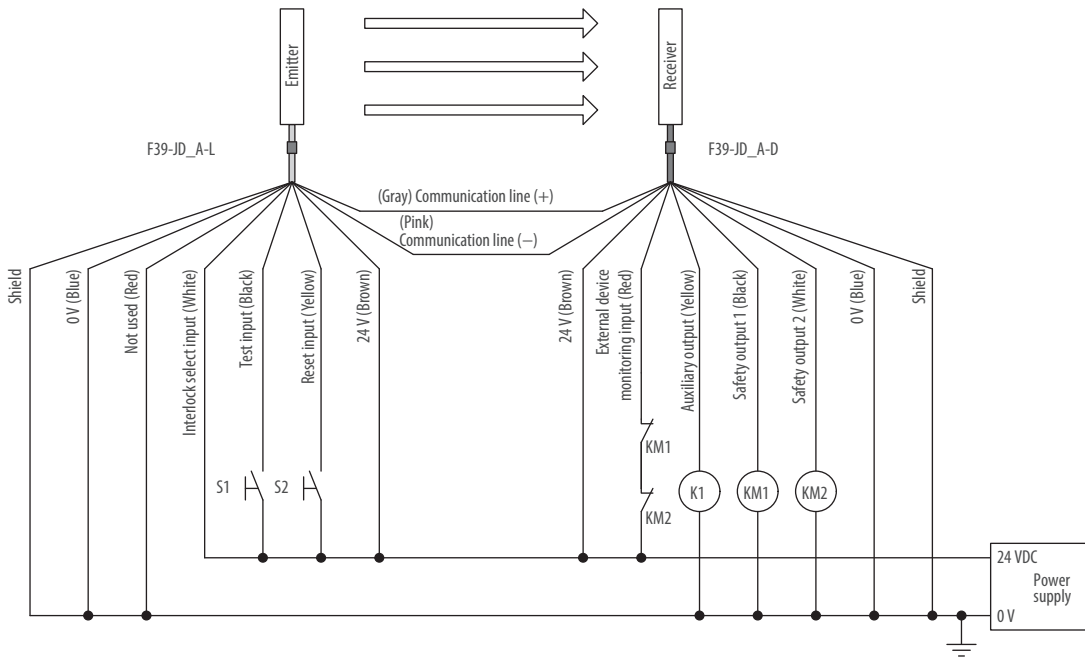

- S1 : External test switch (connect to 0V if a switch is not required)
- S2 : Interlock/lockout reset switch
- KM1, KM2 : Safety relay with force-guided contact (G7SA) or magnetic contactor
- K1 : Load or PLC, etc. (for monitoring)



Advanced type for complex safety solutions

The F3SJ-A-family is a type 4 safety light curtain with an optical resolution of 14 mm and 30 mm. An operating range of up to 9 m and protective heights up to 2,495 mm are provided with no dead zone.

- Detection height = sensor height
- Muting and blanking function available
- Series connection up to 4 Sets
- LED bar for easy alignment and diagnosis
- Type 4 sensor complying with EN 61496-1 and up to PLe according EN ISO 13849-1

Ordering information

Application	Detection capability	Beam gap	Operating range	Protective height (mm)	Order code
Finger protection	Dia. 14 mm	9 mm	0.2 to 9 m	245 to 1,631	F3SJ-A____P14
Hand/arm protection	Dia. 30 mm	25 mm	0.2 to 9 m	245 to 1,620	F3SJ-A____P30
			0.2 to 7 m	1,745 to 2,495	

Safety light curtain model list

F3SJ-A14 series (9 mm gap), F3SJ-A14 TS series (9 mm gap)

Number of beams	Protective height (mm) ^{*1}	Order code
26	245	F3SJ-A0245P14
28	263	F3SJ-A0263P14
34	317	F3SJ-A0317P14
42	389	F3SJ-A0389P14
50	461	F3SJ-A0461P14
60	551	F3SJ-A0551P14
68	623	F3SJ-A0623P14
76	695	F3SJ-A0695P14
80	731	F3SJ-A0731P14
88	803	F3SJ-A0803P14
96	875	F3SJ-A0875P14
108	983	F3SJ-A0983P14
116	1,055	F3SJ-A1055P14
124	1,127	F3SJ-A1127P14
132	1,199	F3SJ-A1199P14
140	1,271	F3SJ-A1271P14

^{*1} Protective height (mm) = Total sensor length

F3SJ-A30 series (25 mm gap)

Number of beams	Protective height (mm) ^{*1}	Order code
10	245	F3SJ-A0245P30
12	295	F3SJ-A0295P30
16	395	F3SJ-A0395P30
19	470	F3SJ-A0470P30
21	520	F3SJ-A0520P30
22	545	F3SJ-A0545P30
23	570	F3SJ-A0570P30
25	620	F3SJ-A0620P30
29	720	F3SJ-A0720P30
32	795	F3SJ-A0795P30
35	870	F3SJ-A0870P30
37	920	F3SJ-A0920P30
38	945	F3SJ-A0945P30
41	1,020	F3SJ-A1020P30
44	1,095	F3SJ-A1095P30
45	1,120	F3SJ-A1120P30
48	1,195	F3SJ-A1195P30
51	1,270	F3SJ-A1270P30
56	1,395	F3SJ-A1395P30
65	1,620	F3SJ-A1620P30
70	1,745	F3SJ-A1745P30
75	1,870	F3SJ-A1870P30
80	1,995	F3SJ-A1995P30
90	2,245	F3SJ-A2245P30
95	2,370	F3SJ-A2370P30
100	2,495	F3SJ-A2495P30

^{*1} Protective height (mm) = Total sensor length

Accessories (sold separately)

Single-end connector cable (2 cables per set, for emitter and receiver)









For wiring with safety circuit such as single safety relay, safety relay unit, and safety controller.

Appearance	Cable length	Specifications	Order code
	0.5 m	M12 connector (8-pin)	F39-JCR5A
	3 m		F39-JC3A
	7 m		F39-JC7A
	10 m		F39-JC10A
	15 m		F39-JC15A
	20 m		F39-JC20A

Setting Tools

Appearance	Type	Remarks	Order code
	“SD Manager” Setting support software for the F3SJ	Accessories: SD Manager CD-ROM (1), F39-CN1 branch connector (1), Connector cap (1), 2-m Dedicated cable (1), 0.3-m Dedicated cable with plug (1), Instruction manual	F39-GWUM

Sensor Mounting Brackets (Sold separately)

Appearance	Specifications	Application	Remarks	Order code
	Standard mounting bracket (for top/bottom)	(provided with the F3SJ)	2 for an emitter, 2 for a receiver, total of 4 per set	F39-LJ1
	Flat side mounting bracket	Use these small-sized brackets when performing side mounting with standard mounting brackets, so that they do not protrude from the detection surface.	2 for an emitter, 2 for a receiver, total of 4 per set	F39-LJ2
	Free-location mounting bracket (also used as standard intermediate bracket)	Use these brackets for mounting on any place without using standard bracket.	Two brackets per set	F39-LJ3
	F3SN Intermediate bracket Replacement spacers	When replacing the F3SN with the F3SJ, the mounting hole pitches in the Intermediate Brackets are not the same. This Spacer is placed between the mounting holes to mount the F3SJ.	1 set with 2 pieces	F39-LJ3-SN
	Top/bottom bracket B (mounting hole pitch 19 mm)	Mounting bracket used when replacing existing area sensors (other than F3SN or F3WN) with the F3SJ. For front mounting. Suitable for mounting hole pitch of 18 to 20 mm.	2 for an emitter, 2 for a receiver, total of 4 per set	F39-LJ4
	Bracket for replacing short-length F3SN	Mounting bracket used when an F3SN with protective height of 300 mm or less is replaced by an F3SJ.	2 for an emitter, 2 for a receiver, total of 4 per set	F39-LJ5
	Space-saving mounting bracket	Use these brackets to mount facing inward. Length is 12 mm shorter than the standard F39-LJ1 bracket.	2 for an emitter, 2 for a receiver, total of 4 per set	F39-LJ8
	Top/bottom bracket C (mounting hole pitch 13 mm)	Mounting bracket used when replacing existing area sensors having a mounting pitch of 13 mm with the F3SJ.	2 for an emitter, 2 for a receiver, total of 4 per set	F39-LJ11

Laser pointer

Appearance	Output	Order code
	Laser pointer for F3SJ	F39-PTJ

Specifications

F3SJ-A ___ P14/P30

Model	F3SJ-A ___ P14	F3SJ-A ___ P30
Sensor type	Type 4 safety light curtain	
Version	Ver. 2	
Setting tool connection	Connectable	
Safety category	Safety purpose of category 4, 3, 2, 1, or B	
Detection capability	Opaque objects 14 mm in diameter	Opaque objects 30 mm in diameter
Beam gap (P)	9 mm	25 mm
Number of beams (n)	26 to 180	10 to 100
Protective height (PH)	245 to 1,631 mm	245 to 2,495 mm
Lens diameter	Diameter 5 mm	
Operating range	0.2 to 9 m (protective height 1,640 mm max.), 0.2 to 7 m (protective height 1,655 mm min.) (Depending on the setting tool, the detection distance can be shortened to 0.5 m.)	
Response time (under stable light incident condition)	ON to OFF	1 set, 0245 to 983: 11 ms to 17.5 ms max. 1,055 or higher: 20 ms to 25 ms max.
	OFF to ON	1 set, 0245 to 983: 44 ms to 70 ms max. 1,055 or higher: 80 ms to 100 ms max.
Startup waiting time	2 s max. (2.2 s max. for series connection)	
Power supply voltage (Vs)	24 VDC±20% (ripple p-p10% max.)	
Current consumption (no load)	Emitter	To 50 beams: 76 mA max., 51 to 100 beams: 106 mA max., 101 to 150 beams: 130 mA max., 151 to 180 beams: 153 mA max., 201 to 234 beams: 165 mA max.
	Receiver	To 50 beams: 68 mA max., 51 to 100 beams: 90 mA max., 101 to 150 beams: 111 mA max., 151 to 180 beams: 128 mA max., 201 to 234 beams: 142 mA max.
Light source (emitted wavelength)	Infrared LED (870 nm)	
Effective aperture angle (EAA)	Based on IEC 61496-2. Within ±2.5° for both emitter and receiver when the detection distance is 3 m or over	
Safety outputs (OSSD)	Two PNP transistor outputs, load current 300 mA max., residual voltage 2 V max. (except for voltage drop due to cable extension), allowable capacity load 2.2 µF, leak current 1 mA max. (This can be different from traditional logic (ON/OFF) because safety circuit is used.)	
Auxiliary output 1 (Non-safety output)	One PNP transistor output, load current 300 mA max., residual voltage 2 V max. (except for voltage drop due to cable extension), leak current 1 mA max.	
Auxiliary output 2 (Non-safety output. Function for Basic System.)	One PNP transistor output, load current 50 mA max., residual voltage 2 V max. (except for voltage drop due to cable extension), leak current 1 mA max.	
External indicator output (Non-safety output)	Available indicators Incandescent lamp: 24 VDC, 3 to 7 W LED lamp: Load current 10 mA to 300 mA max., leak current 1 mA max. (To use an external indicator, an F39-JJ3N universal indicator cable or an F39-A01P-PAC dedicated external indicator kit is required.)	
Output operation mode	Receiver	Safety output 1, 2: ON when receiving light Auxiliary output 1: Inverse of safety output signals (Operation mode can be changed with the setting tool.) External indicator output 1: Inverse of safety output signals for a basic system (Operation mode can be changed with the setting tool.), ON when muting/override for a muting system (Operation mode can be changed with the setting tool.)
	Emitter	Auxiliary output 2: Turns ON when the point of 30,000 operating hours is reached (Operation mode can be changed with the setting tool.) External indicator output 2: ON when lock-out for a basic system (Operation mode can be changed with the setting tool.) ON when muting/override for a muting system (Operation mode can be changed with the setting tool.)

Model		F3SJ-A P14	F3SJ-A P30
Input voltage		Test input, interlock selection input, reset input, and muting input are all ON voltage: 9 to 24 V (Vs) (sink current: 3 mA max.), OFF voltage: 0 to 1.5 V, or open External device monitoring input ON voltage: 9 to 24 V (Vs) (sink current: 5 mA max.), OFF voltage: 0 to 1.5 V, or open	
Indicator	Emitter	Light intensity level indicators (green LED × 2, orange LED × 3): ON based on the light intensity Error mode indicators (red LED × 3): Blink to indicate error details Power indicator (green LED × 1): ON while power is on Interlock indicator (yellow LED × 1): ON while under interlock, blinks at lockout. External device monitoring indicator (muting input 1 indicator), Blanking/test indicator (muting input 2 indicator) (green LED × 2): ON/flash according to function	
	Receiver	Light intensity level indicators (green LED × 2, orange LED × 3): ON based on the light intensity Error mode indicators (red LED × 3): Blink to indicate error details OFF output indicator (red LED × 1): ON when safety output is OFF, blinks at lockout. ON output indicator (green LED × 1): ON while safety output is ON Muting error indicator, Blanking/test indicator (green LED × 2): ON/flash according to function	
Mutual interference prevention function		Interference light prevention algorithm, sensing distance change function	
Series connection		Time division emission by series connection Number of connections: up to 4 sets (F3SJ-A only) F3SJ-E, F3SJ-B and F3SJ-TS cannot be connected. Total number of beams: up to 400 beams Maximum cable length for 2 sets: no longer than 15 m	
Test function		Self test (at power-ON and at power distribution) External test (emission stop function by test input)	
Safety-related functions		Start interlock, restart interlock (Must be set with a setting tool when the muting function is used.) External device monitor Muting (Lamp burnout detection, override function included. F39-CN6 key cap for muting is required.) Fixed blanking (must be set by a setting tool) Floating blanking (must be set by a setting tool)	
Connection method		Connector method (M12, 8-pin)	
Protection circuit		Output short-circuit protection, and power supply reverse polarity protection	
Ambient temperature		Operating: -10 to 55°C (no icing), Storage: -30 to 70°C	
Ambient humidity		Operating: 35% to 85% (no condensation), Storage: 35% to 95%	
Operating ambient light intensity		Incandescent lamp: receiving-surface light intensity of 3,000 lx max., Sunlight: receiving-surface light intensity of 10,000 lx max.	
Insulation resistance		20 MΩ min. (at 500 VDC)	
Withstand voltage		1,000 VAC 50/60 Hz, 1 min	
Degree of protection		IP65 (IEC 60529)	
Vibration resistance		Malfunction: 10 to 55 Hz, Multiple amplitude of 0.7 mm, 20 sweeps in X, Y, and Z directions	
Shock resistance		Malfunction: 100 m/s ² , 1,000 times each in X, Y, and Z directions	
Material		Casing (including metal parts on both ends): Aluminum, zinc die-cast Cap: ABS resin, Optical cover: PMMA resin (acrylic), Cable: Oil resistant PVC	
Weight (packaged)		Calculate using the following expressions: (1) For F3SJ-A P14, weight (g) = (protective height) × 1.7 + α (2) F3SJ-A P30, weight (g) = (protective height) × 1.5 + α The values for α are as follows: Protected height 245 to 596 mm: = 1,100 protected height 1,660 to 2,180 mm: = 2,400 Protected height 600 to 1,130 mm: = 1,500 protected height 2,195 to 2,500 mm: = 2,600 Protected height 1,136 to 1,658 mm: = 2,000	
Accessories		Test rod (*1), instruction manual, standard mounting bracket (F39-LJ1 bracket for top/bottom mounting), mounting brackets (intermediate) (*2), error mode label, User's Manual (CD-ROM) *1. The F3SJ-A P14 P30 is not included. *2. Number of intermediate brackets depends on protective height of F3SJ. For protective height from 600 to 1,130 mm: 1 set for each of the emitter and receiver is included For protective height from 1,136 to 1,658 mm: 2 sets for each of the emitter and receiver are included For protective height from 1,660 to 2,180 mm: 3 sets for each of the emitter and receiver are included For protective height from 2,195 to 2,500 mm: 4 sets for each of the emitter and receiver are included	
Applicable standards		IEC 61496-1, EN 61496-1 UL 61496-1, Type 4 ESPE (Electro-Sensitive Protective Equipment) IEC 61496-2, CLC/TS 61496-2, UL 61496-2, Type 4 AOPD (Active Opto-electronic Protective Devices) IEC 61508-1 to -3, EN 61508-1 to -3 SIL3 IEC 13849-1: 2006, EN ISO 13849-1: 2008 (PLe, Cat.4) UL 508, UL 1998, CAN/CSA C22.2 No.14, CAN/CSA C22.2 No.0.8	

Response Time

Model	Protected height (mm)	Number of beams	Response time ms (ON to OFF)	Response time ms (OFF to ON)
F3SJ-A____14 Series	245 to 263	26 to 28	11	44
	281 to 389	30 to 42	12	48
	407 to 497	44 to 54	13	52
	515 to 605	56 to 66	14	56
	623 to 731	68 to 80	15	60
	767 to 983	84 to 108	17.5	70
	1,055 to 1,271	116 to 140	20	80
	1,343 to 1,559	148 to 172	22.5	90
	1,631	180	25	100
F3SJ-A____30 Series	245 to 395	10 to 16	10	40
	420 to 720	17 to 29	11	44
	745 to 1,045	30 to 42	12	48
	1,070 to 1,295	43 to 52	13	52
	1,395 to 1,620	56 to 65	14	56
	1,745 to 1,995	70 to 80	15	60
	2,120 to 2,495	85 to 100	17.5	70

Note: Use the following expressions for series connection.

- For 2-set series connection:
Response time (ON to OFF): Response time of the 1st unit + Response time of the 2nd unit – 1 (ms), Response time (OFF to ON): Response time calculated by the above × 4 (ms)
- For 3-set series connection:
Response time (ON to OFF):
Response time of the 1st unit + Response time of the 2nd unit + Response time of 3rd unit – 5 (ms), Response time (OFF to ON): Response time calculated by the above × 5 (ms)
For models with the “-TS” suffix, multiply the response time obtained by the above × 5 (ms), or use 200 ms, whichever is less.)
- For 4-set series connection:
Response time (ON to OFF): Response time of the 1st unit + Response time of the 2nd unit + Response time of the 3rd unit + Response time of the 4th unit – 8 (ms)
Response time (OFF to ON): Response time calculated by the above × 5 (ms)

Cable extension length

Total cable extension length must be no greater than the lengths described below.

When the F3SJ and an external power supply are directly connected, or when the F3SJ is connected to a G9SA-300-SC.

Condition	1 set	2 sets	3 sets	4 sets
Using incandescent lamp for auxiliary output and external indicator output	45 m	40 m	30 m	20 m
Not using incandescent lamp	100 m	60 m	45 m	30 m

When connected to the F3SP-B1P

Condition	1 set	2 sets	3 sets	4 sets
Using incandescent lamp for external indicator output 2	40 m	30 m	25 m	20 m
Using incandescent lamp for external indicator output 1	60 m	45 m	30 m	20 m
Using incandescent lamp for auxiliary output 1				
Not using incandescent lamp	100 m	60 m	45 m	30 m

Note: Keep the cable length within the rated length. Failure to do so is dangerous as it may prevent safety functions from operating normally.

Connections

Basic Wiring Diagram

PNP Output

Wiring when using manual reset mode, external device monitoring.

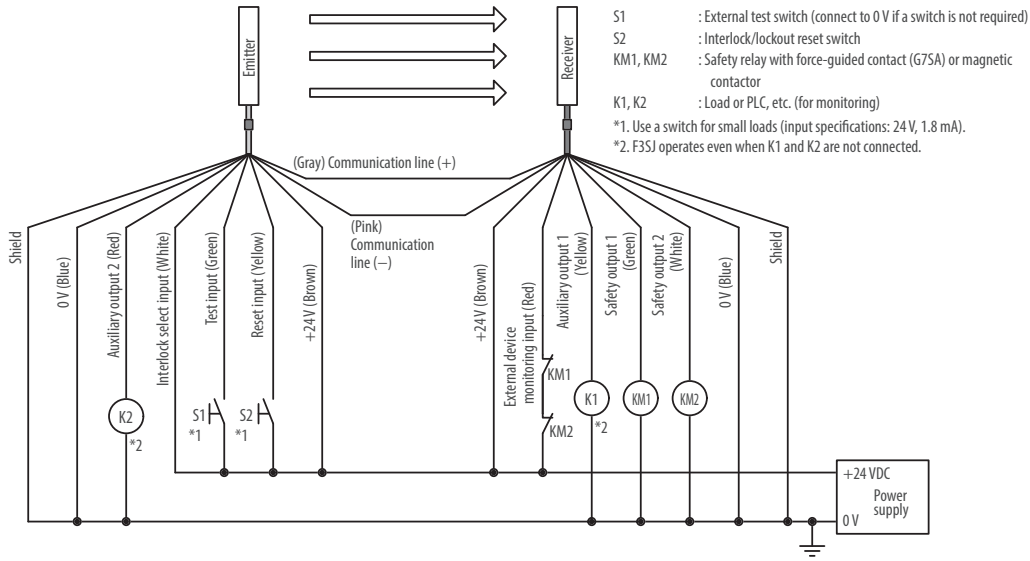



Category 4 / 2 safety light curtain

The MS4800 and MS2800 family of safety light curtain provides simplicity in mounting, configuring, daily use and maintenance by providing a:

- Sensing distance up to 20m for 30mm resolution and 7 m for 14mm resolution
- LED bar for easy alignment and diagnosis
- DIP-switch setup for blanking, muting and optical coding
- Category 4 / 2 sensor complying with EN 61496-1
- All-in-one M12 connection and mounting concept with robust housing
- Multicascadable up to 3 sets

Ordering information

MS2800 Safety Category 2

Connection features	Standard				Master				Slave	
Standard Standalone operation										
Master Series connection, muting										
Slave Series connection only										
Function Set	MS2800S-				MS2800FS-				MS2800F-	
	Basic		Advanced		Basic		Advanced			
Basic Interlock, restart, EDM, 2 optical channels, integrated alignment tool										
Advanced Muting, blanking (fixed/floating)										
	MS2800S-EB-		MS2800S-EA-		MS2800FS-EB-		MS2800FS-EA-		MS2800F-E-	
Resolution	14 mm	30 mm	14 mm	30 mm	14 mm	30 mm	14 mm	30 mm	14 mm	30 mm
14 mm finger protection	MS2800S-EB-014-	MS2800S-EB-030-	MS2800S-EA-014-	MS2800S-EA-030-	MS2800FS-EB-014-	MS2800FS-EB-030-	MS2800FS-EA-014-	MS2800FS-EA-030-	MS2800F-E-014-	MS2800F-E-030-
30 mm hand protection										
Length	280 ... 1800		280 ... 2120		280 ... 1800		280 ... 2120		240 ... 1280	
240 mm ... 2120 mm in										
40 mm increments										

MS4800 Safety Category 4

Connection features	Standard				Master				Slave	
Standard Standalone operation										
Master Series connection, muting										
Slave Series connection only										
Function Set	MS4800S-				MS4800FS-				MS4800F-	
	Basic		Advanced		Basic		Advanced			
Basic Interlock, restart, EDM, 2 optical channels, integrated alignment tool										
Advanced Muting, blanking (fixed/floating)										
	MS4800S-EB-		MS4800S-EA-		MS4800FS-EB-		MS4800FS-EA-		MS4800F-E-	
Resolution	14mm	30mm	14mm	30mm	14mm	30mm	14mm	30mm	14mm	30mm
14 mm finger protection	MS4800S-EB-014-	MS4800S-EB-030-	MS4800S-EA-014-	MS4800S-EA-030-	MS4800FS-EB-014-	MS4800FS-EB-030-	MS4800FS-EA-014-	MS4800FS-EA-030-	MS4800F-E-014-	MS4800F-E-030-
30 mm hand protection										
Length	280 ... 1800		280 ... 2120		280 ... 1800		280 ... 2120		240 ... 1280	
240 mm ... 2120 mm in										
40 mm increments										

Examples

MS2800S-EB-030-1000
 Standalone operation
 Basic function set
 30 mm resolution
 1000 mm protective height

MS4800FS-EA-014-1200
 Series connection model
 Advanced function set
 14 mm resolution
 1200 mm protective height

MS4800F-E-014-600
 Slave operation
 14 mm resolution
 600 mm protective height

Specifications

Model	MS4800_-E_ -_-_-_-_-	MS2800_-E_ -_-_-_-_-
Sensor type	Type 4	Type2
Normal operating range	14 mm resolution: 0.3 - 7 m, 30 mm resolution: 0.3 - 20 m	
Reduced range (DIP-switch 6)	14 mm resolution: 0.3 - 3 m, 30 mm resolution: 0.3 - 8 m	
Beam pitch	14 mm resolution: 10 mm; 30 mm resolution: 20 mm	
Protective height	14 mm resolution: 280 - 1800 mm; 30 mm resolution: 240 - 2120 mm	
Detection capability	14 mm resolution: 14 mm non-transparent; 30 mm resolution: 30 mm non-transparent	
Effective aperture angle (EAA)	Within $\pm 2,5^{\circ}$ Within $\pm 5,0^{\circ}$ for the emitter and receiver at a detection distance of at least 3m according to IEC61496-2	
Light source	Infrared LED's (880 nm), Power dissipation: 180 mW, Class 1 per EN60825-1	
Supply voltage (Vs)	24 VDC $\pm 20\%$, according EN/IEC60204, able to cover a drop of voltage of at least 20 msec	
OSSD	Two safety related PNP transistor output, load current 625 mA max.*1, short circuit protection	
Auxiliary output (non safety output)	One PNP output sourcing 100mA @ 24VDC. This output follows the OSSD's	
Output operation mode	OSSD output: Light-ON	
Test functions	Self-test (after power ON and during operation)	
Safety-related functions	All versions: Auto reset/interlock with manual reset, EDM (external device monitoring) advanced versions only: fixed blanking, floating blanking, muting	
Response time	ON to OFF: 14 to 59 ms	
Ambient light intensity	Incandescent lamp: 3000 lx max. (light intensity on the receiver surface)	
Ambient temperature	Operating: -10°C to $+55^{\circ}\text{C}$, storage: -25°C to $+70^{\circ}\text{C}$ (without icing or condensation)	
Degree of protection	IP65 (IEC60529)	
Connection method	Flexible cable with M 12 connection: receiver: 8 pins, transmitter: 5 pins	
Materials	Case: Polyurethane powder painted aluminum, cap: polycarbonate, front window: acrylic, mounting brackets: cold rolled steel	
Size (cross section)	39 x 50 mm	
Receiver indicator lights	Individual Beam Indicator (IBI), interlock, blanking activ, RUN and STOP state, error codes	
Transmitter indicator lights	ON, OFF, failure	
AOPD (ESPE)	Type4 acc. IEC 61496-1	Type2 acc. IEC 61496-1
Suitable for safety control systems	Cat. 4 acc. EN954-1, PL acc. EN ISO 13849-1	Cat. 2 acc. EN954-1, PLC acc. EN ISO 13849-1
Safety Integrity Level	SIL 3 according IEC 61508	
PFH	$5,9 \times 10^{-8}$	

*1 Up to 12 m we recommend to use the F39-JMR cables, to use longer cables and a current of 625 mA the F39-JMR cables are necessary.

Connection example

Using a manual restart and an external device monitoring

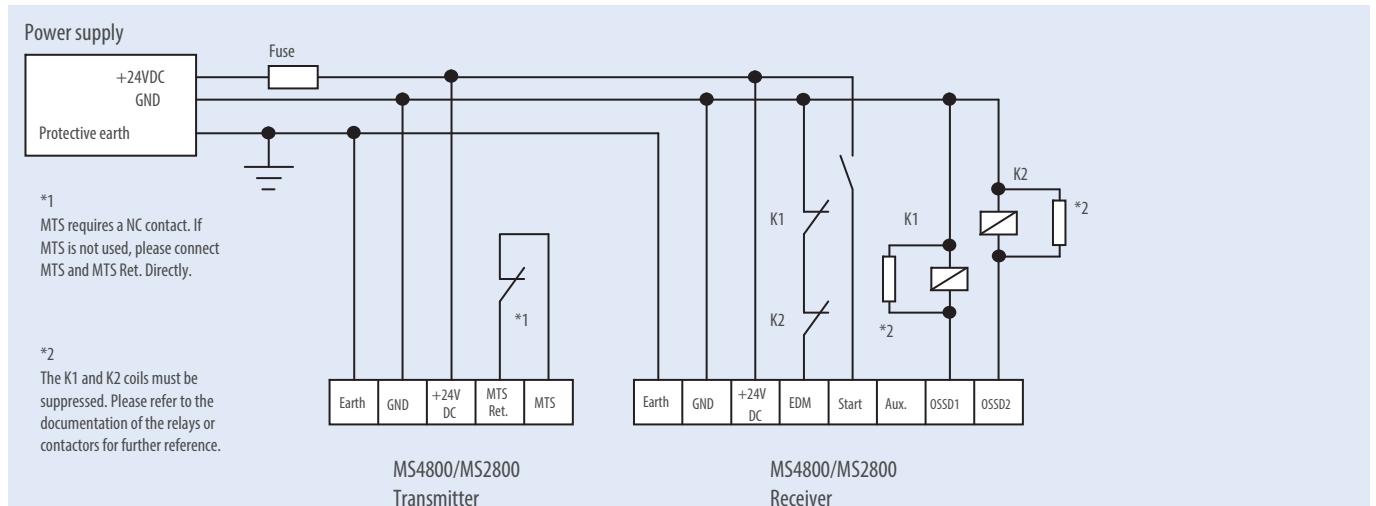

K1 and K2 forcibly guided relay's expected



Multi-beam, finger- and hand protection safety sensor

The F3S-TGR-CL multi-beam, finger- and hand protection safety sensors satisfying with integrated safety control functions selectable via built-in dip-switches.

- Type 2 or type 4 acc. EN61496-1
- PL c or PL e acc. ISO13849
- Family concept in wiring and mounting
- All models with dip-switch setup for external device monitoring, interlock function, range setting (short and long range) and optical or wired coding
- Advanced models with pre-reset function, T-, L- or X- muting function and muting lamp integrated

Ordering information

Multi-beam safety sensors

F3S-TGR-CL2_-K_ (Type 2)

System	Sensing distance	Detection capability	Order code	
			Basic feature set* ¹	Advanced feature set* ²
Active/passive	0.5 m to 12 m	500	F3S-TGR-CL2B-K2C-500	F3S-TGR-CL2A-K2C-500
	0.5 m to 8 m	400	F3S-TGR-CL2B-K3C-800	F3S-TGR-CL2A-K3C-800
	0.5 m to 7 m	300	F3S-TGR-CL2B-K4C-900	F3S-TGR-CL2A-K4C-900
		400	F3S-TGR-CL2B-K4C-1200	F3S-TGR-CL2A-K4C-1200
Active/active	0.5 m to 40 m	500	F3S-TGR-CL2B-K2-500	F3S-TGR-CL2A-K2-500
		400	F3S-TGR-CL2B-K3-800	F3S-TGR-CL2A-K3-800
		300	F3S-TGR-CL2B-K4-900	F3S-TGR-CL2A-K4-900
		400	F3S-TGR-CL2B-K4-1200	F3S-TGR-CL2A-K4-1200
Active/active, long distance	25 m to 50 m	500	F3S-TGR-CL2B-K2-500-LD	F3S-TGR-CL2A-K2-500-LD
		400	F3S-TGR-CL2B-K3-800-LD	F3S-TGR-CL2A-K3-800-LD
		300	F3S-TGR-CL2B-K4-900-LD	F3S-TGR-CL2A-K4-900-LD
		400	F3S-TGR-CL2B-K4-1200-LD	F3S-TGR-CL2A-K4-1200-LD

F3S-TGR-CL4_-K_ (Type 4)

System	Sensing distance	Detection capability	Order code	
			Basic feature set* ¹	Advanced feature set* ²
Active/passive	0.5 m to 12 m	500	F3S-TGR-CL4B-K2C-500	F3S-TGR-CL4A-K2C-500
	0.5 m to 8 m	400	F3S-TGR-CL4B-K3C-800	F3S-TGR-CL4A-K3C-800
	0.5 m to 7 m	300	F3S-TGR-CL4B-K4C-900	F3S-TGR-CL4A-K4C-900
		400	F3S-TGR-CL4B-K4C-1200	F3S-TGR-CL4A-K4C-1200
Active/active	0.5 m to 40 m	500	F3S-TGR-CL4B-K2-500	F3S-TGR-CL4A-K2-500
		400	F3S-TGR-CL4B-K3-800	F3S-TGR-CL4A-K3-800
		300	F3S-TGR-CL4B-K4-900	F3S-TGR-CL4A-K4-900
		400	F3S-TGR-CL4B-K4-1200	F3S-TGR-CL4A-K4-1200
Active/active, long distance	25 m to 50 m	500	F3S-TGR-CL4B-K2-500-LD	F3S-TGR-CL4A-K2-500-LD
		400	F3S-TGR-CL4B-K3-800-LD	F3S-TGR-CL4A-K3-800-LD
		300	F3S-TGR-CL4B-K4-900-LD	F3S-TGR-CL4A-K4-900-LD
		400	F3S-TGR-CL4B-K4-1200-LD	F3S-TGR-CL4A-K4-1200-LD

*¹ Basic feature set: Manual/automatic restart, coding

*² Advanced feature set: Basic + Muting + integrated Muting lamp + Pre-reset

Safety sensors

F3S-TGR-CL2_ (Type 2)

Feature set	Master/Slave	Sensing distance	Detection capability	Length	Order code	
Basic*1	Standalone	0.2 m to 6 m	14 mm	150 mm to 2,400 mm*3	F3S-TGR-CL2B-014-__	
		0.2 m to 14 m	35 mm		F3S-TGR-CL2B-035-__	
Advanced*2	Standalone	0.2 m to 6 m	14 mm		150 mm to 2,250 mm*3	F3S-TGR-CL2A-014-__
		0.2 m to 14 m	35 mm			F3S-TGR-CL2A-035-__
	Master	0.2 m to 6 m	14 mm	F3S-TGR-CL2A-014-_M		
		0.2 m to 14 m	35 mm	F3S-TGR-CL2A-035-_M		
	Slave	0.2 m to 6 m	14 mm	F3S-TGR-CL2A-014-_S		
		0.2 m to 14 m	35 mm	F3S-TGR-CL2A-035-_S		
			70 mm	300 mm to 2,100 mm	F3S-TGR-CL2A-070-_S	

F3S-TGR-CL4_ (Type 4)

Feature set	Master/Slave	Sensing distance	Detection capability	Length	Order code	
Basic*1	Standalone	0.2 m to 6 m	14 mm	150 mm to 2,400 mm*3	F3S-TGR-CL4B-014-__	
		0.2 m to 14 m	35 mm		F3S-TGR-CL4B-035-__	
Advanced*2	Standalone	0.2 m to 6 m	14 mm		150 mm to 2,250 mm*3	F3S-TGR-CL4A-014-__
		0.2 m to 14 m	35 mm			F3S-TGR-CL4A-035-__
	Master*4	0.2 m to 6 m	14 mm	F3S-TGR-CL4A-014-_M		
		0.2 m to 14 m	35 mm	F3S-TGR-CL4A-035-_M		
	Slave*4	0.2 m to 6 m	14 mm	F3S-TGR-CL4A-014-_S		
		0.2 m to 14 m	35 mm	F3S-TGR-CL4A-035-_S		
			70 mm	300 mm to 2,100 mm	F3S-TGR-CL4A-070-_S	

*1 Basic feature set:Manual/automatic restart, coding

*2 Advanced feature set:Basic + Muting + integrated Muting lamp + Pre-reset

*3 Available length (in mm):150, 300, 450, 600, 750, 900, 1,050, 1,200, 1,350, 1,500, 1,650, 1,800, 1,950, 2,100, 2,250, (2,400 mm, only standalone versions)

*4 Master/slave system:A master/slave system cannot exceed the total length of 2,400 mm

F3S-TGR-CL- _ _M/S Master-Slave Series

- A Master-Slave cascade system is made of one master segment and one slave segment.
- The length of the total protective field can vary from minimum 300 mm till maximum 2,400 mm.

- The interconnect cable length limitation between master and slave segment is in total max. 0,9 m.

Possible combinations of master and slave are in this table:

		Slave models																					
		14 mm or 35 mm resolution															70 mm resolution						
		150	300	450	600	750	900	1,050	1,200	1,350	1,500	1,650	1,800	1,950	2,150	2,250	300	600	900	1,200	1,500	1,800	2,100
Master models (14 mm or 35 mm resolution)	150	OK	OK	OK	OK	OK	OK	OK	OK	OK	OK	OK	OK	OK	OK	OK	OK	OK	OK	OK	OK	OK	OK
	300	OK	OK	OK	OK	OK	OK	OK	OK	OK	OK	OK	OK	OK	OK	OK	OK	OK	OK	OK	OK	OK	OK
	450	OK	OK	OK	OK	OK	OK	OK	OK	OK	OK	OK	OK	OK	OK	OK	OK	OK	OK	OK	OK	OK	OK
	600	OK	OK	OK	OK	OK	OK	OK	OK	OK	OK	OK	OK	OK	OK	OK	OK	OK	OK	OK	OK	OK	OK
	750	OK	OK	OK	OK	OK	OK	OK	OK	OK	OK	OK	OK	OK	OK	OK	OK	OK	OK	OK	OK	OK	OK
	900	OK	OK	OK	OK	OK	OK	OK	OK	OK	OK	OK	OK	OK	OK	OK	OK	OK	OK	OK	OK	OK	OK
	1,050	OK	OK	OK	OK	OK	OK	OK	OK	OK	OK	OK	OK	OK	OK	OK	OK	OK	OK	OK	OK	OK	OK
	1,200	OK	OK	OK	OK	OK	OK	OK	OK	OK	OK	OK	OK	OK	OK	OK	OK	OK	OK	OK	OK	OK	OK
	1,350	OK	OK	OK	OK	OK	OK	OK	OK	OK	OK	OK	OK	OK	OK	OK	OK	OK	OK	OK	OK	OK	OK
	1,500	OK	OK	OK	OK	OK	OK	OK	OK	OK	OK	OK	OK	OK	OK	OK	OK	OK	OK	OK	OK	OK	OK
	1,650	OK	OK	OK	OK	OK	OK	OK	OK	OK	OK	OK	OK	OK	OK	OK	OK	OK	OK	OK	OK	OK	OK
	1,800	OK	OK	OK	OK	OK	OK	OK	OK	OK	OK	OK	OK	OK	OK	OK	OK	OK	OK	OK	OK	OK	OK
1,950	OK	OK	OK	OK	OK	OK	OK	OK	OK	OK	OK	OK	OK	OK	OK	OK	OK	OK	OK	OK	OK	OK	
2,100	OK	OK	OK	OK	OK	OK	OK	OK	OK	OK	OK	OK	OK	OK	OK	OK	OK	OK	OK	OK	OK	OK	
2,250	OK	OK	OK	OK	OK	OK	OK	OK	OK	OK	OK	OK	OK	OK	OK	OK	OK	OK	OK	OK	OK	OK	

Accessories

Receiver cables (M12-8pin, shielded, flying leads)

Shape	Description	Remark	Order code
	Sensor connector with open cable end M12-8pin, outer shielding layer	Receiver cable, 2 m length	Y92E-M12PURSH8S2M-L
		Receiver cable, 5 m length	Y92E-M12PURSH8S5M-L
		Receiver cable, 10 m length	Y92E-M12PURSH8S10M-L
		Receiver cable, 25 m length	Y92E-M12PURSH8S25M-L

Transmitter cables (M12-4pin, shielded, flying leads)

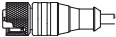

Shape	Description	Remark	Order code
	Sensor connector with open cable end M12-4pin, outer shielding layer	Transmitter cable, 2 m length	Y92E-M12PURSH4S2M-L
		Transmitter cable, 5 m length	Y92E-M12PURSH4S5M-L
		Transmitter cable, 10 m length	Y92E-M12PURSH4S10M-L
		Transmitter cable, 25 m length	Y92E-M12PURSH4S25M-L

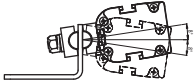
Mounting brackets

Shape	Description	Remark	Order code
	Mounting bracket	Mounting bracket × 1, SLC mounting screws × 1 set	F39-TGR-ST-SB*1
	Adjustable bracket	Adjustable bracket × 1, Bracket mounting screws × 1 set	F39-TGR-ST-ADJ

*1 Brackets amount included in shipment is shown in table of Dimensions

Master-Slave accessories

Shape	Description	Remark	Order code
	Male-male extension connector M12-8pin, outer shielding layer	Connection cable, 0.3 m length	Y92E-M12MSM12MSPURSH80.3M-L
		Connection cable, 0.9 m length	Y92E-M12MSM12MSPURSH80.9M-L (included in slave system)
	Alignment kit – end cap	To support alignment of a Master-Slave system	F39-TGR-CL-MSA (included in slave system)

Laser alignment kit

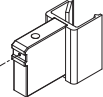
Shape	Description	Remark	Order code
	Laser alignment kit	Scanning range: ≤ 60 m Batteries: 2 × 1.5 V Micro/AAA Laser Class 2 (IEC 60825)	F39-TGR-CL-LLK

Mounting systems and mirrors

Adjustable stands

		Order code
Adjustable stand, 1,200 mm high	Safety sensors, Mirror systems	F39-TGR-AS-B1200
Adjustable stand, 1,600 mm high	Safety sensors, Mirror systems, Muting applications	F39-TGR-AS-B1600

Mirror system for multi-beam safety sensors (F3S-TGR-CL-K)

		Order code
Mirror mounting plate	2-, 3- and 4-beam systems ≤900 mm	F39-TGR-AS-MM1
	4-beam system 1,200 mm	F39-TGR-AS-MM2
Adjustable mirror kit	Use 1 pcs F39-TGR-AS-AM1 for each beam of the safety sensor	F39-TGR-AS-AM1

Muting accessories

		Order code
Mounting system for muting sensors	For L-muting	F39-TGR-AS-MA-MBL
	For X- and T-muting	F39-TGR-AS-MA-MBXT
Mounting bracket for muting sensors	For OMRON E3Z and E3G-family	F39-TGR-AS-MA-MSM
Mounting bracket for reflectors	For OMRON E39-R1S	F39-TGR-AS-MA-MRM

Cable cover

		Order code
Cable cover	For 1,200 mm stand	F39-TGR-AS-MA-CC12
	For 1,600 mm stand	F39-TGR-AS-MA-CC16

Specifications

Multi-beam safety sensors

Item	F3S-TGR-CL2_-0__	F3S-TGR-CL4_-0__
Sensor type	Type 2	Type 4
Protective height	500 mm, 800 mm, 900 mm or 1,200 mm	
Operating range	F3S-TGR-CL__-K__ 0.5 to 20 m or 20 to 40 m (Dip switch option) F3S-TGR-CL__-K_-__-LD 25 to 50 m F3S-TGR-CL__-K2C-500 0.5 to 12 m F3S-TGR-CL__-K3C-800 0.5 to 8 m F3S-TGR-CL__-K4C-__ 0.5 to 7 m	
Beam pitch	F3S-TGR-CL__-K2_-500: 2 beams, 500 mm F3S-TGR-CL__-K3_-800: 3 beams, 400 mm F3S-TGR-CL__-K4_-900: 4 beams, 300 mm F3S-TGR-CL__-K4_-1200: 4 beams, 400 mm	
Effective aperture angle (EAA)	Within ±5°	Within ±2.5°
	for the emitter and receiver at a detection distance of at least 3 m according to IEC 61496-2	
Light source	Infrared LED (880 nm), power dissipation <3 mW, Class 1 per EN 60825-1	
Supply voltage	24 VDC±20%, according EN 60204-1 able to cover a drop of voltage of at least 20 ms	
OSSD	2 PNP transistor outputs, load current 2 × 250 mA max	
Test functions	Self test (after power ON and during operation)	
Safety-related functions	All models with dip-switch setup for external device monitoring, interlock function, range setting (short and long range) and optical or wired sync. Advanced models with selectable pre-reset function, T-, L-or X- muting function (timeout or infinite muting dip switch option) and muting lamp integrated (only for the non master-slave systems)	
Response time	ON to OFF: Maximum: 13 ms	
Ambient temperature	Operating: -10 to 55°C, Storage: -25 to 70°C (no icing, no condensation)	
Ambient humidity	95% not condensing	
Degree of protection	IP 65 (IEC 60529)	
Materials	Housing: Painted aluminum, Yellow, RAL 1018 Front Window: Acrylic Lexan Red end cap: PA6 (Standalone models), Transparent end cap: PC (Advanced standalone models), Sealing Gasket: EPDM Mounting Bracket: Cold rolled Steel	
Suitable for safety control systems	PLc (ISO 13849-1)	PLe (ISO 13849-1)
Category	Categorie 2	Categorie 4
PFHd	2,5 × 10 ⁻⁹	
Proof test interval	every 20 years	

Finger- and hand safety protection sensors

Item	F3S-TGR-CL2_-0__	F3S-TGR-CL4_-0__
Sensor type	Type 2	Type 4
Protective height	150 mm to 2,400 mm	
Operating range (short setting or long setting)	F3S-TGR-CL__-014: 0.2 m to 3 m or 3 m to 6 m (Dip switch option) F3S-TGR-CL__-035: 0.2 m to 7 m or 7 m to 14 m (Dip switch option) F3S-TGR-CL__-070: 0,2 m to 7 m or 7 m to 14 m (Dip switch option)	
Detection capability	F3S-TGR-CL__-014: Opaque objects 14 mm in diameter F3S-TGR-CL__-035: Opaque objects 35 mm in diameter F3S-TGR-CL__-070: Opaque objects 70 mm in diameter	
Effective aperture angle (EAA)	Within ±5°	Within ±2.5°
	for the emitter and receiver at a detection distance of at least 3 m according to IEC 61496-2	
Light source	Infrared LED (880 nm), power dissipation <3 mW, Class 1 per EN 60825-1	
Supply voltage	24 VDC±20%, according EN 60204-1 able to cover a drop of voltage of at least 20 ms	
OSSD	2 PNP transistor outputs, load current 2 × 250 mA max	
Series connection	Number of connections: One master and one slave safety light curtain Total number of beams ≤ 336 Maximum interconnect cable length: 900 mm	
Test functions	Self test (after power ON and during operation)	
Safety-related functions	All models with dip-switch setup for external device monitoring, interlock function, range setting (short and long range) and optical or wired sync. Advanced models with selectable pre-reset function, T-, L-or X- muting function (timeout muting), blanking, single / double brake function and muting lamp integrated (only for the non master-slave systems)	
Response time	ON to OFF: 14 ms to 103 ms	
Ambient temperature	Operating: -10 to 55°C, Storage: -25 to 70°C (no icing, no condensation)	
Ambient humidity	95% not condensing	
Degree of protection	IP 65 (IEC 60529)	
Materials	Housing: Painted aluminum, Yellow, RAL 1018 Front Window: Acrylic Lexan Red end cap: PA6 (Standalone models), Transparent end cap: PC (Advanced standalone models), Die cast aluminum (Master-, Slave models) Sealing Gasket: EPDM Mounting Bracket: Cold rolled Steel	
Suitable for safety control systems	PLc (ISO 13849-1)	PLe (ISO 13849-1)
Category	Categorie 2	Categorie 4
PFHd	2,5 × 10 ⁻⁹	
Proof test interval	every 20 years	

F3S-TGR-CL and GSB-301-D in manual reset

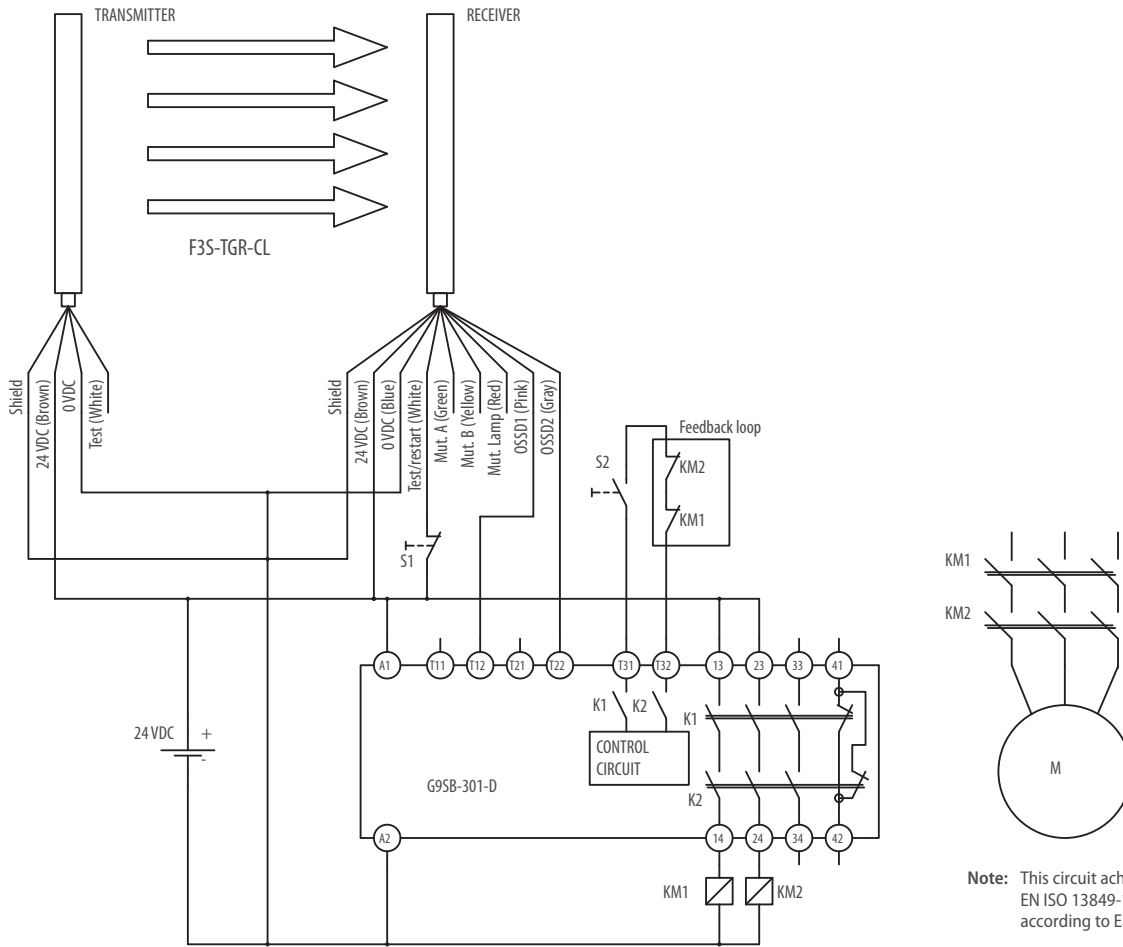



Muting actuators

The F39-TGR-MCL- _ muting actuators are plug-and-play accessories for the F3S-TGR-CL Safety Sensors. Easy wiring of the entire muting system is provided by connection boxes managing all connections needed.

- Active/active and active/passive systems supported
- T- and L- shape muting by using same parts
- Selectable muting sensor sequence
- Pre-installed mounting brackets
- Pre-wired connection cables
- Supporting Type 2 and Type 4 applications

Ordering information

Muting actuators (mounting brackets are included)

		Order code
Transmitter + Receiver set	active/active	F39-TGR-MCL
Receiver only	active/active	F39-TGR-MCL-D
Transmitter only	active/active	F39-TGR-MCL-L
Transceiver + Reflector set	active/passive	F39-TGR-MCL-R
Transceiver only	active/passive	F39-TGR-MCL-R-A
Reflector only	active/passive	F39-TGR-MCL-R-P

Connection boxes

	Order code
Connection box for Receivers and Transceivers	F39-TGR-MCL-CMD
Connection box for Transmitters	F39-TGR-MCL-CML

Mounting brackets

	Order code
Mounting bracket for one muting actuator	F39-TGR-MCL-ST

Specifications

Power supply	24 VDC±20%	
Consumption	5 W max (F39-TGR-MCL- _ only)	
Ambient temperature	During operation; -10 to + 55°C (with no dew condensation)	
Cable connector	Length	30 cm pre-wired
	RX	M12 5-pin female
	TX	M12 5-pin female
Degree of protection	IP65	
Distance between muting beams	250mm	
F39-TGR-MCL	Optical data	Through-beam system
	Operating distance	0 ... 7 m; max. 0 ... 8,4 m
	Light source	Red emitting LEDs, Wavelength 630 nm
F39-TGR-MCL-R	Optical data	Polarized retro-reflective system
	Operating distance	0 ... 4 m; max. 0 ... 4,8 m
	Light source	Red emitting LEDs, Wavelength 660 nm

Configuration examples

L-muting, active/active

- 1) Safety sensor (e.g. F3S-TGR-CL4A-K2-500)
- 2) Muting actuators F39-TGR-MCL
- 3) Connector box F39-TGR-MCL-CML
- 4) Connector box F39-TGR-MCL-CMD



L-muting, active/passive

- 1) Safety Sensor (e.g. F3S-TGR-CL4A-K2C-500)
- 2) Muting actuators F39-TGR-MCL-R
- 3) Connection box F39-TGR-MCL-CMD

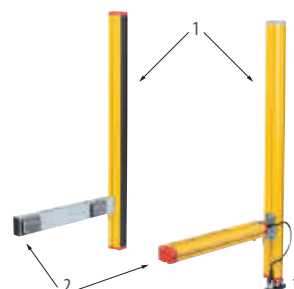



Single-beam safety sensor in compact housing

The slender M18-sized E3FS is a type 2 safety single beam with an operating range of up to 10 m. Plastic and metal housing, cable and M12-connector offer flexibility in application together with a control unit such as F3SP-U3P or F3SP-U5P.

- Sensing distance up to 10 m
- LEDs for easy alignment and diagnosis
- Cable and M12 plug categories
- Plastic and metal housing
- Type 2 sensor complying with EN 61496-1

Ordering information

Safety single beam sensors (Type 2)

Case material	Operation distance	Order code	
Plastic	0 to 10 m	Cable type	E3FS-10B4
		Plug type	E3FS-10B4-P1
Nickel brass		Cable type	E3FS-10B4-M
		Plug type	E3FS-10B4-M1-M

Controller for safety single beam sensors

Sensors	Output contacts	Width	Order code
1 to 2 Safety single beam sensors	2 NO 2.5 A	22.5 mm	F3SP-U3P-TGR
1 to 4 Safety single beam sensors		45 mm	F3SP-U5P-TGR

Specifications

Sensors

Sensing method	Through-beam
Controller	F3SP-U3P-TGR, F3SP-U5P-TGR
Supply voltage (Vs)	24 VDC \pm 10% (ripple p-p 10% max.)
Effective aperture angle (EAA)	\pm 5° (at 3 m)
Current consumption	Emitter: 50 mA max. Receiver: 25 mA max.
Sensing distance	10 m
Standard sensing object	Opaque object: 11 mm min. in diameter
Response time	2.0 ms (E3FS only)
Control output	PNP transistor output, load current: 100 mA max.
Test input (emitter)	21.5 to 24 VDC: Emitter OFF (source current: 3 mA max.) Open or 0 to 2.5 V: Emitter ON (leakage current: 0.1 mA max.)
Ambient light intensity	Incandescent lamp: 3,000 lx max. (light intensity on the receiver surface) Sunlight: 10,000 lx max. (light intensity on the receiver surface)
Ambient temperature	Operating: -20°C +55°C, storage: -30°C +70°C (with no icing or condensation)
Degree of protection	IP67 (IEC 60529)
Light source	Infrared LED
Protection	Output short-circuit protection, reverse polarity protection

Controllers

Item	F3SP-U3P	F3SP-U5P
Number of sensors	1 to 2 safety single beam sensor	1 to 4 safety single beam sensor
Width	22.5 mm	45 mm
Muting input	2 Inputs	4 Inputs
Safety related function	Override function Muting lamp connection Interlock system (automatic and manual reset)	
Power supply voltage	24 VDC \pm 10%	
Power consumption	420 mA max.	
Output contacts	2 NO 2.5 A (protected by fuse), 115 VAC max.	2 NO 2.5 A (protected by fuse), 250 VAC max.
Indicators	6 LED for status and diagnostics	
Degree of protection	IP20 (IEC 60529)	
Terminal	16 screw terminals, detachable blocks with '4pin'	32 screw terminals, detachable blocks with '4pin'
Response time	\leq 30 ms	
Ambient temperature	Operation: -10°C +55°C	
Housing material	Plastic; DIN rail mounting	



OS32C Safety laser scanner

- Type 3 safety laser scanner complies with IEC61496-1/-3
- 70 sets of safety zone and warning zone combinations are available, supporting complicated changes in working environments
- A safety radius up to 4 m and warning zone(s) radius up to 10 m can be set
- 8 Individual sector indicators and various LED indications allow the user to determine scanner status at a glance
- Reference boundary monitoring function prevents unauthorized changes in the scanner position
- Configurable minimum object resolution of 30, 40, 50 or 70 mm, for hand and arm detection applications

Ordering information

Description	Max. operating range	Order code
OS32C with back location cable entry	3 m	OS32C-BP
	4 m	OS32C-BP-4M
OS32C with side location cable entry ^{*1}	3 m	OS32C-SP1
	4 m	OS32C-SP1-4M
OS32C with back location cable entry EtherNet/IP capable for status measurement data reporting	3 m	OS32C-BP-DM
	4 m	OS32C-BP-DM-4M
OS32C with side location cable entry ^{*1} EtherNet/IP capable for status measurement data reporting	3 m	OS32C-SP1-DM
	4 m	OS32C-SP1-DM-4M

^{*1} Each connector is located on the left as viewed from the back of the I/O block.

Description	Remarks	Order code
Configuration tool	CD-ROM OS supported: Windows 2000, XP, Vista, Windows 7	included

Specifications

Sensors

Sensor type	Type 3 safety laser scanner
Safety category	Category 3, performance level d (ISO13849-1: 2006)
Detection capability	Configurable; Non-transparent with a diameter of 30, 40, 50 or 70 mm (1.8% reflectivity or greater)
Monitoring zone	Monitoring zone set count: (Safety zone + 2 warning zones) × 70 sets
Operating range	Safety Zone: 4.0 m (min. obj. resolution of 70mm, only OS32C-_-4M types) 3.0 m (min. obj. resolution of 50 mm or 70 mm) 2.5 m (min. obj. resolution of 40 mm) 1.75 m (min. obj. resolution of 30 mm) Warning Zone: 10.0 m (15.0 m for OS32C-_-4M types)
Detection angle	270°
Response time	Response time from ON to OFF: From 80 ms (2 scans) to 680 ms (up to 17 scans) ^{*1} Response time from OFF to ON: Response time from ON to OFF + 100 ms to 60 s (configurable)
Line voltage	24 VDC +25%/−30% (ripple p-p 2.5 V max.)
Power consumption	Normal operation: 5 W max., 4 W typical (without output load) ^{*2} Standby mode: 3.75 W (without output load)
Safety output (OSSD)	PNP transistor × 2, load current of 250mA max., residual voltage of 2 V max., load capacity of 2.2 μf max., leak current of 1 mA max. ^{*2,*3,*4}
Auxiliary output (Non-safety)	NPN/PNP transistor × 1, load current of 100 mA max., residual voltage of 2 V max., leak current of 1 mA max. ^{*3,*4,*5}
Warning output (Non-safety)	NPN/PNP transistor × 1, load current of 100 mA max., residual voltage of 2 V max., leak current of 1 mA max. ^{*3,*4,*5}
Output operation mode	Auto start, start interlock, start/restart interlock
Input	External Device Monitoring (EDM) ON: 0 V short (input current of 50 mA), OFF: Open
	Start ON: 0 V short (input current of 20 mA), OFF: Open
	Zone select ON: 24 V short (input current of 5 mA), OFF: Open
	Stand-by ON: 24 V short (input current of 5 mA), OFF: Open
Connection type	Power cable: 18-pin mini-connector (pigtail) Communication cable: M12, 4-pin connector
Connection with PC	Communication: EtherNet/IP
Indicators	RUN indicator: Green, STOP indicator: Red, Interlock indicator: Yellow, Warning output indicator: Orange, Status/diagnostic display: 2 × 7-segment LEDs, Intrusion indicators: Red LED × 8
Enclosure rating	IP65 (IEC60529)
Dimensions (W × H × D)	133.0 × 104.5 × 142.7 mm (except cable)
Weight (Main Unit only)	1.3 kg
Approvals	Certified by: TÜV Rheinland, UL Major standards: IEC61496-1/-3 (Type 3), IEC61508 (SIL2), ISO13849-1:2008 (Category 3, performance level d), UL508, UL1998

^{*1} Pollution Tolerance will add 6 ms to each scan time.

^{*2} Rated current of OS32C is 1.025 A max. (OS32C 210 mA + OSSD A load + OSSD B load + auxiliary output load + warning output load + functional inputs). Where functional inputs are: EDM input ... 50 mA, Start input ... 20 mA, Standby input ... 5 mA, Zone X input ... 5 mA × 8 (eight zone set select inputs).

^{*3} Output voltage is input voltage − 2.0 VDC.

^{*4} Total consumption current of 2 OSSDs, auxiliary output, and warning output must not exceed 700 mA.

^{*5} Output polarity (NPN/PNP) is configurable via the configuration tool.

Accessories (sold separately)

Power cable







Appearance	Description	Remarks	Order code
	Cable length: 3 m	One cable is required per sensor	OS32C-CBL-03M
	Cable length: 10 m		OS32C-CBL-10M
	Cable length: 20 m		OS32C-CBL-20M
	Cable length: 30 m		OS32C-CBL-30M

Ethernet cable

Appearance	Description	Remarks	Order code
	Cable length: 2 m	Required for configuration and monitoring	OS32C-ECBL-02M
	Cable length: 5 m		OS32C-ECBL-05M
	Cable length: 15 m		OS32C-ECBL-15M





Note: An ethernet cable with an M12, 4-pin connector is required.

Mounting brackets

Appearance	Description	Remarks	Order code
	Bottom/side mounting bracket	Bottom/side mounting bracket × 1, unit mounting screws × 4 sets	OS32C-BKT1
	XY axis rotation mounting bracket	XY axis rotation mounting bracket × 1, unit mounting screws × 6 sets, bracket mounting screws × 1 set (must be used with OS32C-BKT1)	OS32C-BKT2
	Simple mounting bracket	Simple mounting brackets × 2, unit mounting screws × 4 sets ^{*1}	OS32C-BKT3
	Protective cover for window		OS32C-BKT4
	Mounting stand	When using a mounting stand, use an OS32C with side location cable entry (OS32C-SP1). The OS32C with back location cable entry (OS32C-BP) cannot be mounted. Use with mounting brackets (OS32C-BKT1 and OS32C-BKT2).	OS32C-MT
	Hardware kit for mounting stand	Mounting screws × 3 sets Use this when mounting a bracket to the mounting stand.	OS32C-HDT

*1 There are eight OS32C mounting screws: four screws for singular use, and four screws for protective cover for window.

Miscellaneous

Appearance	Description	Remarks	Order code
	Scan window	Spare for replacement	OS32C-WIN-KT
	Sensor block without I/O block Max. operating range: 3 m	Spare for replacement	OS32C-SN
	Sensor block without I/O block Max. operating range: 4 m		OS32C-SN-4M
	Sensor block without I/O block for EtherNet/IP Max. operating range: 3 m	Spare replacement for EtherNet/IP	OS32C-SN-DM
	Sensor block without I/O block for EtherNet/IP Max. operating range: 4 m		OS32C-SN-DM-4M
	I/O block	With cable access from the back	OS32C-CBBP
		With cable access from the left side	OS32C-CBSP1
	Window cleaning kit, anti-static cleaner	Accessory	WIN-CLN-KT

Connection

Basic connection with single OS32C unit
Category 3, performance level d (ISO13849-1)

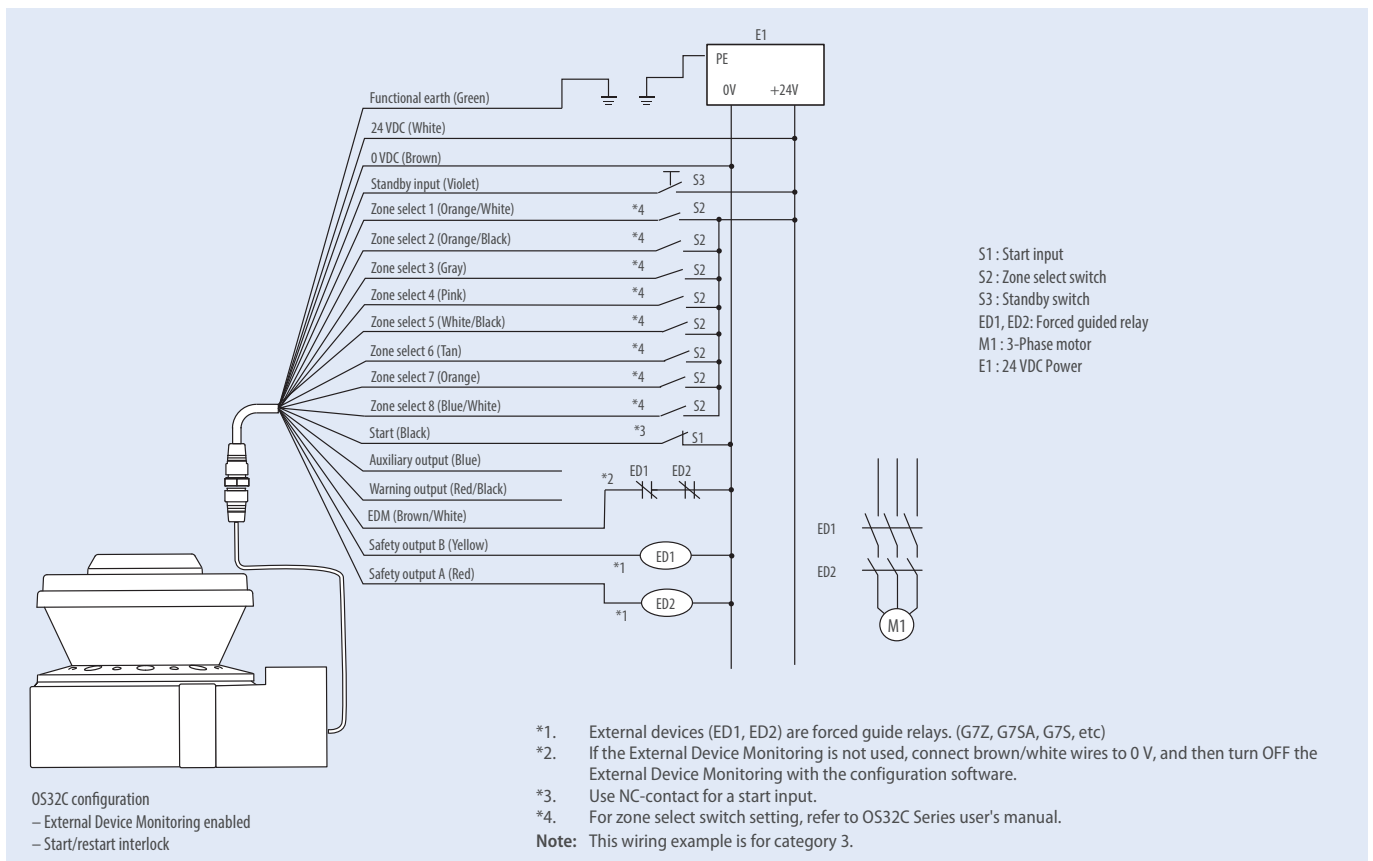

BREAK THROUGH BARRIERS IN SAFETY DESIGN

Configurable, flexible and simple



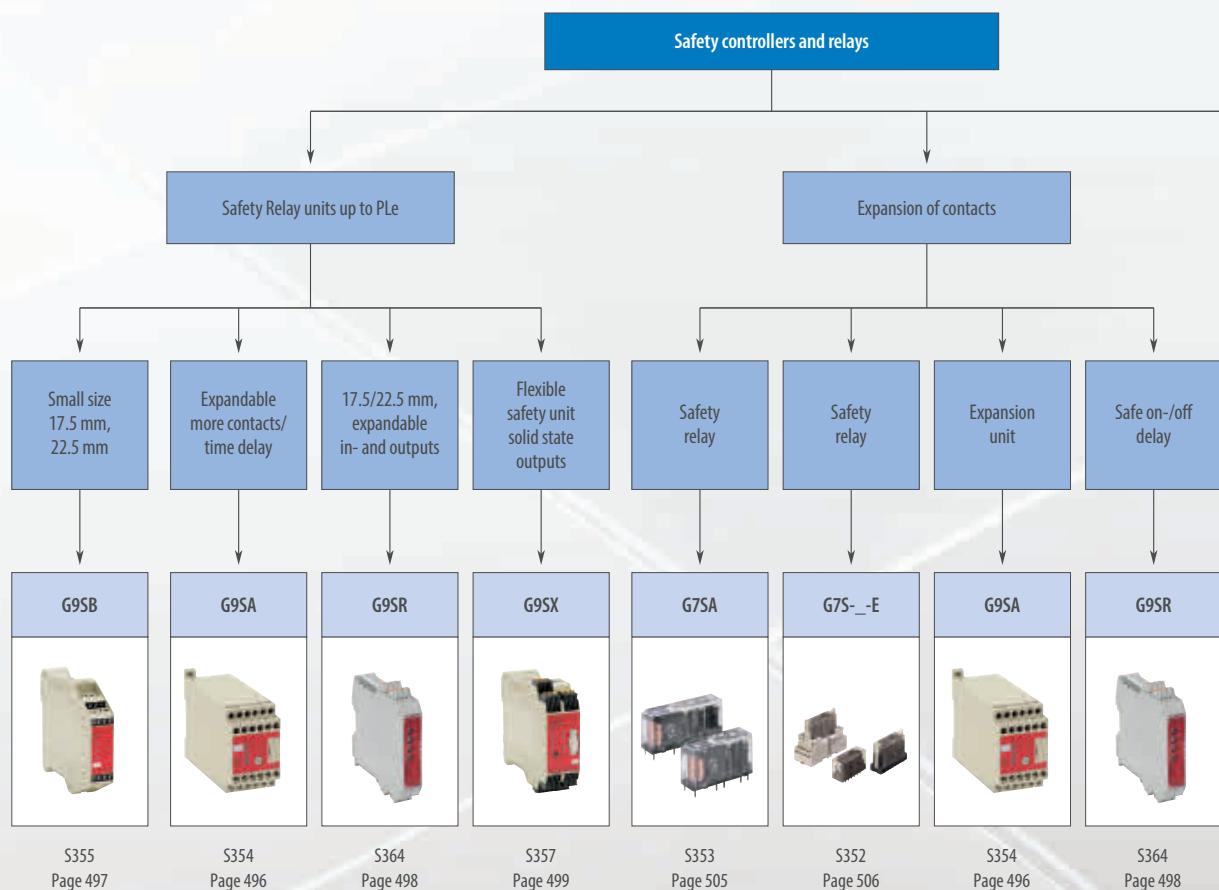

Omron safety controllers offer transparent standalone operation and scalability in safety networking applications for all sizes of machine safety control systems. The G9SP safety controller is simple to configure and setup and overcomes limitations of hard-wired solutions by adding flexibility of a software - based solution. Total cost of ownership is reduced by having user-defined function blocks and an integrated simulation tool for debugging or the application program.

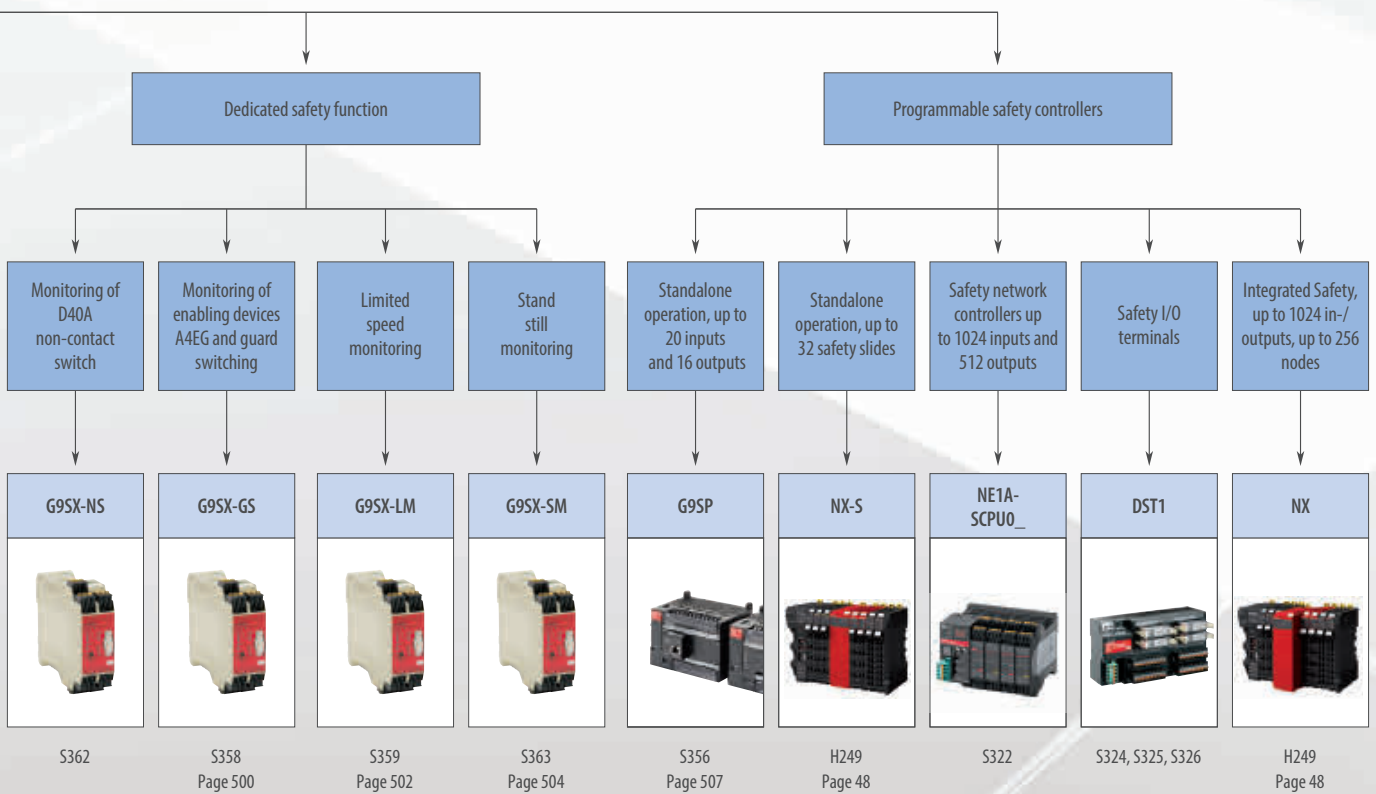



- EN ISO 13849-1 (PLe) and IEC 61508 (SIL3) certification for future-proof design of the safety system
- Predefined function blocks for simple configuration and self-explanatory validation
- Equipped with Ethernet and serial interface for transparent diagnosis





Selection table

		Safety relay units		Safety relays	Flexible safety unit	
						
Model		G9SA	G9SB	G9SR	G9SX	
Selection criteria	Performance level	up to PLe acc. EN ISO 13849-1 depending on application				
	Safety integrity level (IEC 61508)	–	–	SIL 3	SIL 3	
	Reaction time	max. 10 ms	max. 10 ms	depend on safety application	15 ms	
	DeviceNet safety Bus interface	–	–	–	–	
	Standard DeviceNet Bus interface	–	–	–	–	
	EDM function	■	■	■	■	
	Interlock function	■	■	■	■	
	Logical 'AND' connection	–	–	■	■	
	Relay expansion units	■	–	–	■	
	Housing	Plastic	Plastic	Plastic	Plastic	
	Operating temperature	–25 to 55°C	–25 to 55°C	–10 to 55°C	–10 to 55°C	
	Flux-tight	–	–	–	–	
Features	Number of poles	–	–	–	–	
	Gold clad contacts	–	–	–	–	
	Relay socket	–	–	–	–	
	Detachable cage clamp terminals	–	–	■	■	
	Screw terminals	■	■	optional	■	
	Safe timing functions	■	–	on-delay and off-delay	■	
	USB-interface	–	–	–	–	
	Programming software	–	–	–	–	
	Application	E-Stop application	■	■	■	■
		Door switch monitoring	■	■	■	■
		Safety light curtain monitoring	■	■	■	■
		EDM monitoring	■	■	■	■
Interlock function		■	■	■	■	
Logic function blocks		–	–	■	–	
Safe ON delay timer		–	–	■	–	
Safe OFF delay timer		■	–	■	■	
Two-Hand control		■	–	■	–	
Manual/automatic reset		■	■	■	■	
Non-contact switches monitoring		–	–	■	■	
Guard switching/enabling function		–	–	■	■	
limited speed monitoring		–	–	–	■	
standstill monitoring		–	–	–	■	
General safety application	■	■	■	■		
Supply voltage	24 VDC	■	■	■	■	
	100 VAC to 240 VAC	■	–	–	–	
In- and outputs	Safety inputs	■	■	■	■	
	Test signal output	–	–	■	■	
	Solid state safety outputs	–	–	■	■	
	Safety relay outputs	3PST-NO, 5PST-NO	DPST-NO, 3PST-NO	DPST-NO, 3PST-NO	■	
	Auxiliary outputs	SPST-NC	SPST-NC	Solid state, SPST-NO	■	
	4PST-NO + DPST-NC	–	–	–	–	
	3PST-NO + 3PST-NC	–	–	–	–	
	3PST-NO + SPST-NC	–	–	–	–	
	DPST-NO + DPST-NC	–	–	–	–	
5PST-NO + SPST-NC	–	–	–	–		
Page/Quick Link	496	497	498	499		

		Safety relays		Programmable safety system			
							
Model		G7SA	G7S- _E	G9SP	NE1A-SCPU0_	DST1	
Selection criteria	Performance level	–	–	up to PLe acc. EN ISO 13849-1 depending on application			
	Safety integrity level (IEC 61508)	–	–	SIL 3			
	Reaction time	–	–	dependent on safety application program			
	DeviceNet safety Bus interface	–	–	–	■	■	
	Standard DeviceNet Bus interface	–	–	Diagnosis via Ethernet and Serial interface (option)	■	■	
	EDM function	–	–	■	■	■	
	Interlock function	–	–	■	■	■	
	Logical 'AND' connection	–	–	–	–	–	
	Relay expansion units	–	–	–	–	–	
	Housing	Plastic	Plastic	Plastic	Plastic	Plastic	
	Operating temperature	–40 to 85°C	–25 to 70°C	–10 to 55°C	–10 to 55°C	–10 to 55°C	
Features	Flux-tight	■	■	–	–	–	
	Number of poles	4 pole and 6 pole	6 pole	–	–	–	
	Gold clad contacts	■	–	–	–	–	
	Relay socket	■	■	–	–	–	
	Detachable cage clamp terminals	–	–	–	■	■	
	Screw terminals	–	–	■	–	–	
	Safe timing functions	–	–	■	■	■	
	USB-interface	–	–	■	■	–	
	Programming software	–	–	■	■	–	
	Application	E-Stop application	–	–	■	■	■
		Door switch monitoring	–	–	■	■	■
Safety light curtain monitoring		–	–	■	■	■	
EDM monitoring		–	–	■	■	■	
Interlock function		–	–	■	■	■	
Logic function blocks		–	–	■	■	■	
Safe ON delay timer		–	–	■	■	■	
Safe OFF delay timer		–	–	■	■	■	
Two-Hand control		–	–	■	■	■	
Manual/automatic reset		–	–	■	■	■	
Non-contact switches monitoring		–	–	■	■	■	
Guard switching/enabling function		–	–	■	■	■	
limited speed monitoring		–	–	–	–	■	
standstill monitoring	–	–	–	–	■		
General safety application	■	■	■	■	■		
Supply voltage	24 VDC	■	■	■	■	■	
	100 VAC to 240 VAC	–	–	–	–	–	
In- and outputs	Safety inputs	–	–	■	■	■	
	Test signal output	–	–	■	■	■	
	Solid state safety outputs	–	–	■	■	■	
	Safety relay outputs	–	–	–	–	■	
	Auxiliary outputs	–	–	■	■	■	
	4PST-NO + DPST-NC	■	■	–	–	–	
	3PST-NO + 3PST-NC	■	■	–	–	–	
	3PST-NO + SPST-NC	■	–	–	–	–	
	DPST-NO + DPST-NC	■	–	–	–	–	
5PST-NO + SPST-NC	■	–	–	–	–		
Page/Quick Link	505	506	507	S322	S324, S325, S326		

■ Standard

– No/not available



Expandable safety relay unit

G9SA-family offers a complete line-up of compact and expandable safety relay units. Modules with safe OFF-delay timing are available as well as a two-hand controller. Simple multiplication of safety contacts is possible by using the connection on the front.

- 45 mm-wide housing, expansion units are 17.5 mm wide
- Safe OFF-delay timer
- Simple expansion connection
- Certification up to PLe according to EN ISO 13849-1 depending on the application

Ordering information

Emergency-stop units

Main contacts	Auxiliary contact	Number of input channels	Rated voltage	Order code
3PST-NO	SPST-NC	1 channel or 2 channels possible	24 VAC/VDC 100 to 240 VAC	G9SA-301
5PST-NO	SPST-NC	1 channel or 2 channels possible	24 VAC/VDC 100 to 240 VAC	G9SA-501

Emergency-stop OFF-delay units

Main contacts	OFF-delay contacts	Auxiliary contact	Number of input channels	OFF-delay time	Rated voltage	Order code
3PST-NO	DPST-NO	SPST-NC	1 channel or 2 channels possible	7.5 s	24 VAC/VDC 100 to 240 VAC	G9SA-321-T075
				15 s	24 VAC/VDC 100 to 240 VAC	G9SA-321-T15
				30 s	24 VAC/VDC 100 to 240 VAC	G9SA-321-T30

Two-hand controller

Main contacts	Auxiliary contact	Number of input channels	Rated voltage	Order code
3PST-NO	SPST-NC	2 channels	24 VAC/VDC 100 to 240 VAC	G9SA-TH301

Expansion unit

The expansion unit connects to a G9SA-301, G9SA-501, G9SA-321, or G9SA-TH301.

Main contacts	Auxiliary contact	Category	Order code
3PST-NO	SPST-NC	4	G9SA-EX301

Expansion units with OFF-delay outputs

The expansion unit connects to a G9SA-301, G9SA-501, G9SA-321, or G9SA-TH301.

Main contact form	Auxiliary contact	OFF-delay time	Order code
3PST-NO	SPST-NC	7.5 s	G9SA-EX031-T075
		15 s	G9SA-EX031-T15
		30 s	G9SA-EX031-T30

Specifications

Power input

Item	G9SA-301/TH301 / G9SA-501 / G9SA-321-T_
Power supply voltage	24 VAC/VDC: 24 VAC, 50/60 Hz, or 24 VDC 100 to 240 VAC: 100 to 240 VAC, 50/60 Hz
Operating voltage range	85 to 110% of rated power supply voltage

Inputs

Item	G9SA-301/321-T_/TH301	G9SA-501
Input current	40 mA max.	60 mA max.

Contacts

Item	G9SA-301/501/321-T_/TH301/EX301/EX031-T_
	Resistive load (cosφ= 1)
Rated load	250 VAC, 5 A
Rated carry current	5 A

Characteristics

Item	G9SA-301/TH301 / G9SA-501/321-T_ / G9SA-EX301/EX031-T_	
Operating time	30 ms max. (not including bounce time)	
Response time ^{*1}	10 ms max. (not including bounce time)	
Durability	Mechanical	5,000,000 operations min. (at approx. 7,200 operations/hr)
	Electrical	100,000 operations min. (at approx. 1,800 operations/hr)
Minimum permissible load (reference value)	5 VDC, 1 mA	
Ambient temperature	Operating: -25 to 55°C (with no icing or condensation) Storage: -25 to 85°C (with no icing or condensation)	

*1 The response time is the time it takes for the main contact to open after the input is turned OFF.



Slim-size safety unit

G9SB is a family of slender safety relay units, providing two safety contacts in a 17.5 mm- and three safety contacts in a 22.5mm-wide housing.

- 17.5 mm- and 22.5 mm-wide housing
- 1- and 2-input channel units
- Manual and automatic reset units
- Certification up to PLe according to EN ISO 13849-1 depending on the application

Ordering information

Main contacts	Auxiliary contact	Number of input channels	Reset mode	Input type	Rated voltage	Size (H×W×D)	Order code
DPST-NO 2 safety contacts	None	2 channels	Auto-reset	Inverse	24 VAC/VDC	100 mm × 17.5 mm × 112 mm	G9SB-2002-A
		1 channel or 2 channels		+ common			G9SB-200-B
		2 channels	Manual-reset	Inverse			G9SB-2002-C
		1 channel or 2 channels		+ common			G9SB-200-D
3PST-NO 3 safety contacts	SPST-NC	None (direct breaking)	Auto-reset	–	24 VDC	100 mm × 17.5 mm × 112 mm	G9SB-3010
		2 channels		Inverse	24 VAC/VDC	100 mm × 22.5 mm × 112 mm	G9SB-3012-A
		1 channel or 2 channels					+ common
		2 channels	Manual-reset	Inverse	24 VAC/VDC	100 mm × 22.5 mm × 112 mm	G9SB-3012-C
		1 channel or 2 channels					+ common

Specifications

Power input

Item	G9SB-200 _ _	G9SB-3010	G9SB-301 _ _
Power supply voltage	24 VAC/VDC: 24 VAC, 50/60 Hz, or 24VDC 24 VDC: 24 VDC		
Operating voltage range	85 to 110% of rated power supply voltage		
Power consumption	1.4 VA/1.4 W max.	1.7 W max.	1.7 VA/1.7 W max.

Inputs

Item	G9SB-200 _ _	G9SB-3010	G9SB-301 _ _
Input current	25 mA max.	60 mA max. (See note.)	30 mA max.

Note: Indicates the current between terminals A1 and A2.

Contacts

Item	G9SB-200 _ _	G9SB-3010	G9SB-301 _ _
	Resistive load (cosφ= 1)		
Rated load	250 VAC, 5 A		
Rated carry current	5 A		

Characteristics

Item	G9SB-200 _ _	G9SB-3010	G9SB-301 _ _
Response time *1	10 ms max.		
Durability	Mechanical	5,000,000 operations min. (at approx. 7,200 operations/hr)	
	Electrical	100,000 operations min. (at approx. 1,800 operations/hr)	
Minimum permissible load (reference value)	5 VDC, 1 mA		
Ambient operating temperature	–25°C +55°C (with no icing or condensation)		

*1 The response time is the time it takes for the main contact to open after the input is turned OFF.



Compact safety relay unit family

G9SR family modules operate standalone and as a system with input and output extension. All modules are simple to set up using DIP-switches and provide clear diagnosis via LEDs on the front.

- Three modules for all safety relay unit applications
- Solid-state outputs for long life and high current safety relay outputs
- Detailed LED indications enable easy diagnosis
- Safe on- and off-delay function up to PLe
- Up to PLe according to EN ISO 13949-1 and SIL 3 according to EN 61508

Ordering information

Advanced unit

Safety outputs	Auxiliary outputs	No. of input channels	Rated voltage	Terminal block type	Order code
Instantaneous					
2 PST-NO (contact)	1 PNP transistor outputs	1 or 2 channels	24 VDC	removable cage clamp terminals	G9SR-AD201-RC

Basic unit

Safety outputs	Auxiliary outputs	No. of input channels	Rated voltage	Terminal block type	Order code
Instantaneous					
2 P channel MOS FET transistor output	1 PNP transistor output	1 or 2 channels	24 VDC	removable cage clamp terminals	G9SR-BC201-RC

Expansion unit

Safety outputs	Auxiliary outputs	Rated voltage	Terminal block type	Order code	
Instantaneous	ON/OFF-delayed				
–	3 PST-NO (contact) ^{*1}	1 (solid state) PNP transistor outputs	24 VDC	removable cage clamp terminals	G9SR-EX031-T90-RC

^{*1} The ON/OFF delay time can be set in 16 steps as follows: 0/0.1/0.2/0.5/1/1.5/2/2.5/5/10/20/30/45/60/75/90 s

Specifications

Power input

Item	G9SR-AD_	G9SR-BC_	G9SR-EX_
Rated supply voltage	19.2 to 28.8 VDC (24 VDC ±20%)		

Inputs

Item	G9SR-AD_	G9SR-BC_	G9SR-EX_
Safety input	Operating voltage: 19.2 VDC to 28.8 VDC, internal impedance: Approx. 3 kΩ		
Feedback/reset input			

Outputs

Item	G9SR-BC_	G9SR-AD_	G9SR-EX_
Instantaneous safety output	P channel MOS FET transistor output Load current (Using 2 outputs): 2 A DC max.	–	
Auxiliary output	PNP transistor output Load current: 500 mA max.		
Rated load	–	250 VAC, 5 A AC15 (inductive load)	
Rated carry current	–	5 A	
Maximum switching voltage	–	250 VAC	

Characteristics

Item	G9SR-BC_	G9SR-AD_	G9SR-EX_
Operating time (OFF to ON)	150 ms max.		
Response time (ON to OFF)	50 ms max.		
Durability	Electrical	–	
	Mechanical	–	
Ambient temperature	–10 to 55°C (with no icing or condensation)		



Flexible safety unit

G9SX-family modules can be connected by a logical “AND” function to implement partial/global stopping of a machine. Solid-state outputs, detailed LED diagnosis and clever feedback signals help to keep maintenance easy. The line-up is completed by expansion units with safe timing functions.

- Clear and transparent segmentation of safety functions by use of unique “AND” connection
- Solid-state outputs for long life and relay outputs in extension box available
- Detailed LED indications enable easy diagnosis
- Clever feedback signals for easy maintenance
- PLe according to EN ISO 13849-1 and SIL 3 according to EN 61508

Ordering information

Advanced unit

Safety outputs		Auxiliary outputs	No. of input channels	Max. OFF-delay time ^{*1}	Rated voltage	Terminal block type	Order code
Instantaneous	OFF-delayed						
3 P channel MOS-FET transistor output	2 P channel MOS-FET transistor output	2 PNP transistor outputs	1 or 2 channels	0 to 15 sec in 16 steps	24 VDC	Screw terminals	G9SX-AD322-T15-RT
						Cage clamp terminals	G9SX-AD322-T15-RC
2 P channel MOS-FET transistor output	2 P channel MOS-FET transistor output	2 PNP transistor outputs	1 or 2 channels	0 to 150 sec in 16 steps	24 VDC	Screw terminals	G9SX-AD-322-T150-RT
						Cage clamp terminals	G9SX-AD-322-T150-RC
				0 to 15 sec in 16 steps	24 VDC	Screw terminals	G9SX-ADA-222-T15-RT
						Cage clamp terminals	G9SX-ADA-222-T15-RC
				0 to 150 sec in 16 steps	24 VDC	Screw terminals	G9SX-ADA-222-T150-RT
						Cage clamp terminals	G9SX-ADA-222-T150-RC

*1 The OFF-delay time can be set in 16 steps as follows: T15: 0/0.2/0.3/0.4/0.5/0.6/0.7/1/1.5/2/3/4/5/7/10/15 s, T150: 0/10/20/30/40/50/60/70/80/90/100/110/120/130/140/150 s.

Basic unit

Safety outputs		Auxiliary outputs	No. of input channels	Rated voltage	Terminal block type	Order code
Instantaneous	OFF-delayed					
2 P channel MOS-FET transistor output	–	2 PNP transistor output	1 or 2 channels	24 VDC	Screw terminals	G9SX-BC202-RT
					Cage clamp terminals	G9SX-BC202-RC

Expansion unit

Safety outputs		Auxiliary outputs	OFF-delay time	Rated voltage	Terminal block type	Order code
Instantaneous	OFF-delayed					
4 PST-NO (contact)	–	2 (solid state) PNP transistor outputs	–	24 VDC	Screw terminals	G9SX-EX401-RT
					Cage clamp terminals	G9SX-EX401-RC
–	4 PST-NO (contact)	Synchronized with G9S-X-AD - unit	–	24 VDC	Screw terminals	G9SX-EX041-T-RT
					Cage clamp terminals	G9SX-EX041-T-RC

Specifications

Power input

Item	G9SX-AD_	G9SX-BC202_	G9SX-EX_
Rated supply voltage	20.4 to 26.4 VDC (24 VDC -15% +10%)		

Inputs

Item	G9SX-AD_	G9SX-BC202_
Safety input	Operating voltage: 20.4 VDC to 26.4 VDC, internal impedance: Approx. 2.8 kΩ	
Feedback/reset input		

Outputs

Item	G9SX-AD_	G9SX-BC202_
Instantaneous safety output OFF-delayed safety output	P channel MOS FET transistor output Load current: Using 2 outputs or less: 1 A DC max. Using 3 outputs or more: 0.8 A DC max.	
Auxiliary output	PNP transistor output Load current: 100 mA max.	

Expansion unit

Item	G9SX-EX_
Rated load	250 VAC, 3A/30 VDC, 3A (resistive load)
Rated carry current	3 A
Maximum switching voltage	250 VAC, 125 VDC

Characteristics

Item	G9SX-AD_	G9SX-BC202_	G9SX-EX_
Operating time (OFF to ON state)	50 ms max. (Safety input: ON) 100 ms max. (Logical AND connection input: ON)	50 ms max. (Safety input: ON)	30 ms max.
Response time (ON to OFF state)	15 ms max.		10 ms max.
Durability	Electrical	–	100,000 cycles min.
	Mechanical	–	5,000,000 cycles min.
Ambient temperature	–10°C +55°C (with no icing or condensation)		



Safety guard switching unit

The safety controller to support maintenance mode of machinery in the safe way.

- Two operation modes to support:
 - Auto switching for applications where machine and worker co-operate.
 - Manual switching for applications with limitation in operation like maintenance.
- Clear and transparent segmentation of safety functions by use of unique "AND" connection
- Clear LED diagnosis of all in- and output signals for easy maintenance
- PLe according to EN ISO 13849-1 and SIL 3 according to EN 61508.

Ordering information

Enabling grip switches

Contact form			Order code
Enabling switch	Monitor switch	Pushbutton switch	
Two contacts	1NC (grip output)	None	A4EG-C000041
Two contacts	None	Emergency stop switch (2NC)	A4EG-BE2R041
Two contacts	None	Momentary operation switch (2NO)	A4EG-BM2B041

Safety guard switching units

Safety outputs *1		Auxiliary outputs *2	Logical AND connection input	Logical AND connection output	Max. OFF delay time *3	Rated voltage	Terminal block type	Order code
Instantaneous	OFF-delayed *4							
2 (Semi-conductors)	2 (Semi-conductors)	6 (Semi-conductors)	1	1	15 s	24 VDC	Screw terminals	G9SX-GS226-T15-RT
							Spring-cage terminals	G9SX-GS226-T15-RC

*1 P channel MOS FET transistor output

*2 PNP transistor output

*3 The OFF-delay time can be set in 16 steps as follows:

T15: 0, 0.2, 0.3, 0.4, 0.5, 0.6, 0.7, 1, 1.5, 2, 3, 4, 5, 7, 10 or 15 s

*4 The OFF-delayed output becomes an instantaneous output by setting the OFF-delay time to 0 s.

Specifications

Ratings of guard switching unit

Power input

Item	G9SX-GS226-T15-__	G9SX-EX-__
Rated supply voltage	24 VDC	

Inputs

Item	G9SX-GS226-T15-__
Safety input	Operating voltage: 20.4 VDC to 26.4 VDC, internal impedance: approx. 2.8 kΩ
Feedback/reset input	
Mode selector input	

Outputs

Item	G9SX-G9SX-GS226-T15-__
Instantaneous safety output	P channel MOS FET transistor output Load current: 0.8 A DC max.
OFF-delayed safety output	
Auxiliary output	PNP transistor output Load current: 100 mA max.
External indicator outputs	P channel MOS FET transistor outputs Connectable indicators <ul style="list-style-type: none"> • Incandescent lamp: 24 VDC, 3 W to 7 W • LED lamp: 10 to 300 mA DC

Application example

Automatic switching mode

Worker is loading and unloading the machine manually. When loading is finished, robot cycle is started manually by the worker. When robots return to their home position, loading cycle is selected automatically.

Loading condition: Safety sensor B is not active, safety sensor A is active because the robots are not allowed to move to the loading area while the worker loads the machine. So the worker is safe because safety sensor A is active.

Robot work condition: Safety sensor B is active, safety sensor A is not active because the worker is not allowed to move to the loading area when the robots work. So the worker is safe because safety sensor B stops the machine if he moves to the loading area.

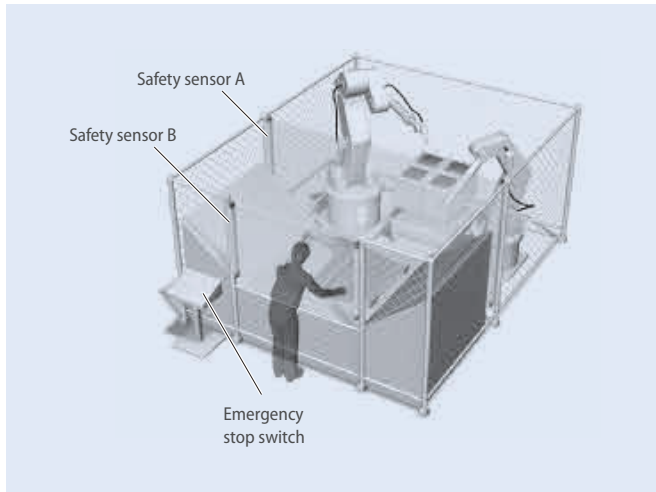

Manual switching mode

Worker has to do maintenance in this machine. While maintenance, it is necessary to move the machine in a limited way. The worker has to select automatic mode or manual mode manually by using the mode selector switch.

Operation steps:

- 1) Select maintenance mode by using the mode selector
- 2) Open the door to do the maintenance while the machine still is able to operate in a limited way (monitoring of limited movement by using the safety limit switch).
- 3) Close the cover after finishing maintenance
- 4) Select automatic mode by using the mode selector

E-Stop conditions:

- a) open the door while not in maintenance mode
- b) the machine actuates the limit switch (breaks the limit).
- c) the Enabling grip switch A4EG is actuated to stop the machine in emergency condition.

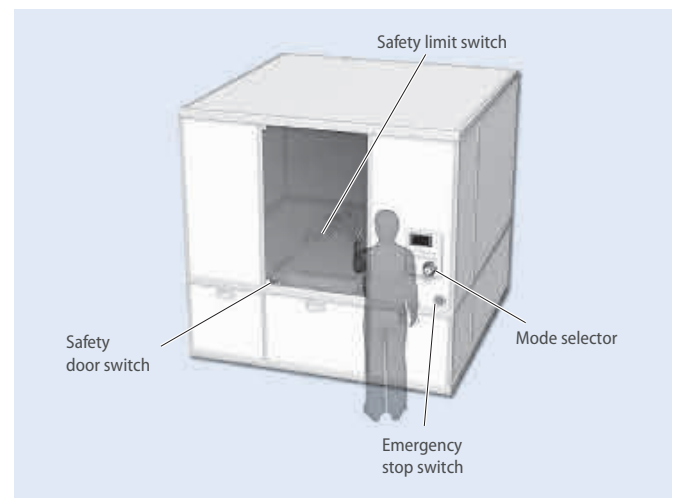



Limited speed monitoring unit

Safe limited speed monitoring unit for complete support of maintenance mode in machinery.

- Preset of limited speed frequency by using integrated preset switches
- Easy integration in G9SX-Systems by using unique logical "AND" connection
- Clear LED diagnosis of all in- and output signals for easy maintenance
- Applicable up to PLd according to EN ISO 13849-1 using Omron proximity sensors

Ordering information

Proximity sensors

Classification			Order code
Proximity sensor	Shielded	M8	E2E-X1R5F1
		M12	E2E-X2F1
		M18	E2E-X5F1
	Unshielded	M8	E2E-X2MF1
		M12	E2E-X5MF1
		M18	E2E-X10MF1

Ratings of limited speed monitoring unit

Safety outputs ^{*1}	Auxiliary outputs ^{*2}	Logical AND connection input	Rated voltage	Sensor power supply terminals	Terminal block type	Order code
Instantaneous 4 (Semi-conductors)	4 (Semi-conductors)	1	24 VDC	2	Screw terminals	G9SX-LM224-F10-RT
					Spring-cage terminals	G9SX-LM224-F10-RC

^{*1} P channel MOS FET output

^{*2} PNP transistor output

Specifications

Ratings of limited speed monitoring unit

Power input

Item	G9SX-LM224-F10-__
Rated supply voltage	24 VDC

Inputs

Item	G9SX-LM224-F10-__
Safety input	Operating voltage: 20.4 VDC to 26.4 VDC Internal impedance: approx. 2.8 kΩ
Feedback/reset input	
Mode selector input	
Rotation detection input	Operating voltage 20.4 VDC to 26.4 VDC Internal impedance: approx. 2.8 kΩ Input frequency: 1 kHz max.

Outputs

Item	G9SX-LM224-F10-__
Safety solid state output	P channel MOS FET transistor output Load current: 0.8 A DC max.
Safety speed detection output	P channel MOS FET transistor output Load current: 0.3 A DC max.
External indicator output	PNP transistor output Load current: 100 mA max.

Application example

Safe limited speed

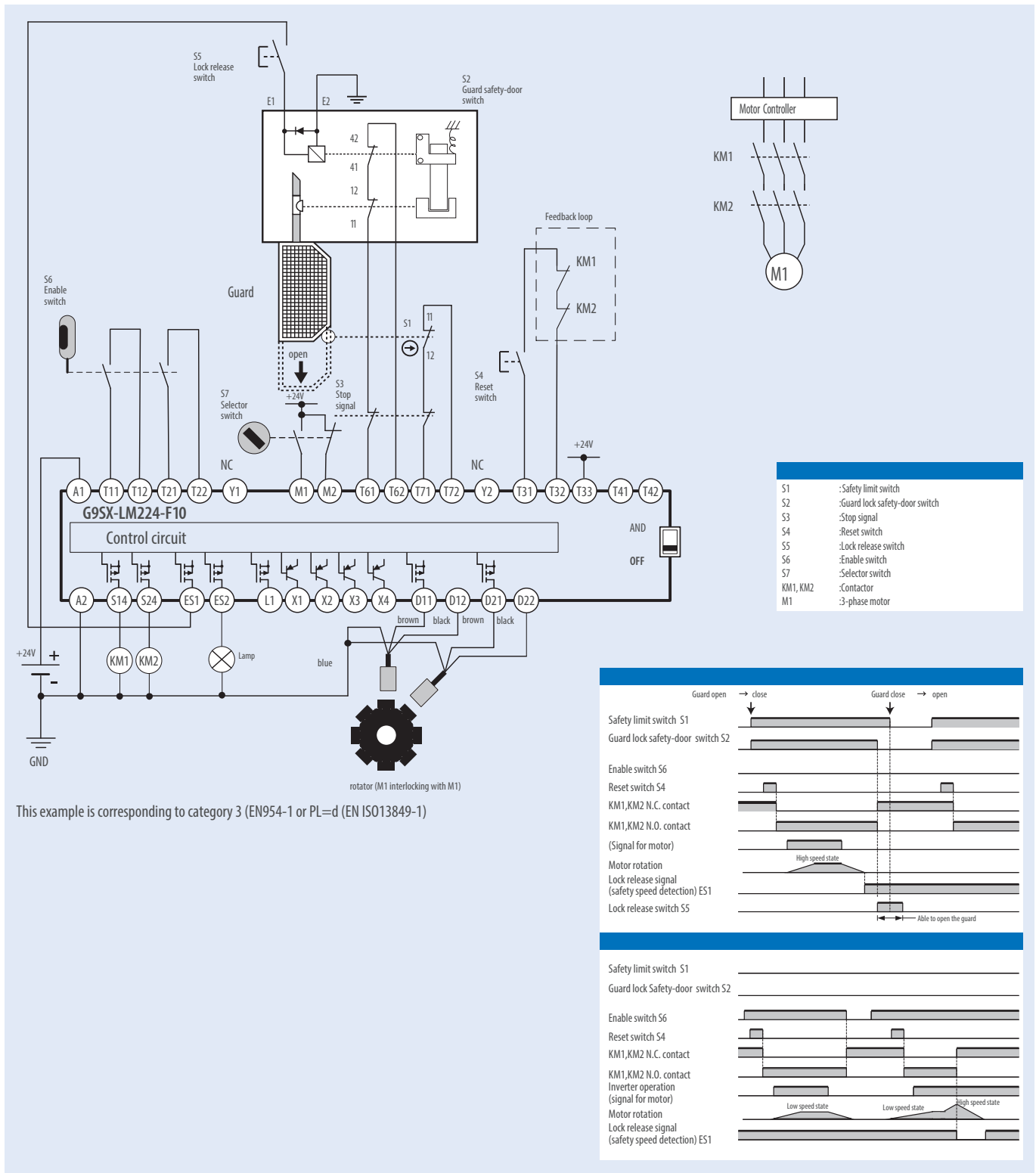



Standstill monitoring unit

Safe standstill monitoring unit based on Back-EMF operation for two- and three-phase systems.

- Ready to use – covering all standard applications without additional setup
- Easy integration in star- and delta wiring
- Clear LED diagnosis of all in- and output signals for easy maintenance
- Applicable up to PLe according to EN ISO 13849-1

Ordering information

Safety standstill monitoring unit

Safety outputs *1	Auxiliary outputs *1	Power input	Terminal block type	Order code
Instantaneous		Rated supply voltage		
3 (Semi-conductors)	2 (Semi-conductors)	24 VDC	Screw terminals	G9SX-SM032-RT
			Spring-cage terminals	G9SX-SM032-RC

*1 PNP transistor output

Specifications

Ratings of standstill monitoring unit

Power input

Item	G9SX-SM032-__
Rated supply voltage	24 VDC

Inputs

Item	G9SX-SM032-__
Input voltage	Standstill detection input (Z1-Z2/Z3-Z4) AC 415 Vrms + 10% max.
Maximum power supply frequency for AC induction motor	60 Hz max.
Internal impedance	Standstill detection input: approx. 660 kΩ EDM input: approx. 2.8 kΩ

Outputs

Item	G9SX-SM032-__
Safety standstill detection output	Sourcing output (PNP) Load current: 300 mA DC max.
Auxiliary output	Sourcing output (PNP) Load current: 100 mA DC max.

Application example

3-phase motor

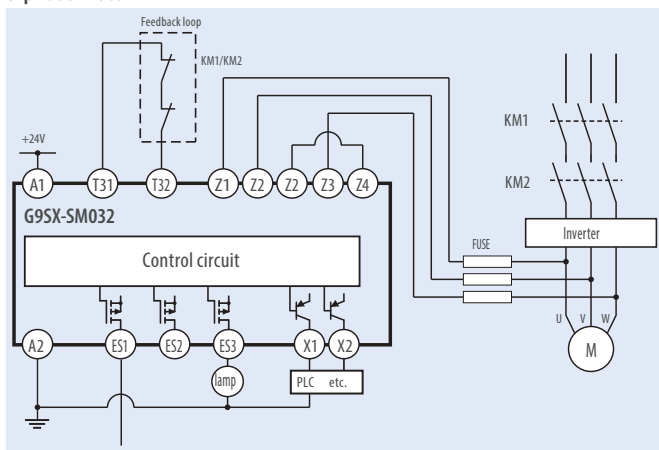

Standstill detected

3-phase motor with star-delta wiring

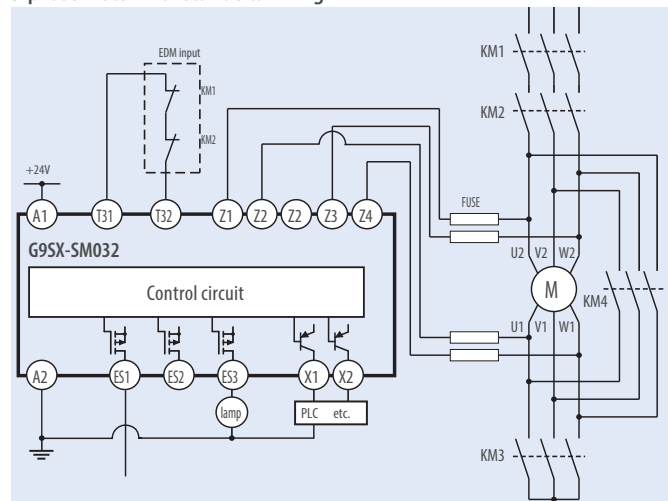

Standstill detected



Relays with forcibly guided contacts

The slim G7SA relay family with forcibly guided contacts is available as a four- or six-pole type in various contact combinations and offers reinforced insulation. Terminals are arranged for easy PCB layout. It can be soldered directly to a PCB or used together with the P7SA sockets.

- Forcibly guided contacts
- Conforms to EN 50205
- 6 A at 240 VAC and 6A at 24 VDC for resistive loads
- Reinforced insulation between inputs and outputs and poles
- 4- and 6-pole relays available

Ordering information

Relays with forcibly guided contacts

Type	Sealing	Poles	Contacts	Rated voltage	Order code
Standard	Flux-tight	4 poles	3PST-NO, SPST-NC	24 VDC ^{*1}	G7SA-3A1B
			DPST-NO, DPST-NC		G7SA-2A2B
			5PST-NO, SPST-NC		G7SA-5A1B
		6 poles	4PST-NO, DPST-NC		G7SA-4A2B
			3PST-NO, 3PST-NC		G7SA-3A3B

^{*1} 12 VDC, 21 VDC, 48 VDC are available on request.

Sockets

Type	LED indicator	Poles	Rated voltage	Order code
Track-mounting	Track mounting and screw mounting possible	4 poles	24 VDC	P7SA-10F-ND
		6 poles		P7SA-14F-ND
Back-mounting	PCB terminals	4 poles	-	P7SA-10P
		6 poles		P7SA-14P

Specifications

Coil

Rated voltage	Rated current	Coil resistance	Must-operate voltage	Must-release voltage	Max. voltage	Power consumption
24 VDC	4 poles: 15 mA 6 poles: 20.8 mA	4 poles: 1,600 Ω 6 poles: 1,152 Ω	75% max. (V)	10% min. (V)	110% (V)	4 poles: Approx. 360 mW 6 poles: Approx. 500 mW

Note: Refer to datasheet for details

Contacts

Load	Resistive load (cosφ = 1)	Load	Resistive load (cosφ = 1)
Rated load	6 A at 250 VAC, 6 A at 30 VDC	Max. switching current	6 A
Rated carry current	6 A	Max. switching capacity (reference value)	1,500 VA, 180 W
Max. switching voltage	250 VAC, 125 VDC		

Relays with forcibly guided contacts

Contact resistance	100 mΩ max. (The contact resistance was measured with 1 A at 5 VDC using the voltage-drop method.)	
Operating time ^{*1}	20 ms max.	
Response time ^{*1}	10 ms max. (The response time is the time it takes for the normally open contacts to open after the coil voltage is turned OFF.)	
Release time ^{*1}	20 ms max.	
Insulation resistance	100 MΩ min. (at 500 VDC) (The insulation resistance was measured with a 500 VDC megger at the same places that the dielectric strength was measured.)	
Dielectric strength ^{*2 *3}	Between coil contacts/different poles: 4,000 VAC, 50/60 Hz for 1 min (2,500 VAC between poles 3-4 in 4-pole Relays or poles 3-5, 4-6, and 5-6 in 6-pole Relays.) Between contacts of same polarity: 1,500 VAC, 50/60 Hz for 1 min	
Durability	Mechanical	10,000,000 operations min. (at approx. 36,000 operations/hr)
	Electrical	100,000 operations min. (at the rated load and approx. 1,800 operations/hr)
Min. permissible load ^{*4}	5 VDC, 1 mA (reference value)	
Ambient temperature ^{*5}	Operating: -40 to 85°C (with no icing or condensation)	
Ambient humidity	Operating: 35 to 85%	
Approved standards	EN61810-1 (IEC61810-1), EN50205, UL508, CSA22.2 No. 14	

^{*1} These times were measured at the rated voltage and an ambient temperature of 23°C. Contact bounce time is not included.

^{*2} Pole 3 refers to terminals 31-32 or 33-34, pole 4 refers to terminals 43-44, pole 5 refers to terminals 53-54, and pole 6 refers to terminals 63-64.

^{*3} When using a P7SA socket, the dielectric strength between coil contacts/different poles is 2,500 VAC, 50/60 Hz for 1 min.

^{*4} Min. permissible load is for a switching frequency of 300 operations/min.

^{*5} When operating at a temperature between 70°C and 85°C, reduce the rated carry current (6 A at 70°C or less) by 0.1 A for each degree above 70°C.

Note: The values listed above are initial values.

Please check Omron in the Internet for updated information on product reliability data and the SISTEMA libraries: <http://industrial.omron.eu/safety>

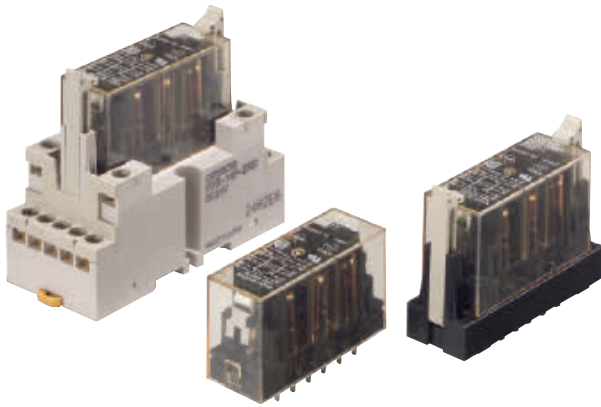

Relays with forcibly guided contacts

The slim G7S-_-E relay family with forcibly guided contacts is available as a six-pole type in two different contact combinations. Terminals are arranged for easy PCB layout. It can be soldered directly to a PCB or used together with the P75A sockets.

- Forcibly guided contacts
- Conforms to EN 50205
- NO contacts: 10 A at 250 VAC and 10 A at 30 VDC
NC contacts: 6 A at 250 VAC and 6 A at 30 VDC (for resistive loads)
- Reinforced insulation between inputs and outputs and poles
- 4- and 6-pole relays available

Ordering information

Relays with forcibly guided contacts

Type	Sealing	Poles	Contacts	Rated voltage	Order code
Standard	Flux-tight	6 poles	4PST-NO, DPST-NC	24 VDC	G7S-4A2B-E
			3PST-NO, 3PST-NC		G7S-3A3B-E

Sockets

Type		LED indicator	Rated voltage	Order code
Track-mounting	Track mounting and screw mounting possible	Yes	24 VDC	P7S-14F-END
Back-mounting	PCB terminals	No	–	P7S-14P-E

Specifications

Ratings

Coil

Rated voltage	Rated current (mA) ^{*1}	Coil resistance (Ω) ^{*1}	Max. voltage (V) ^{*2}	Power consumption (W)
24 VDC	30	800	110%	Approx. 0.8

^{*1} The rated current and coil resistance are measured at a coil temperature of 23°C with tolerances of ±15%.

^{*2} The maximum voltage is based on an ambient operating temperature of 23°C maximum.

Contacts

Item	Resistive load	
Rated load	NO contact	10 A at 250 VAC, 10 A at 30 VDC
	NC contact	6 A at 250 VAC, 6 A at 30 VDC
Rated carry current	NO contact	10 A
	NC contact	6 A

Item	Resistive load	
Maximum switching voltage	250 VAC, 30 VDC	
Maximum switching current	NO contact	10 A
	NC contact	6 A

G7S-_-E Characteristics of Sockets

Model	P7S-14F-END	P7S-14P-E
Continuous current	10 A	
Dielectric strength	2000 VAC for 1 min. between terminals	
Insulation resistance	1000 MW min. ^{*1}	
Ambient operating humidity	25 to 85%	5 to 85%

^{*1} Measurement conditions: Measurement of the same points as for the dielectric strength at 500 VDC.

Characteristics

Contact resistance ^{*1}	100 mΩ max.	
Operating time ^{*2}	50 ms max.	
Release time ^{*2}	50 ms max.	
Maximum operating frequency	Mechanical	18,000 operations/h
	Rated load	1,800 operations/h
Insulation resistance	100 MΩ min.	
Durability ^{*3}	Mechanical	10,000,000 operations min. (at approx. 18,000 operations/h)
	Electrical	100,000 operations min. (at the rated load and approx. 1,800 operations/h)
Inductive load switching capability ^{*4} (IEC60947-5-1)	NO Contact	AC15 AC240V 5A, DC13 DC24V 2A
	NC Contact	AC15 AC240V 3A, DC13 DC24V 2A
Ambient operating temperature	–25 to 70°C (with no icing or condensation)	
Ambient operating humidity	5% to 85%	

^{*1} Measurement conditions: 5 VDC, 10 mA, voltage drop method.

^{*2} Measurement conditions: Rated voltage operation, ambient operating temperature: 23°C, contact bounce time is not included.

^{*3} The durability is for an ambient temperature of 15 to 35°C and an ambient humidity of 25% to 75%.

^{*4} AC15: cosφ = 0.3, DC13: L/R = 96-ms

Note: The values listed above are initial values.

Please check Omron in the Internet for updated information on product reliability data and the SISTEMA libraries: <http://industrial.omron.eu/safety>



Standalone safety controller

The G9SP safety controller provides all local safety based in- and outputs and controls the safety application.

- Three CPU-types to suit different applications
- Clear diagnosis and monitoring via Ethernet or serial connection
- Memory cassette for easy duplication of configuration
- Unique programming software to support easy design, verification, standardization and reuse of the program.
- Certified according to PLe (EN ISO 13849-1) and SIL 3 (IEC 61508)

Ordering information

Appearance	Appearance description	Order code
Standalone safety controller	10 PNP safety inputs 4 PNP safety outputs 4 test outputs 4 PNP standard outputs	G9SP-N10S
	10 PNP safety inputs 16 PNP safety outputs 6 test outputs	G9SP-N10D
	20 PNP safety inputs 8 PNP safety outputs 6 test outputs	G9SP-N20S

Software

Appearance	Media	Applicable OS	Order code
G9SP configurator	Setup disk 1 license	Windows 2000	WS02-G9SP01-V1
	Setup disk 10 licenses	Windows XP	WS02-G9SP10-V1
	Setup disk 50 licenses	Windows Vista	WS02-G9SP50-V1
	Setup disk Site license	Windows 7	WS02-G9SPXX-V1

Expansion units (standard I/O)

Appearance	Type	Number of I/O		Model
		In	Out	
Expansion I/O unit	Sinking	12	8 (solid state)	CP1W-20EDT
	Sourcing	12	8 (solid state)	CP1W-20EDT1
	Sinking	-	32 (solid state)	CP1W-32ET
	Sourcing	-	32 (solid state)	CP1W-32ET1
I/O Connecting cable, 80 cm long				CP1W-CN811

Option units

Appearance	Order code
RS-232C option board	CP1W-CIF01
Ethernet option board (Ver. 2.0 or later)	CP1W-CIF41
Memory cassette	CP1W-ME05M
G9SP Status Display Touchscreen with 1.8 m cable	82614-0010 H-T40M-P
G9SP-N10S Display Kit (G9SP, Touchscreen, cable, CP1W-CIF01)	82612-0010 G9SP-N10S-SDK
G9SP-N10D Display Kit (G9SP, Touchscreen, cable, CP1W-CIF01)	82612-0020 G9SP-N10D-SDK
G9SP-N20S Display Kit (G9SP, Touchscreen, cable, CP1W-CIF01)	82612-0030 G9SP-N20S-SDK
G9SP-N10S kit with EtherNet/IP module	82608-0010 G9SP-N10S-EIP
G9SP-N10D kit with EtherNet/IP module	82608-0020 G9SP-N10D-EIP
G9SP-N20S kit with EtherNet/IP module	82608-0030 G9SP-N20S-EIP

G9SP configuration

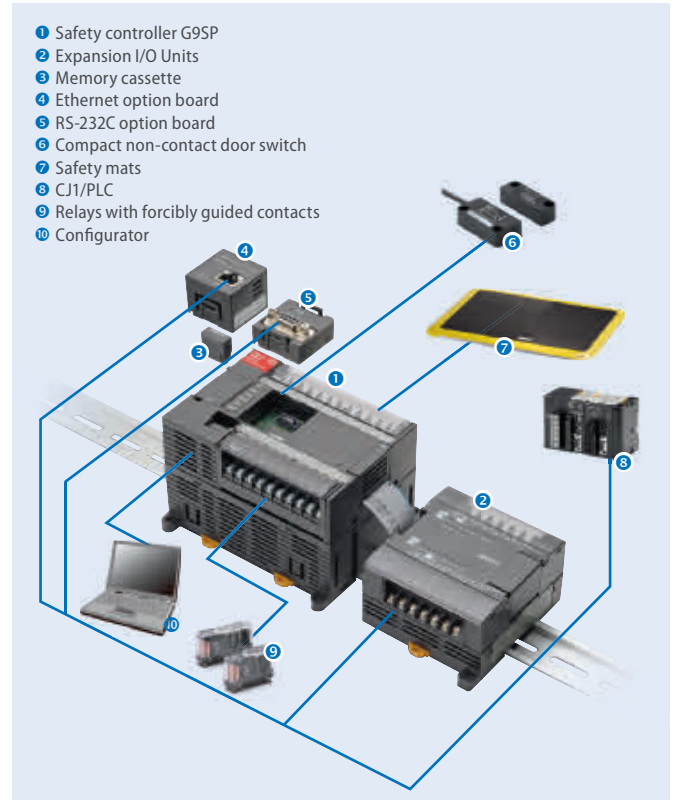

Safety control systems

Specifications

General specifications

Power supply voltage	20.4 to 26.4 VDC (24 VDC -15% +10%)	
Consumption current	G9SP-N10S	400 mA (V1: 300 mA, V2: 100 mA)
	G9SP-N10D	500 mA (V1: 300 mA, V2: 200 mA)
	G9SP-N20S	500 mA (V1: 400 mA, V2: 100 mA)
Mounting method	35-mm DIN track	
Ambient operating temperature	0°C to 55°C	
Ambient storage temperature	-20°C to 75°C	
Degree of protection	IP20 (IEC 60529)	

Safety input specifications

Input type	Sinking inputs (PNP)
ON voltage	11 VDC min. between each input terminal and G1
OFF voltage	5 VDC max. between each input terminal and G1
OFF current	1 mA max.
Input current	6 mA

Safety output specifications

Output type	Sourcing outputs (PNP)
Rated output current	0.8 A max. per output*
Residual voltage	1.2 V max. between each output terminal and V2

Test output specifications

Output type	Sourcing outputs (PNP)
Rated output current	0.3 A max. per output*
Residual voltage	1.2 V max. between each output terminal and V1

Standard output specifications (G9SP-N10S)

Output type	Sourcing outputs (PNP)
ON Residual voltage	1.5 V max. (between each output terminal and V2)
Rated output current	100 mA max.*

*For details on the rated output current, please refer to the user manual of G9SP.

Control system integration

Safety - I/O-status becomes transparent

The standalone safety controller offers diagnosis information in 3 ways:

- 1) via parallel wiring
- 2) via serial RS232C interface (option)
- 3) via Ethernet interface (option).

Information of all safety in- and outputs on the standard control system ensure minimum downtime of the machine.

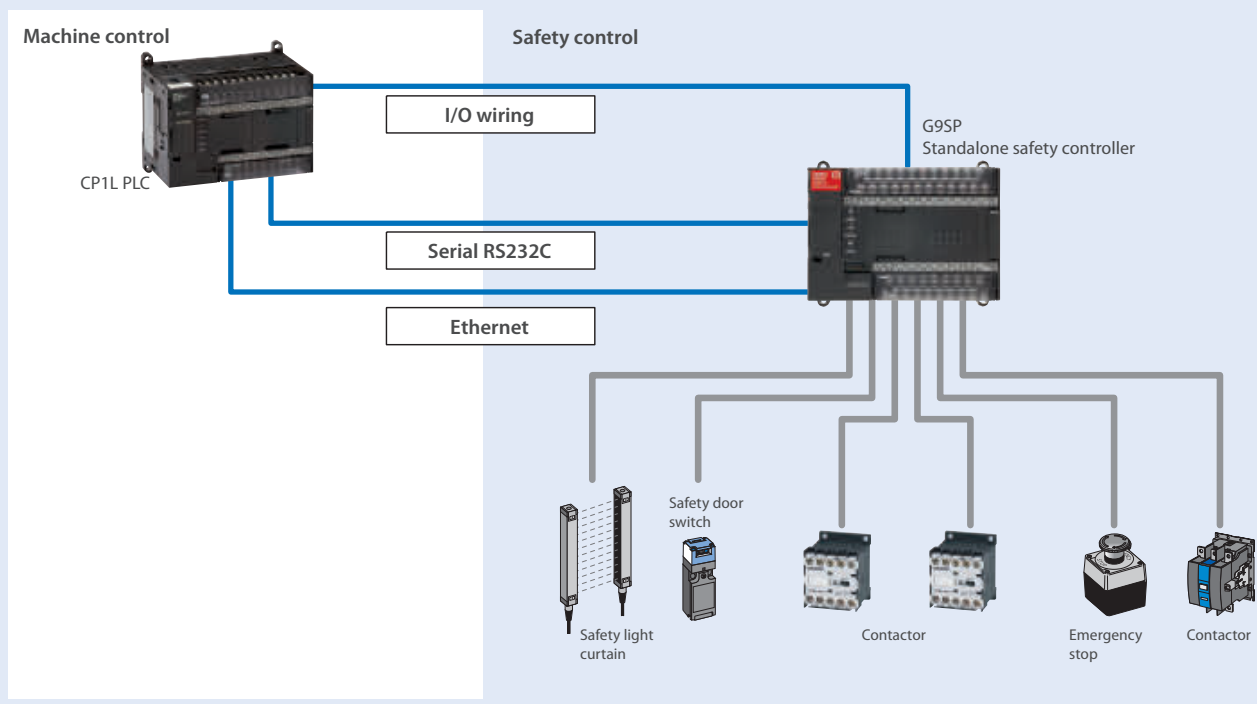

G9SP configuration tool



Easy setup and configuration is provided by a setup wizard supporting the hardware selection.

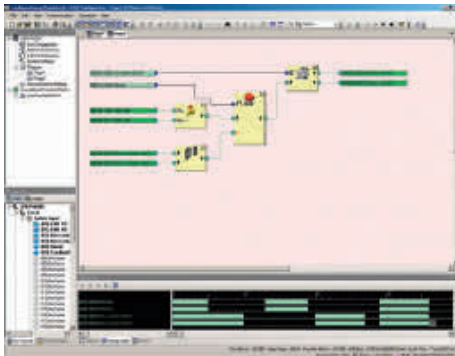

Integrated Simulator

All functions can be tested and simulated in the Configuration Tool, so there's no unnecessary additional workload for the engineer. In addition, on-line diagnosis reduces debug time to a minimum during implementation in the machine control system.

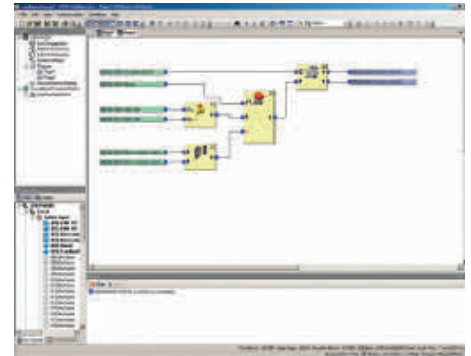

User-defined function blocks

Approved configuration elements such as a tested door monitoring solution can be easily stored as a user defined function block and re-used in future projects. This minimises the time it takes to create a new system configuration.

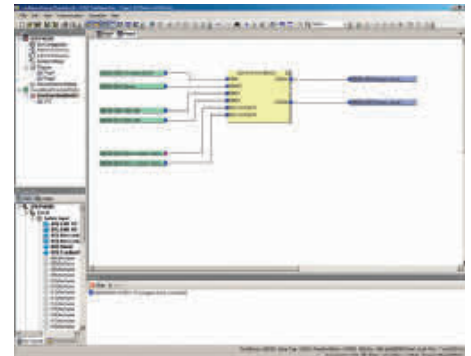

Knowledge-building

Existing configurations are the basis for new projects. The G9SP Configuration Tool supports re-use of existing and proven know-how in safety control, as well as user-defined function blocks. Which means no more repetition of effort, instead a growing library of safety solutions.



Control components

Find information fast!

Quick Links shortens your search. Quick Links are unique codes assigned to Omron products listed in this guide. Enter Quick Link codes in the search box on industrial.omron.eu to access detailed information on products in this guide.

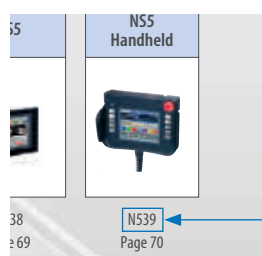

[Quick Link](#)

Control components

Temperature controllers

Product overview	512
Selection table	514
Basic temperature controllers	
E5C2	517
E5CSV	519
E5CB	520
K8AK-TH	512
E5L	512
E5L-A/C	514
E5_L	514
General purpose temperature controllers	
E5_C	521
Advanced and Multi-Loop controllers	
E5_C-T	527
E5_N-H/E5_N-HT	529
E5_R/E5_R-T	531
CelciuX° (EJ1)	533
Temperature sensors	
E52-E	535
Auxiliaries	
PRT1-SCU11/ES1B	536
ES1C/EJ1N-HFU-ETN	537

Power supplies

Product overview	538
Selection table	540
Single-phase	
S8VK-C	542
S8VK-G	543
S8JC-ZS	545
S8JX-G	546
S8JX-P	548
S8EX	550
DC Backup	
S8TS	549
S8T-DCBU-01/-02	551
Three-phase	
S8VK-T	544
Digital multi circuit protector	
S8M	553
Redundancy unit	
S8VK-R	552

Timers

Product overview	554
Selection table	556
Analog solid state timers	
H3DS	558
H3DK	559
H3YN	560
H3CR	561
Digital timers	
H5CX	562
H8GN	571
Motor timers	
H2C	563

Counters

Product overview	564
Selection table	566
Totalisers	
H7EC	568
H7ET	569
H7ER	570
Pre-set counters	
H8GN	571
H7CX	572
Cam positioners	
H8PS	573

Programmable relays

Product overview	574
Selection table	577
Programmable relays	
ZEN-10C	578
ZEN-20C	579
ZEN-8E	580
ZEN-PA	581

Digital panel indicators

Product overview	582
Selection table	584
1/32 DIN multi-function	
K3GN	586
1/8 DIN standard indicators	
K3MA-J, -L, -F	587
1/8 DIN advanced indicators	
K3HB-X, -H, -V, -S	588
K3HB-C, -P, -R	590

Temperature controllers

E5_C – THE NEW STANDARD

...in temperature control

Omron has been an active innovator in temperature control since introducing its first temperature controller in 1967. Now temperature control has taken a giant leap forward with Omron's next generation of controllers – the E_C, which set new global standards in the crucial areas of precision, user friendliness and control performance. The E_C series will save you time and effort in set-up and operation, while enabling faster and more accurate monitoring/control of your process. The high visibility display of the new series is also extremely easy to read and virtually eliminates any possibility for human error.



Always the latest news on:

industrial.omron.eu/en/news/product-news

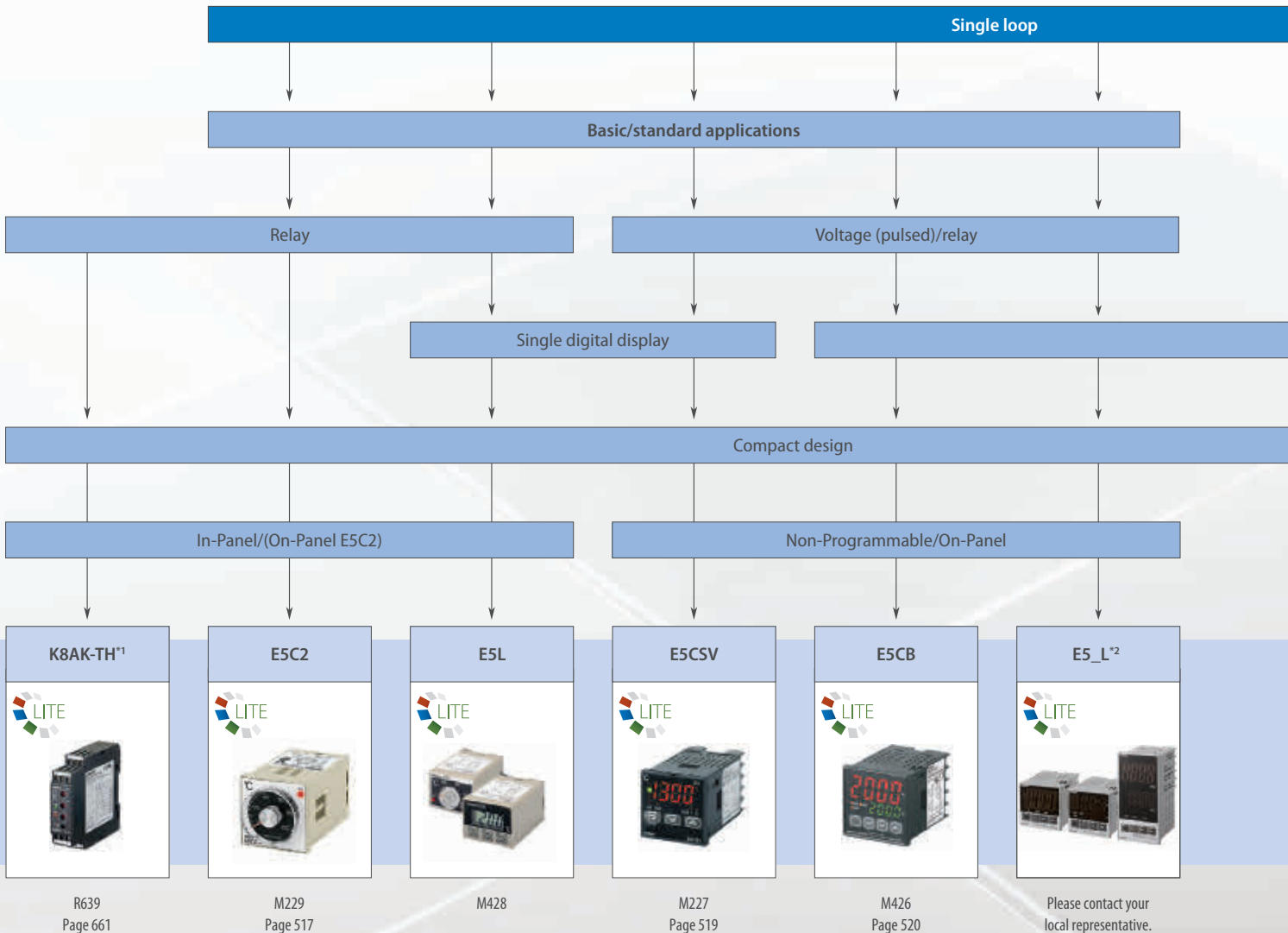

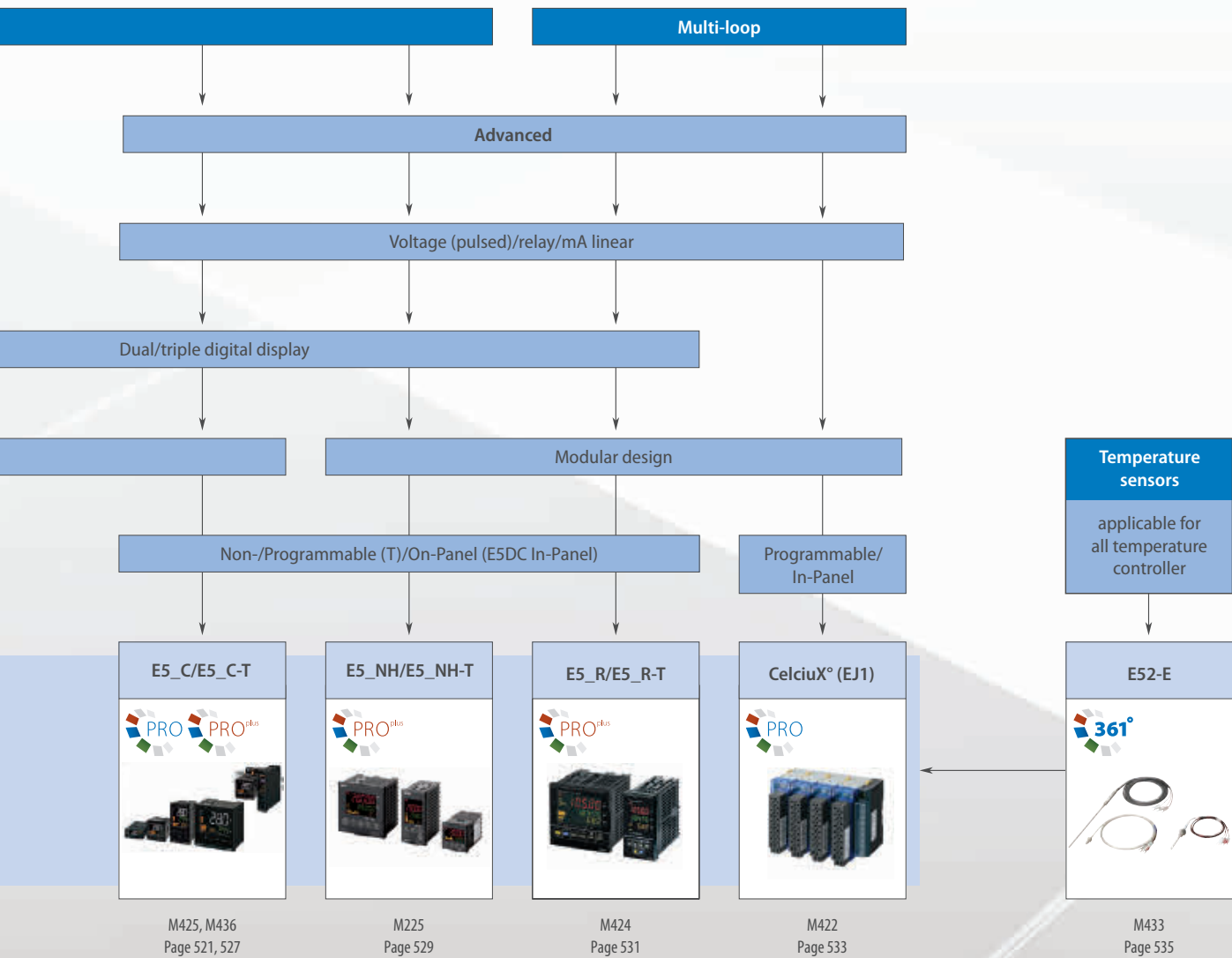

¹ Temperature limiter

² Only available in Africa, Middle East and Russia

Selection table

Category		Analog temperature controller	Analog/digital temperature controller	Digital temperature controller		
						
Model		ESC2	ESL-A/C	E5CSV	E5CB	E5_L
Selection criteria	Type	Lite line				
	Panel	On-panel/In-Panel	In-Panel	On-panel		
	Loops	1	1	1	1	1
	Size	1/16 DIN	45 × 35 mm	1/16 DIN	1/16 DIN	1/16, 1/32 DIN
Control mode	ON/OFF PID 2-PID ^{*1}	■/P ■ -	■ - -	■ - ■	■ - ■	■ - ■
	Operation ^{*2}	H/C	H/C	H/C	H/C	H/C
	Valve Control ^{*3}	-	-	-	-	-
Features	Accuracy	-	±1°C	±0.5%	±0.5%	±0.5%
	Auto-/Self-/Gradient-tuning	- -	- -	■ ■	■ ■ -	■ ■ -
	Transfer output	-	-	-	-	-
	Remote input	-	-	-	-	-
	Number of alarms	-	-	1	1	1
	Heater alarm	-	-	-	-	-
	IP rating front panel	IP40	IP40	IP66	IP66	IP50
	Display	-	Analog (A)/3 digit (C)	Single 3.5 digit	Dual 4 digit	Dual 4 digit
Supply voltage	110/240 VAC	■	■	■	■	■
	24 VAC/VDC	-	-	□	□	-
Comms	RS-232 RS-485	- -	- -	- -	- -	- -
	Event IP	-	-	-	-	-
	QLP port	-	-	-	■ ^{*4}	-
	DeviceNet	-	-	-	-	-
	Modbus	-	-	-	■	-
	PROFIBUS	-	-	-	-	-
	Modbus TCP	-	-	-	-	-
ProfiNet	-	-	-	-	-	
Control output	Relay SSR	- -	- -	■ -	■ -	■ -
	Voltage (pulse)	-	-	■	■	■
	Linear voltage	-	-	-	-	-
	Linear current	-	-	-	-	-
Input type – linear	mA	-	-	-	-	-
	mV	-	-	-	-	-
	V	-	-	-	-	-
Input type Thermocouple	K	■	-	■	■	■
	J	■	-	■	■	■
	T	-	-	■	■	■
	E	-	-	-	-	-
	L	-	-	■	-	-
	U	-	-	■	-	-
	N	-	-	■	-	-
	R	-	-	■	■	■
	S	-	-	-	■	■
	B	-	-	-	-	-
	W	-	-	-	-	-
	PLII	-	-	-	-	-
	RTD	Pt100 JPt100 THE	■ - ■	- - ■ ^{*5}	■ ■ -	■ - -
	Page/Quick Link	517	Please contact your local representative.	519	520	Please contact your local representative.

^{*1} 2-PID is Omron's easy to use high performance PID algorithm

^{*2} H = heat, H/C = heat or cool, H & C = heat and/or cool

^{*3} Valve control = relay up and down

^{*4} QLP: Quick Link Port to connected TC to PC using the smart USB cable E58-CIFQ2

^{*5} SP sensor provided

Digital temperature controller	Digital programmable temperature controller	Digital (programmable) temperature controller		Digital temperature/Gradient controller
E5_C	E5_C-T	E5_NH/E5_NH-T	E5_R/E5_R-T	CelciuX° (EJ1-G)
Pro line	ProPlus (Lite) line – Programmable (T)	ProPlus line – Programmable (T)		Pro line
On-panel/In-Panel		On-panel		In-panel
1	1	1	2/4	2/4
1/4, 1/8, 1/16, 1/32, 22,5 mm	1/4, 1/8, 1/16 DIN	1/4, 1/8, 1/16 DIN	1/4, 1/8 DIN	31 × 95.5 × 109 mm
<input checked="" type="checkbox"/> <input type="checkbox"/> <input checked="" type="checkbox"/>	<input checked="" type="checkbox"/> <input type="checkbox"/> <input checked="" type="checkbox"/>	<input checked="" type="checkbox"/> <input type="checkbox"/> <input checked="" type="checkbox"/>	<input checked="" type="checkbox"/> <input type="checkbox"/> <input checked="" type="checkbox"/>	<input checked="" type="checkbox"/> <input type="checkbox"/> <input checked="" type="checkbox"/>
H & C	H & C	H & C	H & C	H & C
<input type="checkbox"/>	<input type="checkbox"/>	<input type="checkbox"/>	<input type="checkbox"/>	-
±0.3%	±0.3%	±0.1%	±0.1%	±0.5%
<input checked="" type="checkbox"/> <input checked="" type="checkbox"/> <input checked="" type="checkbox"/> <input type="checkbox"/> -	<input checked="" type="checkbox"/> <input checked="" type="checkbox"/> <input checked="" type="checkbox"/> <input type="checkbox"/> -	<input checked="" type="checkbox"/> <input checked="" type="checkbox"/> <input checked="" type="checkbox"/> <input type="checkbox"/> -	<input checked="" type="checkbox"/> <input type="checkbox"/> <input checked="" type="checkbox"/> <input type="checkbox"/> -	<input checked="" type="checkbox"/> <input type="checkbox"/> <input checked="" type="checkbox"/> <input checked="" type="checkbox"/> (only G)
<input type="checkbox"/>	<input type="checkbox"/>	<input type="checkbox"/>	<input type="checkbox"/>	<input type="checkbox"/> (only EJ1)
<input type="checkbox"/>	<input type="checkbox"/>	<input type="checkbox"/>	<input type="checkbox"/>	<input type="checkbox"/>
0-4	3-4	2-3	2-3	2
<input type="checkbox"/> *6	<input type="checkbox"/> *6	<input type="checkbox"/> *6	<input type="checkbox"/> *6	<input type="checkbox"/>
IP66	IP66	IP66	IP66	IP20
Dual/triple 4 digit	Dual/triple 4 digit	Dual/triple 5 digit	Triple 5 digit	-
<input checked="" type="checkbox"/>	<input checked="" type="checkbox"/>	<input checked="" type="checkbox"/>	<input checked="" type="checkbox"/>	-
<input type="checkbox"/>	<input type="checkbox"/>	<input type="checkbox"/>	<input type="checkbox"/>	24 VDC
- <input type="checkbox"/>	- <input type="checkbox"/>	<input type="checkbox"/> <input type="checkbox"/>	- <input type="checkbox"/>	<input checked="" type="checkbox"/> <input checked="" type="checkbox"/>
<input type="checkbox"/>	<input type="checkbox"/>	<input type="checkbox"/>	<input type="checkbox"/>	<input type="checkbox"/>
<input checked="" type="checkbox"/> *7	<input checked="" type="checkbox"/> *7	<input checked="" type="checkbox"/> *10	<input checked="" type="checkbox"/> *10	<input checked="" type="checkbox"/>
-	-	-	<input type="checkbox"/>	<input type="checkbox"/>
<input checked="" type="checkbox"/>	<input checked="" type="checkbox"/>	<input checked="" type="checkbox"/>	<input checked="" type="checkbox"/>	<input checked="" type="checkbox"/>
<input type="checkbox"/> *8	<input type="checkbox"/> *8	<input type="checkbox"/> *8	<input type="checkbox"/> *8	<input type="checkbox"/> *8
<input type="checkbox"/> *9	<input type="checkbox"/> *9	<input type="checkbox"/> *9	<input type="checkbox"/> *9	<input type="checkbox"/> *9
<input type="checkbox"/> *9	<input type="checkbox"/> *9	<input type="checkbox"/> *9	<input type="checkbox"/> *9	<input type="checkbox"/> *9
<input checked="" type="checkbox"/> <input type="checkbox"/> -	<input checked="" type="checkbox"/> <input type="checkbox"/> -	<input checked="" type="checkbox"/> <input checked="" type="checkbox"/>	<input checked="" type="checkbox"/> <input type="checkbox"/> -	- <input type="checkbox"/> -
<input checked="" type="checkbox"/>	<input checked="" type="checkbox"/>	<input checked="" type="checkbox"/>	<input checked="" type="checkbox"/>	<input checked="" type="checkbox"/>
-	-	<input checked="" type="checkbox"/>	-	-
<input checked="" type="checkbox"/>	<input checked="" type="checkbox"/>	<input checked="" type="checkbox"/>	<input checked="" type="checkbox"/>	<input checked="" type="checkbox"/> (only EJ1)
<input checked="" type="checkbox"/>	<input checked="" type="checkbox"/>	<input checked="" type="checkbox"/>	<input checked="" type="checkbox"/>	<input checked="" type="checkbox"/>
-	-	-	-	-
<input checked="" type="checkbox"/>	<input checked="" type="checkbox"/>	<input checked="" type="checkbox"/>	<input checked="" type="checkbox"/>	<input checked="" type="checkbox"/>
<input checked="" type="checkbox"/>	<input checked="" type="checkbox"/>	<input checked="" type="checkbox"/>	<input checked="" type="checkbox"/>	<input checked="" type="checkbox"/>
<input checked="" type="checkbox"/>	<input checked="" type="checkbox"/>	<input checked="" type="checkbox"/>	<input checked="" type="checkbox"/>	<input checked="" type="checkbox"/>
<input checked="" type="checkbox"/>	<input checked="" type="checkbox"/>	<input checked="" type="checkbox"/>	<input checked="" type="checkbox"/>	<input checked="" type="checkbox"/>
<input checked="" type="checkbox"/>	<input checked="" type="checkbox"/>	<input checked="" type="checkbox"/>	<input checked="" type="checkbox"/>	<input checked="" type="checkbox"/>
<input checked="" type="checkbox"/>	<input checked="" type="checkbox"/>	<input checked="" type="checkbox"/>	<input checked="" type="checkbox"/>	<input checked="" type="checkbox"/>
<input checked="" type="checkbox"/>	<input checked="" type="checkbox"/>	<input checked="" type="checkbox"/>	<input checked="" type="checkbox"/>	<input checked="" type="checkbox"/>
<input checked="" type="checkbox"/>	<input checked="" type="checkbox"/>	<input checked="" type="checkbox"/>	<input checked="" type="checkbox"/>	<input checked="" type="checkbox"/>
<input checked="" type="checkbox"/>	<input checked="" type="checkbox"/>	<input checked="" type="checkbox"/>	<input checked="" type="checkbox"/>	<input checked="" type="checkbox"/>
<input checked="" type="checkbox"/>	<input checked="" type="checkbox"/>	<input checked="" type="checkbox"/>	<input checked="" type="checkbox"/>	<input checked="" type="checkbox"/>
<input checked="" type="checkbox"/>	<input checked="" type="checkbox"/>	<input checked="" type="checkbox"/>	<input checked="" type="checkbox"/>	<input checked="" type="checkbox"/>
<input checked="" type="checkbox"/>	<input checked="" type="checkbox"/>	<input checked="" type="checkbox"/>	<input checked="" type="checkbox"/>	<input checked="" type="checkbox"/>
<input checked="" type="checkbox"/>	<input checked="" type="checkbox"/>	<input checked="" type="checkbox"/>	<input checked="" type="checkbox"/>	<input checked="" type="checkbox"/>
<input checked="" type="checkbox"/>	<input checked="" type="checkbox"/>	<input checked="" type="checkbox"/>	<input checked="" type="checkbox"/>	<input checked="" type="checkbox"/>
<input checked="" type="checkbox"/>	<input checked="" type="checkbox"/>	<input checked="" type="checkbox"/>	<input checked="" type="checkbox"/>	<input checked="" type="checkbox"/>
<input checked="" type="checkbox"/> <input checked="" type="checkbox"/> <input checked="" type="checkbox"/> <input type="checkbox"/> -	<input checked="" type="checkbox"/> <input checked="" type="checkbox"/> <input checked="" type="checkbox"/> <input type="checkbox"/> -	<input checked="" type="checkbox"/> <input checked="" type="checkbox"/> <input checked="" type="checkbox"/> <input type="checkbox"/> -	<input checked="" type="checkbox"/> <input type="checkbox"/> <input checked="" type="checkbox"/> <input type="checkbox"/> -	<input checked="" type="checkbox"/> <input checked="" type="checkbox"/> <input checked="" type="checkbox"/> <input type="checkbox"/> -
521	527	529	531	533

*6 Heater alarm = heater burnout & SSR failure detection
 *7 Quick link port using comm. cable E58-CIFQ2
 *8 PROFIBUS-DP communication option via PRT1-SCU11
 *9 EJ1N-HFU-ETN Serial gateway
 *10 QLP: Quick Link Port to connected TC to PC using the smart USB cable E58-CIFQ1



Easy-to-use, basic temperature controller with analog dial setting

Omron's basic ON/OFF or PD controller features an analog setting dial. This compact, low-cost controller has a setting accuracy of 2% of full scale. It incorporates a plug-in socket allowing for DIN-rail or flush mounting.

- Compact, cost-effective controller
- Control mode: ON/OFF or P
- Control output: relay
- Power supply: 100 to 240 VAC
- Thermocouple K: 0 to 1200°C, J: 0 to 400°C, Pt100: -50 to 400°C

Ordering information

Standard models (Power supply: 100 to 240 VAC)

Input		Control method	On/OFF	Proportional (P)		
		Output/Indication method	Relay/No indication			
Input/ standard scale (°C)	Thermocouple	K (CA) Chromel vs. Alumel	0 to 200 °C	ESC2-R20K AC100-240 0-200	E5C2-R40K AC100-240 0-200	
			0 to 300 °C	–	E5C2-R40K AC100-240 0-300	
			0 to 400 °C	ESC2-R20K AC100-240 0-400	E5C2-R40K AC100-240 0-400	
			0 to 600 °C	ESC2-R20K AC100-240 0-600	E5C2-R40K AC100-240 0-600	
			0 to 800 °C	ESC2-R20K AC100-240 0-800	E5C2-R40K AC100-240 0-800	
			0 to 1000 °C	ESC2-R20K AC100-240 0-1000	–	
			0 to 1200 °C	ESC2-R20K AC100-240 0-1200	–	
		J (IC) Iron versus Constantan	0 to 200 °C	ESC2-R20J AC100-240 0-200	–	
			0 to 300 °C	ESC2-R20J AC100-240 0-300	–	
			0 to 400 °C	ESC2-R20J AC100-240 0-400	–	
		Resistance thermometer	Platinum resistance thermometer	-50 to 50 °C	ESC2-R20P-D AC100-240 -50-50	–
				0 to 50 °C	ESC2-R20P-D AC100-240 0-50	–
				0 to 100 °C	ESC2-R20P-D AC100-240 0-100	–
				0 to 200 °C	ESC2-R20P-D AC100-240 0-200	–
				0 to 300 °C	ESC2-R20P-D AC100-240 0-300	–
	0 to 400 °C			ESC2-R20P-D AC100-240 0-400	–	
	Thermistor	THE (replaceable element)	0 to 100 °C	ESC2-R20G AC100-240 0-100	–	
			100 to 200 °C	ESC2-R20G AC100-240 100-200	–	
			150 to 300 °C	ESC2-R20G AC100-240 150-300	–	

Input ranges	Thermocouple *1		Platinum resistance thermometer	Thermistor *2
	K (CA) chromel vs. alumel	J (IC) iron vs. constantan	Pt100	THE
°C	0 to 200 (5), 0 to 400 (10), 0 to 600 (20), 0 to 800 (20), 0 to 1,000 (25), 0 to 1,200 (25)	0 to 200 (5), 0 to 300 (10), 0 to 400 (10)	-50 to 50 (2), 0 to 50 (1), 0 to 100 (2), 0 to 200 (5), 0 to 300 (10), 0 to 400 (10)	0 to 100 (2) (6 kΩ at 0°C), 100 to 200 (2) (550 Ω @ 200°C), 150 to 300 (2) (4 kΩ @ 200°C)

*1 Values in () are the minimum unit.

*2 Values in () are the thermistor resistive value.

Accessories

Functions	Order code
Front connecting socket with finger protection	P2CF-08-E
Back connecting socket (for flush mounting)	P3G-08
Finger protection cover (for P3G-08)	Y92A-48G
Protective front cover (IP66)	Y92A-48B

Specifications

Supply voltage	100 to 240 VAC, 50/60 Hz
Thermocouple input type	K, J (with sensor break detection)
RTD input type	Pt100, THE
Control mode	ON/OFF or P control
Setting method	analog setting
Output	Relay, SPDT, 3 A at 250 VAC
Life expectancy	Electrical: 100,000 operations min.
Setting accuracy	±2% FS max.
Hysteresis	Approx. 0.5% FS (fixed)
Proportional band	3% FS (fixed)
Reset range	5 ±1% FS min.
Control period	20 s
IP Rating front panel	IP40 (IP66 cover available)
IP rating terminals	IP00
Ambient temperature	-10 to 55°C
Size in mm (HxWxD)	48×48×96

The easy way to perfect temperature control

This multi-range 1/16 DIN controller with alarm function offers field-selectable PID control or ON/OFF control. The large, single display shows process value, direction of deviation from set point, output and alarm status.

- All setting fields configurable with switches
- Multi-input (Thermocouple/Pt100)
- Clearly visible 3.5 digit display with character height of 13.5 mm
- Control output: relay, voltage (for driving SSR)
- ON/OFF or 2-PID control with auto-tuning and self-tuning



Ordering information

Size in mm	Supply voltage	Number of alarm points	Control output	Order code
1/16 DIN 48H×48W×78D	100 to 240 VAC	1	Relay	E5CSV-R1T-500
			Voltage (for driving SSR)	E5CSV-Q1T-500
	24 VAC/VDC	1	Relay	E5CSV-R1TD-500
			Voltage (for driving SSR)	E5CSV-Q1TD-500

Note: Other models are available on request.

Accessories

Type	Order code
Hard protective cover	Y92A-48B

Specifications

Item	E5CSV	
Supply voltage	100 to 240 VAC, 50/60 Hz or 24 VAC/VDC (depending on model)	
Operating voltage range	85 to 110% of rated supply voltage	
Power consumption	5 VA	
Sensor input	Multi-input (thermocouple/platinum resistance thermometer): K, J, L, T, U, N, R, Pt100, JPt100	
Control output	Relay output	SPST-NO, 250 VAC, 3 A (resistive load)
	Voltage output (for driving SSR)	12 VDC, 21 mA (with short-circuit protection circuit)
Control method	ON/OFF or 2-PID (with auto-tune and self-tune)	
Alarm output	SPST-NO, 250 VAC, 1 A (resistive load)	
Setting method	Digital setting using front panel keys (functionality set-up with DIP switch)	
Indication	7-segment digital display (character height: 13.5 mm) and deviation indicators	
Ambient temperature	-10 to 55°C (with no condensation or icing)	
Setting/indication accuracy	±0.5% of indication value or ±1 °C, whichever is greater ±1 digit max.	
Hysteresis (for ON/OFF control)	0.2% FS (0.1% FS for multi-input (thermocouple/platinum resistance thermometer) models)	
Proportional band (P)	1 to 999°C (automatic adjustment using AT/ST)	
Integral time (I)	0 to 1,999 s (automatic adjustment using AT/ST)	
Derivative time (D)	0 to 1,999 s (automatic adjustment using AT/ST)	
Control period	2/20 s	
Sampling period	500 ms	
Electrical life expectancy	100,000 operations min. (relay output models)	
Weight	Approx. 120 g (controller only)	
Degree of protection	Front panel: Equivalent to IP66; rear case: IP20; terminals: IP00	
Memory protection	EEPROM (non-volatile memory) (number of writes: 1,000,000)	
Size in mm (H×W×D)	48×48×78	



Best price performance ratio and user-friendliness combined with ergonomic design

Thanks to a clear and easy-to-use menu structure, the E5CB General Purpose Controller is extremely user friendly. But despite very simply layered, the E5CB still offers a high performance inherited from the E5CN series. Even if no power is available, the E5CB can be powered and parameterized with only a few clicks using the free ThermoMini remote software.

- Set up your configuration in only 30 s
- Large display (16.2 mm) legible up to 5 m
- Built to last and regulate precisely with Omron unique 2-PID algorithm
- Easy and quick remote parameterization via free ThermoMini software
- Speed up your application with a sampling period time of 250 ms

Ordering information

Size	Power supply voltage	Input type	Alarm output	Control output	Order code
E5CB 48 × 48 mm	100 to 240 VAC	Thermocouple	1	Relay output	E5CB-R1TC
		Platinum resistance thermometer		E5CB-R1P	
		Thermocouple		Voltage output (for driving SSR)	E5CB-Q1TC
		Platinum resistance thermometer		E5CB-Q1P	
	24 VAC/VDC	Thermocouple		Relay output	E5CB-R1TCD
		Platinum resistance thermometer		E5CB-R1PD	
		Thermocouple		Voltage output (for driving SSR)	E5CB-Q1TCD
		Platinum resistance thermometer		E5CB-Q1PD	

Accessories

Option	Order code
USB-Serial conversion cable	E58-C1FQ2



Software

Description	Features
ThermoMini	Freeware/Parameter copying and cloning tool Parameter export (.csv), self-expressing

Specifications

Item	E5CB
Power supply voltage	100 to 240 VAC 50/60 Hz, 24 VAC 50/60 Hz, or 24 VDC
Operating voltage range	85% to 110% of rated supply voltage
Power consumption	Approx. 3.5 VA (100 to 240 VAC) Approx. 3.5 VA (24 VAC) Approx. 2.5 W (24 VDC)
Sensor input	Models with thermocouple inputs Thermocouple: K, J, T, R, or S (JIS C 1602-1995, IEC60584-1) Models with platinum resistance thermometer inputs Platinum resistance thermometer: Pt100 (JIS C 1604-1997, IEC60751)
Control output	SPST-NO, 250 VAC, 3 A (resistive load), electrical life: 100,000 operations, minimum applicable load: 5 V, 10 mA Output voltage: 12 VDC +25%/–15% (PNP), max. load current: 21 mA, with short-circuit protection circuit
Alarm output	SPST-NO, 250 VAC, 1 A (resistive load), electrical life: 100,000 operations, minimum load: 5 V, 10 mA
Control method	ON/OFF control or 2-PID control (with auto-tuning)
Setting method	Digital setting using front panel keys
Indication method	7-segment digital display and individual indicators Character height: 16.2 mm (PV)
Other functions	Temperature input shift, run/stop, protection functions, etc.
Ambient operating temperature	–10 to 55°C (with no condensation or icing)/With a three-year guarantee: –10 to 50°C
Ambient operating humidity	25% to 85%
Storage temperature	–25 to 65°C (with no condensation or icing)
Size in mm (H × W × D)	48×48×65

Note: Other models (E5C_L/E5EW) with similar features but without USB communication are only available for "Emerging Countries". Please ask you local Sales representative for further information.

High performance & simplicity

The next generation E5_C temperature controller is setting a new global standard in terms of precision and user-friendly design. Best control performance, easy set-up and outstanding visibility of the white IP66 LCD display have been integrated into a spacing-saving housing with only 60 mm of depth.

- Fast and precise regulation: 50 ms sampling loop period time
- Easy to set up, and operate intuitively via CX-Thermo without power supply
- Best contrasty display using white LCD technology which is visible from a far distance and from any angle
- Useful alarm and diagnosis functions for secure operation
- Practical timer and logic operation functions eliminating the need of a PLC



Ordering information

E5CC (all models 3 auxiliary outputs)

Output	Option No.	Fixed option	Order code	
			110-240 VAC	24 VAC/VDC
Out1: Relay Out2: non	–	–	E5CC-RX3A5M-000	E5CC-RX3D5M-000
	001	Event input 2, Heater burnout SSR defect detection	E5CC-RX3A5M-001	E5CC-RX3D5M-001
	003	Communication 3-phase heater alarm	E5CC-RX3A5M-003	E5CC-RX3D5M-003
	005	Event input 4	E5CC-RX3A5M-005	E5CC-RX3D5M-005
	006	Event input 2, Transfer output	E5CC-RX3A5M-006	E5CC-RX3D5M-006
	007	Event input 2, Remote SP	E5CC-RX3A5M-007	E5CC-RX3D5M-007
Out1: Voltage (pulse) Out2: non	–	–	E5CC-QX3A5M-000	E5CC-QX3D5M-000
	001	Event input 2, Heater burnout SSR defect detection	E5CC-QX3A5M-001	E5CC-QX3D5M-001
	003	Communication 3-phase heater alarm	E5CC-QX3A5M-003	E5CC-QX3D5M-003
	005	Event input 4	E5CC-QX3A5M-005	E5CC-QX3D5M-005
	006	Event input 2, Transfer output	E5CC-QX3A5M-006	E5CC-QX3D5M-006
	007	Event input 2, Remote SP	E5CC-QX3A5M-007	E5CC-QX3D5M-007
Out1: Voltage (pulse) Out2: Voltage (pulse)	–	–	E5CC-QQ3A5M-000	E5CC-QQ3D5M-000
	001	Event input 2, Heater burnout SSR defect detection	E5CC-QQ3A5M-001	E5CC-QQ3D5M-001
	003	Communication 3-phase heater alarm	E5CC-QQ3A5M-003	E5CC-QQ3D5M-003
	005	Event input 4	E5CC-QQ3A5M-005	E5CC-QQ3D5M-005
	006	Event input 2, Transfer output	E5CC-QQ3A5M-006	E5CC-QQ3D5M-006
	007	Event input 2, Remote SP	E5CC-QQ3A5M-007	E5CC-QQ3D5M-007
Out1: Linear current Out2: non	–	–	E5CC-CX3A5M-000	E5CC-CX3D5M-000
	004	Event input 2, Communication	E5CC-CX3A5M-004	E5CC-CX3D5M-004
	005	Event input 4	E5CC-CX3A5M-005	E5CC-CX3D5M-005
	006	Event input 2, Transfer output	E5CC-CX3A5M-006	E5CC-CX3D5M-006
	007	Event input 2, Remote SP	E5CC-CX3A5M-007	E5CC-CX3D5M-007
Out1: Linear current Out2: Voltage (pulse)	–	–	E5CC-CQ3A5M-000	E5CC-CQ3D5M-000
	001	Event input 2, Heater burnout SSR defect detection	E5CC-CQ3A5M-001	E5CC-CQ3D5M-001
	003	Communication 3-phase heater alarm	E5CC-CQ3A5M-003	E5CC-CQ3D5M-003
	005	Event input 4	E5CC-CQ3A5M-005	E5CC-CQ3D5M-005
	006	Event input 2, Transfer output	E5CC-CQ3A5M-006	E5CC-CQ3D5M-006
	007	Event input 2, Remote SP	E5CC-CQ3A5M-007	E5CC-CQ3D5M-007

Note: As well as these models other models are available on request. Please contact the local sales office for special requests.

E5EC/E5AC (all models 4 auxiliary outputs)

Output	Option No	Fixed option	Order code	
			110-240 VAC	24 VAC/VDC
Out1: Relay Out2: non	–	–	E5_C-RX4A5M-000	E5_C-RX4D5M-000
	009	Event input 2, Communication 3-phase heater alarm	E5_C-RX4A5M-009	E5_C-RX4D5M-009
	010	Event input 4, Heater burnout SSR defect detection	E5_C-RX4A5M-010	E5_C-RX4D5M-010
	011	Event input 6, Remote SP Heater burnout SSR defect detection, Transfer output	E5_C-RX4A5M-011	E5_C-RX4D5M-011
Out1: Voltage (pulse) Out2: non	–	–	E5_C-QX4A5M-000	E5_C-QX4D5M-000
	009	Event input 2, Communication 3-phase heater alarm	E5_C-QX4A5M-009	E5_C-QX4D5M-009
	010	Event input 4, Heater burnout SSR defect detection	E5_C-QX4A5M-010	E5_C-QX4D5M-010
	011	Event input 6, Remote SP Heater burnout SSR defect detection, Transfer output	E5_C-QX4A5M-011	E5_C-QX4D5M-011
Out1: Relay Out2: Relay	–	–	E5_C-RR4A5M-000	E5_C-RR4D5M-000
	009	Event input 2, Communication 3-phase heater alarm	E5_C-RR4A5M-009	E5_C-RR4D5M-009
	010	Event input 4, Heater burnout SSR defect detection	E5_C-RR4A5M-010	E5_C-RR4D5M-010
	011	Event input 6, Remote SP Heater burnout SSR defect detection, Transfer output	E5_C-RR4A5M-011	E5_C-RR4D5M-011
Out1: Voltage (pulse) Out2: Voltage (pulse)	–	–	E5_C-QQ4A5M-000	E5_C-QQ4D5M-000
	009	Event input 2, Communication 3-phase heater alarm	E5_C-QQ4A5M-009	E5_C-QQ4D5M-009
	010	Event input 4, Heater burnout SSR defect detection	E5_C-QQ4A5M-010	E5_C-QQ4D5M-010
	011	Event input 6, Remote SP Heater burnout SSR defect detection, Transfer output	E5_C-QQ4A5M-011	E5_C-QQ4D5M-011
Out1: Voltage (pulse) Out2: Relay	–	–	E5_C-QR4A5M-000	E5_C-QR4D5M-000
	009	Event input 2, Communication 3-phase heater alarm	E5_C-QR4A5M-009	E5_C-QR4D5M-009
	010	Event input 4, Heater burnout SSR defect detection	E5_C-QR4A5M-010	E5_C-QR4D5M-010
	011	Event input 6, Remote SP Heater burnout SSR defect detection, Transfer output	E5_C-QR4A5M-011	E5_C-QR4D5M-011
Out1: Linear current Out2: non	–	–	E5_C-CX4A5M-000	E5_C-CX4D5M-000
	004	Event input 2, Communication	E5_C-CX4A5M-004	E5_C-CX4D5M-004
	005	Event input 4	E5_C-CX4A5M-005	E5_C-CX4D5M-005
	013	Event input 6, Remote SP, Transfer output	E5_C-CX4A5M-013	E5_C-CX4D5M-013
	014	Event input 4, Communication Remote SP, Transfer output	E5_C-CX4A5M-014	E5_C-CX4D5M-014
Out1: Linear current Out2: Linear current	–	–	E5_C-CC4A5M-000	E5_C-CC4D5M-000
	004	Event input 2, Communication	E5_C-CC4A5M-004	E5_C-CC4D5M-004
	005	Event input 4	E5_C-CC4A5M-005	E5_C-CC4D5M-005
	013	Event input 6, Remote SP Transfer output	E5_C-CC4A5M-013	E5_C-CC4D5M-013
	014	Event input 4, Communication Remote SP, Transfer output	E5_C-CC4A5M-014	E5_C-CC4D5M-014
Out1: Linear current Out2: Voltage (pulse)	–	–	E5_C-CQ4A5M-000	E5_C-CQ4D5M-000
	009	Event input 2, Communication 3-phase heater alarm	E5_C-CQ4A5M-009	E5_C-CQ4D5M-009
	010	Event input 4, Heater burnout SSR defect detection	E5_C-CQ4A5M-010	E5_C-CQ4D5M-010
	011	Event input 6, Remote SP Heater burnout SSR defect detection, Transfer output	E5_C-CQ4A5M-011	E5_C-CQ4D5M-011
Out1: Relay* ¹ Out2: Relay* ¹	–	–	E5_C-PR4A5M-000	E5_C-PR4D5M-000
	004	Event input 2, Communication	E5_C-PR4A5M-004	E5_C-PR4D5M-004
	014	Event input 4, Communication Remote SP, Transfer output	E5_C-PR4A5M-014	E5_C-PR4D5M-014

*¹ Position proportional control model

E5GC (models with 0, 1 or 2 auxiliary outputs)

Output	Terminal type	Option No	Fixed option	Order code			
				110-240 VAC	24 VAC/VDC		
Out 1: Relay	Screw terminals (with cover)	–	–	E5GC-RX0A6M-000	E5GC-RX0D6M-000		
				E5GC-RX1A6M-000	E5GC-RX106M-000		
				E5GC-RX2A6M-000	E5GC-RX206M-000		
		015	Communication	E5GC-RX1A6M-015	E5GC-RX106M-015		
				E5GC-RX2A6M-015	E5GC-RX206M-015		
		016	Event input 1	E5GC-RX2A6M-016	E5GC-RX206M-016		
			023	Heater Burnout SSR defect detection	E5GC-RX2A6M-023	E5GC-RX206M-023	
			024	Event input 2	E5GC-RX1A6M-024	E5GC-RX106M-024	
	Screwless clamp terminal	–	–		E5GC-RX0ACM-000	E5GC-RX0DCM-000	
					E5GC-RX1ACM-000	E5GC-RX1DCM-000	
					E5GC-RX2ACM-000	E5GC-RX2DCM-000	
		015	Communication		E5GC-RX1ACM-015	E5GC-RX1DCM-015	
					E5GC-RX2ACM-015	E5GC-RX2DCM-015	
		016	Event input 1		E5GC-RX2ACM-016	E5GC-RX2DCM-016	
				023	Heater Burnout SSR defect detection	E5GC-RX2ACM-023	E5GC-RX2DCM-023
				024	Event input 2	E5GC-RX1ACM-024	E5GC-RX1DCM-024
Out 1: Voltage (pulse)	Screw terminals (with cover)	–	–	E5GC-OX0A6M-000	E5GC-OX0D6M-000		
				E5GC-OX1A6M-000	E5GC-OX106M-000		
				E5GC-OX2A6M-000	E5GC-OX206M-000		
		015	Communication	E5GC-OX1A6M-015	E5GC-OX106M-015		
				E5GC-OX2A6M-015	E5GC-OX206M-015		
		016	Event input 1	E5GC-OX2A6M-016	E5GC-OX206M-016		
			023	Heater Burnout SSR defect detection	E5GC-OX2A6M-023	E5GC-OX206M-023	
			024	Event input 2	E5GC-OX1A6M-024	E5GC-OX106M-024	
	Screwless clamp terminal	–	–		E5GC-OX0ACM-000	E5GC-OX0DCM-000	
					E5GC-OX1ACM-000	E5GC-OX1DCM-000	
					E5GC-OX2ACM-000	E5GC-OX2DCM-000	
		015	Communication		E5GC-OX1ACM-015	E5GC-OX1DCM-015	
					E5GC-OX2ACM-015	E5GC-OX2DCM-015	
		016	Event input 1		E5GC-OX2ACM-016	E5GC-OX2DCM-016	
				023	Heater Burnout SSR defect detection	E5GC-OX2ACM-023	E5GC-OX2DCM-023
				024	Event input 2	E5GC-OX1ACM-024	E5GC-OX1DCM-024
Out 1: Linear current	Screw terminals (with cover)	–	–	E5GC-CX0A6M-000	E5GC-CX0D6M-000		
				E5GC-CX1A6M-000	E5GC-CX106M-000		
				E5GC-CX2A6M-000	E5GC-CX206M-000		
		015	Communication	E5GC-CX1A6M-015	E5GC-CX106M-015		
				E5GC-CX2A6M-015	E5GC-CX206M-015		
		016	Event input 1	E5GC-CX2A6M-016	E5GC-CX206M-016		
			024	Event input 2	E5GC-CX1A6M-024	E5GC-CX106M-024	
	Screwless clamp terminal	–	–		E5GC-CX0ACM-000	E5GC-CX0DCM-000	
					E5GC-CX1ACM-000	E5GC-CX10CM-000	
					E5GC-CX2ACM-000	E5GC-CX20CM-000	
		015	Communication		E5GC-CX1ACM-015	E5GC-CX10CM-015	
					E5GC-CX2ACM-015	E5GC-CX20CM-015	
		016	Event input 1		E5GC-CX2ACM-016	E5GC-CX20CM-016	
				024	Event input 2	E5GC-CX1ACM-024	E5GC-CX10CM-024

E5DC (models with 0 or 2 auxiliary outputs)

Output	Option No	Fixed option	Order code	
			110-240 VAC	24 VAC/VDC
Out1: Relay	–	–	E5DC-RX2ASM-000	E5DC-RX2DSM-000
	002	Communication, Heater Burnout SSR defect detection	E5DC-RX2ASM-002	E5DC-RX2DSM-002
	015	Communication	E5DC-RX0ASM-015 ^{*1}	E5DC-RX0DSM-015 ^{*1}
	017	Event Input 1, Heater Burnout SSR defect detection	E5DC-RX2ASM-017	E5DC-RX2DSM-017
Out1: Voltage (pulse)	–	–	E5DC-QX2ASM-000	E5DC-QX2DSM-000
	002	Communication, Heater Burnout SSR defect detection	E5DC-QX2ASM-002	E5DC-QX2DSM-002
	015	Communication	E5DC-QX0ASM-015 ^{*1}	E5DC-QX0DSM-015 ^{*1}
	017	Event Input 1, Heater Burnout SSR defect detection	E5DC-QX2ASM-017	E5DC-QX2DSM-017
Out1: Linear current	–	–	E5DC-CX2ASM-000	E5DC-CX2DSM-000
	015	Communication	E5DC-CX0ASM-015 ^{*1}	E5DC-CX0DSM-015 ^{*1}
	015	Communication	E5DC-CX2ASM-015	E5DC-CX2DSM-015
	016	Event Input 1	E5DC-CX2ASM-016	E5DC-CX2DSM-016

*1 Auxiliary outputs are not possible for these models.

E5_C optional tools

Option	Order code
USB based configuration cable	E58-CIFQ2, E58-CIFQ2-E (for E5AC, E5DC, E5EC and E5GC)
PC based configuration and tuning software	EST2-2C-MV4

Specifications

E5CC/E5EC/E5AC

Item	E5CC	E5EC	E5AC
Power supply voltage	A in model number: 100 to 240 VAC, 50/60 Hz D in model number: 24 VAC, 50/60 Hz; 24 VDC		
Operating voltage range	85% to 110% of rated supply voltage		
Power consumption	6.5 VA max. at 100 to 240 VAC, and 4.1 VA max. at 24 VAC or 2.3 W max. at 24 VDC	8.3 VA max. at 100 to 240 VAC, and 5.5 VA max. at 24 VAC or 3.2 W max. at 24 VDC	9.0 VA max. at 100 to 240 VAC, and 5.6 VA max. at 24 VAC or 3.4 W max. at 24 VDC
Sensor input	<ul style="list-style-type: none"> Temperature inputs Thermocouple: K, J, T, E, L, U, N, R, S, B, W, or PL II Platinum resistance thermometer: Pt100 or JPt100 Infrared temperature sensor (ES1B): 10 to 70°C, 60 to 120°C, 115 to 165°C, or 140 to 260°C Analog inputs Current input (mA): 4 to 20 or 0 to 20 Voltage input (V): 1 to 5, 0 to 5, or 0 to 10 		
Input impedance	Current input: 150 Ω max., Voltage input: 1 MΩ min. (Use a 1:1 connection when connecting the ES2-HB/THB.)		
Control method	ON/OFF control or 2-PID control (with auto-tuning)		
Indication accuracy	Thermocouple input: (±0.3% of indicated value or ±1°C, whichever is greater) ±1 digit max. Platinum resistance thermometer input: (±0.2% of indicated value or ±0.8°C, whichever is greater) ±1 digit max. Analog input: ±0.2% FS ±1 digit max. CT input: ±5% FS ±1 digit max.	Thermocouple input: (±0.3% of indicated value or ±1°C, whichever is greater) ±1 digit max. Platinum resistance thermometer input: (±0.2% of indicated value or ±0.8°C, whichever is greater) ±1 digit max. Analog input: ±0.2% FS ±1 digit max. CT input: ±5% FS ±1 digit max.	Thermocouple input: (±0.3% of indicated value or ±1°C, whichever is greater) ±1 digit max. Platinum resistance thermometer input: (±0.2% of indicated value or ±0.8°C, whichever is greater) ±1 digit max. Analog input: ±0.2% FS ±1 digit max. CT input: ±5% FS ±1 digit max.
Auto-Tuning	Yes, 40%/100% MV output limit selection. When using Heat/Cool: Automatic cool gain adjustment		
Self-Tuning	Yes		
Control outputs	Relay output	SPST-NO, 250 VAC, 3 A (resistive load), electrical life: 100,000 operations, minimum applicable load: 5 V, 10 mA	SPST-NO, 250 VAC, 5 A (resistive load), electrical life: 100,000 operations, minimum applicable load: 5 V, 10 mA
	Voltage output (for driving SSR)	Output voltage: 12 VDC ±20% (PNP), max. load current: 21 mA, with short-circuit protection circuit	Output voltage: 12 VDC ±20% (PNP), max. load current: 40 mA, with short-circuit protection circuit (The maximum load current is 21 mA for models with two control outputs.)
	Linear current output	4 to 20 mA DC/0 to 20 mA DC, load: 500 Ω max., resolution: approx. 10,000	
Auxiliary outputs	Number of outputs	3	4
	Output specifications	N.O. relay outputs, 250 VAC, Models with 3 outputs: 2 A (resistive load), electrical life: 100,000 operations, minimum applicable load: 5 V, 10 mA	N.O. relay outputs, 250 VAC, Models with 4 outputs: 2 A (resistive load), electrical life: 100,000 operations, minimum applicable load: 5 V, 10 mA
Event inputs	Number of inputs	2 or 4 or 6 max (depends on the model)	
	External contact input specifications	Contact input: ON: 1 kΩ max., OFF: 100 kΩ min. Non-contact input: ON: Residual voltage: 1.5 V max., OFF: Leakage current: 0.1 mA max. Current flow: approx. 7 mA per contact	
Setting method	Digital setting using front panel keys or via Remote Software CX-Thermo V4.5		
Indication method	11-segment digital display and individual indicators		
Multi SP	Up to eight set points (SP0 to SP7) can be saved and selected using event inputs, key operations, or serial communications.		
Other functions	Manual output, heating/cooling control, loop burnout alarm, SP ramp, other alarm functions, heater burnout detection (including SSR failure detection), 40% AT, 100% AT, MV limiter, input digital filter, self-tuning, temperature input shift, run/stop, protection functions, extraction of square root, MV change rate limit, logic operations, PV/SV status display, simple program, automatic cooling coefficient adjustment		
Ambient operating temperature	-10 to 55°C (with no condensation or icing)		
Ambient operating humidity	25% to 85%		
Storage temperature	-25 to 65°C (with no condensation or icing)		
Degree of protection	Front panel: IP66, Rear case: IP20, Terminals: IP00		
Sampling period	50 ms		
Size in mm (H×W×D)	48×48×64	48×96×64	96×96×64

E5GC

Item	E5GC	
Power supply voltage	A in model number: 100 to 240 VAC, 50/60 Hz D in model number: 24 VAC, 50/60 Hz; 24 VDC	
Sensor input	<ul style="list-style-type: none"> Temperature input Thermocouple: K, J, T, E, L, U, N, R, S, B, W, or PL II Platinum resistance thermometer: Pt100 or JPt100 Infrared temperature sensor (ES1B): 10 to 70°C, 60 to 120°C, 115 to 165°C, or 140 to 260°C Analog input Current input: 4 to 20 mA or 0 to 20 mA Voltage input: 1 to 5 V, 0 to 5 V, or 0 to 10 V 	
Control method	ON/OFF control or 2-PID control (with auto-tuning)	
Control output	Relay output	SPST-NO, 250 VAC, 2 A (resistive load), electrical life: 100,000 operations, minimum applicable load: 5 V, 10 mA (reference value)
	Voltage output (for driving SSR)	Output voltage 12 VDC \pm 20% (PNP), max. Load current: 21 mA, with short-circuit protection circuit
	Linear current output	4 to 20 mA DC/0 to 20 mA DC, load: 500 Ω max., resolution: Approx. 10,000
Auxiliary output	Number of outputs	1 or 2 (depends on model)
	Output specifications	SPST-NO relay outputs, 250 VAC, 2 A (resistive load), Electrical life: 100,000 operations, Minimum applicable load: 10 mA at 5 V (reference value)
Indication method	11-segment digital displays and individual indicators Character height: PV: 10.5 mm, SV: 5.0 mm	
Multi SP	Up to eight set points (SP0 to SP7) can be saved and selected using the event inputs, key operations, or serial communications.*1	
Other functions	Manual output, heating/cooling control, loop burnout alarm, SP ramp, other alarm functions, heater burnout (HB) alarm (including SSR failure (HS) alarm), 40% AT, 100% AT, MV limiter, input digital filter, self tuning, robust tuning, PV input shift, run/stop, protection functions, extraction of square root, MV change rate limit, logic operations, temperature status display, simple programming, moving average of input value, display brightness setting, simple transfer output, and work bit message.*2	
Size in mm (H×W×D)	24×48×93	

*1 Only four set points are selectable for event inputs.

*2 Simple transfer output and work bit message are only for E5GC.

E5DC

Item	E5DC	
Power supply voltage	A in model number: 100 to 240 VAC, 50/60 Hz D in model number: 24 VAC, 50/60 Hz; 24 VDC	
Operating voltage range	85% to 110% of rated supply voltage	
Power consumption	4.9 VA max. at 100 to 240 VAC, and 2.8 VA max. at 24 VDC or 1.5 W max. at 24 VDC	
Sensor input	<ul style="list-style-type: none"> Temperature inputs Thermocouple: K, J, T, E, L, U, N, R, S, B, W, or PL II Platinum resistance thermometer: Pt100 or JPt100 Infrared temperature sensor (ES1B): 10 to 70°C, 60 to 120°C, 115 to 165°C, or 140 to 260°C Analog inputs Current input (mA): 4 to 20 or 0 to 20 Voltage input (V): 1 to 5, 0 to 5, or 0 to 10 	
Input impedance	Current input: 150 Ω max., Voltage input: 1 M Ω min. (Use a 1:1 connection when connecting the ES2-HB/THB.)	
Control method	ON/OFF control or 2-PID control (with auto-tuning)	
Indication accuracy	Thermocouple input: (\pm 0.3% of PV or \pm 1°C, whichever is greater) \pm 1 digit max. Platinum resistance thermometer input: (\pm 0.2% of PV or \pm 0.8°C, whichever is greater) \pm 1 digit max. Analog input: \pm 0.2% FS \pm 1 digit max. CT input: \pm 5% FS \pm 1 digit max.	
Auto-Tuning	Yes, 40%/100% MV output limit selection. When using Heat/Cool: Automatic cool gain adjustment	
Self-Tuning	Yes	
Control outputs	Relay output	SPST-NO, 250 VAC, 3 A (resistive load), electrical life: 100,000 operations, minimum applicable load: 5 V, 10 mA
	Voltage output (for driving SSR)	Output voltage: 12 VDC \pm 20% (PNP), max. load current: 20 mA, with short-circuit protection circuit
	Linear current output	4 to 20 mA DC/0 to 20 mA DC, load: 500 Ω max., resolution: approx. 10,000
Auxiliary outputs	Number of outputs	2 (depends on model)
	Output specifications	SPST-NO relay outputs: 250 VAC, 2 A (resistive load), Electrical life: 100,000 operations, minimum applicable load: 5 V, 10 mA
Event inputs	Number of inputs	1 (depends on model)
	External contact input specifications	Contact input: ON: 1 k Ω max., OFF: 100 k Ω min.
		Non-contact input: ON: Residual voltage: 1.5 V max., OFF: Leakage current: 0.1 mA max. Current flow: approx. 7 mA per contact
Setting method	Digital setting using front panel keys	
Indication method	11-segment digital displays and individual indicators Character height: PV 8.5 mm, SV: 8.0 mm	
Multi SP	Up to eight set points (SP0 to SP7) can be saved and selected using event inputs, key operations, or serial communications.*1	
Other functions	Manual output, heating/cooling control, loop burnout alarm, SP ramp, other alarm functions, heater burnout (HB) alarm (including SSR failure (HB) alarm), 40% AT, 100% AT, MV limiter, input digital filter, self tuning, robust tuning, PV input shift, run/stop, protection functions, extraction of square root, MV change rate limit, simple calculations, temperature status display, simple programming, moving average of input value, and display brightness setting	
Ambient operating temperature	-10 to 55°C (with no condensation or icing), for 3-year warranty: -10 to 50°C (with no condensation or icing)	
Ambient operating humidity	25% to 85%	
Storage temperature	-25 to 65°C (with no condensation or icing)	
Degree of protection	Main unit: IP20, Terminal unit: IP00	
Sampling period	50 ms	
Size in mm (H×W×D)	96×22.5×85	

*1 Only two set points are selectable for event inputs.

USB communication cable E58-CIFQ2

Item	E5AC	E5CC	E5DC	E5EC	E5GC
E58-CIFQ2	■	■	■	■	■
E58-CIFQ2-E	■	-	■	■	■

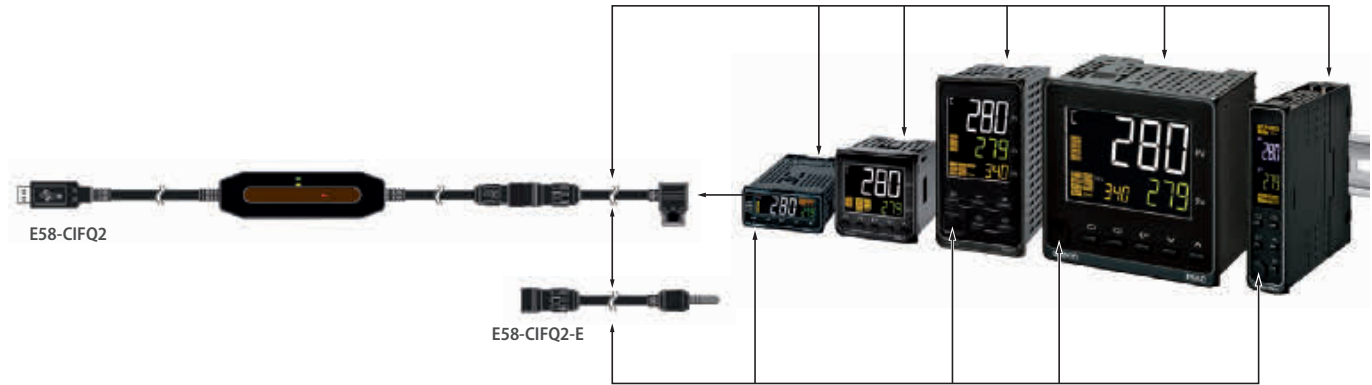

Exchange this head for
E5AC/E5DC/E5EC/E5GC adaptation.

Compact and intelligent Ramp/Soak controller



The E5_C-T Ramp/Soak temperature controllers expands the E5_C family to handle process applications. Capable of addressing up to 6 event inputs and up to 4 auxiliary outputs all in a compact 60 mm (depth) housing, makes this controller series one of Omron's most powerful and versatile temperature controllers.

- Set up to 8 programs with 32 segments totaling 256 program segments simply via CX-Thermo software.
- The three-level display is visible simultaneously so each process status can be easily identified.
- "Segment Jump" allows users to move directly to the specified segment reducing programming time and increase production throughput.

Ordering information

E5CC-T

Input	Output	Alarms	HB ^{*1} alarm & SSR ^{*2} defect detection	Comm. (RS-485)	Event Input	Transfer output	Order code		
							100 to 240 VAC	24VAC/VDC	
Temperature sensor/ analog	Out 1: Relay Out 2: None	3	–	–	–	–	E5CC-TRX3A5M-000	E5CC-TRX3D5M-000	
			1	–	2	–	E5CC-TRX3A5M-001	E5CC-TRX3D5M-001	
			2 ^{*3}	1	–	–	E5CC-TRX3A5M-003	E5CC-TRX3D5M-003	
			–	–	2	–	E5CC-TRX3A5M-004	E5CC-TRX3D5M-004	
			–	–	4	–	E5CC-TRX3A5M-005	E5CC-TRX3D5M-005	
			–	–	2	–	E5CC-TRX3A5M-006	E5CC-TRX3D5M-006	
	Out 1: Voltage (pulse) Out 2: None	–	–	1	–	–	–	E5CC-TQX3A5M-000	E5CC-TQX3D5M-000
				2 ^{*3}	1	–	–	E5CC-TQX3A5M-000	E5CC-TQX3D5M-000
				–	–	2	–	E5CC-TQX3A5M-003	E5CC-TQX3D5M-003
				–	–	2	–	E5CC-TQX3A5M-004	E5CC-TQX3D5M-004
				–	–	4	–	E5CC-TQX3A5M-005	E5CC-TQX3D5M-005
				–	–	2	–	E5CC-TQX3A5M-006	E5CC-TQX3D5M-006
	Out 1: Current linear Out 2: None	–	–	1	–	–	–	E5CC-TCX3A5M-000	E5CC-TCX3D5M-000
				–	–	2	–	E5CC-TCX3A5M-004	E5CC-TCX3D5M-004
				–	–	4	–	E5CC-TCX3A5M-005	E5CC-TCX3D5M-005
				–	–	2	–	E5CC-TCX3A5M-006	E5CC-TCX3D5M-006
				–	–	–	–	E5CC-TQX3A5M-000	E5CC-TQX3D5M-000
				–	–	2	–	E5CC-TQX3A5M-001	E5CC-TQX3D5M-001
	Out 1: Voltage (pulse) Out 2: Voltage (pulse)	–	–	1	–	–	–	E5CC-TQX3A5M-000	E5CC-TQX3D5M-000
				2 ^{*3}	1	–	–	E5CC-TQX3A5M-003	E5CC-TQX3D5M-003
				–	–	2	–	E5CC-TQX3A5M-004	E5CC-TQX3D5M-004
				–	–	4	–	E5CC-TQX3A5M-005	E5CC-TQX3D5M-005
				–	–	2	–	E5CC-TQX3A5M-006	E5CC-TQX3D5M-006
				–	–	–	–	E5CC-TCQ3A5M-000	E5CC-TCQ3D5M-000
Out 1: Current linear Out 2: Voltage (pulse)	–	–	1	–	–	–	E5CC-TCQ3A5M-000	E5CC-TCQ3D5M-000	
			–	–	2	–	E5CC-TCQ3A5M-004	E5CC-TCQ3D5M-004	
			–	–	4	–	E5CC-TCQ3A5M-005	E5CC-TCQ3D5M-005	
			–	–	2	–	E5CC-TCQ3A5M-006	E5CC-TCQ3D5M-006	
			–	–	–	–	E5CC-TQX3A5M-000	E5CC-TQX3D5M-000	
			–	–	2	–	E5CC-TQX3A5M-001	E5CC-TQX3D5M-001	

*1 HB = Heater burnout
 *2 SSR = Solid state relay
 *3 3-Phase heater burnout alarm

E5AC-T/E5EC-T

Input	Output	Alarms	HB ^{*1} alarm & SSR ^{*2} defect detection	Comm. (RS-485)	Event Input	Transfer output	Order code ^{*3}		
							Model: 100 to 240 VAC	Model: 24VAC/VDC	
Temperature sensor/ analog	Out 1: Relay Out 2: None	4	–	–	–	–	E5_C-TRX4A5M-000	E5_C-TRX4D5M-000	
			1	1	2	–	E5_C-TRX4A5M-008	E5_C-TRX4D5M-008	
			–	–	4	–	E5_C-TRX4A5M-010	E5_C-TRX4D5M-010	
			–	–	6	–	E5_C-TRX4A5M-019	E5_C-TRX4D5M-019	
	Out 1: Voltage (pulse) Out 2: None	–	–	–	–	–	–	E5_C-TQX4A5M-000	E5_C-TQX4D5M-000
				1	1	2	–	E5_C-TQX4A5M-008	E5_C-TQX4D5M-008
				–	–	4	–	E5_C-TQX4A5M-010	E5_C-TQX4D5M-010
				–	–	6	–	E5_C-TQX4A5M-019	E5_C-TQX4D5M-019
	Out 1: Current linear Out 2: None	–	–	–	–	–	–	E5_C-TCX4A5M-000	E5_C-TCX4D5M-000
				1	1	2	–	E5_C-TCX4A5M-004	E5_C-TCX4D5M-004
				–	–	4	–	E5_C-TCX4A5M-005	E5_C-TCX4D5M-005
				–	–	6	–	E5_C-TCX4A5M-021	E5_C-TCX4D5M-021
–	–	1	–	4	–	E5_C-TCX4A5M-022	E5_C-TCX4D5M-022		

*1 HB = Heater burnout
 *2 SSR = Solid state relay
 *3 Replace " _ " with "A" for E5AC or "E" for E5EC

E5AC-T/E5EC-T

Input	Output	Alarms	HB*1 alarm & SSR*2 defect detection	Comm. (RS-485)	Event Input	Transfer output	Order code*3		
							Model: 100 to 240 VAC	Model: 24VAC/VDC	
Temperature sensor/ analog	Out 1: Current linear Out 2: Current linear	4	-	-	-	-	-	E5_C-TCC4A5M-000	E5_C-TCC4D5M-000
				1	2	-	E5_C-TCC4A5M-004	E5_C-TCC4D5M-004	
				-	4	-	E5_C-TCC4A5M-005	E5_C-TCC4D5M-005	
				-	6	Y	E5_C-TCC4A5M-021	E5_C-TCC4D5M-021	
				1	4	Y	E5_C-TCC4A5M-022	E5_C-TCC4D5M-022	
				-	-	-	E5_C-TRR4A5M-000	E5_C-TRR4D5M-000	
	Out 1: Relay Out 2: Relay			1	1	2	-	E5_C-TRR4A5M-008	E5_C-TRR4D5M-008
					-	4	-	E5_C-TRR4A5M-010	E5_C-TRR4D5M-010
					6	Y	E5_C-TRR4A5M-019	E5_C-TRR4D5M-019	
	Out 1: Voltage (pulse) Out 2: Voltage (pulse)			1	-	-	-	E5_C-TQQ4A5M-000	E5_C-TQQ4D5M-000
					1	2	-	E5_C-TQQ4A5M-008	E5_C-TQQ4D5M-008
					-	4	-	E5_C-TQQ4A5M-010	E5_C-TQQ4D5M-010
	Out 1: Voltage (pulse) Out 2: Relay			1	-	-	-	E5_C-TQR4A5M-000	E5_C-TQR4D5M-000
					1	2	-	E5_C-TQR4A5M-008	E5_C-TQR4D5M-008
					-	4	-	E5_C-TQR4A5M-010	E5_C-TQR4D5M-010
	Out 1: Current linear Out 2: Voltage (pulse)			1	-	-	-	E5_C-TCQ4A5M-000	E5_C-TCQ4D5M-000
					1	2	-	E5_C-TCQ4A5M-008	E5_C-TCQ4D5M-008
					-	4	-	E5_C-TCQ4A5M-010	E5_C-TCQ4D5M-010
	Out 1: Relay Out 2: Relay (Valve control)			1	-	-	-	E5_C-TPR4A5M-000	E5_C-TPR4D5M-000
					1	2	-	E5_C-TPR4A5M-004	E5_C-TPR4D5M-004
					-	4	Y	E5_C-TPR4A5M-022	E5_C-TPR4D5M-022

*1 HB = Heater burnout

*2 SSR = Solid state relay

*3 Replace “_” with “A” for E5AC or “E” for E5EC

Specifications

E5CC-T/E5AC-T/E5EC-T

	E5CC-T	E5EC-T	E5AC-T
Sizes in mm (W x H x D)	48x48x60	48x96x60	96x96x60
Supply voltage	100 to 240 VAC 50/60Hz or 24 VAC/VDC		
Sensor input	Temperature input Thermocouple: K, J, T, E, L, U, N, R, S, B, W, or PL II Platinum resistance thermometer: Pt100 or JPt100 Infrared temperature sensor (E51B): 10 to 70°C, 60 to 120°C, 115 to 165°C, or 140 to 260°C Analog input Current input: 4 to 20 mA or 0 to 20 mA Voltage input: 1 to 5 V, 0 to 5 V, or 0 to 10 V		
Control mode	2-PID control (with auto-tuning) or ON/OFF control		
Accuracy	Thermocouple: (±0.3% of indication value or ±1°C, whichever is greater) ±1 digit max. /Platinum resistance thermometer: (±0.2% of indication value or ±0.8°C, whichever is greater) ±1 digit max. Analog input: ±0.2% FS ±1 digit max. CT input: ±5% FS ±1 digit max. Potentiometer input: ±5% FS ±1 digit max.		
Functions	Manual output, heating/cooling control, loop burnout alarm, other alarm functions, heater burnout (HB) alarm (including SSR failure (HS) alarm), 40% AT, 100% AT, MV limiter, input digital filter, robust tuning, PV input shift, protection functions, extraction of square root, MV change rate limit, logic operations, temperature status display, moving average of input value, and display brightness setting		
Programs / segments	8/32		
PID sets	8		
Communication	RS-485 (multi-drop), CompowayF or Modbus RTU		
Event inputs	2-6		
QLP (Quick link port)	Yes, via USB and E58-CIFQ2 conversion cable		
Ambient temperature	-10 to 55 °C		
IP rating of front panel	IP66		
Sampling period time	50 ms		

E5CC-T/E5AC-T/E5EC-T series optional tools

USB PC based configuration cable	E58-CIFQ2 for E5CC-T
	E58-CIFQ2 (& E58-CIFQ2-E) for E5AC-T and E5EC-T

E5CC-T/E5AC-T/E5EC-T series software

CX-Thermo >4.62	Professional parameterization and cloning software, data-logging, Fine-Tuning, logic operations, easy setting of process steps Operation system: Microsoft Windows XP (Service Pack 3 or higher)/Vista/7/8
-----------------	---

Universal compact digital process controllers



The E5_N-H series of process controllers take the proven concept of the general purpose E5_N series to a process level. Main features of the E5_N-H series are universal inputs, process outputs and options such as transfer output, remote setpoint and set-value programmer.

- Control mode: ON/OFF or 2-PID, Valve control on EN-H/AN-H
- Control output: relay, voltage (pulse), SSR, linear current and voltage
- Power supply: 100/240 VAC or 24 VDC/VAC
- Easy PC connection for parameter cloning, setting and tuning
- Clear and intuitive set-up and operation

Ordering information

Type	Input	Output	Fixed option	Alarms	Order code	
					48x48 mm model (includes supply voltage indication)	
On-panel	Universal TC/Pt/mV mA/V	Relay output	-	3 software alarms 2 SUB outputs	E5CN-HR2M-500 AC100-240	E5CN-HR2MD-500 AC/DC24
		Voltage (pulse)			E5CN-HQ2M-500 AC100-240	E5CN-HQ2MD-500 AC/DC24
		Current output			E5CN-HC2M-500 AC100-240	E5CN-HC2MD-500 AC/DC24
		Linear voltage output			E5CN-HV2M-500 AC100-240	E5CN-HV2MD-500 AC/DC24
		Relay output	SV programmer (8 programs of 32 segments)		E5CN-HTR2M-500 AC100-240	E5CN-HTR2MD-500 AC/DC24
		Voltage (pulse)			E5CN-HTQ2M-500 AC100-240	E5CN-HTQ2MD-500 AC/DC24
		Current output			E5CN-HTC2M-500 AC100-240	E5CN-HTC2MD-500 AC/DC24
		Linear voltage output			E5CN-HTV2M-500 AC100-240	E5CN-HTV2MD-500 AC/DC24

Note: - Output and Alarm Relays: 3 A/250 VAC, electrical life: 100,000 operations
 - Output voltage (pulse): 12 V, 21 mA (ie. to drive solid state relays)
 - Linear current: 0(4) to 20 mA
 - Linear voltage output: 0 to 10 V

Accessories

E5CN-H option boards

(One slot available in each instrument)

Option				Order code
Event inputs				E53-CNBN2
Event inputs	Control output 2 Voltage (for driving SSR)			E53-CNQB2
Event inputs			Heater burnout/SSR failure/Heater overcurrent detection	E53-CNHB2
Event inputs		Transfer output		E53-CNBF2
Communications RS-232C	Control output 2 Voltage (for driving SSR)			E53-CN01N2
Communications RS-232C				E53-CNQ01N2
Communications RS-232C			Heater burnout/SSR failure/Heater overcurrent detection	E53-CN01N2
Communications RS-485				E53-CN03N2
Communications RS-485	Control output 2 Voltage (for driving SSR)			E53-CNQ03N2
Communications RS-485			Heater burnout/SSR failure/Heater overcurrent detection	E53-CN03N2
Communications RS-485			3-phase heater burnout/SSR failure/Heater overcurrent detection	E53-CNHH03N2
	Control output 2 Voltage (for driving SSR)	Transfer output		E53-CNQFN2
	Control output 2 Voltage (for driving SSR)		Heater burnout/SSR failure/Heater overcurrent detection	E53-CNQHN2
	Control output 2 Voltage (for driving SSR)		3-phase heater burnout/SSR failure/Heater overcurrent detection	E53-CNQH2N2

Control method	Auxiliary output	Control output 1/2	Heater burnout	Transfer output	Order code (includes supply voltage indication)						
					96 × 96 mm model	48 × 96 mm model					
Basic	2 alarm relays	none fitted, 2 slots none fitted, 2 slots 2 SSR output fitted 2 SSR output fitted	1-phase	4 to 20 mA output	E5AN-HAA2HBM-500 AC100-240	E5EN-HAA2HBM-500 AC100-240					
					E5AN-HAA2HBMD-500 AC/DC24	E5EN-HAA2HBMD-500 AC/DC24					
					E5AN-HSS2HBM-500 AC100-240	E5EN-HSS2HBM-500 AC100-240					
					E5AN-HSS2HBMD-500 AC/DC24	E5EN-HSS2HBMD-500 AC/DC24					
		none fitted, 2 slots none fitted, 2 slots 2 SSR output fitted 2 SSR output fitted	3-phase		E5AN-HAA2HHBFM-500 AC100-240	E5EN-HAA2HHBFM-500 AC100-240					
					E5AN-HAA2HHBFMD-500 AC/DC24	E5EN-HAA2HHBFMD-500 AC/DC24					
					E5AN-HSS2HHBFM-500 AC100-240	E5EN-HSS2HHBFM-500 AC100-240					
					E5AN-HSS2HHBFMD-500 AC/DC24	E5EN-HSS2HHBFMD-500 AC/DC24					
	3 alarm relays	none fitted, 2 slots none fitted, 2 slots 2 SSR output fitted 2 SSR output fitted	3-phase	4 to 20 mA output	E5AN-HAA3BFM-500 AC100-240	E5EN-HAA3BFM-500 AC100-240					
					E5AN-HAA3BFMD-500 AC/DC24	E5EN-HAA3BFMD-500 AC/DC24					
					E5AN-HSS3BFM-500 AC100-240	E5EN-HSS3BFM-500 AC100-240					
					E5AN-HSS3BFMD-500 AC/DC24	E5EN-HSS3BFMD-500 AC/DC24					
					Valve controller	2 alarm relays	2 relay output fitted	4 to 20 mA output	E5AN-HPRR2BM-500 AC100-240	E5EN-HPRR2BM-500 AC100-240	
									E5AN-HPRR2BMD-500 AC/DC24	E5EN-HPRR2BMD-500 AC/DC24	
SV programmer (8 programs of 32 segments)	2 alarm relays	none fitted, 2 slots	1-phase	4 to 20 mA output	E5AN-HTAA2HBM-500	E5EN-HTAA2HBM-500 AC100-240					
					E5AN-HTAA2HBMD-500	E5EN-HTAA2HBMD-500 AC/DC24					
					E5AN-HTAA2HHBFM-500	E5EN-HTAA2HHBFM-500					
					E5AN-HTAA2HHBFMD-500	E5EN-HTAA2HHBFMD-500					
	3 alarm relays	none fitted, 2 slots	3-phase		4 to 20 mA output	E5AN-HTAA3BFM-500	E5EN-HTAA3BFM-500				
						E5AN-HTAA3BFMD-500	E5EN-HTAA3BFMD-500				
						SV programmer and valve controller	2 alarm relays	2 relay output fitted	4 to 20 mA output	E5AN-HTPRR2BM-500	E5EN-HTPRR2BM-500
										E5AN-HTPRR2BMD-500	E5EN-HTPRR2BMD-500
4 to 20 mA output	4 to 20 mA output	E5AN-HTPRR2BFM-500	E5EN-HTPRR2BFM-500								
		E5AN-HTPRR2BFMD-500	E5EN-HTPRR2BFMD-500								

Note: - All E5EN-H/AN-H have 2 event inputs
- All E5EN-H/AN-H have Remote Setpoint 4 to 20 mA input

Specifications E5CN-H/EN-H/AN-H

	E5CN-H(T)	E5EN-H(T)	E5AN-H(T)
Supply voltage	100 to 240 VAC 50/60 Hz or 24 VAC, 50/60Hz; 24 VDC		
Sensor input	Thermocouple: K, J, T, E, L, U, N, R, S, B, W or PL II Platinum resistance thermometer: Pt100 or JPt100 Current input: 4 to 20 mA or 0 to 20 mA Voltage input: 1 to 5 V, 0 to 5 V or 0 to 10 V		
Control mode	ON/OFF, 2-PID and valve (PRR)		
Accuracy	Thermocouple: (± 0.1% of indicated value or ± 1°C, whichever is greater) ± digit max. Platinum resistance thermometer: (± 0.1% of indicated value or ± 0.5°C, whichever is greater) ± 1 digit max. Analog input: ± 0.1% FS ± 1 digit max.		
Auto-tuning	yes, 40% and 100% MV output limit selection. When using Heat/Cool: automatic cool gain adjustment		
Self-tuning	yes		
RS-232C/RS-422/RS-485	optional, CompoWayF or Modbus selectable		
Event input	Optional (Standard 2 event input in EN-H/AN-H)		
QLP port (USB connection PC)	yes		
Ambient temperature	-10 to 55°C		
IP Rating front panel	IP66		
Sampling period	60 ms		
Sizes*1 in mm (W × H × D)	48×48×76.5	48×96×77.2	96×96×77.2

*1 With mounted terminal cover

E5AN-H/EN-H output option boards

(2 slots available in E5_N-HAA__-500 models: SS models have 2 fixed SSR output modules)

Option	Order code
Relay	E53-RN
Voltage (pulse) PNP 12 VDC	E53-QN
Voltage (pulse) NPN 24 VDC	E53-Q3
Voltage (pulse) PNP 24 VDC	E53-Q4
Linear 4 to 20 mA	E53-C3N
Linear 0 to 20 mA	E53-C3DN
Linear 0 to 10 V	E53-V34N
Linear 0 to 5 V	E53-V35N

E5AN-H/EN-H option boards

(one slot available in each instrument)

Option	Order code
RS-232C communications (CompoWay/F/Modbus)	E53-EN01
RS-422 communications (CompoWay/F/Modbus)	E53-EN02
RS-485 communications (CompoWay/F/Modbus)	E53-EN03
Event input	E53-AKB

E5AN-H/EN-H series optional tools

Option	Order code
USB PC based configuration cable	E58-CIFQ1
PC based configuration and tuning software	CX-Thermo
	EST2-2C-MV4





Fast, accurate and equipped for application specific needs

The E5_R series provides you with high accuracy inputs (0.01°C for Pt100) and a 50 ms sample and control cycle for all four loops. Its unique Disturbance Overshoot Reduction Adjustment ensures solid, robust control.

- Easy and clear read-out thanks to bright Liquid Crystal Display
- Exceptional versatility – multi-loop control, cascade control, and valve control
- Easy integration with DeviceNet, PROFIBUS or Modbus
- SV programmer optional, 32 programs with up to 256 segments

Ordering information

Function	Loops	Input analog	Event Inputs	Number of outputs	Outputs	AUX outputs	Communication	Order code (96 × 96 mm)	
								100 to 240 VAC	24 VAC/DC
standard	1	1	2	2	QC,Q	4R	–	E5AR-Q4B AC100-240	E5AR-Q4B AC/DC24
standard	1	1	2	2	QC,Q	4R	RS-485	E5AR-Q43B-FLK AC100-240V	E5AR-Q43DB-FLK AC/DC24
standard	1	1	6	2	QC,Q	4R	RS-485	E5AR-Q43DB-FLK AC100-240V	
standard	1	1	6	4	QC,Q,C,C	4R	RS-485	E5AR-QC43DB-FLK AC100-240	E5AR-QC43DB-FLK AC/DC24
standard	max 2	2	4	2	QC,Q	4R	RS-485	E5AR-Q43DW-FLK AC100-240V	E5AR-QQ43DW-FLK AC/24
standard	max 2	2	4	4	QC,Q,QC,Q	4R	RS-485	E5AR-QQ43DW-FLK AC100-240	
standard	max 4	4	4	4	QC,Q,QC,Q	4R	RS-485	E5AR-QQ43DWW-FLK AC100-240V	E5AR-QQ43DWW-FLK AC/DC24
standard	1	1	2	2	C,C	4R	–	E5AR-C4B AC100-240	E5AR-C4B AC/DC24
standard	1	1	2	2	C,C	4R	RS-485	E5AR-C43B-FLK AC100-240V	E5AR-C43DB-FLK AC/DC24
standard	1	1	6	2	C,C	4R	RS-485	E5AR-C43DB-FLK AC100-240V	
standard	max 2	2	4	2	C,C	4R	RS-485	E5AR-C43DW-FLK AC100-240V	E5AR-CC43DWW-FLK AC/DC24
standard	max 4	4	4	4	C,C,C,C	4R	RS-485	E5AR-CC43DWW-FLK AC100-240	
valve	1	1 + pot	4	2	R,R	4R	–	E5AR-PR4DF AC100-240	E5AR-PR4DF AC/DC24
valve	1	1 + pot	4	4	R,R,QC,Q	4R	RS-485	E5AR-PRQ43DF-FLK AC100-240	E5AR-PRQ43DF-FLK AC/DC24
standard	1	1	2	2	QC,Q	4R	DeviceNet	E5AR-Q4B-DRT AC100-240V	E5AR-Q4B-DRT AC24V
standard	1	1	2	4	QC,Q,C,C	4R	DeviceNet	E5AR-QC4B-DRT AC100-240V	E5AR-QC4B-DRT AC24V
standard	max 2	2	–	4	QC,Q,QC,Q	4R	DeviceNet	E5AR-QQ4W-DRT AC100-240V	E5AR-QQ4W-DRT AC24V
standard	1	1	2	2	C,C	4R	DeviceNet	E5AR-C4B-DRT AC100-240V	E5AR-C4B-DRT AC24V
standard	max 4	4	–	4	C,C,C,C	4R	DeviceNet	E5AR-CC4WW-DRT AC100-240V	E5AR-CC4WW-DRT AC24V
valve	1	1 + pot	–	2	R,R	4R	DeviceNet	E5AR-PR4F-DRT AC100-240V	E5AR-PR4F-DRT AC24V
valve	1	1 + pot	–	4	R,R,QC,Q	4R	DeviceNet	E5AR-PRQ4F-DRT AC100-240V	E5AR-PRQ4F-DRT AC24V
SV programmer	1	1	2	2	QC,Q	4R	–	E5AR-TQ4B AC100-240	E5AR-TQ4B AC/DC24
SV programmer	1	1	2	2	C,C	4R	–	E5AR-TC4B AC100-240	E5AR-TC4B AC/DC24
SV programmer	1	1	2	2	QC,Q	4R	RS-485	E5AR-TQ43B-FLK AC100-240	E5AR-TQCE3MB-FLK AC/DC24
SV programmer	1	1	2	2	C,C	4R	RS-485	E5AR-TC43B-FLK AC100-240	
SV programmer	1	1	10	2	QC,Q	10T	RS-485	E5AR-TQE3MB-FLK AC100-240	E5AR-TQCE3MB-FLK AC/DC24
SV programmer	1	1	10	2	C,C	10T	RS-485	E5AR-TCE3MB-FLK AC100-240	
SV programmer	1	1	10	4	QC,Q,C,C	10T	RS-485	E5AR-TQCE3MB-FLK AC100-240V	E5AR-TQCE3MB-FLK AC/DC24
SV programmer	max 2	2	4	2	QC,Q	4R	RS-485	E5AR-TQ43DW-FLK AC100-240	E5AR-TQCE3MW-FLK AC/DC24
SV programmer	max 2	2	4	2	C,C	4R	RS-485	E5AR-TC43DW-FLK AC100-240	
SV programmer	max 2	2	8	4	QC,Q,QC,Q	10T	RS-485	E5AR-TQCE3MW-FLK AC100-240	E5AR-TQCE3MW-FLK AC/DC24
SV programmer	max 4	4	8	2	C,C,C,C	10T	RS-485	E5AR-TCCE3MWW-FLK AC100-240	E5AR-TCCE3MWW-FLK AC/DC24
SV programmer	max 4	4	8	4	QC,Q,QC,Q	10T	RS-485	E5AR-TQCE3MWW-FLK AC100-240	E5AR-TQCE3MWW-FLK AC/DC24
SV programmer + valve	1	1 + pot	4	2	R,R	4R	–	E5AR-TPR4DF AC100-240	E5AR-TPR4DF AC/DC24
SV programmer + valve	1	1 + pot	8	4	R,R,QC,Q	10T	RS-485	E5AR-TPRQE3MF-FLK AC100-240	E5AR-TPRQE3MF-FLK AC/DC24

- Note**
- Standard = heat and/or cool PID control, valve = valve positioning (relay up/down) (PRR)
 - max 2 = 2 loops heat and/or cool or 1 loop cascade, ratio or remote SP
 - max 4 = 4 loops heat and/or cool
 - 1, 2 or 4 = number of analog universal input 1 + pot = 1 universal and 1 slide wire feedback from valve
 - QC = voltage (pulse) or current (switch), Q = voltage (pulse), C = current, 4R = 4 two pole relay, 2T = two transistor output NPN

Function	Loops	Input analog	Event Inputs	Number of outputs	Outputs	AUX outputs	Communication	Order code (48 × 96 mm)	
								100 to 240 VAC	24 VAC/DC
standard	1	1	2	2	QC+Q	4R	–	E5ER-Q4B AC100-240	E5ER-Q4B AC/DC24
standard	1	1	2	2	QC+Q	4R	RS-485	E5ER-Q43B-FLK AC100-240V	
standard	1	1	2	4	QC+Q+C+C	4R	RS-485	E5ER-QC43B-FLK AC100-240	E5ER-QC43B-FLK AC/DC24
standard	1	1	6	2	QC+Q	2T	RS-485	E5ER-QT3DB-FLK AC100-240V	
standard	max 2	2	4	2	QC+Q	2T	RS-485	E5ER-QT3DW-FLK AC100-240	E5ER-QT3DW-FLK AC/DC24
standard	1	1	2	2	C+C	4R	–	E5ER-C4B AC100-240	E5ER-C4B AC/DC24
standard	1	1	2	2	C+C	4R	RS-485	E5ER-C43B-FLK AC100-240V	
standard	1	1	6	2	C+C	2T	RS-485	E5ER-CT3DB-FLK AC100-240V	
standard	max 2	2	4	2	C+C	2T	RS-485	E5ER-CT3DW-FLK AC100-240	E5ER-CT3DW-FLK AC/DC24
valve	1	1 + pot	4	2	R+R	2T	–	E5ER-PRTDF AC100-240	E5ER-PRTDF AC/DC24
valve	1	1 + pot	–	4	R+R+QC+Q	4R	RS-485	E5ER-PRQ43F-FLK AC100-240	E5ER-PRQ43F-FLK AC/DC24
standard	1	1	2	2	QC+Q	2T	DeviceNet	E5ER-QTB-DRT AC100-240V	E5ER-QTB-DRT AC24V
standard	max 2	2	–	2	QC+Q	2T	DeviceNet	E5ER-QTW-DRT AC100-240V	E5ER-QTW-DRT AC24V
standard	1	1	2	2	C+C	2T	DeviceNet	E5ER-CTB-DRT AC100-240V	E5ER-CTB-DRT AC24V
standard	max 2	2	–	2	C+C	2T	DeviceNet	E5ER-CTW-DRT AC100-240V	E5ER-CTW-DRT AC24V
valve	1	1 + pot	–	2	R+R	2T	DeviceNet	E5ER-PRTF-DRT AC100-240V	E5ER-PRTF-DRT AC24V
SV programmer	1	1	2	2	QC+Q	4R	–	E5ER-TQ4B AC100-240	E5ER-TQ4B AC/DC24
SV programmer	1	1	2	2	C+C	4R	–	E5ER-TC4B AC100-240	E5ER-TC4B AC/DC24
SV programmer	1	1	2	2	QC+Q	4R	RS-485	E5ER-TQC43B-FLK AC100-240	E5ER-TQC43B-FLK AC/DC24
SV programmer	max 2	2	4	2	QC+Q	2T	RS-485	E5ER-TQT3DW-FLK AC100-240	E5ER-TQT3DW-FLK AC/DC24
SV programmer	max 2	2	4	2	C+C	2T	RS-485	E5ER-TCT3DW-FLK AC100-240	E5ER-TCT3DW-FLK AC/DC24
SV programmer + valve	1	1 + pot	4	2	R+R	2T	–	E5ER-TPRTDF AC100-240	E5ER-TPRTDF AC/DC24
SV programmer + valve	1	1 + pot	–	3	R+R+QC	4R	RS-485	E5ER-TPRQ43F-FLK AC100-240	E5ER-TPRQ43F-FLK AC/DC24

- Note**
- Standard = heat and/or cool PID control, valve = valve positioning (relay up/down) (PRR)
 - max 2 = 2 loops heat and/or cool or 1 loop cascade, ratio or remote SP
 - max 4 = 4 loops heat and/or cool
 - 1, 2 or 4 = number of analog universal input 1 + pot = 1 universal and 1 slide wire feedback from valve
 - QC = voltage (pulse) or current (switch), Q = voltage (pulse), C = current, 4R = 4 two pole relay, 2T = two transistor output NPN

Accessories

Terminal covers	Order code
Terminal cover for E5AR	E53-COV14
Terminal cover for E5ER	E53-COV15

E5_R/E5_R-T optional tools

Option	Order code
PC based configuration and tuning software CX-Thermo	EST2-2C-MV4

Specifications

Item	
Thermocouple input type	K, J, T, E, L, U, N, R, S, B, W
RTD input type	Pt100
Linear input type	mA, V
Control mode	2-PID or ON/OFF control
Accuracy	±0.1% FS
Auto-tuning	yes
RS-485	optional
Event input	optional
Ambient temperature	–10 to 55°C
IP rating front panel	IP66
Sampling period	50 ms
Size in mm (H×W×D)	E5ER: 96×48×110 E5AR: 96×96×110



CelciuX° (EJ1) - Multi-Loop temperature control – Control and Connectivity

CelciuX° (EJ1) is designed to handle complex temperature profiles thanks to Omron’s unique Gradient temperature Control (GTC) algorithm and to offer easy program-less communication with Omron and third-party PLCs and HMI. Above all, CelciuX° (EJ1) incorporates all “simple to use” clever temperature control technology, like 2-PID, disturbance control and various ways of tuning.

- Interfaces to a wide range of industrial networks
- Reduced engineering due to Program-less communications, Smart Active Parts and Function Block Libraries
- Available with screw terminals and screw-less clamp terminals
- One unit handling various types of input, such as Pt, Thermocouple, mA, and V input
- Gradient Temperature Control (GTC)

Ordering information

Type	Control points	Control outputs	Auxiliary outputs	Other functions	Terminal	Order code
Basic unit	2	2 voltage (pulse)	2 transistor (NPN) ^{*1}	2 CT input ^{*2} + 2 event input	M3 screws	EJ1N-TC2A-QNHB
Basic unit	2	2 voltage (pulse)	2 transistor (NPN) ^{*1}	2 CT input ^{*2} + 2 event input	Screw-less clamp	EJ1N-TC2B-QNHB
Basic unit	2	2 current	2 transistor (NPN) ^{*1}	2 event input	M3 screws	EJ1N-TC2A-CNB
Basic unit	2	2 current	2 transistor (NPN) ^{*1}	2 event input	Screw-less clamp	EJ1N-TC2B-CNB
Basic unit	4	4 voltage (pulse)	–	–	M3 screws	EJ1N-TC4A-QQ
Basic unit	4	4 voltage (pulse)	–	–	Screw-less clamp	EJ1N-TC4B-QQ
High function unit	–	–	4 transistor (NPN)	4 event input	M3 screws	EJ1N-HFUA-NFLK
High function unit	–	–	4 transistor (NPN)	4 event input	Screw-less clamp	EJ1N-HFUB-NFLK
DeviceNet unit	–	–	–	–	Screw connector	EJ1N-HFUB-DRT
Ethernet unit ^{*3}	–	–	–	–	3 x RJ45	EJ1N-HFU-ETN
End unit ^{*4}	–	–	2 transistor (NPN)	–	M3 screws	EJ1C-EDUA-NFLK
End unit ^{*4}	–	–	2 transistor (NPN)	–	Removable Connector	EJ1C-EDUC-NFLK

^{*1} For heating/cooling control applications, the auxiliary outputs on the 2-point models are used for cooling control.

On the 4-point models, heating/cooling control can be performed for two input points only.

^{*2} When using the heater burnout alarm, purchase a Current Transformer (E54-CT1 or E54-CT3) separately.

^{*3} This unit mounts to the left of the CelciuX° (EJ1) configuration and enables PROFINET or Modbus/TCP network connection. Combine the HFU-ETN with an EDU_ -NFLK end unit to use with other devices supporting Modbus-RTU like E5_N temperature controllers and MX2 Inverters.

^{*4} An End unit is always required for connection to a Basic unit or an HFU. An HFU cannot operate without a Basic unit.

Type	Control points	Control outputs	Auxiliary outputs	Other functions	Terminal	Order code
Basic unit	2 (GTC)	2 voltage (pulse) ^{*1}	2 transistor (NPN)	2 CT input ^{*2}	M3 screws	EJ1G-TC2A-QNH
Basic unit	2 (GTC)	2 voltage (pulse) ^{*1}	2 transistor (NPN)	2 CT input ^{*2}	Screw-less clamp	EJ1G-TC2B-QNH
Basic unit	4 (GTC)	4 voltage (pulse) ^{*1}	–	–	M3 screws	EJ1G-TC4A-QQ
Basic unit	4 (GTC)	4 voltage (pulse) ^{*1}	–	–	Screw-less clamp	EJ1G-TC4B-QQ
High function unit	– (GTC)	–	4 transistor (NPN)	–	M3 screws	EJ1G-HFUA-NFLK
High function unit	– (GTC)	–	4 transistor (NPN)	–	Screw-less clamp	EJ1G-HFUB-NFLK
End unit ^{*3}	–	–	2 transistor (NPN)	–	M3 screws	EJ1C-EDUA-NFLK
End unit ^{*3}	–	–	2 transistor (NPN)	–	Removable Connector	EJ1C-EDUC-NFLK

^{*1} Heating/cooling control is not supported for gradient temperature control.

^{*2} When using the heater burnout alarm, use a Current Transformer (E54-CT1 or E54-CT3) (sold separately).

^{*3} An End-unit (EDU) is always required to connect an HFU and/or a Basic TC unit for Communications and Power supply. A GTC (Gradient Temperature Control) basic TC unit always requires a GTC HFU unit.

Accessories

Current transformer

Diameter	Order code
5.8 dia.	E54-CT1
12.0 dia.	E54-CT3

Communications and cables

Description	Order code
G3ZA connecting cable 5 meter	EJ1C-CBLA050
USB programming cable	E58-CIFQ1
PC based configuration and tuning software CX-Thermo	EST2-2C-MV4
PROFIBUS Gateway	PRT1-SCU11

Specifications

Item	Type	EJ1_-TC2	EJ1_-TC4
Power supply voltage		24 VDC	
Operating voltage range		85% to 110% of rated voltage	
Power consumption		4 W max. (at maximum load)	5 W max. (at maximum load)
Input (see note) ^{*1}		Thermocouple: K, J, T, E, L, U, N, R, S, B, W, PLII ES1B Infrared Thermosensor: 10 to 70°C, 60 to 120°C, 115 to 165°C, 140 to 260°C. Analog input: 4 to 20 mA, 0 to 20 mA, 1 to 5 V, 0 to 5 V, 0 to 10 V Platinum resistance thermometer: Pt100, JPt100	
Input impedance		Current input: 150Ω max., voltage input: 1 MΩ min.	
Control outputs	Voltage output	Output voltage: 12 VDC ±15%, max. load current: 21 mA (PNP models with short-circuit protection circuit)	
	Transistor output	Max. operating voltage: 30 V, max. load current: 100 mA	–
	Current output	Current output range: 4 to 20 mA or 0 to 20 mA DC Load: 500 Ω max. (including transfer output) (Resolution: Approx: 2,800 for 4 to 20 mA DC, approx. 3,500 for 0 to 20 mA DC)	–
Event inputs	Input points	2	–
	Contact input	ON: 1 kΩ max., OFF: 100 kΩ min.	–
	Non-contact input	ON: Residual voltage: 1.5 V max., OFF: Leakage current: 0.1 mA max. Outflow current: approx. 4 mA per point	–
Number of input and control points	Input points: 2, control points: 2	Input points: 4, control points: 4	
Setting method	Via communications		
Control method	ON/OFF control or 2-PID (with autotuning, selftuning, Heat & Cool autotuning and non-linear cool output selection)		
Other functions	Two-point input shift, digital input filter, remote SP, SP ramp, manual manipulated variable, manipulated variable limiter, interference overshoot adjustment, loop burnout alarm, RUN/STOP, banks, I/O allocations, etc.		
Alarm output	2 points via End unit		
Communication	RS-485, PROFIBUS, Modbus, DeviceNet	RS-485, PROFIBUS, Modbus, DeviceNet	
Size in mm (W×H×D)	31×96×109		
Weight	180 g		
Ambient temperature range	Operating –10°C to 55°C, Storage –25°C to 65°C (with no icing or condensation)		
Ambient humidity range	Operating 25% to 85% (with no condensation)		

^{*1} Inputs are fully multi-input. Therefore, platinum resistance thermometer, thermocouple, infrared thermosensor, and analog input can be selected.

Dimensions

Item	Size in mm (H×W×D)
EJ1N-HFU_-NFL_	95.4×31.0×104.9/109.0
EJ1N-HFUB-DRT	90.9×31.0×82.2
EJ1C-EDU	95.4×15.7×76.2/79.7

Temperature sensors for standard applications

E52-E temperature sensors and thermocouples provide accurate temperature sensing for standard and challenging environments and include a wide range of mounting and connection options.

For best control results, the E52-E series is optimized to operate perfectly with suitable E5_ temperature controllers.

- Thermocouples and PT100 elements
- Wide range of housing, mounting and connection options
- Best performance match with temperature controllers from the E5_ portfolio



Ordering information

Line-Type	Series	Technology	Sub-Type	Min [°C]	Max [°C]	Dia. [mm]	Length [mm]	Material	Type	Fixing	Length [m]	Order code											
PRO-Line	Smooth tube	t/c ^{*1}	T	-80	400	3	100	SUS 316	2-wire	pre-wired with cable end shoes	2	E52-ETT3-100-2-A											
						6						E52-ETT6-100-2-A											
						1						E52-ETJ1-100-2-A											
						2						E52-ETJ2-100-2-A											
						3						E52-ETJ3-100-2-A											
						4.5						E52-ETJ4.5-100-2-A											
Lite-Line			J	0	400	4	100	SUS 304			2	E52-ELTJ4-100-2-A											
						5						E52-ELTJ5-100-2-A											
						6						E52-ELTJ6-100-2-A											
						8						E52-ELTJ8-100-2-A											
						PRO-Line								K	-80	1100	1	100	INCONEL 600			2	E52-ETK1-100-2-A
																	2						E52-ETK2-100-2-A
3	E52-ETK3-100-2-A																						
4.5	E52-ETK4.5-100-2-A																						
6	E52-ETK6-100-2-A																						
Lite-Line			K	0	400		4	100	SUS 304								2						E52-ELTK4-100-2-A
						5	E52-ELTK5-100-2-A																
						6	E52-ELTK6-100-2-A																
						8	E52-ELTK8-100-2-A																
						PRO-Line						PT100	class B	-50	500	3		250	SUS 316	3-wire	pre-wired with open cable ends		E52-EP3-250-2-B
																6							E52-EP6-250-2-B
Lite-Line			class B	0	400	4	50	SUS 304				2	E52-ELP4-50-2-A										
						5							E52-ELP5-100-2-A										
						6							E52-ELP6-100-2-A										
						8							E52-ELP8-100-2-A										
PRO-Line	Bayonet mounting		class B	-50	500	6	35	SUS 316	2-wire	enclosed screw terminals		-	E52-EP6-35-2-BG1/4G-B										
						200							E52-EP6-200-T2-B										
	Enclosed terminals, smooth tube	t/c ^{*1}	J	0	400	1150	15	200	INCONEL 600		pre-wired with open cable ends	2	E52-ETJ6-15-2-BG1/4G-B										
													720	E52-ETK6-200-T2-B									
	Enclosed terminals, smooth tube		K			1150			SUS 316	enclosed screw terminals			E52-ETJ6-200-T2-B										
													720	E52-ETK6-200-T2-CG1/2G-B									
	Enclosed terminals, G1/2" g; mounting		K			1150			INCONEL 600				E52-ETJ6-200-T2-CG1/2G-B										
													720	E52-EP6-200-T2-CG1/2G-B									
	Enclosed terminals, clamp mounting 1.5"		PT100	class B	-50	500	100			3-wire			E52-EP6-100-T2-CC1.5-B										
													200	E52-EP6-100-T2-CC2-B									
Enclosed terminals, clamp mounting 2"												E52-EP6-100-T2-CC2-B											
Pro ^{plus} -Line	Surface temperature	t/c ^{*1}	J	0	250	10	dia	Cu (tin plated)	2-wire	pre-wired with open cable ends	2	E52-ETJS1-B											
	Environmental temperature	PT100	class B	-40	80	-	-	Aluminium PVC	3-wire	enclosed screw terminals	-	E52-EPE1-B E52-EPE2-B											
	Non-contact	IR ^{*2}	up to 60 mm	10	260	M18	44.5	ABS	4-wire	pre-wired with open cable ends	3	ES1B											
			up to 1000 mm	0	400		120	SUS 304	5-wire		2	ES1C-A40											

*1 t/c = Thermocouple

*2 IR = Infrared Sensor

Note: Further types with different dia., tube & cable lengths and other confectioning are available on request.



Omron's intelligent PROFIBUS and CompoWay/F gateway

This gateway supports all CompoWay/F equipped products, including temperature controllers, digital panel indicators, etc. It can also be used for connecting MCW151-E and E5_K series.

- Cost-effectively integrates basic instruments into a PROFIBUS network
- Requires no complex protocol conversion writing
- Has function blocks for drag-and-drop configuration
- Connects up to 15 instruments to a single PROFIBUS point



Ordering information

Name	Order code
PROFIBUS remote terminal serial communications unit	PRT1-SCU11

Supports all CompoWay/F equipped units, but has "drag-and-drop" function blocks for

- ESAN/ESEN/ESCN/ESGN
- ESN and CelciuX^o (EJ1)
- ESAR/ESER
- ESAK/ESEK

Specifications

Item	PRT1-SCU11
Storage temperature	-20 to +75°C
Ambient temperature	0 to 55°C
Ambient humidity	10 to 90% (non-condensing)
EMC compliance	EN 50081-2, EN 61131-2
Power supply	+24 VDC (+10%/-15%) Current consumption 80 mA (typical)
Weight	125 g (typical)
Communication interface	RS-485 based PROFIBUS-DP RS-422A Host link RS-485 CompoWay/F RS-232C Peripheral Port supporting connection to thermotools
Size in mm (HxWxD)	90x40x65

ES1B



Achieve low-cost measurements with an infrared thermosensor

This infrared thermosensor provides an accurate, stable and cost-effective way to measure the temperature of objects. It behaves just like a standard K-type thermocouple, which enables it to operate with any temperature controller or alarm unit.

- Cost-effective infrared thermosensor
- Contactless, meaning no deterioration, unlike thermocouples
- 4 temperature ranges available: 10-70°C, 60-120°C, 115-165°C and 140-260°C
- Response speed 300 ms

Ordering information

Appearance and sensing characteristics	Specification	Order code
	10 to 70°C	ES1B 10-70C
	60 to 120°C	ES1B 60-120C
	115 to 165°C	ES1B 115-165C
	140 to 260°C	ES1B 140-260C

Dimensions (unit: mm)

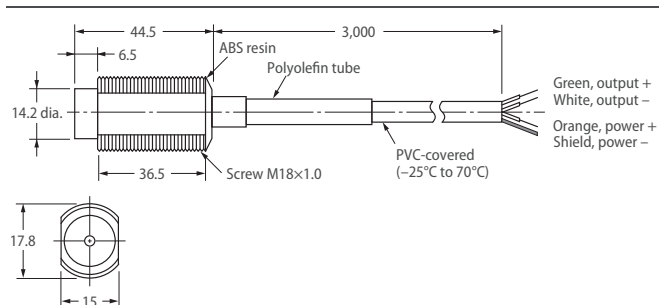

Specifications

Item	ES1B								
Power supply voltage	12/24 VDC								
Current consumption	20 mA max.								
Accuracy	<table border="1"> <tr> <td>±5°C</td> <td>±2% PV or ±2°C, whichever is larger</td> </tr> <tr> <td>±10°C</td> <td>±4% PV or ±4°C, whichever is larger</td> </tr> <tr> <td>±30°C</td> <td>±6% PV or ±6°C, whichever is larger</td> </tr> <tr> <td>±40°C</td> <td>±8% PV or ±8°C, whichever is larger</td> </tr> </table>	±5°C	±2% PV or ±2°C, whichever is larger	±10°C	±4% PV or ±4°C, whichever is larger	±30°C	±6% PV or ±6°C, whichever is larger	±40°C	±8% PV or ±8°C, whichever is larger
±5°C	±2% PV or ±2°C, whichever is larger								
±10°C	±4% PV or ±4°C, whichever is larger								
±30°C	±6% PV or ±6°C, whichever is larger								
±40°C	±8% PV or ±8°C, whichever is larger								
Reproducibility	±1% PV or ±1°C, whichever is larger								
Temperature drift	0.4°C/°C max.								
Receiver element	Thermopile								
Response speed	Approximately 300 ms at response rate of 63%								
Operating temperature	-25 to 70°C (with no icing or condensation)								
Allowable ambient humidity	35 to 85%								
Degree of protection	IP65								
Size in mm	head: 17.8 dia. x 44.5 (screw M18x1.0), cable 3,000								



Achieve Superior Environmental Resistance and a Wide Measurement Range of 0 to 400°C.

This infrared thermosensor provides an fast, accurate and very stable way to measure the temperature of objects. Its output provides a universal 4-20 mA, which enables it to operate with many temperature controllers or PLCs.

- Flexible placement with slim cylindrical shape and long focus with a distance of 500 mm and area diameter of 80 mm.
- The SUS body and silicon lens resist ambient operating temperatures of up to 70°C and resist dust and water to the equivalent of IP67.
- Fast measurement with high-speed response of 100 ms/90%.
- Strong resistance to noise with output of 4 to 20 mA.

Ordering information

Specification (measuring temperature range)	Order code
0 to 400°C	ES1C-A40

Dimensions (unit: mm)

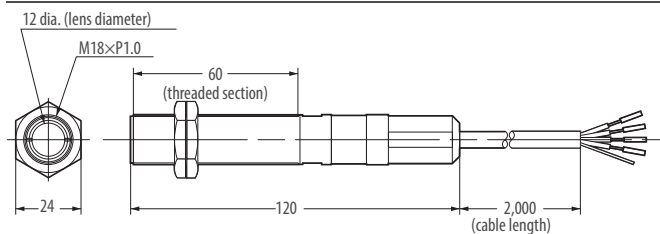

Ratings and Characteristics

Item	Model	ES1C
Power supply voltage		12 to 24 VDC
Operating voltage range		90% to 110% of rated voltage
Current consumption		70 mA max.
Measuring temperature range		0 to 400°C
Measurement accuracy		0 to 200°C: ±2°C, 201 to 400°C: ±1% (emissivity: 0.95)
Response time		100 ms/90%
Reproducibility		±1°C of reading value
Emissivity		0.95 fixed
Current output		4 to 20 mA DC, Load: 250 Ω max.
Ambient temperature range		Operating: 0 to 70°C, Storage: -20 to 70°C (with no icing or condensation)
Ambient humidity range		Operating and storage: 35% to 85%
Vibration resistance (destruction)		1.5-mm amplitude at 10 to 55 Hz for 2 hours each in the X, Y, and Z directions
Weight		180 g
Degree of protection		Equivalent to IP67

EJ1N-HFU-ETN



Connect Modbus slaves to ETHERNET

The EJ1N-HFU-ETN provides the solution to connect a CelciuX° (EJ1) in-panel multi-loop PID controller to PROFINET and Modbus/TCP. Although built on the CelciuX° (EJ1) platform, this unit can be used as a gateway for discrete Modbus units when only using the EJ1N-EDU endplate.

- Connects Modbus serial slaves to PROFINET and Modbus/TCP
- Built for integration into the CelciuX° (EJ1)
- Usable as a gateway for discrete units like E5_N-series temperature controllers and MX2 inverters.
- Flexible implementation with standard .gsd files



Ordering information

Name	Order code
ETHERNET to Serial Gateway	EJ1N-HFU-ETN

Specifications

Item	EJ1N-HFU-ETN
PROFINET	IO Device
Conformance	Class A
Supported RT	Class 1
Minimum Update Rate	8 ms
Number of Modbus RTU nodes	31
Ambient operating temperature	-10°C to 55°C
Ambient operating humidity	25% to 85%
Storage temperature	-20°C to 65°C
Weight	170 g

RELIABLE AND EASY OPERATION – WORLDWIDE

S8VK-G – The right power supply for your application

The S8VK-G offers a wide product range (from 15 W up to 480 W), in a very compact size. It is 13% smaller than comparable power supplies and the smallest on the market of its type.

- Wide operating temperature range (–40 to +70°C) to guarantee operation stability
- Double set of DC output terminals (three for the negative) to provide easy wiring
- High efficiency (90%) to reduce energy consumption
- Power Boost functionality (120%)
- Improved DIN-rail mounting clip to provide better vibration resistance and allow for easy installation

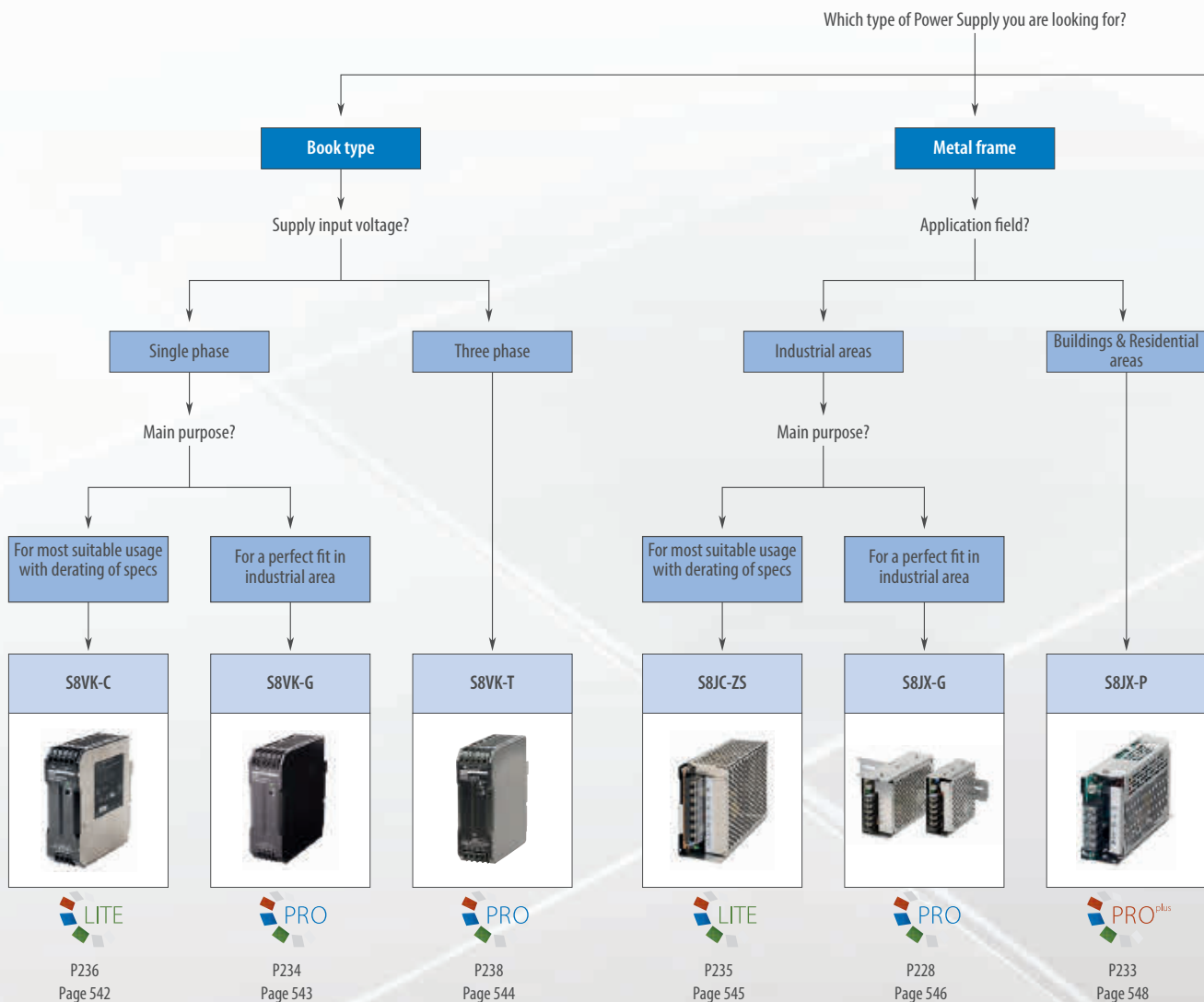

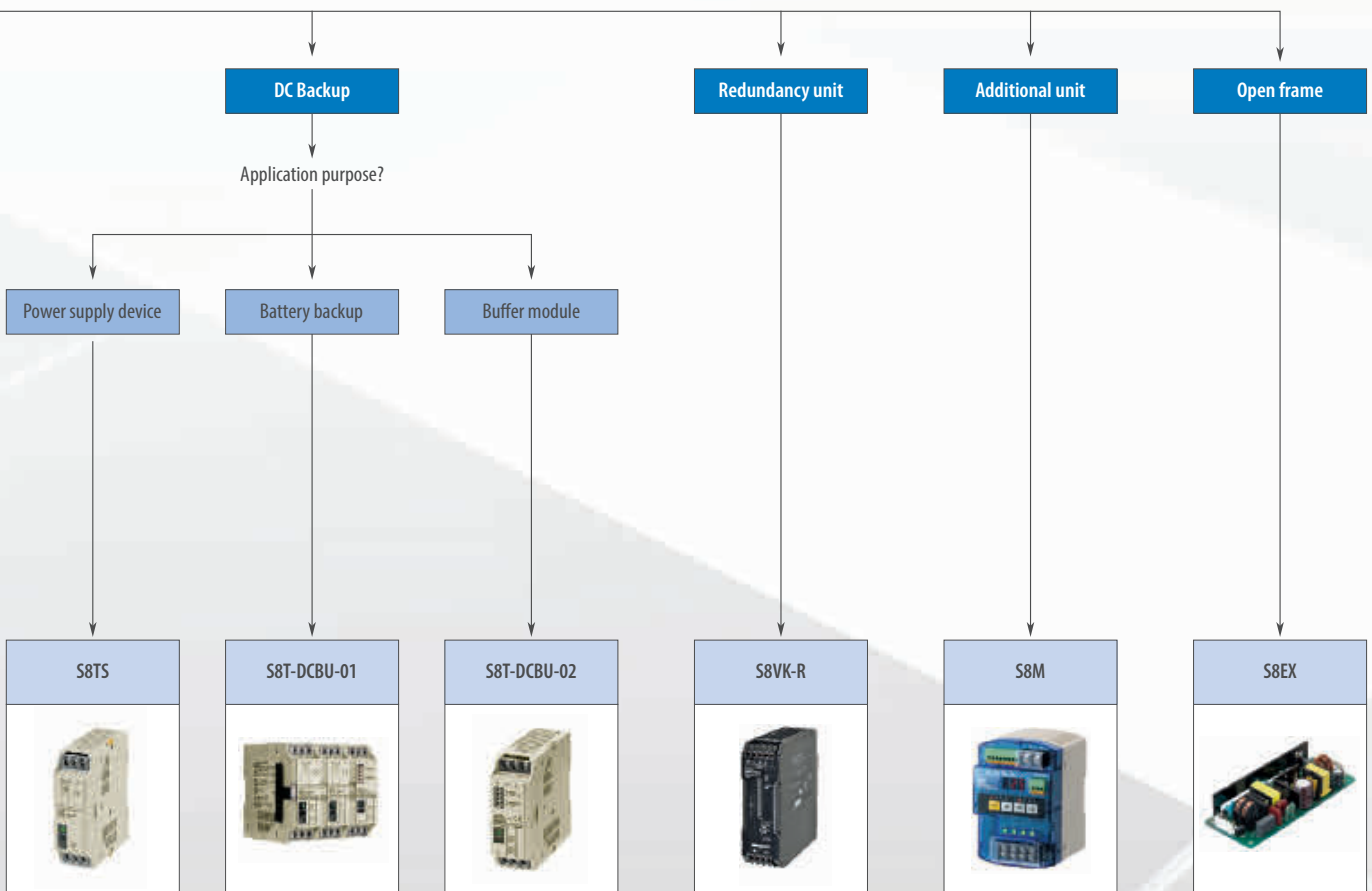

P243
Page 549

P244
Page 551

P245
Page 551











P237
Page 552

P227
Page 553

P239
Page 550

Selection table

Category		Book type power supply				Metal frame power supply							
													
Model		S8VK-G				S8VK-C		S8VK-T		S8JX-P			
Selection Criteria	Type	Pro line				Lite line		Pro line		Pro plus line			
	Phases	Single phase						Three phases		Single phase			
	Rated voltage	100 V to 240 VAC (90 to 350 VDC)				100 V to 240 VAC		3 × 320 V to 576 VAC		100 V to 240 VAC			
Power	Voltage	5 V	12 V	24 V	48 V	24 V				5 V	12 V	24 V	48 V
	15 W	■ 3 A	■ 1.2 A	■ 0.65 A	-								
	25 W	-											
	30 W	■ 5 A	■ 2.5 A	■ 1.3 A	-								
	35 W	-											
	50 W	-						■ 10 A	■ 4.2 A	■ 2.1 A	■ 1.1 A		
	60 W	-		■ 4.5 A	■ 2.5 A	-	■ 2.5 A	-					
	90 W	-											
	100 W	-						■ 20 A	■ 8.5 A	■ 4.5 A	■ 2.1 A		
	120 W	-		■ 5 A	-	■ 5 A							
	150 W	-						■ 30 A	■ 13 A	■ 6.5 A	■ 3.3 A		
	180 W	-											
	240 W	-		■ 10 A	■ 5 A	■ 10 A							
	300 W	-						■ 60 A	■ 27 A	■ 14 A	■ 7 A		
	350 W	-											
	480 W	-		■ 20 A	■ 10 A	■ 20 A							
	600 W	-						■ 120 A	■ 53 A	■ 27 A	■ 13 A		
	960 W	-						■ 40 A					
	1,500 W	-											
	Features	Conforms to EN61000-3-2	■				-		■				
DC back-up		-											
Capacitor back-up		□				□		□					
Undervoltage alarm		-											
Overvoltage protection		■											
Overload protection		■											
DIN-rail mounting		■											
Screw mounting (with bracket)		■											
EMI Class B		■				-		■		■			
UL Class 2		■ 15 W, 30 W, 60 W only				-							
N+1 Redundancy		□											
Parallel operation		■ by 2 units				-		■ by 2 units		■ 300 W, 600 W only by 5 units			
Power Boost		■ 120%				-		■ 120%		■ 300 W, 600 W at 24 V 115%			
Page/Quick Link	543				542		544		548				

Metal frame power supply					Modular				Open frame power supply											
																				
S8JX-G					S8JC-ZS				S8TS				S8EX							
Pro line					Lite line															
Single phase																				
100 V to 240 VAC					200 V to 240 VAC				100 V to 240 VAC				100 to 240 VAC (85 to 264 VAC)							
5 V	12 V	15 V	24 V	48 V	5 V	12 V	24 V	5 V	12 V	24 V	5 V	12 V	15 V	24 V	36 V	48 V				
■ 3 A	■ 1.3 A	■ 1.0 A	■ 0.65 A	■ 0.35 A	■ 3 A	■ 1.3 A	■ 0.7 A	-	-	-	■ 3 A	■ 1.3 A	■ 1.0 A	■ 0.7 A	-	■ 0.32 A				
-	-	-	-	-	-	-	-	■ 5 A	-	-	-	-	-	-	-	-				
-	-	-	-	-	-	-	-	-	■ 2.5 A	-	■ 6 A	■ 2.5 A	■ 2 A	■ 1.3 A	-	■ 0.65 A				
■ 7 A	■ 3 A	■ 2.4 A	■ 1.5 A	■ 0.75 A	■ 7 A	■ 3.0 A	■ 1.5 A	-	-	-	■ 10 A	■ 4.3 A	-	■ 2.1 A	-	■ 1.1 A				
■ 10 A	■ 4.2 A	-	■ 2.1 A	■ 1.1 A	■ 10 A	■ 4.2 A	■ 2.1 A	-	-	-	-	-	-	-	-	-				
-	-	-	-	-	-	-	-	-	■ 5 A	■ 2.5 A	-	-	-	-	-	-				
-	-	-	-	-	-	-	-	-	■ 7.5 A	-	-	-	-	-	-	-				
■ 20 A	■ 8.5 A	-	■ 4.5 A	■ 2.1 A	■ 20 A	■ 8.5 A	■ 4.5 A	-	-	-	■ 20 A	■ 8.5 A	-	■ 4.3 A	-	■ 2.1 A				
-	-	-	-	-	-	-	-	-	■ 10 A	■ 5 A	-	-	-	-	-	-				
■ 30 A	■ 13 A	-	■ 6.5 A	■ 3.3 A	■ 30 A	■ 12.5 A	■ 6.5 A	-	-	-	■ 30 A	■ 12.5 A	-	■ 6.3 A	-	■ 3.2 A				
-	-	-	-	-	-	-	-	-	■ 7.5 A	-	-	-	-	-	-	-				
-	-	-	-	-	-	-	-	-	■ 10 A	-	-	-	■ 10 A	■ 6.7 A	■ 5 A	-				
■ 60 A	■ 27 A	-	■ 14 A	■ 7 A	-	-	-	-	-	-	-	-	-	-	-	-				
-	-	-	-	-	■ 60 A	■ 29 A	■ 14.6 A	-	-	-	-	-	-	-	-	-				
-	-	-	-	-	-	-	-	-	-	-	-	-	-	-	-	-				
■ 120 A	■ 53 A	-	■ 27 A	■ 13 A	-	-	-	-	-	-	-	-	-	-	-	-				
-	-	-	-	-	-	-	-	-	-	-	-	-	-	-	-	-				
-	-	-	-	-	-	-	-	-	-	-	-	-	-	-	-	-				
-	-	-	-	-	-	-	-	-	■	-	■	-	-	-	-	-				
-	-	-	-	-	-	-	-	-	-	□	-	-	-	-	-	-				
-	-	-	-	-	-	-	-	-	-	-	■	-	-	-	-	-				
■	-	-	-	-	-	-	-	-	-	-	■	-	-	-	-	-				
■	-	-	-	-	-	-	-	-	-	-	■	-	-	-	-	-				
■	-	-	-	-	-	-	-	-	-	-	-	-	-	-	-	-				
■	-	-	-	-	-	-	-	-	-	-	-	-	-	-	-	-				
-	-	-	-	-	-	-	-	-	-	-	■	-	-	-	-	-				
-	-	-	-	-	-	-	-	-	■	■ 1 unit	-	-	-	-	-	-				
-	-	-	-	-	-	-	-	-	■	-	-	-	-	-	-	-				
■ 300 W, 600 W only by 5 units	-	-	-	-	-	-	-	-	■	-	-	-	-	-	-	-				
-	-	-	-	-	-	-	-	-	-	-	-	-	-	-	-	-				
546	-	-	-	-	545	-	-	549	-	-	550	-	-	-	-	-				

■ Standard □ Available - No/not available



The cost effective book type power supply

The S8VK-C Lite family is an ideal choice for cost-sensitive applications that require a dependable high-quality power supply. The S8VK-C have an universal 100 to 240 V 50/60 Hz input capability (DC input (90 to 350 VDC) also possible) and they are available with power ratings from 60 to 480 W.

- Operating temperature range of -25 to 60°C
- Double set of DC output terminals (three for the negative) provide easy wiring
- Overload and overvoltage protection
- Conforms to EN61204-3, EN55011 Class A

Ordering information

Type	Power ratings	Input voltage	Output voltage	Output current	Size (W × H × D) [mm]	Order code
Power supply Single-phase	60 W	Single phase 100 to 240 VAC	24 V	2.5 A	32 × 90 × 110	S8VK-C06024
	120 W		24 V	5 A	40 × 125 × 113	S8VK-C12024
	240 W	Allowable range: 85 to 264 VAC, 90 to 350 VDC	24 V	10 A	60 × 125 × 140	S8VK-C24024
	480 W		24 V	20 A	95 × 125 × 140	S8VK-C48024

Specifications

Item	60 W	120 W	240 W	480 W
Efficiency (Typ. at 230 VAC)	88%	89%	89%	92%
Input	Rated input voltage			
	100 to 240 VAC			
Input	Allowable range			
	85 to 264 VAC, 90 to 350 VDC			
Output	Voltage adjustment range (with V.ADJ)			
	-10% to 15%			
	Input variation influence			
	0.5% max. (at 85 to 264 VAC input, 100% load)			
Output	Load variation influence			
	1.5% max. at 0% to 100% load			
Output	Temperature variation influence			
	0.05%/°C max.			
Overload protection	Yes			
Overvoltage protection	Yes			
Operating ambient temperature	-25 to 60°C (-13 to 140°F)			
Series operation	Yes, up to 2 units			
Parallel operation	No			
EMI	Conforms to EN 61204-3, EN 55011 Class A			
EMS	Conforms to EN 61204-3 high severity levels			
Approved standards	UL: UL 508 (Listing), UL 60950-1, cUL: CSA C22.2 No. 107.1 and No. 60950-1, EN/VDE: EN 50178 (=VDE0160), EN 60950-1 (=VDE0805)			
Degree of protection	IP20 by EN/IEC 60529			



The standard book type power supply

The standard S8VK-G Pro line is our “install and forget” option, offering longer lifetime, higher protection and more features. The S8VK-G offers a wide product range (from 15 up to 480 W), in a very compact package. There are models available for 5, 12, 24 and 48 VDC output voltage. DC input (90 to 350 VDC) is also available through the whole range.

- Wide operating temperature range (–40 to 70°C) that guarantees stable operation
- Double set of DC output terminals (three for the negative) provide easy wiring
- High efficiency 90% to reduce the energy consumption
- Power boost functionality (120%) for the right start of the application
- Improved DIN-rail mounting clip provides a better resistance to vibrations and allows easy installation (using one hand to mount in a flash)

Ordering information

Type	Power ratings	Input voltage	Output voltage	Output current	Size (W × H × D) [mm]	Order code
Power supply Single-phase	15 W	100 to 240 VAC Allowable range: 85 to 264 VAC, 90 to 350 VDC, 2 phases less than 240 VAC	5 V	3 A	22.5 × 90 × 90	S8VK-G01505
			12 V	1.2 A		S8VK-G01512
			24 V	0.65 A		S8VK-G01524
	30 W		5 V	5 A	32 × 90 × 90	S8VK-G03005
			12 V	2.5 A		S8VK-G03012
			24 V	1.3 A		S8VK-G03024
	60 W		12 V	4.5 A	32 × 90 × 110	S8VK-G06012
			24 V	2.5 A		S8VK-G06024
	120 W		24 V	5 A	40 × 125 × 113	S8VK-G12024
	240 W		24 V	10 A	60 × 125 × 140	S8VK-G24024
			48 V	5 A		S8VK-G24048
	480 W		24 V	20 A	95 × 125 × 140	S8VK-G48024
48 V		10 A	S8VK-G48048			

Specifications

Item	15 W	30 W	60 W	120 W	240 W	480 W
Efficiency (Typ. at 230 VAC)	80% (24 V)	86% (24 V)	88% (24 V)	89% (24 V)	92% (24 V)	93% (24 V)
Input	Rated input voltage	100 to 240 VAC				
	Allowable range	85 to 264 VAC, 90 to 350 VDC. 2 phases less than 240 VAC				
Output	Voltage adjustment range (with V.ADJ)	–10% to 15%				
	Input variation influence	0.5% max. (at 85 to 264 VAC input, 100% load)				
	Load variation influence	3.0% max. (5 V), 2.0% max. (12 V), 1.5% max. (24, 48 V), at 0% to 100% load				
	Temperature variation influence	0.05%/°C max.				
Overload protection	Yes, 130% of rated current typ.					
Power Boost	120% of rated current					
Overvoltage protection	Yes					
Operating ambient temperature	–40 to 70°C (–40 to 158°F)					
Series operation	Yes, up to 2 units					
Parallel operation	Yes, up to 2 units					
EMI	Conforms to EN 61204-3, EN 55011 Class B					
EMS	Conforms to EN 61204-3 high severity levels					
Harmonic current emissions	Conforms to EN 61000-3-2					
Approved standards	UL: UL 508 (Listing), UL 60950-1, cUL: CSA C22.2 No. 107.1 and No. 60950-1, UL 1310 Class 2 output for 15 W, 30 W, 60 W EN/VDE: EN 50178 (=VDE0160), EN 60950-1 (=VDE0805), Lloyd's Register					
Fulfilled standards	SELV (EN 60950-1/EN 50178/UL 60950-1), PELV (EN 60204-1, EN 50178), Safety of power transformers (EN 61558-2-16), EN 50274 for terminal parts					
Degree of protection	IP20 by EN/IEC 60529					



Compact 3-phase input power supply

The S8VK-T has an exceptionally wide operating temperature range from – 40 to 70°C as well as S8VK-G, single phase power supply. These models have also good endurance against hard vibration and guarantee the stable operation even in the harshest of environments.

- Input range: 3 × 320 to 576 VAC, 2 × 340 to 576 VAC
- Safety standard, UL 508, ANSI 12.12.01, EN 50178, EN 60950-1, UL 60950-1, CSA No. 60950-1, EN 60204-1 PELV, EN 61558-2-16 Safety transformer. Lloyd's Register
- Protection IP20 by EN/IEC 60529
- EMI Class B
- 120% boost function

Ordering information

Type	Power ratings	Input voltage	Output voltage	Output current	Size (W × H × D) [mm]	Order code
Power supply three-phase	120 W	3 × 380 to 480 VAC, 2 × 380 to 480 VAC	24 V	5 A	40×125×113	S8VK-T12024
	240 W	450 to 600 VDC (Excluding 960 W)		10 A	60×125×140	S8VK-T24024
	480 W	Allowable range: 3 × 320 to 576 VAC, 2 × 340 to 576 VAC, 450 to 810 VDC (Excluding 960 W)		20 A	95×125×140	S8VK-T48024
	960 W			40 A	135×125×170	S8VK-T96024

Specifications

Item	120 W	240 W	480 W	960 W
Efficiency (Typ. at 400 VAC)	89%	89%	91%	92%
Input	Rated Input Voltage			3 × 380 to 480 VAC, 2 × 380 to 480 VAC
	Allowable range			3 × 320 to 576 VAC, 2 × 340 to 576 VAC, 450 to 810 VDC
Output	Voltage adjustment range (with V.ADJ)			22.5 to 29.5 V
	Input variation influence			0.5% max. (at 3 × 320 to 576 VAC input, 100% load)
	Load variation influence			1.5% max. at 0 to 100% load
	Temperature variation influence			0.05%/°C max.
Overload protection	Yes, 125% of rated current typ.			
Power Boost	120% of rated current			
Overvoltage protection	Yes			
Operating ambient temperature	–40 to 70°C (–40 to 158°F)			
Series Operation	Yes, Up to 2 units			
Parallel Operation	Yes, Up to 2 units			
EMI	Conforms to EN 61204-3, EN 55011 Class B			
EMS	Conforms to EN 61204-3 high severity levels			
Harmonic current emissions	Conforms to EN 61000-3-2			
Approved Standards	UL: UL 508 (Listing), ANSI/ISA 12.12.01 EN/VDE: EN 50178, Lloyd's Register	UL: UL 508 (Listing), ANSI/ISA 12.12.01, UL 60950-1, CSA: C22.2 No.60950-1, EN/VDE: EN 50178, EN 60950-1, Lloyd's Register		
Fulfilled Standards	SELV (EN 50178), PELV (EN 60204-1, EN 50178), Safety of Power Transformers (EN 61558-2-16), EN 50274 for Terminal parts	SELV (EN 60950-1/EN 50178/UL 60950-1), PELV (EN 60204-1, EN 50178), Safety of Power Transformers (EN 61558-2-16), EN 50274 for Terminal parts		
Degree of protection	IP20 by EN / IEC 60529			



Cost effective range with CE marking

The S8JC-ZS Lite family of metal framed power supplies is our best standard power supply for material cost reduction. The range covers 15 W, 35 W, 50 W, 100 W, 150 W and 350 W models and all are available with 5, 12 or 24 VDC output voltages.

- CE marking
- Overload and over voltage protection
- Conforms to EN 61204-3, EN 55011 Class A

Ordering information

Power ratings	Output voltage	Output current	Size in mm (H × W × D)	Order code
15 W	5 V	3.0 A	97 × 36 × 79.5	S8JC-ZS01505CD-AC2
	12 V	1.3 A		S8JC-ZS01512CD-AC2
	24 V	0.7 A		S8JC-ZS01524CD-AC2
35 W	5 V	7 A	98.3 × 38 × 129	S8JC-ZS03505CD-AC2
	12 V	3.0 A		S8JC-ZS03512CD-AC2
	24 V	1.5 A		S8JC-ZS03524CD-AC2
50 W	5 V	10 A	98.3 × 38 × 129	S8JC-ZS05005CD-AC2
	12 V	4.2 A		S8JC-ZS05012CD-AC2
	24 V	2.1 A		S8JC-ZS05024CD-AC2
100 W	5 V	20 A	98 × 50 × 159	S8JC-ZS10005CD-AC2
	12 V	8.5 A	97.6 × 38 × 159	S8JC-ZS10012CD-AC2
	24 V	4.5 A		S8JC-ZS10024CD-AC2
150 W	5 V	30 A	98 × 43 × 199	S8JC-ZS15005CD-AC2
	12 V	12.5 A	98 × 50 × 159	S8JC-ZS15012CD-AC2
	24 V	6.5 A		S8JC-ZS15024CD-AC2
350 W	5 V	60 A	115 × 50 × 193.6	S8JC-ZS35005CD-AC2
	12 V	29 A		S8JC-ZS35012CD-AC2
	24 V	14.6 A	115 × 50 × 194.8	S8JC-ZS35024CD-AC2

Specifications

Item	15 W	35 W	50 W	100 W	150 W	350 W
Efficiency (Typ.)	80% (24 V)	84% (24 V)	83% (24 V)	87% (24 V)	87% (24 V)	84% (24 V)
Input	Rated input voltage	200 to 240 VAC				
	Allowable range	185 to 264 VAC				
Output	Voltage adjustment range(with V.ADJ)	±10%				
	Overload protection	Yes, 105% of rated current				
Overvoltage protection	Yes					
Operating ambient temperature	-20 to 60°C (-4 to 140°F)					
Series operation	No					
Parallel operation	No					
Fulfilled standards	EN 50178 (CE mark by self declaration)					



Slim and economic power supply

The S8JX-G is Omron's cost effective power supply delivering Omron's quality and reliability. The range of this Power Supply covers up to 600 W, the output voltages are 5, 12, 15, 24 or 48 VDC. The low profile and multiple mounting options help you reduce panel space. With a minimum life expectancy of 10 years and protection against over-voltage, over-current and short circuiting, the S8JX-G has the reliability you expect from Omron.

- Wide range in DC-output voltage (5 V, 12 V, 15 V, 24 V and 48 V) and wattage (15 to 600 W)
- LED indication power ON
- Over-voltage, over-current, and short circuit protection
- Vibration resistance 4,5 g
- All models can be DIN-rail mounted
- Approvals: UL, cUL, UL508 Listed, SEMI F47, VDE

Ordering information

Power ratings	Output voltage	Output current	Size in mm (H × W × D)	Order code
15 W	5 V	3 A	91 × 40 × 90	S8JX-G01505CD
	12 V	1.3 A		S8JX-G01512CD
	15 V	1 A		S8JX-G01515CD
	24 V	0.65 A		S8JX-G01524CD
	48 V	0.35 A		S8JX-G01548CD
35 W	5 V	7 A	92 × 40 × 100	S8JX-G03505CD
	12 V	3 A		S8JX-G03512CD
	15 V	2.4 A		S8JX-G03515CD
	24 V	1.5 A		S8JX-G03524CD
	48 V	0.75 A		S8JX-G03548CD
50 W	5 V	10 A	92 × 40 × 100	S8JX-G05005CD
	12 V	4.2 A		S8JX-G05012CD
	24 V	2.1 A		S8JX-G05024CD
	48 V	1.1 A		S8JX-G05048CD
100 W	5 V	20 A	92 × 50 × 150	S8JX-G10005CD
	12 V	8.5 A		S8JX-G10012CD
	24 V	4.5 A		S8JX-G10024CD
	48 V	2.1 A		S8JX-G10048CD
150 W	5 V	30 A	92 × 60 × 178	S8JX-G15005CD
	12 V	13 A	92 × 50 × 150	S8JX-G15012CD
	24 V	6.5 A	92 × 50 × 150	S8JX-G15024CD
	48 V	3.3 A	92 × 50 × 150	S8JX-G15048CD
300 W	5 V	60 A	92 × 110 × 164.5	S8JX-G30005CD
	12 V	27 A	92 × 110 × 167	S8JX-G30012CD
	24 V	14 A	92 × 110 × 167	S8JX-G30024CD
	48 V	7 A	92 × 110 × 167	S8JX-G30048CD
600 W	5 V	120 A	92 × 150 × 160	S8JX-G60005C
	12 V	53 A		S8JX-G60012C
	24 V	27 A		S8JX-G60024C
	48 V	13 A		S8JX-G60048C

Specifications

Item		15 W	35 W	50 W	100 W	150 W	300 W	600 W	
Efficiency (Typ. at 230 VAC)		81% (24 V)	84% (24 V)	86% (24 V)	88% (24 V)	90% (24 V)	88% (24 V)	84% (24 V)	
Input	Rated input voltage	100 to 240 VAC					100 to 120 VAC/200 to 240 VAC, Switchable		
	Allowable range	85 to 264 VAC, 80 to 370 VDC (DC is not applicable for the safety standards.)					85 to 132 VAC/170 to 264 VAC		
Output	Voltage adjustment range (with V.ADJ)	-10% to 15% for 5 V to 24 V, $\pm 10\%$ for 48 V (with V.ADJ)							
	Input variation influence	0.4% max. (at 85 to 264 VAC input, 100% load)							
	Load variation influence	0.8% max. at 0% to 100% load							
	Temperature variation influence	0.05%/°C max.							
Overload protection		Yes, 105% to 160% of rated current							
Overvoltage protection		Yes							
Operating ambient temperature		-10 to 60°C (14 to 140°F)							
Series operation		Yes, up to 2 units					Yes, up to 2 units		
Parallel operation		No					Yes, up to 5 units		
EMI		Conforms to EN 61204-3, EN 55011 Class A							
EMS		Conforms to EN 61204-3 high severity levels							
Approved standards		UL: UL 508 (Listing), UL 60950-1, cUL: CSA C22.2 No. 107.1 and No. 60950-1, EN/VDE: EN 50178 (=VDE0160), EN 60950-1 (=VDE0805)					UL: UL 508 (Recognition), UL 60950-1, cUR: CSA C22.2 No. 107.1 and No. 60950-1, EN/VDE: EN 50178 (=VDE0160), EN 60950-1 (=VDE0805)		
Fulfilled standards		EN 50274 for terminal parts							



EMI Class B and Power Factor Correction

The main improvements provided by the S8JX-P models are harmonic current suppression/PFC (Power Factor Correction) and EMI EN55011 Class B compliant. In addition, further functionalities have been implemented (applies only to 300 and 600 W models):

- Remote sensing, to compensate for voltage drops on the load lines
- Remote control, using an external signal allows to turn the output ON and OFF without removing the input voltage
- Alarm output, informing about PS errors, such as fan failure or insufficient voltage

Ordering information

Power ratings	Output voltage	Output current	Size in mm (H × W × D)	Order code
50 W	5 V	10 A	92 × 42 × 129	S8JX-P05005CD
	12 V	4.2 A		S8JX-P05012CD
	24 V	2.1 A		S8JX-P05024CD
	48 V	1.1 A		S8JX-P05048CD
100 W	5 V	20 A	92 × 42 × 159	S8JX-P10005CD
	12 V	8.5 A		S8JX-P10012CD
	24 V	4.5 A		S8JX-P10024CD
	48 V	2.1 A		S8JX-P10048CD
150 W	5 V	30 A	92 × 42 × 159	S8JX-P15005CD
	12 V	13 A		S8JX-P15012CD
	24 V	6.5 A		S8JX-P15024CD
	48 V	3.3 A		S8JX-P15048CD
300 W	5 V	60 A	92 × 71 × 165	S8JX-P30005CD
	12 V	27 A		S8JX-P30012CD
	24 V	14 A		S8JX-P30024CD
	48 V	7 A		S8JX-P30048CD
600 W	5 V	120 A	92 × 110 × 165	S8JX-P60005CD
	12 V	53 A		S8JX-P60012CD
	24 V	27 A		S8JX-P60024CD
	48 V	13 A		S8JX-P60048CD

Specifications

Item	50 W	100 W	150 W	300 W	600 W
Efficiency (Typ. at 230 VAC)	82% (24 V)	87% (24 V)	88% (24 V)	87% (24 V)	85% (24 V)
Input	Rated input voltage	100 to 240 VAC			
	Allowable range	85 to 264 VAC, 80 to 370 VDC (DC is not applicable for the safety standards.)			
Output	Voltage adjustment range (with V.ADJ)	-10% to 15% for 5 V to 24 V, ±10% for 48 V (with V.ADJ)		-10% to 15% for 12 V and 24 V, ±10% for 5 V and 48 V	
	Input variation influence	0.4% max. (at 85 to 264 VAC input, 100% load)			
	Load variation influence	0.8% max. at 0% to 100% load			
	Temperature variation influence	0.05%/°C max.			
Overload protection	Yes, 105% to 160% of rated current				
Power Boost	-			115% of rated current for 24 V only	
Overvoltage protection	Yes				
Operating ambient temperature	-10 to 70°C (14 to 158°F)				
Series operation	Yes, up to 2 units				
Parallel operation	No			Yes, up to 5 units	
EMI	Conforms to EN 61204-3, EN 55011 Class B				
EMS	Conforms to EN 61204-3 high severity levels				
Harmonic current emissions	Conforms to EN61000-3-2				
Approved standards	UL: UL508 (Listing), UL60950-1, cUL: CSA C22.2 No. 107.1 and No. 60950-1, EN/VDE: EN 50178 (=VDE0160), EN 60950-1 (=VDE0805),				
Fulfilled standards	EN 50274 for Terminal parts				



Industrial use, modular power supply for multiple configurations

The S8TS is an expandable power supply; standard units can easily be snapped together in parallel to provide you with ultimate flexibility. Expandable up to 4 units, it can deliver a total power of 240W at 24VDC or a multi-output configuration.

- Improves system reliability by building up N+1 redundancy
- Standard unit; 60 W at 24 VDC, 30 W at 12 VDC and 25 W at 5 VDC
- Battery back-up unit protects against power outage (see accessories)
- Buffer unit protects against power glitches and outage (see accessories)
- EMI Class B, UL Class 2, UL Class 1 division 2

Ordering information

Basic block		Order code			
Output voltage	Output current	Screw terminal type		Connector terminal type	
		With bus line connectors ^{*1}	Without bus line connectors ^{*2}	With bus line connectors ^{*1}	Without bus line connectors ^{*2}
24 V	2.5 A	S8TS-06024-E1 ^{*3}	S8TS-06024	S8TS-06024F-E1	S8TS-06024F
12 V	2.5 A	S8TS-03012-E1	S8TS-03012	S8TS-03012F-E1	S8TS-03012F
5 V	5 A	–	S8TS-02505	–	S8TS-02505F

*1 One S8T-BUS01 connector and one S8T-BUS02 connector are included as accessories.

*2 Bus line connectors can be ordered separately if necessary.

*3 Conforms to EMI class B with DC minus terminal ground.

Accessories

Bus line connector		
Type	Number of connectors	Order code
AC line + DC line bus (For parallel operation)	1 connector	S8T-BUS01
	10 connectors ^{*1}	S8T-BUS11
AC line bus (For series operation or isolated operation)	1 connector	S8T-BUS02
	10 connectors ^{*2}	S8T-BUS12

*1 One package contains 10 S8T-BUS01 connectors.

*2 One package contains 10 S8T-BUS02 connectors.

Specifications

Item	5 V models		24/12 V models	
	Single operation		Single operation	Parallel operation
Efficiency	62% min.		24 V models: 75%, 12 V models: 70% min.	
Power factor	0.8 min.		24 V models: 0.9 min., 12 V models: 0.8 min.	
Input voltage	100 to 240 VAC, (85 to 264 VAC), single-phase			
Output voltage	Voltage adjustment	5 V \pm 10% min.		24 V models: 22 to 28 V, 12 V models: 12 V \pm 10% min.
	Ripple	2% (p-p) max.		2% (p-p) max. 2% (p-p) max.
	Input variation	0.5% max.		– –
	Temperature influence	0.05%/°C max. (with rated input, 10 to 100% load)		
Overcurrent protection	105 to 125% of rated load current, inverted L drop, automatic reset			
Overvoltage protection	yes		yes	yes
Output indicator	yes (green)		yes (green)	yes (green)
Weight	450 g max.		450 g max.	450 g max.
Series operation	yes		yes	yes
Parallel operation	no		yes	yes
Size in mm (HxWxD)	120x43x120			



Open frame power supply, the best to build-in small equipment

The S8EX is an open frame power supply to mount on small equipment directly. The wide variation of output voltage and Power boost function 200% can contribute the down sizing of equipment and the standardization of power supply

- 200% Power boost function
- Connector terminals
- Various installations are possible.
- Wide operation temperature range: -10 to 70°C

Ordering information

Power ratings	Input voltage	Output voltage	Output current	Size (W × H × D) [mm]	Order code
15 W	100 to 240 VAC	5 V	3 A	50 × 22 × 105	S8EX-N01505
		12 V	1.3 A		S8EX-N01512
		15 V	1 A		S8EX-N01515
		24 V	0.7 A		S8EX-N01524
		48 V	0.32 A		S8EX-N01548
30 W		5 V	6 A	50 × 27 × 105	S8EX-N03005
		12 V	2.5 A		S8EX-N03012
		15 V	2 A		S8EX-N03015
		24 V	1.3 A		S8EX-N03024
		48 V	0.65 A		S8EX-N03048
50 W		5 V	10 A	50 × 28.5 × 132	S8EX-BP05005
		12 V	4.3 A		S8EX-BP05012
		24 V	2.1 A		S8EX-BP05024
		48 V	1.1 A		S8EX-BP05048
100 W		5 V	20 A	62 × 35.5 × 155	S8EX-P10005
		12 V	8.5 A		S8EX-BP10012
		24 V	4.3 A		S8EX-BP10024
		48 V	2.1 A		S8EX-BP10048
150 W		5 V	30 A	75 × 37.5 × 160	S8EX-P15005
		12 V	12.5 A		S8EX-BP15012
		24 V	6.3 A		S8EX-BP15024
		48 V	3.2 A		S8EX-BP15048
240 W		24 V	10 A	84 × 42.5 × 180	S8EX-BP24024
		36 V	6.7 A		S8EX-BP24036
		48 V	5 A		S8EX-BP24048

Specifications

Specification	15 W	30 W	50 W	100 W	150 W	240 W
Efficiency (Typ at 200 VAC)	78% (24 V)	86% (24 V)	85% (24 V)	86% (24 V)	87% (24 V)	90% (24 V)
Input	Rated Input Voltage	100 to 240 VAC				
	Allowable range	85 to 264 VAC				
Output	Voltage adjustment range (with V.ADJ)	±10%				
	Input variation influence	0.5% max. (at 85 to 264 VAC input, 100% load)				
	Load variation Influence	2.0% max. (5 V), 1.5% max. (12, 24, 36, 48 V), at 0 to 100% load				
	Temperature variation influence	0.05%/°C max.				
Overload protection	Yes, 105 to 160% of rated current					
Power Boost	-		150% of rated current (5 V of 50 W, 12 V) 200% of rated current (24 V, 36 V, 48 V)			
Overvoltage protection	Yes					
Operating ambient temperature	-10 to 70°C (14 to 158°F)					
EMI	Conforms to EN 61204-3, EN55011 Class B					
EMS	Conforms to EN 61204-3 high severity levels					
Harmonic current emissions	Conforms to EN 61000-3-2					
Approved Standards	UL: UR 60950-1, cUR: CSA C22.2 No.60950-1, EN/VDE: EN 50178 (=VDE 0160), EN 60950-1 (=VDE 0805)					

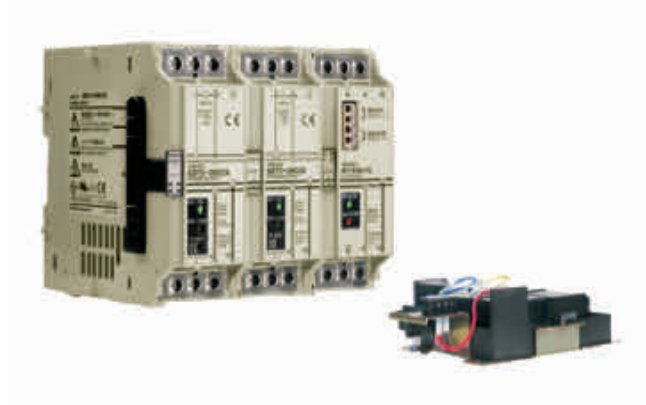

S8T-DCBU-01

The S8T-DCBU-01 battery backup block supplies 24 VDC for a fixed period of time during AC input outages to considerably improve system reliability.

- Supplies 24 VDC for a long period of time during AC input outages
- For system reliability improvement
- Block power supply basic block is connected by the bus line connector
- Simple system configuration
- Alarms indicated on main unit and via alarm signal output

Ordering information

Product	Input voltage	Output voltage	Output current	Order code		
DC back-up block	24 to 28 VDC	24 V	3.7 A/8 A	S8T-DCBU-01		
Battery holder	–	–	–	S82Y-TS01		
Product	Input voltage	Output voltage	Output current	Type	Order code	
Basic block (use together with the DC back-up block)	100 to 240 VAC	24 V	2.5 A	Screw terminal type	With bus line connectors	S8TS-06024-E1
				Connector terminal type	Without bus line connectors	S8TS-06024
					With bus line connectors	S8TS-06024F-E1
				Without bus line connectors	S8TS-06024F	
Product	Back-up time	Overcurrent protection operating point selector		Order code		
Battery	8 min./3.7 A	5.7 A (typ.)	–	LC-R122R2PG		
	4 min./8.0 A	5.7 A (typ.)	11.7 A (typ.)	LC-R123R4PG		

Note: The S8TS DC back-up block is for S8TS power supplies only.

Specifications

Item	Size in mm (HxWxD)
S8T-DCBU-01	120x43x130
Battery holder	82x185.7x222.25



S8T-DCBU-02

Prevents equipment stoppage, data loss and other problems resulting from momentary power failures. One S8T-DCBU-02 buffer block provides a back-up time of 500 ms at an output current of 2.5 A. Can be wired to the 24 VDC output from any switch mode power supply.

- Connects to all Omron power supplies: S8TS, S8VS, S82J, S82K, S8VM, S8PE
- Connects to both single-phase and three-phase power supplies
- Connects to an S8TS power supply via an S8T-BUS03 bus line connector
- Parallel connection up to 4 units to increase back-up time and capacity
- Complies with Semi F47-0200 standard

Ordering information

Input voltage	Output voltage (during back-up operation)	Output current	Order code
24 VDC (24 to 28 VDC)	22.5 V	2.5 A	S8T-DCBU-02

Accessories

Type	Number of connectors	Order code
DC bus line connector (for use with S8TS only)	1 connector	S8T-BUS03
	10 connectors	S8T-BUS13

Specifications

Item	Size in mm (HxWxD)
S8T-DCBU-02	120x43x120



Redundancy Unit, contributes to build high reliable systems

The S8VK-R is a redundancy unit used with S8VK Power Supply series. This unit consists of 2 main diodes and additional function to build the redundancy of Power supply and can save your design time by the combination of S8VK series with high reliability.

- Redundancy operating LED for the status confirmation
- A signal output for failure detection of power supplies
- By adjusting the power supply voltage to light up Balance LED the lifetime of power supplies will be more than twice.
- •Wide operation temperature range: -40 to 70°C

Ordering information

Input voltage	Output current	Size (W × H × D) [mm]	Order code
5 to 30 VDC	10 A	32 × 90 × 110	S8VK-R10
10 to 60 VDC	20 A	40 × 125 × 113	S8VK-R20

Specifications

Type	S8VK-R10	S8VK-R20
Rated Input Voltage	5 to 30 V	10 to 60 V
Output Current	10 A	20 A
Voltage Drop	0.7 V max at 10 A	0.9 V max at 20 A
Operation Temperature range	-40 to 70°C	-40 to 70°C
Safety Standard	UL 60950-1, UL 508, cURus, cULus, EN 50178, EN 60950-1	
Signal output	30 VDC 50 mA max by Photo MOS Relay	
Redundancy OK Indicator	LED (Green), The function to know the both of PS operate normally.	
Voltage Balance Indicator	LED (Green), The function to help to get the balance of 2 unit PS output voltage	
Grounding terminal	-	Yes, One for Chassis grounding



Digital multi circuit protector for DC output of power supply

The S8M turns your machine directly into UL Class 2 compliant, maximum tripping current is 3,8 A per channel (adjustable). This unit controls up to 4 circuits. On top of this you will get startup/shutdown—sequence control, display and alarm functions, like voltage, output current, runtime, and over temperature and external reset. These functions can be set by using the front buttons or with the free support tool software. These settings can be protected.

- 4 circuit protection up-to 4 A per channel
- UL Class 2 (max. 3.8 A)
- Emergency stop by external signal
- Optimize use of available power through start-up sequence
- Maintenance control

Ordering information

Input voltage	Communications	UL class 2 output	Size (W × H × D) [mm]	Order code
24 VDC	–	–	75 × 115 × 94	S8M-CP04
	RS-232C	–		S8M-CP04-R
	–	Compliant		S8M-CP04-RS

Specifications

Type	S8M-CP04	S8M-CP04-R	S8M-CP04-RS
Input characteristics	Rated input voltage		
	24 VDC (19.2 to 26.4 VDC)		
	Allowable input current	17.0 A max.	16.0 A max
	Power consumption	10 W max	15 W max
Output characteristics	Number of branches		
	4		
	Max tripping current	4.0 A	3.8 A
	Adjustable tripping range	0.5 to 4.0 A in 0.1 A units	0.5 to 3.8 A in 0.1 A units
	Internal voltage drop	0.5V max at 4 A	0.7V max at 3.8 A
Approved Standards	UL: UL508(Listing), UR 60950-1 cUL, cUR: CSA C22.2 No. 107.1 and No.60950-1 EN/VDE: EN 50178 (=VDE 0160), EN 60950-1 (=VDE 0805)		UL: UL508(Listing, Class 2 per UL 1310), UR 60950-1 cUL, cUR: CSA C22.2 No. 107.1 and No.60950-1 EN/VDE: EN 50178 (=VDE 0160), EN 60950-1 (=VDE 0805)

WHEN TIMING ACCURACY MATTERS!

H5CX – The most complete digital timer

The H5CX series offers multiple-functions and -timing ranges for precise timing control, as well as real twin-timing and memory function. These and other added-value features ensure that the H5CX covers almost every possible user requirement in timers.

- 15 different time functions
- Three color display value, red, orange or green
- Models with instantaneous contact outputs
- 0.001 s to 9999 h, 10 ranges

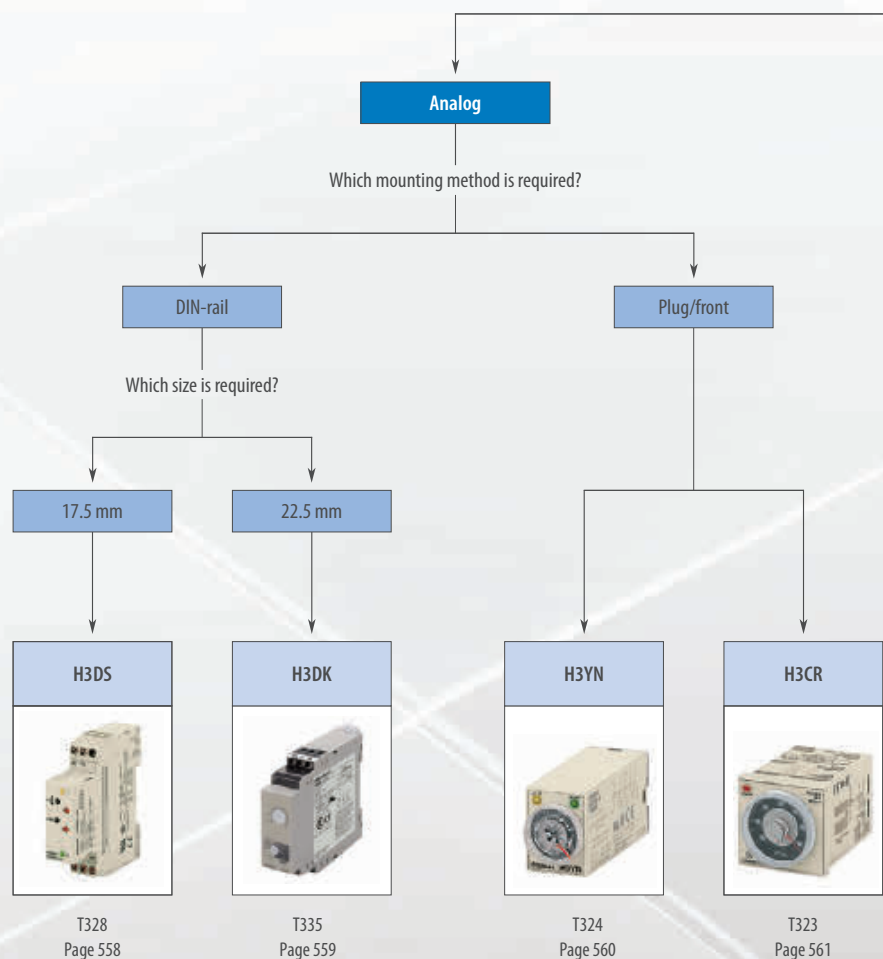



Which type of timer is needed?

Digital

Motor timer

Which size is required?

48×24 mm

48×48 mm

H8GN
timer/counter

H5CX

H2C





















T429
Page 571

T322
Page 562

T338
Page 563

Selection table

Category		Analog solid state timer											
													
Model		H3DS-M	H3DS-S	H3DS-A	H3DS-F	H3DS-G	H3DS-X	H3DK-M	H3DK-S	H3DK-F	H3DK-G	H3DK-H	
Selection criteria	Mounting	DIN-rail											
	Size	17.5 mm						22.5 mm					
	Type	Multi-functional				Twin timer	Star-delta	Two-wired	Multi-functional			Twin timer	Star-delta
Contact configuration	Time limit	■	■	■	■	■	■	■	■	■	■	■	
	Instantaneous	-	-	-	-	-	-	■	■	-	-	-	
	Programmable contacts	-	-	-	-	-	-	■	■	-	-	-	
	14 pins	-	-	-	-	-	-	-	-	-	-	-	
	11 pins	-	-	-	-	-	-	-	-	-	-	-	
	8 pins	-	-	-	-	-	-	-	-	-	-	-	
	Screw terminals	■	■	■	■	■	■	■	■	■	■	■	
	Screw-less clamp terminals	□	□	□	□	□	□	-	-	-	-	-	
Screw-less clamp sockets	-	-	-	-	-	-	-	-	-	-	-		
Inputs	Voltage input	□	□	□	-	-	-	□	□	-	-	-	
	Transistor	-	-	-	-	-	-	-	-	-	-	-	
Outputs	Relay	■	■	■	■	■	■	■	■	■	■	■	
	SCR	-	-	-	-	-	■	-	-	-	-	-	
	Relay output type	SPDT	■	■	■	■	-	-	□	■	■	■ (2x)	■
		SPST-NO	-	-	-	-	■ (2x)	-	-	-	-	-	-
		DPDT	-	-	-	-	-	-	□	■	-	-	-
4PDT		-	-	-	-	-	-	-	-	-	-	-	
Features	Time range	Total time range	0.1 s to 120 h	1 s to 120 h	2 s to 120 h	0.1 s to 12 h	1 s to 120 s	0.1 s to 120 h	0.1 s to 1,200 h	0.1 s to 1,200 h	0.1 s to 1,200 h	1 s to 120 s	0.1 s to 120 s
		Number of sub ranges	7	7	7	6	2	7	12	12	8	2	2 (model dependent)
	Supply voltage	24 to 230 VAC or 24 to 48 VDC	24 to 230 VAC or 24 to 48 VDC	24 to 230 VAC or 24 to 48 VDC	24 to 230 VAC or 24 to 48 VDC	24 to 230 VAC or 24 to 48 VDC	24 to 230 VAC or 24 to 48 VDC	24 to 230 VAC or 24 to 48 VDC	24 to 240 VAC/DC or 12 VDC	24 to 240 VAC/DC or 12 VDC	24 to 240 VAC/DC or 12 VDC	24 to 240 VAC/DC, 240 to 440 VAC, 12 VDC	100 to 120 VAC, 200 to 240 VAC, 24 to 48 VAC/DC
	Number of operating modes	8	4	1	2	1	1	8	4	1	1	1	
Functions	ON-delay	■	■	-	-	-	■	■	■	-	-	-	
	Flicker OFF start	■	-	-	■	-	-	■	-	■	-	-	
	Flicker ON start	■	■	-	■	-	-	■	■	■	-	-	
	Signal ON-/OFF-delay	■	-	-	-	-	-	■	-	-	-	-	
	Signal OFF-delay	■	-	-	-	-	-	■	-	-	-	■	
	Interval (signal or power start)	■	■	-	-	-	-	■	■	-	-	-	
	One-shot output (ON-delay)	■	■	-	-	-	-	■	■	-	-	-	
	ON-delay (fixed)	-	-	■	-	-	-	-	-	-	■	-	
	Independent ON/OFF time setting	-	-	-	-	-	-	-	-	-	-	-	
Remarks	Star-delta	-	-	-	-	■	-	-	-	-	-	-	
	Transistor	-	-	-	-	-	■	-	-	-	-	-	
Page/Quick Link		558						559					

Category		Analog solid state timer					Digital timer		Motor timer	
										
Model		H3YN	H3CR-A	H3CR-F	H3CR-G	H3CR-H	H5CX	H8GN	H2C	
Selection criteria	Mounting	Socket/on panel								
	Size	21.5 mm	1/16 DIN					1/32 DIN	1/16 DIN	
	Type	Miniature	Multi-functional	Twin timer	Star-delta	Power OFF-delay	Multi-functional	Preset counter/timer	Motor timer	
Contact configuration	Time limit	■	■	■	■	■	■	■	■	
	Instantaneous	-	■	-	■	■	■	-	■	
	Programmable contacts	-	-	-	-	-	■	■	-	
	14 pins	■	-	-	-	-	-	-	-	
	11 pins	-	□	□	□	□	□	-	□	
	8 pins	■	□	□	□	□	□	-	□	
	Screw terminals	-	-	-	-	-	□	■	□	
	Screw-less clamp terminals	-	-	-	-	-	-	-	-	
Screw-less clamp sockets	□	-	-	-	-	-	-	-		
Inputs	Voltage input	-	□	-	-	-	-	-	-	
	Transistor	-	□	-	-	-	□	-	-	
Outputs	Relay	■	□	■	■	■	□	■	■	
	SCR	-	-	-	-	-	-	-	-	
	Relay output type	SPDT	-	□	-	-	□	□	■	■
		SPST-NO	-	-	-	■ (2x)	-	-	-	-
		DPDT	□	□	■	-	□	-	-	-
4PDT		□	-	-	-	-	-	-	-	
Features	Time range	Total time range	0.1 s to 10 h (model dependent)	0.05 s to 300 h, 0.1 s to 600 h (model dependent)	0.05 s to 30 h or 1.2 s to 300 h (model dependent)	0.5 s to 120 s	0.05 s to 12 s, 1.2 s to 12 min	0.001 s to 9999 h (configurable)	0.000 s to 9999 h (configurable)	0.2 s to 30 h
		Number of sub ranges	2	9	14	4	4	10	9	15
	Supply voltage	24, 100 to 120, 200 to 230 VAC, 12, 24, 48, 100 to 110, 125 VDC	100 to 240 VAC, 100 to 125 VDC, 24 to 48 VAC, 12 to 48 VDC	100 to 240 VAC, 12 VDC, 24 VAC/DC, 48 to 125 VDC	100 to 120 VAC, 200 to 240 VAC	100 to 120 VAC, 200 to 240 VAC, 24 VAC/DC, 48 VDC, 100 to 125 VDC	100 to 240 VAC, 24 VAC, 12 to 24 VDC	24 VDC	24, 48, 100, 110, 115, 120, 200, 220, 240 VAC	
	Number of operating modes	4	6 (model dependent)	-	1	1	15	6	2	
Functions	ON-delay	■	□	-	-	-	■	■	■	
	Flicker OFF start	■	□	■	-	-	■	■	-	
	Flicker ON start	■	□	■	-	-	■	-	-	
	Signal ON-/OFF-delay	-	□	-	-	-	■	-	-	
	Signal OFF-delay	-	□	-	-	■	■	■	■	
	Interval (signal or power start)	■	□	-	-	-	■	■	-	
	One-shot output (ON-delay)	-	□	-	-	-	■	-	-	
	ON-delay (fixed)	-	-	-	-	-	■	-	-	
	Independent ON/OFF time setting	-	-	-	-	-	■	■	-	
Star-delta	-	-	-	■	-	-	-	-		
Remarks	Transistor	-	□	-	-	-	■	-	-	
	Page/Quick Link	560	561				562	571	563	

■ Standard □ Available - No/not available



DIN-rail mounted, standard 17.5 mm wide solid state timer range

This broad range of timers includes many functionalities and has a wide AC/DC power supply range. Models with screwless clamp connection available.

- 17.5 mm width, modular 45 mm
- DIN-rail mounting
- 24-48 VDC and 24-230 VAC
- 0.1 s to 120 h, 7 ranges

Ordering information

Type	Supply voltage	Control output	Time setting range	Operating modes	Order code	
					Screw terminal type	Screw-less clamp type
Multi-functional timer	24 to 230 VAC (50/60 Hz)/ 24 to 48 VDC	SPDT	0.1 s to 120 h	ON-delay, flicker OFF start, flicker ON start, signal ON/OFF-delay, signal OFF-delay, interval, one-shot	H3DS-ML	H3DS-MLC
Standard timer				ON-delay, flicker ON start, interval, one-shot	H3DS-SL	H3DS-SLC
Single function timer				ON-delay	H3DS-AL	H3DS-ALC
Twin timer		Relay SPDT	0.1 s to 12 h	Flicker OFF start, flicker ON start	H3DS-FL	H3DS-FLC
Star-delta timer		2x Relay SPST-NO	1 s to 120 s	Star-delta	H3DS-GL	H3DS-GLC
Two-wired timer	24 to 230 VAC/VDC (50/60 Hz)	SCR output	0.1 s to 120 h	ON-delay	H3DS-XL	H3DS-XLC

Specifications

Terminal block	Screw terminal type: Clamps two 2.5 mm ² max. bar terminals without sleeves Screw-less clamp type: Clamps two 1.5 mm ² max. bar terminals without sleeves
Mounting method	DIN-rail mounting
Operating voltage range	85 to 110% of rated supply voltage
Power reset	Minimum power-off time: 0.1 s, 0.5 s for H3DS-G
Reset voltage	2.4 VAC/VDC max., 1.0 VAC/VDC max. for H3DS-X
Voltage input	Max. permissible capacitance between input lines (terminals B1 and A2): 2,000 pF Load connectable in parallel with inputs (terminals B1 and A1) H-level: 20.4 to 253 VAC/20.4 to 52.8 VDC L-level: 0 to 2.4 VAC/VDC
Control output	Contact output: 5 A at 250 VAC with resistive load (cosφ = 1) 5 A at 30 VDC with resistive load (cosφ = 1)
Ambient temperature	Operating: -10 to 55°C (with no icing) Storage: -25 to 65°C (with no icing)
Accuracy of operating time	±1% max. of FS (±1% ±10 ms max. at 1.2 s range)
Setting error	±10% ±50 ms max. of FS
Influence of voltage	±0.7% max. of FS (±0.7% ±10 ms max. at 1.2 s range)
Influence of temperature	±5% max. of FS (±5% ±10 ms max. at 1.2 s range)
Life expectancy (not H3DS-X)	Mechanical: 10 million operations min. (under no load at 1,800 operations/h) Electrical: 100,000 operations min. (5 A at 250 VAC, resistive load at 360 operations/h)
Size in mm(HxWxD)	80x17.5x73



DIN-rail mounted, standard 22.5 mm wide solid state timer range

The H3DK series of timers provides a wide AC/DC power supply and time range to reduce the number of items.

- Size in mm (H×W×D): 79×22.5×100
- DIN-rail mounting
- 12 VDC and 24-240 VAC/VDC (except -H). 240-440 VAC for -G
- Wide time setting range: 0.10 s - 1,200 h (except -H and -G), 12 ranges (for -M and -S)

Ordering information

Type	Supply voltage	Control output	Time setting range	Operating modes	Order code
Multi-functional standard timers	12 VDC	SPDT	0.1 s to 1200 h	ON-delay, flicker OFF start, flicker ON start, signal ON/OFF-delay, signal OFF-delay, interval, one-shot	H3DK-M1A DC12
		DPDT			H3DK-M2A DC12 ^{*1}
		SPDT		ON-delay, flicker ON start, interval, one-shot	H3DK-S1A DC12
		DPDT			H3DK-S2A DC12 ^{*1}
	24 to 240 VAC/VDC	SPDT	0.1 s to 1200 h	ON-delay, flicker OFF start, flicker ON start, signal ON/OFF-delay, signal OFF-delay, interval, one-shot	H3DK-M1 AC/DC24-240
		DPDT			H3DK-M2 AC/DC24-240 ^{*1}
		SPDT		ON-delay, flicker ON start, interval, one-shot	H3DK-S1 AC/DC24-240
		DPDT			H3DK-S2 AC/DC24-240 ^{*1}
Twin timer	12 VDC	SPDT	0.1 s to 12 h	Flicker OFF start, flicker ON start	H3DK-FA DC12
	24 to 240 VAC/VDC				H3DK-F AC/DC24-240
Star-delta timer	12 VDC	2× SPDT	1 to 120 s	Star-delta	H3DK-GA DC12
	24 to 240 VAC/VDC				H3DK-G AC/DC24-240
	240 to 440 VAC				H3DK-GE AC/DC240-440
Power OFF-delay timer	24 to 48 VAC/VDC	SPDT	1 to 120 s	Signal OFF-delay	H3DK-HBL AC/DC24-48
			0.1 to 12 s		H3DK-HBS AC/DC24-48
	100 to 120 VAC		1 to 120 s		H3DK-HCL AC100-120V
	200 to 240 VAC		0.1 to 12 s		H3DK-HCS AC100-120V
			1 to 120 s		H3DK-HDL AC200-240V
			0.1 to 12 s		H3DK-HDS AC200-240V

*1 One output can be set to instantaneous.

Specifications

Operating voltage range	85 to 110% of rated supply voltage (90 to 110% for the 12 VDC models).
Power reset	Minimum power-off time: H3DK-M/S, H3DK-F: 0.1 s, H3DK-G: 0.5 s. (Not for H3DK-H)
Reset voltage	10% of rated voltage. (Not for H3DK-H)
Voltage input (H3DK-M/-S)	24 to 240 VAC/DC: H-level 20.4 to 264 VAC/VDC, L-level 0 to 2.4 VAC/VDC. 12 VDC: H-level 10.8 to 13.2 VDC, L-level 0 to 1.2 VDC.
Control output	Contact output: 5 A at 250 VAC with resistive load ($\cos\phi = 1$), 5 A at 24 VDC (30 VDC for -M/-S) with resistive load (not for H3DK-GE)
Ambient temperature	Operating: -20 to 55°C (with no icing), storage: -40 to 70°C (with no icing)
Accuracy of operating time	±1% of FS max. (±1% ±10 ms max. at 1.2 s range)
Setting error	±10% of FS ±0.05 s max.
Minimum input signal width	50 ms (start input) (Only for H3DK-M/S)
Influence of voltage	±0.5% of FS max. (±0.5% ±10 ms max. at 1.2 s range). For H3DK-G: ±0.5% of FS max.
Influence of temperature	±2% of FS max. (±2% ±10 ms max. at 1.2s range). For H3DK-G: ±2% of FS max.
Life expectancy	Mechanical: 10 million operations min. (under no load at 1,800 operations/h)
	Electrical: 100,000 operations min. (5 A at 250 VAC, resistive load at 360 operations/h)
Degree of protection	IP30 (terminal block: IP20)
Terminal block	Clamps two 2.5 mm ² max. bar terminals without sleeves
Size in mm (H×W×D)	79×22.5×100



Miniature timer with multiple time ranges and multiple operating modes

H3YN features 4 multi-operating modes: ON-delay, interval, flicker ON start and flicker OFF start.

- Size in mm (H×W×D): 28×21.5×52.6
- Plug-in
- All supply voltages available
- 0.1 s to 10 h
- DPDT (5A) or 4PDT (3A)

Ordering information

Supply voltage	Functions	Time-limit contact	Order code	
			Short-time range model (0.1 s to 10 min)	Long-time range model (0.1 min to 10 h)
12 VDC	ON-delay Interval Flicker ON Flicker OFF	DPDT	H3YN-2 12DC	H3YN-21 12DC
24 VAC			H3YN-2 24AC	H3YN-21 24AC
24 VDC			H3YN-2 24DC	H3YN-21 24DC
100 to 120 VAC			H3YN-2 100-120AC	H3YN-21 100-120AC
200 to 230 VAC			H3YN-2 200-230AC	H3YN-21 200-230AC
12 VDC		4PDT	H3YN-4 12DC	H3YN-41 12DC
24 VAC			H3YN-4 24AC	H3YN-41 24AC
24 VDC			H3YN-4 24DC	H3YN-41 24DC
100 to 120 VAC			H3YN-4 100-120AC	H3YN-41 100-120AC
200 to 230 VAC			H3YN-4 200-230AC	H3YN-41 200-230AC

Accessories

Connecting socket

Timer	DIN-rail mounting/ front-connecting socket	Back-connecting socket
		PCB terminal
H3YN-2/-21	PYF08A, PYF08A-N, PYF08A-E	PY08-02
H3YN-4/-41	PYF14A, PYF14A-N, PYF14A-E	PY14-02

Hold-down clips

Applicable socket	Order code
PYF08A, PYF08A-N, PYF08A-E, PYF14A, PYF14A-N, PYF14A-E	Y92H-3 (pair)
PY08, PY08-02, PY14-02	Y92H-4

Specifications

Item	H3YN-2/-4	H3YN-21/-41
Time ranges	0.1 s to 10 min (1 s, 10 s, 1 min, or 10 min max. selectable)	0.1 min to 10 h (1 min, 10 min, 1 h, or 10 h max. selectable)
Rated supply voltage	24, 100 to 120, 200 to 230 VAC (50/60 Hz) 12, 24, 48, 100 to 110, 125 VDC	
Pin type	Plug-in	
Operating mode	ON-delay, interval, flicker OFF start, or flicker ON start (selectable with DIP switch)	
Operating voltage range	85 to 110% of rated supply voltage (12 VDC: 90 to 110% of rated supply voltage)	
Reset voltage	10% min. of rated supply voltage	
Control outputs	DPDT: 5 A at 250 VAC, resistive load ($\cos\phi = 1$), 4PDT: 3 A at 250 VAC, resistive load ($\cos\phi = 1$)	
Accuracy of operating time	$\pm 1\%$ FS max. (1 s range: $\pm 1\% \pm 10$ ms max.)	
Setting error	$\pm 10\% \pm 50$ ms FS max.	
Reset time	Min. power-opening time: 0.1 s max. (including halfway reset)	
Influence of voltage	$\pm 2\%$ FS max.	
Influence of temperature	$\pm 2\%$ FS max.	
Ambient temperature	Operating: -10 to 50°C (with no icing), storage: -25 to 65°C (with no icing)	
Degree of protection	IP40	
Size in mm (H×W×D)	28×21.5×52.6	



DIN 48 × 48 mm multi-functional timer series

This elaborate range of solid state timers provides you with a multi-functional timer, twin timer, star-delta timer and a power OFF-delay timer.

- 48 × 48 mm front-panel/plug-in
- High-/low-voltage models (except -H and -G)
- 0.05 s to 300 h (except -H and -G)
- DPDT, 5 A at 250 VAC
- Transistor 100 mA at 30 VDC

Ordering information

Output	Number of pins	Supply voltage	Time range	Operating mode	Order code
Relay DPDT	11	100 to 240 VAC/100 to 125 VDC	0.05 s to 300 h	ON-delay, flicker OFF start, flicker ON start, signal ON/OFF-delay, signal OFF-delay, interval	H3CR-A 100-240AC/100-125DC
		24 to 48 VAC/12 to 48 VDC			H3CR-A 24-48AC/12-48DC
Transistor		24 to 48 VAC/12 to 48 VDC	0.05 s to 300 h		H3CR-AS 24-48AC/12-48DC
Relay DPDT	8	100 to 240 VAC/100 to 125 VDC	0.05 s to 300 h	ON-delay, flicker ON start, interval, one-shot	H3CR-A8 100-240AC/100-125DC
		24 to 48 VAC/12 to 48 VDC			H3CR-A8 24-48AC/12-48DC
Transistor		24 to 48 VAC/12 to 48 VDC	0.05 s to 300 h		H3CR-A8S 24-48AC/12-48DC
Relay SPDT		100 to 240 VAC/100 to 125 VDC			H3CR-A8E 100-240AC/100-125DC
		24 to 48 VAC/VDC			H3CR-A8E 24-48AC/DC
Relay DPDT	11	100 to 240 VAC	0.05 s to 30 h	Flicker OFF start	H3CR-F 100-240AC
		24 VAC/VDC			H3CR-F 24AC/DC
	8	100 to 240 VAC			H3CR-F8 100-240AC
		24 VAC/VDC			H3CR-F8 24AC/DC
	11	100 to 240 VAC	0.05 s to 30 h	Flicker ON start	H3CR-FN 100-240AC
		24 VAC/VDC			H3CR-FN 24AC/DC
8	100 to 240 VAC			H3CR-F8N 100-240AC	
	24 VAC/VDC			H3CR-F8N 24AC/DC	
Time-limit contact and instantaneous contact		100 to 120 VAC		Star-delta	H3CR-G8EL 100-120AC
		200 to 240 VAC			H3CR-G8EL 200-240AC
DPDT	8	100 to 120 VAC	0.05 to 12 s	Power OFF-delay	H3CR-H8LS 100-120AC
		200 to 240 VAC			H3CR-H8LS 200-240AC
		24 VAC/VDC			H3CR-H8LS 24AC/DC
		100 to 120 VAC	0.05 to 12 m		H3CR-H8LM 100-120AC
		200 to 240 VAC			H3CR-H8LM 200-240AC
		24 VAC/VDC			H3CR-H8LM 24AC/DC

Accessories

Name/specifications	Order code	
Flush-mounting adapter	Y92F-30	
Protective cover	Y92A-48B	
Front connecting socket	8-pin, finger-safe type, DIN-rail	P2CF-08-E
Front connecting socket	11-pin, finger-safe type, DIN-rail	P2CF-11-E
Back connecting socket	8-pin	P3G-08
	11-pin	P3GA-11

Name/specifications	Order code	
Time setting ring	Setting a specific time	Y92S-27
	Limiting the setting range	Y92S-28
Panel cover	Light grey (5Y7/1)	Y92P-48GL
	Black (N1.5)	Y92P-48GB

Specifications

Accuracy of operating time	±0.2% FS max. (±0.2% ±10 ms max. in a range of 1.2 s)	
Influence of voltage	±0.2% FS max. (±0.2% ±10 ms max. in a range of 1.2 s)	
Influence of temperature	±1% FS max. (±1% ±10 ms max. in a range of 1.2 s)	
Ambient temperature	Operating: -10 to 55°C (with no icing), storage: -25 to 65°C (with no icing)	
Life expectancy	Mechanical	20,000,000 operations min. (under no load at 1,800 operations/h)
	Electrical	100,000 operations min. (5 A at 250 VAC, resistive load at 1,800 operations/h)
Size in mm (H×W×D)	48×48×66.6 (H3CR-A, -F), 48×48×78 (H3CR-G, -H)	
Setting error	±5% FS ±50 ms	
Degree of protection	IP40 (panel surface)	
Weight	Approx. 90 g	



The most complete digital standard timer on the market

H5CX offers you the most complete series of products on the market today. Based on extensive customer research, these new timers have been designed with value added features that users both need and appreciate.

- Size in mm (H×W×D): 48×48×59 to 78 mm
- Three color display value, red, green or orange
- Models with Instantaneous Contact Outputs
- 0.001 s to 9999 h, 10 ranges
- Input NPN, PNP and contact

Ordering information

Output type	Supply voltage	Functions	External connection	Size in mm (H×W×D)	Inputs	Order code
Contact output	100 to 240 VAC	A: Signal ON-delay	Screw terminals	48×48×84	Signal, Reset, Gate (NPN/PNP inputs)	H5CX-A-N
	12 to 24 VDC/24 VAC	A-1: Signal ON-delay 2		48×48×65		H5CX-AD-N
Transistor output	100 to 240 VAC	A-2: Power ON-delay 1	Screw terminals	48×48×84	Signal, Reset, Gate (NPN/PNP inputs)	H5CX-AS-N
	12 to 24 VDC/24 VAC	A-3: Power ON-delay 2		48×48×65		H5CX-ASD-N
Contact output	100 to 240 VAC	b-1: Repeat cycle 1	11-pin socket	48×48×69.7	Signal, Reset, Gate (NPN/PNP inputs)	H5CX-A11-N
	12 to 24 VDC/24 VAC	b-2: Repeat cycle 2				H5CX-A11D-N
Transistor output	100 to 240 VAC	d: Signal OFF-delay	11-pin socket	48×48×69.7	Signal, Reset, Gate (NPN/PNP inputs)	H5CX-A11S-N
	12 to 24 VDC/24 VAC	E: Interval				H5CX-A11SD-N
Contact output	100 to 240 VAC	F: Cumulative	8-pin socket	48×48×69.7	Signal, Reset (NPN inputs)	H5CX-L8-N
	12 to 24 VDC/24 VAC	Z: ON/OFF-duty adjustable flicker				H5CX-L8D-N
Transistor output	100 to 240 VAC	toff: Twin timer OFF start	8-pin socket	48×48×69.7	Signal, Reset (NPN inputs)	H5CX-L8S-N
	12 to 24 VDC/24 VAC	ton: Twin timer ON start				H5CX-L8SD-N
Contact output Models with instantaneous contact outputs	100 to 240 VAC	A-2: Power ON-delay 1	Screw terminals	48×48×65	-	H5CX-L8E-N
	12 to 24 VDC/24 VAC	b: Repeat cycle 1				H5CX-L8ED-N
Transistor output	100 to 240 VAC	E: Interval	Screw terminals	48×48×65	Signal, Reset, Gate (NPN/PNP inputs)	H5CX-BWSD-N
	12 to 24 VDC	Z: ON/OFF-duty adjustable flicker				H5CX-BWSD-N

Accessories

Name	Order code	
Flush-mounting adapter	Y92F-30	
Waterproof packing	Y92S-29	
Front-connecting socket	8-pin, finger safe type	P2CF-08-E
	11-pin, finger safe type	P2CF-11-E
Back-connecting socket	8-pin	P3G-08
	11-pin	P3GA-11
Hard cover	Y92A-48	
Soft cover	Y92A-48F1	
Front panels (4-digit models)	Light gray	Y92P-CXT4G
	White	Y92P-CXT4S

Specifications

Item	H5CX-A_	H5CX-A11_	H5CX-L8_
Display	7-segment, negative transmissive LCD		
	Present value: 12 mm high characters		
	red, orange or green (programmable)	red	
	Set value: 6 mm high characters, green		
Digits	4 digits		
Total time range	0.001 s to 9,999 h (configurable)		
Timer mode	Elapsed time (Up), remaining time (Down) (selectable)		
Input signals	Signal, reset, gate		Signal, reset
Key protection	Yes		
Memory backup	EEPROM (overwrites: 100,000 times min.) that can store data for 10 years min.		
Ambient temperature	Operating: -10 to 55°C (no icing or condensation), side-by-side mounting: -10 to 50°C		
Case color	Black (N1.5)		



DIN-sized (48×48) motor timer with variable time ranges

This motor timer series provides you with many features, such as ON-delay, time indicator, moving pointer and synchronous motor. Moreover, the LED indicator shows the time operation, time range and the rated voltage.

- DIN-sized 48 × 48mm
- Front-panel/plug-in/DIN-rail
- All supply voltages available
- 0.2 s to 30 h
- SPDT, 6A at 250VAC

Ordering information

Operation/resetting system	Internal connection	Terminal	Time-limit contact	Instantaneous contact	Time range code	Order code
Time-limit operation/ electric resetting	Separate motor and clutch connection	11-pin socket	SPDT	SPDT	1.25 s to 30 h in 5 ranges	H2C-RSA 110AC
						H2C-RSA 220AC
						H2C-RSA 24AC
					0.2 s to 6 h in 5 ranges	H2C-RSB 110AC
						H2C-RSB 220AC
						H2C-RSB 24AC
					0.5 s to 12 h in 5 ranges	H2C-RSC 110AC
						H2C-RSC 220AC
						H2C-RSC 24AC
Time-limit operation/ self-resetting	Separate motor and clutch connection	11-pin socket	SPDT	SPDT	1.25 s to 30 h in 5 ranges	H2C-SA 110AC
						H2C-SA 220AC
						H2C-SA 24AC
					0.2 s to 6 h in 5 ranges	H2C-SB 110AC
						H2C-SB 220AC
						H2C-SB 24AC
					0.5 s to 12 h in 5 ranges	H2C-SC 110AC
						H2C-SC 220AC
						H2C-SC 24AC

Note: Other voltages available on request

Accessories

Name/specifications		Order code
DIN-rail mounting/ front-connecting socket	8-pin, finger safe type	P2CF-08-E
	11-pin, finger safe type	P2CF-11-E
Back-connecting socket	8-pin, screw terminal	P3G-08
	11-pin	P3GA-11

Name/specifications		Order code
Hold-down clip (pair)	For PL08 and PL11 sockets	Y92H-1
	For PF085A socket	Y92H-2
Flush mounting adapter		Y92F-30
Time setting ring		Y92A-Y1

Specifications

Operating voltage range	85 to 110% of rated supply voltage
Reset voltage	10% max. of rated supply voltage
Reset time	Min. power-opening time: 0.5 s, min. pulse width: 0.5 s
Control outputs	6 A at 250 VAC, resistive load ($\cos\phi = 1$)
Mounting method	Flush mounting (except for H2C-F/-FR models), surface-mounting, DIN-rail mounting
Life expectancy	Mechanical: 10,000,000 operations min.
	Electrical: 500,000 operations min.
Motor life expectancy	20,000 h
Accuracy of operating time	$\pm 0.5\%$ FS max. ($\pm 1\%$ max. at 0.2 to 6 s for the time range code B or at 0.5 to 12 s for the time range code C)
Setting error	$\pm 2\%$ FS max.
Reset time	0.5 s max.
Influence of voltage	$\pm 1\%$ FS max.
Influence of temperature	$\pm 2\%$ FS max.
Ambient temperature	Operating: -10 to 50°C
Case color	Light grey (Munsell 5Y7/1)
Degree of protection	IP40 (panel surface)
Size in mm (H×W×D)	48×48×77.5

MULTI-FUNCTIONAL PRESET COUNTER

H7CX – Designed with value added features

The H7CX series offers the ultimate in versatility and intuitive programming.

- 7 basic functions in one
- Switching color on threshold, green, orange & red
- Twin counter mode
- 12 different outputs modes
- Display 6 digits from -100 K +1 up to 1 M -1

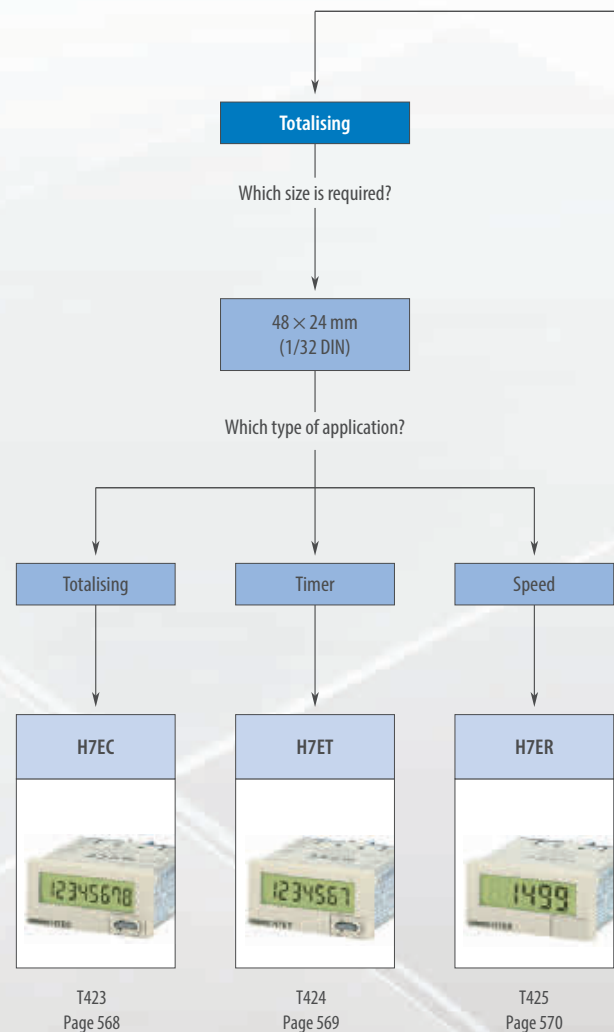



What is the type of counting application?

Pre-set counter
time count

Which size is required?

48 × 24 mm
(1/32 DIN)

48 × 48 mm
(1/16 DIN)

H8GN
counter/timer



T429
Page 571

H7CX



T422
Page 572

Cam positioner

Which size is required?



96 × 96 mm
(1/4 DIN)



H8PS



F424
Page 573

Selection table

Category		Self-powered total	Self-powered timer	Self-powered tachometer
				
Model		H7EC	H7ET	H7ER
Selection criteria	Display	LCD		
	Size	1/32 DIN		
Outputs	Control outputs	-	-	-
	5 stage	-	-	-
	Total	■	■	-
	Time	-	■	-
	Preset	-	-	-
	Batch	-	-	-
	Dual	-	-	-
	Tachometer	■	-	■
Inputs	Control inputs	No-voltage, PNP/NPN, DC-voltage, AC/DC multi-voltage	No-voltage, PNP/NPN, DC-voltage, AC/DC multi-voltage	No-voltage, PNP/NPN
Features	Dual operation	-	-	-
	Number of digits	8	7	4 or 5
	NPN/PNP switch	■	■	■
	Back-lit	□	□	□
	External reset	■	■	-
	Manual reset	■	■	-
	Number of banks	-	-	-
	Built-in sensor power supply	-	-	-
Terminals	IP rating	IP66	IP66	IP66
	Screw terminals	■	■	■
	PCB terminals	-	-	-
Supply voltage	11-pin socket	-	-	-
	100 to 240 VAC	-	-	-
	12 to 24 VDC	-	-	-
Functions	24 VDC	□	□	□
	Comms	-	-	-
	Up	■	■	-
	Down	-	-	-
	Up/down	-	-	-
	Reversible	-	-	-
	Speed	0 to 30 Hz or 0 to 1 kHz	-	1 or 10 kHz
	Counting range	0 to 99999999	0.0 h to 999999.9 h <--> 0.0 h to 3999 d 23.9 h or 0 s to 999 h 59 min 59 s <--> 0.0 min to 9999 h 59.9 min	1000 s-1 or 1000 min-1; 1000 s-1 or 1000 min-1 <--> 10000 min-1
Color	Beige	■	■	■
	Black	■	■	■
Page/Quick Link		568	569	570

Counter type		Pre-set counter/timer	Pre-set counter	Cam positioner
				
Model		H8GN	H7CX	H8PS
Selection criteria	Display	LCD negative transmissive		LCD negative transmissive
	Size	1/32 DIN	1/16 DIN	1/4 DIN
Outputs	Control outputs	1 relay (SPDT)	1 relay (SPDT), transistor	NPN or PNP, cam outputs 8/16/32, run out, tachometer
	5 stage	■	□	–
	Total	■	□	–
	Time	■	–	–
	Preset	■	□	–
	Batch	■	□	–
	Dual	■	□	–
Inputs	Tachometer	–	□	–
	Control inputs	No-voltage	No-voltage, PNP/NPN	Encoder
Features	Dual operation	■	■	□
	Number of digits	PV: 4, SV: 4	PV: 4, SV: 4 or PV: 6, SV: 6	7
	NPN/PNP switch	–	■	–
	Back-lit	–	■	■
	External reset	■	■	–
	Manual reset	■	■	8 (16- and 32-output models only)
	Number of banks	4	–	–
	Built-in sensor power supply	–	■	–
Terminals	IP rating	IP66	IP66	IP40
	Screw terminals	■	■	■
	PCB terminals	–	–	■
Supply voltage	11-pin socket	–	□	–
	100 to 240 VAC	–	■	–
	12 to 24 VDC	–	■	–
	24 VDC	■	–	■
Functions	Comms	□	–	–
	Up	■	■	–
	Down	■	■	–
	Up/down	–	■	–
	Reversible	■	■	–
	Speed	0 to 30 Hz or 0 to 5 kHz	0 to 30 Hz or 0 to 5 kHz	–
	Counting range	-999 to 9999	-99999 to 999999	–
Color	Beige	–	–	■
	Black	■	■	–
Page/Quick Link		571	572	573

■ Standard

□ Available

– No/not available



Self-powered LCD totaliser

The H7E series is available with large display with 8.6 mm character height. It includes models with backlight for improved visibility in dimly lit places. The H7E family includes total counters, time counters, tachometers and PCB mounted counters.

- Size in mm (H×W×D): 24×48×55.5, 1/32 DIN size housing
- 8 digits, 8.6 mm character height
- Black or light-grey housing
- Dual input speed: 30 Hz <-> 1 kHz
- Short body: all models have a depth of 48.5 mm

Ordering information

Count input	Max. counting speed	Display	Order code	
			Light grey body	Black body
No-voltage	30 Hz <-> 1 kHz (switchable)	7-segment LCD	H7EC-N	H7EC-N-B
PNP/NPN universal DC voltage input	30 Hz <-> 1 kHz (switchable)	7-segment LCD	H7EC-NV	H7EC-NV-B
		7-segment LCD with backlight	H7EC-NV-H	H7EC-NV-BH
AC/DC multi-voltage input	20 Hz	7-segment LCD	H7EC-NFV	H7EC-NFV-B

Specifications

Item	H7EC-NV-_/H7EC-NV-_H	H7EC-NFV-_	H7EC-N-_
Operating mode	Up type		
Mounting method	Flush mounting		
External connections	Screw terminals, optional wire-wrap terminals		
Number of digits	8		
Display	7-segment LCD with or without backlight, zero suppression (character height: 8.6 mm)		
Max. counting speed	30 Hz/1 kHz	20 Hz	30 Hz/1 kHz
Case color	Light grey or black (-B models)		
Attachment	Waterproof packing, flush mounting bracket		
Supply voltage	Backlight model: 24 VDC (0.3 W max.) (only for backlight) No-backlight model: Not required (powered by built-in battery)	Not required (powered by built-in battery)	
Count input	High (logic) level: 4.5 to 30 VDC Low (logic) level: 0 to 2 VDC (input impedance: Approx. 4.7 kΩ)	High (logic) level: 24 to 240 VAC/VDC, 50/60 Hz Low (logic) level: 0 to 2.4 VAC/VDC, 50/60 Hz	No voltage input Maximum short-circuit impedance: 10 kΩ max. Short-circuit residual voltage: 0.5 V max. Minimum open impedance: 750 kΩ min.
Reset input		No voltage input Maximum short-circuit impedance: 10 kΩ max. Short-circuit residual voltage: 0.5 V max. Minimum open impedance: 750 kΩ min.	
Minimum signal width	20 Hz: 25 ms, 30 Hz: 16.7 ms, 1 KHz: 0.5 ms		
Reset system	External reset and manual reset: Minimum signal width of 20 ms		
Ambient temperature	Operating: -10 to 55°C (with no condensation or icing), storage: -25 to 65°C (with no condensation or icing)		
Degree of protection	Front-panel: IP66, NEMA4, terminal block: IP20		
Battery life (reference)	7 years min. with continuous input at 25°C (lithium battery)		
Size in mm (H×W×D)	24×48×55.5		



Self-powered time counter

The H7E series is available with large display with 8.6 mm character height. It includes models with backlight for improved visibility in dimly lit places. The H7E family includes total counters, time counters, tachometers and PCB mounted counters.

- Size in mm (H×W×D) 24×48×55.5, 1/32 DIN size housing
- 7 digits, 8.6 mm character height
- Black or light-grey housing
- Dual time range 999999.9 h <-> 3999 d 23.9 h
or 999 h 59 m 59 s <-> 9999 h 59.9 m

Ordering information

Timer input	Display	Order code			
		Time range 999999.9h <-> 3999d23.9h (switchable)		Time range 999h59m59s <-> 9999h59.9m	
		Light grey body	Black body	Light grey body	Black body
No-voltage input	7-segment LCD	H7ET-N	H7ET-N-B	H7ET-N1	H7ET-N1-B
PNP/NPN universal	7-segment LCD	H7ET-NV	H7ET-NV-B	H7ET-NV1	H7ET-NV1-B
DC voltage input	7-segment LCD with backlight	H7ET-NV-H	H7ET-NV-BH	H7ET-NV1-H	H7ET-NV1-BH
AC/DC multi-voltage input	7-segment LCD	H7ET-NFV	H7ET-NFV-B	H7ET-NFV1	H7ET-NFV1-B

Specifications

Item	H7ET-NV _ _/H7ET-NV _ _ H	H7ET-NFV _ _	H7ET-N _ _
Operating mode	Accumulating		
Mounting method	Flush mounting		
External connections	Screw terminals		
Display	7-segment LCD with or without backlight, zero suppression (character height: 8.6 mm)		
Number of digits	7		
Case color	Light grey or black (-B models)		
Attachment	Waterproof packing, flush mounting bracket, time unit labels		
Supply voltage	Backlight model: 24 VDC (0.3 W max.) (for backlight) No-backlight model: Not required (powered by built-in battery)	Not required (powered by built-in battery)	
Timer input	High (logic) level: 4.5 to 30 VDC Low (logic) level: 0 to 2 VDC (Input impedance: Approx. 4.7 kΩ)	High (logic) level: 24 to 240 VAC/VDC, 50/60 Hz Low (logic) level: 0 to 2.4 VAC/VDC, 50/60 Hz	No voltage input Maximum short-circuit impedance: 10 kΩ max. Short-circuit residual voltage: 0.5 V max. Minimum open impedance: 750 kΩ min.
Reset input		No voltage input Maximum short-circuit impedance: 10 kΩ max. Short-circuit residual voltage: 0.5 V max. Minimum open impedance: 750 kΩ min.	
Minimum pulse width	1 s		
Reset system	External reset and manual reset: Minimum signal width of 20 ms		
Ambient temperature	Operating: -10 to 55°C (with no condensation or icing), storage: -25 to 65°C (with no condensation or icing)		
Time accuracy	±100 ppm (25°C)		
Degree of protection	Front-panel: IP66, NEMA4 with waterproof packing, terminal block: IP20		
Battery life (reference)	10 years min. with continuous input at 25°C (lithium battery)		
Size in mm (H×W×D)	24×48×55.5		



Self-powered tachometer

The H7E series is available with large display with 8.6 mm character height. It includes models with backlight for improved visibility in dimly lit places. The H7E family includes total counters, time counters, tachometers and PCB mounted counters.

- Size in mm (H×W×D) 24×48×53.5, 1/32 DIN size housing
- 5 digits, 8.6 mm character height
- Black or light-grey housing
- Dual revolution display

Ordering information

Count input	Display	Order code			
		Max. revolutions displayed (applicable encoder resolution)			
		1,000 s ⁻¹ (1 pulse/rev.) 1,000 min ⁻¹ (60 pulse/rev.)		1,000.0 s ⁻¹ (10 pulse/rev) 1,000.0 min ⁻¹ (600 pulse/rev) <-> 10,000 min ⁻¹ (60 pulse/rev) (switchable)	
		Light grey body	Black body	Light grey body	Black body
No-voltage input	7-segment LCD	H7ER-N	H7ER-N-B		
PNP/NPN universal	7-segment LCD	H7ER-NV	H7ER-NV-B	H7ER-NV1	H7ER-NV1-B
DC voltage input	7-segment LCD with backlight	H7ER-NV-H	H7ER-NV-BH	H7ER-NV1-H	H7ER-NV1-BH

Specifications

Item	H7ER-NV1-_/H7ER-NV1-_H	H7ER-NV-_ /H7ER-NV-_H	H7ER-N-_
Operating mode	Up type		
Mounting method	Flush mounting		
External connections	Screw terminals, wire-wrap terminals		
Display	7-segment LCD with or without backlight, zero suppression (character height: 8.6 mm)		
Number of digits	5	4	
Max. revolutions displayed	1,000.0 s ⁻¹ (when encoder resolution of 10 pulse/rev is used) 1,000.0 min ⁻¹ (when encoder resolution of 600 pulse/rev is used) <-> 10,000 min ⁻¹ (when encoder resolution of 60 pulse/rev is used) (switchable with switch)	1,000 s ⁻¹ (when encoder resolution of 1 pulse/rev is used) 1,000 min ⁻¹ (when encoder resolution of 60 pulse/rev is used)	
Attachment	Waterproof packing, flush mounting bracket, revolution unit labels		
Supply voltage	Backlight model: 24 VDC (0.3 W max.) (for backlight lit) No-backlight model: Not required (powered by built-in battery)		Not required (powered by built-in battery)
Count input	High (logic) level: 4.5 to 30 VDC Low (logic) level: 0 to 2 VDC (Input impedance: Approx. 4.7 kΩ)		No voltage input Maximum short-circuit impedance: 10 kΩ max. Short-circuit residual voltage: 0.5 V max. Minimum open impedance: 750 kΩ min.
Max. counting speed	10 kHz	1 kHz	
Minimum signal width	10 kHz: 0.05 ms, 1 kHz: 0.5 ms		
Ambient temperature	Operating: -10 to 55°C (with no condensation or icing), storage: -25 to 65°C (with no condensation or icing)		
Degree of protection	Front-panel: IP66, NEMA4 with waterproof packing, terminal block: IP20		
Battery life (reference)	7 years min. with continuous input at 25°C (lithium battery)		
Size in mm (H×W×D)	24×48×53.5		



World's smallest compact preset counter/timer

The H8GN is a 1/32 DIN timer and counter in one. It is simple to switch between the timer and counter functions. During operation it is also possible to switch the display to monitor the totalising count value in 8 digits. Many sophisticated functions come as standard with H8GN.

- Size in mm (H×W×D) 24×48×83, 1/32 DIN size housing
- 8 digit display, 4 value and 4 set value
- Front mounting
- –999 to 9999
- 24 VDC

Ordering information

Functions		Supply voltage	Output	Order code	
Counter	Timer			Communications	
				No communications	RS-485
Counter: Up/down/reversible, 4 digits, N, F, C or K output modes Total counter: 8 digits	A: ON-delay B: Flicker D: Signal OFF-delay E: Interval F: Accumulative Z: ON/OFF-duty adjustable flicker	24 VDC	Contact output (SPDT)	H8GN-AD	H8GN-AD-FLK

Specifications

Rated supply voltage		24 VDC
Operating voltage range		85 to 110% of rated supply voltage
Power consumption		1.5 W max. (for max. DC load) (inrush current: 15 A max.)
Mounting method		Flush-mounting
External connections		Screw terminals (M3 screws)
Terminal screw tightening torque		0.5 Nm max.
Attachment		Waterproof packing, flush-mounting bracket
Display		7-segment, negative transmissive LCD; time display (h, min, s); CMW, OUT, RST, TOTAL Present value (red, 7 mm high characters); set value (green, 3.4 mm high characters)
Digits		PV: 4 digits, SV: 4 digits, when total count value is displayed: 8 digits (zeros suppressed)
Memory backup		EEPROM (non-volatile memory) (number of writes: 100,000 times)
Counter	Maximum counting speed	30 Hz or 5 kHz
	Counting range	–999 to 9,999
Input modes		Increment, decrement, individual, quadrature inputs
Timer	Timer modes	Elapsed time (up), remaining time (down)
Inputs	Input signals	For counter: CP1, CP2, and reset For timer: Start, gate, and reset
	Input method	No-voltage input (contact short-circuit and open input) Short-circuit (ON) impedance: 1 kΩ max. (approx. 2 mA runoff current at 0 Ω) Short-circuit (ON) residual voltage: 2 VDC max. Open (OFF) impedance: 100 kΩ min. Applied voltage: 30 VDC max.
	Start, reset, gate	Minimum input signal width: 1 or 20 ms (selectable)
	Power reset	Minimum power-opening time: 0.5 s
Control output		SPDT contact output: 3 A at 250 VAC/30 VDC, resistive load (cosφ = 1)
Minimum applied load		10 mA at 5 VDC (failure level: P, reference value)
Reset system		External, manual, and power supply resets (for timer in A, B, D, E, or Z modes)
Sensor waiting time		260 ms max. (inputs cannot be received during sensor wait time if control outputs are turned OFF)
Timer function	Accuracy of operating time and setting error (including temperature and voltage effects)	Signal start: ±0.03% ±30 ms max. Power-ON start: ±0.03% ±50 ms max.
Ambient temperature	Operating storage	–10 to 55°C (with no icing or condensation)
		–25 to 65°C (with no icing or condensation)
Case color		Rear section: Grey smoke; front section: N1.5 (black)
Degree of protection		Panel surface: IP66 and NEMA Type 4X (indoors); rear case: IP20, terminal block: IP20
Size in mm (H×W×D)		24×48×83



The most complete digital standard counter on the market

H7CX offers you the most complete series of products on the market today. Based on extensive customer research, these new counters have been designed with value added features that users both need and appreciate.

- Size in mm (H×W×D) 48×48×59 to 78 mm 1/16 DIN size housing
- Three color display value, red, green or orange
- Twin counter mode
- 6 digit model –99,999 to 999,999, set value –99,999 to 999,999 or 0 to 999,999
- Input contact, NPN or PNP

Ordering information

Type	External connection	Sensor power supply	Supply voltage	Output type	Digits	Size in mm (H×W×D)	Order code
1-stage counter	Screw terminal	12 VDC	100 to 240 VAC	Contact and transistor output	6	48×48×84	H7CX-AU-N
1-stage counter with total counter			12 to 24 VDC/24 VAC	Transistor output (2×)			H7CX-AUD1-N
2-stage counter							H7CX-AUSD1-N
1-stage counter with batch counter			100 to 240 VAC	Contact output (2×)			H7CX-AW-N
Dual counter (addition/subtraction)							12 to 24 VDC/24 VAC
Tachometer							
Twin counter							
1-stage counter	11-pin socket	12 VDC	100 to 240 VAC	Contact output	6	48×48×69.7	H7CX-A11-N
1-stage counter with total counter			12 to 24 VDC/24 VAC	Transistor output			H7CX-A11D1-N
							100 to 240 VAC
			12 to 24 VDC/24 VAC	Transistor output			
	Screw terminal	12 VDC			100 to 240 VAC	Contact output	6
			100 to 240 VAC	Transistor output	H7CX-AS-N		

Accessories

Name	Order code	
Flush-mounting adapter	Y92F-30	
Waterproof packing	Y92S-29	
DIN-rail mounting/front-connecting socket	11-pin, finger safe type	P2CF-11-E
Back-connecting socket	11-pin	P3GA-11
	Finger safe terminal cover for P3GA-11	Y92A-48G
Hard cover	Y92A-48	
Soft cover	Y92A-48F1	
Front panels (4-digit models)	Light gray	Y92P-CXC4G
	White	Y92P-CXC4S
Front panels (6-digit models)	Light gray	Y92P-CXC6G
	White	Y92P-CXC6S

Specifications

Display	7-segment, negative transmissive LCD
Digits	6-digits: –99,999 to 999,999, SV range: –99999 to 999999 or 0 to 999999
Max. counting speed	30 Hz or 5 kHz (selectable, ON/OFF ratio 1:1)
Input modes	Increment, decrement, increment/decrement (UP/DOWN A (command input), UP/DOWN B (individual inputs), or UP/DOWN C (quadrature inputs))
Control output	Contact output: 3 A at 250 VAC/30 VDC, resistive load (cosφ = 1) Minimum applied load: 10 mA at 5 VDC Transistor output: NPN open collector, 100 mA at 30 VDC Residual voltage: 1.5 VDC max. (approx. 1V) Leakage current: 0.1 mA max.
Key protection	Yes
Decimal point adjustment	Yes (rightmost 3 digits)
Sensor waiting time	290 ms max.
Memory backup	EEPROM (overwrites: 100,000 times min.) stores data 10 years min.
Ambient temperature	Operating: –10 to 55°C (–10 to 50°C when mounted side by side)
Case color	Black (N1.5) (Optional Front Panels are available to change the Front Panel color to light gray or white.)
Life expectancy	Mechanical: 10,000,000 operations min. Electrical: 100,000 operations min. (3 A at 250 VAC, resistive load)
Degree of protection	Panel surface: IP66, NEMA 4 (indoors), and UL Type 4X (indoors)



Compact, easy-to-use cam positioner

The H8PS provides high speed operation at 1,600 r/min and high-precision settings to 0.5° ensuring widespread application. H8PS features a highly visible display with back-lit negative transmissive LCD. Advance angle compensation function compensates for output delays.

- 96 to 121.2H×96W×60.6 to 67.5D mm
- Front-panel / DIN-rail
- 24 VDC
- 8-, 16- and 32-outputs
- NPN/PNP 100 mA at 30 VDC

Ordering information

Number of outputs	Mounting method	Output configuration	Bank function	Size in mm (H×W×D)	Order code
8-outputs	Flush-mounting	NPN transistor output	No	96×96×67.5	H8PS-8B
		PNP transistor output			H8PS-8BP
16-outputs	Front-mounting/DIN-rail mounting	NPN transistor output	Yes	96×96×60.6	H8PS-8BF
		PNP transistor output			H8PS-8BFP
	Flush-mounting	NPN transistor output		96×96×67.5	H8PS-16B
		PNP transistor output		96×96×67.5	H8PS-16BP
32-outputs	Front-mounting/DIN-rail mounting	NPN transistor output	121.2×96×60.6	H8PS-16BF	
		PNP transistor output	121.2×96×60.6	H8PS-16BFP	
	Flush-mounting	NPN transistor output	96×96×67.5	H8PS-32B	
		PNP transistor output	96×96×67.5	H8PS-32BP	
Front-mounting/DIN-rail mounting	NPN transistor output	121.2×96×60.6	H8PS-32BF		
	PNP transistor output	121.2×96×60.6	H8PS-32BFP		

Encoders

Type	Resolution	Cable length	Order code
Economy	256	2 m	E6CP-AG5C-C 256 2M
Standard	256	1 m	E6C3-AG5C-C 256 1M
		2 m	E6C3-AG5C-C 256 2M
	360		E6C3-AG5C-C 360 2M
	720		E6C3-AG5C-C 720 2M
Rigid	256	2 m	E6F-AG5C-C 256 2M
	360		E6F-AG5C-C 360 2M
	720		E6F-AG5C-C 720 2M

Accessories

Name	Specification	Order code
Discrete wire output cable	2 m	Y92S-41-200
Connector-type output cable	2 m	E5ZE-CBL200
Support software	CD-ROM	H8PS-SOFT-V1
USB cable	A miniB, 2 m	Y92S-40
Parallel input adapter	Two units can operate in parallel	Y92C-30
Protective cover		Y92A-96B
Watertight cover		Y92A-96N
DIN-rail mounting base		Y92F-91

Encoder accessories

Name	Specification	Order code
Shaft coupling for the E6CP	Axis: 6 mm dia.	E69-C06B
Shaft coupling for the E6C3	Axis: 8 mm dia.	E69-C08B
Shaft coupling for the E6F	Axis: 10 mm dia.	E69-C10B
Extension cable	5 m (same for E6CP, E6C3, and E6F)	E69-DF5

Specifications

Rated supply voltage		24 VDC
Inputs	Encoder input	8-output models: None; 16-/32-output models: Bank inputs 1/2/4, origin input, start input
	External inputs	Input signals Input type
		8-output models: None; 16-/32-output models: Bank inputs 1/2/4, origin input, start input
		No voltage inputs: ON impedance: 1 kΩ max. (leakage current: Approx. 2 mA at 0 Ω) ON residual voltage: 2 V max., OFF impedance: 100 kΩ min., applied voltage: 30 VDC max. Minimum input signal width: 20 ms
Number of banks		8 banks (for 16-/32-output models only)
Display method		7-segment, negative transmissive LCD (main display: 11 mm (red), sub-display: 5.5 mm (green))
Memory backup method		EEPROM (overwrites: 100,000 times min.) that can store data for 10 years min.
Ambient operating temperature		-10 to 55°C (with no icing or condensation)
Storage temperature		-25 to 65°C (with no icing or condensation)
Ambient humidity		25 to 85%
Degree of protection		Panel surface: IP40, rear case: IP20
Case color		Light grey (Munsell 5Y7/1)

Programmable relays



ZEN - SIMPLICITY AT ITS BEST

The ZEN series offers simple logic control for a wide variety of applications. With many on-board functions like season and weekly timers, counters, analog inputs and using the ladder logic, you can automate the application very quickly. Adjustments and maintenance is easy using the models with an LCD.

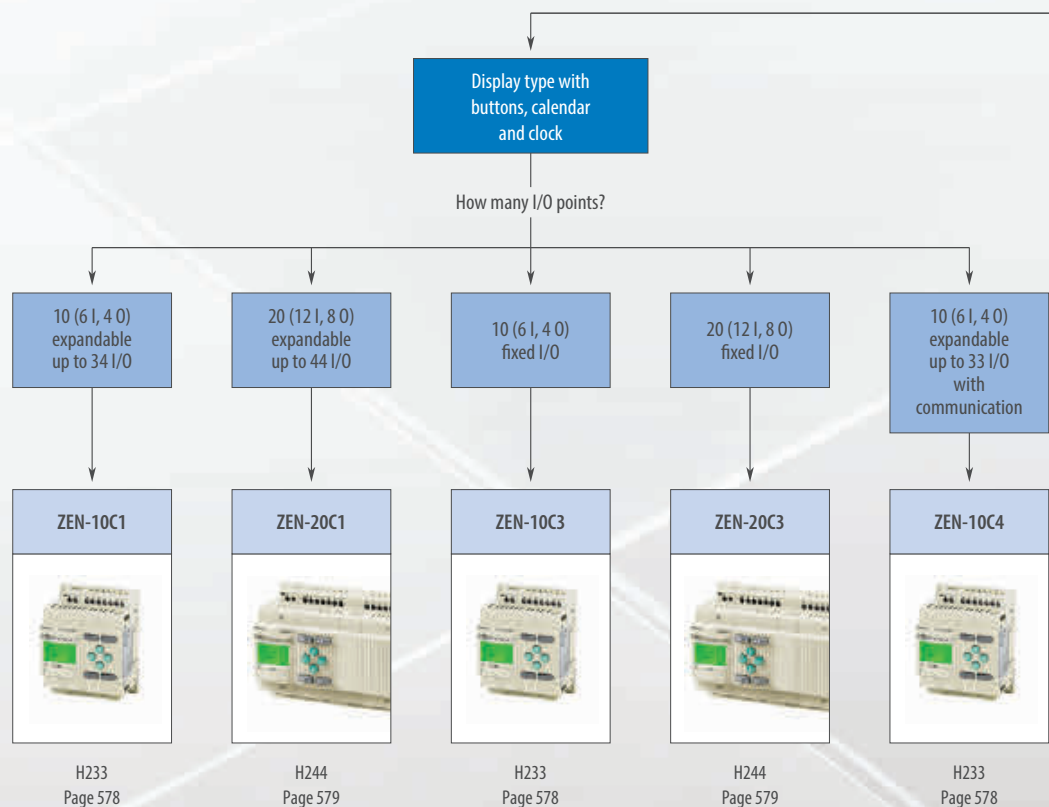
- RS-485 communication
- Expandable I/O
- Memory Data backup

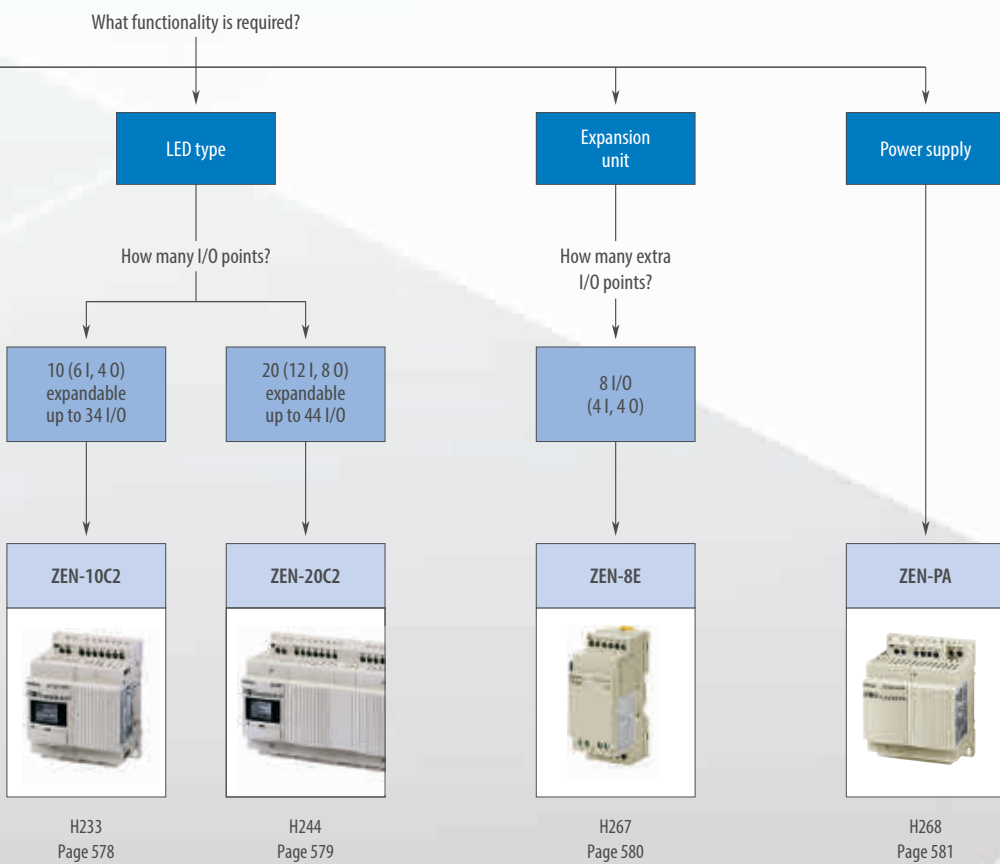



				
Model	ZEN-10C	ZEN-20C		
Type	CPU unit	CPU unit		
Features C1	With LCD Display, program/control buttons, calendar and real-time clock	With LCD display, program/control buttons, calendar and real-time clock		
Features C2	With LED indication Logic control Programming by software	With LED indication Logic control Programming by software		
Features C3	Same as C1 but not expandable.	Same as C1 but not expandable.		
Features C4	Same as C1 but instead of one output relay you get RS-485 communication.	-		
Features Starter kits	Complete set with C1 CPU including software, cable and manual	-		
Number of I / O points	10 expandable up to 34 I/O (C4 up to 33 I/O)	20 expandable up to 44 I/O		
Inputs	6	12		
Inputs/power supply	100 to 240 VAC or 12 to 24 VDC	100 to 240 VAC or 12 to 24 VDC		
Outputs	4 relays (C4 = 3 relays) or 4 transistors	8 relays or 8 transistors		
Page/Quick Link	578	579		



Flexible automation

The ZEN-10C offers simple logic control in a choice of four CPU units. Expansion is possible on three of these CPU's of up to 34 I/O whereas the fourth (C3 Units) is fixed at 10 I/O. All DC models have analog input and a high-speed counter input up to 150 Hz.

- DC input/supply units have analog input + high speed counter
- The ZEN-10C4 has RS-485 communication
- Expansion available with relay output or transistor output
- ZEN-Kits the best choice to start!

Ordering information

Name	Number of I/O points	Inputs (I)/ power supply	Outputs (Q)	Type	LCD, buttons (B), calendar and clock	Analog input/ comparators (A)	8-digit counter (F)/ comparators (G)	No. of bits 16	No. of bits 8	Size in mm (H×W×D)	Order code		
CPU units	10 Expandable up to 34 I/O	6	100 to 240 VAC	4	Relays	LCD	yes	–	–	Work bits (M) Holding bits (H) Timers (T) Counters (C) Weekly timers (@) LCD display (D) Timer/counter comparator (P)	Holding timers (#) Button input (B)	90×70×56	ZEN-10C1AR-A-V2
						LED	–	–	–				ZEN-10C2AR-A-V2
		12 to 24 VDC	LCD			yes	yes / 4	yes / 4	ZEN-10C1DR-D-V2				
			LED			–	yes / 4	yes / 4	ZEN-10C2DR-D-V2				
	Fixed I/O	100 to 240 VAC	3	Relays	LCD	yes	yes / 4	yes / 4	ZEN-10C1DT-D-V2				
					LED	–	yes / 4	yes / 4	ZEN-10C2DT-D-V2				
		12 to 24 VDC			LCD	yes	–	yes / 4	ZEN-10C3AR-A-V2				
					LED	yes	yes / 4	yes / 4	ZEN-10C3DR-D-V2				
10 Expandable up to 33 I/O	100 to 240 VAC	3	Relays	LCD/ Comm.	yes	–	yes / 4	ZEN-10C4AR-A-V2					
				LCD/ Comm.	yes	yes / 4	yes / 4	ZEN-10C4DR-D-V2					
ZEN kit	Set containing CPU unit (ZEN-10C1AR-A-V2), connecting cable, ZEN support software and manual.										ZEN-KIT01-EV4		
	Set containing CPU unit (ZEN-10C1DR-D-V2), connecting cable, ZEN support software and manual.										ZEN-KIT02-EV4		

Specifications

Item	Specifications	
	ZEN-10C_AR-A-V2	ZEN-10C_D_-D-V2
Power supply voltage	100 to 240 VAC, 50/60 Hz	12 to 24 VDC (DC ripple rate: 5%)
Rated power supply voltage	85 to 264 VAC	10.8 to 28.8 VDC
Power consumption	9 VA max.	4 W max.
Inrush current	3 A max.	30 A max.
Ambient temperature	0°C to 55°C (–25°C to 55°C for ZEN-10C2 models (LED))	
Ambient storage	–20°C to 55°C (–40°C to 75°C for ZEN-10C2 models (LED))	
Control method	Stored program control	
I/O control method	Cyclic scan	
Programming language	Ladder diagram	
Program capacity	96 lines (3 input conditions and 1 output per line)	
LCD display	12 characters x 4 lines, with backlight (LCD-type CPU unit only)	
Operation keys	8 (4 cursor keys and 4 operation keys) (LCD-type CPU unit only)	
Super-capacitor holding time	2 days min. (25°C)	
Battery life (ZEN-BAT01)	10 years min. (25°C)	
Calendar & Clock function	Accuracy: ±15 s/month (at 25°C)	

Accessories

Name	Description	Order code
Memory Cassette	EEPROM (for data security and copying)	ZEN-ME01
Battery unit	Battery (keeps time, date and bit values for 10 years at 25°C)	ZEN-BAT01
Connecting Cable	For the programming software, RS-232C cable, 9-way 'D' connector for PC	ZEN-CIF01
USB-Serial conversion cable	USB-Serial conversion cable (to be used in combination with ZEN-CIF01)	CS1W-CIF31
ZEN support software	Runs on Windows ME, 2000, XP, NT4.0 Service Pack 3, Vista	ZEN-SOFT01-V4



Extended flexible automation

Ideal for small-scale control applications, the ZEN-20C provides an economical alternative to discrete timers, counters and general purpose relays. With 12 Inputs and 8 relay or transistor Outputs, and expansion possibilities of up to 44 I/O on C1 and C2 models, the ZEN-20C offers extended flexibility, with features such as calendar and real time clock functionality.

- ZEN-20C1/C2 expandable up to 44 I/Os
- ZEN DC units have analog input 0-10 VDC
- DC models have as well high speed counter 150 Hz
- Expansion available with relay output or transistor output

Ordering information

Name	Number of I/O points	Inputs (I)/ power supply	Outputs (Q)	Type	LCD, buttons (B), calendar and clock	Analog input/comparators (A)	8-digit counter (F)/ comparators (G)	No. of bits 16	No. of bits 8	Size in mm (H×W×D)	Order code		
CPU units	20	12	100 to 240 VAC	8	Relays	LCD	yes	–	–	Work bits (M) Holding bits (H) Timers (T) Counters (C) Weekly timers (@) LCD display (D) Timer/counter comparator (P)	Holding timers (#) Button input (B)	90×122.5×56	ZEN-20C1AR-A-V2
						LED	–	–	–				ZEN-20C2AR-A-V2
						LCD	yes	yes / 4	yes / 4				ZEN-20C1DR-D-V2
						LED	–	yes / 4	yes / 4				ZEN-20C1DR-D-V2
	Expandable up to 44 I/O	12	12 to 24 VDC	8	Transistors	LCD	yes	yes / 4	yes / 4	LCD display (D)	ZEN-20C1DT-D-V2		
						LED	–	yes / 4	yes / 4	Timer/counter comparator (P)	ZEN-20C2DT-D-V2		
						LCD	yes	–	yes / 4	ZEN-20C3AR-A-V2			
						LCD	yes	yes / 4	yes / 4	ZEN-20C3DR-D-V2			
Fixed I/O	12	100 to 240 VAC	8	Relays	LCD	yes	–	yes / 4	ZEN-20C3AR-A-V2				
					LCD	yes	yes / 4	yes / 4	ZEN-20C3DR-D-V2				
Fixed I/O	12	12 to 24 VDC	8	Relays	LCD	yes	–	yes / 4	ZEN-20C3AR-A-V2				
					LCD	yes	yes / 4	yes / 4	ZEN-20C3DR-D-V2				

Specifications

Item	Specifications	
	ZEN-20C_AR-A-V2	ZEN-20C_D_-D-V2
Power supply voltage	100 to 240 VAC, 50/60 Hz	12 to 24 VDC (DC ripple rate: 5%)
Rated power supply voltage	85 to 264 VAC	10.8 to 28.8 VDC
Power consumption	11 VA max.	5 W max.
Inrush current	4 A max.	30 A max.
Ambient temperature	0°C to 55°C (–25°C to 55°C for ZEN-20C2 models (LED))	
Ambient storage	–20°C to 55°C (–40°C to 75°C for ZEN-20C2 models (LED))	
Control method	Stored program control	
I/O control method	Cyclic scan	
Programming language	Ladder diagram	
Program capacity	96 lines (3 input conditions and 1 output per line)	
LCD display	12 characters x 4 lines, with backlight (LCD-type CPU unit only)	
Operation keys	8 (4 cursor keys and 4 operation keys) (LCD-type CPU unit only)	
Super-capacitor holding time	2 days min. (25°C)	
Battery life (ZEN-BAT01)	10 years min. (25°C)	
Calendar & Clock function	Accuracy: ±15 s/month (at 25°C) if applicable	

Accessories

Name	Description	Order code
Memory Cassette	EEPROM (for data security and copying)	ZEN-ME01
Battery unit	Battery (keeps time, date and bit values for 10 years at 25°C)	ZEN-BAT01
Connecting Cable	For the programming software, RS-232C cable, 9-way 'D' connector for PC	ZEN-CIF01
USB-Serial conversion cable	USB-Serial conversion cable (to be used in combination with ZEN-CIF01)	CS1W-CIF31
ZEN support software	Runs on Windows ME, 2000, XP, NT4.0 Service Pack 3, Vista	ZEN-SOFT01-V4



ZEN Expansion units

To scale-up your ZEN application we provide three different expansion units in only 35 mm width ZEN housing. All expansion units have standard 4 inputs and 4 outputs. You can add maximum 3 expansion units to one CPU.

- 4 inputs, 100 to 240 VAC or 12 to 24 VDC
- 4 outputs, either relays or transistors (only DC models)
- DIN-rail mounting
- Size in mm (H×W×D): 90×35×56

Ordering information

Name	Number of I/O points	Inputs (X)/power supply	Outputs (Y)	Size in mm (H×W×D)	Order code
Expansion I/O units	8	4 100 to 240 VAC 12 to 24 VDC	4 Relays	90×35×56	ZEN-8E1AR
			4 Transistors		ZEN-8E1DR
					ZEN-8E1DT

Specifications

Item	Specifications	
	ZEN-8E1AR	ZEN-8E1D
Power supply voltage	100 to 240 VAC, 50/60 Hz	12 to 24 VDC (DC ripple rate: 5% max.)
Rated power supply voltage	85 to 264 VAC	10.8 to 28.8 VDC
Power consumption	4 VA max.	2 W max.
Inrush current	1.5 A max.	15 A max.
Ambient temperature	0°C to 55°C (–25°C to 55°C for ZEN-10C2 models (LED))	
Ambient storage	–20°C to 55°C (–40°C to 75°C for ZEN-10C2 models (LED))	



ZEN Power Supply

The ZEN Power Supply has the same compact housing as our 10 I/O CPU units. With a current/wattage output of 1.3 A/30 W it covers enough power to supply the DC ZEN itself and the eventually used sensors. If needed parallel operation is possible.

- Output voltage 24 VDC
- Output current 1.3 A
- Capacity 30 W
- Allows parallel operation
- Size in mm (H×W×D): 90×70×56

Ordering information

Power rating	Inputs voltage	Output current	Order code
30 W	100 to 240 VAC	1.3 A	ZEN-PA03024

Specifications

Item	Specifications	
Power rating	30 W	
Efficiency	80% min. (24 V)	
Input voltage	100 to 240 VAC (85 to 264 VAC), single-phase	
Output voltage	Voltage adjustment	±10% to ±15% (with V. ADJ) min. of rate output voltage
	Ripple	2% (p-p) max. (-25°C to -10°C: 4% max.)
	Input variation	0.5% max.
	Temperature	0.05% / °C max.
Overload protection	105% to 135% of rated load current, inverted L drop, intermittent	
Overvoltage protection	yes	
Input Current	100 V	0.8 A max.
	200 V	0.45 A max.
Output indicator	yes (green)	
Weight	240 g max.	
Operating temperature	-10°C to 60°C	
Parallel operation	yes (2 units max.)	

Digital panel indicators

LOOKING FOR PERFECT MEASURING & READ-OUT?

K3HB-V – For perfect weighing

With our K3HB series we cover a wide range of applications. One of them is the weighing indicator which performs perfect measurement in any weighing application. The instrument can be equipped with a load-cell power supply of 10V/100mA. Several option boards for communication, contact output boards or event inputs are also available. On top of these you can get direct DeviceNet communication.

- High speed sampling 20 ms
- Equipped with position meter
- Two color display for easy recognition

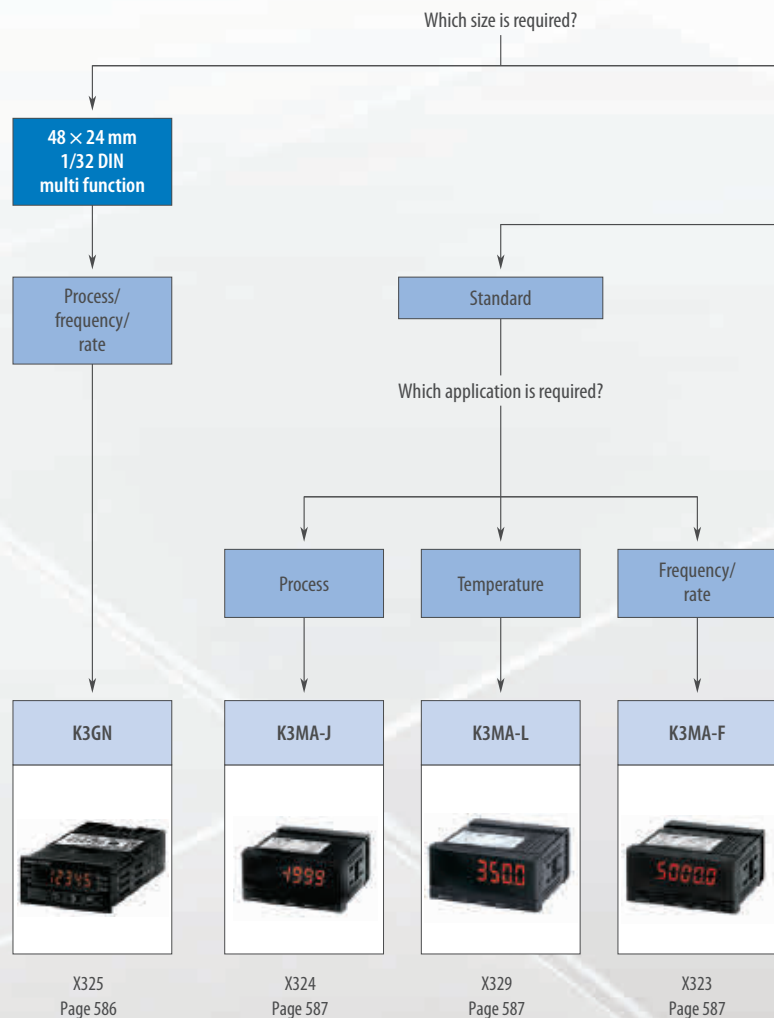



96 × 48 mm
(1/8 DIN)

Advanced

Which application is required?

Process

Temperature

Weighing

Linear sensor

Up/down
counting pulse

Time interval

Rotary pulse

K3HB-X

K3HB-H

K3HB-V

K3HB-S

K3HB-C

K3HB-P

K3HB-R



X335
Page 588

X332
Page 588

X334
Page 588





X333
Page 588

X326
Page 590

X327
Page 590

X328
Page 590

Selection table

Category	Multifunctional digital panel indicator	Process indicator	Temperature indicator	Frequency/rate indicator	Process indicator	
						
Model	K3GN	K3MA-J	K3MA-L	K3MA-F	K3HB-X	
Size	1/32 DIN	1/8 DIN				
Features	Color change display	■	■	■	■	
	Number of digits	5	5	4	5	
	Leading zero suppression	■	■	■	■	
	Forced zero function	■	■	■	■	
	Min./max. hold function	■	■	■	■	
	Average processing	■	■	■	■	
	User selectable inputs	■	■	■	■	
	Start-up compensating time	■	–	–	■	
	Key protection	■	■	■	■	
	Decimal point position setting	■	■	■	■	
Accuracy	±0.1% of full scale	±0.1% of full scale	±0.1% of full scale	±0.1% of full scale	±0.1% of full scale (DC voltage & DC current), ±0.5% of full scale (AC voltage & AC current)	
Input range	0 to 20 mA, 4 to 20 mA or 0 to 5 V, 1 to 5 V, -5 to 5 V, -10 to 10 V or 0 to 30 Hz or 0 to 5 kHz	0 to 20 mA, 4 to 20 mA or 0 to 5 V, 1 to 5 V, -5 to 5 V, -10 to 10 V	Pt100, JPt100 or thermocouple K, J, T, E, L, U, N, R, S, B	0 to 30 Hz or 0 to 5 kHz	0.000 to 10.000 A, 0.0000 to 19.999 mA, -199.99 to 199.99 mA, 4.000 to 20.000 mV, 0.0 to 400.0 V, 0.0000 to 1.999 V, -199.99 to 199.99 V, 1.0000 to 5.0000 V	
Sample rate	250 ms	250 ms	500 ms	–	20 ms	
Features	Remote/local processing, parameter initialisation, programmable output configuration, process value hold	Teaching, comparative output pattern selection, parameter initialisation, programmable output configuration, process value hold	Programmable output configuration, process value hold	Teaching, comparative output pattern selection, programmable output configuration, process value hold	Scaling, teaching, averaging, output hysteresis, output OFF-delay, output test, bank selection, reset, comparative output	
Sensor power supply	–	–	–	■	□	
Front protection	IP66	IP66	IP66	IP66	IP66	
Supply voltage	24 VDC	24 VAC/VDC or 100 to 240 VAC	24 VAC/VDC or 100 to 240 VAC	24 VAC/VDC or 100 to 240 VAC	100 to 240 VAC or 24 VAC/VDC	
Inputs	NPN	■	–	■	■	□
	PNP	■	–	■	■	□
	Temperature	–	–	–	–	–
	Contact	–	–	–	■	–
	Voltage pulse	–	–	–	■	–
	Load cell	–	–	–	–	–
	DC voltage	■	■	■	–	□
	DC current	■	■	–	–	□
	AC voltage	–	–	–	–	□
AC current	–	–	–	–	□	
Outputs	Relay	■	■	■	■	□
	NPN	■	–	–	–	□
	PNP	■	–	–	–	□
	Linear	–	–	–	–	□
	BCD	–	–	–	–	–
	Comms	■	–	–	–	□
Page/Quick Link	586	587			588	

Temperature indicator	Weighing indicator	Linear sensor indicator	Up/down counting pulse indicator	Time interval indicator	Rotary pulse indicator
K3HB-H	K3HB-V	K3HB-S	K3HB-C	K3HB-P	K3HB-R
1/8 DIN					
■	■	■	■	■	■
5	5	5	5	5	5
■	■	■	■	■	■
■	■	■	■	■	■
■	■	■	■	■	■
■	■	■	■	■	■
■	■	■	■	■	■
■	■	■	■	■	■
■	■	■	■	■	■
■	■	■	■	■	■
Thermocouple: ±0.3% of full scale, Pt-100: ±0.2% of full scale	±0.1% of full scale	One input: ±0.1% of full scale, two inputs: ±0.2% of full scale		±0.08% rgd ±1 digit	±0.006% rgd ±1 digit ±0.02% rgd ±1 digit
Pt100, thermocouple K, J, T, E, L, U, N, R, S, B, W	0.00 to 199.99 mV, 0.000 to 19.999 mV, 100.00 mV, 199.99 mV	0 to 20 mA, 4 to 20 mA, 0 to 5 V, -5 to 5 V, -10 to 10 V	No voltage contact: 30 Hz, voltage pulse: 50 kHz, open collector: 50 kHz	No voltage contact: 30 Hz, voltage pulse: 50 kHz, open collector: 50 kHz	No voltage contact: 30 Hz, voltage pulse: 50 kHz, open collector: 50 kHz
20 ms	20 ms	0.5 ms	–	–	–
Scaling, teaching, averaging, output hysteresis, output OFF-delay, output test, bank selection, reset, comparative output	Scaling, teaching, averaging, output hysteresis, output OFF-delay, output test, bank selection, reset, comparative output	Scaling, 2-input calculation, teaching, averaging, output hysteresis, output OFF-delay, output test, bank selection, reset, comparative output	Scaling, measurement operation selection, output hysteresis, output OFF-delay, output test, display value selection, display color selection, key protection, bank selection, display refresh period, maximum/minimum hold, reset	Scaling, measurement operation selection, output hysteresis, output OFF-delay, output test, teaching, display value selection, display color selection, key protection, bank selection, display refresh period, maximum/minimum hold, reset	Scaling, measurement operation selection, averaging, previous average value comparison, output hysteresis, output OFF-delay, output test, teaching, display value selection, display color selection, key protection, bank selection, display refresh period, maximum /minimum hold, reset
□	□	□	□	□	□
IP66	IP66	IP66	IP66	IP66	IP66
100 to 240 VAC or 24 VAC/VDC	100 to 240 VAC or 24 VAC/VDC	100 to 240 VAC or 24 VAC/VDC	100 to 240 VAC or 24 VAC/VDC	100 to 240 VAC or 24 VAC/VDC	100 to 240 VAC or 24 VAC/VDC
□	□	□	■	■	■
□	□	□	■	■	■
■	–	–	–	–	–
–	–	–	–	–	–
–	–	–	■	■	■
–	■	–	–	–	–
–	–	■	–	–	–
–	–	■	–	–	–
–	–	–	–	–	–
–	–	–	–	–	–
□	□	□	□	□	□
□	□	□	□	□	□
□	□	□	□	□	□
□	□	□	□	□	□
–	–	–	□	□	□
□	□	□	□	□	□
588			590		

■ Standard □ Available – No/not available



Compact and intelligent digital panel meter

The K3GN is able to cover a wide variety of applications with its 3 main functions: process meter, RPM processor/tachometer and digital data display for PC/PLC. Configuration is easy and the design is advanced and compact.

- Process indicator DC voltage/current
- RPM process/tachometer
- Digital data display for PC/PLC
- Very compact 1/32 DIN housing: Size in mm (HxWxD): 24x48x83mm
- 5-digit display with programmable display color, in red or green

Ordering information

Input type	Supply voltage	Output	Order code	
			No communications	RS-485
DC voltage/current, NPN	24 VDC	Dual relays (SPST-NO)	K3GN-NDC 24 DC	K3GN-NDC-FLK 24 DC
		Three NPN open collector	K3GN-NDT1 24 DC	K3GN-NDT1-FLK 24 DC
DC voltage/current, PNP		Dual relays (SPST-NO)	K3GN-PDC 24 DC	K3GN-PDC-FLK 24 DC
		Three PNP open collector	K3GN-PDT2 24 DC	K3GN-PDT2-FLK 24 DC

Specifications

Supply voltage	24 VDC
Operating voltage range	85 to 110% of the rated supply voltage
Power consumption	2.5 W max. (at max. DC load with all indicators lit)
Ambient temperature	Operating: -10 to 55°C (with no condensation or icing) Storage: -25 to 65°C (with no condensation or icing)
Display refresh period	Sampling period (sampling times multiplied by number of averaging times if average processing is selected)
Max. displayed digits	5 digits (-19999 to 99999)
Display	7-segment digital display, character height: 7.0 mm
Polarity display	"-" is displayed automatically with a negative input signal
Zero display	Leading zeros are not displayed
Scaling function	Programmable with front-panel key inputs (range of display: -19999 to 99999). The decimal point position can be set as desired.
External controls	HOLD: (measurement value held) ZERO: (forced-zero)
Hysteresis setting	Programmable with front-panel key inputs (0001 to 9999)
Other functions	Programmable color display Selectable output operating action Teaching set values Average processing (simple average) Lockout configuration Communications writing control (communications output models only)
Output	Relays: 2 SPST-NO Transistors: 3 NPN open collector 3 PNP open collector Combinations: Communications output (RS-485) + relay outputs Communications output (RS-485) + transistor outputs Communications output (RS-485) + transistor outputs (3 PNP open collector)
Communications	Communications function: RS-485
Delay in comparative outputs (transistor outputs)	750 ms max.
Degree of protection	Front-panel: NEMA4X for indoor use (equivalent to IP66) Rear case: IEC standard IP20 Terminals: IEC standard IP20
Memory protection	Non-volatile memory (EEPROM) (possible to rewrite 100,000 times)
Size in mm (HxWxD)	24x48x80



Highly visible LCD display with 2 color (red and green) LEDs

The K3MA series comes with a process meter, a frequency/rate meter and a temperature meter of either 100 to 240 VAC or 24 VAC/VDC. All are equipped with the same quality display and have the same short depth of 80 mm.

- 1/8 DIN size housing
- Highly visible, negative transmissive backlit LCD display
- 14.2 mm high characters
- 5 digits (–19,999 to 99,999), K3MA-L: 4 digits
- Front-panel IP66

Ordering information

Indicator	Supply voltage	Input type & ranges	Output	Order code
Process meter	100 to 240 VAC	DC voltage: 0 to 5 V, 1 to 5 V, -5 to 5 V, -10 to 10 V DC current: 0 to 20 mA, 4 to 20 mA	2 relay contact outputs (SPST-NO)	K3MA-J-A2 100-240VAC
	24 VAC/VDC		2 relay contact outputs (SPST-NO)	K3MA-J-A2 24VAC/VDC
Temperature meter	100 to 240 VAC	Platinum-resistance thermometer: Pt100, JPt100 or thermocouple K, J, T, E, L, U, N, R, S, B	1 relay contact output (SPDT)	K3MA-L-C 100-240VAC
	24 VAC/VDC		1 relay contact output (SPDT)	K3MA-L-C 24VAC/VDC
Frequency/rate meter	100 to 240 VAC	Rotary pulse: No voltage: 0.05 to 30.00 Hz; open collector: 0.1 to 5000.0 Hz	2 relay contact outputs (SPST-NO)	K3MA-F-A2 100-240VAC
	24 VAC/VDC		2 relay contact outputs (SPST-NO)	K3MA-F-A2 24VAC/VDC

Accessories

Type	Order code
Splash-proof soft cover	K32-49SC
Hard cover	K32-49HC

Specifications

Item	100-240 VAC models	24 VAC/VDC models
Supply voltage	100 to 240 VAC	24 VAC (50/60 Hz), 24 VDC
Operating voltage range	85 to 110% of the rated supply voltage	
Power consumption (under maximum load)	6 VA max.	4.5 VA max. (24 VAC) 4.5 W max. (24 VDC)
Ambient temperature	Operating: –10 to 55°C (with no condensation or icing) Storage: –25 to 65°C (with no condensation or icing)	
Weight	Approx. 200 g	
Display	7-segment digital display, character height: 14.2 mm	
Polarity display	"–" is displayed automatically with a negative input signal	
Zero display	Leading zeros are not displayed	
Hold function	Max. hold (maximum value), min. hold (minimum value)	
Hysteresis setting	Programmable with front-panel key inputs (0001 to 9,999)	
Delay in comparative outputs	1 s max.	
Degree of protection	Front-panel: NEMA4X for indoor use (equivalent to IP66) Rear case: IEC standard IP20 Terminals: IEC standard IP00 + finger protection (VDE 0106/100)	
Memory protection	Non-volatile memory (EEPROM) (possible to rewrite 100,000 times)	
Size in mm (H×W×D)	48×96×80	



Process, temperature, weighing and linear sensor indicators

These indicators with analog input feature a clear and easy-to-use color change display. All models are equipped with an IP66 housing. K3HB series is high speed, with a sample rate of 50 Hz, and even 2,000 Hz for K3HB-S

- Position meter indication for easy monitoring
- Optional DeviceNet, RS-232C, RS-485
- Double display, with 5 digits, in two colors
- 1/8 DIN size housing

Ordering information

Type of indicator	Input sensor type and range	Supply voltage	Order code
Process indicator K3HB-X	AC current input, from 0.000 to 10.000 A, 0.0000 to 19.999 mA	100 to 240 VAC	K3HB-XAA 100-240VAC
		24 VAC/VDC	K3HB-XAA 24VAC/VDC
	DC current input, from ± 199.99 mA, to 4.000 to 20.000 mA	100 to 240 VAC	K3HB-XAD 100-240VAC
		24 VAC/VDC	K3HB-XAD 24VAC/VDC
	AC voltage input, from 0.0 to 400.0 V to 0.0000 to 1.999 V	100 to 240 VAC	K3HB-XVA 100-240VAC
24 VAC/VDC		K3HB-XVA 24VAC/VDC	
DC voltage input, from ± 199.99 V to 1.0000 to 5.0000 V	100 to 240 VAC	K3HB-XVD 100-240VAC	
	24 VAC/VDC	K3HB-XVD 24VAC/VDC	
Temperature indicator K3HB-H	Temperature input Pt100, thermocouple K, J, T, E, L, U, N, R, S, B, W	100 to 240 VAC	K3HB-HTA 100-240VAC
		24 VAC/VDC	K3HB-HTA 24VAC/VDC
Weighing indicator K3HB-V	Load cell input (DC low voltage input), 0.00 to 199.99 mV, 0.000 to 19.999 mV, 100.00 mV, 199.999 mV	100 to 240 VAC	K3HB-VLC 100-240 VAC
Linear sensor indicator K3HB-S	DC process input, 0 to 5 V, 1 to 5 V, -5 to 5 V, -10 to 10 V, 0 to 20 mA, 4 to 20 mA	24 VAC/VDC	K3HB-SSD AC/DC24
		100 to 240 VAC	K3HB-SSD AC100-240

Option boards

Sensor power supply/output boards

Slot	Output	Sensor power supply	Communications	Applicable indicator types	Order code		
B	Relay	PASS: SPDT	12 VDC $\pm 10\%$, 80 mA	-	K3HB-X, -H, -S	K33-CPA ^{*1}	
	Linear current	DC0(4) - 20 mA		-	K3HB-X, -H, -S	K33-L1 A ^{*2}	
	Linear voltage	DC0(1) - 5 V, 0 to 10 V		-	K3HB-X, -H, -S	K33-L2A ^{*2}	
	-	-		-	K3HB-X, -H, -S	K33-A ^{*2}	
	-	-		-	RS-232C	K3HB-X, -H, -S	K33-FLK1 A ^{*2}
	-	-		-	RS-485	K3HB-X, -H, -S	K33-FLK3A ^{*2}
	Relay	PASS: SPDT		10 VDC $\pm 5\%$, 100 mA	-	K3HB-V	K33-CPB ^{*1}
	Linear current	DC0(4) - 20 mA			-	K3HB-V	K33-L1B ^{*2}
	Linear voltage	DC0(1) - 5 V, 0 to 10 V			-	K3HB-V	K33-L2B ^{*2}
	-	-			-	K3HB-V	K33-B ^{*2}
-	-	-	RS-232C		K3HB-V	K33-FLK1B ^{*2}	
-	-	-	RS-485		K3HB-V	K33-FLK3B ^{*2}	

Relay/transistor output boards

Slot	Output	Communications	Order code	
C	Relay	H/L: SPDT each	-	K34-C1
		HH/H/LL/L: SPST-NO each	-	K34-C2
	Transistor	NPN open collector: HH/H/PASS/L/LL	-	K34-T1
		PNP open collector: HH/H/PASS/L/LL	-	K34-T2
	-	-	DeviceNet	K34-DRT ^{*2}

Event input boards

Slot	Input type	Number of points	Communications	Order code
D	NPN open collector	5	M3 terminal blocks	K35-1
		8	10-pin MIL connector	K35-2
	PNP open collector	5	M3 terminal blocks	K35-3
		8	10-pin MIL connector	K35-4

^{*1} CPA/CPB can be combined with relay outputs only.

^{*2} Only one of the following can be used by each digital indicator: RS-232C/RS-485 communications, a linear output, or DeviceNet communications.
K3HB has got three slots for option boards: Slot B, slot C and slot D.

Accessories

Type	Order code
Special cable (for event inputs with 8-pin connector)	K32-DICN

Specifications

Power supply voltage		100 to 240 VAC (50/60 Hz), 24 VAC/VDC, DeviceNet power supply: 24 VDC	
Allowable power supply voltage range		85 to 110% of the rated power supply voltage, DeviceNet power supply: 11 to 25 VDC	
Power consumption		100 to 240 V: 18 VA max. (max. load), 24 VAC/DC: 11 VA/7 W max. (max. load)	
Display method		Negative LCD (backlit LED) display 7-segment digital display (character height: PV: 14.2 mm (green/red); SV: 4.9 mm (green))	
Ambient operating temperature		-10 to 55°C (with no icing or condensation)	
Display range		-19,999 to 99,999	
Weight		Approx. 300 g (base unit only)	
Degree of protection		Front-panel	Conforms to NEMA 4X for indoor use (equivalent to IP66)
		Rear case	IP20
		Terminals	IP00 + finger protection (VDE0106/100)
Memory protection		EEPROM (non-volatile memory), number of rewrites: 100,000	
Event input ratings		Contact	ON: 1 k Ω max., OFF: 100 k Ω min.
		No-contact	ON residual voltage: 2 V max., OFF leakage current: 0.1 mA max., load current: 4 mA max. Maximum applied voltage: 30 VDC max.
Output ratings	Transistor output	Maximum load voltage	24 VDC
		Maximum load current	50 mA
		Leakage current	100 μ A max.
	Contact output (resistive load)	Rated load	5 A at 250 VAC, 5 A at 30 VDC
		Rated through current	5 A
		Mechanical life expectancy	5,000,000 operations
		Electrical life expectancy	100,000 operations
	Linear output	Allowable load impedance	500 Ω max. (mA); 5 k Ω min. (V)
		Resolution	Approx. 10,000
Output error		\pm 0.5% FS	
Size in mm (H×W×D)		48×96×100	



Rotary pulse, timer interval and up/down counting pulse indicators

These indicators with analog input feature a clear and easy-to-use color change display. All models are equipped with an IP66 housing. K3HB-R and -C are high-speed, with a sample rate up to 50 kHz.

- Position meter indication for easy monitoring
- Optional DeviceNet, RS-232C, RS-485
- Double display, with 5 digits, in two colors
- 1/8 DIN size housing

Ordering information

Type of indicator	Input ranges	Supply voltage	Input sensor	Order code
Rotary pulse indicator K3HB-R	No voltage contact: 30 Hz max. Voltage pulse: 50 kHz max. Open collector: 50 kHz max.	100 to 240 VAC	NPN input/voltage pulse	K3HB-RNB 100-240VAC
		24 VAC/VDC		K3HB-RNB 24VAC/VDC
		100 to 240 VAC	PNP input	K3HB-RPB 100-240VAC
		24 VAC/VDC		K3HB-RPB 24VAC/VDC
Timer interval indicator K3HB-P		100 to 240 VAC	NPN	K3HB-PNB 100-240VAC
		100 to 240 VAC	PNP	K3HB-PPB 100-240VAC
		24 VAC/VDC	PNP	K3HB-PPB 24VAC/VDC
Up/down counting pulse indicator K3HB-C		100 to 240 VAC	NPN	K3HB-CNB 100-240VAC
		24 VAC/VDC	NPN	K3HB-CNB 24VAC/VDC
		24 VAC/VDC	PNP	K3HB-CPB 24VAC/VDC

Option boards

Sensor power supply/output boards

Slot	Output	Sensor power supply	Communications	Order code	
B	Relay	PASS: SPDT	12 VDC \pm 10%, 80 mA	K33-CPA ^{*1}	
	Linear current	DC0(4) - 20 mA		K33-L1 A ^{*2}	
	Linear voltage	DC0(1) - 5 V, 0 to 10 V		K33-L2A ^{*2}	
	-	-		K33-A ^{*2}	
	-	-		RS-232C	K33-FLK1 A ^{*2}
	-	-		RS-485	K33-FLK3A ^{*2}

Relay/transistor output boards

Slot	Output	Communications	Order code	
C	Relay	H/L: SPDT each	K34-C1	
		HH/H/LL/L: SPST-NO each	K34-C2	
	Transistor	NPN open collector: HH/H/PASS/L/LL	K34-T1	
		PNP open collector: HH/H/PASS/L/LL	K34-T2	
	-	-	DeviceNet	K34-DRT ^{*2}
	BCD + transistor	NPN open collector: HH/H/PASS/L/LL	-	K34-BCD

Event input boards

Slot	Input type	Number of points	Communications	Order code
D	NPN open collector	5	M3 terminal blocks	K35-1
		8	10-pin MIL connector	K35-2
	PNP open collector	5	M3 terminal blocks	K35-3
		8	10-pin MIL connector	K35-4

^{*1} CPA can be combined with relay outputs only.

^{*2} Only one of the following can be used by each digital indicator: RS-232C/RS-485 communications, a linear output, or DeviceNet communications.
K3HB has got three slots for option boards: Slot B, slot C and slot D.

Accessories

Type	Order code
Special cable (for event inputs with 8-pin connector)	K32-DICN
Special BCD output cable	K32-BCD

Specifications

Power supply voltage		100 to 240 VAC (50/60 Hz), 24 VAC/VDC, DeviceNet power supply: 24 VDC	
Allowable power supply voltage range		85 to 110% of the rated power supply voltage, DeviceNet power supply: 11 to 25 VDC	
Power consumption		100 to 240 V: 18 VA max. (max. load), 24 VAC/DC: 11 VA/7 W max. (max. load)	
Display method		Negative LCD (backlit LED) display 7-segment digital display (character height: PV: 14.2 mm (green/red); SV: 4.9 mm (green))	
Ambient operating temperature		-10 to 55°C (with no icing or condensation)	
Display range		-19,999 to 99,999	
Weight		Approx. 300 g (base unit only)	
Degree of protection		Front-panel	Conforms to NEMA 4X for indoor use (equivalent to IP66)
		Rear case	IP20
		Terminals	IP00 + finger protection (VDE0106/100)
Memory protection		EEPROM (non-volatile memory), number of rewrites: 100,000	
Event input ratings		Contact	ON: 1 k Ω max., OFF: 100 k Ω min.
		No-contact	ON residual voltage: 2 V max., OFF leakage current: 0.1 mA max., load current: 4 mA max. Maximum applied voltage: 30 VDC max.
Output ratings	Transistor output	Maximum load voltage	24 VDC
		Maximum load current	50 mA
		Leakage current	100 μ A max.
	Contact output (resistive load)	Rated load	5 A at 250 VAC, 5 A at 30 VDC
		Rated through current	5 A
		Mechanical life expectancy	5,000,000 operations
		Electrical life expectancy	100,000 operations
	Linear output	Allowable load impedance	500 Ω max. (mA); 5 k Ω min. (V)
		Resolution	Approx. 10,000
Output error		\pm 0.5% FS	
Size in mm (H×W×D)		48×96×100	

Switching components

Find information fast!

Quick Links shortens your search. Quick Links are unique codes assigned to Omron products listed in this guide. Enter Quick Link codes in the search box on industrial.omron.eu to access detailed information on products in this guide.

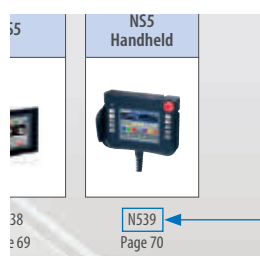

Quick Link

Switching components

Electromechanical relays

Product overview	594
Selection table	596
Industrial plug-in relays	
G2RV	599
G2R-_S	601
MY	603
LY	605
MKS	606
MKS(X)	595
Industrial high power relays	
G7J	607
G7L	595
G7Z	595

Solid state relays

Product overview	608
Selection table	610
Panel mounted	
G3RV	612
G3R-I/O	613
G3NA	614
G3PA	616
G3PE	617
G3PH	608
G3PF	608
G3PW	609
G3ZA	609

Low voltage switchgear

Product overview	618
Selection table	620
Mini contactor relays	
J7KNA-AR	625
Mini motor contactors	
J7KNA	626
Motor contactors	
J7KN	627
Thermal overload relays	
J7TKN	629
Motor protection circuit breakers	
J7MN	631

Monitoring products

Product overview	634
Selection table	638
1-phase control	
K8AK-AS	641
K8AK-AW	642
K8AK-VS	643
K8AK-VW	644
3-phase control	
K8AK-PH	645
K8DS-PH	646
K8AK-PM	647
K8DS-PM	648
K8AK-PA	649
K8DS-PA	650
K8DS-PZ	651
K8DS-PU	652
K8AK-PW	653
Level Control	
61F-GP-N8	654
61F-GPN-BT/-BC	656
K8AK-LS	657
K7L	659
Temperature monitor	
K8AK-TS/-PT	660
K8AK-TH	661
Pushbutton switches	
Product overview	662
Selection table	665
Pushbutton switches	
A16	666
A22	668
Indicators	
M16	670
M22	671

Electromechanical relays

UNIQUE!

G2RV-SL□□ 1-6 mm relay with lockable test switch

At the heart of the industrial G2RV relay is a strong mechanical pin with a large contact surface that ensures reliable connection and high conductivity between the socket and relay. The patented switch design with rotating protection cover is (almost) impossible to achieve in an adapted PCB relay.

Benefits lockable test switch:

- Test panel, machine or system functionality, or simulate an actuator when one or more modules are offline or have been removed
- Rotating protection cover stops accidental operation
- See from distance that the switch is protected – eg, in a hazardous environment

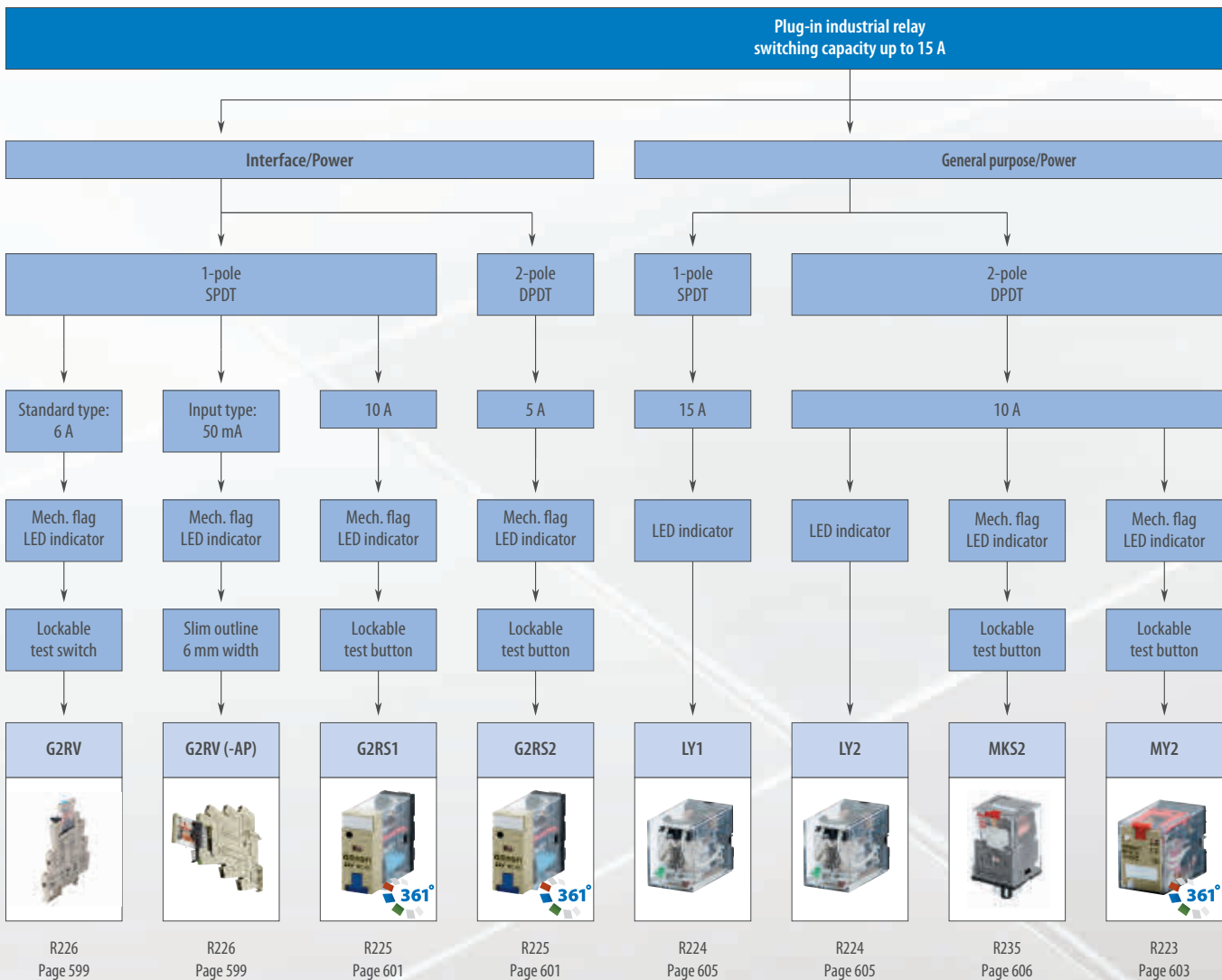

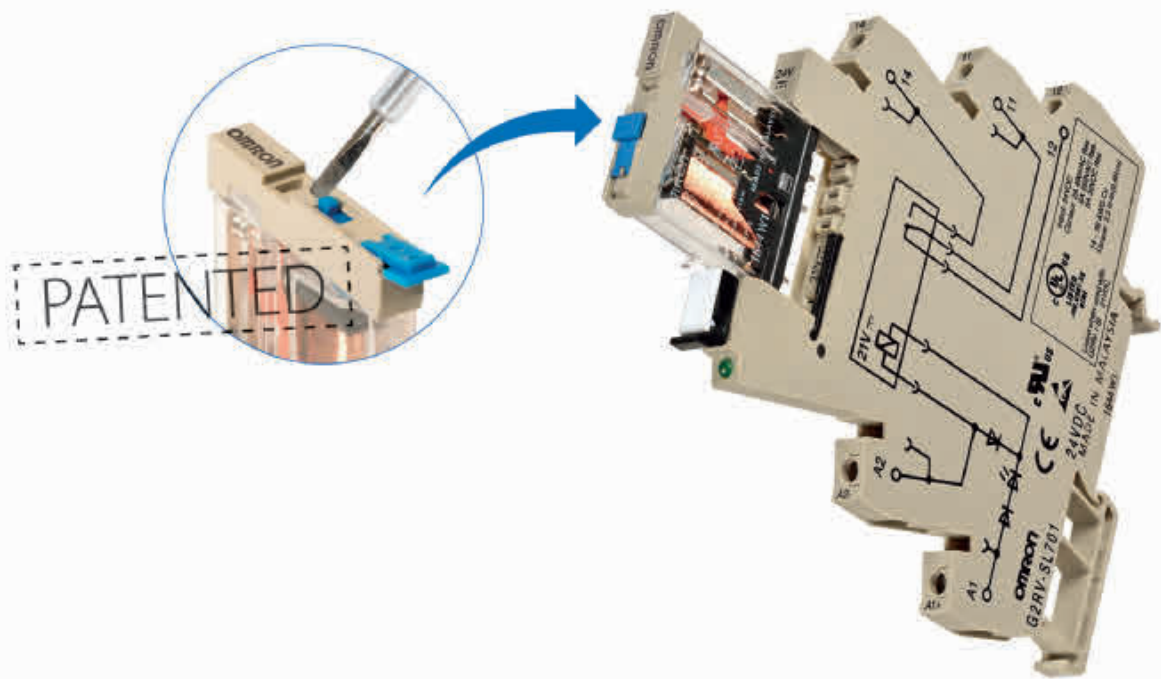



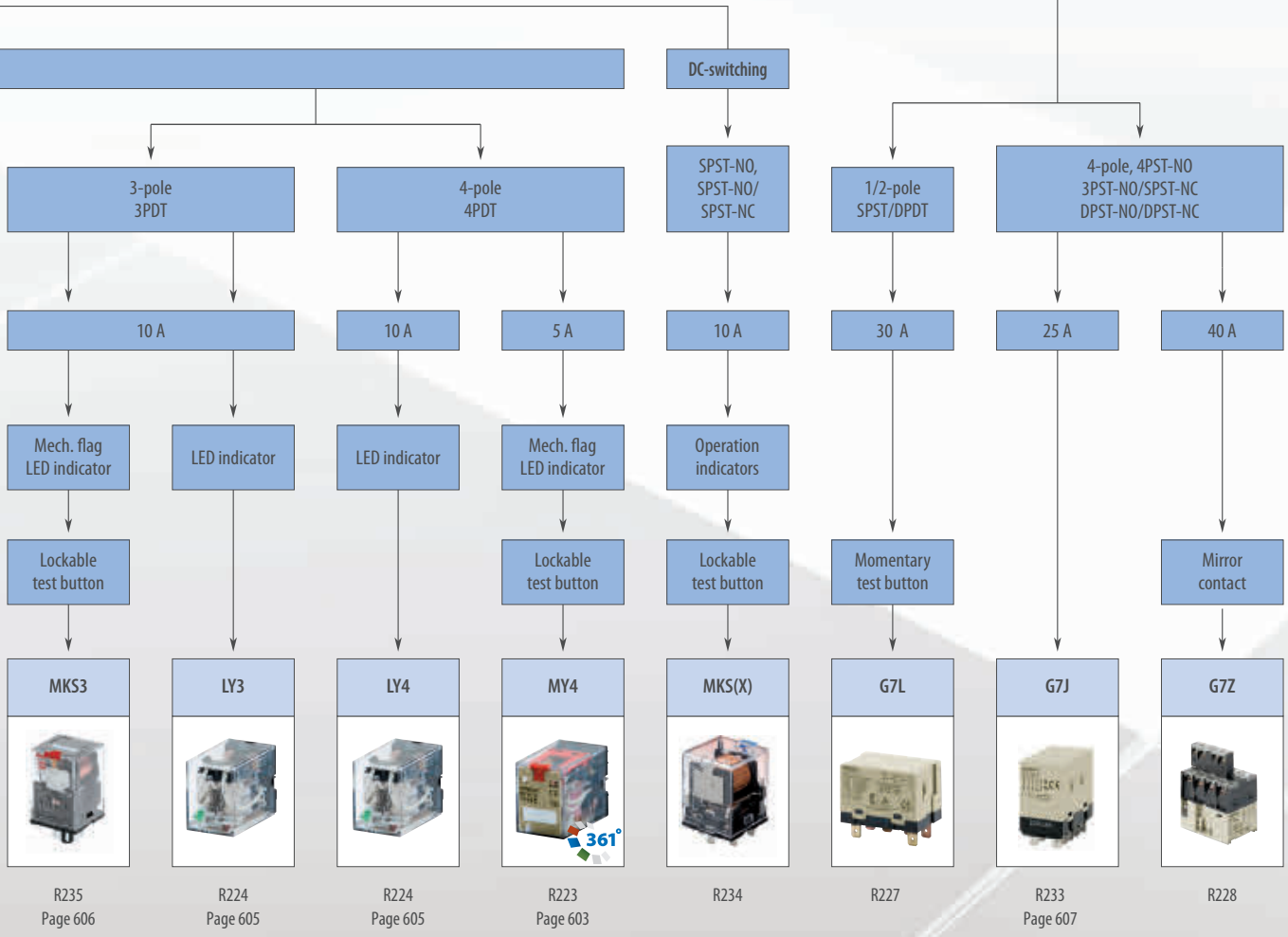



High power relays up to 40 A





Electromechanical relays

Selection table

Category		Interface/Power				General purpose/Power		
								
Family		G2RV		G2R- <u> </u> -S		MY		
Selection criteria	1-pole	■	■	■	–	–	–	–
	2-pole	–	–	–	■	■	–	–
	3-pole	–	–	–	–	–	–	–
	4-pole	–	–	–	–	–	■	■
	Contact configuration	SPDT	SPDT	SPDT	DPDT	DPDT	4PDT	4PDT bifurcated
	Contact material	AgSnIn	AgSnIn + gold plating	AgSnIn	AgSnIn	Ag	AgNi + Au	AgNi + Au
	Max. switching current	6 A	50 mA	10 A	5 A	10 A	5 A	5 A
	Min. switching current	10 mA at 5 VDC	1 mA at 100 mVDC	100 mA at 5 VDC	10 mA at 5 VDC	1 mA at 5 VDC	1 mA at 1 VDC	0.1 mA at 1 VDC
	Gold clad/plate	–	■	□	□	–	■	■
Width max. (Relay only)	5.2 mm	5.2 mm	13.0 mm	13.0 mm	21.5 mm	21.5 mm	21.5 mm	
Features	LED indication	■	■	□	□	□	□	□
	Mechanical flag	■	■	■	■	■	■	■
	Momentary testbutton	–	–	–	–	–	–	–
	Momentary/Lockable testbutton (/switch)	□	–	□	□	□	□	□
	Label	□	□	□	□	□	□	□
	Diode (DC coil)	■	■	□	□	□	□	□
	Varistor (AC coil)	–	–	–	–	–	–	–
CR network (AC coil)	■	■	–	–	□	□	□	
Wiring to socket	Screw (plate clamp)	–	–	□	□	□	□	□
	Screw (box clamp)	□	□	□	□	□	□	□
	Screw-less clamp	□	□	□	□	□	□	□
Page/Quick Link		599		601		603		

Category		High power relays								
										
Family		G7J			G7L			G7Z		
Selection criteria	1-pole	–	–	–	–	■	–	–	–	–
	2-pole	–	–	–	–	–	■	–	–	–
	3-pole	–	–	–	–	–	–	–	–	–
	4-pole	■	■	■	■	–	–	■	■	■
	Contact configuration	4PST-NO	4PST-NO	3PST-NO/SPST-NC	DPST-NO/DPST-NC	SPST-NO	DPST-NO	4PST-NO	3PST-NO/SPST-NC	DPST-NO/DPST-NC
	Max. switching current	25 A	25 A	25 A	25 A	30 A	25 A	40 A	40 A	40 A
	Min. permissible load	100 mA at 24 VDC	100 mA at 24 VDC	100 mA at 24 VDC	100 mA at 24 VDC	100 mA at 5 VDC	100 mA at 5 VDC	2 A at 24 VDC	2 A at 24 VDC	2 A at 24 VDC
Relay terminals	Auxiliary contact block mirror contact	–	–	–	–	–	■	■	■	■
	Momentary testbutton	–	–	–	–	□	□	–	–	–
	Screw	□	□	□	□	□	□	□	□	□
Mounting	Quick-connect	□	□	□	□	□	□	–	–	–
	PCB terminals	□	□	□	□	□	□	–	–	–
	Screw	–	–	–	–	–	–	□	□	□
	DIN rail	–	–	–	–	–	–	□	□	□
	Clip (screw)	□	□	□	□	□	□	–	–	–
Flange (screw)	□	□	□	□	□	□	–	–	–	
DIN rail (adapter)	–	–	–	–	–	–	–	–	–	
Page/Quick Link		607			R227			R228		

Category		General purpose/Power								
										
Family		LY				MKS		MKS(X)		
Selection criteria	1-pole	■	-	-	-	-	-	■	-	-
	2-pole	-	■	■	-	-	■	-	-	■
	3-pole	-	-	-	■	-	-	■	-	-
	4-pole	-	-	-	-	■	-	-	-	-
	Contact configuration	SPDT	DPDT	DPDT bifurcated	3PDT	4PDT	DPDT	3PDT	SPST-NO	SPST-NO/SPST-NC
	Contact material	AgSnIn	AgSnIn	AgSnIn	AgSnIn	AgSnIn	AgSnIn	AgSnIn	AgSnIn	AgSnIn
	Max. switching current	15 A	10 A	7 A	10 A	10 A	10 A	10 A	10 A, 220 VDC; 15 A, 250 VAC	5 A, 220 VDC; 15 A, 250 VAC
	Min. switching current	100 mA at 5 VDC	100 mA at 5 VDC	10 mA at 5 VDC	100 mA at 5 VDC	100 mA at 5 VDC	10 mA at 1 VDC	10 mA at 1 VDC	10 mA at 24 VDC	10 mA at 24 VDC
	Gold clad/plate	-	□	■	-	-	-	-	-	-
	Width max. (Relay only)	21.5 mm	21.5 mm	21.5 mm	31.5 mm	41.5 mm	34.5 mm	34.5 mm	34.5 mm	34.5 mm
Features	LED indication	□	□	□	□	□	□	□	□	□
	Mechanical flag	-	-	-	-	-	■	■	-	-
	Momentary testbutton	-	-	-	-	-	-	-	-	-
	Momentary/Lockable testbutton	-	-	-	-	-	□	□	□	□
	Label	-	-	-	-	-	□	□	-	-
	Diode (DC coil)	□	□	□	□	□	□	□	Optional for socket	Optional for socket
	Varistor (AC coil)	-	-	-	-	-	□	□	-	-
	CR network (AC coil)	-	□	□	-	-	-	-	-	-
Wiring to socket	Screw (plate clamp)	□	□	□	□	□	□	□	□	□
	Screw (box clamp)	-	-	-	-	-	□	□	-	-
	Screw-less clamp	-	-	-	-	-	-	-	-	-
Page/Quick Link	605				606		R234			

■ Standard □ Available - No/not available



The only truly industrial 6 mm relay

Having been designed from first principles, instead of being adapted from a PCB relay, Omron's G2RV series is the only genuine slim industrial relay on the market. As a result, the G2RV offers a wide array of benefits to machine manufacturers and panel builders. Just 6mm wide, the relay is ideal for compact panels and equipment, yet it offers all of the durability and reliability required for industrial applications.

- Lockable test switch models available
- Large plug-in pins – excellent connection
- LED/mechanical flag – check operation
- Transparent housing – check condition
- Slim outline – space saving
- Push-in/accessories – simple wiring
- Special input type with gold plated contacts
- G3RV compatible

Ordering information

Relay	Input voltage	Order code	
		Screw terminals	Push-in terminals
Standard type without lockable test switch	12 VDC	G2RV-SL700 DC12	G2RV-SL500 DC12
	24 VDC	G2RV-SL700 DC24	G2RV-SL500 DC24
	24 VAC/VDC	G2RV-SL700 AC/DC24	G2RV-SL500 AC/DC24
	48 VAC/VDC	G2RV-SL700 AC/DC48	G2RV-SL500 AC/DC48
	110 VAC	G2RV-SL700 AC110	G2RV-SL500 AC110
Standard type with lockable test switch	230 VAC	G2RV-SL700 AC230	G2RV-SL500 AC230
	24 VDC	G2RV-SL701 DC24	G2RV-SL501 DC24
Input type	24 VAC/VDC	G2RV-SL701 AC/DC24	G2RV-SL501 AC/DC24
	12 VDC	G2RV-SL700-AP DC12	G2RV-SL500-AP DC12
Input type	24 VDC	G2RV-SL700-AP DC24	G2RV-SL500-AP DC24
	24 VAC/VDC	G2RV-SL700-AP AC/DC24	G2RV-SL500-AP AC/DC24
	48 VAC/VDC	G2RV-SL700-AP AC/DC48	G2RV-SL500-AP AC/DC48
	110 VAC	G2RV-SL700-AP AC110	G2RV-SL500-AP AC110
	230 VAC	G2RV-SL700-AP AC230	G2RV-SL500-AP AC230

Accessories

Type	Description	Order code
Cross bar	2-pole	P2RVM-020_
Cross bar	3-pole	P2RVM-030_
Cross bar	4-pole	P2RVM-040_
Cross bar	10-pole	P2RVM-100_
Cross bar	20-pole	P2RVM-200_
PLC interface	Connect 8 relays and PLC output	P2RVC-8-O-F
PLC interface	Connect 8 relays and PLC input	P2RVC-8-I-F
Label	Plastic, for mounting on socket	R99-15 for G2RV
Label (Sticker)	Paper for mounting on socket or relay	R99-16 for G2RV
Separating plate	Provides isolation between adjacent relays to achieve 400 V isolation	P2RV-S
Relay only	Maintenance part for G2RV-SL_00-series 12 VDC	G2RV-1-S DC11
Relay only	Maintenance part for G2RV-SL_00-series 24 VDC and 24 VAC/VDC	G2RV-1-S DC21
Relay only	Maintenance part for G2RV-SL_00-series 48 VAC/VDC and 110, 230 VAC	G2RV-1-S DC48
Relay only	Maintenance part for G2RV-SL_01-series 24 VDC and 24 VAC/VDC	G2RV-1-SI SC21
Relay only	Maintenance part for G2RV-SL-AP series 12 VDC	G2RV-1-S-AP DC11
Relay only	Maintenance part for G2RV-SL-AP series 24 VDC and 24 VAC/VDC	G2RV-1-S-AP DC21
Relay only	Maintenance part for G2RV-SL-AP series 48 VAC/VDC and 110, 230 VAC	G2RV-1-S-AP DC48

Note: _ Select color: R=Red, S=Blue, B=Black

Interface cables

PLC brand	PLC type	Number of I/O	I/O type	Cable length	Order code
Omron	CJ1	32	Digital Output (MIL)	1.0 m	P2RV-4-100C
				2.0 m	P2RV-4-200C
				3.0 m	P2RV-4-300C
				5.0 m	P2RV-4-500C
			Digital Input (Fujitsu)	1.0 m	P2RV-4-100IFC
				2.0 m	P2RV-4-200IFC
				3.0 m	P2RV-4-300IFC
				5.0 m	P2RV-4-500IFC
			Digital Input (MIL)	1.0 m	P2RV-4-100IMC
				2.0 m	P2RV-4-200IMC
				3.0 m	P2RV-4-300IMC
				5.0 m	P2RV-4-500IMC
	GRT1 SmartSlice	8	Digital Output	0.5 m	P2RV-A050C-OMR GRT1
				1.0 m	P2RV-A100C-OMR GRT1
		8	Digital Input	0.5 m	P2RV-A050IC-OMR GRT1
				1.0 m	P2RV-A100IC-OMR GRT1
NX	8	Digital Output	0.5 m	P2RV-A050C-OMR NX	
			1.0 m	P2RV-A100C-OMR NX	
	8	Digital Input	0.5 m	P2RV-A050IC-OMR NX	
			1.0 m	P2RV-A100IC-OMR NX	
Siemens	S7/300	32	Digital Input and Digital Output	2.0 m	P2RV-200C-SIM S7/300
				2.5 m	P2RV-250C-SIM S7/300
				3.0 m	P2RV-300C-SIM S7/300
				5.0 m	P2RV-500C-SIM S7/300
	S7/400	32	Digital Input and Digital Output	2.0 m	P2RV-200C-SIM S7/400
				2.5 m	P2RV-250C-SIM S7/400
				3.0 m	P2RV-300C-SIM S7/400
				5.0 m	P2RV-500C-SIM S7/400
Multi purpose (flying leads)	All	8	Digital Input and Digital Output	1.0 m	P2RV-A100C
				2.0 m	P2RV-A200C
				3.0 m	P2RV-A300C
				5.0 m	P2RV-A500C

Specifications

Coil ratings

Item	Standard type	Input type*1
Contact form	SPDT	
Input voltage	12, 24 VDC, 24, 48 VAC/VDC, 110, 230 VAC	
Rated load	6 A at 250 VAC 6 A at 30 VDC	50 mA at 30 VAC 50 mA at 36 VDC
Max. switching voltage	400 VAC, 125 VDC	30 VAC, 36 VDC
Max. switching current	6 A	50 mA
Max. switching power	1,500 VA/180 W (resistive load)	
Min. permissible load	10 mA at 5 VDC	1 mA at 100 mVDC
Mechanical durability	5 Million operations min.	
Electrical durability (rated load)	100 K operations (typical)	5 Million operations min.
Dielectric strength	4,000 VAC, 50/60 Hz for 1 min between coil and contacts; 1,000 VAC, 50/60 Hz for 1 min between contacts of same polarity	
Ambient temperature	-40 to 55°C	
Approved standards	UL, IEC/VDE, Lloyd's, and CE marking	
Size in mm (H×W×D)	92.7×106.3×6.2 (push-in type) 97.4×106.3×6.2 (screw type)	

*1 If a gold layer is destroyed, contact ratings of standard type are applicable



Plug-in relay with enhanced features covers a wide range of applications

G2RS series, which comes as standard with a mechanical indicator and nameplate covering a wide range of interface applications.

Optionally available with gold clad contacts and diode, whilst the socket and crossbar range are offering a maximum of flexibility during installation.

- SPDT type 10A / DPDT type 5 A
- Mechanical Flag, LED indicator and momentary / lockable testbutton optional
- Transparent housing
- Screwless clamp terminal sockets available
- Space saving – 16 mm width (including sockets)

Ordering information

Contact form	Diode	LED indicator	Test button	Gold clad 3 µm	Order code		
					(___ = coil voltage + AC/DC)	Common coil voltages ^{*1}	
						DC	AC
SPDT (1-pole)	no	no	no	no	G2R-1-S___(S)	24	230
					G2R-1-SN___(S)	12, 24	24, 110, 230
					G2R-1-SNI___(S)	12, 24	12, 24, 110, 230
	yes	yes	no	no	G2R-1-SNI-AP3___(S)	–	230
					G2R-1-SND___(S)	12, 24	–
					G2R-1-SNDI___(S)	24	–
DPDT (2-pole)	no	no	no	no	G2R-2-S___(S)	24	24, 110, 240
					G2R-2-SN___(S)	12, 24, 48	24, 110, 230
					G2R-2-SN-AP3___(S)	24	–
	yes	yes	no	no	G2R-2-SNI___(S)	12, 24	12, 24, 110, 230
					G2R-2-SNI-AP3___(S)	–	230
					G2R-2-SD___(S)	–	–
yes	yes	yes	no	G2R-2-SND___(S)	12, 24	–	
				G2R-2-SND-AP3___(S)	24	–	
				G2R-2-SNDI___(S)	12, 24	–	
			yes	yes	G2R-2-SNDI-AP3___(S)	24	–

*1 Other coil voltages available. Please see specifications.

Sockets & accessories

For type	Order code										
	DIN rail						PCB				
	Screwless clamp						Screw (plate clamp)		Screw (box clamp)		Soldering
	Socket	Clip	Cross bar AC type	Cross bar DC type	Name plate	Socket	Socket	Clip	Name plate	Socket	
G2R-1-S	P2RF-05-S	P2CM-S	P2RM-SR	P2RM-SB	R99-11	P2RF-05-E	P2RF-05-ESS	P2CM-ESS	PYC-TR	P2R-05P	
G2R-2-S	P2RF-08-S	P2CM-S	P2RM-SR	P2RM-SB	R99-11	P2RF-08-E	P2RF-08-ESS	P2CM-ESS	PYC-TR	P2R-08P	

Specifications

Coil ratings

	Rated voltage	Must operate voltage	Must release voltage	Max. voltage	Power consumption (approx.)
		% of rated voltage			
AC	24 V, 110 V, 120 V, 230 V, 240 V	80% max.	30% max.	110%	0.9 VA (60 Hz)
DC	6 V, 12 V, 24 V, 48 V	70% max.	15% max.	110%	0.53 W

Contact ratings

Number of poles	1-pole		2-pole	
	Resistive load (cosφ = 1)	Inductive load (cosφ = 0.4; L/R = 7)	Resistive load (cosφ = 1)	Inductive load (cosφ = 0.4; L/R = 7)
Rated load	10 A at 250 VAC 10 A at 30 VDC	7.5 A at 250 VAC 5 A at 30 VDC	5 A at 250 VAC 5 A at 30 VDC	2 A at 250 VAC 3 A at 30 VDC
Rated carry current	10 A		5 A	
Max. switching voltage	440 VAC, 125 VDC		380 VAC, 125 VDC	
Max. switching current	10 A		5 A	
Max. switching power	2,500 VA, 300 W		1,250 VA, 150 W	
Failure rate (reference value)	100 mA at 5 VDC		10 mA at 5 VDC	
Mechanical life	AC: 10,000,000 operations min., DC: 20,000,000 operations min.			
Electrical life	100,000 operations min.			

Technical data

Item	1-pole	2-pole
Contact material	AgSnIn	
Operating time	15 ms max.	15 ms max.
Release time	AC: 10 ms max., DC: 5 ms max.	AC: 15 ms max., DC: 10 ms max.
Dielectric strength	5,000 VAC (coil-contact)	5,000 VAC (coil-contact)
Ambient temperature	Operating: -40 to 70°C (no icing or condensation)	
Size in mm (H×W×D)	35.5×13×29	



Versatile plug-in relay that sets the standard

Over 1 billion pieces of this mini power relay have been manufactured since its introduction and have successfully been used in many different applications. Bifurcated contacts optionally are available to achieve reliable low current switching during the entire electrical life. Full range of sockets covering mounting by screw, box clamp and screw-less clamp method.

- DPDT type 10 A / 4PDT type 5 A
- Mechanical flag, LED indicator and momentary / lockable testbutton optional
- Transparent housing
- Low power switching (1 mA at 5 VDC) / Bifurcated 4PDT (0.1 mA at 1 VDC)
- Screw-less clamp terminal sockets available

Ordering information

Contact form	Diode	LED indicator	Lockable test button	Order code (___ = coil voltage + AC/DC)					
								Common coil voltages*1	
				DC	AC	DC	AC		
DPDT	no	no	no	MY2___(S)	–	12, 24	12, 24, 48/50, 110/120, 220/240		
DPDT		yes		MY2N___(S)	–	12, 24	24, 110/120, 220/240		
DPDT	yes			MY2N-D2___(S)	–	24	–		
DPDT	no		yes	MY2IN___(S)	–	12, 24, 48	12, 24, 110/120, 220/240		
DPDT				–	MY2IN1___(S)	12, 24	–		
DPDT	yes			MY2IN-D2___(S)	–	24	–		
DPDT				–	MY2IN1-D2___(S)	24	–		
4PDT	no	no	no	MY4___(S)	–	12, 24, 48, 100/110, 125	12, 24, 48/50, 110/120, 220/240		
4PDT		yes		MY4N___(S)	–	12, 24, 48, 100/110	24, 110/120, 220/240		
4PDT	yes			MY4N-D2___(S)	–	12, 24	–		
4PDT	no		yes	MY4IN___(S)	–	12, 24, 48	12, 24, 48/50, 110/120, 220/240		
4PDT				–	MY4IN1___(S)	12, 24, 48	–		
4PDT	yes			MY4IN-D2___(S)	–	24	–		
4PDT				–	MY4IN1-D2___(S)	24, 48	–		

*1 Other coil voltages available. Please see specifications.

- Note
- MY4 also available with bifurcated contacts => example MY4Z
 - MY2 and MY4 AC 110/120, 220/240 types also available with suppression => example MY4N-CR

Sockets & accessories

Input terminals separated from output terminals

For type	Order code					Box clamp			
	Screw-less clamp					Socket	Metal spring clip	Plastic holding clip	Label
	Socket	Clip	Cross bar AC type	Cross bar DC type	Name plate				
MY2	PYF08S	PYCM-08S	PYDM-08SR	PYDM-08SB	R99-11	PYF14-ESS	PYC-0	PYC-35	PYCTR1
MY4	PYF14S	PYCM-14S	PYDM-14SR	PYDM-14SB	R99-11	PYF14-ESS	PYC-0	PYC-35	PYCTR1

Combined input/output terminals

Order code	Order code			Box clamp			
	Screw terminal			Socket	Metal spring clip	Plastic holding clip	Label
	Socket	Clip (set = 2 pcs)	Clip for MY2IN (set = 2 pcs)				
MY2	PYF08A-N	PYC-A1	PYC-E1	PYF14-ESN	PYC-0	PYC-35	PYCTR1
MY4	PYF14A-N	PYC-A1		PYF14-ESN	PYC-0	PYC-35	PYCTR1

Specifications

Coil ratings

Rated voltage	Must operate voltage	Must release voltage	Max. voltage	Power consumption (approx.)
	% of rated voltage			
AC 6 V, 12 V, 24 V, 48/50 V 110/120 V, 220/240 V	80% max	30% min.	110%	1.0 to 1.2 VA (60 Hz)
				0.9 to 1.1 VA (60 Hz)
DC 6 V, 12 V, 24 V, 48 V, 100/110 V		10% min.		0.9 W

Contact ratings

Item	2-pole		4-pole		4-pole (bifurcated)	
	Resistive load ($\cos\phi = 1$)	Inductive load ($\cos\phi = 0.4$; L/R = 7)	Resistive load ($\cos\phi = 1$)	Inductive load ($\cos\phi = 0.4$; L/R = 7)	Resistive load ($\cos\phi = 1$)	Inductive load ($\cos\phi = 0.4$; L/R = 7)
Rated load	5 A at 250 VAC 5 A at 30 VDC	2 A at 250 VAC 2 A at 30 VDC	3 A at 250 VAC 3 A at 30 VDC	0.8 A at 250 VAC 1.5 A at 30 VDC	3 A at 250 VAC 3 A at 30 VDC	0.8 A at 250 VAC 1.5 A at 30 VDC
Rated carry current	10 A		5 A			
Max. switching voltage	250 VAC, 125 VDC		250 VAC, 125 VDC			
Max. switching current	10 A		5 A			
Max. switching power	2,500 VA, 300 W	1,250 VA, 300 W	1,250 VA, 150 W	500 VA, 150 W	1,250 VA, 150 W	500 VA, 150 W
Failure rate (reference value)	5 VDC at 1 mA		1 VDC at 1 mA		1 VDC at 100 μ A	
Mechanical life	AC: 50,000,000 operations min., DC: 100,000,000 operations min.				20,000,000 operations min.	
Electrical life	500,000 operations min.		200,000 operations min.		100,000 operations min.	

Technical data

Item	2-pole	4-pole
Contact Material:	Ag	AgNi + Au
Operating time	20 ms max.	
Release time	20 ms max.	
Dielectric strength	2,000 VAC	
Ambient temperature	Operating: -55 to 70°C (no icing)	
Size in mm (H×W×D)	28×21.5×36	

Dimension relay + socket

Type	Size in mm (H×W×D)
PYF08S + MYS	90×23.2×38.2
PYF08A-E + MYS	76×23×31
PYF08A-N + MYS	73×22×30
PYF14S + MYS	89.2×31×36.5
PYF14A-E + MYS	76×29.5×31
PYF14A-N + MYS	73×29.5×30
PYF14-ESN + MYS	82×27×80 (incl. plastic holding clip PYC-35)
PYF14-ESS + MYS	83×27×82 (inc. plastic holding clip PYC-35)



Miniature 15 A power relay

LY-series comes in SPDT, DPDT, 3PDT and 4PDT types covering depending on the number of poles 10 or even 15A rated load. Bifurcated contacts available for DPDT configuration only, whilst the optional Diodes for DC and CR circuit for AC coils are available for all plug-in types.

- SPDT type 15 A / DPDT, 3PDT and 4PDT type 10 A
- Led indicator optional
- Transparent housing
- Suppression by optional Built-in Diodes (DC only) or CR network (AC-types)
- DIN rail mounting by socket. PCB and Flange mounting available

Ordering information

Contact form	LED indicator	Diode	Terminals			Order code *1 (___ = coil voltage + AC/DC)	Common coil voltages *2	
			Plug-in/solder	PCB	Upper-mounting plug-in/solder		DC	AC
SPDT (1 pole)	no	no	yes	no	no	LY1 ___	24	–
SPDT (1 pole)	yes	yes				LY1N-D2 ___	24	–
DPDT (2 pole)	no	no				LY2 ___	12, 24, 100/110	24, 100/110, 110/120, 220/240
DPDT (2 pole)			no		yes	LY2F ___	–	220/240
DPDT (2 pole)	yes	yes	yes		no	LY2N-D2 ___	24	–
3PDT (3 pole)	no	no				LY3 ___	24	–
4PDT (4 pole)						LY4 ___	12, 24, 100/110, 125	24, 100/110, 230
4PDT (4 pole)	yes	yes				LY4N-D2 ___	24	–

*1 For other options like CR suppression, please see specifications.
 *2 Other coil voltages available. Please see specifications.

Sockets & accessories

For type	Order code			
	DIN rail		PCB	
	Socket	Clip (set = 2 pcs)	Socket	Clip (set = 2 pcs.)
LY1/LY2	PTF08A-E	PYC-A1	PT08-0	PYC-P
LY2 CR-type	PTF08A-E	Y92H-3	PT08-0	PYC-1
LY3	PTF11A-E	PYC-A1	PT11-0	PYC-P
LY4	PTF14A-E	PYC-A1	PT14-0	PYC-P

Dimension relay & socket

Type	Size in mm (H×W×D)
PTF08A-E + LY	78.5×28.5×71
PTF11A-E + LY	78.5×37×71
PTF14A-E + LY	78.5×45.5×71

Specifications

Coil ratings

Poles	Rated voltage	Must operate voltage	Must release voltage	Max. voltage	Power consumption (approx.)
1 or 2	AC 6 V, 12 V, 24 V, 50 V	80% max.	30% min.	110%	1.0 to 1.2 VA (60 Hz)
	100/110 V, 110/120 V, 200/220 V, 220/240 V				0.9 to 1 VA (60 Hz)
	DC 6 V, 12 V, 24 V, 48 V, 100/110 V		10% min.		0.9 W
3	AC 6 V, 12 V, 24 V, 50 V, 100/110 V, 200/220 V	80% max.	30% min.	110%	1.6 to 2.0 VA (60 Hz)
	DC 6 V, 12 V, 24 V, 48 V, 100/110 V				1.4 W
4	AC 6 V, 12 V, 24 V, 50 V, 100/110 V, 200/220 V	80% max.	30% min.	110%	1.95 to 2.5 VA (60 Hz)
	DC 6 V, 12 V, 24 V, 48 V, 100/110 V				1.5 W

Technical data

Contact material	AgSnIn
Operating time	25 ms max.
Release time	25 ms max.
Dielectric strength	1,000 VAC
Ambient temperature *1	–25 to 70°C

*1 See datasheet for more details.

Contact ratings

Relay	Single contact 1-pole		Single contact 2-, 3- or 4-pole		Bifurcated contacts 2-pole	
	Resistive load (cosφ = 1)	Inductive load (cosφ = 0.4; L/R = 7)	Resistive load (cosφ = 1)	Inductive load (cosφ = 0.4; L/R = 7)	Resistive load (cosφ = 1)	Inductive load (cosφ = 0.4; L/R = 7)
Rated load	110 VAC at 15 A 24 VDC at 15 A	110 VAC at 10 A 24 VDC at 7 A	110 VAC at 10 A 24 VDC at 10 A	110 VAC at 7.5 A 24 VDC at 5 A	110 VAC at 5 A 24 VDC at 5 A	110 VAC at 4 A 24 VDC at 4 A
Rated carry current	15 A		10 A		7 A	
Max. switching voltage	250 VAC, 125 VDC		250 VAC, 125 VDC		250 VAC, 125 VDC	
Max. switching current	15 A		10 A		7 A	
Max. switching power	1,700 VA	1,100 VA	1,100 VA	825 VA	550 VA	440 VA
	360 W	170 W	240 W	120 W	120 W	100 W
Failure rate (reference value)	100 mA at 5 VDC		100 mA at 5 VDC		10 mA at 5 VDC	
Mechanical life	AC: 50,000,000 operations min., DC: 100,000,000 operations min.					
Electrical life	1-, 3-, 4-pole: 200,000 operations min., 2-pole: 500,000 operations min.					



Exceptionally reliable general purpose relay with 8 or 11 plug-in pins for round sockets

MK relay breaks compared to its size relatively large currents. The AgSnIn contacts ensure long electrical lifetime (min. 100,000 operations). Wide switching range from 10 mA at 1 VDC upto 10 A at 250 VAC.

- 8-pin DPDT and 11-pin 3PDT contact types
- Switching current up to 10 A
- Lockable test button for easy testing
- Temperature rating from -40°C up to 60°C

Ordering information

Contact form	Mechanical indicator & lockable test button	LED indicator	Diode	Order code ^{*1} (___ = coil voltage + AC/DC)	Common coil voltages ^{*2}	
					DC	AC
DPDT (2-pole)	yes	no	no	MKS2PI	12, 24, 110	24, 110, 230
		yes		MKS2PIN	24	24, 230
3PDT (3-pole)		no		MKS3PI-5	12, 24, 48, 110	12, 24, 110, 230
		yes	yes	MKS3PI-D-5	24	N/A
		yes	no	MKS3PIN-5	12, 24	24, 110, 230
			yes	MKS3PIN-D-5	24	N/A

*1 Many various terminal arrangements possible, please see specifications.

*2 Other coil voltages available. Please see specifications.

Sockets & accessories

For type	Order code			
	DIN rail			
	Screw		Box clamp	
	Socket	Clip (set= 2 pcs.)	Socket	
MKS2	PF083A-E	PFC-A1	–	PF083A-D
MKS3	PF113A-E	PFC-A1	PF113A-N	PF113A-D

Specifications

Coil ratings

Rated voltage	Must operate voltage % of rated voltage	Must release voltage	Max. voltage	Power consumption (approx.)
AC	6 V, 12 V, 24 V, 100 V, 110 V, 120 V, 200 V, 220 V, 230 V, 240 V	80% max.	30% min.	2.3 VA (60 Hz) 2.7 VA (50 Hz)
DC	6 V, 12 V, 24 V, 48 V, 100 V, 110 V		15% min.	1.4 W

Contact ratings

Load	2- or 3-pole	
	Resistive load ($\cos\phi = 1$)	Inductive load ($\cos\phi = 0.4$; L/R = 7)
Contact material	AgSnIn	
Rated load	NO: 10 A at 250 VAC NC: 5 A at 30 VDC	7 A at 250 VAC
Rated carry current	10 A	
Max. switching voltage	250 VAC, 250 VDC	–
Max. switching current	10 A	
Max. switching power	2,500 VA/ 300 W	1,250 VA/150 W
Mechanical life	5,000,000 operations min.	
Electrical life	100,000 operations min.	

Technical data

Operating time	AC: 20 ms max., DC: 30 ms max.
Release time	20 ms max. (40 ms max. for built-in Diode relays)
Dielectric strength	2,500 VAC (coil-contact)
Ambient temperature	Operating: -40 to 60°C (with no icing or condensation)
Size in mm (H×W×D)	34.5×34.5×53.3

Dimension relay & socket

Type	Size in mm (H×W×D)
PF083A-E + MKS	56×41×77.8 (incl. clip)
PF113A-E + MKS	56×42.8×87.8 (incl. clip)
PF___A-D + MKS	65×38×80.3



High capacity, high dielectric strength 4 pole power relay

G7J series developed for switching resistive, inductive as well as motor loads. No contact chattering for momentary voltage drops up to 50% of rated voltage. High dielectric strength (4KV) between coil and contacts as well as between different polarity contacts.

- 25 A Rated current
- 4PST-NO, 3PST-NO / SPST-NC or DPST-NO / DPST-NC
- Bifurcated contacts optional
- Terminals: Screw, Quick-connect or PCB pins
- Mounting by insertion into a clip or just by screws (flange type)

Ordering information

Contact form	Mounting		Terminal			Order code ^{*1} (___ = coil voltage + AC/DC)	Common coil voltages ^{*2}	
	PCB	W-bracket mounting	PCB	Quick-connect	Screw		DC	AC
4PST-NO	yes	no	yes	no	no	G7J-4A-P___	12, 24	200/240
	no	yes	no	yes	yes	G7J-4A-B___	24	–
3PST-NO/SPST-NC	yes	no	yes	no	no	G7J-4A-T___	12, 24	200/240
	no	yes	no	yes	yes	G7J-3A1B-P___	24	–
DPST-NO/SPST-NC				yes	no	G7J-3A1B-B___	24	–
DPST-NO/DPST-NC	yes	no	yes	no	no	G7J-3A1B-T___	24	200/240
						G7J-2A2B-P___	24	–

^{*1} For other options like bifurcated contacts, please see specifications.

^{*2} Other coil voltages available. Please see specifications.

Accessories

For type	Order code
	W-bracket
G7J Screw terminal type	R99-04 for GSF
G7J Quick Connect type	

Specifications

Coil ratings

Rated voltage	Must operate voltage % of rated voltage	Must release voltage % of rated voltage	Max. voltage	Power consumption (approx.)		
					AC	24, 50, 100 to 120, 200 to 240
DC	6, 12, 24, 48, 100				10% min.	2.0 W

Contact ratings

Item	4-pole		
	Resistive load cosφ = 1	Inductive load cosφ = 0.4	Resistive load
Rated load	NO: 25 A at 220 VAC (24 A at 230 VAC) NC: 8 A at 220 VAC (7.5 A at 230 VAC)		NO: 25 A at 30 VDC NC: 8 A at 30 VDC
Rated carry current	NO: 25 A (1 A), NC: 8 A (1 A)		
Max. switching voltage	250 VAC		125 VDC
Max. switching current	NO: 25 A (1 A), NC: 8 A (1 A)		
Mechanical life	1,000,000 operations min.		
Electrical life	100,000 operations min.		

Note: Values between () indicate bifurcated contact specification.

Technical data

Contact material	Ag alloy
Operating time	50 ms max.
Release time	50 ms max.
Dielectric strength	4,000 VAC
Ambient temperature	Operating: -25 to 60°C (no icing)

Solid state relays

COMPACT SOLID STATE RELAYS

G3_ series – Reliable interfacing and power switching

With a wide variety of output currents and voltages, our control-panel mounted types of power switching SSRs are available with (G3PE & G3PH) and without (G3NA) built-in heat-sink. The compact SSRs for I/O Interfacing G3RV & G3R offer high-speed models (G3R).

- Industrial 6 mm 'slim' SSR which is G2RV compatible (G3RV)
- G2RS compatible high-speed interface solutions (G3R-I/O)
- G3NA with 5-90 A output current, G3PB up to 45 A
- Output voltages up to 480 VAC / 200 VDC available on G3NA
- Effectively absorbing of external surge thanks to the built-in varistor

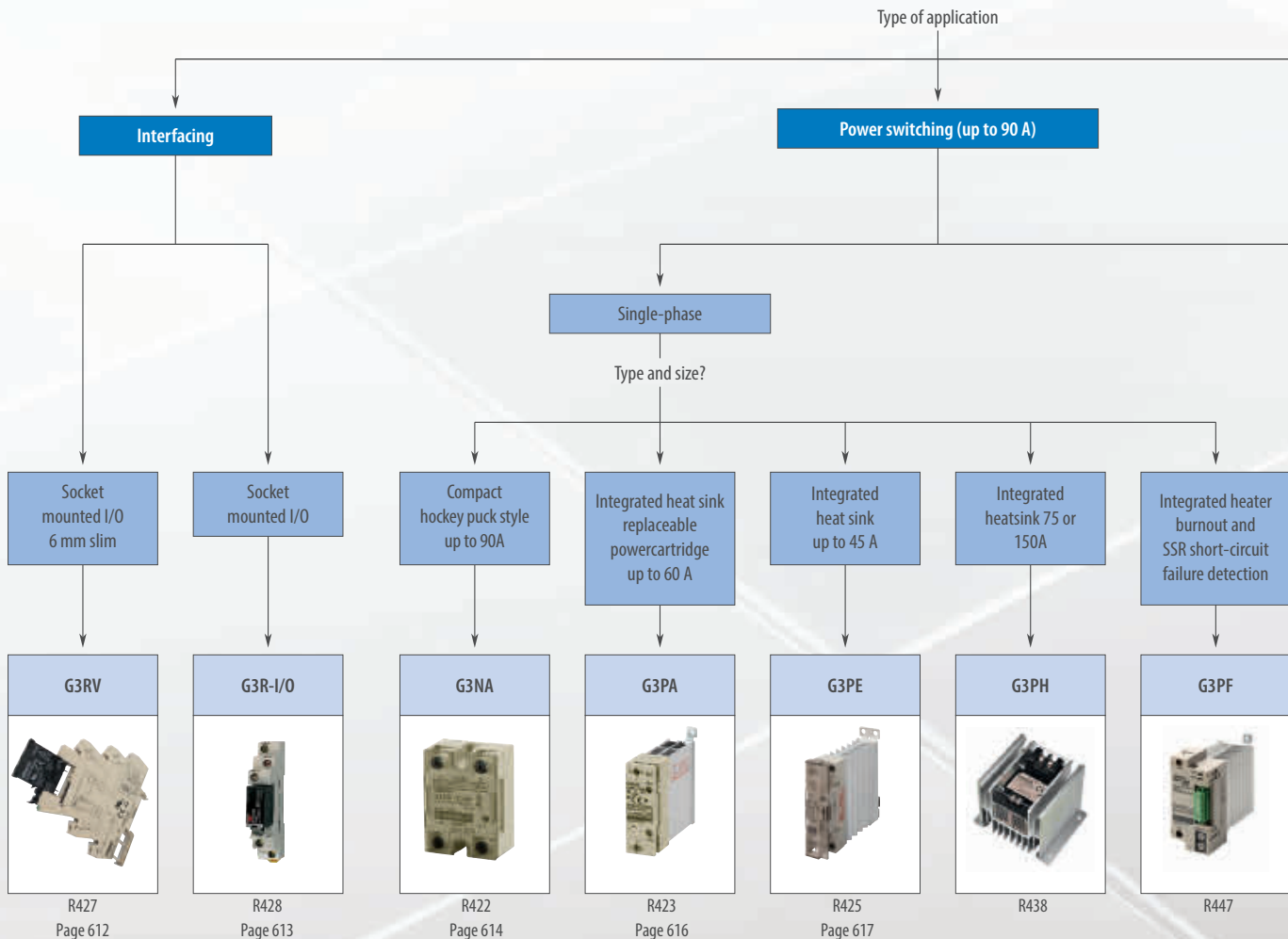

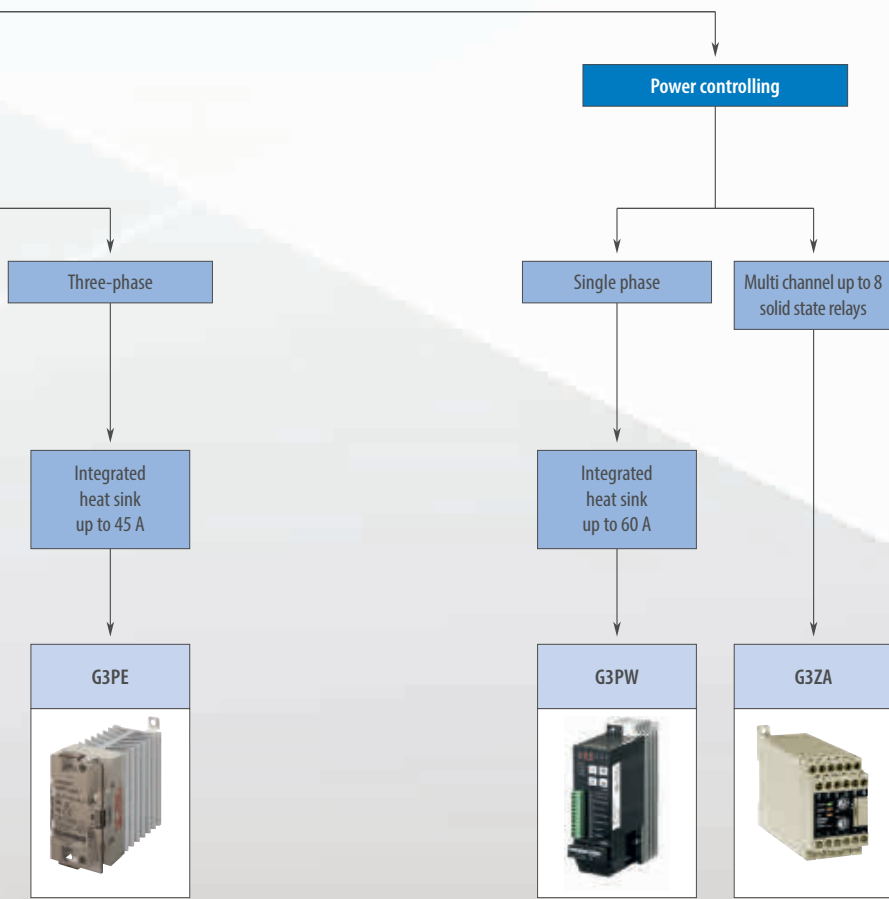
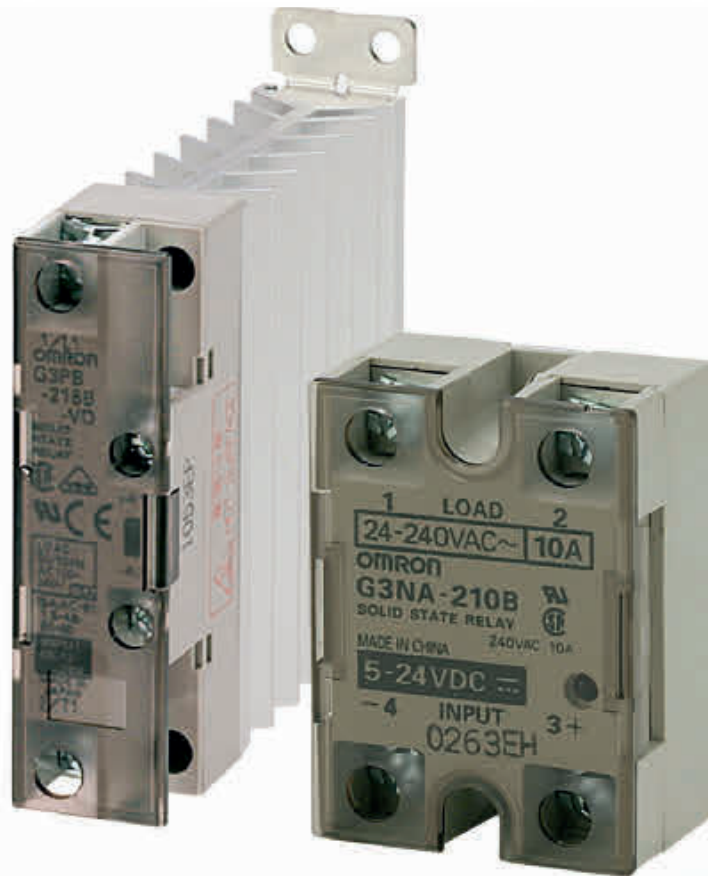







R425
Page 617

R442

R426

Selection table

Category		Control panel mounting type				
						
Model		G3RV	G3R-I/O	G3NA	G3PA	
Selection criteria	Type of load	Output module (interface)	Input Module (interface)	Output Module (interface)	Normal resistive heaters Motor control	Normal resistive heaters
	1-phase control	–	–	–	■	■
	2-phase control	–	–	–	–	–
	3-phase control	–	–	–	–	–
	Function	Signal switching	Signal switching	Signal switching	Heater control, motor control	Heater control
	Max. current rating	2 A (AC); 3 A (DC)	100 mA	2 A	90 A	60 A
Load voltage/ current [VAC]	24 to 240	–	–	–	■	■
	100 to 240	■	–	■	–	–
	200 to 480	–	–	–	■	■
Load voltage/ current [VDC]	5 to 200	3 to 26.4	4 to 32	■	■	–
	5 to 24 VDC	–	■	■	■	■
Input voltages [VDC or VAC]	12 to 24 VDC	12 VDC ±10%; 24 VDC ±10%	■	–	–	■
	24 VAC	■ 24 VAC/DC ±10%	–	–	–	■
	100 to 120 VAC	■ 110 VAC ±10%	■	–	■	–
	200 to 240 VAC	■ 230 VAC ±10%	■	–	■	–
	Analog input	–	–	–	–	–
	Features	Built-in heat sink	–	–	–	–
Zero-cross		□	–	□	■	■
Built-in varistor		–	–	–	■	■
LED operation indicator		■	■	■	■	■
Protective cover		NA	NA	NA	■	■
3-phase loads via 3 single-phase SSRs		NA	NA	NA	■	■
Replaceable power cartridge		–	–	–	–	■
Alarm output		NA	NA	NA	–	–
Built-in failure detection		NA	NA	NA	–	–
SSR open circuits detection		NA	NA	NA	–	–
SSR short circuits detection	NA	NA	NA	–	–	
Mounting	DIN-rail	■	–	–	■	■
	Screw	–	–	–	■	■
	Mounting socket	■	■	■	–	–
Page/Quick Link	612	613	614	616		

Control panel mounting type				Power regulator	
					
G3PE	G3PE	G3PH	G3PF	G3PW	G3ZA
Normal resistive heaters	Normal resistive heaters	Normal resistive & lamp heaters	Normal resistors	Alloy heater Pure metal heater, nonmetal heater (Constant-current models recommended.)	Depends on the SSR used Distributes loop/control output levels (mV%) to SSRs
■	-	■	■	■	Depends on the SSR used
-	■	-	-	-	Depends on the SSR used
-	■	-	-	-	Depends on the SSR used
Heater control	Heater control	(Lamp) heater control	Heater control and diagnostics	Single-phase power control	Intelligent power control
45 A	45 A	150 A	35 A	60 A	Depends on the SSR used
-	-	-	-	-	-
■	■	■	■	■	■
■	■	■ (180 to 480)	■	-	■ 400 to 480
-	-	-	-	-	-
-	-	■	-	-	-
■	■	-	■	-	-
-	-	-	-	-	-
-	-	-	-	-	-
-	-	■ (100 to 240 VAC)	-	-	-
-	-	■ (100 to 240 VAC)	-	-	-
-	-	-	-	4 to 20 mA DC, 1 to 5 VDC	-
■	□	■	■	■	-
□	■	□	■	□	-
-	-	-	-	-	-
■	■	■	■	■	■
■	■	■	■	■	-
■	-	-	-	-	-
-	-	■	-	-	-
-	-	-	■	■	■
-	-	-	■	■	■
-	-	-	-	■	■
■	■	-	■	-	■
■	■	■	■	■	■
-	-	-	-	-	-
617		R438	R447	R442	R426

■ Standard □ Available - No/not available NA Not applicable

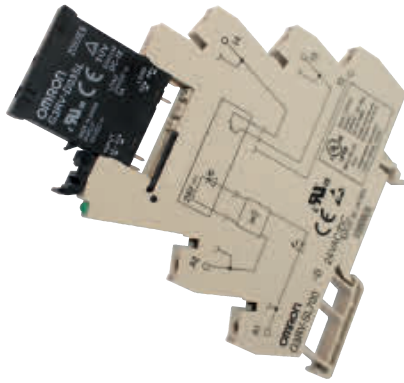

Industrial 6 mm “slim” SSR which is G2RV compatible

As well as being slim and thus saving panel space, G3RV relays are very strong, have a large contact area and non-bendable pins. Connection to a PLC is easy and achieved faultlessly in a few seconds via click connectors. In addition, power switching in G3RV relays with DC outputs is managed by a MOSFET in the output, which has ideal heat dissipation characteristics.

- G2RV compatible
- LED indicator built in SSR
- Push-in terminals and accessories for easy wiring

Ordering information

Zero cross function	Input Rated voltage (operating voltage)	Rated current			Must operate voltage	Must release voltage	Output			Type of connection	Order code
		AC		DC			Rated load voltage (load voltage range)	Load current	Inrush current		
		50 Hz	60 Hz								
-	24 VAC/DC (21.6 to 26.4 VAC/DC)	10.7 mA	11.1 mA	4.3 mA	21.6 V	1 V	5 to 24 VDC (3 to 26.4 VDC)	100 µA to 3 A	30 A (60 Hz, 1 cycle)	Screw	G3RV-SL700-D AC/DC24
-	24 VAC/DC (21.6 to 26.4 VAC/DC)	10.7 mA	11.1 mA	4.3 mA	21.6 V	1 V	5 to 24 VDC (3 to 26.4 VDC)	100 µA to 3 A	30 A (60 Hz, 1 cycle)	Push-in	G3RV-SL500-D AC/DC24
Yes	24 VAC/DC (21.6 to 26.4 VAC/DC)	20 mA	21 mA	11 mA	21.6 V	1 V	100 to 240 VAC (75 to 264 VAC)	0.1 A to 2 A	30 A (60 Hz, 1 cycle)	Screw	G3RV-SL700-A AC/DC24
Yes	24 VAC/DC (21.6 to 26.4 VAC/DC)	20 mA	21 mA	11 mA	21.6 V	1 V	100 to 240 VAC (75 to 264 VAC)	0.1 A to 2 A	30 A (60 Hz, 1 cycle)	Push-in	G3RV-SL500-A AC/DC24
-	230 VAC (207 to 253 VAC)	6.8 mA	8.1 mA	-	207 V	1 V	5 to 24 VDC (3 to 26.4 VDC)	100 µA to 3 A	30 A (60 Hz, 1 cycle)	Screw	G3RV-SL700-D AC230
-	230 VAC (207 to 253 VAC)	6.8 mA	8.1 mA	-	207 V	1 V	5 to 24 VDC (3 to 26.4 VDC)	100 µA to 3 A	30 A (60 Hz, 1 cycle)	Push-in	G3RV-SL500-D AC230

Note: Ratings at an ambient temperature of 25°C

Accessories

Type	Description	Order code
Cross bar	2-pole	P2RVM-020_
Cross bar	3-pole	P2RVM-030_
Cross bar	4-pole	P2RVM-040_
Cross bar	10-pole	P2RVM-100_
Cross bar	20-pole	P2RVM-200_
PLC interface	Connect 8 relays and PLC output	P2RVC-8-O-F
Label	Plastic, for mounting on socket	R99-15 for G2RV
Label (Sticker)	Paper for mounting on socket or relay	R99-16 for G2RV
Separating plate	Provides isolation between adjacent relays to achieve 400 V isolation	P2RV-S

Note: _ Select color: R=Red, S=Blue, B=Black

Specifications

Order code	G3RV-SL700/500-A	G3RV-SL700/500-D
Isolation	Triac	Mosfet
Output ON voltage drop	1.6 V rms max.	0.9 V max.
Leakage current	5 mA max. (at 200 VAC 50/60 Hz)	10 µA max. (at 24 VDC)
Operating indicator	Yes	
Ambient temperature	Storage	-30~+100°C (with no icing or condensation)
	Operating	-30~+55°C (with no icing or condensation)



Compact SSR for I/O interface with high dielectric strength requirements

High-speed models with optimum input ratings for a variety of sensors are available, as well as input and output modules that can be used instead of the G2RS. Use a coupler conforming to VDE 0884 and assuring an I/O dielectric strength of 4,000V.

- 1.5 and 2A output current
- 5 to 200VDC/100 to 240VAC output voltages
- Compatible with G2RS electromechanical relays
- DIN-rail mounting via sockets
- Operation indicator to confirm input

Ordering information

Input module

Response speed	Input				Output			Size in mm (HxWxD)	Order code
	Rated voltage (operating voltage)	Input current	Must operate voltage	Must release voltage	Logic level supply voltage	Logic level supply current			
–	100 to 240 VAC (60 to 264 VAC)	15 mA max.	60 VAC max.	20 VAC min.	4 to 32 VDC	0.1 to 100 mA	29x13x28 (90.5x16x61 in combination with P2RF-05-E mounting socket)	G3R-IAZR1SN-UTU	
High-speed (1 kHz)	5 VDC (4 to 6 VDC)	8 mA max.	4 VDC max.	1 VDC min.				G3R-IDZR1SN-UTU	
	12 to 24 VDC (6.6 to 32 VDC)		6.6 VDC max.	3.6 VDC min.					
Low-speed (10 Hz)	5 VDC (4 to 6 VDC)	8 mA max.	4 VDC max.	1 VDC min.				G3R-IDZR1SN-1-UTU	
	12 to 24 VDC (6.6 to 32 VDC)		6.6 VDC max.	3.6 VDC min.					

Note: Ratings at an ambient temperature of 25°C

Output module

Zero cross function	Input				Output				Size in mm (HxWxD)	Order code
	Rated voltage (operating voltage)	Input current	Must operate voltage	Must release voltage	Rated load voltage (load voltage range)	Load current ^{*1}	Inrush current			
Yes	5 to 24 VDC (4 to 32 VDC)	15 mA max.	4 VDC max.	1 VDC min.	100 to 240 VAC (75 to 264 VAC)	0.05 to 2 A	30 A (60 Hz, 1 cycle)	29x13x28 (90.5x16x61 in combination with P2RF-05-E mounting socket)	G3R-OA202SZN-UTU	
No									G3R-OA202SLN-UTU	
–		8 mA max.			5 to 48 VDC (4 to 60 VDC)	0.01 to 2 A	8 A (10 ms)		G3R-ODX02SN-UTU	
–									48 to 200 VDC (40 to 200 VDC)	0.01 to 1.5 A

Note: Ratings at an ambient temperature of 25°C

*1 The minimum current value is measured at 10°C min.

Socket & accessories

Order code						
DIN rail						PCB
Screwless clamp					Screw	Soldering
Socket	Clip	Cross bar AC type	Cross bar DC type	Name plate	Socket	Socket
P2RF-05-S	P2CM-S	P2RM-SR	P2RM-SB	R99-11	P2RF-05-E	P2R-05P

Specifications

	Input module			Output module			
	G3R-IAZR1SN-UTU	G3R-IDZR1SN-UTU	G3R-IDZR1SN-1-UTU	G3R-OA202SZN-UTU	G3R-OA202SLN-UTU	G3R-ODX02SN-UTU	G3R-OD201SN-UTU
Isolation	Photocoupler			Phototriac		Photocoupler	
Operate time	20 ms max.	0.1 ms max.	15 ms max.	1/2 of load power source cycle + 1 ms max.	1 ms max.	1 ms max.	1 ms max.
Release time	20 ms max.	0.1 ms max.	15 ms max.	1/2 of load power source cycle + 1 ms max.	2 ms max.	2 ms max.	2 ms max.
Response frequency	10 Hz	1 kHz	10 Hz	20 Hz	20 Hz	100 Hz	100 Hz
Output ON voltage drop	1.6 V max.	1.6 V max.	1.6 V max.	1.6 V max.	1.6 V max.	1.6 V max.	2.5 V max.
Leakage current	5 µA max.	5 µA max.	5 µA max.	1.5 mA max.	1.5 mA max.	1 mA max.	1 mA max.
Operation indicator	Yes						
Ambient temperature	Operating: -30 to 80°C (with no icing)						



Hockey puck style SSR with 5-90 A output currents

All models feature the same compact dimensions to provide a uniform mounting pitch. A built-in varistor effectively absorbs external surges. The operation indicator enables monitoring operation.

- 5-90 A output current
- 24-480 VAC/5-200VDC output voltages
- Built-in varistor
- Operation indicator (red LED)
- Protective cover for greater safety

Ordering information

Applicable output load	Zero cross function	Isolation	Rated input voltage	Must operate voltage	Must release voltage	Load current with/without heatsink at 40 °C	Size in mm (H×W×D)	Order code			
24 to 240 VAC	5 A	Yes	Phototriac	5 to 24 VDC	4 VDC max.	1 VDC min.	0.1 to 5 A/0.1 to 3 A	58×43×27	G3NA-205B-UTU DC5-24		
				100 to 120 VAC	75 VAC max.	20 VAC min.			G3NA-205B-UTU AC100-120		
			Photocoupler	200 to 240 VAC	150 VAC max.	40 VAC min.	0.1 to 10 A/0.1 to 4 A	58×43×27	G3NA-205B-UTU AC200-240		
				Phototriac	5 to 24 VDC	4 VDC max.			1 VDC min.	G3NA-210B-UTU DC5-24	
			Photocoupler	100 to 120 VAC	75 VAC max.	20 VAC min.	0.1 to 20 A/0.1 to 4 A	58×43×27	G3NA-210B-UTU AC100-120		
				200 to 240 VAC	150 VAC max.	40 VAC min.			G3NA-210B-UTU AC200-240		
	20 A	Phototriac	5 to 24 VDC	4 VDC max.	1 VDC min.	0.1 to 20 A/0.1 to 4 A	58×43×27	G3NA-220B-UTU DC5-24			
			100 to 120 VAC	75 VAC max.	20 VAC min.			G3NA-220B-UTU AC100-120			
			200 to 240 VAC	150 VAC max.	40 VAC min.			G3NA-220B-UTU AC200-240			
	40 A	Phototriac	5 to 24 VDC	4 VDC max.	1 VDC min.	0.1 to 40 A/0.1 to 6 A	58×43×27	G3NA-240B-UTU DC5-24			
			100 to 120 VAC	75 VAC max.	20 VAC min.			G3NA-240B-UTU AC100-120			
			200 to 240 VAC	150 VAC max.	40 VAC min.			G3NA-240B-UTU AC200-240			
	50 A	Phototriac	5 to 24 VDC	4 VDC max.	1 VDC min.	0.1 to 50 A/0.1 to 6 A	58×43×27	G3NA-250B-UTU DC5-24			
			100 to 120 VAC	75 VAC max.	20 VAC min.			G3NA-250B-UTU AC100-120			
			200 to 240 VAC	150 VAC max.	40 VAC min.			G3NA-250B-UTU AC200-240			
	75 A	Phototriac	5 to 24 VDC	4 VDC max.	1 VDC min.	1 to 75 A/1 to 7 A	58×43×30	G3NA-275B-UTU-2 DC5-24			
			100 to 240 VAC	75 VAC max.	20 VAC min.			G3NA-275B-UTU-2 AC100-240			
	90 A	Phototriac	5 to 24 VDC	4 VDC max.	1 VDC min.	1 to 90 A/1 to 7 A	58×43×30	G3NA-290B-UTU-2 DC5-24			
100 to 240 VAC			75 VAC max.	20 VAC min.	G3NA-290B-UTU-2 AC100-240						
5 to 200 VDC	10 A	No	Photocoupler	5 to 24 VDC	4 VDC max.	1 VDC min.	0.1 to 10 A/0.1 to 4 A	58×43×27	G3NA-D210B-UTU DC5-24		
				100 to 240 VAC	75 VAC max.	20 VAC min.			G3NA-D210B-UTU AC100-240		
200 to 480 VAC	10 A	Yes	Photocoupler	5 to 24 VDC	4 VDC max.	1 VDC min.	0.2 to 10 A/0.2 to 4 A	58×43×27	G3NA-410B-UTU DC5-24		
				100 to 240 VAC	75 VAC max.	20 VAC min.			G3NA-410B-UTU AC100-240		
				25 A	Photocoupler	5 to 24 VDC	4 VDC max.	1 VDC min.	0.2 to 20 A/0.2 to 4 A	58×43×27	G3NA-425B-UTU-2 DC5-24
						100 to 240 VAC	75 VAC max.	20 VAC min.			G3NA-425B-UTU-2 AC100-240
				50 A	Photocoupler	5 to 24 VDC	4 VDC max.	1 VDC min.	0.2 to 40 A/0.2 to 6 A	58×43×30	G3NA-450B-UTU-2 DC5-24
						100 to 240 VAC	75 VAC max.	20 VAC min.			G3NA-450B-UTU-2 AC100-240
	75 A	Photocoupler	5 to 24 VDC	4 VDC max.	1 VDC min.	1 to 75 A/1 to 7 A	58×43×30	G3NA-475B-UTU-2 DC5-24			
			100 to 240 VAC	75 VAC max.	20 VAC min.			G3NA-475B-UTU-2 AC100-240			
	90 A	Photocoupler	5 to 24 VDC	4 VDC max.	1 VDC min.	1 to 90 A/1 to 7 A	58×43×30	G3NA-490B-UTU-2 DC5-24			
			100 to 240 VAC	75 VAC max.	20 VAC min.			G3NA-490B-UTU-2 AC100-240			

Accessories

Name	Applicable SSRs	Size in mm (H×W×D) ^{*1}	Order code
One-touch mounting plates	–	NA	R99-12 FOR G3NA
Mounting bracket	G3NA-240B-UTU	NA	R99-11 FOR G3NA
Slim heat sink enabling DIN-rail mounting	G3NA-205B-UTU, G3NA-210B-UTU, G3NA-D210B-UTU, G3NA-410B-UTU	100×47×51	Y92B-N50
	G3NA-220B-UTU, G3NA-425B-UTU(-2)	100×75×100	Y92B-N100
	G3NA-240B-UTU, G3NA-250B-UTU	100×104×100	Y92B-N150
	G3NA-450B-UTU(-2)	190.5×130.5×100	Y92B-P250
	G3NA-275B-UTU(-2), G3NA-290B-UTU(-2), G3NA-475B-UTU(-2), G3NA-490B-UTU(-2)	172×110×150	Y92B-P250NF
	G3NA-240B-UTU	150×102×60	Y92B-A150N
Low-cost heat sink	G3NA-205B-UTU, G3NA-210B-UTU, G3NA-D210B-UTU, G3NA-220B-UTU, G3NA-410B-UTU, G3NA-425B-UTU(-2)	100×102×60	Y92B-A100
	G3NA-240B-UTU	150×102×60	Y92B-A150N

^{*1} Size includes heat sink + G3NA SSR

Specifications

Operating voltage range	5 to 24 VDC; 4 to 32 VDC 100 to 120 VAC; 75 to 132 VAC 200 to 240 VAC; 150 to 264 VAC
Output ON voltage drop	G3NA-2: 1.6 V (RMS) max. G3NA-4: 1.8 V (RMS) max. G3NA-D2: 1.5 V max.
Leakage current	5 mA (100 V)/10 mA (200 V) G3NA-D2: 5 mA max. (200 VDC)
Load voltage range	200 to 480 VAC; 180 to 528 VAC 24 to 240 VAC; 19 to 264 VAC 5 to 200 VDC; 4 to 220 VDC
Ambient temperature	Operating: -30 to 80°C
Operate & release time	1/2 of load power source cycle + 1 ms max. (DC input) 1/2 of load power source cycle + 1 ms max. (DC input)
G3NA-D2	1 ms max. (DC input; release 5 ms), 30 ms max. (AC input)



Solid State Relays with exchangeable power cartridge

Optimum design of the heat sink has contributed to the downsizing of this product. The power element cartridges of the G3PA are easily replaceable for easy maintenance. G3PA can be mounted on a DIN-rail or using screws.

- 10-60 A output current
- 24-480 VAC output voltages
- Applicable with 3-phase loads
- Replaceable power element cartridges

Ordering information

Rated output load	Zero cross function	Rated input voltage	Operating voltage range	Input current impedance	Voltage level		Size in mm (H×W×D)	Order code
					Must operate voltage	Must release voltage		
24 to 240 VAC	Yes	5 to 24 VDC	4 to 30 VDC	7 mA max.	4 VDC max.	1 VDC min.	100×27×100	G3PA-210B-VD DC5-24
							100×37×100	G3PA-220B-VD DC5-24
							100×47×100	G3PA-240B-VD DC5-24
							100×110×100	G3PA-260B-VD DC5-24
		24 VAC	19.2 to 26.4 VAC	1.4 kΩ ±20%	19.2 VAC max.	4.8 VAC min.	100×27×100	G3PA-210B-VD AC24
							100×37×100	G3PA-220B-VD AC24
							100×47×100	G3PA-240B-VD AC24
							100×110×100	G3PA-260B-VD AC24
180 to 400 VAC	20 A	12 to 24 VDC	9.6 to 30 VDC	7 mA max.	9.2 VDC max.	1 VDC min.	100×37×100	G3PA-420B-VD DC12-24
							100×47×100	G3PA-430B-VD DC12-24
200 to 480 VAC	20 A	12 to 24 VDC	9.6 to 30 VDC	7 mA max.	9.2 VDC max.	1 VDC min.	100×37×100	G3PA-420B-VD-2 DC12-24
							100×47×100	G3PA-430B-VD-2 DC12-24
							100×47×100	G3PA-430B-VD-2 DC12-24
							100×110×100	G3PA-450B-VD-2 DC12-24

Accessories

Replacement parts: Power device cartridges			
Load voltage range	Carry current	Applicable SSR	Order code
19 to 264 VAC	10 A	G3PA-210B-VD DC5-24	G32A-A10-VD DC5-24
		G3PA-210B-VD AC24	G32A-A10-VD AC24
	20 A	G3PA-220B-VD DC5-24	G32A-A20-VD DC5-24
		G3PA-220B-VD AC24	G32A-A20-VD AC24
	40 A	G3PA-240B-VD DC5-24	G32A-A40-VD DC5-24
		G3PA-240B-VD AC24	G32A-A40-VD AC24
	60 A	G3PA-260B-VD DC5-24	G32A-A60-VD DC5-24
		G3PA-260B-VD AC24	G32A-A60-VD AC24
150 to 440 VAC	20 A	G3PA-420B-VD DC12-24	G32A-A420-VD DC12-24
	30 A	G3PA-430B-VD DC12-24	G32A-A430-VD DC12-24
180 to 528 VAC	20 A	G3PA-420B-VD-2 DC12-24	G32A-A420-VD-2 DC12-24
	30 A	G3PA-430B-VD-2 DC12-24	G32A-A430-VD-2 DC12-24
	50 A	G3PA-450B-VD-2 DC12-24	G32A-A450-VD-2 DC12-24

G32A-D_ _ enables 2 line switching of 3 phase configurations		
Current flow	Applicable SSR	Order code
10 A	G3PA-210B-VD, G3PA-210BL-VD, G3PA-220B-VD, G3PA-220BL-VD, G3PA-420B-VD, G3PA-420B-VD-2	G32A-D20
20 A		
30 A	G3PA-430B-VD, G3PA-430B-VD-2, G3PA-240B-VD, G3PA-240BL-VD	G32A-D40
40 A		

Specifications

Isolation	Phototriac coupler
Indicator	Yes
Ambient temperature	Operating: -30 to 80°C
Load voltage range	200 to 480 VAC: 180 to 528 VAC 24 to 240 VAC: 19 to 264 VAC 180 to 400 VAC: 150 to 440 VAC
Output ON drop	1.6 V (RMS) max.
Operate time	0.5 of load power source cycle + 1 ms max. (DC input, -B models) 1.5 of load power source cycle + 1 ms max. (AC input) 1 ms max. (-BL models)
Release time	0.5 of load power source cycle + 1 ms max. (DC input) 1.5 of load power source cycle + 1 ms max. (AC input)



Omron's G3PE compact industrial SSR with outstanding surge endurance

The G3PE features an original surge-pass circuit that gives outstanding surge endurance and protects the semiconductor device against voltages in excess of 30 kV.

- Single and three phase, 15-45 A output current
- 100-240 VAC and 200-480 VAC output voltages
- Models available without zero cross
- Improved surge dielectric strength for output circuits
- Terminal cover with finger protection
- Mount to DIN track or with screws

Ordering information

Phases	Rated voltage (operating voltage)	Rated output load	Permissible I^2t (half 60 Hz wave)	Applicable heater capacity AC1: resistive load)	Size in mm (H×W×D)	Number of poles	Order code
1	100 to 240 VAC (75 to 264 VAC)	15 A (at 40°C)	121 A ² s	3 kW (at 200 VAC)	100×22.5×100	1	G3PE-215B DC12-24
		25 A (at 40°C)	260 A ² s	5 kW (at 200 VAC)		1	G3PE-225B DC12-24
		35 A	1,260 A ² s	7 kW (at 200 VAC)	100×44.5×100	1	G3PE-235B DC12-24
		45 A		9 kW (at 200 VAC)		1	G3PE-245B DC12-24
	200 to 480 VAC (180 to 528 VAC)	15 A (at 40°C)	128 A ² s	6 kW (at 400 VAC)	100×22.5×100	1	G3PE-515B DC12-24
		25 A (at 40°C)	1,350 A ² s	10 kW (at 400 VAC)		100×44.5×100	1
		35 A		14 kW (at 400 VAC)	1		G3PE-535B DC12-24
		45 A	6,600 A ² s	18 kW (at 400 VAC)	1	G3PE-545B DC12-24	
3	200 to 480 VAC (180 to 528 VAC)	15 A (at 40°C)	260 A ² s	12.5 kW (at 480 VAC)	100×80×155	3	G3PE-515B-3N DC12-24
				20.7 kW (at 480 VAC)		2	G3PE-515B-2N DC12-24
		25 A (at 40°C)	1,260 A ² s	29 kW (at 480 VAC)	120×80×155	3	G3PE-525B-3N DC12-24
				37.4 kW (at 480 VAC)		2	G3PE-525B-2N DC12-24
		35 A	1,260 A ² s	29 kW (at 480 VAC)	140×80×155	3	G3PE-535B-3N DC12-24
						2	G3PE-535B-2N DC12-24
		45 A	1,260 A ² s	37.4 kW (at 480 VAC)	140×110×155	3	G3PE-545B-3N DC12-24
						2	G3PE-545B-2N DC12-24

Specifications

Rated input voltage	12 to 24 VDC
Operating voltage range	9.6 to 30 VDC
Rated input current (impedance)	7 mA max. (zero cross models); 15 mA max. (models without zero cross)
Zero cross function	Yes
Must operate voltage	9.6 VDC max.
Must release voltage	1 VDC min.
Isolation method	Phototriac coupler
Operation indicator	Yes (yellow)
Load voltage range	200 to 480 VAC models: 180 to 528 VAC 100 to 240 VAC models: 75 to 264 VAC
Operate time	1/2 of load power source cycle + 1 ms max.
Release time	1/2 of load power source cycle + 1 ms max.
Leakage current	10 mA (at 200 VAC)
Ambient temperature	Operating: -30 to 80°C

Low voltage switchgear

J7KN MOTOR CONTACTOR

J7KN – Motor contactors

The popular J7KN series offers many outstanding benefits, such as space-saving, small footprint, great reliability, and an ambient temperature rating up to +90°C. But now we've replaced it with a completely new design that extends its application range and will make your life even easier.

The new J7KN 10D to 22D series has the same footprint and severe ambient temperature rating, but has an improved design affording better protection, easier maintenance plus an integrated auxiliary double contact suitable for switching electronic circuits (17 V, 5 mA).

- Basic units can be combined with auxiliary contacts (top/side mounting)
- 3-main-pole and 4-main-pole versions are possible
- The power range covers 4 to 500 kW
- Different coil voltages (AC and DC)
- J7KN-10D to J7KN-22D models have integrated auxiliary contact for electronic circuits (3-pole versions)

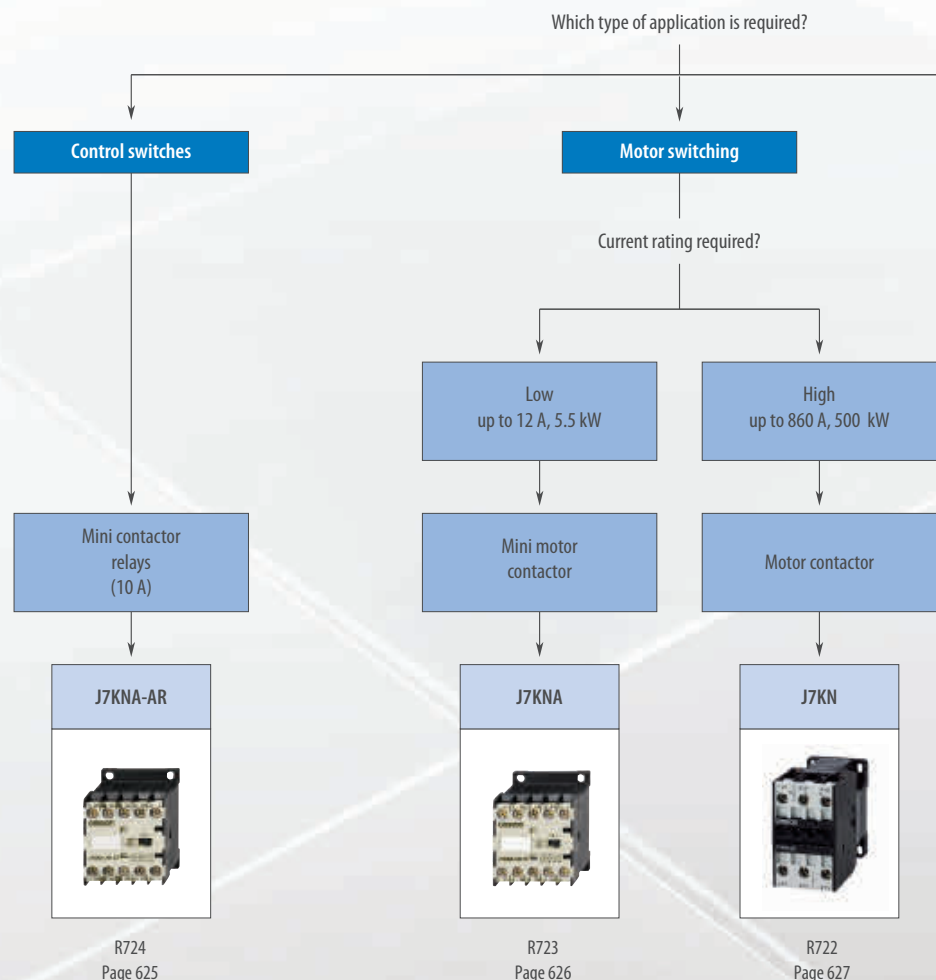

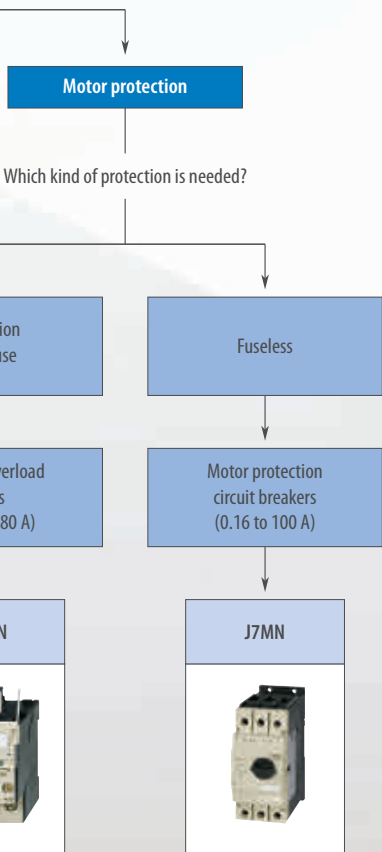





R726
Page 629





R725
Page 631



Selection table







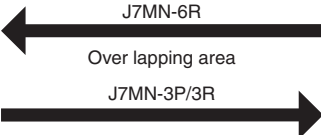

Category		Motor protection circuit breaker
MPCB		
	Type	J7MN-3P/3R
	Setting range current	0.16 - 32 A
	Number of ranges	16
	Auxiliary contact external	front 1 NO and 1 NC or 2 NO, side 1 NO and NC or 2 NO or 2 NC
Page/Quick Link	631	



Category		Contactors					
Contactors							
	Type	J7KNA-AR	J7KNA-09/12	J7KN(G)-10(D)	J7KN(G)-14(D)	J7KN(G)-18(D)	J7KN(G)-22(D)
	Maximum power AC3-380/415 V	-	4 kW or 5 kW	4 kW	5.5 kW	7.5 kW	11 kW
	Rated current AC3-380/415 V	10 A th	9/12 A	10 A	14 A	18 A	22 A
	Main contacts	4 in 4 configurations	3 or 4	3 or 4			
	Auxiliary contacts	Included	-	1	1 NO or 1 NC		
		External	4 in different combinations		4 contacts ^{*1}		
Page/Quick Link	625	626	627		627		

Category		Thermal overload	
Thermal overload			
	Type	J7TKN-A	J7TKN-B
	Setting range D.O.L.	0.12 - 14 A	0.12 - 32 A
	Number of ranges	13	16
	Auxiliary contacts included	1 NO and 1 NC	1 NO and 1 NC
	Page/Quick Link	629	629

^{*1} Using J7KN with DC double wiring coils results in 1 aux. less



Motor protection circuit breaker	
	
	
J7MN-6R	J7MN-9R
26 - 63 A	63 - 100 A
5	4
front 1 NO and 1 NC or 2 NO, side 1 NO and NC or 2 NO or 2 NC	
631	



Contactors							
							
J7KN(G)-24	J7KN(G)-32	J7KN(G)-40	J7KN-50	J7KN-62	J7KN-74	J7KN-90	J7KN-115
11 kW	15 kW	18.5 kW	22 kW	30 kW	37 kW	45 kW	55 kW
24 A	32 A	40 A	50 A	62 A	74 A	90 A	115 A
3			3			3	
-			-			-	
front and side 8-contacts ^{*1}			front and side 8-contacts ^{*1}			front and side 11-contacts	
627			627			627	

Thermal overload		
		
J7TKN-C	J7TKN-D	J7TKN-E
28 - 42 A	40 - 74 A	60 - 120 A
1	3	2
1 NO and 1 NC	1 NO and 1 NC	1 NO and 1 NC
629	629	629

*1 Using J7KN with DC double wiring coils results in 1 aux. less

Selection table

Category		Contactors				
Contactors						
	Type	J7KN-151	J7KN-176	J7KN-210	J7KN-260	
	Maximum power AC3-380/415 V	75 kW	90 kW	110 kW	132 kW	
	Rated current AC3-380/415 V	150 A	175 A	210 A	260 A	
	Main contacts	3 or 4		3		
	Auxiliary contacts	Included	-		-	
		External	front and side 6-contacts		front and side 8-contacts	
Page/Quick Link	627					

Category		Thermal overload		
Thermal overload				
	Type	J7TKN-E	J7TKN-F	J7TKN-G
	Setting range D.O.L.	60 - 120 A	120 - 180 A	144 - 320 A
	Number of ranges	2	1	2
	Auxiliary contacts included	1 NO and 1 NC	1 NO and 1 NC	1 NO and 1 NC
	Page/Quick Link	629		

Contactors



J7KN-316	J7KN-450-22	J7KN-550-22	J7KN-700-22	J7KN-860-22
160 kW	250 kW	300 kW	400 kW	500 kW
315 A	450 A	550 A	700 A	860 A
3	3	3	3	3
–	4	4	4	4
front and side 8-contacts	front 4-contacts	front 4-contacts	front 4-contacts	front 4-contacts

627

Thermal overload



J7TKN-G	J7TKN-H
144 - 320 A	240 - 800 A
2	3
1 NO and 1 NC	1 NO and 1 NC

629



Main mini contactor relay, 4-pole

Three basic units can be combined with different additional auxiliary contacts. 4-pole, 6-pole and 8-pole versions in different configurations are possible as well as different coil voltages (AC and DC). Accessories such as suppressors are available.

- Mirror contacts
- Screw fixing and snap fitting (35 mm DIN-rail)
- Rated current = 10 A (I_{th})
- Suitable for electronic devices (DIN 19240)
- Finger proof (BGV A2)

Ordering information

Operation	Contacts		Distinctive number according to DIN EN 50011	Ratings		Thermal rated current I_{th} , A	Order code	Coil voltage ^{*1} , replace ___ with:				
	NO	NC		AC15 230 V A	400 V A			VAC	VAC	VAC	VDC	VDC
4-pole, with screw terminals												
AC	4	0	40 E	3	2	10	J7KNA-AR-40 ___	24	110	230	-	-
	3	1	31 E	3	2	10	J7KNA-AR-31 ___	24	110	230	-	-
	2	2	22 E	3	2	10	J7KNA-AR-22 ___	24	110	230	-	-
DC solenoid	4	0	40 E	3	2	10	J7KNA-AR-40 ___	-	-	-	24D	110D
	3	1	31 E	3	2	10	J7KNA-AR-31 ___	-	-	-	24D	110D
	2	2	22 E	3	2	10	J7KNA-AR-22 ___	-	-	-	24D	110D
DC solenoid with diode	4	0	40 E	3	2	10	J7KNA-AR-40 ___	-	-	-	24VS	-
	3	1	31 E	3	2	10	J7KNA-AR-31 ___	-	-	-	24VS	-
	2	2	22 E	3	2	10	J7KNA-AR-22 ___	-	-	-	24VS	-

*1 Other coil voltages available on request

Accessories

Contacts		Ratings		Thermal rated current		Order code
NO	NC	AC15 230 V A	400 V A	I_{th} , A	I_{th} , A	
1	1	3	2	10	10	J73KN-A-11
0	2	3	2	10	10	J73KN-A-02
4	0	3	2	10	10	J73KN-A-40
2	2	3	2	10	10	J73KN-A-22
0	4	3	2	10	10	J73KN-A-04

Specifications

Suffix to contactor type e.g. J7KNA-09-10-24	Voltage marking at the coil for		Rated control voltage U_s range for			
	50 Hz	60 Hz	50 Hz		60 Hz	
	V	V	min. V	max. V	min. V	max. V
24	24	24	22	24	24	24
110	110 to 115	120 to 125	110	115	120	125
230	220 to 230	240	220	230	240	250



Motor contactors from 4 to 5.5 kW for normal duty switching

This modular system consists of main contactors and additional contact blocks. The basic units can be combined with auxiliary contacts (top mounting). Reversed versions, including integrated mechanical interlock, are available as well as 3-main-pole and 4-main-pole versions.

- 4 kW and 5.5 kW versions are available
- Different coil voltages (AC and DC)
- Mini and normal-size versions are available
- The contactors can be mounted with screw fixing and snap fitting on a DIN-rail
- All components are finger proof

Ordering information

Operation	Poles	Rating AC2, AC3			Rated current		Auxiliary contact		Overload relay	Size in mm (H×W×D)	Order code	Coil voltage*1, replace ___ with:				
		380 V 400 V 415 V kW	500 V kW	660 V 690 V kW	AC3 400 V A	AC1 690 V A	NO	NC				VAC			VDC	
		4	4	4	9	20	1	0				24	110	230	400	24D
AC/DC solenoid	3	4	4	4	9	20	1	0	J7TKN-A	57.5×45×49	J7KNA-09-10_ ___	24	110	230	400	24D
		5.5	5.5	5.5	12	20	0	1	J7TKN-A		J7KNA-09-01_ ___	24	110	230	400	24D
	4	4	4	9	20	1	0	J7TKN-A	J7KNA-12-10_ ___		24	110	230	400	24D	
	5.5	5.5	5.5	12	20	0	1	J7TKN-A	J7KNA-12-01_ ___		24	110	230	400	24D	
DC solenoid with diode	3	4	4	4	9	20	0	0	J7TKN-A		J7KNA-09-4_ ___	24	110	230	400	24D
		5.5	5.5	5.5	12	20	1	0	J7TKN-A		J7KNA-09-10_ ___	-	-	-	-	24VS
	4	4	4	9	20	0	1	J7TKN-A	J7KNA-09-01_ ___		-	-	-	-	24VS	
	5.5	5.5	5.5	12	20	1	0	J7TKN-A	J7KNA-12-10_ ___		-	-	-	-	24VS	
AC/DC solenoid DC solenoid with diode	3 reversing contactors	4	4	4	9	20	0	1	J7TKN-A	57.5×94.5×50	J7KNA-12-01_ ___	-	-	-	-	24VS
		5.5	5.5	5.5	12	20	0	1	J7TKN-A		J7KNA-09-01 R_ ___	24	110	230	400	24D
		4	4	4	9	20	0	1	J7TKN-A		J7KNA-12-01 R_ ___	24	110	230	400	24D
		5.5	5.5	5.5	12	20	0	1	J7TKN-A		J7KNA-09-01 R_ ___	-	-	-	-	24VS
											J7KNA-12-01 R_ ___	-	-	-	-	24VS

*1 Other coil voltages available on request

Accessories

Auxiliary contacts				
Contacts		Rated current		Order code
NO	NC	AC15 230 V	400 V	
1	1	3 A	2 A	J73KN-AM-11
0	2	3 A	2 A	J73KN-AM-02
2	2	3 A	2 A	J73KN-AM-22
Auxiliary contacts for reversing contactors				
1	1	3 A	2 A	J73KN-AM-11V
1	1	3 A	2 A	J73KN-AM-11X
Link modules between MPCB & contactors				
For MPCB J7MN-3P/J7MN-3R				J77MN-VKA-3
Insulated wiring system for J7KNA-09-01-R...(D) and J7KNA-12-01-R...(D)				
Reversing Starter Connector for Mini Reversing Contactors, mechanical interlocked				J74-WKR-A

Specifications

Suffix to contactor type e.g. J7KNA-09-10-24	Voltage marking at the coil for		Rated control voltage U ₃ range for			
	50 Hz V	60 Hz V	50 Hz min. V	max. V	60 Hz min. V	max. V
24	24	24	22	24	24	24
110	110 to 115	120 to 125	110	115	120	125
230	220 to 230	240	220	230	240	250

Main contacts		J7KNA-09- ___	J7KNA-12- ___
Rated insulation voltage U _i		690 VAC	690 VAC
Making capacity I _{eff} at U _e = 690 VAC		165 A	165 A
Breaking capacity I _{eff} cosφ = 0,65	400 VAC	100 A	100 A
	500 VAC	90 A	90 A
	690 VAC	80 A	80 A
Mechanical life AC operated		5 × 106	5 × 106
DC operated		15 × 106	15 × 106
Short time current		10 s current	96 A
			120 A



Motor contactors from 4–500 kW for normal and heavy-duty switching

This modular system consists of main contactors and additional contact blocks. The basic units can be combined with auxiliary contacts. DC-DC versions, integrated mechanical interlock, are available as well as 3-main-pole and 4-main-pole versions.

- Basic units can be combined with auxiliary contacts (top/side mounting)
- 3-main-pole and 4-main-pole versions are possible
- The power range covers 4 to 500 kW
- Different coil voltages (AC and DC)
- J7KN-10D to J7KN-22D models have integrated auxiliary contact for electronic circuits (3-pole versions)

Ordering information

Operation	Poles	AC3 400 V rated motor current	Rating AC2, AC3			Rated current AC1 690 V A	Auxiliary contact		Overload relay	Size in mm (H × W × D)	Order code	Coil voltage ^{*1} , replace ____ with:								
			380 V 400 V 415 V kW	500 V kW	660 V 690 V kW		NO	NC				VAC			VDC					
												24	110	230	400	24D	110D			
AC or DC	3	10 A	4	5.5	5.5	25	1	0	J7TKN-B	67 × 45 × 82.5	J7KN-10D-10_	24	110	230	400	24D	110D			
			4	5.5	5.5	25	0	1			J7KN-10D-01_	24	110	230	400	24D	110D			
		14 A	5.5	7.5	7.5	25	1	0			J7KN-14D-10_	24	110	230	400	24D	110D			
			5.5	7.5	7.5	25	0	1			J7KN-14D-01_	24	110	230	400	24D	110D			
		18 A	7.5	10	10	32	1	0			J7KN-18D-10_	24	110	230	400	24D	110D			
			7.5	10	10	32	0	1			J7KN-18D-01_	24	110	230	400	24D	110D			
		22 A	11	10	10	32	1	0			J7KN-22D-10_	24	110	230	400	24D	110D			
			11	10	10	32	0	1			J7KN-22D-01_	24	110	230	400	24D	110D			
		J7TKN-C	24 A	11	15	15	50	0			0	J7KN-24_	24	110	230	400	24D	110D		
			32 A	15	18.5	18.5	65	0			0	J7KN-32_	24	110	230	400	24D	110D		
			40 A	18.5	18.5	18.5	80	0			0	J7KN-40_	24	110	230	400	24D	110D		
			50 A	22	30	30	110	0			0	J7TKN-D	112 × 60 × 113	J7KN-50_	24	110	230	400	24D	110D
			62 A	30	37	37	120	0			0	J7KN-62_	24	110	230	400	24D	110D		
			74 A	37	45	45	130	0			0	J7KN-74_	24	110	230	400	24D	110D		
AC and DC ^{*2}	3	90 A	45	55	55	160	0	0	J7TKN-E	155 × 90 × 136	J7KN-90_	24	110	230	400	24	110			
		115 A	55	75	55	200	0	0	J7KN-115_	24	110	230	400	24	110					
		150 A	75	75	75	230	0	0	J7TKN-F	290 × 110 × 162	J7KN-151_	24	110	230	400	24	110			
		175 A	90	90	90	250	0	0	J7KN-176_	24	110	230	400	24	110					
		210 A	110	160	160	350	0	0	J7TKN-G	200 × 145 × 208	J7KN-210_	24	110	230	400	24	110			
		260 A	132	210	210	450	0	0	J7KN-260_	24	110	230	400	24	110					
		315 A	160	250	250	500	0	0	J7KN-316_	24	110	230	400	24	110					
		450 A	250	375	375	600	2	2	J7TKN-H	258 × 220 × 225	J7KN-450-22_	24	110	230	400	24	110			
		550 A	300	475	475	760	2	2	J7KN-550-22_	24	110	230	400	24	110					
		700 A	400	630	630	1000	2	2	J7KN-700-22_	310 × 280 × 291	J7KN-700-22_	24	110	230	400	24	110			
860 A	500	700	700	1100	2	2	J7KN-860-22_	361 × 280 × 291	J7KN-860-22_	24	110	230	400	24	110					
DC operated solenoid motor contactor	3	10 A	4	5.5	5.5	25	1	0	J7TKN-B	67 × 45 × 82.5	J7KNG-10-10_	-	-	-	-	24D	110D			
			4	5.5	5.5	25	0	1			J7KNG-10-01_	-	-	-	-	24D	110D			
		14 A	5.5	7.5	7.5	25	1	0			J7KNG-14-10_	-	-	-	-	24D	110D			
			5.5	7.5	7.5	25	0	1			J7KNG-14-01_	-	-	-	-	24D	110D			
		18 A	7.5	10	10	32	1	0			J7KNG-18-10_	-	-	-	-	24D	110D			
			7.5	10	10	32	0	1			J7KNG-18-01_	-	-	-	-	24D	110D			
		22 A	11	10	10	32	1	0			J7KNG-22-10_	-	-	-	-	24D	110D			
			11	10	10	32	0	1			J7KNG-22-01_	-	-	-	-	24D	110D			
		24 A	11	15	15	50	0	0			J7TKN-B	78 × 45 × 104.5	J7KNG-24_	-	-	-	-	24D	110D	
		32 A	15	18.5	18.5	65	0	0			J7TKN-C	J7KNG-32_	-	-	-	-	24D	110D		
40 A	18.5	18.5	18.5	80	0	0	J7KNG-40_	-	-	-	-	24D	110D							

*1 Other coil voltages available on request

*2 Universal current (AC and DC)

Operation	Poles	AC3 400 V rated motor current	Rating AC2, AC3		Rated current	Auxiliary contact		Overload relay	Size in mm (H × W × D)	Order code	Coil voltage *1, replace ___ with:							
			380 V 400 V 415 V kW	AC1 400 V kW		AC1 690 V A	NO				NC	VAC			VDC			
AC	4	10 A	4	17.5	25	0	0	-	67 × 45 × 82.5	J7KN-10D-4-___	24	110	230	400	-			
		14 A	5.5	17.5	25	0	0			J7KN-14D-4-___	24	110	230	400				
		18 A	7.5	22	32	0	0			J7KN-18D-4-___	24	110	230	400				
		22 A	11	22	32	0	0			J7KN-22D-4-___	24	110	230	400				
DC solenoid mo- tor contactor	4	10 A	4	17.5	25	0	0	-	67 × 45 × 82.5	J7KNG-10-4-___	-						24D	110D
		14 A	5.5	17.5	25	0	0			J7KNG-14-4-___							24D	110D
		18 A	7.5	22	32	0	0			J7KNG-18-4-___							24D	110D
		22 A	11	22	32	0	0			J7KNG-22-4-___							24D	110D
AC and DC*2	4	150 A	75	159	230	0	0	-	170 × 110 × 162	J7KN-151-4-___*2	24	110	230	400	24	110		
		175 A	90	173	250	0	0			J7KN-176-4-___*2	24	110	230	400	24	110		

*1 Other coil voltages available on request
*2 Universal current (AC and DC)

Accessories

Auxiliary contact blocks	Rated operational current			Contacts		Order code
	AC15 230 V A	AC15 400 V A	AC1 690 V A	NO	NC	
Suitable for:						
J7KN-10D... to -74...	3	2	10	1	-	J73KN-B-10
	3	2	10	-	1	J73KN-B-01
	3	2	10	1	-	J73KN-B-10U
	3	2	10	-	1	J73KN-B-01U
	6	4	25	1	-	J73KN-B-10A
	6	4	25	-	1	J73KN-B-01A
J7KN-24... to -115...	3	3	10	1	1	J73KN-C-11S
J7KN-151... to -316...	3	2	10	1	1	J73KN-D-11F
	3	2	10	2	2	J73KN-D-22F
	3	2	10	1	1	J73KN-D-11S
J7KN-450... to -860...	3	2	10	2	2	J73KN-E-22F

Pneumatic timers	Function	Time range	Contacts		Order code	
			NO	NC		
Suitable for:						
J7KN-10D... to -74...	3	2	10	1	-	J73KN-B-10
	3	2	10	-	1	J73KN-B-01
	3	2	10	1	-	J73KN-B-10U
	3	2	10	-	1	J73KN-B-01U
	6	4	25	1	-	J73KN-B-10A
	6	4	25	-	1	J73KN-B-01A
J7KN-24... to -115...	3	3	10	1	1	J73KN-C-11S
J7KN-151... to -316...	3	2	10	1	1	J73KN-D-11F
	3	2	10	2	2	J73KN-D-22F
	3	2	10	1	1	J73KN-D-11S
J7KN-450... to -860...	3	2	10	2	2	J73KN-E-22F

Mechanical interlocks	Interlocks contactor with contactor	Order code
Mounting	Order code + Order code	
Horizontal	J7KN(G)-10D to -40 + J7KN(G)-10D to -40	J74KN-B-ML
	J7KN-24 to -74 + J7KN-24 to -74	J74KN-C-ML
	J7KN-90 to -115 + J7KN-90 to -115	J74KN-D2-ML
	J7KN-151 to -316 + J7KN-151 to -316	J74KN-E-ML

Suppressor units Suitable for contactors	Type		Applicable coil voltage	Order code
	AC/DC	RC-unit snap-on contactor		
J7KNA(-AR)	AC/DC	RC-unit snap-on contactor	12 to 48 V	J74KN-D-RC24
	AC/DC		48 to 127 V	J74KN-D-RC110
	AC/DC		110 to 250 V	J74KN-D-RC230
J7KN-10D to -74	AC/DC	RC-unit snap-on contactor	12 to 48 V	J74KN-C2-RC24
	AC/DC		48 to 127 V	J74KN-C2-RC110
	AC/DC		110 to 230 V	J74KN-C2-RC230
	AC/DC		230 to 415 V	J74KN-C2-RC400

Additional terminals single pole	Cable cross-sections to clamp (mm ²)			Order code
	Suitable for contactors	Solid or stranded	Flexible with multi-core cable end	
J7KN-50 to -74	4 to 35	6 to 25	4 to 25	J74KN-LG-9030
J7KN-151 to -176	16 to 120	-	16 to 95	J74KN-LG-11224

Terminal covers	Specification	Order code
Suitable for contactors		
J7KN-151 to -176	One unit for 3 terminals, 2 units for one contactor	J74KN-LG-10404
J7KN-210 to -316		J74KN-LG-11457

Marking systems	Specification	Order code
Description		
Marking plate	2-section without marking, divisible	J74KN-P487-1
Marking plate	4-section without marking, divisible	J74KN-P245-1

Insulated wiring systems	Suitable for contactors	Max. current (A)	Order code
Function			
For reversing contactors (2 parts)	J7KN-10D to -22D	22	J74-WKR-B2
	J7KN-24 to -40	40	J74-WKR-C
For star-delta combination (4 parts)	J7KN-10D to -22D	22	J74-WKSD-B2
	J7KN-24 to -40	40	J74-WKSD-C

Specifications

Coil voltages	Suffix to contactor type:						
	24	48	110	180	230	400	500
Contactor type							
J7KN-10D to J7KN-74	yes	yes	yes	yes	yes	yes	yes
J7KN-90 to J7KN-860	yes	yes	yes	-	yes	yes	-



Thermal overload relays for J7KN(A) contactors

J7TKN relays protect motors against thermal overload. They can be mounted on the contactor or separately. The relays comply with IEC 60947 (single-phase sensitivity).

- Series of overload relays covering a setting range from 0.12 A to 800 A (D.O.L.)
- Manual and/or auto reset models available

Ordering information

Applicable contactors	Setting range		Size in mm (H × W × D) (incl. standard J7KN[A] contactor)	Order code
	D.O.L. (A)	Star-delta (A)		
J7KNA-09... , J7KNA-12...	0.12 to 0.18	–	95 × 48.5 × 77	J7TKN-A-E18
	0.18 to 0.27	–		J7TKN-A-E27
	0.27 to 0.4	–		J7TKN-A-E4
	0.4 to 0.6	–		J7TKN-A-E6
	0.6 to 0.9	–		J7TKN-A-E9
	0.8 to 1.2	–		J7TKN-A-1E2
	1.2 to 1.8	–		J7TKN-A-1E8
	1.8 to 2.7	–		J7TKN-A-2E7
	2.7 to 4	–		J7TKN-A-4
	4 to 6	7 to 10.5		J7TKN-A-6
	6 to 9	10.5 to 15.5		J7TKN-A-9
	8 to 11	14 to 19		J7TKN-A-11
	10 to 14	18 to 24		J7TKN-A-14
J7KN-10D... to J7KN-40...	0.12 to 0.18	–	126.5 × 45 × 70 (J7KN-10D to J7KN-22D); 141.5 × 45 × 87.5 (J7KN-24 to J7KN-40)	J7TKN-B-E18
	0.18 to 0.27	–		J7TKN-B-E27
	0.27 to 0.4	–		J7TKN-B-E4
	0.4 to 0.6	–		J7TKN-B-E6
	0.6 to 0.9	–		J7TKN-B-E9
	0.8 to 1.2	–		J7TKN-B-1E2
	1.2 to 1.8	–		J7TKN-B-1E8
	1.8 to 2.7	–		J7TKN-B-2E7
	2.7 to 4	–		J7TKN-B-4
	4 to 6	7 to 10.5		J7TKN-B-6
	6 to 9	10.5 to 15.5		J7TKN-B-9
	8 to 11	14 to 19		J7TKN-B-11
	10 to 14	18 to 24		J7TKN-B-14
	13 to 18	23 to 31		J7TKN-B-18
17 to 24	30 to 41	J7TKN-B-24		
23 to 32	40 to 55	J7TKN-B-32		
J7KN-24... to J7KN-40...	28 to 42	48 to 73	136 × 67 × 96.5	J7TKN-C-42
J7KN-50... to J7KN-74...	40 to 52	70 to 90	180 × 69 × 108	J7TKN-D-52
	52 to 65	90 to 112		J7TKN-D-65
	60 to 74	104 to 128		J7TKN-D-74
J7KN-90... to J7KN-115...	60 to 90	104 to 156	260 × 107 × 120	J7TKN-E-90
	80 to 120	140 to 207		J7TKN-E-120
J7KN-151... to J7KN-176...	120 to 180	208 to 312	290 × 110 × 162	J7TKN-F-180
J7KN-210... to J7KN-316...	144 to 216	250 to 374	362 × 145 × 208	J7TKN-G-216
	216 to 320	374 to 554		J7TKN-G-320
J7KN-450... to J7KN-860...	240 to 360	416 to 623	372 × 1246 × 1225 (J7KN-450)	J7TKN-H-360
	360 to 540	623 to 935	395 × 1246 × 1225 (J7KN-550)	J7TKN-H-540
	540 to 800	935 to 1385	487 × 1280 × 1291 (J7KN-700) 540 × 1280 × 1291 (J7KN-860)	J7TKN-H-800

Accessories

Sets for single mounting

For overload relays	Cable cross-section to clamp (mm ²)			Order code
	Solid or stranded	Flexible	Flexible with multi-core cable	
J7TKN-AB	0.75 to 6	0.75 to 4	0.5 to 4	J74TK-M-AB
J7TKN-B	0.75 to 6	0.75 to 4	0.5 to 4	J74TK-SM

Busbar sets for thermal overload relays

For overload relays	For motor contactors	Order code
J7TKN-H-360/540	J7KN-450/550	J74TK-SU-550
J7TKN-H-540/800	J7KN-700/860	J74TK-SU-860

Specifications

Type	J7TKN-A	J7TKN-B	J7TKN-C	J7TKN-D	J7TKN-E	J7TKN-F	J7TKN-G	J7TKN-H	
Rated insulation voltage U _i	690 VAC				750 VAC	1000 VAC			
Permissible ambient temperature	Operation							-25 to 55°C	
	Storage							-50 to 70°C	
Trip class according to IEC 947-4-1	10 A				20 A	10 A			
Cable cross-section Main connector	Solid or stranded mm ²	0.75 to 6 0.75 to 2.5	0.75 to 6	0.75 to 10	4 to 35	Without terminals, suitable for bushing one connector 70 mm ² (stranded) per phase	Busbar 18×4 Screw M8	Busbar 25×6 Screw M10	See accessories
	Flexible mm ²	0.75 to 4 0.5 to 2.5	1 to 4	0.75 to 6	6 to 25				
	Flexible with multi-core cable end mm ²	0.5 to 2.5 0.5 to 1.5	0.75 to 4	0.75 to 6	4 to 25				
Cables per clamp	Number	1 + 1	2	2	1	-	1	1	1
Auxiliary connector	Solid mm ²	0.75 to 2.5							1 to 2.5
	Flexible mm ²	0.5 to 2.5							1 to 2.5
	Flexible with multi-core cable end mm ²	0.5 to 1.5							1 to 2.5
Cables per clamp	Number	2							
Auxiliary contacts									
Rated insulation voltage U _i	same potential	690 VAC						500 VAC	
	different potential	440 VAC			250 VAC		440 VAC		
Rated operational current I _e Utilization category AC15	24 V	5 A	3 A	4 A	5 A		3 A	4 A	
	230 V	3 A	2 A	2.5 A	2.5 A	3 A	2 A	2.5 A	
	400 V	2 A	1 A	1.5 A	1.5 A	2 A	1 A	1.5 A	
	690 V	0.6 A	0.5 A	0.6 A		0.5 A		0.6 A	
Rated operational current I _e Utilization category DC13	24 V	1.2 A	1 A	1.2 A					
	110 V	0.15 A							
	220 V	0.1 A							
Short circuit protection (without welding 1 kA)	Highest fuse rating gL (gG)	6 A	4 A	6 A			4 A		6 A
Setting range		to 23 A	All	28 to 42 A	52 to 65 A	All	-	-	-
Power loss per current path (max.)	Minimum setting value	1.1 W	1.1 W	1.3 W	2.9 W	1.1 W	-	-	-
	Maximum setting value	2.3 W	2.3 W	3.3 W	4.5 W	2.5 W	-	-	-



J7MN motor protection circuit breakers from 0.10 A to 100 A

J7MN starters protect motors against thermal overload and short circuit. The J7MN can be equipped with additional auxiliary contacts, tripping indicator (alarm), undervoltage release and/or shunt release. All models can be locked for safe maintenance.

- Rated operational currents of 32 A for the rocker type
- Rated operational currents of 32 A, 63 A and 100 A for the rotary types
- Switching capacity is 100 kA/415 V up-to 13 A and 50 kA/415 V up-to 100 A
- Electrical/mechanical link modules available up-to 11 kW motor protection units
- All components are finger proof

Ordering information

Rated current in A	Suitable for motors 3 ~ 400 V kW	Current setting range		Short-circuit breaking capacity at 3 ~ 400 V kA	Size in mm (H × W × D)	Order code
		Thermal overload release A	Instantaneous short-circuit release A			
0.16	–	0.10–0.16	2.1	100	98 × 45 × 75	J7MN-3P-E16
0.25	0.06	0.16–0.25	3.3	100		J7MN-3P-E25
0.4	0.09	0.25–0.4	5.2	100		J7MN-3P-E4
0.63	0.18	0.4–0.63	8.2	100		J7MN-3P-E63
1	0.25	0.63–1	13	100		J7MN-3P-1
1.6	0.55	1–1.6	20.8	100		J7MN-3P-1E6
2.5	0.75	1.6–2.5	32.5	100		J7MN-3P-2E5
4	1.5	2.5–4	52	100		J7MN-3P-4
6	2.2	4–6	78	100		J7MN-3P-6
8	3	5–8	104	100		J7MN-3P-8
10	4	6–10	130	50		J7MN-3P-10
13	5.5	9–13	169	50		J7MN-3P-13
17	7.5	11–17	221	20		J7MN-3P-17
22	7.5	14–22	286	15		J7MN-3P-22
26	11	18–26	338	15		J7MN-3P-26
32	15	22–32	416	15		J7MN-3P-32
0.16	–	0.10–0.16	2.1	100	98 × 45 × 100	J7MN-3R-E16
0.25	0.06	0.16–0.25	3.3	100		J7MN-3R-E25
0.4	0.09	0.25–0.4	5.2	100		J7MN-3R-E4
0.63	0.18	0.4–0.63	8.2	100		J7MN-3R-E63
1	0.25	0.63–1	13	100		J7MN-3R-1
1.6	0.55	1–1.6	20.8	100		J7MN-3R-1E6
2.5	0.75	1.6–2.5	32.5	100		J7MN-3R-2E5
4	1.5	2.5–4	52	100		J7MN-3R-4
6	2.2	4–6	78	100		J7MN-3R-6
8	3	5–8	104	100		J7MN-3R-8
10	4	6–10	130	100		J7MN-3R-10
13	5.5	9–13	169	100		J7MN-3R-13
17	7.5	11–17	221	50		J7MN-3R-17
22	7.5	14–22	286	50		J7MN-3R-22
26	11	18–26	338	50		J7MN-3R-26
32	15	22–32	416	50		J7MN-3R-32
26	12.5	18–26	338	50	140 × 55 × 144	J7MN-6R-26
32	15	22–32	416	50		J7MN-6R-32
40	18.5	28–40	520	50		J7MN-6R-40
50	22	34–50	650	50		J7MN-6R-50
63	30	45–63	819	50	165 × 70 × 171	J7MN-6R-63
63	30	45–63	819	50		J7MN-9R-63
75	37	55–75	975	50		J7MN-9R-75
90	45	70–90	1170	50		J7MN-9R-90
100	–	80–100	1300	50	J7MN-9R-100	

Accessories

Description	Version	For circuit breaker	Order code	
Transverse auxiliary contact block				
Contact block	1 NO + 1 NC	All	J77MN-11F	
	2NO		J77MN-20F	
	2NC		J77MN-02F	
Auxiliary contact block for left hand side mounting (max. 2 pc. per circuit breaker)				
Contact block (9 mm)	1 NO + 1 NC	All	J77MN-11S	
	2NO		J77MN-20S	
	2NC		J77MN-02S	
Signalling switch for left hand side mounting (max. 1 pc. per circuit breaker)				
Signalling switch (18 mm)	1 NO + 1 NC any tripping condition	J7MN-3P/-3R	J77MN-TA-11S	
		J7MN-6R/-9R	J77MN-TB-11S	
	1 NO + 1 NC short circuit tripping condition	All	J77MN-T-11S	
Undervoltage releases for right hand side mounting (max 1 pc. per circuit breaker)				
Trips the circuit breaker when the voltage is interrupted. Prevents the motor from being restarted accidentally when the voltage is restored, suitable for EMERGENCY STOP according to VDE 0113	AC 50 Hz	AC 60 Hz	All	
	24 V	28 V		J77MN-U-24
	110–127 V	120 V		J77MN-U-110
	220–230 V	240–260 V		J77MN-U-230
	240 V	277 V		J77MN-U-240
	380–400 V	440–460 V		J77MN-U-400
	415–440 V	460–480 V		J77MN-U-415
Shunt releases for right hand side mounting (max 1 pc. per circuit breaker)				
Trips the circuit breaker when the release coil is energized	AC 50 Hz	AC 60 Hz	All	
	24 V	28 V		J77MN-S-24
	110–127 V	120 V		J77MN-S-110
	220–230 V	240–260 V		J77MN-S-230
	240 V	277 V		J77MN-S-240
	380–400 V	440–460 V		J77MN-S-400
	415–440 V	460–480 V		J77MN-S-415
Terminal block				
Terminal block	Up to 600 V according to UL 489 not for transverse auxiliary contact block	J7MN-3R	J77MN-TB32	
		J7MN-9R	J77MN-TB100	

Insulated 3-Phase Busbar System IP20

Description	Connection type	Version	For Units (MPCB)	Order code
3-phase busbars; modular spacing = 45 mm	Spade	for 2 units	J7MN-3P; J7MN-3R	J77MN-CPM-3-45-2S
		for 3 units		J77MN-CPM-3-45-3S
		for 4 units		J77MN-CPM-3-45-4S
		for 5 units		J77MN-CPM-3-45-5S
Line side terminal 3-pole, connection from above; conductor cross-section solid or stranded 6–25 mm ² with end sleeve 4–16 mm ²	Spade	acc. IEC/EN 60947-1, 60947-2, 60947-4-1 and VDE 0660	J7MN-3P; J7MN-3R	J77MN-BTC-63-SE
Line side terminal 3-pole, connection from above; conductor cross-section solid or stranded 6–25 mm ² with end sleeve 4–16 mm ²	Spade	up to 600 V acc. UL 489	J7MN-3P; J7MN-3R	J77MN-BTC-63-SEV
Shrouds for unused terminals on busbar system	Spade		J7MN-3P; J7MN-3R	J77MN-TA-63S

Specifications

Type		J7MN-3P	J7MN-3R	J7MN-6R	J7MN-9R
Number of poles		3	3	3	3
Max. rated current I_{nmax} (= max. rated operational current I_e)	A	32	32	63	100
Permissible ambient temperature	Storage/transport	-50 to 80°C			
	Operation	-20 to 60°C			
Rated operational voltage U_e	V	690			
Rated frequency	Hz	50/60			
Rated insulation voltage U_i	V	690			
Rated impulse withstand voltage U_{imp}	kV	6			
Utilization category	IEC 60 947-2 (circuit breaker)	A			
	IEC 60 947-4-1 (motor starter)	AC-3			
Class	According to IEC 60 947-4-1	10			
Degree of protection	According to IEC 60 529	IP20	IP20	IP20	IP20
Phase failure sensitivity	According to IEC 60 947-4-1	Yes			
Explosion protection	According to EC Directive 94/19/EC	Yes			
Isolator characteristics	According to IEC 60 947-3	Yes			
Main and EM. STOP switch characteristics	According to IEC 60 204-1 (VDE113)	Yes			
Safe isolation between main and auxiliary circuits According to DIN VDE 0106 Part 101	Up to 400 V + 10%	Yes			
	Up to 415 V + 5%	Yes			
Mechanical endurance	Operating cycles	100,000	100,000	50,000	50,000
Electrical endurance		100,000	100,000	25,000	25,000
Max. operating frequency per hour (motor starts)	1/h	25	25	25	25

Monitoring products

THE COMPLETE MONITORING RANGE

K8 series – The smart way to protect your system

The K8 series offers you a flexible and complete one-stop shopping solution!
This monitoring range can be split into models for single-phase current and single-phase voltage, three-phase voltage, conductive level and a temperature alarm unit.

- 1-phase: full-span of range setting, all models with timer function
- 3-phase: wide range of global voltage settings
- Temperature monitoring relay: wide temperature range with precision increased
- Easy-to-set parameters

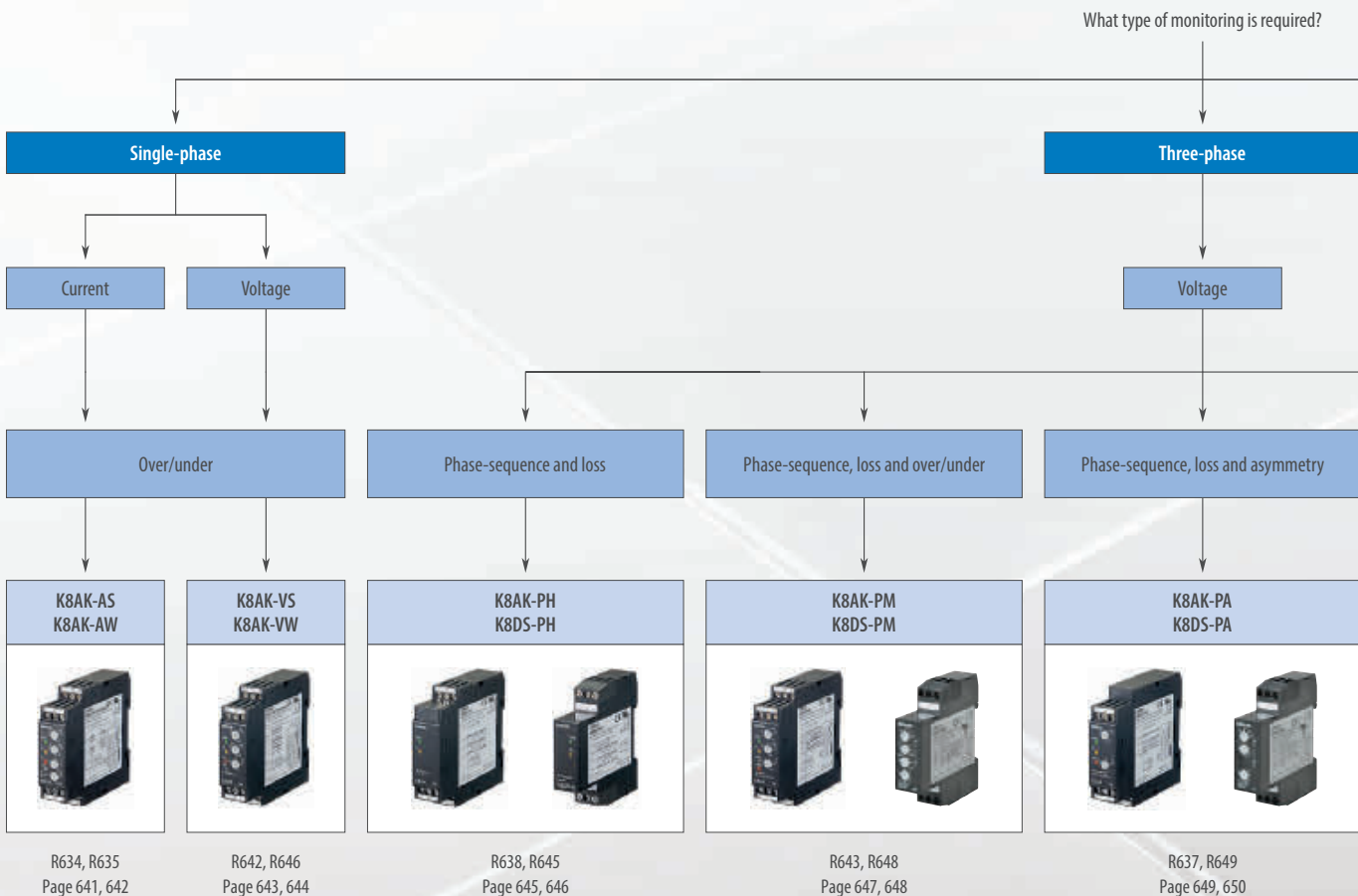

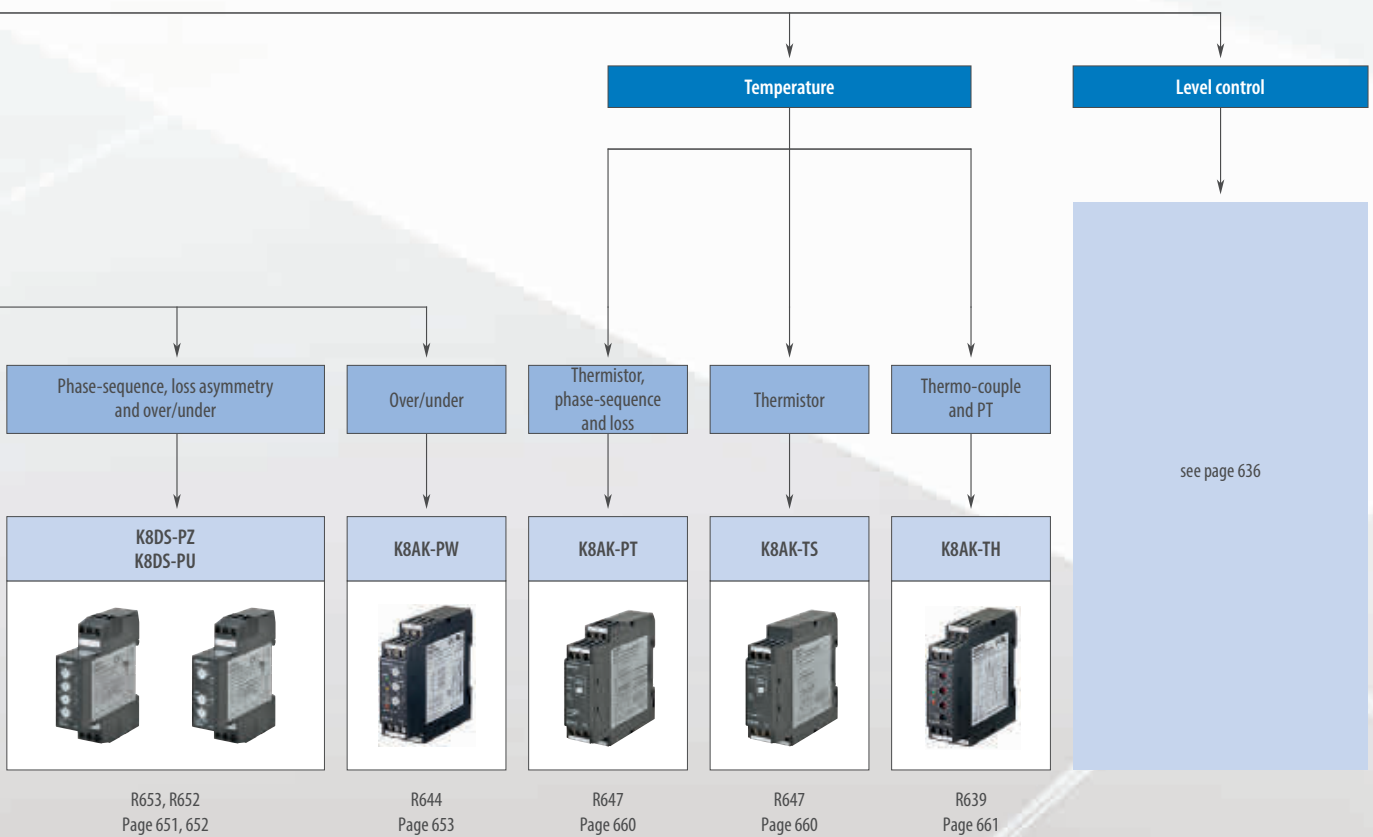



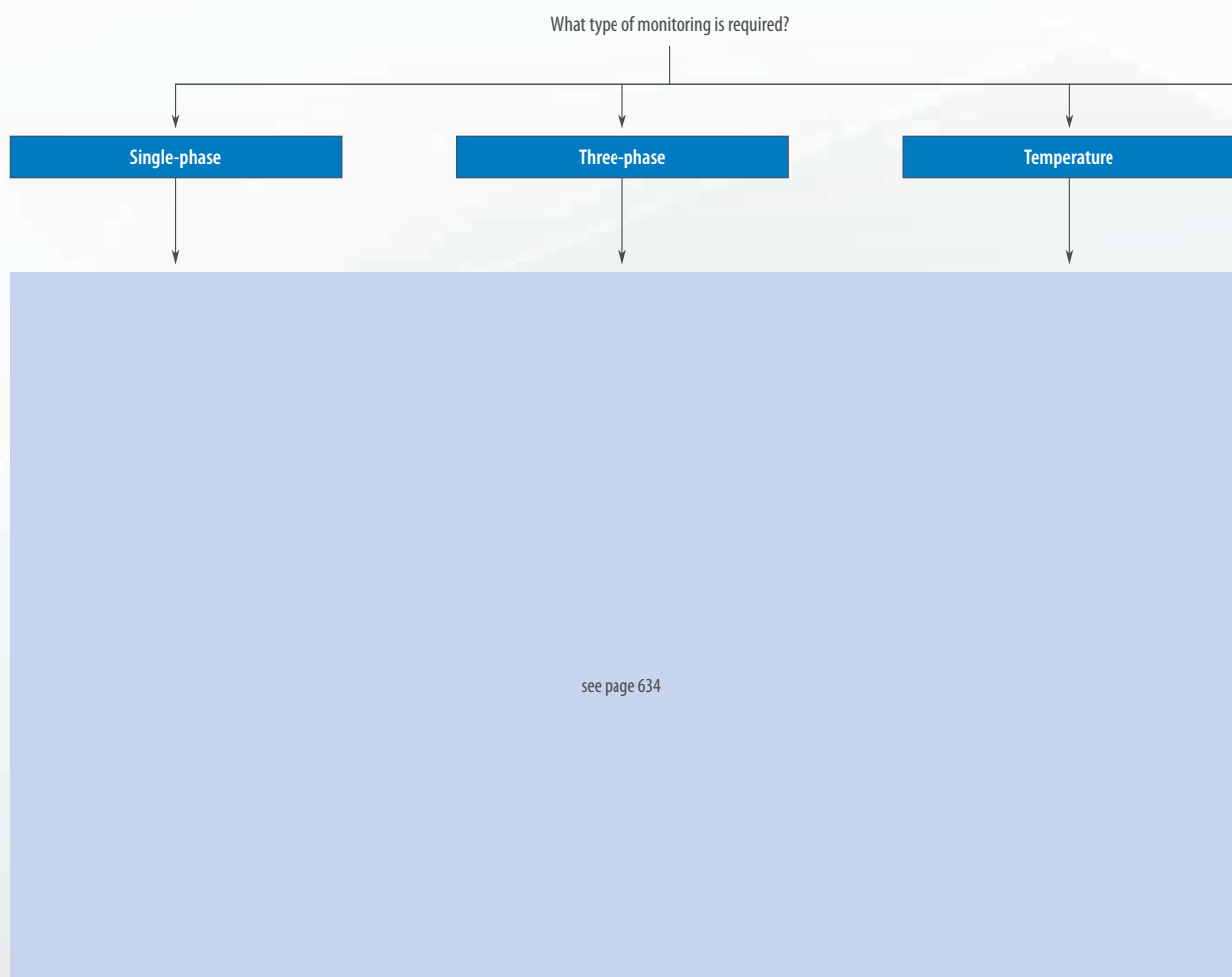

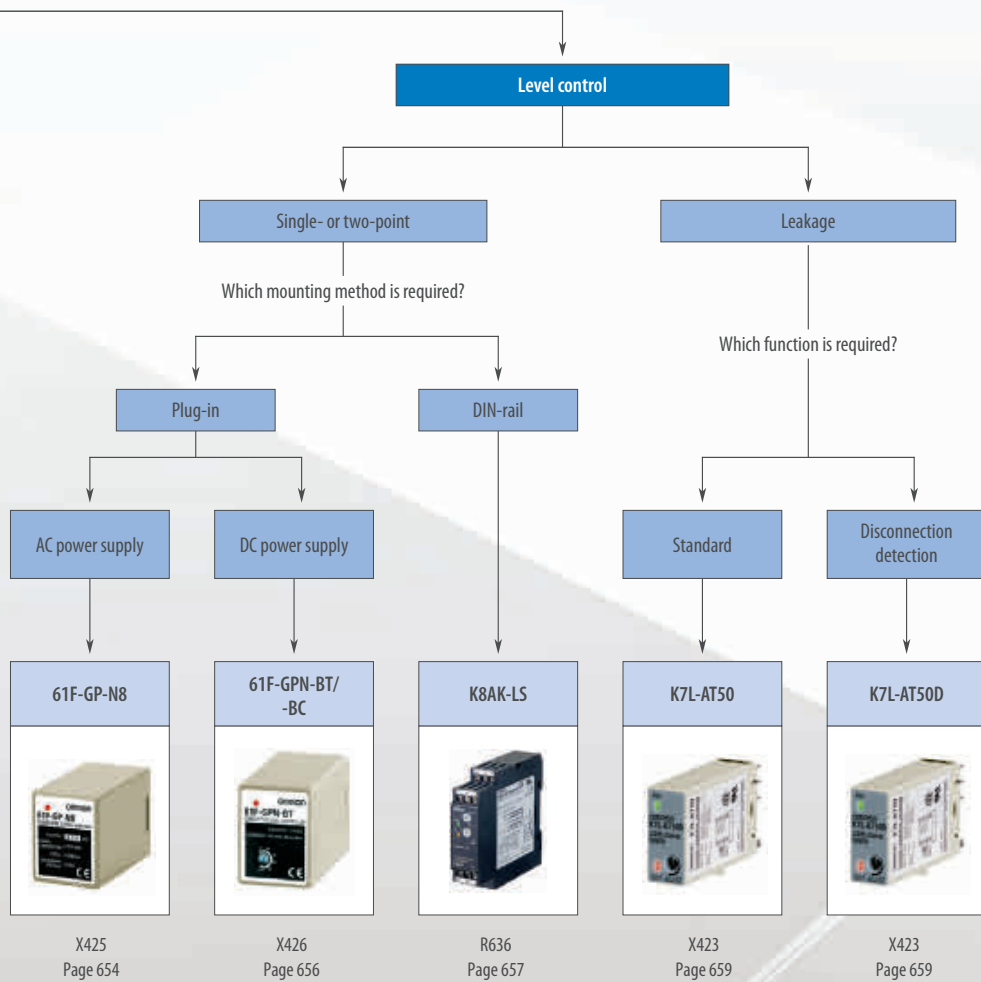







Monitoring products









Selection table

Category		1-phase current		1-phase voltage		3-phase voltage phase-sequence/phase-loss		3-phase voltage phase-sequence/phase-loss over/under	
									
Model		K8AK-AS	K8AK-AW	K8AK-VS	K8AK-VW	K8AK-PH	K8DS-PH	K8AK-PM	K8DS-PM
Selection criteria	Specialty	Ideal for current monitoring for industrial heaters and motors.		Ideal for voltage monitoring for industrial facilities and equipment.		Ideal for phase-sequence and phase-loss monitoring for industrial facilities and equipment.		Ideal for monitoring 3-phase power supplies for industrial facilities and equipment.	
	Sensing range (configurable)	20 mA to 8 A, 100 or 200 A with current transformer		1 to 600 V		Same as supply voltage			
Supply voltage AC	24 VAC	■	■	■	■	-	-	-	-
	100 VAC	-	-	-	-	-	-	-	-
	110 VAC	-	-	-	-	-	-	-	-
	115 VAC	-	-	-	-	-	-	-	-
	120 VAC	-	-	-	-	-	-	-	-
	200 VAC	-	-	-	-	-	-	-	-
	220 VAC	-	-	-	-	-	-	-	-
	230 VAC	-	-	-	-	-	-	-	-
	240 VAC	-	-	-	-	-	-	-	-
	100 to 240 VAC	■	■	■	■	-	-	-	-
	200 to 480 VAC	-	-	-	-	■	■	-	-
	200 to 240 VAC	-	-	-	-	-	-	■ (-PM1, 3-wire)	■
	115 to 138 VAC	-	-	-	-	-	-	■ (-PM1, 4-wire)	-
	380 to 480 VAC	-	-	-	-	-	-	■ (-PM2, 3-wire)	■
220 to 277 VAC	-	-	-	-	-	-	■ (-PM2, 4-wire)	-	
Supply voltage DC	24 VDC	■	■	■	■	-	-	-	-
	12 to 24 VDC	-	-	-	-	-	-	-	-
Control output	Transistor NPN	-	-	-	-	-	-	-	-
	Transistor PNP	-	-	-	-	-	-	-	-
	Relay	■ (1 SPDT)	■ (2 SPDT)	■ (1 SPDT)	■ (2 SPDT)	■ (1 DPDT)	■ (1 SPDT)	■ (2 SPDT)	■ (1 SPDT)
Features	LED operation indicator	■	■	■	■	■	■	■	■
	Adjustable sensitivity	-	-	-	-	-	-	-	-
	Electrode types	-	-	-	-	-	-	-	-
	Page/Quick Link	641	642	643	644	645	646	647	648

3-phase voltage phase-sequence, loss and asymmetry		3-phase voltage phase-sequence, loss, asymmetry and over/under		3-phase voltage over/under	Temperature thermistor, phase-sequence and loss	Temperature thermistor	Temperature thermo-couple and PT
							
K8AK-PA	K8DS-PA	K8DS-PZ	K8DS-PU	K8AK-PW	K8AK-PT	K8AK-TS	K8AK-TH
Ideal for 3-phase voltage asymmetry monitoring for industrial facilities and equipment.		Ideal for monitoring 3-phase power supplies for industrial facilities and equipment		Ideal for monitoring 3-phase power supplies for industrial facilities and equipment.	Monitor temperature rise through internal motor		Compact and slim relay ideal for temperature alarms and monitoring
Same as supply voltage					100 to 240 VAC 24 VAC/DC		100 to 240 VAC 24 VAC/DC
-	-	-	-	-	■	■	■
-	-	-	-	-	-	-	-
-	-	-	-	-	-	-	-
-	-	-	-	-	-	-	-
-	-	-	-	-	-	-	-
-	-	-	-	-	-	-	-
-	-	-	-	-	-	-	-
-	-	-	-	-	-	-	-
-	-	-	-	-	■	■	■
-	-	-	-	-	-	-	-
■ (-PA1, 3-wire)	■	■	■	■ (-PW1, 3-wire)	-	-	-
■ (-PA1, 4-wire)	-	-	-	■ (-PW1, 4-wire)	-	-	-
■ (-PA2, 3-wire)	■	■	■	■ (-PW2, 3-wire)	-	-	-
■ (-PA2, 4-wire)	-	-	-	■ (-PW2, 4-wire)	-	-	-
-	-	-	-	-	■	■	■
-	-	-	-	-	-	-	-
-	-	-	-	-	-	-	-
-	-	-	-	-	-	-	-
■ (1 SPDT)	■ (1 SPDT)	■ (1 SPDT)	■ (1 SPDT)	■ (2 SPDT)	■ (1 SPDT)	■ (1 SPDT)	■ (1 SPDT)
■	■	■	■	■	■	■	■
-	-	-	-	-	-	-	-
-	-	-	-	-	-	-	-
649	650	651	652	653	660	660	661

■ Standard □ Available - No/not available

Conductive level controller				Liquid leakage sensor amplifier	
					
61F-GP-N8	61F-GPN-BT	61F-GPN-BC	K8AK-LS	K7L-AT50	K7L-AT50D
Single or two-point	AC sine wave between electrodes for stable detection with no electrolysis	AC sine wave between electrodes for stable detection with no electrolysis	Ideal for level control for industrial facilities and equipment	Sensor amplifier, AC sine wave between electrodes for stable detection with no electrolysis	Sensor amplifier with disconnection detection function
4 to 50 kΩ	0 to 100 kΩ	1 to 100 kΩ	10 to 100 kΩ	0 to 50 MΩ	1 to 50 MΩ
<input type="checkbox"/>	-	-	<input type="checkbox"/>	-	-
<input type="checkbox"/>	-	-	-	-	-
<input type="checkbox"/>	-	-	-	-	-
-	-	-	-	-	-
<input type="checkbox"/>	-	-	-	-	-
<input type="checkbox"/>	-	-	-	-	-
<input type="checkbox"/>	-	-	-	-	-
<input type="checkbox"/>	-	-	-	-	-
-	-	-	■	-	-
-	■	■	<input type="checkbox"/>	-	-
-	-	-	-	<input type="checkbox"/>	<input type="checkbox"/>
-	-	■	-	■	■
-	-	-	-	■	■
■	■	■	■ (1 SPDT)	-	-
■	■	■	■	■	■
-	■	■	-	■	■
Electrode holder: PS- _S , PS-31, BF-1 and BS-1			-	Liquid leakage sensor band F03-16PE	
654	656		657	659	

■ Standard □ Available - No/not available



Single-phase current relay

These single-phase current relays monitor over- and undercurrents. Manual resetting and automatic resetting are supported by one relay. The start-up lock and operating time can be set separately. The relay warning status is easily monitored with the LED indicator.

- Single-phase current relay
- In 22.5 mm wide industrial housing
- Under or over control
- Supply voltages: 24 VAC/DC, 100 to 240 VAC
- Easy wiring with ferrules

Ordering information

Measuring current	Supply voltage	Order code
2 to 20 mA AC/DC, 10 to 100 mA AC/DC, 50 to 500 mA AC/DC	24 VAC/DC	K8AK-AS1 24 VAC/DC
	100 to 240 VAC	K8AK-AS1 100-240 VAC
0.1 to 1 A AC/DC, 0.5 to 5 A AC/DC, 0.8 to 8 A AC/DC	24 VAC/DC	K8AK-AS2 24 VAC/DC
	100 to 240 VAC	K8AK-AS2 100-240 VAC
10 to 100 A AC, 20 to 200 A AC	24 VAC/DC	K8AK-AS3 24 VAC/DC
	100 to 240 VAC	K8AK-AS3 100-240 VAC

Accessories

Current transformer	Input range	Applicable relay	Order code
	10 to 100 A AC, 20 to 200 A AC	K8AK-AS3	K8AC-CT200L

Note: The K8AK-AS3 is designed to be used in combination with the K8AC-CT200L (direct input not possible)

Specifications

Ambient operating temperature		-20 to 60°C (with no condensation or icing)
Storage temperature		-25 to 65°C (with no condensation or icing)
Operating voltage range		85% to 110% of rated operating voltage
Rated power supply frequency		50/60 Hz±5 Hz (AC power supply)
Output relays (1 × SPDT, normally closed operation)	Resistive load	5 A at 250 VAC or at 30 VDC
	Maximum contact voltage	250 VAC or 30 VDC
	Maximum contact current	5 A
	Maximum switching capacity	1,250 VA, 150 W
Mechanical life		10,000,000 operations
Electrical life		50,000 operations at 5 A, 250 VAC or 30 VDC
Degree of protection		Terminal section: IP20
Case material		PC and ABS
Weight		Approx. 150 g
Operating power	Isolated power supply	2.0 VA/1.1 W max. at 24 VAC/DC, 4.6 VA max. at 100 to 240 VAC
Operate (SV)	Operating value setting range	10% to 100% of maximum measuring current
	Operating value	100% operation at set value
Reset (HYS.)	Hysteresis	5% to 50% of operating value
	Resetting method	Manual reset/automatic reset (switchable) Manual reset: Turn OFF operating power for 1 s or longer
Operating time (T)		0.1 to 30 s
Operating power ON lock (LOCK)		0 to 30 s (The startup lock timer starts when the input has reached approximately 30% or more of the set value.) Note: Enabled only for overcurrent operation
Repeat error	Operating value	±0.5% full scale (at 25°C and 65% humidity, rated power supply voltage, DC or 50/60 Hz sine wave input)
	Operating time	±50 ms (at 25°C and 65% humidity, rated power supply voltage)
Input frequency range	K8AK-AS1/-AS2	DC input or AC input (45 to 65 Hz)
	K8AK-AS3	AC input (45 to 65 Hz)
Overload capacity	K8AK-AS1/-AS2	Continuous input at 120% of maximum input, 1 s at 150%
	K8AK-AS3	Continuous input at 120%, 30 s at 200%, and 1 s at 600% with an OMRON CT (K8AC-CT200L)
Indicators		Power (PWR): Green LED, relay output (RY): Yellow LED, alarm outputs (ALM): Red LED
Applicable standards	Conforming standards	EN 60947-5-1 Installation environment (pollution level 2, installation category III)
	EMC	EN 60947-5-1
	Safety standards	UL 508 (Recognition), Korean Radio Waves Act (Act 10564), CSA and CCC
Size in mm (H × W × D)		90 × 22.5 × 100



Single-phase current relay, window type

These single-phase current relays monitor over- and undercurrents. Manual resetting and automatic resetting are supported by one relay. The start-up lock and operating time can be set separately. The relay warning status is easily monitored with the LED indicator.

- Single-phase current window relay
- In 22.5 mm wide industrial housing
- Under and over control
- Supply voltages: 24 VAC/DC, 100 to 240 VAC
- Easy wiring with ferrules

Ordering information

Measuring current	Supply voltage	Order code
2 to 20 mA AC/DC, 10 to 100 mA AC/DC, 50 to 500 mA AC/DC	24 VAC/DC	K8AK-AW1 24 VAC/DC
	100 to 240 VAC	K8AK-AW1 100-240 VAC
0.1 to 1 A AC/DC, 0.5 to 5 A AC/DC	24 VAC/DC	K8AK-AW2 24 VAC/DC
	100 to 240 VAC	K8AK-AW2 100-240 VAC
10 to 100 A AC, 20 to 200 A AC	24 VAC/DC	K8AK-AW3 24 VAC/DC
	100 to 240 VAC	K8AK-AW3 100-240 VAC

Accessories

Current transformer	Input range	Applicable relay	Order code
	10 to 100 A AC, 20 to 200 A AC	K8AK-AW3	K8AC-CT200L

Note: The K8AK-AW3 is designed to be used in combination with the K8AC-CT200L (direct input not possible)

Specifications

Ambient operating temperature		-20 to 60°C (with no condensation or icing)
Storage temperature		-25 to 65°C (with no condensation or icing)
Operating voltage range		85% to 110% of rated operating voltage
Rated power supply frequency		50/60 Hz±5 Hz (AC power supply)
Output relays (1 × SPDT, normally closed operation)	Resistive load	5 A at 250 VAC or at 30 VDC
	Maximum contact voltage	250 VAC or 30 VDC
	Maximum contact current	5 A
	Maximum switching capacity	1,250 VA, 150 W
Mechanical life		10,000,000 operations
Electrical life		50,000 operations at 5 A, 250 VAC or 30 VDC
Degree of protection		Terminal section: IP20
Case material		PC and ABS
Weight		Approx. 150 g
Operating power	Isolated power supply	2.0 VA/1.1 W max. at 24 VAC/DC, 4.6 VA max. at 100 to 240 VAC
Operate (SV)	Operating value setting range	10% to 100% of maximum measuring current
	Operating value	100% operation at set value
Reset (HYS.)	Hysteresis	5% of operating value (fixed)
	Resetting method	Manual reset/automatic reset (switchable) Manual reset: Turn OFF operating power for 1 s or longer
Operating time (T)		0.1 to 30 s
Operating power ON lock (LOCK)		0 to 30 s (The startup lock timer starts when the input has reached approximately 30% or more of the set value.) Note: Enabled only for overcurrent operation
Repeat error	Operating value	±0.5% full scale (at 25°C and 65% humidity, rated power supply voltage, DC or 50/60 Hz sine wave input)
	Operating time	±50 ms (at 25°C and 65% humidity, rated power supply voltage)
Input frequency range	K8AK-AW1/-AW2	DC input or AC input (45 to 65 Hz)
	K8AK-AW3	AC input (45 to 65 Hz)
Overload capacity	K8AK-AW1/-AW2	Continuous input at 120% of maximum input, 1 s at 150%
	K8AK-AW3	Continuous input at 120%, 30 s at 200%, and 1 s at 600% with an OMRON CT (K8AC-CT200L)
Indicators		Power (PWR): Green LED, relay output (RY): Yellow LED, alarm outputs (ALM): Red LED
Applicable standards	Conforming standards	EN 60947-5-1 Installation environment (pollution level 2, installation category III)
	EMC	EN 60947-5-1
	Safety standards	UL 508 (Recognition), Korean Radio Waves Act (Act 10564), CSA and CCC
Size in mm (H × W × D)		90 × 22.5 × 100



Single-phase voltage relay

These single-phase voltage relays are for monitoring over- and undervoltages. Manual resetting and automatic resetting are supported by one relay. Relay warning status can easily be monitored using the LED indicator.

- Single-phase voltage relay
- In 22.5 mm wide industrial housing
- Under or over control
- Supply voltages: 24 VAC/DC, 100 to 240 VAC
- Easy wiring with ferrules

Ordering information

Measuring current	Supply voltage	Order code
1 to 10 VAC/DC, 3 to 30 VAC/DC, 15 to 150 VAC/DC	24 VAC/DC	K8AK-VS2 24 VAC/DC
	100 to 240 VAC	K8AK-VS2 100-240 VAC
20 to 200 VAC/DC, 30 to 300 VAC/DC, 60 to 600 VAC/DC	24 VAC/DC	K8AK-VS3 24 VAC/DC
	100 to 240 VAC	K8AK-VS3 100-240 VAC

Specifications

Ambient operating temperature		-20 to 60°C (with no condensation or icing)
Storage temperature		-25 to 65°C (with no condensation or icing)
Operating voltage range		85% to 110% of rated operating voltage
Rated power supply frequency		50/60 Hz±5 Hz (AC power supply)
Output relays (1 × SPDT, normally closed operation)	Resistive load	5 A at 250 VAC or at 30 VDC
	Maximum contact voltage	250 VAC or 30 VDC
	Maximum contact current	5 A
	Maximum switching capacity	1,250 VA, 150 W
	Mechanical life	10,000,000 operations
	Electrical life	50,000 operations at 5 A, 250 VAC or 30 VDC
Degree of protection		Terminal section: IP20
Case material		PC and ABS
Weight		Approx. 150 g
Operating power	Isolated power supply	2.0 VA/1.1 W max. at 24 VAC/DC, 4.6 VA max. at 100 to 240 VA
Operate (SV)	Operating value setting range	10% to 100% of maximum measuring voltage
	Operating value	100% operation at set value
Reset (HYS.)	Hysteresis	5% to 50% of operating value
	Resetting method	Manual reset/automatic reset (switchable) Manual reset: Turn OFF operating power for 1 s or longer
Operating time (T)		0.1 to 30 s
Power ON lock (LOCK)		1 s or 5 s (Switched using DIP switch) (value when input rapidly changes from 0 to 100%. The operating time is the shortest at this point)
Repeat accuracy	Operating value	±0.5% full scale (at 25°C and 65% humidity, rated power supply voltage, DC or 50/60 Hz sine wave input)
	Operating time	±50 ms (at 25°C and 65% humidity, rated power supply voltage)
Input frequency		40 to 500 Hz
Overload capacity		Continuous input at 115% of maximum input, 10 s at 125% (up to 600 VAC)
Indicators		LED power (PWR): Green LED, relay output (RY): Yellow LED, alarm output (ALM): Red LED
Applicable standards	Conforming standards	EN 60947-5-1 Installation environment (pollution level 2, installation category III)
	EMC	EN 60947-5-1
	Safety standards	UL 508 (Recognition), Korean Radio Waves Act (Act 10564), CSA and CCC
Size in mm (H × W × D)		90 × 22.5 × 100



Single-phase voltage relay, window type

For monitoring over- and undervoltages simultaneously. Manual resetting and automatic resetting are supported by one relay. Separate settings and outputs are supported for over- and undervoltages. Relay warning status can easily be monitored with the LED indicator.

- Single-phase voltage window relay
- In 22.5 mm wide industrial housing
- Under and over, low/low or high/high control
- Supply voltages: 24 VAC/DC, 100 to 240 VAC
- Easy wiring with ferrules

Ordering information

Measuring current	Supply voltage	Order code
1 to 10 VAC/DC, 3 to 30 VAC/DC, 15 to 150 VAC/DC	24 VAC/DC	K8AK-VW2 24 VAC/DC
	100 to 240 VAC	K8AK-VW2 100-240 VAC
20 to 200 VAC/DC, 30 to 300 VAC/DC, 60 to 600 VAC/DC	24 V AC/DC	K8AK-VW3 24 VAC/DC
	100 to 240 VAC	K8AK-VW3 100-240 VAC

Specifications

Ambient operating temperature		-20 to 60°C (with no condensation or icing)
Storage temperature		-25 to 65°C (with no condensation or icing)
Operating voltage range		85% to 110% of rated operating voltage
Rated power supply frequency		50/60 Hz±5 Hz (AC power supply)
Output relays (2 × SPDT, normally closed operation)	Resistive load	5 A at 250 VAC or at 30 VDC
	Maximum contact voltage	250 VAC or 30 VDC
	Maximum contact current	5 A
	Maximum switching capacity	1,250 VA, 150 W
	Mechanical life	10,000,000 operations
	Electrical life	50,000 operations at 5 A, 250 VAC or 30 VDC
Degree of protection		Terminal section: IP20
Case material		PC and ABS
Weight		Approx. 150 g
Operating power	Isolated power supply	2.0 VA/1.1 W max. at 24 VAC/DC, 4.6 VA max. at 100 to 240 VAC
Operation (AL1 and AL2)	Operating value setting range	10% to 100% of maximum measuring voltage
	Operating value	100% operation at set value
Reset (HYS.)	Hysteresis	5% of operating value (fixed)
	Resetting method	Manual reset/automatic reset (switchable) Manual reset: Turn OFF operating power for 1 s or longer
Operating time (T)		0.1 to 30 s
Power ON lock (LOCK)		1 s or 5 s (Switched using DIP switch)
Indicators		Power (PWR): Green LED, relay output (RY): Yellow LED, alarm outputs (ALM 1/2): Red LED
Repeat accuracy	Operating value	±0.5% full scale (at 25°C and 65% humidity, rated power supply voltage, DC or 50/60 Hz sine wave input)
	Operating time	±50 ms (at 25°C and 65% humidity, rated power supply voltage)
Input frequency		40 to 500 Hz
Overload capacity		Continuous input at 115% of maximum input, 10 s at 125% (up to 600 VAC)
Applicable standards	Conforming standards	EN 60947-5-1 Installation environment (pollution level 2, installation category III)
	EMC	EN 60947-5-1
	Safety standards	UL 508 (Recognition), Korean Radio Waves Act (Act 10564), CSA and CCC
Size in mm (H × W × D)		90 × 22.5 × 100



3-phase sequence, phase loss relay

The K8AK-PH1 monitoring relay is designed to monitor 3-phase 3-wire supplies. It simultaneously monitors phase sequence and phase loss during start up as well as phase loss during operation. The output relay releases when alarm conditions are detected, and the warning status can easily be monitored using the LED indicator. Suitable for industrial facilities and equipment.

- Monitors phase sequence and phase-loss simultaneously
- Measuring range: 200 to 480 VAC
- Power supply voltage is the same as measuring voltage
- Operation reaction time: 0.1 s maximum

Ordering information

Rated input voltage	Order code
200 to 480 VAC	K8AK-PH1

Specifications

Ambient operating temperature		-20 to 60°C (with no condensation or icing)
Storage temperature		-25 to 65°C (with no condensation or icing)
Altitude		2,000 m max.
Input frequency		50/60 Hz (AC power supply)
Output relays (1 × DPDT, normally closed operation)	Resistive load	5 A at 250 VAC or at 30 VDC
	Maximum contact voltage	250 VAC or 30 VDC
	Maximum contact current	5 A
	Maximum switching capacity	1,250 VA, 150W
	Mechanical life	10,000,000 operations
Electrical life		50,000 operations at 5 A, 250 VAC or 30 VDC
Degree of protection		Terminal section: IP20
Case material		PC and ABS
Weight		Approx. 130 g
Rated input voltage		Three-phase, three-wire mode, 200 to 480 VAC
Reversed phase and phase loss operating time		0.1 s max.
Resetting method		Automatic reset
Overload capacity		Continuous input: 528 VAC
Indicators		Power (PWR): Green LED, relay output (RY): Yellow LED
Applicable standards	Conforming standards	EN 60947-5-1 Installation environment (pollution level 2, installation category III)
	EMC	EN 60947-5-1
	Safety standards	UL 508 (Recognition), Korean Radio Waves Act (Act 10564), CSA and CCC
Size in mm (H × W × D)		90 × 22.5 × 100



3-phase voltage, phase-sequence/phase loss relay

The K8DS-PH1 is a monitoring relay designed at 17.5 mm slim by simplified functions for 3-phase 3 wire supplies. It simultaneously monitors phase sequence and phase loss during start up as well as phase loss during operation. The output relay releases when alarm conditions are detected, and the warning status can easily be monitored using the LED indicator.

- Monitors phase sequence and phase-loss simultaneously
- Measuring range: 200 to 480 VAC
- Power supply voltage is the same as measuring voltage
- Operation reaction time: 0.1 s maximum

Ordering information

Rated input voltage	Order code
200 to 480 VAC	K8DS-PH1

Specifications

Ambient operating temperature	-20 to 60°C (with no condensation or icing)	
Storage temperature	-25 to 65°C (with no condensation or icing)	
Altitude	2,000 m max.	
Input frequency	50/60 Hz (AC power supply)	
Output relays (1 × SPDT, normally closed operation)	Resistive load	5 A at 250 VAC or at 30 VDC
	Maximum contact voltage	250 VAC or 30 VDC
	Maximum contact current	5 A
	Maximum switching capacity	1,250 VA, 150 W
	Mechanical life	10,000,000 operations
	Electrical life	50,000 operations at 5 A, 250 VAC or 30 VDC
Degree of protection	Terminal section: IP20	
Case material	PC UL 94 V-0	
Weight	Approx. 60 g	
Rated input voltage	Three-phase, three-wire mode, 200 to 480 VAC	
Reversed phase and phase loss operating time	0.1 s max.	
Resetting method	Automatic reset	
Overload capacity	Continuous input: 500 VAC	
Indicators	Power (PWR): Green LED, relay output (RY): Yellow LED	
Applicable standards	Conforming standards	EN 60947-5-1 Installation environment (pollution level 2, installation category III)
	EMC	EN 60947-5-1
	Safety standards	UL 508 (Recognition), Korean Radio Waves Act (Act 10564), CSA and CCC
Size (H × W × D)	80 × 17.5 × 74 mm	



3-phase voltage, phase sequence, phase loss relay

K8AK-PM monitors overvoltages, undervoltages, phase sequence and phase loss for 3-phase, 3-wire or 4-wire power supplies, in one unit. This relay features a switch setting for 3-phase, 3-wire or 3-phase, 4-wire power supply.

- Worldwide power specifications supported by one unit
- Phase sequence, phase loss: Operation reaction time 0.1 s maximum
- Overvoltages or undervoltages: Operation time setting from 0.1 to 30 s
- Relay warning status can easily be monitored using the LED indicator
- Easy wiring with ferrules

Ordering information

Rated input		Order code
3-phase 3-wire mode	200, 220, 230, 240 VAC	K8AK-PM1
3-phase 4-wire mode	115, 127, 133, 138 VAC	
3-phase 3-wire mode	380, 400, 415, 480 VAC	K8AK-PM2
3-phase 4-wire mode	220, 230, 240, 277 VAC	

Specifications

Ambient operating temperature		-20 to 60°C (with no condensation or icing)
Storage temperature		-25 to 65°C (with no condensation or icing)
Input frequency		50/60 Hz (AC power supply)
Output relays (2 × SPDT, normally closed operation)	Resistive load	5 A at 250 VAC or at 30 VDC
	Maximum contact voltage	250 VAC or 30 VDC
	Maximum contact current	5 A
	Maximum switching capacity	1,250 VA, 150 W
	Mechanical life	10,000,000 operations
	Electrical life	50,000 operations at 5 A, 250 VAC or 30 VDC
Degree of protection		Terminal section: IP20
Case material		PC and ABS
Weight		Approx. 150 g
Rated input voltage	K8AK-PM1	3-phase, 3-wire mode: 200, 220, 230, 240 VAC, 3-phase, 4-wire mode: 115, 127, 133, 138 VAC
	K8AK-PM2	3-phase, 3-wire mode: 380, 400, 415, 480 VAC, 3-phase, 4-wire mode: 220, 230, 240, 277 VAC
Operation (overvoltage or undervoltage)	Operating value setting range	Overvoltage = -30% to 25% of maximum rated input voltage ^{*1} Undervoltage = -30% to 25% of maximum rated input voltage ^{*1}
	Operating value	100% operation at set value
Reset (HYS.)	Hysteresis	5% of operating value (fixed)
	Resetting method	Automatic reset
	Operating time (T)	Overvoltage/undervoltage: 0.1 to 30 s Phase-sequence, phase-loss: 0.1 s max.
Power ON lock (LOCK)		1 s or 5 s (Changed with the DIP switch)
Overload capacity		Continuous input at 115% of maximum input, 10 s at 125% (up to 600 VAC)
Repeat accuracy	Operating value	±0.5% full scale (at 25°C and an ambient humidity of 65% at the rated power supply voltage, DC or 50/60 Hz sine wave input)
	Operating time	±50 ms (at 25°C and 65% humidity, rated power supply voltage)
Indicators		Power (PWR): Green LED, relay output (RY): Yellow LED, alarm outputs (ALM 1/2): Red LED
Applicable standards	Conforming standards	EN 60947-5-1 Installation environment (pollution level 2, installation category III)
	EMC	EN 60947-5-1
	Safety standards	UL 508 (Recognition), Korean Radio Waves Act (Act 10564), CSA and CCC
Size in mm (H × W × D)		90 × 22.5 × 100

^{*1} The rated input voltage is switched with a switch



3-Phase voltage, phase sequence, phase-loss and over-/undervoltage relay

The K8DS-PM is the simplified 3-phase monitoring relay, 3-wire circuits with one unit. It can monitor undervoltages, overvoltages, phase sequence and phase-loss.

- Greater resistance to inverter noise
- One SPDT output relay, 5 A at 250 VAC (resistive load)
- World-wide power specifications supported by one unit (Set with a rotary switch)
- Relay status can be monitored using LED indicator

Ordering information

Rated input		Order code
3-phase 3-wire mode	200, 220, 230, 240 VAC	K8DS-PM1
3-phase 3-wire mode	380, 400, 415, 480 VAC	K8DS-PM2

Specifications

Ambient operating temperature		-20 to 60°C (with no condensation or icing)
Storage temperature		-25 to 65°C (with no condensation or icing)
Input frequency		50/60 Hz (AC power supply)
Output relays (1 × SPDT, normally closed operation)	Resistive load	5 A at 250 VAC or at 30 VDC
	Maximum contact voltage	250 VAC or 30 VDC
	Maximum contact current	5 A
	Maximum switching capacity	1,250 VA, 150 W
	Mechanical life	10,000,000 operations
Electrical life		50,000 operations at 5 A, 250 VAC
Degree of protection		Terminal section: IP20
Case material		PC UL94 V-0
Weight		Approx. 65 g
Rated input voltage	K8DS-PM1	3-phase, 3-wire mode: 200, 220, 230, 240 VAC
	K8DS-PM2	3-phase, 3-wire mode: 380, 400, 415, 480 VAC
Operation (overvoltage or undervoltage)	Operating value setting range	Overvoltage = -30% to 25% of maximum rated input voltage Undervoltage = -30% to 25% of maximum rated input voltage
	Operating value	100% operation at set value
Reset (HYS.)	Hysteresis	5% of operating value (fixed)
	Resetting method	Automatic reset
Operating time (T)	Overvoltage/undervoltage	0.1 to 30 s
	Phase-sequence, phase-loss	0.1 s max.
Power ON lock (LOCK)		1 s ±0.5 s
Overload capacity		Continuous input: 500 V
Repeat accuracy	Operating value	±0.5% full scale (at 25°C and an ambient humidity of 65% at the rated power supply voltage, 50/60 Hz sine wave input)
	Operating time	±50 ms (at 25°C and 65% humidity, rated power supply voltage)
Indicators		Power (PWR): Green, Relay output (RY): Yellow LED, OVER/UNDER: Red
Applicable standards	Conforming standards	EN 60947-5-1 Installation environment (pollution level 2, installation category III)
	EMC	EN 60947-5-1
	Safety standards	UL 508 (Recognition), Korean Radio Waves Act (Act 10564), CSA and CCC
Size in mm (H × W × D)		80 × 17.5 × 74



3-phase asymmetry, phase sequence, phase loss relay

Monitors voltage asymmetry, phase sequence and phase loss for 3-phase 3-wire or 4-wire power supplies, in one unit.

- Worldwide power specifications supported by one unit
- Phase sequence, phase loss: Operation reaction time 0.1 s maximum
- Asymmetry: Operation time setting from 0.1 to 30 s
- Reset method: Automatic
- Power ON lock: 1 s or 5 s

Ordering information

Rated input		Order code
3-phase 3-wire mode	200, 220, 230, 240 VAC	K8AK-PA1
3-phase 4-wire mode	115, 127, 133, 138 VAC	
3-phase 3-wire mode	380, 400, 415, 480 VAC	K8AK-PA2
3-phase 4-wire mode	220, 230, 240, 277 VAC	

Specifications

Ambient operating temperature		-20 to 60°C (with no condensation or icing)
Storage temperature		-25 to 65°C (with no condensation or icing)
Altitude		2,000 m max.
Input frequency		50/60 Hz (AC power supply)
Output relays (1 × SPDT, normally closed operation)	Resistive load	5 A at 250 VAC or at 30 VDC
	Maximum contact voltage	250 VAC or 30 VDC
	Maximum contact current	5 A
	Maximum switching capacity	1,250 VA, 150 W
	Mechanical life	10,000,000 operations
	Electrical life	50,000 operations at 5 A, 250 VAC or 30 VDC
Degree of protection		Terminal section: IP20
Case material		PC and ABS
Weight		Approx. 130 g
Rated input voltage	K8AK-PA1	3-phase, 3-wire mode: 200, 220, 230, 240 VAC, 3-phase, 4-wire mode: 115, 127, 133, 138 VAC
	K8AK-PA2	3-phase, 3-wire mode: 380, 400, 415, 480 VAC, 3-phase, 4-wire mode: 220, 230, 240, 277 VAC
Asymmetry operation (ASY.)	Operating value setting range	Asymmetry rate: 2% to 22%
	Operating value	100% operation at set value Asymmetry operating value = rated input voltage × asymmetry set value [%] The asymmetry operation will function when the difference between the highest and lowest voltage phases equals or exceeds the asymmetry operating value
Reset (HYS.)	Hysteresis	5% of operating value (fixed)
	Resetting method	Automatic reset
Operating time (T)	Asymmetry	0.1 s to 30 s
	Phase-sequence, phase-loss	0.1 s max.
Power ON lock (LOCK)		1 s or 5 s (Changed with the DIP switch)
Overload capacity		Continuous input at 115% of maximum input, 10 s at 125% (up to 600 VAC)
Repeat accuracy	Operating value	±0.5% full scale (at 25°C and an ambient humidity of 65% at the rated power supply voltage, DC or 50/60 Hz sine wave input)
	Operating time	±50 ms (at 25°C and 65% humidity, rated power supply voltage)
Indicators		Power (PWR): Green LED, relay output (RY): Yellow LED, alarm outputs (ALM 1/2): Red LED
Applicable standards	Conforming standards	EN 60947-5-1 Installation environment (pollution level 2, installation category III)
	EMC	EN 60947-5-1
	Safety standards	UL 508 (Recognition), Korean Radio Waves Act (Act 10564), CSA and CCC
Size in mm (H × W × D)		90 × 22.5 × 100



3-Phase voltage, phase sequence, loss and asymmetry

The K8DS-PA is the simplified 3-phase monitoring relay, 3-wire circuits with one unit. It can monitor voltage asymmetry with 3-phase sequence and loss at the same time.

- Greater resistance to inverter noise
- One SPDT output relay, 5 A at 250 VAC (resistive load)
- World-wide power specifications supported by one unit (Set with a rotary switch)
- Relay status can be monitored using LED indicator

Ordering information

Rated input		Order code
3-phase 3-wire mode	200, 220, 230, 240 VAC	K8DS-PA1
3-phase 3-wire mode	380, 400, 415, 480 VAC	K8DS-PA2

Specifications

Ambient operating temperature		-20 to 60°C (with no condensation or icing)
Storage temperature		-25 to 65°C (with no condensation or icing)
Altitude		2,000 m max.
Input frequency		50/60 Hz (AC power supply)
Output relays (1 × SPDT, normally closed operation)	Resistive load	5 A at 250 VAC or at 30 VDC
	Maximum contact voltage	250 VAC or 30 VDC
	Maximum contact current	5 A
	Maximum switching capacity	1,250 VA, 150 W
	Mechanical life	10,000,000 operations
Electrical life		50,000 operations at 5 A, 250 VAC or 30 VDC
Degree of protection		Terminal section: IP20
Case material		PC UL94 V-0
Weight		Approx. 65 g
Rated input voltage	K8DS-PA1	3-phase, 3-wire mode: 200, 220, 230, 240 VAC
	K8DS-PA2	3-phase, 3-wire mode: 380, 400, 415, 480 VAC
Asymmetry operation (ASY.)	Operating value setting range	Asymmetry rate: 2% to 22%
	Operating value	100% operation at set value Asymmetry operating value = rated input voltage × asymmetry set value [%] The asymmetry operation will function when the difference between the highest and lowest voltage phases equals or exceeds the asymmetry operating value
Reset (HYS.)	Hysteresis	5% of operating value (fixed)
	Resetting method	Automatic reset
Operating time (T)	Asymmetry	0.1 to 30 s
	Phase-sequence	0.1 s ±0.5 s
	Phase-loss	0.1 s max.
Power ON lock (LOCK)		1 s ±0.5 s
Overload capacity		Continuous input: 500 V
Repeat accuracy	Operating value	±0.5% full scale (at 25°C and an ambient humidity of 65% at the rated power supply voltage, 50/60 Hz sine wave input)
	Operating time	±50 ms (at 25°C and 65% humidity, rated power supply voltage)
Indicators		Power (PWR): Green, Relay output (RY): Yellow, Alarm outputs (ALM): Red
Applicable standards	Conforming standards	EN 60947-5-1 Installation environment (pollution level 2, installation category III)
	EMC	EN 60947-5-1
	Safety standards	UL 508 (Recognition), Korean Radio Waves Act (Act 10564), CSA: C22.2 No. 14, CCC: GB14048.5
Size (H × W × D)		80 × 17.5 × 74 mm



3-Phase asymmetry, phase sequence, phase-loss and over-/undervoltage relay

The K8DS-PZ is the simplified 3-phase monitoring relay, 3-wire circuits with one unit. It can monitor undervoltages, overvoltages, voltage asymmetry, phase sequence and phase-loss.

- Greater resistance to inverter noise
- One SPDT output relay, 5 A at 250 VAC (resistive load)
- World-wide power specifications supported by one unit (Set with a rotary switch)
- Relay status can be monitored using LED indicator

Ordering information

Rated input		Order code
3-phase 3-wire mode	200, 220, 230, 240 VAC	K8DS-PZ1
3-phase 3-wire mode	380, 400, 415, 480 VAC	K8DS-PZ2

Specifications

Ambient operating temperature		-20 to 60°C (with no condensation or icing)
Storage temperature		-25 to 65°C (with no condensation or icing)
Altitude		2,000 m max.
Input frequency		50/60 Hz (AC power supply)
Output relays (1 × SPDT, normally closed operation)	Resistive load	5 A at 250 VAC or at 30 VDC
	Maximum contact voltage	250 VAC or 30 VDC
	Maximum contact current	5 A
	Maximum switching capacity	1,250 VA, 150 W
	Mechanical life	10,000,000 operations
	Electrical life	50,000 operations at 5 A, 250 VAC
Degree of protection		Terminal section: IP20
Case material		PC UL94 V-0
Weight		Approx. 65 g
Rated input voltage	K8DS-PZ1	3-phase, 3-wire mode: 200, 220, 230, 240 VAC
	K8DS-PZ2	3-phase, 3-wire mode: 380, 400, 415, 480 VAC
Operation (overvoltage or undervoltage)	Operating value setting range	Overvoltage/undervoltage: 2% to 30% of rated input voltage
	Operating value	100% operation at set value
Asymmetry operation (ASY.)	Operating value setting range	Asymmetry rate: 5% to 22%
	Operating value	100% operation at set value Asymmetry operating value = rated input voltage x asymmetry set value [%] The asymmetry operation will function when the difference between the highest and lowest voltage phases equals or exceeds the asymmetry operating value
Reset (HYS.)	Hysteresis	5% of operating value (fixed)
	Resetting method	Automatic reset
Operating time (T)	Asymmetry	0.1 to 30 s
	Overvoltage/undervoltage	0.1 to 30 s
	Phase-sequence, phase-loss	0.1 s ±0.05 s, 0.1 s max.
Power ON lock (LOCK)		1 s ±0.5 s
Overload capacity		Continuous input: 500 V
Repeat accuracy	Operating value	±0.5% full scale (at 25°C and an ambient humidity of 65% at the rated power supply voltage, 50/60 Hz sine wave input)
	Operating time	±50 ms (at 25°C and 65% humidity, rated power supply voltage)
Indicators		Power (PWR): Green, Relay output (RY): Yellow LED, Alarm output: Red LED
Applicable standards	Conforming standards	EN 60947-5-1 Installation environment (pollution level 2, installation category III)
	EMC	EN 60947-5-1
	Safety standards	UL 508 (Recognition), Korean Radio Waves Act (Act 10564), CSA: C22.2 No.14
Size in mm (H × W × D)		80 × 17.5 × 74



3-phase voltage asymmetry, phase-sequence, phase-loss and undervoltage relay

The K8DS-PU is the simplified 3-phase monitoring relay, 3-wire circuits with one unit. It can monitor undervoltages, asymmetry, phase sequence and phase loss.

- Greater resistance to inverter noise
- One SPDT output relay, 5 A at 250 VAC (resistive load)
- World-wide power specifications supported by one unit (Set with a rotary switch)
- Relay status can be monitored using LED indicator

Ordering information

Rated input		Order code
3-phase 3-wire mode	200, 220, 230, 240 VAC	K8DS-PU1
3-phase 3-wire mode	380, 400, 415, 480 VAC	K8DS-PU2

Specifications

Ambient operating temperature		-20 to 60°C (with no condensation or icing)
Storage temperature		-25 to 65°C (with no condensation or icing)
Altitude		2,000 m max.
Voltage fluctuation range (UNDER)		Undervoltage 30 to 25% of rated input voltage
Input frequency		50/60 Hz (AC power supply)
Output relays (1× SPDT, normally closed operation)	Resistive load	5 A at 250 VAC or at 30 VDC
	Maximum contact voltage	250 VAC or 30 VDC
	Maximum contact current	5 A
	Maximum switching capacity	1,250 VA, 150 W
	Mechanical life	10,000,000 operations
Electrical life		50,000 operations at 5 A, 250 VAC
Degree of protection		Terminal section: IP20
Case material		PC UL94 V-0
Weight		Approx. 65 g
Rated input voltage	K8DS-PU1	3-phase, 3-wire mode: 200, 220, 230, 240 VAC
	K8DS-PU2	3-phase, 3-wire mode: 380, 400, 415, 480 VAC
Operation (overvoltage or undervoltage)	Operating value setting range	Undervoltage = -30% to 25% of maximum rated input voltage
	Operating value	100% operation at set value
Reset (HYS.)	Hysteresis	5% of operating value (fixed)
	Resetting method	Automatic reset
Operating time (T)	Asymmetry	0.1 to 30 s
	Phase-sequence	0.1 s ±0.5 s
	Phase-loss	0.1 s ±0.05 s
Power ON lock (LOCK)		0.1 s ±0.5 s
Overload capacity		Continuous input: 500 V
Repeat accuracy	Operating value	±0.5% full scale (at 25°C and an ambient humidity of 65% at the rated power supply voltage, 50/60 Hz sine wave input)
	Operating time	±50 ms (at 25°C and 65% humidity, rated power supply voltage)
Indicators		Power (PWR): Green LED, relay output (RY): Yellow LED, UNDER: Red
Applicable standards	Conforming standards	EN 60947-5-1 Installation environment (pollution level 2, installation category III)
	EMC	EN 60947-5-1
	Safety standards	UL 508 (Recognition), Korean Radio Waves Act (Act 10564), CSA and CCC
Size in mm (H × W × D)		80 × 17.5 × 74



3-phase voltage relay

Monitors overvoltages and undervoltages for 3-phase 3-wire or 4-wire power supplies, in one unit. Switch setting for 3-phase 3-wire or 3-phase 4-wire power supply.

- Overvoltages or undervoltages: Operation time setting from 0.1 to 30 s
- Relay warning status can easily be monitored using the LED indicator
- Separate outputs possible for overvoltages and undervoltages
- Reset method: Automatic
- Power ON lock: 1 s or 5 s

Ordering information

Rated input		Order code
3-phase 3-wire mode	200, 220, 230, 240 VAC	K8AK-PW1
3-phase 4-wire mode	115, 127, 133, 138 VAC	
3-phase 3-wire mode	380, 400, 415, 480 VAC	K8AK-PW2
3-phase 4-wire mode	220, 230, 240, 277 VAC	

Specifications

Ambient operating temperature		-20 to 60°C (with no condensation or icing)
Storage temperature		-25 to 65°C (with no condensation or icing)
Altitude		2,000 m max.
Voltage fluctuation rang		85% to 110% of rated input voltage
Input frequency		50/60 Hz (AC power supply)
Output relays (2 × SPDT, normally closed operation)	Resistive load	5 A at 250 VAC or at 30 VDC
	Maximum contact voltage	250 VAC or 30 VDC
	Maximum contact current	5 A
	Maximum switching capacity	1,250 VA, 150 W
	Mechanical life	10,000,000 operations
	Electrical life	50,000 operations at 5 A, 250 VAC or 30 VDC
Degree of protection		Terminal section: IP20
Case material		PC and ABS
Weight		Approx. 150 g
Rated input voltage	K8AK-PW1	3-phase, 3-wire mode: 200, 220, 230, 240 VAC, 3-phase, 4-wire mode: 115, 127, 133, 138 VAC
	K8AK-PW2	3-phase, 3-wire mode: 380, 400, 415, 480 VAC, 3-phase, 4-wire mode: 220, 230, 240, 277 VAC
Operation (overvoltage and undervoltage)	Operating value setting range	Overvoltage = -30% to 25% of maximum rated input voltage ^{*1} Undervoltage = -30% to 25% of maximum rated input voltage ^{*1}
	Operating value	100% operation at set value
Reset (HYS.)	Hysteresis	5% of operating value (fixed)
	Resetting method	Automatic reset
Operating time (T)	Overvoltage/undervoltage	0.1 to 30 s
Power ON lock (LOCK)		1 s or 5 s (Changed with the DIP switch)
Overload capacity		Continuous input at 115% of maximum input, 10 s at 125% (up to 600 VAC)
Repeat accuracy	Operating value	±0.5% full scale (at 25°C and an ambient humidity of 65% at the rated power supply voltage, DC or 50/60 Hz sine wave input)
	Operating time	±50 ms (at 25°C and 65% humidity, rated power supply voltage)
Indicators		Power (PWR): Green LED, relay output (RY): Yellow LED, alarm outputs (ALM 1/2): Red LED
Applicable standards	Conforming standards	EN 60947-5-1 Installation environment (pollution level 2, installation category III)
	EMC	EN 60947-5-1
	Safety standards	UL 508 (Recognition), Korean Radio Waves Act (Act 10564), CSA and CCC
Size in mm (H × W × D)		90 × 22.5 × 100

^{*1} The rated input voltage is switched with a switch



Compact plug-in (8-pin) level controller

The 61F-GP-N8 can be used for single- or two-point level control of conductive materials, both liquids and solids. These products are equipped with a red LED operation indicator.

- Low-voltage (AC) electrodes (8 VAC or 24 VAC)
- Operation range: 4 to 15 k Ω , 70 to 300 k Ω
- Detection method: Conductive
- Probes need to be ordered separately
- Conforms to EMC and LVD directives, UL/CSA approved

Ordering information

Application	Type	Order code
Ordinary purified water or sewage water	General purpose type	61F-GP-N8 24AC
		61F-GP-N8 110AC
		61F-GP-N8 230AC
Ordinary purified water, where the distance between sewage pumps and water tanks or between receiver tanks and supply tanks is long or where remote control is required	Long-distance type	2 km
		4 km
		61F-GP-N8L 24AC 2KM
		61F-GP-N8L 110AC 2KM
		61F-GP-N8L 230AC 2KM
		61F-GP-N8L 24AC 4KM
Liquids with high specific resistance such as distilled water	High sensitivity type	61F-GP-N8H 24AC
		61F-GP-N8H 110AC
		61F-GP-N8H 230AC
Liquids with low specific resistance such as salt water, sewage water, acid chemicals, alkali chemicals	Low sensitivity type	61F-GP-N8D 24AC
		61F-GP-N8D 110AC
		61F-GP-N8D 230AC
Ordinary purified or sewage water, with two-wired-type electrode holder (incorporating a resistor of 6.8 k Ω)	Two-wired type	61F-GP-N8R 24AC
		61F-GP-N8R 110AC
		61F-GP-N8R 230AC
DIN-rail mounting socket		PF083A-E
Back-connecting socket		PL08

Accessories

Electrode holders					
Applications	Mounting style	Insulator material	Max. temperature	Number of electrodes	Order code
For city water and other general use. Easy-to-replace separate versions for maintenance.	Flange	Phenol resin	70°C	3	PS-3S
When mounting space is limited. Special 3-pole holder of small size and light weight.	Screw	Phenol resin		3, 300 mm 3, 1,000 mm	PS-31-300MM PS-31-1000MM
Use for sewage, sea water, etc., having a low specific resistance.	Flange	PPS	150°C (without water drips or vapour on the electrode holder surface)	1	BF-1
For resistance to high pressure. Use in tanks with high temperature or pressure.	Screw	PFA	250°C (without water drips or vapour on the surface of the electrode holder)	1	BS-1
Electrode separators				Number of electrodes	Order code
				1	F03-14 1P
				3	F03-14 3P
Electrodes, connecting, and lock nuts					
Applicable liquids	Material	Component	Indication mark	Inscription	Order code
Purified city water, industrial water, sewage	Equivalent to SUS 304 (AISI-304)	Electrode (1 m long)	1 line	–	F03-01 SUS201
		Connecting nut	–	–	F03-02 SUS201
		Lock nut	–	–	F03-03 SUS201
Purified city water, industrial water, sewage, dilute alkaline solution	SUS316 (AISI-316)	Electrode (1 m long)	2 lines	–	F03-01 SUS316
		Connecting nut	–	6	F03-02 SUS316
		Lock nut	–	316	F03-03 SUS316

Specifications

Item	61F-GP-N8	61F-GP-N8L	61F-GP-N8H	61F-GP-N8D	61F-GP-N8R
Supply voltage	24, 100, 110, 120, 200, 220, 230 or 240 VAC; 50/60 Hz				
Operating voltage range	85 to 110% of rated voltage				
Interelectrode voltage	8 VAC		24 VAC	8 VAC	
Interelectrode current	Approx. 1 mA AC max.		Approx. 0.4 mA AC max.	Approx. 1 mA AC max.	
Power consumption	Approx. 3.5 VA max.				
Response time	Operate: 80 ms max., release: 160 ms max.				
Cable length	1 km max.	2 km max. 4 km max.	50 m max.	1 km max.	800 m max.
Control output	1 A, 250 VAC (inductive load: $\text{Cos}\phi = 0.4$), 3 A, 250 VAC (resistive load)				
Ambient temperature	Operating: -10 to 55°C				
Life expectancy	Electrical: 100,000 operations min., mechanical: 5,000,000 operations min				
Size in mm (HxWxD)	49.9x38x70				



Compact plug-in (11-pin) level controller (DC supply)

This controller is for single- or two-point level control. 24 VDC supply allows for usage in locations without AC power supply. Relay contact chattering usually caused by waves has been eliminated by using open collector output, reducing contact wear.

- Adjustable sensitivity: Operation range: 0 to 100 k Ω
- Red LED for operation indicator
- Conforms to EMC and LVD directives
- UL/CSA approved
- Probes need to be ordered separately

Ordering information

Product name	Output	Order code
Conductive level controller	Open collector (NPN)	61F-GPN-BT 24VDC
	Relay contact (SPST-NO)	61F-GPN-BC 24VDC
Front socket		PF113A-E

Accessories

Electrode holders					
Applications	Mounting style	Insulator material	Max. temperature	Number of electrodes	Order code
For city water and other general use. Easy-to-replace separate versions for maintenance. When mounting space is limited. Special 3-pole holder of small size and light weight.	Flange	Phenol resin	70°C	3	PS-3S
	Screw			3, 300 mm 3, 1000 mm	PS-31-300MM PS-31-1000MM
Use for sewage, sea water, etc., having a low specific resistance.	Flange	PPS	150°C (without water drips or vapour on the electrode holder surface)	1	BF-1
For resistance to high pressure. Use in tanks with high temperature or pressure.	Screw	PFA	250°C (without water drips or vapour on the surface of the electrode holder)	1	BS-1
Electrode separators				Number of electrodes	Order code
				1	F03-14 1P
				3	F03-14 3P
Electrodes, connecting, and lock nuts					
Applicable liquids	Material	Component	Indication mark	Inscription	Order code
Purified city water, industrial water, sewage	Equivalent to SUS 304 (AISI-304)	Electrode (1 m long)	1 line	–	F03-01 SUS201
		Connecting nut	–	–	F03-02 SUS201
		Lock nut	–	–	F03-03 SUS201
Purified city water, industrial water, sewage, dilute alkaline solution	SUS316 (AISI-316)	Electrode (1 m long)	2 lines	–	F03-01 SUS316
		Connecting nut	–	6	F03-02 SUS316
		Lock nut	–	316	F03-03 SUS316

Specifications

Item	61F-GPN-BT	61 F-GPN-BC
Rated voltage	24 VDC	
Allowable voltage range	85 to 110% of the rated voltage	
Interelectrode voltage	5 VAC max.	
Error	For scale of 0: +10 k Ω , for scale of 100: \pm 10 k Ω	
Release resistance	200% max. of the operation resistance	
Switching between supply and drainage	Terminals 7 and 8 open: Automatic drainage operation; terminals 7 and 8 shorted: Automatic supply operation	
Output specifications	Open collector (NPN) 30 VDC, 100 mA max.	SPST-NO; 5 A, 240 VAC (resistive load) 2 A, 240 VAC (inductive load: $\cos\phi = 0.4$)
Life expectancy	–	Electrical: 100,000 operations min. Mechanical: 20,000,000 operations min.
Wiring distance	100 m max.	
Ambient operating temperature	–10 to 55°C	
Response time	Operating: 1.5 s max., releasing: 3.0 s max.	
Size in mm (HxWxD)	49.9x38x70	



22.5 mm wide conductive level controller

The K8AK-LS1 is a conductive level controller in a 22.5 mm wide industrial housing. Via DIP switches its function (supply or drainage) can be selected. This product is for single- or two-point level control.

- Time delay function up to 10 s
- Supply voltages: 24 VAC/DC and 100 to 240 VAC
- Control output: Relay 5 A at 250 VAC resistive load
- Probes cable length: Max. 100 m from controller
- LED indicator: Green for power ON, yellow for output relay

Ordering information

Supply voltage	Order code
24 VAC/VDC	K8AK-LS1 24VAC/DC
100 to 240 VAC	K8AK-LS1 100-240 VAC

Accessories

Electrode holders					
Applications	Mounting style	Insulator material	Max. temperature	Number of electrodes	Order code
For city water and other general use. Easy-to-replace separate versions for maintenance.	Flange	Phenol resin	70°C	3	PS-3S
When mounting space is limited. Special 3-pole holder of small size and light weight.	Screw	Phenol resin		3, 300 mm 3, 1000 mm	PS-31-300MM PS-31-1000MM
Use for sewage, sea water, etc., having a low specific resistance.	Flange	PPS	150°C (without water drips or vapour on the electrode holder surface)	1	BF-1
For resistance to high pressure. Use in tanks with high temperature or pressure.	Screw	Fluoro resin	250°C (without water drips or vapour on the surface of the electrode holder)	1	BS-1
Electrode separators				Number of electrodes	Order code
				1	F03-14 1P
				3	F03-14 3P
Electrodes, connecting, and lock nuts					
Applicable liquids	Material	Component	Indication mark	Inscription	Order code
Purified city water, industrial water, sewage	Equivalent to SUS304 (AISI-304)	Electrode (1 m long)	1 line	–	F03-01 SUS201
		Connecting nut	–	–	F03-02 SUS201
		Lock nut	–	–	F03-03 SUS201
Purified city water, industrial water, sewage, dilute alkaline solution	SUS316 (AISI-316)	Electrode (1 m long)	2 lines	–	F03-01 SUS316
		Connecting nut	–	6	F03-02 SUS316
		Lock nut	–	316	F03-03 SUS316

Specifications

Item		K8AK-LS
Ambient operating temperature		-20 to 60°C (with no condensation or icing)
Storage temperature		-25 to 65°C (with no condensation or icing)
Operating voltage range		85% to 110% of rated operating voltage
Rated power supply frequency		50/60 Hz (AC power supply)
Output relays	Resistive load	5 A at 250 VAC or at 30 VDC
	Maximum contact voltage	250 VAC or 30 VDC
	Maximum contact current	5 A
	Maximum switching capacity	1,250 VA, 150 W
	Mechanical life	10,000,000 operations
Electrical life		50,000 operations at 5 A, 250 VAC or 30 VDC
Degree of protection		Terminal section: IP20
Case material		PC and ABS
Weight		Approx. 150 g
Operating resistance		10 kΩ to 100 kΩ (variable)
Reset resistance		250 kΩ max.
Response time		Approx. 0.1 to 10 s (variable)
Cable length		100 m max. with completely insulated (600 V) cabtire cable with 3 conductors (0.75 mm ²)
Indicators		Green LED: Power, Yellow LED: Control output
Applicable standards	Conforming standards	EN 61010-1 Installation environment (pollution level 2, installation category II)
	EMC	EN 61326-1
	Safety standards	EN 60664-1UL 508 (Recognition), Korean Radio Waves Act (Act 10564), CSA and CCC
Size in mm (H × W × D)		90 × 22.5 × 100



Ultra-miniature liquid leakage sensor amplifier

This very compact plug-in leakage controller fits into Omron's G2R 8-pin sockets (P2RF-08-E). K7L detects a wide variety of liquids, ranging from water to liquid chemicals with low conductivity.

- Operation range: Up to 50 M Ω
- Four sensing ranges available
- Detection method: Conductive
- Two LEDs: Green for power supplied, red for output indication
- Conforms to EMC and LVD Directives, UL/CSA approved

Ordering information

Product name	Characteristics	Order code
Liquid leakage sensor amplifier	Standard	K7L-AT50
	With disconnection function set	K7L-AT50D
	With disconnection function sensor amplifier only	K7L-AT50D-S

Product name	Characteristics	Order code	
Sensors	Sensing band	Standard model (material: Polyethylene)	F03-16PE 5M
		For temperature and chemical resistance (material: Polyethylene PTFE)	F03-16PT 5M
		For flexibility and superior workability (material: Plastic fiber braided cable)	F03-16SF 5M
		For flexibility and visual confirmation of leakage (material: Plastic fiber braided cable)	F03-16SFC 5M
	Point sensor	Easier to wipe off than the band type	F03-16PS
Electrodes have PTFE coating to resist chemicals		F03-16PS-F	

Accessories

Product name	Characteristics	Order code
Terminal blocks (10 pcs)		F03-20
DIN-rail mounted socket	With finger protection	P2RF-08-E
	Without finger protection	P2RF-08

Product name	Characteristics	Order code	
Mounting brackets and stickers	Sensing band stickers	Used for F03-16SF(C)	F03-25
		Used for F03-16PE (adhesive tape)	F03-26PES
		Used for F03-16PE (screws) (30 pcs)	F03-26PEN
		Used for F03-16PT (screws)	F03-26PTN
	Point sensor mounting brackets	Used for F03-16PS	F03-26PS

Specifications

Rated power supply voltage	12 to 24 VDC (allowable voltage fluctuation range: 10 to 30 VDC)
Operate resistance	0 Ω to 50 M Ω , variable Range 0: 0 to 250 k Ω Range 1: 0 to 600 k Ω Range 2: 0 to 5 M Ω Range 3: 0 to 50 M Ω
Release resistance	105% min. of operate resistance
Output configuration	NPN open-collector transistor output with 100 mA at 30 VDC max.
Wiring distance	Connecting cable: 50 m max. Sensing band length: 10 m max.
Ambient temperature	Operating: -10 to 55°C
Power consumption	1 W max.
Response time	Operate: 800 ms max., release: 800 ms max.
Weight	Approx. 14 g
Disconnection detection function (K7L-AT50D & K7L-AT50D-S only)	Detection signal: 10 VDC max., 200 ms, detection time: 10 s max. Release: By resetting the power supply
Size in mm (HxWxD)	28.8x12.8x46



Thermistor motor protection relay

The K8AK-TS is the temperature monitoring relay based on the thermistor detection and can protect the motor from overheating.

The K8AK-PT gives further functionalities such as temperature, 3-phase sequence and loss monitoring and contributes to the overall safety 3-phase motor's operation.

- DIN 22.5-mm-sized K8AK-PT relays
- Side-by-side mounting of K8AK-PT relays
- Specially designed for internal motor monitoring, no setting required
- Test/Reset button for confirmation of output operation
- Monitoring also performed for thermistor disconnections and short circuits
- Manual or automatic resetting with the same relay

Ordering information

Rated input		Order code
Temperature monitoring	24 VAC/DC	K8AK-TS1 24 VAC/DC
Phase sequence, phase loss and temperature monitoring	100 to 240 VAC	K8AK-PT1 100-240 VAC
		K8AK-TS1 100-240 VAC

Specifications

Ambient operating temperature		-20 to 60°C (with no condensation or icing)
Storage temperature		-25 to 65°C (with no condensation or icing)
Input frequency		50/60 Hz (AC power supply)
Output relays (2 × SPDT, normally closed operation)	Resistive load	5 A at 250 VAC or at 30 VDC
	Maximum contact voltage	250 VAC or 30 VDC
	Maximum contact current	5 A
	Maximum switching capacity	1,250 VA, 150 W
	Mechanical life	10,000,000 operations
Electrical life		50,000 operations at 250 VAC or 30 VDC
Degree of protection		Terminal section: IP20
Case material		PC and ABS UL94 V-0
Weight		Approx. 150 g
Rated input voltage		3-phase, 3-wire mode: 200 to 480 VAC
Reset method		Manual reset/automatic reset (switchable) ^{*1}
Operating time (T)	Phase-sequence on three-phase voltage input	0.1 s ±0.05 s
	Phase loss on three-phase voltage input	0.1 s max. (when the voltage changes rapidly from 100 to 0% of rated voltage)
	PTC thermistor input	0.2 s max.
Overload capacity		Continuous input: 528 V
Indicators		Power (PWR): Green, PH alarm outputs (ALM): Red, TS alarm outputs (ALM): Red
Applicable standards	Conforming standards	EN 60947-5-1 Installation environment (pollution level 2, installation category III)
	EMC	EN 60947-5-1
	Safety standards	UL 508 (Recognition), Korean Radio Waves Act (Act 10564), CSA and CCC
Size in mm (H × W × D)		90 × 22.5 × 100

^{*1} Manual reset method: Press the TEST/RESET button.



Protect your heating application

This temperature monitoring relay was designed specially for monitoring abnormal temperatures to prevent excessive temperature increase and to protect equipment. K8AK-TH provides temperature monitoring in a slim design with a width of just 22.5 mm.

- Simple function settings using DIP switch
- Selectable alarm latch and SV setting protection
- Multi-input support for thermocouple or Pt100 and Pt1000 sensor input
- Changeover relay: fail-safe selectable
- Alarm status identification with LED

Ordering information

Input type	Temperature setting range	Setting unit	Supply voltage	Size in mm (H×W×D)	Order code
Thermocouple/ Pt100 and Pt1000	0 to 999°C/F	1°C/F	100 to 240 VAC	90×22.5×100	K8AK-TH11S AC100-240
			24 VAC/VDC		K8AK-TH11S AC/DC24
Thermocouple	0 to 1,800°C 0 to 3,200 °F *1	10°C/F	100 to 240 VAC		K8AK-TH12S AC100-240
			24 VAC/VDC		K8AK-TH12S AC/DC24

*1 Setting range depending on sensor type selected

Specifications

Item	100 to 240 VAC 50/60 Hz	24 VAC 50/60 Hz or 24 VDC
Allowable voltage range	85 to 110% of power supply voltage	
Power consumption	5 VA max.	2 W max. (24 VDC), 4 VA max. (24 VAC)
Sensor inputs	K8AK-TH11S	Thermocouple: K, J, T, E; platinum-resistance thermometer: Pt100, Pt1000
	K8AK-TH12S	Thermocouple: K, J, T, E, B, R, S, PLII
Output relay	One SPDT relay (5 A at 250 VAC, resistive load)	
External inputs (for latch setting)	Contact input	ON: 1 kΩ max., OFF: 100 kΩ min.
	Non-contact input	ON residual voltage: 1.5 V max., OFF leakage current: 0.1 mA max. Leakage current: Approx. 10 mA
Setting method	Rotary switch setting (set of three switches)	
Indicators	Power (PWR): Green LED, relay output (ALM): Red LED	
Other functions	Alarm mode (upper limit/lower limit), output normally ON/OFF selection, output latch, setting protection, fail-safe operation selectable, temperature unit °C/°F	
Ambient operating temperature	-20 to 55°C (with no condensation or icing)	
Storage temperature	-25 to 65°C (with no condensation or icing)	
Setting accuracy	±1% of full scale	
Hysteresis width	2°C	
Output relays (1 × SPDT, normally closed operation)	Resistive load	5 A at 250 VAC or at 30 VDC
	Maximum contact voltage	250 VAC or 30 VDC
	Maximum contact current	5 A
	Maximum switching capacity	1,250 VA, 150 W
	Electrical life	50,000 operations at 5 A, 250 VAC or 30 VDC
Sampling cycle	100 ms	
Weight	160 g	
Degree of protection	IP20	
Memory protection	Non-volatile memory (number or writes: 1,000,000)	
Safety standards	Approved standards	EN 61010-1 (Pollution level 2, overvoltage category II)
	Application standards	EN 61326-1, UL 61010-1, Korean Radio Waves Act (Act 10564), CSA:CAN/CSA C22.2 No.14, CCC: GB14048.5
Crimp terminals	Two solid wires of 2.5 mm ² or two ferrules of 1.5 mm ² with insulation sleeves can be tightened together	
Case material	PC and ABS	
Mounting	Mounted to DIN-rail	
Size in mm (H×W×D)	90×22.5×100	

Pushbutton switches

16 MM SUB-ASSEMBLED PUSHBUTTON SWITCHES







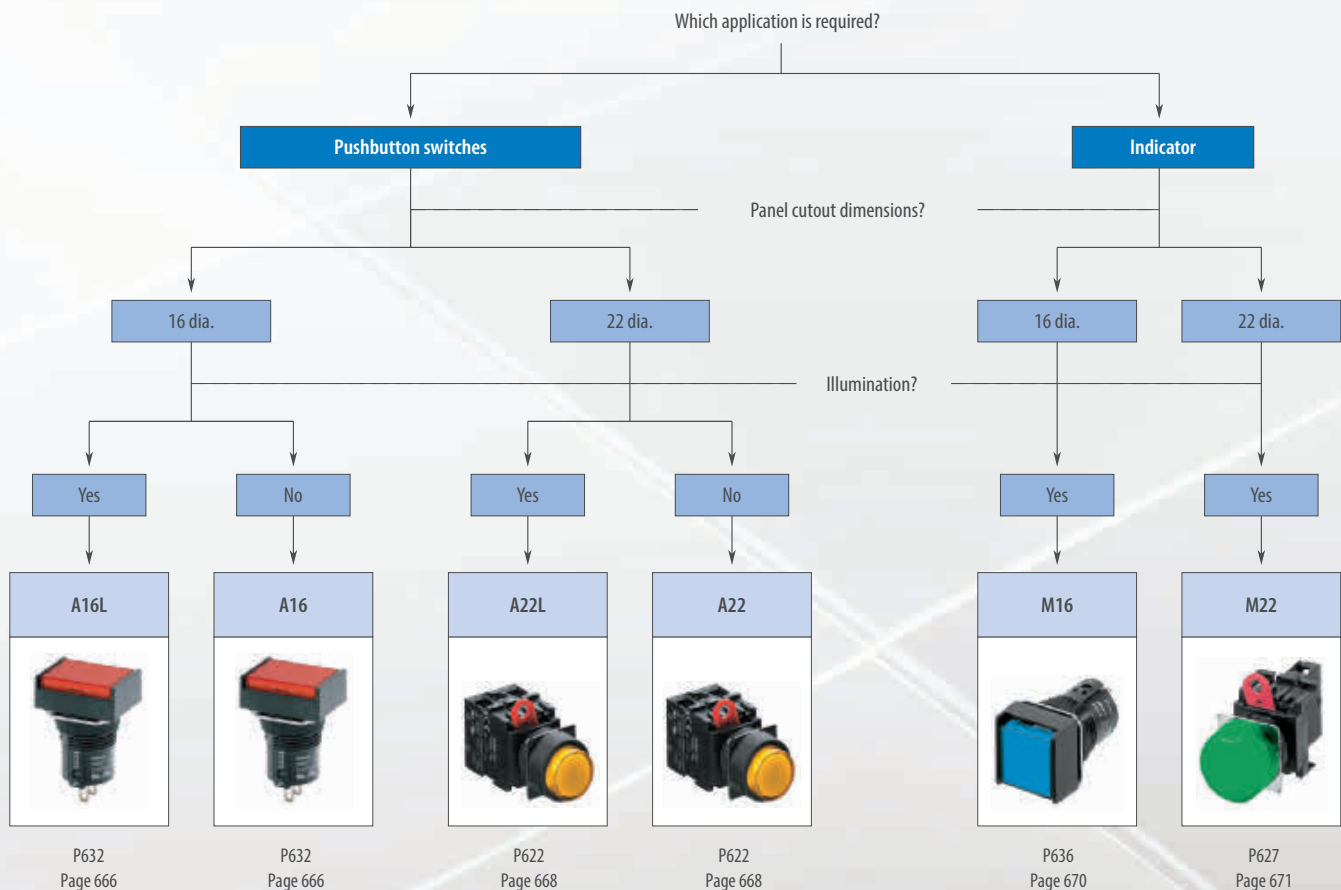

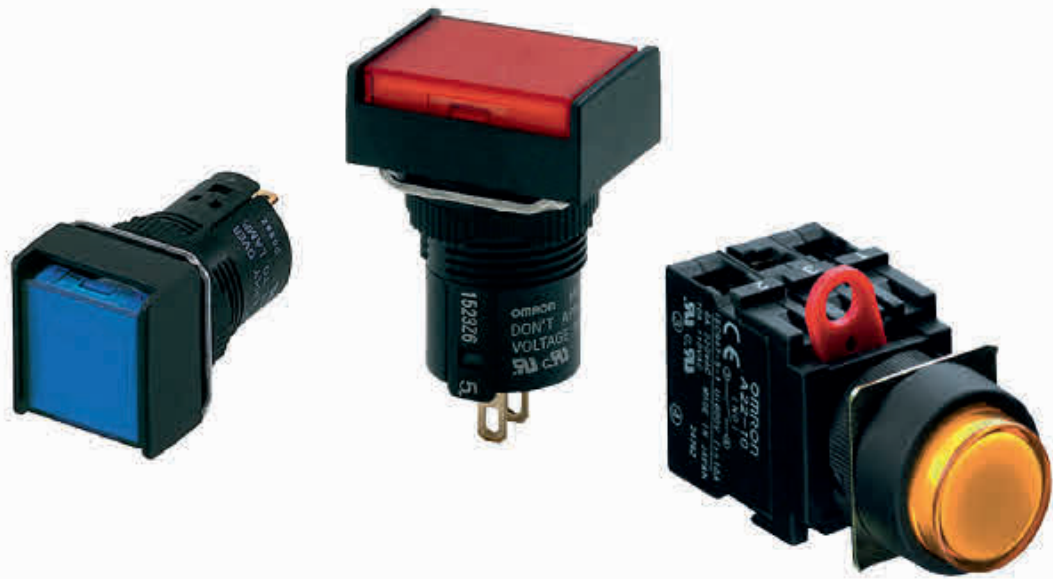
A165 – Full range with IP65 rating

All our 16 mm pushbuttons are upgraded to IP65 rating. This will increase the reliability of your application. The pushbuttons are very easy to assemble due to their modular construction: Pushbutton + case + lamp (if applicable) + switch.

- Wide range of models: rectangular, square & round
- With or without lamp
- Easy assembly and installation





Category		Pushbutton switch		Indicator		
						
Model		A16	A22	M16	M22	
Selection criteria	Mounting	Nut-mounting				
	Size	16 mm	22 mm	16 mm	22 mm	
	Shape					
Pushbutton color	Incandescent lamp-lighted	Red	■	■	■	■
		Yellow	■	■	■	■
		Pure yellow	■		■	-
		Green	■	■	■	■
		White	■	■	■	■
		Blue	■	■	■	■
	LED-lighted	Red	■	■	■	■
		Yellow	■	■	■	■
		Pure yellow	■		■	-
		Green	■	■	■	■
		Blue	■	■	■	■
	Non-lighted	Red	■	■	-	-
		Yellow	■	■	-	-
		Green	■	■	-	-
		White	■	■	-	-
Blue		■	■	-	-	
Features	Momentary operation	■	■	-	-	
	Self-holding	■	■	-	-	
	Number of contacts	2	6	-	-	
	IP rating	IP65				
	Legend plate	■	■	■	■	
Switch ratings [A]	125 VAC	5	10	-	-	
	250 VAC	3	6	-	-	
	30 VDC	3	10	-	-	
	Rated load	5 A at 125 VAC, 3 A at 250 VAC, 3 A at 30 VDC	10 A at 110 VAC, 6 A at 220 VAC	-	-	
Terminals	Solder	■	-	■	-	
	PCB	-	-	■	-	
	Screw-less Clamp	-	-	■	-	
Operating voltage	5 VDC	■	■	■	■	
	12 VDC	■	■	■	■	
	24 VDC	■	■	■	■	
Form	SPDT	■	-	-	-	
	DPDT	■	-	-	-	
	SPST-NO	-	■	-	-	
	SPST-NC	-	■	-	-	
	SPST-NO + SPST-NC	-	■	-	-	
	DPST-NO	-	■	-	-	
	DPST-NC	-	■	-	-	
Page/Quick Link	666	668	670	671		

■ Standard □ Available - No/not available



16 mm pushbutton switch

These sub-assembled pushbutton switches have a modular construction: pushbutton + case + lamp (if applicable) + switch. A16 is a nut-mounted pushbutton switch with a short mounting depth of less than 28.5 mm below panel.

- Wide variety of control and signal devices: lighted, non-lighted and buzzer
- Quick and easy assembly, snap-in switch
- Wide range of switching capacity from standard load to micro load
- High reliability, IP65
- UL, cUL, CSA and VDE approved, conforms to EN60947-5-1 and IEC947-5-1



Ordering information

Type	Color	Order code		
		Degree of protection: Oil-resistant IP65		
		Rectangular	Square	Round
Non-lighted LED Incandescent lamp	Red	A165L-JR	A165L-AR	A165L-TR
	Yellow	A165L-JY	A165L-AY	A165L-TY
	Pure yellow	A165L-JPY	A165L-APY	A165L-TPY
	White	A165L-JW	A165L-AW	A165L-TW
	Blue	A165L-JA	A165L-AA	A165L-TA
Non-lighted	Black	A165L-JB	A165L-AB	A165L-TB
LED	Green	A165L-JGY	A165L-AGY	A165L-TGY
Non-lighted/incandescent lamp	Green	A165L-JG	A165L-AG	A165L-TG



Cases

Appearance	Classification	Order code	
		Oil-resistant IP65	
	Momentary operation	Rectangular (2-way guard)	A165-CJM
		Square	A165-CAM
		Round	A165-CTM
	Alternate operation	Rectangular (2-way guard)	A165-CJA
		Square	A165-CAA
		Round	A165-CTA

Switches

Appearance	Classification			Order code	
	Lighted/ non-lighted (common use)	Standard load/ microload (com- mon use)	SPDT	Solder terminal	A16-1
			DPDT		A16-2
			SPDT	PCB terminal	A16-1P
			DPDT		A16-2P
			DPDT	Screw- less clamp	A16-2S

Switches with reduced voltage lighting



Appearance	Classification			Order code	
	100 V	Standard load/ microload (common use)	SPDT	Solder terminal	A16-T1-1
			DPDT		A16-T1-2
	100 V		DPDT	Screw-less clamp	A16-T1-2S
	200 V				A16-T2-2S

Lamps

Type	Color	Order code		
		5 VDC	12 VDC	24 VDC
LED	Red	A16-5DSR	A16-12DSR	A16-24DSR
	Yellow	A16-5DSY	A16-12DSY	A16-24DSY
	Green	A16-5DSG	A16-12DSG	A16-24DSG
	White ^{*1}	A16-5DSW	A16-12DSW	A16-24DSW
	Blue	A16-5DA	A16-12DA	A16-24DA
Type		5 VAC/VDC	12 VAC/VDC	24 VAC/VDC
Incandescent lamp		A16-5	A16-12	A16-24

^{*1} Use the white LED together with white or pure yellow pushbuttons.

Accessories

Name	Appearance	Classification	Remarks	Order code
Switch guards		For rectangular models	Cannot be used with the dust cover	A16ZJ-5050
		For square and round models		A16ZA-5050
Dust covers		For rectangular models	Cannot be used with the switch guard	A16ZJ-5060
		For square models		A16ZA-5060
		For round models		A16ZT-5060
Panel plugs		For rectangular models	Used for covering the panel cutouts for future panel expansion	A16ZJ-3003
		For square models		A16ZA-3003
		For round models		A16ZT-3003

Specifications

Allowable operating frequency	Mechanical	Momentary operation: 120 operations/minute max. Alternate operation: 60 operations/minute max.
	Electrical	20 operations/minute max.
Durability	Mechanical	Momentary operation: 2,000,000 operations min. Alternate operation: 200,000 operations min.
	Electrical	100,000 operations min.
Ambient temperature		Operating: -10 to 55°C (with no icing or condensation) Storage: -25 to 65°C (with no icing or condensation)
Weight		Approx. 10 g (in the case of a lighted DPDT switch with solder terminals)
Size in mm (H×W×D)		Round/square: 18×18×28.5 rectangular: 18×24×28.5

Operating characteristics	Pushbutton switch	
	Oil-resistant IP65	
	SPDT	DPDT
Operating force (OF) max.	2.94 N	4.91 N
Releasing force (RF) min.	0.29 N	
Total travel (TT)	Approx. 3 mm	
Pretravel (PT) max.	2.5 mm	
Lock stroke (LTA) min.	0.5 mm	

Item	Screw-less clamp				
Recommended wire size	0.5 mm ² twisted wire or 0.8 mm dia. solid wire				
Usable wires and tensile strength	Twisted wire	0.3 mm ²	0.5 mm ²	0.75 mm ²	1.25 mm ²
	Solid wire	0.5 mm dia.	0.8 mm dia.	1.0 mm dia.	
	Tensile strength	10 N	20 N	30 N	40 N
Length of exposed wire	10 ±1 mm				



22 mm pushbutton switch

The A22 comes in a wide variety of shapes and colors and is installable in 22-dia. or 25-dia. panel cutouts. The switch unit can be easily mounted. A22 is mounted using either open-type (fork-type) or closed-type (round-type) crimp terminals.

- Finger-protection mechanism on the switch unit are provided as a standard feature
- Increased wiring efficiency with three-row mounting of switch blocks
- IP65 oil-resistant (non-lighted models), IP65 (lighted models)
- Lighted and non-lighted, flat, projection and half- and full-guard versions
- EN60947-5-1, UL and cUL approved

Ordering information

Pushbutton

Illumination	Color	Order code							
		Flat type	Projection type	Full-guard type	Half-guard type	Square/projection type	Square/full-guard type	Round/mushroom type (30-dia. head)	Round/mushroom type (40-dia. head)
Non-lighted	Red	A22-FR	A22-TR	A22-GR	A22-HR	A22-CR	A22-DR	A22-SR	A22-MR
	Green	A22-FG	A22-TG	A22-GG	A22-HG	A22-CG	A22-DG	A22-SG	A22-MG
	Yellow	A22-FY	A22-TY	A22-GY	A22-HY	A22-CY	A22-DY	A22-SY	A22-MY
	White	A22-FW	A22-TW	A22-GW	A22-HW	A22-CW	A22-DW	A22-SW	A22-MW
	Blue	A22-FA	A22-TA	A22-GA	A22-HA	A22-CA	A22-DA	A22-SA	A22-MA
Lighted	Red	-	A22L-TR	A22L-GR	A22L-HR	A22L-CR	A22L-DR	-	-
	Green	-	A22L-TG	A22L-GG	A22L-HG	A22L-CG	A22L-DG	-	-
	Yellow	-	A22L-TY	A22L-GY	A22L-HY	A22L-CY	A22L-DY	-	-
	White	-	A22L-TW	A22L-GW	A22L-HW	A22L-CW	A22L-DW	-	-
	Blue	-	A22L-TA	A22L-GA	A22L-HA	A22L-CA	A22L-DA	-	-
Buttonsize in mm		29.7 dia. x 12D	29.7 dia. x 19D	29.7 dia. x 19D	29.7 dia. x 12/18.5D	29.8 mm ² x 18D	29.8 mm ² x 18D	30 dia. x 32D	40 dia. x 32D

Switches

Switch operation	Contacts	Order code			
		Non-lighted models		Lighted models	
		Without voltage reduction unit		With voltage reduction unit	
Momentary	SPST-NO	A22-10M	A22L-10M	A22L-10M-T1	A22L-10M-T2
	SPST-NC	A22-01M	A22L-01M	A22L-01M-T1	A22L-01M-T2
	SPST-NO + SPST-NC	A22-11M	A22L-11M	A22L-11M-T1	A22L-11M-T2
	DPST-NO	A22-20M	A22L-20M	A22L-20M-T1	A22L-20M-T2
	DPST-NC	A22-02M	A22L-02M	A22L-02M-T1	A22L-02M-T2
Alternate	SPST-NO	A22-10A	A22L-10A	A22L-10A-T1	A22L-10A-T2
	SPST-NC	A22-01A	A22L-01A	A22L-01A-T1	A22L-01A-T2
	SPST-NO + SPST-NC	A22-11A	A22L-11A	A22L-11A-T1	A22L-11A-T2
	DPST-NO	A22-20A	A22L-20A	A22L-20A-T1	A22L-20A-T2
	DPST-NC	A22-02A	A22L-02A	A22L-02A-T1	A22L-02A-T2

Switch blocks

	Standard load	Order code
Switch blocks	SPST-NO	A22-10
	SPST-NC	A22-01
	DPST-NO	A22-20
	DPST-NC	A22-02

Lamp - LED

AC/DC	LED light	Order code			
		Operating voltage			
		6 V	12 V	24 V	24 V superbright
DC	Red	A22-6DR	-	-	-
	Green	A22-6DG	-	-	-
	Yellow *1	A22-6DY	-	-	-
	Blue	A22-6DA	-	-	-
AC	Red	A22-6AR	-	-	-
	Green	A22-6AG	-	-	-
	Yellow *1	A22-6AY	-	-	-
	Blue	A22-6AA	-	-	-
AC and DC	Red	-	A22-12AR	A22-24AR	A22-24ASR
	Green	-	A22-12AG	A22-24AG	A22-24ASG
	Yellow *1	-	A22-12AY	A22-24AY	A22-24ASY
	Blue	-	A22-12AA	A22-24AA	A22-24ASA

*1 Used when the pushbutton color is yellow or white

Lamp - incandescent lamp

Order code		
Operating voltage		
5 VAC/VDC	12 VAC/VDC	24 VAC/VDC
A22-5	A22-12	A22-24

Accessories

Item			Remarks	Order code		
Lamp sockets	Direct lighting		Used when changing the lighting method (LED only)	A22-TN		
	Voltage-reduction lighting	220 VAC		A22-T2		
Mounting latches	For momentary models		Order mounting latches only when mounting switch blocks or lamp sockets are purchased individually	A22-3200		
Legend plate frames	Large size	With snap-in legend plate, without text, black	Snap-in legend plate is acrylic	A22Z-3333		
		Without snap-in legend plate		A22Z-3330		
Sealing caps	For projection models		Used to prevent dust or water from entering the operation unit (pushbutton, etc.), color: Opaque, material: Silicon	A22Z-3600T		
Three-throw spacer			Used when mounting three non-lighted switches	A22Z-3003		
Control boxes (enclosures)	Exclusively for A22		One hole	Do not use DPST-NO or DPST-NC switches, material: Polycarbonate resin	A22Z-B101	
			Two holes		A22Z-B102	
			Three holes		A22Z-B103	
Snap-in legend plates	Standard size	Without text	White	Attached to the standard-size legend plate frame, material: Acrylic	A22Z-3443W	
			Transparent		A22Z-3443C	
		White text on black background	ON		A22Z-3443B-5	
			OFF		A22Z-3443B-6	
			DOWN		A22Z-3443B-8	
	Large size	Without text	White		Attached to the large-size legend plate frame, material: Acrylic	A22Z-3453W
			Transparent		A22Z-3453C	
	For emergency stop switch	60-dia. round plate with black letters on a yellow background			"EMERGENCY STOP" is engraved on the plate.	A22Z-3466-1
		90-dia. round plate with black letters on a yellow background			Used as an emergency stop switch legend plate	A22Z-3476-1
Lamp extractor			Rubber tool used to easily replace lamps	A22Z-3901		
Tightening wrench			Tool used to tighten nuts from the back of the panel	A22Z-3905		

Specifications

Recognized organization	Standards	File number
UL, cUL	UL508	E41515
-	EN60947-5-1	-

Contact ratings (standard load)

Rated carry current (A)	Rated voltage	Rated current (A)			
		AC15 (inductive load)	AC12 (resistive load)	DC13 (inductive load)	DC12 (resistive load)
10	24 VAC	10	10	-	-
	110 VAC	5	10	-	-
	220 VAC	3	6	-	-
	380 VAC	2	3	-	-
	440 VAC	1	2	-	-
	24 VDC	-	-	1,5	10
	110 VDC	-	-	0,5	2
	220 VDC	-	-	0,2	0,6
	380 VDC	-	-	0,1	0,2

Contacts (microload)

Rated applicable load	Minimum applicable load
50 mA at 5 VDC (resistive load)	1 mA at 5 VDC

LED indicators without voltage reduction unit

Rated voltage	Rated current	Operating voltage
6 VDC	60 mA (20 mA)	6 VDC ±5%
6 VAC	60 mA (20 mA)	6 VAC/VDC ±5%
12 VAC/VDC	30 mA (10 mA)	12 VAC/VDC ±5%
24 VAC/VDC	15 mA (10 mA)	24 VAC/VDC ±5%

Super-bright LED indicator

Rated voltage	Rated current	Operating voltage
24 VAC/VDC	15 mA	24 VAC/VDC ±5%

Incandescent lamp

Rated voltage	Rated current	Operating voltage
6 VAC/VDC	200 mA	5 VAC/VDC
14 VAC/VDC	80 mA	12 VAC/VDC
28 VAC/VDC	40 mA	24 VAC/VDC
130 VAC/VDC	20 mA	100 VAC/VDC

Voltage-reduction lighting

Rated voltage	Operating voltage	Applicable lamp (BA8S/13_gold)
110 VAC	95 to 115 VAC	LED Lamp (A22-24A_)
220 VAC	190 to 230 VAC	

Item		Pushbutton switches		Emergency stop switches		Knob-type selector switches		Key-type selector switch
		Non-lighted	Lighted	Non-lighted	Lighted	Non-lighted	Lighted	Non-lighted
Allowable operating frequency	Mechanical	Momentary operation: 60 operations/minute max.		30 operations/minute max.		Manual release: 30 operations/minute max., automatic release: 30 operations/minute max.		
	Electrical	30 operations/minute max.				30 operations/minute max.		
Durability (number of operations min.)	Mechanical	Momentary operation: 5,000,000		Momentary operation: 300,000		500,000	100,000	500,000
	Electrical	500,000		300,000		500,000	100,000	500,000
Ambient temperature	Operating	-20 to 70°C	-20 to 55°C	-20 to 70°C	-20 to 55°C	-20 to 70°C	-20 to 55°C	-20 to 70°C
	Storage	-40 to 70°C	-40 to 70°C	-40 to 70°C	-40 to 70°C	-40 to 70°C	-40 to 70°C	-40 to 70°C
Degree of protection		IP65 (oil-resistant)	IP65	IP65 (oil-resistant)	IP65	IP65 (oil-resistant)	IP65	IP65 (oil-resistant)
Size in mm (in-panel only)		34H × 34W × 54.7D, 34H × 34W × 72.7D for DPST switches						



Indicators with a mounting aperture of 16 mm

The M16 series of nut-mounted indicators comes in rectangular, square and round versions. Due to its modular construction, assembly is quick and easy. M16 comes in a wide variety of control and signal devices with a wide range of switching capacities, from general load to micro load.

- LED, incandescent and neon lamp
- Snap-in switch unit
- Short mounting depth, less than 28.5 mm below panel
- High reliability, IP65
- UL, CSA and VDE approved, conforms to EN60947-5-1

Ordering information

Pushbutton

Type	Display color	Order code		
		IP65 oil-resistant		
		Rectangular	Square	Round
LED Incandescent lamp	Red	A165L-JR	A165L-AR	A165L-TR
	Yellow	A165L-JY	A165L-AY	A165L-TY
	Pure yellow	A165L-JPY	A165L-APY	A165L-TPY
	White	A165L-JW	A165L-AW	A165L-TW
	Blue	A165L-JA	A165L-AA	A165L-TA
LED Incandescent lamp	Green	A165L-JGY	A165L-AGY	A165L-TGY
	Green	A165L-JG	A165L-AG	A165L-TG

Lamp

Type	Color	Order code		
		Operating voltage		
		5 VDC	12 VDC	24 VDC
LED	Red	A16-5DSR	A16-12DSR	A16-24DSR
	Yellow	A16-5DSY	A16-12DSY	A16-24DSY
	Green	A16-5DSG	A16-12DSG	A16-24DSG
	White	A16-5DSW	A16-12DSW	A16-24DSW
	Blue	A16-5DA	A16-12DA	A16-24DA
Type		5 VAC/VDC	12 VAC/VDC	24 VAC/VDC
Incandescent lamp		A16-5	A16-12	A16-24

Case

Classification	Order code	
IP65 oil-resistant	Rectangular	A165-CJM
	Square	A165-CAM
	Round	A165-CTM

Socket

Classification	Order code		
Solder terminals	M16-0		
PCB terminals	M16-0P		
Screw-less clamp	M16-S		
Solder terminals Screw-less clamp	Voltage-reduction lighting	100 V	M16-T1
		100 V	M16-T1-S
		200 V	M16-T2-S

Specifications

Allowable operating frequency	Mechanical	Momentary operation: 120 operations/minute max., alternate operation: 60 operations/minute max.
	Electrical	20 operations/minute max.
Durability	Mechanical	Momentary operation: 2,000,000 operations min., alternate operation: 200,000 operations min.
	Electrical	100,000 operations min.
Degree of contamination	3 (IEC947-5-1)	
Ambient temperature	Operating: -10 to 55°C (with no icing or condensation) Storage: -25 to 65°C (with no icing or condensation)	
Weight	Approx. 10 g (in the case of a lighted DPDT switch with solder terminals)	
Size in mm	Round/square: 18Hx18Wx28.5D rectangular: 18Hx24Wx28.5D	

Agency	Standards	File number
UL, cUL	UL508	E41515

Ratings

Superbright LED			
Rated voltage	Rated current	Operating voltage	Built-in limiting resistance
5 VDC	30 mA (15 mA)	5 VDC ±5%	33 Ω (68 Ω)
12 VDC	15 mA	12 VDC ±5%	270 Ω (560 Ω)
24 VDC	10 mA	24 VDC ±5%	1,600 Ω (2,000 Ω)

Incandescent lamp		
Rated voltage	Rated current	Operating voltage
6 VAC/VDC	60 mA	5 VAC/VDC
14 VAC/VDC	40 mA	12 VAC/VDC
28 VAC/VDC	24 mA	24 VAC/VDC



Nut-mounted, 22 mm indicator, with high visibility, illuminated buttons

The M22 series of indicators comes in 22 or 25 mm-diameter round versions. They can be easily mounted and removal of the socket unit is also easy. The finger protection mechanism on the lamp is provided as a standard feature. M22 indicators can be equipped with an LED or incandescent lamp.

- Available in 5 colors
- Super-bright LEDs for all versions
- Lamp sockets with or without transformers
- UL and cUL approved

Ordering information

Display

Appearance	IP65 oil-resistant	
	Color of display	Order code
Round/flat	Red	M22-FR
	Green	M22-FG
	Yellow	M22-FY
	White	M22-FW
	Blue	M22-FA
Square/projection	Red	M22-CR
	Green	M22-CG
	Yellow	M22-CY
	White	M22-CW
	Blue	M22-CA

Socket unit

Order code	
Voltage-reduction circuits	
Without voltage reduction unit	With voltage reduction unit (220 VAC)
M22-00	M22-00-T2

Lamp

AC/DC	LED light	Operating voltage			
		6 V	12 V	24 V	24 V superbright
AC	Red	A22-6DR	–	–	–
	Green	A22-6DG	–	–	–
	Yellow	A22-6DY	–	–	–
	Blue	A22-6DA	–	–	–
	–	–	–	–	–
DC	Red	A22-6AR	–	–	–
	Green	A22-6AG	–	–	–
	Yellow	A22-6AY	–	–	–
	Blue	A22-6AA	–	–	–
	–	–	–	–	–
AC and DC	Red	–	A22-12AR	A22-24AR	A22-24ASR
	Green	–	A22-12AG	A22-24AG	A22-24ASG
	Yellow	–	A22-12AY	A22-24AY	A22-24ASY
	Blue	–	A22-12AA	A22-24AA	A22-24ASA
	–	–	–	–	–
Incandescent lamp		6 VAC/VDC	12 VAC/VDC	24 VAC/VDC	100 VAC/VDC
		A22-5	A22-12	A22-24	A22-H1

Accessories

M22 uses the same accessories as A22. Please refer to the relevant information in the corresponding section for the A22.

Specifications

Recognized organization	Standards	File number
UL, cUL	UL508	E41515

LED lamp

Rated voltage	Rated current	Operating voltage
6 VDC	60 mA (20 mA)	6 VDC ±5%
6 VAC	60 mA (20 mA)	6 VAC ±5%
12 VAC/VDC	30 mA (10 mA)	12 VAC/VDC ±5%
24 VAC/VDC	15 mA (10 mA)	24 VAC/VDC ±5%

Incandescent lamp

Rated voltage	Rated current	Operating voltage
6 VAC/VDC	200 mA	5 V
14 VAC/VDC	80 mA	12 V
28 VAC/VDC	40 mA	24 V
130 VAC/VDC	20 mA	100 V

Superbright LED indicator

Rated voltage	Rated current	Operating voltage
24 VAC/VDC	15 mA	24 VAC/VDC ±5%

Voltage-reduction lighting

Rated voltage	Rated current	Operating voltage
110 VAC	95 to 115 VAC	LED lamp (A22-24_)
220 VAC	190 to 230 VAC	

Ambient temperature	Operating: –20 to 55°C, storage: –40 to 70°C
Degree of protection	IP65
Electric shock protection class	Class II
PTI (tracking characteristic)	175
Degree of contamination	3 (IEC947-5-1)
Size in mm	Button: 29.7 dia. × 16D, switch: 34H × 34W × 54.7D

Software

Find information fast!

Quick Links shortens your search. Quick Links are unique codes assigned to Omron products listed in this guide. Enter Quick Link codes in the search box on industrial.omron.eu to access detailed information on products in this guide.

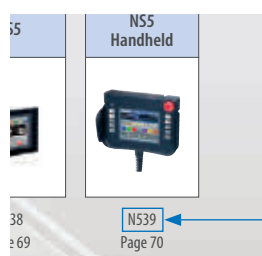

Quick Link

Software

Software

Product overview	674
Software	
CX-One	676
CX-Supervisor	677
CX-Server OPC	678
CX-Server LITE	678
Sysmac Studio	679

ONE SOFTWARE-ONE CONNECTION-ONE MINUTE

One software for all your automation needs

“One Software” is a key component of the overall architecture of Omron software. Whether for our Compact & Modular range or our new Sysmac platform, integration of software technologies brings value direct to the customer. These softwares integrate configuration, programming and monitoring in packages designed for those platforms. Integrated software gives you the power and efficiency to develop and create like never before.

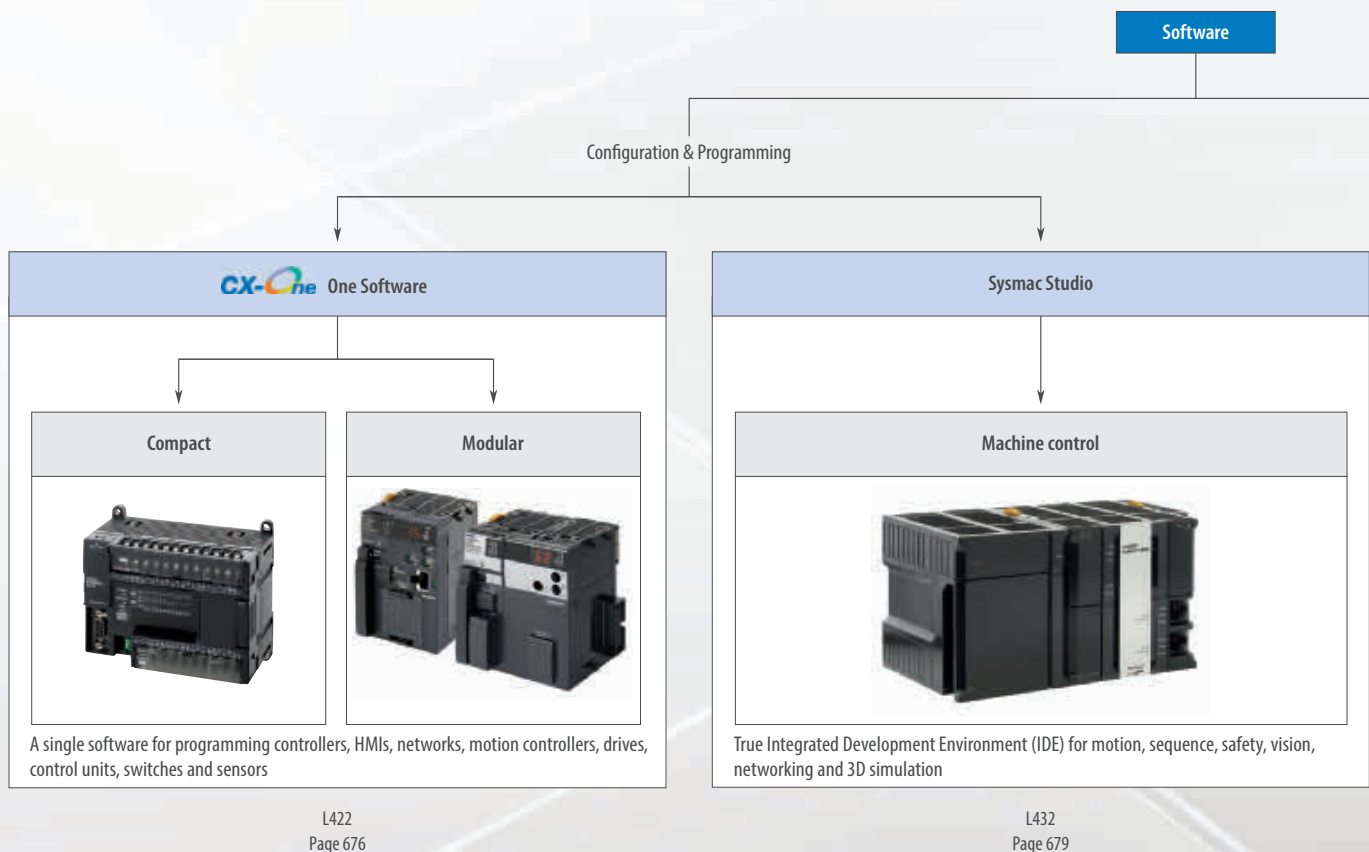



Visualisation

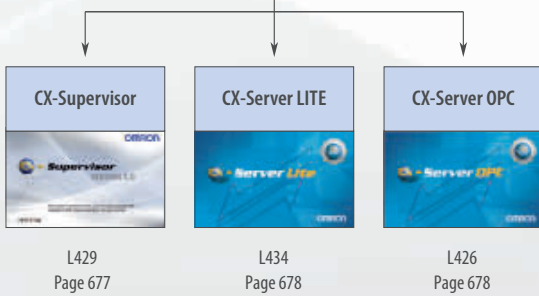



Integrated “One software” that covers all your requirements for complete machine automation

This single programming and configuration environment is an integrated software management tool called CX-One that enables the user to build, configure and program networks, PLCs, HMIs, motion control systems, drives, temperature controllers and sensors. The result of a single software is to reduce complexity of the configuration and allow automation systems to be programmed or configured with minimal training.

By registering a licence number at www.omron-industrial.com, users can benefit from free updates to their version of CX-One for 12 months free of charge. An automatic update service can notify users as soon as relevant updates are available.

CX-One is available as two types. FULL supporting all PLCs or LITE designed for our compact PLC range. Thus our integrated “One Software” applies to our complete portfolio.

Ordering information

CX-One FULL	Media	Order code
Single licence	Licence Only	CXONE-AL01-EV_
Three user licence	Licence Only	CXONE-AL03-EV_
Ten user licence	Licence Only	CXONE-AL010-EV_
Thirty user licence	Licence Only	CXONE-AL030-EV_
Fifty user licence	Licence Only	CXONE-AL050-EV_
Site licence	Licence Only	CXONE-AL0XX-EV_
Software on CDs	CD	CXONE-CD-EV_
Software on a DVD	DVD	CXONE-DVD-EV_
CX-One LITE	Media	Order code
Single user licence	Licence Only	CXONE-LT01-EV_
Software on CD	CD	CXONE-LTCD-EV_

Specifications

Subject	Indicator	Description
Programming	CX-Programmer	CX-Programmer provides one common PLC software platform for all types of Omron PLC controllers – from micro PLC's up to Duplex processor systems. It allows easy conversion and re-use of PLC code between different PLC types, and the full re-use of control programs created by older generation PLC programming software.
	CX-Simulator	A debugging environment equivalent to the actual PLC system environment can be achieved by simulating the operation of a CS/CJ Series PLC with a virtual PLC in the computer. CX-Simulator makes it possible to evaluate program operation, check the cycle time and reduce debugging time before the actual equipment is assembled.
	CX-Designer	CX-Designer is used to create screen data for NS-series Programmable Terminals. CX-Designer can also check the operation of the created screen data on the computer. CX-Designer enables efficient development process for screen creation, simulation and project deployment. Users can develop screens more efficiently with Easy-to-use Support Software. CX-Designer has about 1,000 standard functional objects with associated graphics and advanced functions, so even first-time users can create screens easily just by arranging functional objects in a screen.
Networks	CX-Integrator	CX-Integrator is the main configuration software for CX-One. It enables easy performance of many operations, such as monitoring the connection status of various networks, setting parameters, and diagnosing networks.
	CX-ConfiguratorFDT	Based on FDT/DTM technology, CX-ConfiguratorFDT can be used to configure devices from any vendor connected to a PROFIBUS network. This concept will later be expanded to support many more networks using this technology.
Motion & Drives	CX-Motion	CX-Motion can be used to create, edit, and print the various parameters, position data, and motion control programs (G code) required to operate Motion Controllers, transfer the data to the Motion Control units, and monitor operation of the Motion Control units. Increase productivity in every step of the motion control process, from development of the motion control program to system operation.
	CX-Drive	The complete current range of Omron Yaskawa inverters and servos is covered in this software with full access to all parameters (with 3 different operator levels available). An easy overview of parameters is also included which includes filters to show values that are: different from default, different from inverter, invalid setting. Graphical overviews are available to further assist with configuration of some more detailed parameters such as jump frequencies, v/f profiles and analog setting.
	CX-Position	CX-Position simplifies every aspect of position control, from creating/editing the data used in Position Control units (NC units) to communicating online and monitoring operation. The software is equipped with functions that can improve productivity, such as automatically generating project data and reusing existing data.
Regulation and Switching	CX-Thermo	Omron's CX-Thermo support software has been specially developed for use with the company's E5CN, E5EN, E5GN, E5AN, E5CN-H, E5EN-H, E5AN-H, E5ZN, E5AR, E5ER and CelciuX ^o temperature controllers. CX-Thermo enables faster parameter set-up, easier device adjustment and simpler maintenance. It dramatically reduces the time and effort needed to set and manage temperature control parameters.
	CX-Process	CX-Process simplifies every aspect of loop control, from creating/transferring function blocks to running the Boards/units and debugging (tuning PID parameters, etc.) operation. Function block programs can be created easily by pasting function blocks in the window and making software connections with the mouse.
Sensing	CX-Sensor	CX-Sensor allows configuration and monitoring of Omron's ZX range of sensors via a series of easy to use displays. The graphing dialog allows the outputs from several sensors to be reviewed and compared simultaneously, allowing configuration of complex processes. The software also includes a driver that allows sensor data to be accessed via an Omron serial control unit (SCU) and from other Omron applications such as CX-Supervisor. With the aid of Omron's CX-Server OPC application it is even possible to monitor sensor data in real time from Microsoft Excel.



Powerful Machine Visualisation

CX-Supervisor is dedicated to the design and operation of PC visualisation and machine control. It is not only simple to use for small supervisory and control tasks, but also offers a wealth of power for the design of the most sophisticated applications. CX-Supervisor boasts powerful functions for a wide range of PC based HMI requirements. Simple applications can be created rapidly with the aid of a large number of predefined functions and libraries, and even very complex applications can be generated with a powerful programming language or VBScript™. CX-Supervisor has an extremely simple, intuitive handling and high user friendliness. Importing ActiveX components makes it possible to create flexible applications and extend functionality.

CX-Supervisor now comes in two editions:

CX-Supervisor Machine Edition is the perfect choice for almost all machine visualization requirements. Supporting connection of up to 15 devices and up to 500 user definable points (array = 1 point), it is flexible and powerful enough for the control and supervision of a complete machine or an entire manufacturing process. And its easy-to-use Windows Explorer-style development environment makes building the most sophisticated graphic interfaces simple.

CX-Supervisor PLUS is for those exceptional cases where an application demands a higher number of devices or points than can be handled by CX-Supervisor Machine Edition. It otherwise shares all of the same power and features.

Ordering information

Description	Media	Order code
Developer & runtime (no protection included)	CD	CX-SUPERVISOR-V_ _ _
Developer upgrade (no protection included, requires licence of previous version)	CD	CX-SUPERVISOR-UPGR-V_ _ _
Machine Edition runtime including USB dongle protection	CD	CX-SUPERVISOR-RUN-ME-V_ _ _
PLUS Edition runtime including USB dongle protection	CD	CX-SUPERVISOR-RUN-PLUS-V_ _ _

Specifications

Feature	Supervisor	
	Machine Edition	Plus
ActiveX	Yes	Yes
VBScript	Yes	Yes
Recipes	Yes	Yes
Alarms	300	3000
Animation	Yes	Yes
Max Devices (PLCs etc)	20	256
OPC Connections	Yes	Yes
Max Points	500	8000
Max Regular Interval Scripts	10	100
Max Num Pages	100	500
Databases supported	MS Access	MS Access SQL, ODBC, MS Access, MS Excel, dBase, CSV



Omron’s devices meet ‘Open Integration’

CX-Server OPC provides a connection between the industry standard OPC interface specification and Omron's network architecture and controllers. CX-Server OPC allows any OPC compliant client software to interface easily with Omron. The multi-vendor connectivity and information exchange capability of CX-Server OPC eliminates driver development issues. CX-Server OPC includes an ActiveX OPC client control and a set of graphical components. Linking the graphical controls can be done without a single line of script. No programming knowledge is required!

Ordering information

Description	Media	Order code
CX-Server OPC	CD & Licence	CX-OPC-EV_

CX-Server LITE

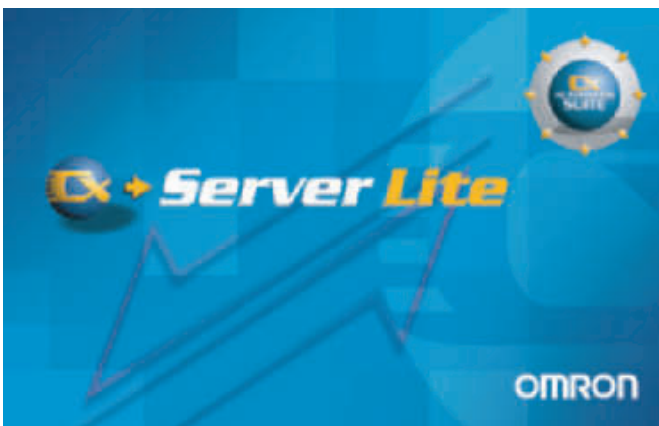

Simple but effective connectivity

As a pair to our OPC product, CX-Server LITE is designed to meet a wide variety of programmers' needs from the simple to the advanced. Used to create PC-based simple HMI projects, CX-Server LITE allows designers of custom programs to send and receive PLC data and manipulate controllers within Omron networks. Based on ActiveX technology, it is easy to add a communications control to a VB project or an Excel spreadsheet. Live data can be updated directly into a cell or range of cells. CX-Server LITE includes a set of graphical components designed to connect to the communications control. Linking the graphical controls can be done without a single line of script. No programming knowledge is required!

Ordering information

Description	Media	Order code
CX-Server LITE	CD & Licence	CX-LITE-EV_



Sysmac Studio for machine creators

The Sysmac Studio provides one design and operation environment for configuration, programming, simulation and monitoring.

- One software for servo, inverter, vision and I/O
- Fully compliant with open standard IEC 61131-3
- Supports Ladder, Structured text and In-Line ST programming with a rich instruction set
- CAM editor for easy programming of complex motion profiles
- One simulation tool for sequence and motion in a 3D environment
- Advanced security function with 32 digit security password

Ordering information

Automation software

Please purchase a DVD and licenses the first time you purchase the Sysmac Studio. DVDs and licenses are available individually. The license does not include the DVD.

Product	Specifications			Order code
	Description	Number of licenses	Media	
Sysmac Studio Standard Edition Ver. 1.□□□	The Sysmac Studio provides an integrated development environment to set up, program, debug and maintain NJ-series controllers and other machine automation controllers, as well EtherCAT slaves Sysmac Studio runs on the following OS: Windows XP (Service Pack 3 or higher, 32-bit version)/ Vista (32-bit version)/7 (32-bit/64-bit version)	– (Media only)	DVD*1	SYSMAC-SE200D
		1 license	–	SYSMAC-SE201L
		3 licenses	–	SYSMAC-SE203L
		10 licenses	–	SYSMAC-SE210L
		30 licenses	–	SYSMAC-SE230L
		50 licenses	–	SYSMAC-SE250L
Sysmac Studio Vision Edition Ver. 1.□□□*2	Sysmac Studio Vision Edition is a limited license that provides selected functions required for FQ-M series vision sensor settings	1 license	–	SYSMAC-VE001L
Sysmac Studio Measurement Sensor Edition Ver. 1.□□□*3,*4	Sysmac Studio Measurement Sensor Edition is a limited license that provides selected functions required for ZW-series displacement sensor settings	1 license	–	SYSMAC-ME001L
		3 licenses	–	SYSMAC-ME003L

*1 The same media is used for both the Standard Edition and the Vision Edition.
 *2 With the Vision Edition, you can use only the setup functions for FQ-M series vision sensors.
 *3 With the Measurement Sensor Edition, you can use only the setup functions for ZW-series displacement sensors.
 *4 This product is a license only. You need the Sysmac Studio Standard Edition DVD media to install it.

Note: Site licenses are available for users who will run Sysmac Studio on multiple computers. Ask your OMRON sales representative for details.

Components

DVD (SYSMAC-SE200D)

Components	Details
Introduction	An introduction about components, installation/uninstallation, user registration and auto update of the Sysmac Studio is provided
Setup disk (DVD-ROM)	1

License (SYSMAC-SE2□□L/VE0□□L/ME0□□L)

Components	Details
License agreement	The license agreement gives the usage conditions and warranty for the Sysmac Studio
License card	A model number, version, license number and number of licenses are described
User registration card	Two cards are contained. One is for users in Japan and the other is for users in other countries

Included support software

DVD media of Sysmac Studio includes the following support software:

Included support software	Version	Outline
CX-Designer	Ver. 3.□□□	The CX-Designer is used to create screens for NS-series PTs
CX-Integrator	Ver. 2.□□□	The CX-Integrator is used to set up FA networks
CX-Protocol	Ver. 1.□□□	The CX-Protocol is used for protocol macros for serial communications units
Network Configurator	Ver. 3.□□□	The Network Configurator is used for tag data links on the built-in EtherNet/IP port

Outline of Major Standards



International Standards

International standards consist of the IEC standards related to electricity and the ISO standards related to other areas (e.g., machines and management.)

IEC (International Electrotechnical Commission)

The IEC is a standardization commission founded in 1908 to promote unification and coordination of international standards relating to electricity. It is headquartered in Geneva, Switzerland.

Based on reports from member nations on the latest science technologies in those nations, IEC standards are issued as technological standards relating to electricity. Established international safety standards provided by various countries and accepted worldwide are based on IEC standards.

The IEC standards committees includes the CISPR (International Special Committee on Radio Interference) that makes standards for EMC (Electromagnetic Compatibility).

To simplify certification procedures for electrical devices and promote smooth international trade, there is an international scheme called CB Scheme (Certification Body Scheme), which is authorized by IEC standards. Based on the CB Scheme, safety tests on electrical devices are conducted and certificates are issued if the devices are proved to meet IEC standards.

ISO (International Organization for Standardization)

ISO is a standardization organization that started official activities in 1947 to promote international standards in all areas (e.g., machines and management) except for electricity, which is covered by the IEC, by issuing ISO standards. It is headquartered in Geneva, Switzerland.

North America

UL Standards (Underwriters Laboratories INC.)



LISTING MARK

A nonprofit organization established in 1894 by the American association of fire insurance companies. Underwriters Laboratories (abbreviated to UL hereafter) conducts certification testing on all kinds of electrical products. In many U.S. cities and states, UL certification is legally required on all electrical items sold. To obtain UL certification on an electrical product, all major internal components also require UL certification. UL offers two classifications of certification, the listing mark and the recognition mark.

A Listing Mark constitutes the entire certification of a product. Products display the Listing Mark shown below.



RECOGNITION MARK

The Recognition Mark applies to the components used in a product, and therefore constitutes a more conditional approval of a product. Use of the Recognition Mark is not required for non-specified parts (e.g., specified parts such as microswitches) Products display the Recognition Mark shown below.



Since October 1992, UL has been recognized as a CO (council organization) and TO (test organization) by the SCC (Standard Council of Canada). This authorizes UL to conduct safety tests and certify products conforming to Canadian standards. The above marks are UL marks for products certifying that the products meet Canadian standards.

The designs of the listing marks and recognition marks have been revised as shown below. These marks have been effective since January 1998. The previous marks are valid until November 2007.

Standards (Canadian Standards Association)



This association descended from a nonprofit, non-government standardization organization established in 1919. In addition to industrial standardization, the association now carries out safety testing on electrical products.

Standard development: The Canadian Standards Association

Product testing and certification: CSA International

This process is known as "certification," and consequently, CSA-certified equipment displays the mark shown below.

For detailed information please refer to:
<http://www.ia.omron.com/support/models/outline>

Europe

EN (European Norm) Standards

Of the EN standards related to electricity, standards beginning with "EN6" are based on IEC standards and those beginning with "EN55" are based on IEC-CISPR standards. Standards beginning with "EN5" are unique EU standards that do not exist in the IEC standards. The following marks of recognition are used by the Certification Bodies in European countries in accordance with EN standards.

Germany



VDE (Prüf- und Zertifizierungsinstitut GmbH)



TÜV Rheinland (Industrie Service GmbH)



TÜV product services

TÜV Product Service

Denmark



DEMKO (Danmarks Elektriske Materielkontrol)

Norway



NEMKO (Norges Elektriske Materielkontroll)

Finland



FIMKO (Finlands Material Kontroll)

United Kingdom



BSI (British Standards Institution, applicable to industrial products)



BEAB (British Electrotechnical Approvals Board, applicable to home electronics products)



ASTA (ASTA Certification Services, applicable to general products)

The Netherlands



KEMA (Keuring van Electrotechnische Materialen Nederland B. V.)

France



UTE (Union Technique De Electricite)

Italy



IMQ (Istituto Italiano del Marchio di Qualita)

Russia



GOST-R



TR CU certificate and declaration

Sweden



Intertek

Switzerland



SEV (Schweizerischer Electrotechnischer Verein)

EC (European Communities) Directives



In the EU (European Union), EC Directives are announced to instruct the creation of laws in the EU member countries. A product can display the CE Marking only when it conforms to all of the directives applicable to it, such as the New Approach Directives, which cover the Machinery Directive, Low Voltage Directive, and the EMC Directive. As a rule, EN standards announced as Harmonized Standards in the Official Journal of the European Communities are used to evaluate directive compliance.

China

CCC (China Compulsory Certification) Mark



As a result of China joining the WTO (World Trade Organization) in 2001, the previous Safety License System for Import Commodities and the Compulsory Supervision System for Product Safety Certification were combined to form the CCC. The change was announced on 3 December 2001 and implemented from 1 May 2002. Starting 1 August 2003, any products that have not received the CCC Mark are prohibited from import to or sale in China.

Products Subject to CCC Mark: 19 product sections consisting of 132 product categories

Applicable Standards: National Standards (GB: Guojia Biaozhun) (Standards related to electricity were based on IEC standards.)

CCC Mark: Display of the CCC Mark is legally required.

Japan

Electrical Appliance and Material Safety Law of Japan



Accompanying revisions to laws related to electrical appliances, the Electrical Appliance and Material Safety Law was switched to on 1 April 2001 and the previous Electrical Appliance and Material Control Law was abolished. New marks were also created for the Electrical Appliance and Material Safety Law.

The law covers 112 specified electrical appliances and materials and 340 non-specified electrical appliances and materials.



Article 2 of the Ordinance Concerning Technical Requirements for Electrical Appliances and Materials specifies technical requirements (IEC-J standards) harmonized with IEC standards.

Industry specific certifications

Marine Standards

There are more than 20 classification societies worldwide that individually work to create regulations and certify compliance. The IACS (International Association of Classification Societies) works as an international body currently consisting of 10 member classification societies plus 2 associate classification societies. The classification societies in the IACS certify and register 90% of the world's ships. The option to be classified is made by the owner of the ship; classification certification is undertaken by the shipyard at the request of the owner.

Classification certification has a close relationship to maritime insurance. Insurance underwriters will as a rule insure only ships that have been classified and refuse those without a certified classification. Therefore, automation devices used on ships must conform to classification standards of individual countries if so requested by the owner.

Although classification societies will often recognize portions of inspection data that have the same requirement from other classification societies, requirements and standards differ among the classification societies. Classification societies therefore they do not recognize certification from other classification societies. It is thus necessary to comply with the classification standards of the required classification society. If registration is required in more than one classification, then certification is required for both.

IACS Member Classification Societies

ABS (American Bureau of Shipping), BV (Bureau Veritas, France's classification society), CCS (China Classification Society), DNV (Det Norske Veritas, Norway's classification society), GL (Germanischer Lloyd, Germany's classification society), KR (Korean Register of Shipping), LR (Lloyd's Register of Shipping, Britain's classification society), NK (Nippon Kaiji Kyokai, Japan's classification society), RINA (Registro Italiano Navale, Italy's classification society), RS (Russian Maritime Register of Shipping)

IACS Associate Classification Societies

IRS (Indian Register of Shipping)

Other Classification Societies

CR (China Corporation Register of Shipping, Taiwan's classification society)

Food, Beverage and Pharma

For more information on standards used in the food, beverage and pharmaceutical industries refer to industrial.omron.eu.

Index

#			
61F-GP-N8	654		
61F-GPN-BC	656		
61F-GPN-BT	656		
A			
A16	406, 666		
A165E	408		
A22	409, 668		
A22E	411		
Accessories	82, 310		
Accessories fiber optic sensors	261		
Accessories NS	67		
Accessories photoelectric sensors	210		
Accurax G5			
Servo drives	106		
Servo motors	125		
C			
Cable connectors	306		
Celciux® (EJ1)	533		
CJ1W-NC_3	100		
CJ1W-NC_4	101		
CJ1W-NC_71	99		
CJ1W-NC_8	95		
CJ-Series			
Analog I/O and control units	32		
Communication units	36		
CPU units	28		
Digital I/O units	31		
Motion/position control units	34		
Power supplies, expansions	30		
Compact I/O CRT1	54		
Compact I/O DRT2	53		
Compact I/O GX-series	52		
Compact I/O SRT2	55		
CP1E CPU units	22		
CP1H CPU units	26		
CP1L CPU units	24		
CP1W expansion units	27		
CPM2C CPU units	20		
CPM2C expansion units	21		
CS-Series			
Analog and process I/O units	40		
Communication units	43		
CPU units	37		
Digital I/O units	39		
Position/motion control units	42		
Power supplies, backplanes	38		
CX-One	676		
CX-Server LITE	678		
CX-Server OPC	678		
CX-Supervisor	677		
D			
D40A/G9SX-NS	434		
D4B	288, 429		
D4BS	453		
D4C	292		
D4E	283		
D4GL	457		
D4MC	283		
D4N	286, 431		
D4N_R	427		
D4NH	433		
D4NL	456		
D4NS	452		
D4SL-N	458		
D5B	285		
DST1	493		
E			
E2A	266		
E2A3	269		
E2A-S	268		
E2AU	277		
E2B	270		
E2C-EDA	281		
μPROX E2E Small Diameter	272		
E2E_U	278		
E2EH	276		
E2FM	279		
E2FQ	264		
E2Q5	275		
E2S	274		
E32 Fibers			
Area monitoring	227		
Chemical resistant	242		
Heat resistant	243		
Longer distance	240		
Miniature	238		
Precision detection	248		
Robot application	247		
Special application	250		
Square shape	236		
Standard cylindrical	234		
Vacuum resistant	245		
E39	261		
E3F_B	201		
E3F_V	201		
E3F1	187		
E3FA/E3FB	184		
E3FC	188		
E3FS	488		
E3G	173		
E3G-M	209		
E3H2	190		
E3JK	182		
E3JM	208		
E3NC	203		
E3NX-FA	258		
E3S-CL	181		
E3S-DB	202		
E3S-LS3	207		
E3T	192		
E3T-C	191		
E3X-DACL	220		
E3X-DAC-S	218		
E3X-DAH-S	231		
E3X-HD	252		
E3X-MDA	231		
E3X-NA	256		
E3X-NA_F	231		
E3X-SD	255		
E3Z	176		
E3Z-B	200		
E3Z-G	196		
E3Z-Laser	180		
E3ZM	178		
E3ZM-B	199		
E3ZM-C	197		
E3ZM-V	217		
E5_C	521		
E5_C-T	527		
E5_N-H	529		
E5_N-HT	529		
E5_R	531		
E5_R-T	531		
E52-E	535		
ESC2	517		
ESCB	520		
ESCSV	519		
ESL	512		
ESL-A/C	514		
E6A2-C	302		
E6B2-C	302		
E6C2-C	303		
E6C3-A	305		
E6C3-C	303		
E6F-A	305		
E6F-C	303		
E6H-C	304		
EE_SX67	194		
EE-SX47	194		
EJ1N-HFU-ETN	537		
ER-series rope pulls			
ER1022	412		
ER1032	412		
ER5018	412		
ER6022	412		
XER1022	412		
XER1032	412		
XER6022	412		
ES1B	536		
ES1C	537		
Ethernet cables	81		
F			
F39-TGR-MCL	487		
F3E	226		
F3EM2	228		
F3ET2	225		
F3SJ-A	474		
F3SJ-B	470		
F3SJ-E	466		
F3S-TGR-CL	482		
F3S-TGRCL_K	463		
F3S-TGRCL_K_C	463		
F3S-TGR-KH16	454		
F3S-TGR-KHL1	460		
F3S-TGR-KHL3	461		
F3S-TGR-KM15	454		
F3S-TGR-KM16	454		
F3S-TGR-N_C	439		
F3S-TGR-N_M	445		
F3S-TGR-N_R	442		
F3S-TGR-N_U	445		
F3S-TGR-N_X	450		
F3S-TGR-S_A/S_D	447		
Field I/O DRT2_C	56		
Field I/O SRT2_C	57		
FQ	214		
FQ2	315		
FQ2-CH	311		
FQ2-CLR	221		
FQ2-S4	311		
FQ-CR1	311		
FQ-CR2	311		
FQ-M	325		
FZ	214		
G			
G2R_S	601		
G2RV	599		
G3NA	614		
G3PA	616		
G3PE	617		
G3PF	608		
G3PH	608		
G3PW	609		
G3R-I	613		
G3R-O	613		
G3RV	612		
G3ZA	609		
G7J	607		
G7L	595		
G7S_E	506		
G7SA	505		
G7Z	595		
G9SA	496		
G9SB	497		
G9SP-N	507		
G9SR	498		
G9SX	499		
G9SX-GS/A4EG	500		
G9SX-LM	502		
G9SX-NS	493		
G9SX-SM	504		
G-Series			
Servo drives	114		
Servo motors	141		
H			
H2C	563		
H3CR	561		
H3DK	559		
H3DS	558		
H3YN	560		
H5CX	562		
H7CX	572		
H7EC	568		
H7ER	570		
H7ET	569		
H8GN	571		
H8PS	573		
HL	283		
I			
I/O cables	72		
I/O terminal blocks	80		
J			
J7KN	627		
J7KNA	626		
J7KNA-AR	625		
J7MN	631		
J7TKN	629		
JX	166		
K			
K3GN	586		
K3HB-C	590		
K3HB-H	588		
K3HB-P	590		
K3HB-R	590		
K3HB-S	588		
K3HB-V	588		
K3HB-X	588		
K3MA-F	587		
K3MA-J	587		
K3MA-L	587		
K7L	659		
K8AK-AS	641		
K8AK-AW	642		
K8AK-LS	657		
K8AK-PA	649		
K8AK-PH	645		
K8AK-PM	647		
K8AK-PT	660		
K8AK-PW	653		
K8AK-TH	512, 661		
K8AK-TS	660		
K8AK-VS	643		
K8AK-VW	644		
K8DS-PA	650		
K8DS-PH	646		
K8DS-PM	648		
K8DS-PU	652		
K8DS-PZ	651		
L			
LME	424		
LUS	415		
LU7	419		
LX	150		
LY	605		

M

M16	670
M22	671
MKS	606
MKS(X)	595
MP	422
MPS	422
MS2800	480
MS4800	480
MX2	160
MY	603

N

NA12	62
NA15	62
NA7	62
NA9	62
NB series	68
NE1A-SCPU0_	493
NJ-Series	14
NS10	64
NS12	64
NS15	64
NS5	65
NS5 handheld	66
NS8	64
NT11	70
NT2S	71
NX-series modular I/O system	48
NX	493
NX-S	493

O

OS32C	489
-------	-----

P

PRT1-SCU11	536
------------	-----

R

RX	154
----	-----

S

S8EX	550
S8JC-ZS	545
S8JX-G	546
S8JX-P	548
S8M	553
S8T-DCBU-01	551
S8T-DCBU-02	551
S8TS	549
S8VK-C	542
S8VK-G	543
S8VK-R	552
S8VK-T	544
SHL	283
SmartSlice I/O system	51
SmartStep 2 servo drive	120
SX (400 V)	151
SX (690 V)	151
Sysmac Studio	679

T

TL-W	273
Trajexia 2.5 axes motion controller	93
Trajexia stand-alone	90
Trajexia-PLC CJ1W-MC472	97
Trajexia-PLC CJ1W-MCH72	97

V

V400-H	311
V680S series	361

W

WE70	83
WL	283
WL-N	290

X

X	283
Xpectia FH	333
Xpectia FZ5	333
Xpectia lite	215

Z

Z	296
ZC	294
ZEN-10C	578
ZEN-20C	579
ZEN-8E	580
ZEN-PA	581
ZG2	393
ZS-HL	376
ZW	384
ZX1	371
ZX2	373
ZX-E	389
ZX-GT	397
ZX-L	381
ZX-T	391

Discover it by yourself!

Just lift up this page and discover these DVDs!

Extended technical information, product brochures and magazines. For online updated information visit industrial.omron.eu

Note:

Although we do strive for perfection, Omron Europe BV and/or its subsidiary and affiliated companies do not warrant or make any representations regarding the correctness or completeness of information described in this catalogue. Product information in this catalogue is provided, as is' without warranty of any kind, either express or implied, including, but not limited to, the implied warranties of merchantability, fitness for a particular purpose, or non-infringement. In a jurisdiction where the exclusion of implied warranties is not valid, the exclusion shall be deemed to be replaced by such valid exclusion, which most closely matches the intent and purpose of the original exclusion. Omron Europe BV and/or its subsidiary and affiliated companies reserve the right to make any changes to the products, their specifications, data at its sole discretion at any time without prior notice. The material contained in this catalogue may be out of date and Omron Europe BV and/or its subsidiary and affiliated companies make no commitment to update such material.

Extended information needed?

Check out these DVDs!

Extended technical information, product brochures and magazines.

For online updated information visit industrial.omron.eu

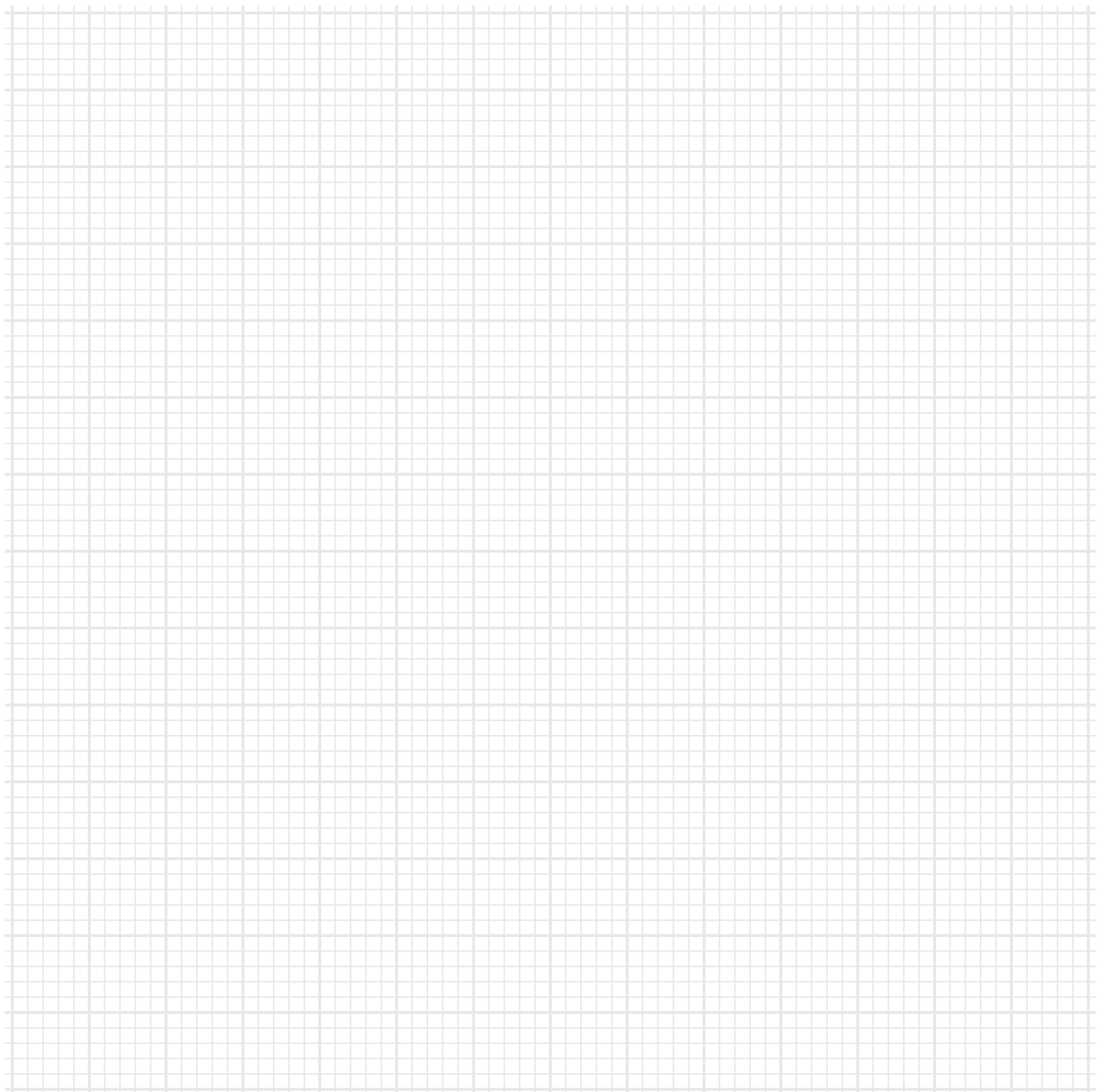

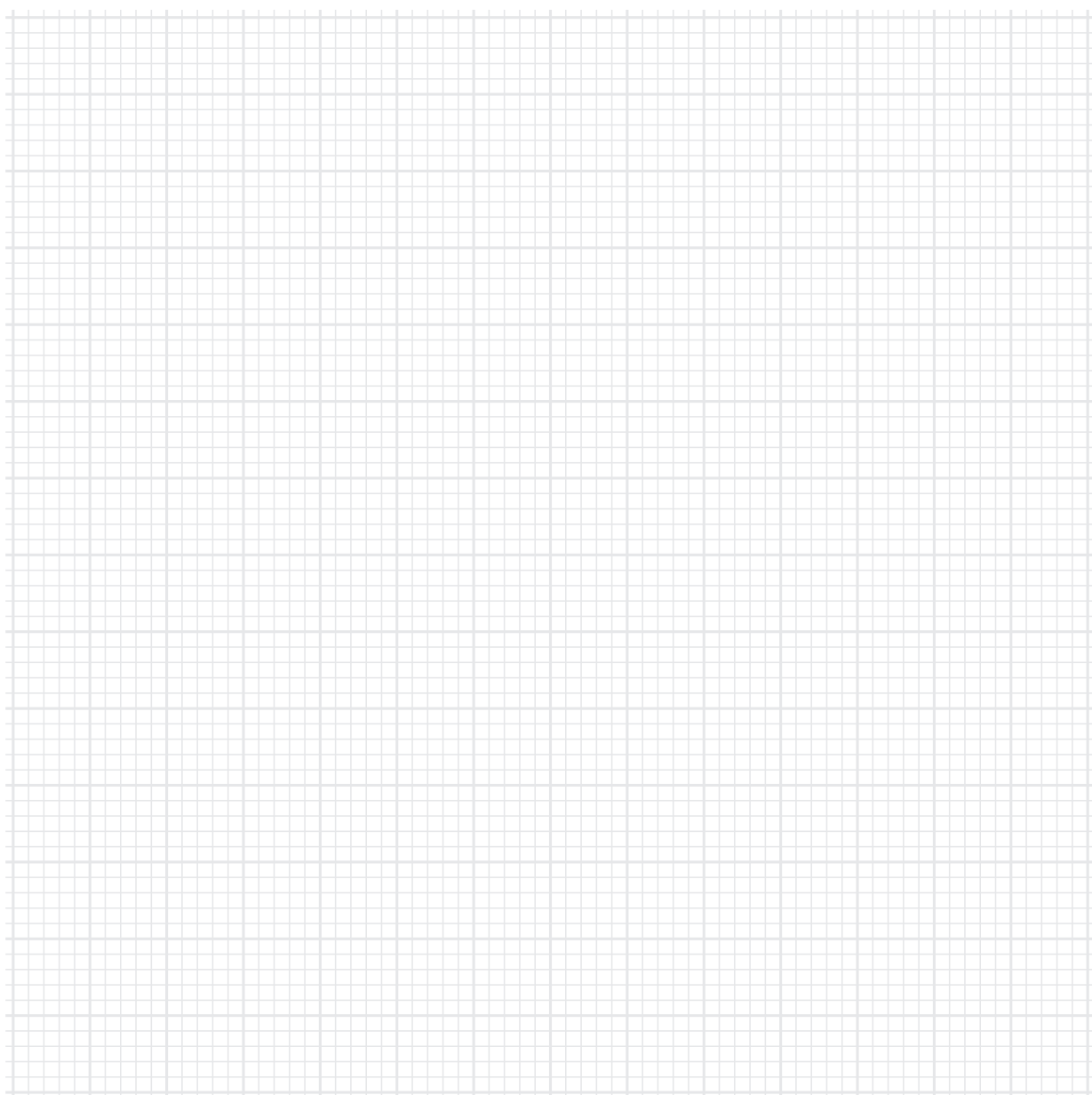

Would you like to know more?

OMRON EUROPE

 +31 (0) 23 568 13 00

 industrial.omron.eu

 omron.me/socialmedia_eu

Sales & Support Offices

Austria

Tel: +43 (0) 2236 377 800
industrial.omron.at

Belgium

Tel: +32 (0) 2 466 24 80
industrial.omron.be

Czech Republic

Tel: +420 234 602 602
industrial.omron.cz

Denmark

Tel: +45 43 44 00 11
industrial.omron.dk

Finland

Tel: +358 (0) 207 464 200
industrial.omron.fi

France

Tel: +33 (0) 1 56 63 70 00
industrial.omron.fr

Germany

Tel: +49 (0) 2173 680 00
industrial.omron.de

Hungary

Tel: +36 1 399 30 50
industrial.omron.hu

Italy

Tel: +39 02 326 81
industrial.omron.it

Netherlands

Tel: +31 (0) 23 568 11 00
industrial.omron.nl

Norway

Tel: +47 (0) 22 65 75 00
industrial.omron.no

Poland

Tel: +48 22 458 66 66
industrial.omron.pl

Portugal

Tel: +351 21 942 94 00
industrial.omron.pt

Russia

Tel: +7 495 648 94 50
industrial.omron.ru

South Africa

Tel: +27 (0)11 579 2600
industrial.omron.co.za

Spain

Tel: +34 902 100 221
industrial.omron.es

Sweden

Tel: +46 (0) 8 632 35 00
industrial.omron.se

Switzerland

Tel: +41 (0) 41 748 13 13
industrial.omron.ch

Turkey

Tel: +90 212 467 30 00
industrial.omron.com.tr

United Kingdom

Tel: +44 (0) 1908 258 258
industrial.omron.co.uk

More Omron representatives

industrial.omron.eu